

OWNER'S HANDBOOK



CITROËN C-CROSSER

<https://www.automotive-manuals.net/>



YOUR HANDBOOK ON THE INTERNET!

CITROËN SERVICE
<http://service.citroen.com>

CITROËN lets you view your vehicle's documentation on line, to see earlier versions and the latest information, simply and free of charge.

Connect to <http://service.citroen.com>:

- 1 | Select your language and register,
- 2 | click on the link in the "Private customer access" zone to consult the vehicle documentation; a window opens providing access to all of the handbooks,
- 3 | select your vehicle, choose the body type then the date of issue of the handbook,
- 4 | finally, click on the heading of your choice.

<https://www.automotive-manuals.net/>

We draw your attention to the following...

Your vehicle is fitted with only some of the equipment described in this document, depending on the trim level, version and the specifications for the country in which it is sold.

The fitting of electrical equipment or accessories which are not recommended by CITROËN may result in a failure of your vehicle's electronic system. Please note this specific warning and contact a CITROËN dealer to be shown the recommended equipment and accessories.

Key



safety warning



contributes to the protection of the environment



refer to the page indicated

CITROËN has a presence on every continent,

a complete product range,

bringing together technology and a permanent spirit of innovation,

for a modern and creative approach to mobility.

We thank you and congratulate you on your choice.

At the wheel of your new vehicle,

getting to know each system,

each control, each setting,

makes your trips, your journeys

more comfortable and more enjoyable.

Happy motoring!

CONTENTS

FAMILIARISATION 4 → 20

I - MONITORING 21 → 43

■ Instrument panel	21
■ Warning lamps	22
■ Instrument panel displays	25
■ Information on the instrument panel screen	31
■ Distance recorders	32
■ Service indicator	33
■ Trip computer	34
■ Setting menu	35
■ Monochrome screen	39
■ Colour screen	41
■ Lighting rheostat	43

II - COMFORT 44 → 72

■ Ventilation	44
■ Automatic air conditioning	46
■ Front seats	50
■ Rear seats	53
■ Rear bench seat	58
■ Mirrors	61
■ Steering wheel adjustment	63
■ Front fittings	64
■ Rear fittings	69
■ Boot fittings	70

III - ACCESS 73 → 85

■ Remote control key	73
■ Electric windows	77
■ Doors	79
■ Tailgate	80
■ Lower tailgate	81
■ Sunroof	82
■ Fuel tank	84

IV - VISIBILITY 86 → 93

■ Lighting stalk	86
■ Daytime running lamps	88
■ Automatic illumination of headlamps	88
■ Headlamp adjustment	89
■ Wiper controls	90
■ Automatic rain sensitive wipers	91
■ Courtesy lamps	92

V - CHILD SAFETY 94 → 101

■ Child seats	94
■ ISOFIX mountings	98
■ Child lock	101

VI - SAFETY 102 → 111

■ Direction indicators	102
■ Hazard warning lamps	102
■ Horn	102
■ Braking assistance systems	103
■ Trajectory control systems	104
■ Front seat belts	105
■ Airbags	108

CONTENTS

VII - DRIVING 112 → 124

- Parking brake 112
- Manual gearbox 112
- CVT gearbox 113
- DCS gearbox 115
- Four wheel drive system 119
- Cruise control 121
- Audible rear parking sensors 123
- Reversing camera 124

IX - PRACTICAL INFORMATION 132 → 158

- Changing a wheel 132
- Changing a bulb 137
- Changing a fuse 146
- Battery 151
- Changing a wiper blade 153
- Towing 154
- Towing a trailer 156
- Fitting roof bars 157
- Accessories 158

XI - AUDIO and TELEMATICS 164 → 223

- Audio CD system 164
- CD changer 175
- Error messages 177
- Audio-Telematic System 178
- Navigation 180
- DVD mode 208
- Hands-free telephone 216

VIII - CHECKS 125 → 131

- Bonnet 126
- Running out of fuel 126
- Petrol engine 127
- Diesel engine 128
- Checking levels 129
- Checks 130

X - TECHNICAL DATA 159 → 163

- Engines 159
- Weights 160
- Dimensions 161
- Identification markings 162

VISUAL SEARCH 224 → 229

ALPHABETICAL INDEX 230 → 233

EXTERIOR

Sunroof

This roof improves the ventilation and light in the passenger compartment.

» 82

Reversing camera

This equipment is activated automatically when reverse gear is engaged providing a visual image on the colour screen.

» 124

**Audible rear parking sensors**

This system warns you if an obstacle is detected behind the vehicle when reversing.

» 123

Lower tailgate

This lower tailgate provides remarkable accessibility and makes the loading of bulky objects easier.

» 81

<https://www.automotive-manuals.net/>

OPENING

Remote control key



- A. Unfolding/folding the key.
- B. Unlocking the vehicle.
- C. Locking the vehicle.

Manual central locking control



- 1. Locking the vehicle.
- 2. Unlocking the vehicle.

Fuel tank

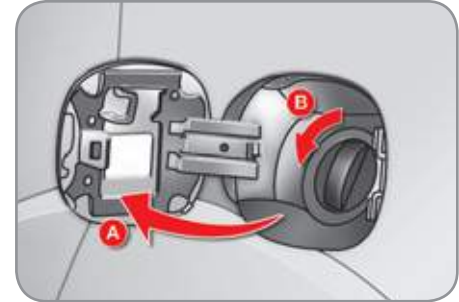

- A. Opening the fuel filler flap.
- B. Removing the fuel filler cap.

Capacity of the tank: approximately 60 litres.

When refitting the cap, insert the upper part first turning it to the right.

OPENING

Tailgate

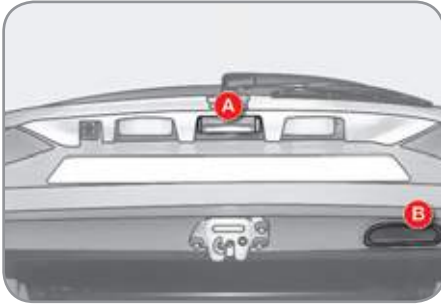

Opening

- ☞ After unlocking the vehicle using the remote control or the key, press the handle **A** and raise the tailgate.

Closing

- ☞ Pull the handle **B** downwards.

Lower tailgate

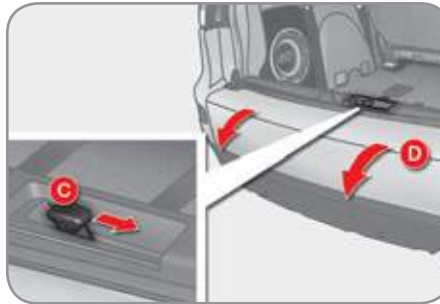

Opening

- ☞ Push the handle **C** to the right and tilt the tailgate **D** gently.

Closing

- ☞ Raise the tailgate **D**, push it to close it, then check that it is latched correctly.



The maximum authorised weight on the lower tailgate when open is **200 kg**.

Spare wheel and tools

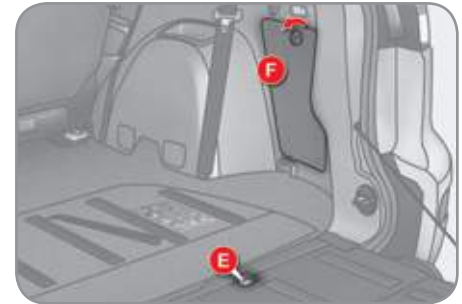

Access to the spare wheel

- ☞ Remove the plastic cover **E** to gain access to the spare wheel fixing system.

Access to the tools

The tools are stored in the storage compartment **F** in the boot right-hand trim.

SEAT CONFIGURATIONS

Rear seats (row 2)



Forwards-backwards adjustment



Head restraint height adjustment

» 52

Rear bench seat (row 3)

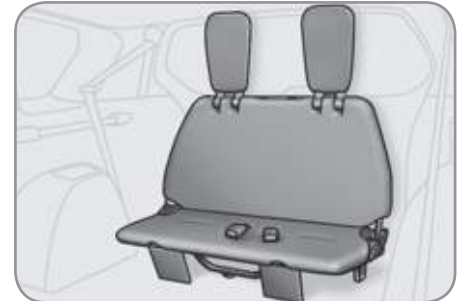

The rear bench seat can be folded. It is stowed in a location in the floor of the vehicle.



Seat back angle adjustment

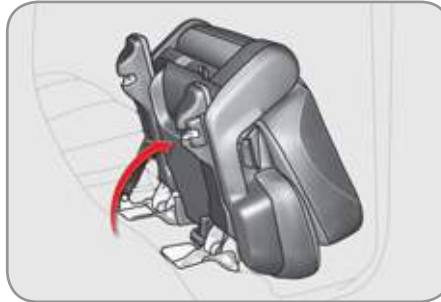

Access to the third row (7-seat version)

» 53

<https://www.automotive-manuals.net/>

» 58

INTERIOR

Digital air conditioning

This automatic air conditioning system maintains the desired level of comfort and adequate air circulation in the passenger compartment.

» 44

Audio and communication systems

These systems benefit from the latest technology: MP3 compatible audio system, Bluetooth hands-free telephone, colour screen...

» 164

Cruise control

This system automatically maintains the vehicle speed at the value programmed by the driver, without use of the accelerator pedal.

» 121

Four wheel drive system with electronic control

This system permits the selection of a transmission mode to suit the driving conditions.

» 119

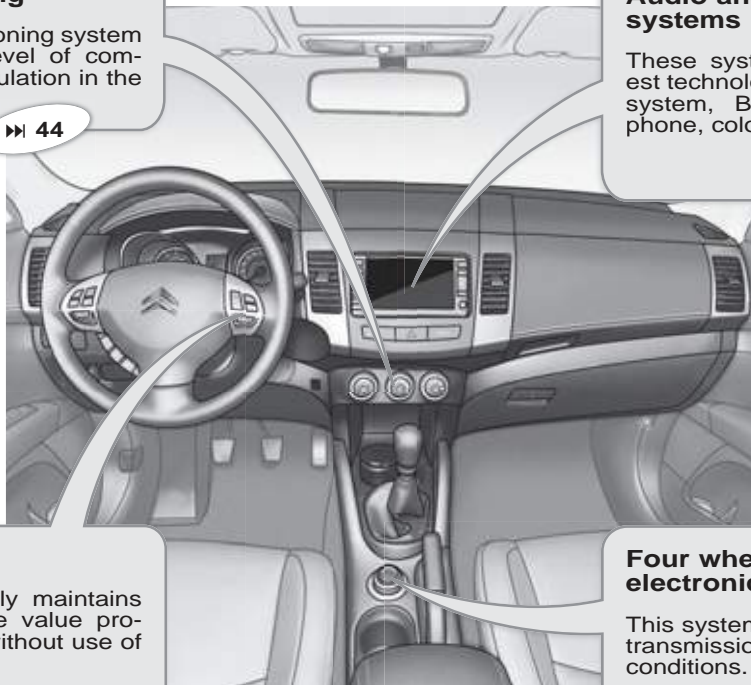

INSTRUMENTS AND CONTROLS

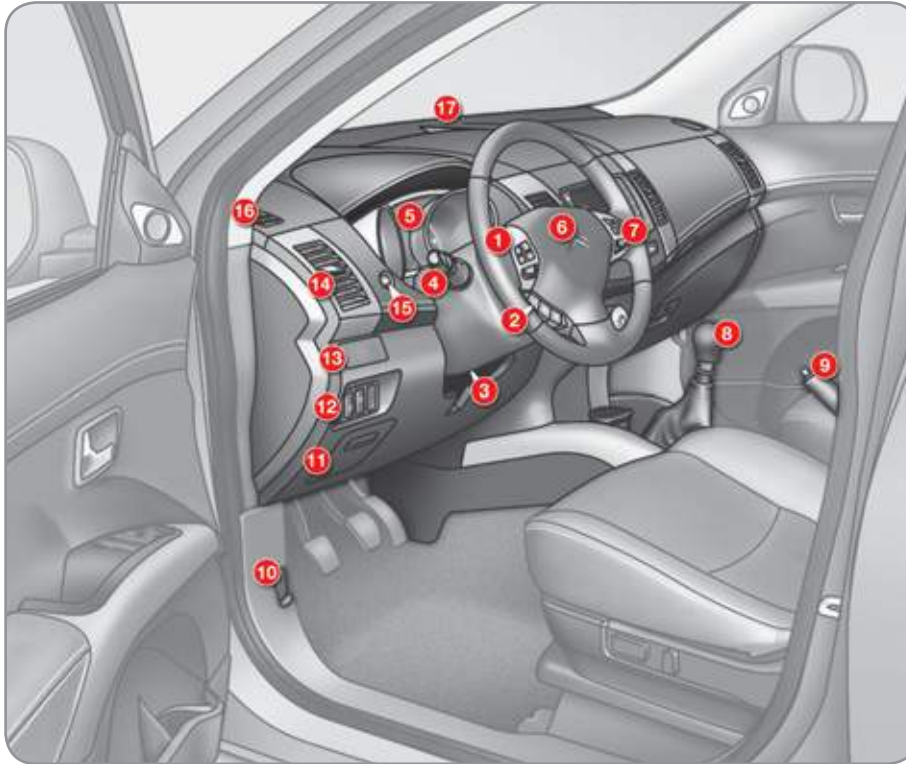

1. Audio system controls.
2. Telephone controls.
3. Steering wheel adjustment control.
4. Lighting and direction indicator control stalk.
Headlamp wash control.
5. Instrument panel.
6. Driver's airbag.
7. Cruise control switches.
Horn.
8. Gear lever.
9. Parking brake.
10. Bonnet release lever.
11. Enclosed storage compartment.
Fusebox.
12. Headlamp height adjustment.
Deactivation of the ASC system.
Deactivation of the audible parking sensors.
13. Cup holder.
14. Side adjustable air vent.
15. Information button.
16. Window demisting/defrosting vent.
17. Windscreen demisting/defrosting vent.

INSTRUMENTS AND CONTROLS

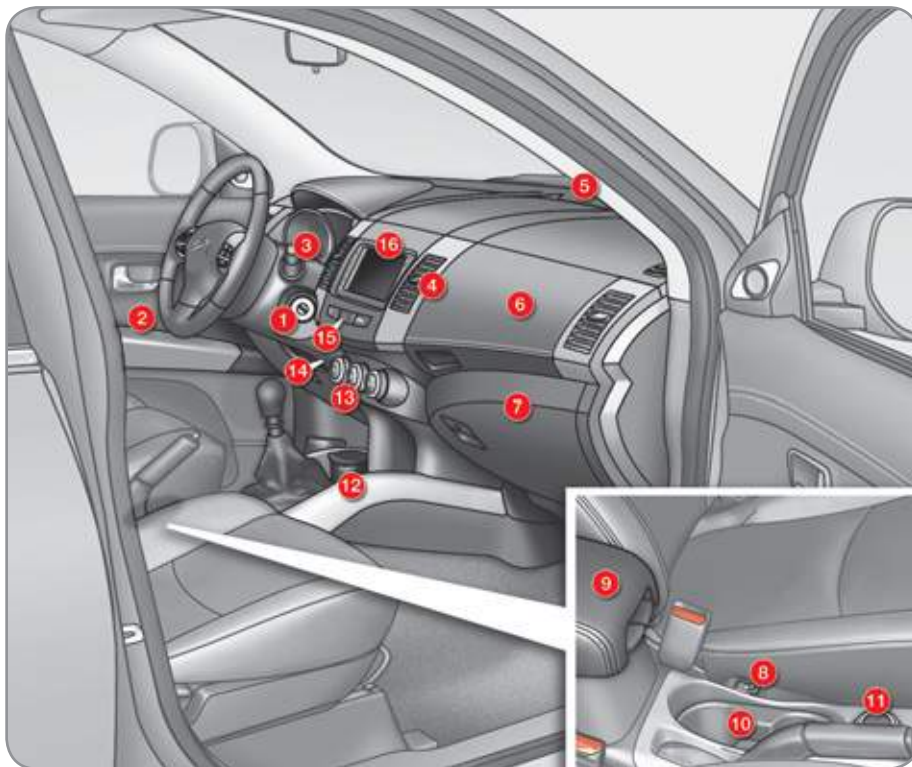

1. Steering lock and ignition.
2. Door mirror controls.
Electric window and rear electric window deactivation controls.
3. Front and rear wipers/screenwash control stalk.
4. Central adjustable air vents.
5. Sunshine sensor.
6. Cooled upper glove box.
7. Lockable lower glove box.
Passenger's airbag deactivation.
8. Heated seat controls.
9. Armrest with storage compartments.
12 volt socket (120 W max).
10. Cup holder.
11. Four wheel drive system position selector.
12. Removable ashtray/
12 volt socket (120 W max).
13. Automatic air conditioning controls.
14. Temperature sensor.
15. Hazard warning lamps switch.
16. Colour screen/Audio system.

SITTING COMFORTABLY

Front seats

Manual adjustments

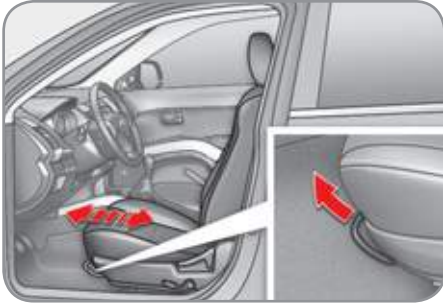

Forwards-backwards

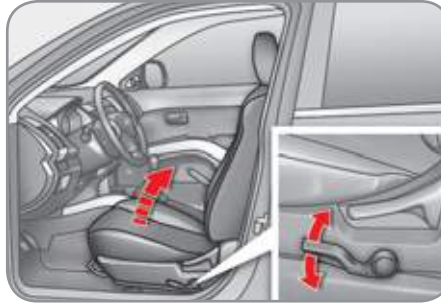

Driver's seat cushion height and angle

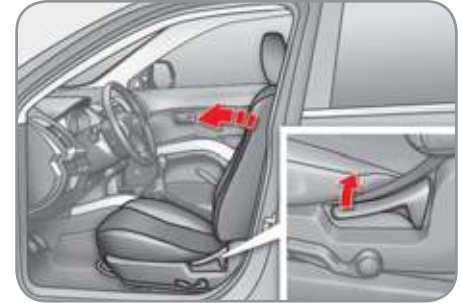

Seat back angle

Electric adjustments (driver's seat only)



Forwards-backwards

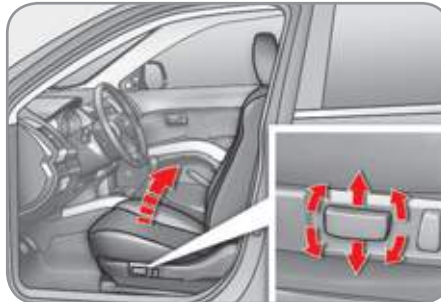

Seat cushion height and angle

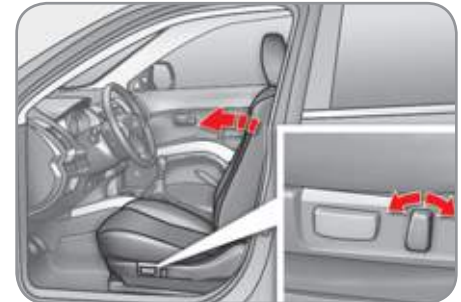

Seat back angle

» 50

<https://www.automotive-manuals.net/>

» 51

SITTING COMFORTABLY

Manual steering wheel height adjustment

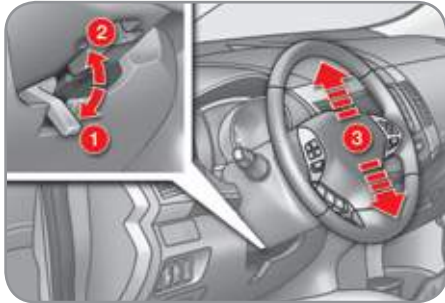

1. Releasing the lever.
2. Locking the lever.
3. Adjustment of the height of the steering wheel.

Door mirror adjustment



- A. Selection of the mirror.
- B. Adjustment of the position of the mirror.
- C. Folding/Unfolding.

» 61

Rear view mirror adjustment

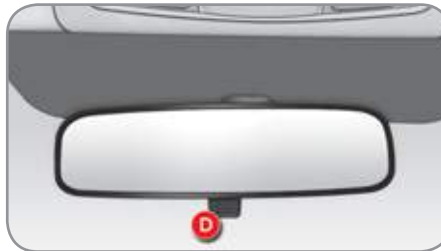

- D. Control for selection of the "day/night" position of the mirror.

Front seat belt

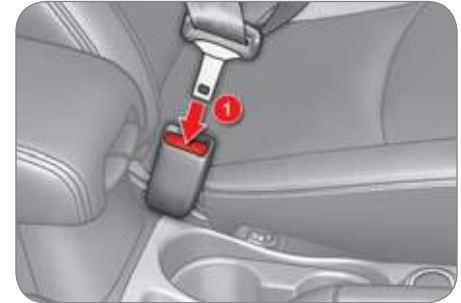

1. Fastening.
2. Height adjustment.



SITTING COMFORTABLY

Ignition switch



1. **LOCK** position.
2. **ACC** position.
3. **ON** position.
4. **START** position.

A heavy object (key fob...), attached to the key and weighing down on its shaft in the ignition switch, could cause a malfunction.

Electric window controls

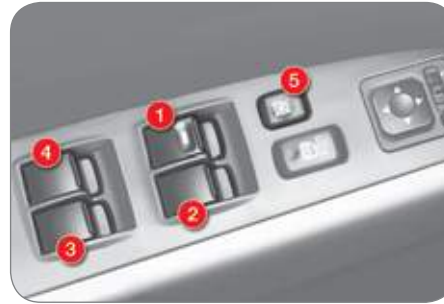

1. Driver's electric window control.
2. Passenger's electric window control.
3. Rear right electric window control.
4. Rear left electric window control.

Also...

5. Deactivation of the front passenger and rear electric window controls.

Sunroof controls



1. Opening control.
2. Closing control.
3. Partial opening control.

Also...



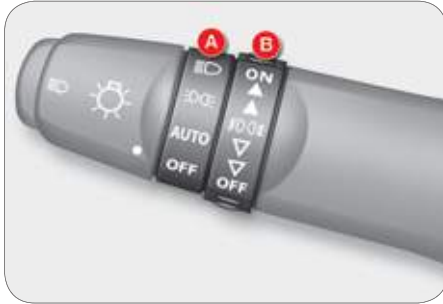

3. Also allows sunroof opening/closing to be stopped at any time.

SEEING CLEARLY

Lighting



Ring A

-  Lighting off.
-  Automatic illumination of headlamps.
-  Sidelamps.
-  Dipped or main beam headlamps.







Ring B

-  Front foglamps and rear foglamps.

Wipers





Windscreen wipers

-  Single wipe.
-  Park.
-  Intermittent (speed which can be adjusted manually).
or
-  Automatic rain sensitive (speed which can be adjusted manually).
-  Slow.
-  Fast.



Rear wiper

-  Park.
-  Intermittent wipe.
-  Wiping with screen wash.

VENTILATION

Digital air conditioning



Temperature adjustment.



Exterior air intake.
Interior air recirculation.



Air flow adjustment.



Automatic programme (comfort).



Switching off the air conditioning.



Air distribution adjustment.



Front visibility setting.



Rear screen demist/defrost.

<https://www.automotive-manuals.net/>

MONITORING

Instrument panel



- A. Speedometer.
- B. Instrument panel screen.
- C. Rev counter.
- D. Dashboard lighting dimmer.

» 21

Warning lamps



When the ignition is on, the orange and red warning lamps come on.

When the engine is running, these warning lamps should go off.

If warning lamps remain on, refer to the page concerned.

» 22

Detection of driver's seat belt fastening



When the **ignition is switched on**, the **seat belt warning lamp** comes on accompanied by an audible signal if the driver has not fastened their seat belt.

The warning lamp goes off when the seat belt is fastened.

Switch panel

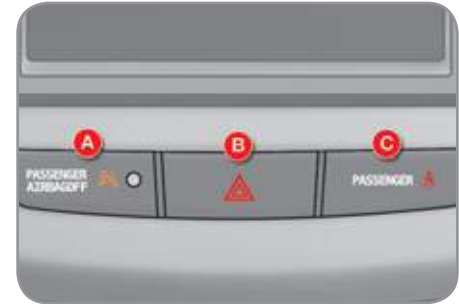

A. Passenger's airbag deactivated warning lamp.

» 109

B. Hazard warning lamps switch.

» 102

C. Front passenger's seat belt not fastened or unfastened warning lamp.

» 106

PASSENGER SAFETY

Front passenger's airbag

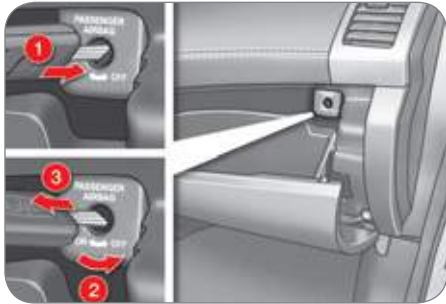

1. Insert the key.
2. Select the "OFF" position.
3. Remove the key.

Child lock

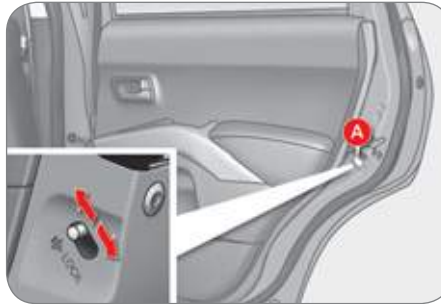

This prevents opening of the door concerned from the inside.
Lower or raise the control **A** to lock or unlock.

ISOFIX mountings



Two rings **A**, located between the seat back and seat cushion of the vehicle's seat are used to secure an ISOFIX child seat.



A ring **B** is used to secure the upper strap referred to as the **TOP TETHER**.

DRIVING SAFELY

Four wheel drive system

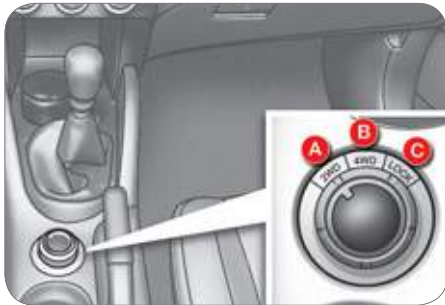

Three transmission modes are available and can be selected manually by the driver to suit the circumstances:

- A. **Two wheel drive (2WD),**
- B. **Four wheel drive (4WD AUTO),**
- C. **Four wheel drive (4WD LOCK).**

Also...

You can change transmission mode when stationary or when driving at a speed below 60 mph (100 km/h).

Cruise control

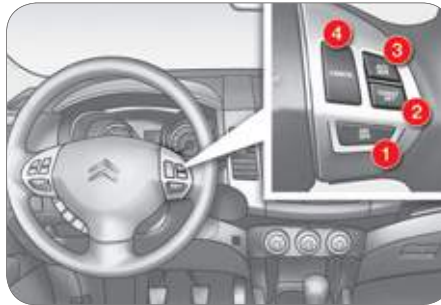

This maintains a constant vehicle speed programmed by the driver.

1. **"ON/OFF"** button: activation/deactivation of cruise control mode.
2. **"COAST SET"** button: storing of a driving speed then decreasing the cruising speed.
3. **"ACC RES"** button: increasing the cruising speed and recalling the stored speed.
4. **"CANCEL"** button: switching off the cruise control.

In order to be programmed or activated, the vehicle speed must be higher than 25 mph (40 km/h) with at least second gear engaged.

Audible rear parking sensors



This detects obstacles (person, vehicle, tree, gate, ...) located behind the vehicle.

The vehicle is fitted with four sensors:

- D. two side sensors.
- E. two central sensors.

ECO-DRIVING

Eco-driving is a range of everyday practices that allow the motorist to optimise their fuel consumption and CO₂ emissions.

Optimise the use of your gearbox

With a manual gearbox, move off gently, change up without waiting and drive by changing up quite soon. If your vehicle has the system, the gear shift indicator invites you to change up; it is displayed in the instrument panel, follow its instructions.

With an automatic or electronic gearbox, stay in Drive "D" or Auto "A", according to the type of gearbox, without pressing the accelerator pedal heavily or suddenly.

Drive smoothly

Maintain a safe distance between vehicles, use engine braking rather than the brake pedal, and press the accelerator progressively. These practices contribute towards a reduction in fuel consumption and CO₂ emissions and also helps reduce the background traffic noise.

If your vehicle has cruise control, make use of the system at speeds above 25 mph (40 km/h) when the traffic is flowing well.

Control the use of your electrical equipment

Before moving off, if the passenger compartment is too warm, ventilate it by opening the windows and air vents before using the air conditioning.

Above 30 mph (50 km/h), close the windows and leave the air vents open.

Remember to make use of equipment that can help keep the temperature in the passenger compartment down (sun roof and window blinds...).

Switch off the air conditioning, unless it has automatic digital regulation, as soon as the desired temperature is attained.

Switch off the demisting and defrosting controls, if not automatic.

Switch off the heated seat as soon as possible.

Switch off the headlamps and front foglamps when the level of light does not require their use.

Avoid running the engine before moving off, particularly in winter; your vehicle will warm up much faster while driving.

As a passenger, if you avoid connecting your multimedia devices (film, music, video game...), you will contribute towards limiting the consumption of electrical energy, and so of fuel.

Disconnect your portable devices before leaving the vehicle.

Limit the causes of excess consumption

Spread loads throughout the vehicle; place the heaviest items in the bottom of the boot, as close as possible to the rear seats.

Limit the loads carried in the vehicle and reduce wind resistance (roof bars, roof rack, bicycle carrier, trailer...). Use a roof box in preference.

Remove roof bars and roof racks after use.

At the end of winter, remove snow tyres and refit your summer tyres.

Observe the recommendations on maintenance

Check the tyre pressures regularly, when cold, referring to the label in the door aperture, driver's side.

Carry out this check in particular:

- before a long journey,
- at each change of season,
- after a long period out of use.

Don't forget the spare wheel and the tyres on any trailer or caravan.

Have your vehicle serviced regularly (engine oil, oil filter, air filter...) and observe the schedule of operations recommended by the manufacturer.

When refuelling, do not continue after the 3rd cut-off of the nozzle to avoid any overflow.

At the wheel of your new vehicle, it is only after the first 1 800 miles (3 000 kilometres) that you will see the fuel consumption settle down to a consistent average.

MONITORING

INSTRUMENT PANEL



Panel grouping together the dials and warning/indicator lamps. These inform the driver of the activation/deactivation of a system or of the occurrence of a fault.

1. Rev counter.
2. Speedometer.

3. Instrument panel screen:

- Warning and status displays.
- Total and trip distance recorders.
- Service indicator.
- Coolant temperature.
- Trip computer information.
- Cruise control setting.
- Dashboard lighting and parameter settings.
- Fuel level.
- Ambient temperature.
- Transmission mode.









Screen type 1



Screen type 2





MONITORING

INSTRUMENT PANEL WARNING LAMPS

Warning lamp		is on	Cause	Actions/Observations
	Left-hand direction indicator	Flashing with audible warning	This flashes when you press the lighting stalk down.	If this indicator lamp flashes abnormally quickly, this could indicate that the bulb of one of the direction indicators has blown. Change the bulb or contact a CITROËN dealer or a qualified workshop.
	Right-hand direction indicator	Flashing with audible warning	This flashes when you push the lighting stalk up.	If this indicator lamp flashes abnormally quickly, this could indicate that the bulb of one of the direction indicators has blown. Change the bulb or contact a CITROËN dealer or a qualified workshop.
	Main beam headlamps	Fixed	This comes on when you pull the lighting stalk towards you.	Pull the stalk to return to dipped beam headlamps.
	Sidelamps	Fixed	This comes on when the lighting stalk is in the "Sidelamps" or "Dipped beam headlamps" position.	Turn the stalk to the desired position.
	Front foglamps	Fixed	This comes on when you use the front foglamps.	Turn the ring on the stalk forwards to switch on the foglamps.
	Rear foglamps	Fixed	This comes on when you use the rear foglamps.	Turn the ring on the stalk forwards to switch on the foglamps.
CRUISE	Cruise control	Fixed	This comes on when the mode is active.	Press the "ON/OFF" button to activate/deactivate the mode.





<https://www.automotive-manuals.net/>

MONITORING

Warning lamp		is on	Cause	Actions/Observations
	Diesel preheating	Fixed	This comes on when the ignition switch is in the ON position.	Wait until this goes off before starting. The duration for which this is on is determined by the exterior climatic conditions.
	Parking brake/ Brake fluid level	Fixed	This comes on for a few seconds when the ignition is turned to "ON" then goes off.	It is accompanied by a message on the instrument panel screen.
			The parking brake is applied or has not been released fully.	It is accompanied by a message on the instrument panel screen. Release the parking brake to switch off the warning lamp.
			The brake fluid level is too low.	It is accompanied by a message on the instrument panel screen. Top up with brake fluid and contact a CITROËN dealer or a qualified workshop.
	Emission control system	Fixed or flashing	This comes on or flashes in the event of a fault with the system.	Contact a CITROËN dealer or a qualified workshop. It should go off a few seconds after starting the engine.
	Battery charge	Fixed	This comes on if a charging circuit fault occurs.	It should go off when the engine is started. It is accompanied by a message on the instrument panel screen. Check the battery terminals (refer to the "Battery" section).

MONITORING

I

Warning lamp		is on	Cause	Actions/Observations
	Driver's seat belt not fastened	Fixed	The driver has not fastened or has unfastened their seat belt.	This is accompanied by a message on the instrument panel screen. Fasten the driver's seat belt.
	ABS	Fixed	This comes on if an anti-lock braking system fault occurs.	It is accompanied by a message in the instrument panel screen. The vehicle retains conventional braking without assistance but you are advised to stop. Have it checked by a CITROËN dealer or a qualified workshop.
	Airbags and pretensioners	Fixed	This comes on for a few seconds when the ignition is turned to "ON" then goes off.	It should go off when the engine is started. If it does not go off, contact a CITROËN dealer or a qualified workshop.
			This comes on if an airbag or pretensioner fault occurs.	It is accompanied by a message on the instrument panel screen. Have the system checked by a CITROËN dealer or a qualified workshop without delay.
	Dynamic stability control system (ASC)	Fixed	This comes on if a dynamic stability control system fault occurs.	It is accompanied by a message on the instrument panel screen. Have the system checked by a CITROËN dealer or a qualified workshop without delay.

MONITORING

INSTRUMENT PANEL DISPLAYS

Each time the engine is started: a series of warning lamps and/or messages come on, applying a checking self test. They go off after a few seconds. Engine running: the warning lamp or the message becomes a warning if it remains on continuously or flashes. This initial warning may be accompanied by an audible signal and a message on the screen. Do not ignore these warnings.

The messages displayed may differ between the type 1 instrument panel and the type 2 instrument panel.

When the cause of the appearance of the warning lamp or warning message has been rectified, the warning disappears from the screen automatically. If the cause of the warning is not rectified, you can return to the previous screen at any time by pressing the **INFO** button on the dashboard.

The symbol "!" is displayed.

To return to the previous screen (with the "!" symbol), you must press the **INFO** button several times.

Symbols which appear in the top right corner of the screen.

You can close the warning messages which show these symbols in order to move on to the next screen.

To do this, press the **INFO** button according to the symbol displayed.





Press **briefly**.



Press **and hold**.









Warning messages (ignition at "OFF")

Message		is on	Cause	Solution - action	Observations
	Key in ignition	Fixed	The driver's door is open and you have forgotten to remove the key from the ignition.	Turn the ignition switch to the LOCK position and remove the key.	Only if the engine has been started. An intermittent audible signal is heard.
	Lighting left on	Fixed	You have forgotten to switch off the vehicle lighting.	Switch off the vehicle lighting by placing the stalk at OFF.	An intermittent audible signal is heard.







<https://www.automotive-manuals.net/>

MONITORING

Warning messages (ignition at "ON")







Message	is on	Cause	Solution - action	Observations
	Fixed	Anti-lock braking system (ABS) fault.	Contact a CITROËN dealer or a qualified workshop.	The vehicle retains conventional braking without assistance but you are advised to stop.
	Fixed	Associated warning lamp. The level of brake fluid in the reservoir is too low. 	Stop and top up, otherwise contact a CITROËN dealer or a qualified workshop.	If the message remains on after topping up, contact a CITROËN dealer or a qualified workshop.
		Associated warning lamp. Braking system fault. 	Contact a CITROËN dealer or a qualified workshop.	You must stop as soon as it is safe to do so.
	Fixed	You have moved off with the parking brake still applied.	Release the parking brake.	
	Flashing	High engine temperature.	If the message flashes , wait for the engine to cool before topping up the level, if necessary.	You must stop your vehicle as soon as it is safe to do so.
	Flashing		If the message flashes and the service warning light comes on , contact a CITROËN dealer or a qualified workshop without delay. 	
	Fixed	The driver has not fastened or has unfastened his seat belt.	Fasten your seat belt.	There is an intermittent audible signal above 5 mph (8 km/h).

MONITORING

Message		is on	Cause	Solution - action	Observations
	Airbags	Fixed	Fault in the airbags or pretensioners.	Contact a CITROËN dealer or a qualified workshop.	
	Service	Fixed	Problem in one of the systems which does not have a specific message.	Stop the vehicle and contact a CITROËN dealer or a qualified workshop.	To identify the problem, contact a CITROËN dealer or a qualified workshop.
	Engine oil pressure	Fixed	Engine oil pressure too low or fault in the engine lubrication system.	Stop the vehicle and contact a CITROËN dealer or a qualified workshop.	
	Engine oil level	Fixed	Engine oil level too low.	Stop the vehicle and check the level using the dipstick.	If there is a lack of oil, top up the level.
	Low fuel warning	Fixed	The fuel level is low.	Refuel as soon as possible.	
	Fuel system	Fixed	Fuel system fault.	Contact a CITROËN dealer or a qualified workshop.	
	Opening not closed correctly	Fixed	One of the doors or the tailgate is not closed correctly.	Close the door or the tailgate.	The opening concerned is indicated on the screen.



<https://www.automotive-manuals.net/>

MONITORING

Message		is on	Cause	Solution - action	Observations
	Dynamic stability control system (ASC)	Fixed	Dynamic stability control system (ASC) fault.	Contact a CITROËN dealer or a qualified workshop.	
	Four wheel drive system	Fixed	Four wheel drive transmission system fault.	Contact a CITROËN dealer or a qualified workshop.	
	Four wheel drive system temperature	Fixed	The temperature of the four wheel drive transmission system is too high.	Stop the vehicle and contact a CITROËN dealer or a qualified workshop.	The vehicle switches to front wheel drive (2 WD) mode automatically.
	Automatic headlamp adjustment system	Fixed	The automatic headlamp adjustment is faulty.	Contact a CITROËN dealer or a qualified workshop.	Only on vehicle fitted with xenon bulbs.
	Battery charge	Fixed	Battery charge fault.	Stop the vehicle and contact a CITROËN dealer or a qualified workshop.	
	Ambient temperature	Fixed	The ambient temperature is 3 °C (37 °F) or below.	Road icy. Take care and drive slowly.	Caution: The road may be icy even when this screen is not displayed.





<https://www.automotive-manuals.net/>

MONITORING



Message		is on	Cause	Solution - action	Observations
	Saturation of the particle emission filter	Fixed	Start of saturation of the particle emission filter.	As soon as traffic conditions permit, regenerate the filter by driving at a speed of at least 35 mph (60 km/h) until the message is cleared.	If the message is still displayed, contact a CITROËN dealer or a qualified workshop.
	Diesel additive level	Fixed	Low Diesel additive level.	Have the level topped up by a CITROËN dealer or a qualified workshop without delay.	
	Water in the Diesel filter (according to country)	Fixed	The presence of water in the Diesel filter is indicated. Risk of damage to the injection system on Diesel engines.	Contact a CITROËN dealer or a qualified workshop without delay.	

MONITORING

Information messages (ignition at "ON")

Message		is on	Status of the system
	2WD two wheel drive system	Flashing	When the "2WD" (2 wheel drive) mode is selected using the transmission mode selector.
	4WD four wheel drive system	Flashing	When the "4WD" (4 wheel drive) mode is selected using the transmission mode selector. This mode is the default mode.
	4WD LOCK four wheel drive system	Flashing	When the "LOCK" (4 wheel drive) mode is selected using the transmission mode selector.
	Ambient temperature	Fixed	This indicates the ambient temperature. When the vehicle is stationary or if the speed is below 12 mph (20 km/h) the temperature displayed may not be the true temperature.

Prevention messages

Display	is on	Cause	Solution - action	Observations
	Fixed	Informs the driver of the time remaining before the vehicle's scheduled service.	Contact a CITROËN dealer or a qualified workshop.	This is displayed for a few seconds when the ignition is switched on.
	Fixed	Informs the driver that they should stop to take a break.	You are advised to take a break.	This is displayed when the driving time that you set previously is reached. An audible signal is heard 3 times and is then heard every 5 minutes until the vehicle stops.

<https://www.automotive-manuals.net/>

MONITORING

INFORMATION ON THE INSTRUMENT PANEL SCREEN

Information display



With the ignition on, press the **INFO** button, located on the fascia to the left of the instrument panel, to display the various types of information in succession:

- distance recorder A,
- distance recorder B,
- service indicator,
- coolant temperature,
- range,
- trip computer,
- setting menu.

Distance recorder (A and B)



The total distance is displayed in zone 1 of the screen and the trip distance in zone 2 (refer to the "Distance recorders" section).

Service indicator



This displays the distance and the number of months remaining before the next service, in line with the manufacturer's servicing schedule (refer to the "Service indicator" section).

Coolant temperature



When the engine is running, this indicates the temperature of the coolant (refer to the "Coolant temperature indicator" section).

Range



When the engine is running, this indicates the number of miles (kilometres) which can still be travelled with the fuel remaining in the tank, based on the average fuel consumption over the last few miles (kilometres) travelled (refer to the "Range" section).

Trip computer

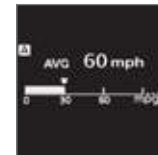

This indicates the average fuel consumption, the average speed and the current fuel consumption (refer to the "Trip computer" section).

Setting menu



When the vehicle is stationary, this allows the user to change the following settings (refer to the "Setting menu" section):

- the display language,
- the temperature display units,
- the fuel consumption units,
- the option to reinitialise the average fuel consumption and the average speed,
- the break (rest) reminder display interval.

MONITORING

DISTANCE RECORDERS (A/B)

System for measuring the total distance travelled by the vehicle during its service life and the distance travelled in a day or other period until it is reset to zero by the driver.



The total distance is displayed in zone 1 of the screen and the trip distance in zone 2.

Zero reset

With the ignition on, press the **INFO** button for more than 2 seconds until zeros appear.

COOLANT TEMPERATURE



When the engine is running, this indicates the temperature of the coolant.

If the bar is close to the **critical** position located on the right, the temperature is too high.

The symbol flashes when your engine is overheating.

You must stop your vehicle as soon as it is safe to do so.

Wait a few minutes before switching off the engine.



Wait for the engine to cool before topping up the level. The cooling system is pressurised.

To avoid any risk of scalding, unscrew the cap by two turns to allow the pressure to drop.

When the pressure has dropped, remove the cap and top up the level, if necessary.

Contact a CITROËN dealer or a qualified workshop.

RANGE



When the engine is running, this indicates the distance which can still be travelled with the fuel remaining in the tank based on the average fuel consumption over the last few miles/kilometres travelled.

When the range is less than **30 miles (50 km)**, dashes are displayed.

Refuel as soon as possible. The display of the range is updated.

This figure may increase following a change in the style of driving or the relief, resulting in a reduction in the current fuel consumption.

If you only add a few litres, the value displayed will be incorrect. Therefore, you must fill the tank whenever possible.



When you disconnect the battery, the previous fuel consumption data is lost and the value displayed will be different from that displayed before the battery was disconnected. The distance displayed must be considered an approximate indication.

MONITORING

SERVICE INDICATOR

System which informs the driver when the next service is due in accordance with the manufacturer's servicing schedule.

The point at which the next service is due is calculated from the last service indicator zero reset.

It is determined by two parameters:

- the distance travelled (in miles (km)),
- the time elapsed since the last service (in months).

The distance remaining to be travelled may be weighted by the time factor, depending on the user's driving habits.

Operation

When the ignition is switched on, you must press the **INFO** button several times in succession until the service indicator is displayed. The distance recorder display line indicates the number of miles (kilometres) remaining and the time elapsed line indicates the number of months remaining before the next service is due.



Example: the display indicates that 7 300 miles (kilometres) remain before the next service is due.



The symbol "---" remains displayed until the first service of a new vehicle has been carried out.

Service overdue

Each time the ignition is switched on, the display "**PERIODIC INSPECTION**" is displayed for a few seconds to indicate that the service must be carried out without delay.



Example: the display indicates that the service is overdue. This service must be carried out by a CITROËN dealer or a qualified workshop.



Resetting the service indicator to zero

Your CITROËN dealer or a qualified workshop carries out this operation after each service.

If you have carried out your vehicle's service yourself, the zero reset procedure is the following:

- ☞ switch off the ignition.
- ☞ press the **INFO** button several times in succession until the service indicator is displayed.
- ☞ press and hold the **INFO** button for a few seconds until the **spanner flashes**.
- ☞ press the **INFO** button while the spanner is flashing to change the display "---" to "**CLEAR**" then the time remaining before the next service is due is displayed.



After a certain distance and a certain time, the display of "---" is reinitialised and the display indicates the time remaining before the next service is due.

MONITORING

TRIP COMPUTER

Information display



With the ignition on, press the **INFO** button on the dashboard, to the left of the instrument panel, several times in succession to display the different information:

- average fuel consumption,
- average speed,
- current fuel consumption.

If dashes "---" are displayed for long periods in place of the digits while driving, contact a CITROËN dealer or a qualified workshop.



Average fuel consumption (l/100 km or km/l or mpg)

This is the average fuel consumption since the last zero reset.

This figure may change following a change in the style of driving or the relief resulting in an increase or decrease in the current fuel consumption.



Average speed (km/h or mph)

This is the average speed calculated since the last zero reset.



Current fuel consumption (l/100 km or km/l or mpg)

This is the average fuel consumption during the last few seconds of driving.

Resetting the information to zero

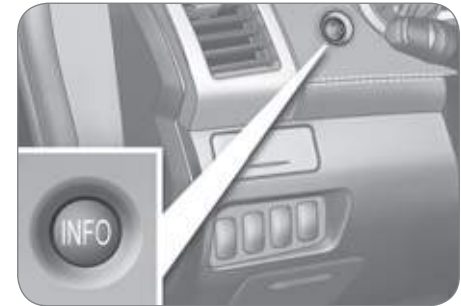

When the required information is displayed, press the **INFO** button for more than two seconds to reset all of the information to zero.

When the ignition is switched on, the zero reset switches automatically from manual mode to automatic mode.

Automatic

If the ignition key remains in the OFF position for more than 4 hours, the information is reset to zero automatically.

MONITORING

SETTING MENU

System which provides access to the settings for certain functions.

The various menus may change between the type 1 instrument panel and the type 2 instrument panel.

With the ignition on, press the **INFO** button on the dashboard, to the left of the instrument panel, several times in succession until the "SETTING MENU" screen is displayed.



When the vehicle is stationary, it allows the user to change the following settings:

- the choice of the reinitialisation of the average fuel consumption and average speed,
- the fuel consumption units,
- the temperature display unit,
- the display language,
- activation/deactivation of the **INFO** button sound,
- the break (rest) reminder display interval,
- restore the factory settings.



To change the settings, you must stop the vehicle and switch on the ignition.

Apply the parking brake and place the gear lever in neutral.

When the vehicle is moving, the function settings are not displayed when you press the **INFO** button.

Operation

- ☞ press and hold the **INFO** button for a few seconds to display the menu screen.



- ☞ on the menu screen, press the **INFO** button to select a function from the list:

MENU 1/3:

- **1 - 2** (choice of the type of reinitialisation of average fuel consumption and average speed),
- **UNIT** (choice of the fuel consumption units),
- choice of the **temperature display unit**,
- **LANGUAGE** (option of the display language),

MENU 2/3:

- **a/b** (option of displaying a different language on the instrument panel screen and the navigation screen),
- **activation/deactivation of the INFO button sound**,
- **ALERT** (changing of the "BREAK REMINDER" display interval),
- **selection of the sound** of the direction indicators,
- **activation/deactivation of the current fuel consumption**,

MENU 3/3:

- **REINITIALISE** (restore factory settings).

Press and hold the **INFO** button for a few seconds to return to the previous screen.

When the menu screen is displayed, if no operation is carried out within 15 seconds, the Setting Menu screen is displayed.

MONITORING

Choice of the reinitialisation of the average consumption and average speed

You can choose between two average fuel consumption and average speed reinitialisation modes:

- automatic reinitialisation (**choice 1**),
- manual reinitialisation (**choice 2**).

On the menu screen:

☞ press the **INFO** button to select:



☞ press and hold the **INFO** button for a few seconds to switch in succession from reinitialisation mode **1 (automatic)** to reinitialisation mode **2 (manual)**.

The mode selected is confirmed.

Choice of the fuel consumption units

You can choose between different units for displaying fuel consumption.

In this case, the distance, speed and quantity of fuel units will also be changed in accordance with your choice of fuel consumption unit.

On the menu screen:

☞ press the **INFO** button to select "**UNIT**".



☞ press and hold the **INFO** button for a few seconds to display the "**UNIT**" screen.



☞ press the **INFO** button to scroll the units (km/L, L/100km, mpg (US), mpg (UK) and PREVIOUS) in succession.

☞ press and hold the **INFO** button for a few seconds to confirm your selection.

If the battery is disconnected, the settings memory is cleared and the default unit (km/L) is restored automatically.

Choice of the temperature display unit

You can choose between different units for displaying the temperature.

On the menu screen:



☞ press the **INFO** button to select the temperature unit setting symbol (thermometer).



☞ press and hold the **INFO** button for a few seconds to scroll the units (°C and °F) in succession.

The mode selected is confirmed.

If the battery is disconnected, the settings memory is cleared and the default unit (°C) is restored automatically.

MONITORING

Choice of the display language

You can choose between different languages for the display.

On the menu screen:

- press the **INFO** button to select "**LANGUAGE**".



- press and hold the **INFO** button for a few seconds to display the "**LANGUAGE**" screen.

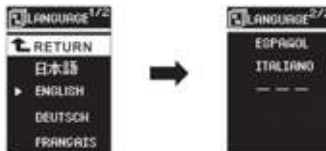

- press the **INFO** button to scroll the languages (Japonais, English, Deutsch, Français, Español, Italiano, "---" and PREVIOUS) in succession.
- press and hold the **INFO** button for a few seconds to confirm your selection.

If you select the "---" setting, no message will be displayed in message display situations.

If the battery is disconnected, the settings memory is cleared and the default language (ENGLISH) is restored automatically.

Activation/deactivation of the "INFO" button sound

You can activate or deactivate the **INFO** button sound.

On the menu screen:



- press the **INFO** button to select the **INFO** button sound activation/deactivation symbol (located on menu 2/3).



- press and hold the **INFO** button for a few seconds to scroll the choices (ON, OFF) in succession.

The mode selected is confirmed.

If the battery is disconnected, the settings memory is cleared and the default choice (ON) is restored automatically.

Changing the display interval of the "BREAK REMINDER" message

You can change the display interval of the "**BREAK REMINDER**" message.

On the menu screen:

- press the **INFO** button to select "**ALERT**" (located on menu 2/3).



- press and hold the **INFO** button for a few seconds to display the "**ALERT**" screen.



- press the **INFO** button to select the display interval of the "**BREAK REMINDER**" message.
- press and hold the **INFO** button for a few seconds to confirm.

If the battery is disconnected, the settings memory is cleared and the default value (OFF) is restored automatically.

MONITORING

Selection of the sound of the direction indicators

You can select the sound of the direction indicators, with the type 2 instrument panel only.

On the menu screen:

- press the **INFO** button to select sound 1 or 2 (**located on menu 2/3**).



Activation/deactivation of the current fuel consumption

You can activate or deactivate the current fuel consumption, with the type 2 instrument panel only.

On the menu screen:

- press the **INFO** button to select the current fuel consumption activation/deactivation symbol (**located on menu 2/3**).



- press and hold the **INFO** button for a few seconds to scroll through the choices in succession (ON, OFF).

Restoring factory settings (REINITIALISE)

You can restore all of the factory settings for all functions.

On the menu screen:

- press the **INFO** button to select "**REINITIALISE**" (**located on menu 2/2 or 3/3 depending on the instrument panel**).

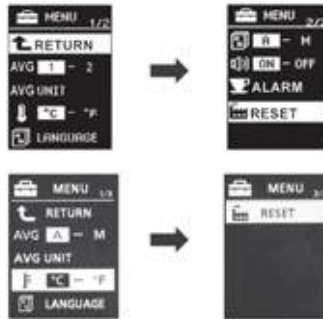

- press and hold the **INFO** button for **at least 5 seconds**.

An audible signal is heard and all of the factory settings are restored for all functions.

The factory settings are:

Functions	Factory setting
Reinitialisation of average fuel consumption and average speed	1 (automatic)
Fuel consumption units	L/100 km
Temperature display unit	°C
Display language	ENGLISH
INFO button sound	ON (activated)
Display of the "BREAK REMINDER" message	OFF (deactivated)

MONITORING

MONOCHROME SCREEN



This provides the following information:

- the time,
- audio system information (refer to the "Audio and Telematics" section).

Setting the time



The digital clock can be set in **automatic mode** or in **manual mode**.

Automatic mode

This mode permits automatic setting of the local time using the signal from RDS stations.

The symbol "**CT**" appears on the screen.

Manual mode

This mode permits manual setting of the time using the audio equipment buttons.

It can also be used when the "Automatic mode" displays an inaccurate time, when the local RDS stations are broadcasting from a different time zone.

Selecting the Setting

Select the **automatic mode** or the **manual mode** as follows:



- ☞ Press button **A** "PWR" to switch on the audio system.
- ☞ Access the setting mode by pressing button **B** "TUNE" for approximately 2 seconds.
- ☞ Press button **B** "TUNE" several times to scroll through the various menus and select the **CT menu** (clock time).

The order of the menus is the following:
AF/CT/REG/TP-S/PTYdisplaylanguage/
SCV/PHONE/Functions setting mode
OFF.

MONITORING



- ☞ Turn button **B** "TUNE" to the left or to the right to select "**CT ON**" (automatic mode) or "**CT OFF**" (manual mode).
- ☞ After selecting the mode, you can exit the "Functions setting mode" menu by pressing button **B** "TUNE" for approximately 2 seconds.

If no action is carried out within 10 seconds, the system will exit the "Functions setting mode" menu automatically.

Automatic mode

In this mode, setting is automatic using the signal from the RDS radio stations.

Manual mode



Set the time using the buttons as indicated below:

- ☞ with the ignition on or in the ACC (Accessories) position, press and hold the **CLOCK** button until the time display flashes.
- ☞ Press the appropriate button to set the time:

Button H: to set the hours

The hours digits scroll when you press this button.

Button M: to set the minutes

The minutes digits scroll when you press this button.

Button 00: to reset the minutes to zero.

- from **1 to 29 min** : rounded down to the previous hour,
- from **30 to 59 min**: rounded up to the next hour.

- ☞ After setting the time, press the **DISP** button; the time display stops flashing.

The digital clock does not display seconds.

When the "minutes" display is set or reset to zero, the clock starts at the zero second of the minute selected.

The time setting is lost if the battery is disconnected.

MONITORING

COLOUR SCREEN



This permits display of the following main menus:

"Audio-video" menu



On the control panel, press button **A (MODE)** to access the **"AV mode"** screen and select:

- radio (FM, MW, LW),
- CD (audio, MP3 or WMA),
- Music Server,
- DVD.

The "CD" and "DVD" buttons are active if you insert a CD or DVD in the player.

"Settings" menu



On the control panel, press button **B (SET)** to access the **"Settings"** screen and select:

- **"Display Off"** to switch off the display,
- **"Sound control"** for the sound distribution or volume, the type of music and the sound field (surround),
- **"Picture control"** to set the colour, the intensity, the brightness, the contrast and the level of black,
- **"System"** to change the time zone, the language, the units and other settings,
- **"Wide Screen"** to change the size of the DVD picture to 4/3 format, wide screen mode, centred wide screen mode or enlargement,
- **"Equipment"** to set certain equipment offered in the vehicle,
- **"Colour Contrast"** to select the contrast of the display in relation to the ambient light (Day, Night or Auto),
- **"TP standby"** to activate or deactivate the traffic information.

"Navigation-guidance" menu



On the control panel, press button **C (MENU)** to access the **"Menu"** screen and select:

- **"Address/Junction"** to search for a location using the address or the name of the street,
- **"POI name"** to search for a location using the name of a point of interest (POI),
- **"Advanced search"** to search for a location using an advanced search based on a POI,
- **"Previous 20"** to search for a location using one of the 20 previous destinations,
- **"Address book"** to search for a location using a stored address,
- **"Home"** to navigate to your home address,
- **"Navigation settings"** to set functions linked with the navigation,
- **"Navigation tools"** to access the basic information or a pre-set demonstration.

MONITORING

"Info" menu



On the control panel, press button **D (INFO)** to access the "Info" screen and consult:

- "**Support info**" to display the software and data versions,
- "**Vehicle position**" to display the GPS location of the vehicle,
- "**Calendar**" to make a note of events, birthdays, etc.,
- "**Journey**" to display the average speed, fuel consumption, distances and driving time,
- "**Environment**" to display the altitude, the atmospheric pressure, the exterior temperature (the ice symbol is displayed if there is a risk of ice),
- "**Air conditioning**" to display the information relating to the air conditioning,
- "**Mobile phone**" to enter a number, delete a character, make or receive a call.

"Route" menu



On the control panel, press button **E (NAVI)** to access the "Route Menu" screen and select:

- "**Detour**" to make a detour through a specified region,
- "**Itinerary**" to change the route,
- "**View route**" to display a route in different ways,
- "**Delete route**" to delete a route,
- "**Nearby POI**" to search for the POIs in the surrounding area.

Setting the time



The digital clock is set **automatically**.

This mode enables the system to set the local time automatically using the signal from the RDS stations.

- ☞ On the control panel, press button **A (SET)** to access the "Settings" menu.



- ☞ On the touch screen, press button **B** to access the "**System**" menu.

The system settings screen is displayed.

MONITORING

Once this menu has been selected, you can access the following functions:



☞ Press button **C** to access the "Time" menu.

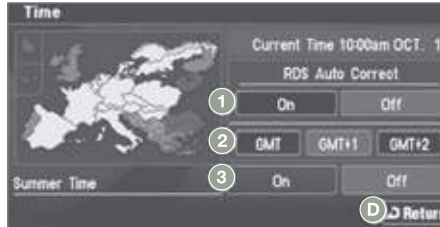

- 1. RDS Auto Correct:**
Activate/deactivate automatic adjustment.
 - 2. GMT/GMT+1/GMT+2**
Select the time zone.
 - 3. Summer Time:**
Summer time On/Off.
- ☞ Press button **D** to confirm and return to the previous menu.

You must deactivate automatic adjustment (RDS Auto Correct) to change the time zone and summer time settings.

On each screen, you can return to the previous screen by pressing button **D "Return"**.

LIGHTING RHEOSTAT

System for manual adjustment of the brightness of the instruments and controls in relation to the exterior brightness.



With the lighting on or off, press the button to change the intensity of the lighting of the instruments and controls in "day" or "night" mode.

An audible signal is heard and the intensity of the lighting increases each time the button is pressed.

When the lighting reaches the maximum setting, press again to change to the minimum setting.

When the lighting reaches the required intensity, release the button.

The setting is saved when the ignition switch is turned to OFF.

AUTOMATIC REGULATION OF THE DIGITAL AIR CONDITIONING

Use of the automatic regulation of the air conditioning is recommended. It permits automatic and optimised control of all of the following functions: air flow, passenger compartment temperature and air distribution, by means of various sensors (ambient temperature, interior temperature, sunshine), so preventing the need for you to change your settings other than the value displayed.

Do not cover the temperature and humidity sensor **2** and the sunshine sensor **7**.

They are required for regulation of the air conditioning.

Advice on operation

In hot weather, in order to obtain intense ventilation, it is advisable to use vents **1** and **4** only.

If, when the vehicle has been parked in the sun for a long time, the interior temperature remains very high, first ventilate the passenger compartment for a few minutes.

For even air distribution, take care not to obstruct the exterior air intake grille located at the bottom of the windscreen, the vents, the air outlets under the front seats and the air extractor located behind the flaps in the boot.

In certain cases of particularly arduous use (towing the maximum load on a steep gradient in hot weather), switching off the air conditioning saves engine power and therefore improves the towing capacity.

Close the windows to benefit from the full effectiveness of the air conditioning.

Ensure that the passenger compartment filter is in good condition. Have the filter elements replaced periodically. If you drive in a dusty environment, replace it twice as often.

The air conditioning system does not contain chlorine and is not harmful to the ozone layer.

Operate the air conditioning system for 5 to 10 minutes, once or twice a month, to keep it in good working order.

The water formed by the air conditioning condensation is discharged via an opening provided for this purpose. Therefore, a puddle of water may form underneath the vehicle when stationary.

If the system does not produce cold air, do not use it and have it checked by a CITROËN dealer or a qualified workshop.

1. Central vents.
2. Temperature sensor.
3. Air outlet to passenger footwells.
4. Side vents.
5. Front window demisting/defrosting vents.
6. Windscreen demisting/defrosting vents.
7. Sunshine sensor.



Switch off the air conditioning when the climatic conditions permit.

COMFORT

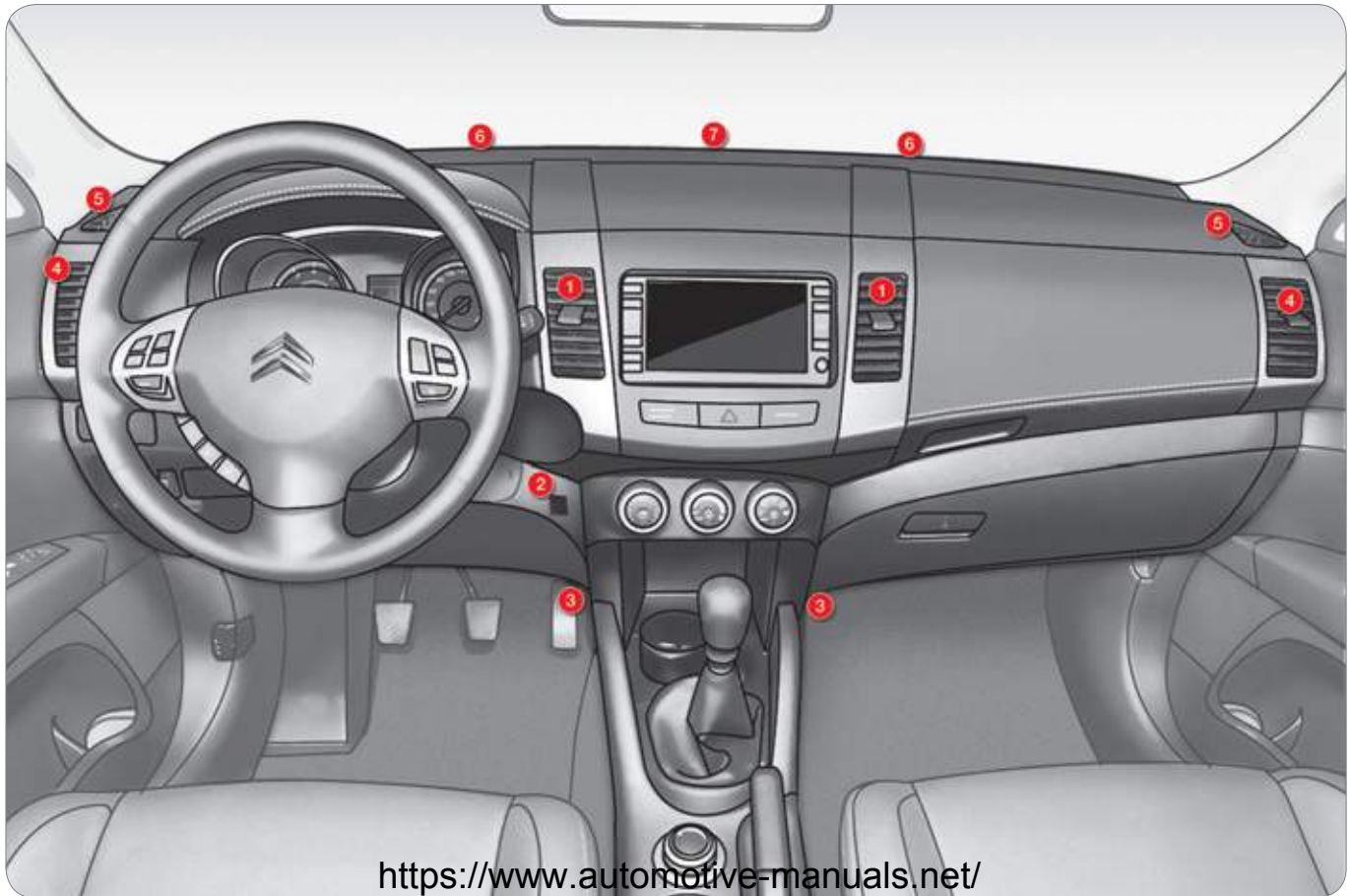

<https://www.automotive-manuals.net/>

COMFORT

AUTOMATIC AIR CONDITIONING



1. Temperature adjustment
2. Air flow adjustment
3. Air distribution adjustment
4. Intake of exterior air/Recirculation of interior air
5. Air conditioning On/Off
6. Rear screen demist/defrost

Automatic operation

- ☞ Set the temperature control dial **1** to the temperature required.
- ☞ Place the air flow control dial **2** in the "**AUTO**" position.
- ☞ Place the air distribution adjustment dial **3** in the "**AUTO**" position.

The system controls the air distribution, the flow, the temperature and the air intake to ensure the level of comfort selected and adequate air circulation in the passenger compartment. No further action on your part is required.

In automatic mode:

- ☞ when the temperature is set to maximum (Rapid heating), the intake of exterior air is activated and the air conditioning stops.
- ☞ when the temperature is set to minimum (Rapid cooling), the air recirculation is activated and the air conditioning operates.

When the engine is cold, to avoid an excessive distribution of cold air, the ventilation will reach its optimum level gradually.

On entering the vehicle, the interior temperature may be much colder (or warmer) than the comfort temperature. There is no need to change the temperature displayed in order to reach the comfort required rapidly.

The automatic regulation of the air conditioning will operate to correct the temperature difference as quickly as possible.

COMFORT

Manual operation

It is possible to set one or more functions manually while leaving the other functions in automatic mode.

Switching to manual mode may result in discomfort (temperature, humidity, odour, condensation) and does not offer optimum comfort.

Temperature adjustment (1)



☞ Turn the temperature control dial to the right to increase the temperature and to the left to decrease it.

Air flow adjustment (2)



☞ Turn the dial to the right to increase the air flow or to the left to decrease it.

To avoid condensation and deterioration of the quality of the air in the passenger compartment, ensure that a sufficient flow of air is maintained.

Air distribution adjustment (3)



☞ Place the dial in the position required to direct the air towards:



the central and side vents,



the central and side vents and the footwells,



the footwells,



the windscreen, the side windows and the footwells,



the windscreen and the side windows.

The air distribution can be adapted by placing the adjustment dial in the intermediate positions.



Intake of exterior air/ Recirculation of interior air (4)

This function insulates the passenger compartment from exterior odours and smoke.

☞ Press button **4** to select the air intake mode.

When the indicator lamp on button **4** is off, the exterior air intake function is on.

When the indicator lamp on button **4** is on, the intake of exterior air is off and the system is in air recirculation mode.

Do not drive for long periods in interior air recirculation mode, except in truly exceptional atmospheric conditions.

Personalisation of the Exterior air intake/Interior air recirculation function

This function is controlled automatically. However, you can deactivate its automatic control if you wish to change the air intake mode at any time.

Changing the status

Press the Air intake/Interior air recirculation button for at least 10 seconds.

When the status changes from active to inactive, three bleeps are heard and the indicator lamp flashes three times.

When the status changes from inactive to active, two bleeps are heard and the indicator lamp flashes three times.

Automatic control active

If the air distribution adjustment dial and the air flow adjustment dial are placed in the "AUTO" position, the Air intake/Interior air recirculation function is also controlled automatically.

Automatic control inactive

Even if the air distribution adjustment dial and the air flow adjustment dial are placed in the "AUTO" position, the Air intake/Interior air recirculation function is no longer controlled automatically.

The settings are retained, even after switching off the ignition.



Air conditioning On/Off (5)

☞ Press button **5** to activate the air conditioning.

The indicator lamp comes on.

Personalisation of the Air Conditioning On/Off function

This function is controlled automatically. However, you can deactivate its automatic control if you wish to activate or deactivate the air conditioning at any time.

Changing the status

Press the Air Conditioning On/Off button for at least 10 seconds.

When the status changes from active to inactive, three bleeps are heard and the indicator lamp flashes three times.

When the status changes from inactive to active, two bleeps are heard and the indicator lamp flashes three times.

Automatic control active

If the air distribution adjustment dial and the air flow adjustment dial are placed in the "AUTO" position, or if the temperature control dial is set to the minimum temperature, the air conditioning system is controlled automatically.

Automatic control inactive

The air conditioning system is no longer controlled automatically.



Rear screen demisting/defrosting (6)

With the engine running, press button **6** to activate the demisting/defrosting of the rear screen and door mirrors.

The indicator lamp on the button comes on while the demisting/defrosting is in operation.

The demisting/defrosting goes off automatically to prevent excessive consumption of current.

Demisting/defrosting can be stopped before it is switched off automatically by pressing the button again.



It is advisable to switch off the rear screen demisting/defrosting as soon as possible as lower current consumption reduces fuel consumption.

Windows and windscreen demisting/defrosting

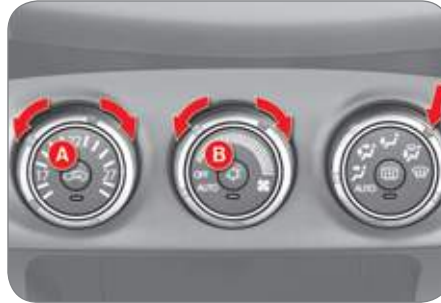

Demisting/defrosting

1. Press button **A** to select "exterior air intake". The indicator lamp on this button goes off.
2. Place the air distribution dial in the "windscreen, side windows and footwells" position.
3. Select the air flow required.
4. Select the temperature required.
5. Press the "air conditioning on/off" button **B** to activate the air conditioning. The indicator lamp on this button comes on.



Rapid demisting/defrosting

1. Place the air distribution dial in the "windscreen and side windows" position.
2. Select the maximum air flow.
3. Select the maximum temperature.

COMFORT

FRONT SEATS

Manual mode

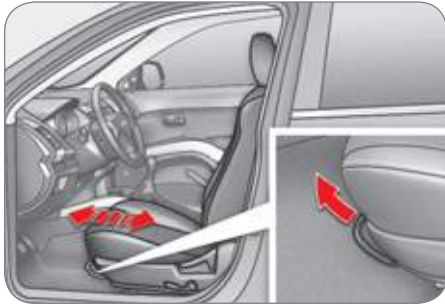

Forwards-backwards adjustment

Raise the control bar and slide the seat forwards or backwards.

When your seat is at the correct distance, move it forwards and backwards slightly without using the control bar to check that it is secured correctly.

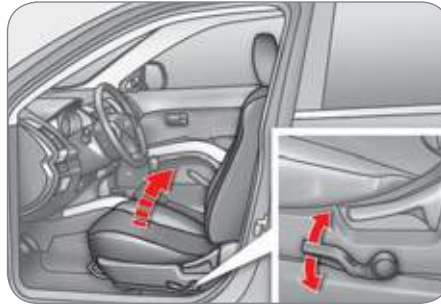

Driver's seat cushion height and angle adjustment

Pull and/or push the control several times to adjust the height of the seat.

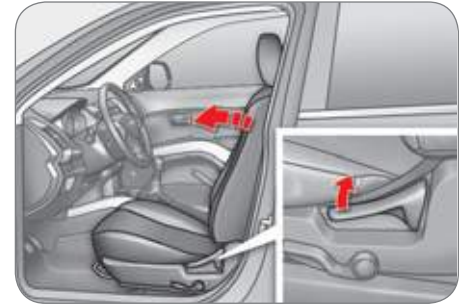

Seat back angle adjustment

Pull the control upwards to adjust the seat back.

When the seat back is at the correct angle, release the control.



To prevent the seat back from moving forward sharply and knocking you, press on it with your back or push it with your hand while operating the lever.

COMFORT

FRONT SEATS

Electric mode (driver's seat only)

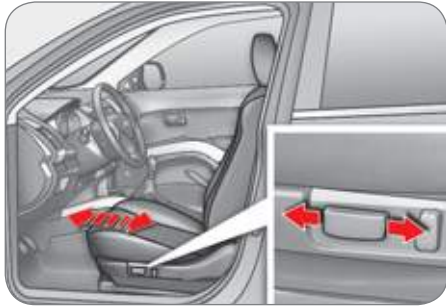

Forwards-backwards adjustment

Push the control forwards or rearwards to move the seat to the position required.

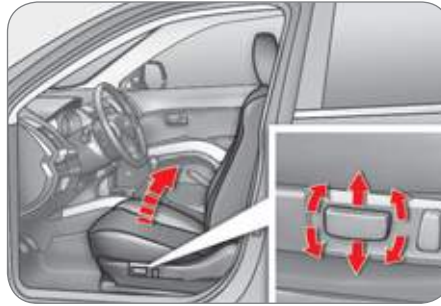

Driver's seat cushion height and angle adjustment

Pull or push the front of the control to raise or lower the front of the seat cushion.
Pull or push the rear of the control to raise or lower the rear of the seat cushion.
Pull or push the entire control to raise or lower the entire seat cushion.



Seat back angle adjustment

Tilt the control forwards or rearwards to straighten or tilt the seat back.

To avoid discharging the battery, use the electric mode with the engine running.

COMFORT

Heated seats adjustment



With the engine running, tilt the button to the position required.

The temperature of the seat is regulated automatically.

There are two setting positions:

- "HI": High heating
- "LO": Low heating

When the button is in the intermediate position, the heating is switched off.

The indicator lamps **A** come on when the system is activated.

Head restraint height adjustment

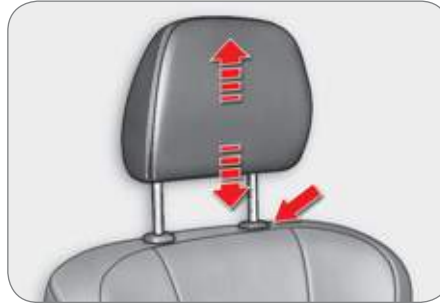

- ☞ To raise it, pull upwards.
- ☞ To lower it, push it downwards, pressing the height adjustment button at the same time.
- ☞ To remove it, raise it to the high position, then remove it pressing the height adjustment button at the same time.
- ☞ To refit it, engage the rods of the head restraint in the apertures, pressing the height adjustment button at the same time.

! Never drive with the removed head restraints in the vehicle as they could be thrown around the vehicle on sharp braking. They must always be in place and adjusted correctly.

After installing the head restraint, check that the height adjustment button has engaged correctly.

The adjustment is correct when the top of the head restraint is aligned with the top of the head of the seated person.

Front armrest



You can move the console housing cover in order to use it as an armrest.

COMFORT

REAR SEATS (ROW 2)

The rear seats can be folded in two parts (1/3 - 2/3).



Forwards-backwards adjustment

Pull the control towards the outside and adjust.

When your seat is at the correct distance, release the control.

To ensure that the seat is secured correctly, move it forwards and backwards slightly without using the control.



Seat back angle adjustment

Pull the control and adjust.

When the seat back is at the correct angle, release the control.

Sit in the centre of the rear bench seat to check that the two seats are at the same level and that the angle of their seat backs is the same.

! When operating the seats, ensure that no person or object is in the vicinity of the moving parts to avoid any risk of injury or damage.

To prevent the seat back from moving forwards sharply and knocking you, press on it with your back or push it with your hand while operating the lever.

COMFORT

Rear armrest



Lower the armrest to use it.
To return to the initial configuration, push the armrest until it locks in its vertical position.

Access to the third row

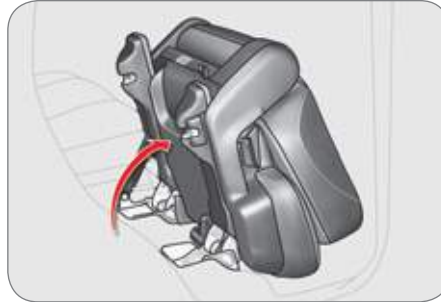

The passenger gains access to the third row of seats by tilting a second row seat.

To put this seat back in place, refer to the following pages.

COMFORT

Folding the second row*

Before folding the seats, lower the head restraints fully.

Before folding the seat backs forwards, insert the seat belt buckles in the slots provided for this purpose in the rear seat cushion.



1. Raise the rear seat lever **A**, or
Pull the button in the boot **B** for at least one second, or
Pull the rear seat releasing strap **C** towards you.
2. The seat backs fold forwards then the cushion rises and folds forwards.
3. After carrying out these operations, press on the seat lightly to check that it is secured correctly.



Before folding the seats, ensure that no object or person is hindering the execution of the operations.
Do not place luggage on the folded seats.

* According to version.

COMFORT

Returning the second row to the normal position

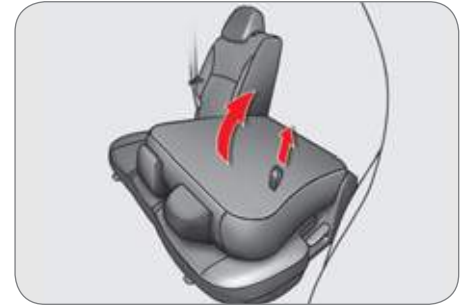
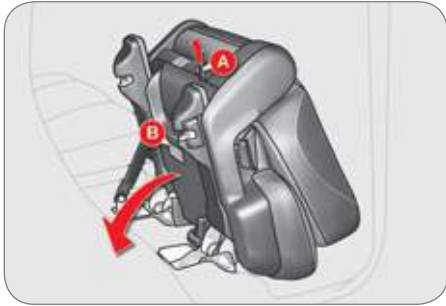

1. Lower the seat pulling simultaneously on the releasing strap **A** located at the rear of the cushion and supporting the seat with your hand.
2. Press on the cushion to put it in place until it engages.
3. Pull the seat back upright pulling simultaneously on the releasing strap located at the rear of the seat back.
4. After putting the seat back back in place, push the seat and the seat back lightly to ensure that they are secured correctly.

Force may be necessary to carry out these operations.

On vehicles fitted with a third row, the rear of the cushion of the second row is fitted with a low level lamp **B**.

When the releasing strap is pulled, the lamp comes on for approximately 10 seconds to illuminate the floor at the base of the third row.

COMFORT

"Lowered seats" configuration

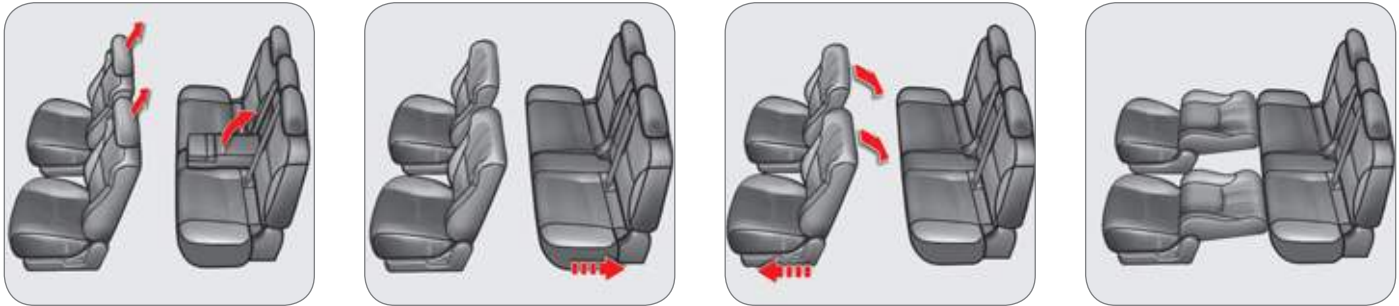

1. Remove the head restraints from the front seats.
2. Raise the rear armrest and remove the load space cover.
3. Move the rear seats as far back as possible.
4. Move the front seats as far forward as possible and tilt their seat backs fully.
5. Tilt the seat back of the rear seats.

To return the seats to their normal position, carry out these operations in reverse order.

COMFORT

REAR BENCH SEAT (ROW 3)

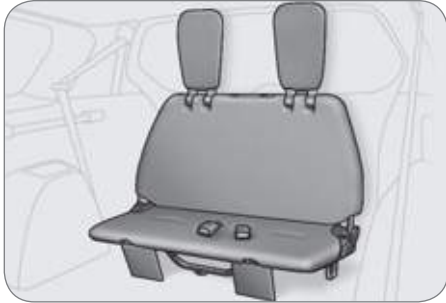

The rear bench seat can be folded. It is stowed in a location in the floor of the vehicle.

For comfort, it is advisable to stow the bench seat when it is not in use.



The label on the bench seat back illustrates the various steps to be followed when unfolding and folding the rear bench seat.

Unfolding the bench seat

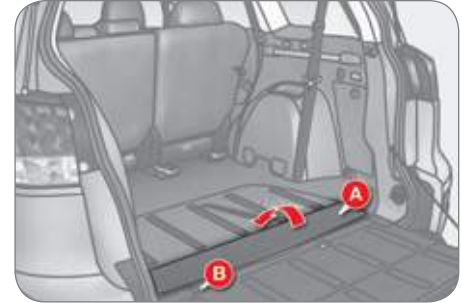

1. Open the tailgate and the lower tailgate (refer to the "Access" section).
2. Pull the cover **A** from the rear and fix it to the seat back using the press stud of the band **B**.

COMFORT



3. Pull the black strap **C** located at the centre of the seat back to raise the seat back.



4. Pull the black strap **D** to release the bench seat cushion.



5. Tilt the bench seat rearwards.



6. Raise the head restraints.



7. Lift and push the bench seat assembly forwards until it locks.

Undo the press stud of band **B** to release the cover.

COMFORT

Folding the bench seat



1. Open the tailgate and the lower tailgate (refer to the "Access" section).
2. Lift the cover **A** and fix it to the seat back using the press stud of the band **B**.



3. Unlock the head restraints by sliding the controls **C** and fold them onto the seat back.



4. Pull the grey strap **D** and bring the bench seat towards you. Press on the bench seat to lock it.



5. Tilt and push the bench seat forwards.



6. Pull the black strap **E** located at the centre of the seat back to fold the seat back.

DOOR MIRRORS



Adjustment

The mirrors can be adjusted when the ignition switch is in the "ON" or "ACC" position.

- ☞ Move control **A** to the right or to the left to select the corresponding mirror.
- ☞ Direct control **B** in all four directions to adjust the mirror.

When adjustment is complete, return control **A** to the central position.



Electric folding/unfolding

- from inside, with the ignition switch in the "ON" or "ACC" position
 - ☞ by pressing the control **C**.
- from inside, with the ignition switch in the "LOCK" position:
 - ☞ by pressing the control **C**, **within 30 seconds**.
- from outside using the remote control:
 - ☞ by pressing the "closed padlock" button briefly 3 times to fold them,
 - ☞ by pressing the "open padlock" button briefly 3 times to unfold them.

! The mirrors can also be folded manually.

If you have folded the mirrors using the control **C**, you must use this control to unfold them, otherwise the mirrors will not be lock in place correctly.

If you switch the engine off then restart it with the mirrors folded, they will unfold automatically when the vehicle reaches 20 mph (30 km/h).

If the mirrors have been folded manually or electrically after starting the engine, they are not unfolded automatically.

In this case:

- ☞ Press the control **C** to unfold them.

The folding and unfolding of the door mirrors can be configured via the colour screen "Equipment" menu or deactivated by a CITROËN dealer or a qualified workshop.

COMFORT

REAR VIEW MIRROR



Adjust the mirror by moving it up or down and/or to the left or right.

The rear view mirror has two positions:

- day (normal),
- night (anti-dazzle).

To change from one to the other, push or pull the lever on the lower edge of the mirror.

AUTOMATIC REAR VIEW MIRROR*



This automatically and gradually changes between the day and night positions.

To prevent dazzling, the glass of the mirror darkens automatically depending on the intensity of the light from behind. It clears as the light (headlamps of following vehicles, sunlight) decreases, ensuring maximum visibility.

You can deactivate automatic mode by pressing the **"AUTO"** button.

AUTOMATIC REAR VIEW MIRROR WITH REVERSING CAMERA*



Combined with a camera fitted at the rear of the vehicle, this mirror allows the driver to see what there is behind the vehicle when reversing.

With reverse engaged, the screen is displayed automatically in the mirror glass.

A warning message appears suggesting that you check around your vehicle.

The screen disappears when another gear is engaged.

You can deactivate automatic mode by pressing the **"AUTO"** button.

STEERING WHEEL MANUAL HEIGHT ADJUSTMENT

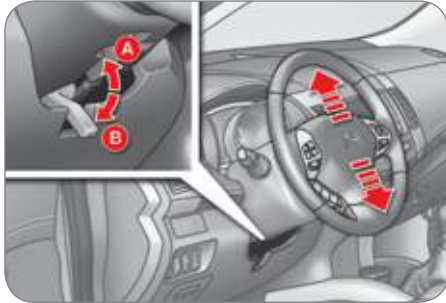

- ☞ Pull the locking lever downwards (position **B**) while supporting the steering wheel.
- ☞ Adjust the steering wheel to the required height.
- ☞ Lock the steering wheel adjustment by pushing the lever upwards (position **A**).



As a safety precaution, these operations must only be carried out while the vehicle is stationary.

SUN VISOR

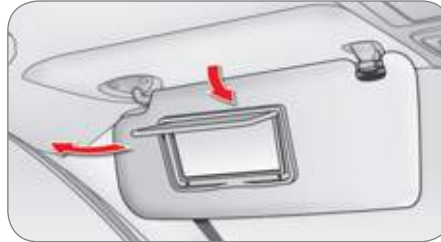

The sun visors fold forwards, and to the side when they are unhooked. They are fitted with a courtesy mirror and a ticket holder.

AREAS FOR TOLL CARDS/CAR PARK TICKETS



The athermic windscreen has a non-reflective zone located above the base of the rear view mirror.

It is intended for affixing toll cards and/or park tickets.

MAT

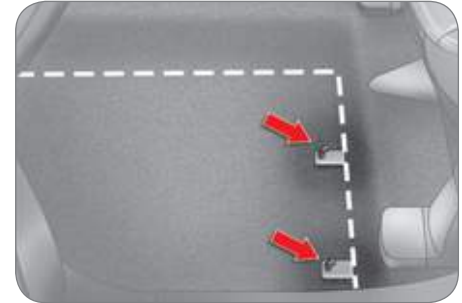

When removing the mat on the driver's side, move back the seat as far as possible and remove the fixings.

When refitting, position the mat correctly on the pins and clip the fixings. Check that the mat is secured firmly.



To prevent any risk of jamming under the pedals:

- only use mats suited to the fixings already present in the vehicle; it is imperative that these fixings are used.
- never fit one mat on top of another.

COMFORT

II

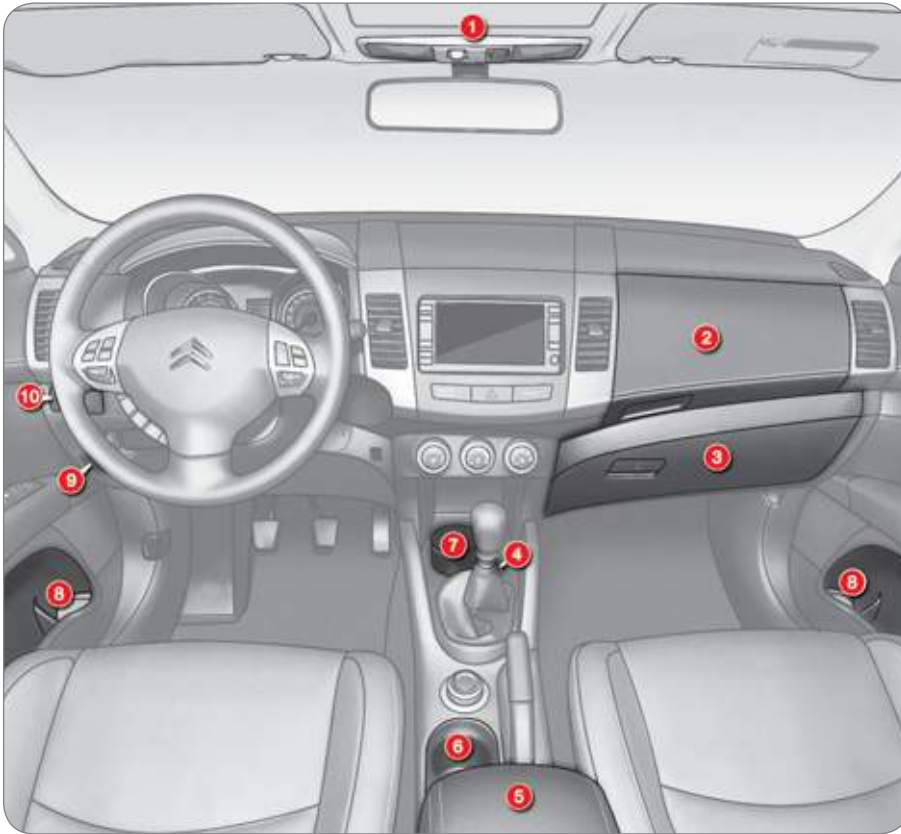

FRONT INTERIOR FITTINGS

1. Spectacles storage.
2. Cooled upper glove box.
3. Lockable lower glove box.
4. 12 V socket (120 W max).
5. Armrest with storage compartments
12 V socket (120 W max).
6. Cup holder.
7. Removable ashtray.
8. Bottle holder.
9. Enclosed storage compartment.
10. Cup holder.

<https://www.automotive-manuals.net/>

COMFORT

Spectacles storage



Press the cover to open it.
To close it, push the cover until it locks.

Cooled upper glove box

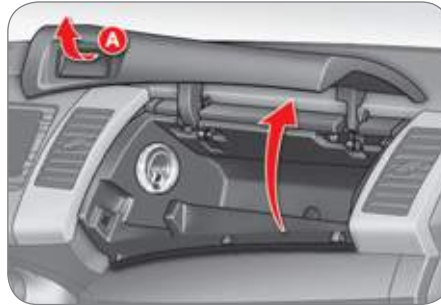

Press button **A** on the lid to open it.
To close it, push the lid up.
It is fitted with a ventilation nozzle which can be closed by means of a dial, distributing conditioned air at the same temperature as the vents in the passenger compartment.
In cold weather, it is advisable to close this vent to conserve the ambient air inside the passenger compartment.

Lower glove box

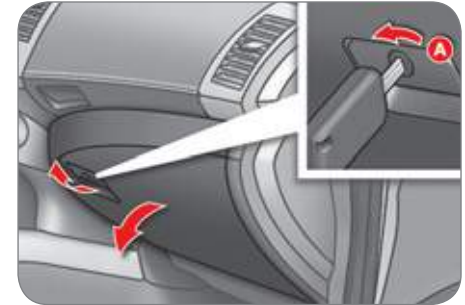

This is fitted with a lock.
To unlock it, turn the key to the left.
To open it, pull the handle **A**.
To close it, push the lid up.
To lock it, turn the key to the right.
It is fitted with a pen holder and a card holder.
It is illuminated on opening when the vehicle lighting is on.

COMFORT

12 V socket (120 W max)



This is operational when the ignition switch is in the "LOCK", "ON" or "ACC" position.

Check that the electrical equipment operates on 12 volts and that its electrical power is 120 W maximum.

Armrest with storage compartments 12 V socket (120 W max)



Upper storage compartment

Pull the right-hand lever to open the storage compartment lid, which serves as an armrest.

To close, fold down the lid until it locks.

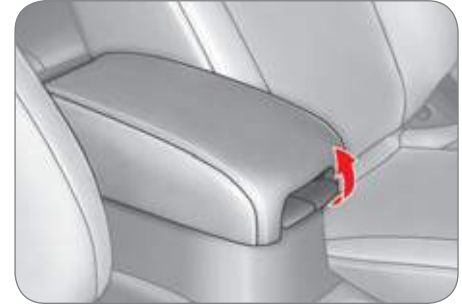

Lower storage compartment

Pull the left-hand lever to open the lid. To close, fold down the lid until it locks.



The prolonged use of electrical equipment without running the engine may discharge the battery.

COMFORT

12 V socket (120 W max)



This operates when the ignition switch is in the "LOCK", "ACC" or "ON" position. Open the cover to gain access to the socket.



Check that the electrical equipment operates on 12 V and that its maximum electrical power is 120 W.

When you use the two sockets at the same time, ensure that the two items of equipment together operate on 12 V and that their combined electrical power is 120 W maximum.

The prolonged use of electrical equipment without running the engine may discharge the battery.

Removable ashtray



Pull the cover to open the ashtray. To empty, remove the ashtray by pulling it upwards.

COMFORT

Enclosed storage compartment



Pull the storage compartment lid to open it.

Cup holder



There is a cup holder fitted in the dashboard on the driver's side.
Press on the centre of the cover to extract the plate.
Pull it fully to use it.
Push it fully to store it.

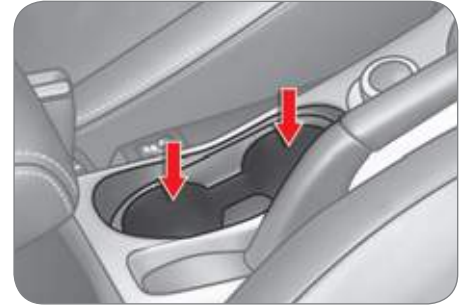

Two further cup holders are available in front of the front armrest.

COMFORT

REAR INTERIOR FITTINGS

Rear armrest



Pull the armrest forwards to lower it.

Bottle holder



There is a bottle holder in each rear door.

Coat hook



The rear left grab handle is fitted with a coat hook.

Cup holder



Open the cover **A** located at the end of the armrest holding the side with your hand.

Grab handle

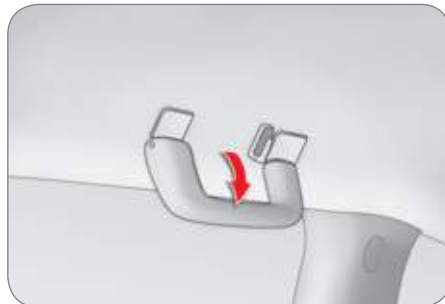

Pull the handle downwards to lower it.

COMFORT

II



BOOT FITTINGS

1. 12 V socket (120 W max).
2. Open storage compartment.
3. Right-hand side enclosed storage compartment.
4. Storage compartment in the floor*.
5. Stowing rings.
6. Left-hand side storage compartment or audio equipment.
7. Load space cover.

<https://www.automotive-manuals.net/>

5-seat version only.

COMFORT

12 V socket (120 W max)

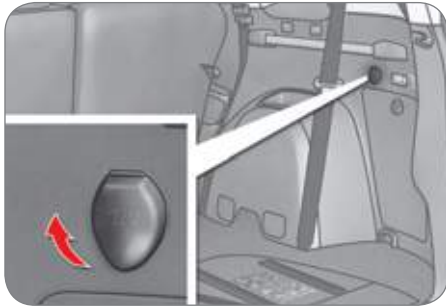

This operates when the ignition switch is in the "ON" or "ACC" position.

Lift the cover to gain access to the socket.



Check that the electrical equipment operates on 12 V and that its maximum electrical power is 120 W.

The prolonged use of electrical equipment without running the engine may discharge the battery.

Right-hand side enclosed storage compartment

This storage compartment contains the tools for changing a wheel.

Stowing rings



There are four stowing rings in the boot for securing luggage:

- two rings are located on the boot floor,
- two rings are located on the rear side pillars.

Storage compartment in the floor*



Raise the boot floor to gain access to this compartment.

COMFORT

Load space cover

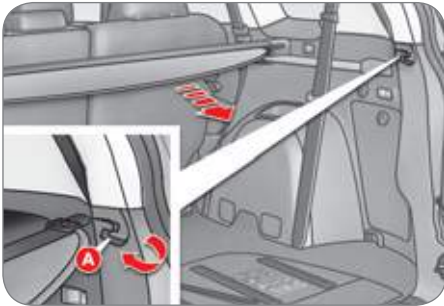

Unroll the load space cover and install it in the housing **A**.

To store the load space cover, release it from the housing, it reels in to its initial position.

Second installation position

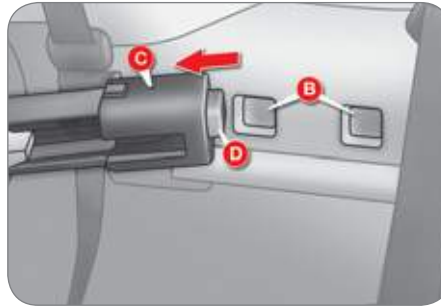

The load space cover can be secured in two different positions **B**, so that the row 2 seat backs can be tilted.

1. Reel in the load space cover.
2. Move one of the slides **C** towards the inside of the vehicle and insert the tab **D** in the installation hole to be used.
Move the opposite slide in the same way.
3. After changing the position, check that the load space cover is secured correctly.

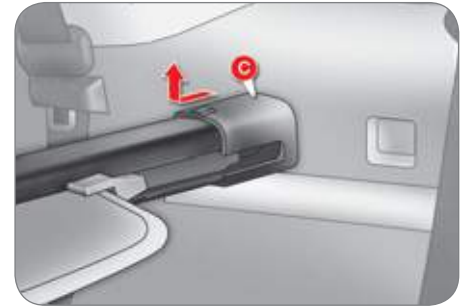

Removing the load space cover

1. Reel in the load space cover.
2. Move one of the slides **C** towards the inside of the vehicle and raise it.
Release the opposite slide in the same way.

To put the load space cover in place, carry out the operations in reverse order.



Take care not to place heavy objects on the load space cover when it is unfolded.

The load space cover can be stored along the lower tailgate, unless audio equipment is present.

ACCESS

REMOTE CONTROL KEY

System which permits central unlocking or locking of the vehicle using the lock or from a distance. It also folds and unfolds the mirrors, closes the electric windows and starts the vehicle, as well as providing protection against theft.



Unlocking the vehicle

Unfolding the key

☞ First press button **A** to unfold the key.

Unlocking using the remote control



☞ Press the open padlock to unlock the vehicle.

Unlocking is confirmed by the interior lighting which comes on for approximately 15 seconds and the direction indicators which flash **twice**.

If you press the open padlock **twice in succession** within 30 seconds after unlocking the vehicle, the door mirrors unfold.

Unlocking using the key

☞ Turn the key to the right in the **driver's door** lock to unlock the vehicle.

Locking the vehicle

Normal locking using the remote control



☞ Press the closed padlock to lock the vehicle.

Locking is confirmed by the direction indicators which come on **once**.

If you press the closed padlock **twice in succession** within 30 seconds after locking the vehicle, the door mirrors fold.

An extended press on the closed padlock within 30 seconds after locking the vehicle closes the windows automatically.

Normal locking using the key

☞ Turn the key to the left in the **driver's door** lock to lock the vehicle.

If one of the doors or the tailgate is still open, the central locking will not take place.



Folding the key

☞ First press button **A** to fold the key.

The vehicle will relock automatically after thirty seconds unless a door or the tailgate is opened. This function prevents inadvertent unlocking.

The duration which precedes the automatic relocking of the vehicle can be configured via the colour screen "Equipment" menu.

Anti-theft protection

Electronic engine immobiliser

The key contains an electronic chip which has a special code. When the ignition is switched on, this code must be recognised to permit starting.

This electronic engine immobiliser locks the engine management system a few moments after the ignition is switched off and prevents starting of the engine by anyone who does not have the key.

In the event of a malfunction and if your vehicle does not start, contact a CITROËN dealer as soon as possible.

ACCESS

Starting the vehicle



- ☞ Insert the key in the ignition switch.
- ☞ Operate the starter by turning the key to position **4 (START)**.
- ☞ When the engine turns over, release the key. The ignition switch is placed in position **3 (ON)** automatically.

Switching the vehicle off

- ☞ Park the vehicle.
- ☞ While pressing the key, turn it towards you to position **1 (LOCK)**.
- ☞ Remove the key from the ignition switch.

Key in ignition

A buzzer sounds on opening the driver's door, if the key has been left in the ignition.

Changing the battery



Battery reference: CR1616/3 volts.

- ☞ Unclip the casing using a coin at the notch.
- ☞ Slide the flat battery out of its housing.
- ☞ Slide the new battery into its housing observing the original direction.
- ☞ Clip the casing.



Keys

Make a careful note of the number of each key. This number is coded on the label attached to the key. If the keys are lost, a CITROËN dealer can supply you with new keys.

Remote control

The high frequency remote control is a sensitive system; do not operate it while it is in your pocket as there is a possibility that it may unlock the vehicle, without you being aware of it.

Do not repeatedly press the buttons of your remote control out of range and out of sight of your vehicle. You run the risk of stopping it from working.

The remote control does not operate when the key is in the ignition, even when the ignition is switched off.

Locking the vehicle

Driving with the doors locked may make access to the passenger compartment by the emergency services more difficult in an emergency.

As a safety precaution (with children on board), remove the key from the ignition when you leave the vehicle, even for a short time.

Anti-theft protection

Do not make any modifications to the electronic engine immobiliser system, this could cause malfunctions.

When purchasing a second-hand vehicle

Have the key codes memorised by a CITROËN dealer, to ensure that the keys in your possession are the only ones which can start the vehicle.



Do not throw the remote control batteries away, they contain metals which are harmful to the environment. Take them to an approved collection point.

ELECTRIC WINDOWS

System which opens or closes a window manually or automatically. It is fitted with a system which provides protection if an obstacle is detected on one-touch models and a deactivation system to prevent misuse of the rear controls.

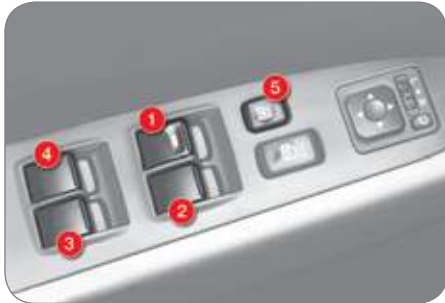

1. Driver's electric window switch.
2. Passenger's electric window switch.
3. Rear right electric window switch.
4. Rear left electric window switch.
5. Deactivating the passenger and rear electric window switches.

Operation

With the ignition on, you have two options:

- **manual mode**
 - ☞ Press the switch gently to open or pull it gently to close. The window stops as soon as the switch is released.
- **automatic mode**
 - ☞ Press the switch fully to open or pull it fully to close. The window opens or closes completely when the switch is released.
 - ☞ Pressing the switch again stops the movement of the window.

The electric window switches can be configured via the colour screen "Equipment" menu.

The electric window switches remain operational for approximately 30 seconds after the ignition is switched off and the switch on the driver's door remains operational for a further 30 seconds when the door is opened.

The windows can no longer be opened or closed after the driver's door is closed.

The rear windows do not lower fully.

Safety anti-pinch

In automatic mode, when the window rises and meets an obstacle, it stops and lowers again.

In the event of unwanted opening of the window on closing (for example in the presence of frost), reinitialise the electric windows (refer to the corresponding paragraph).



Deactivating the passenger and rear electric window switches



☞ For the safety of your children, press switch **5** to prevent operation of the passenger and rear electric windows irrespective of their position.

When the button is pressed down, the switches are deactivated.

When the button is raised, the switches are activated.

When the button is pressed down, you can open or close all of the windows using the switches on the driver's door.

Reinitialising the electric windows

Following reconnection of the battery or after the safety anti-pinch has been triggered three times in succession, you must reinitialise the safety anti-pinch function:

- ☞ with the door closed, lower the window completely then raise it again, it will rise in steps of a few centimetres each time the switch is pressed, repeat the operation until the window is fully closed,
- ☞ continue to press the switch for at least one second after reaching the window closed position.

The safety anti-pinch function is not active during these operations.



Always remove the key from the ignition when leaving the vehicle, even for a short time.

In the event of contact during operation of the windows, you must reverse the movement of the window. To do this, press the switch concerned.

When the driver operates the passenger electric window switches, they must ensure that no one is preventing correct closing of the windows.

The driver must ensure that passengers use the electric windows correctly.

Be aware of children when operating the windows.

ACCESS

DOORS

Opening

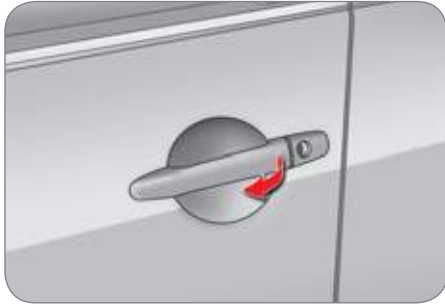

From outside

- ☞ After unlocking the vehicle using the remote control or the key, pull the door handle.

From inside



- ☞ Pull the front or rear door control to open the door.

The front passenger door or the rear doors must first be unlocked manually using the locking control before being opened.

If the doors are locked, opening the driver's door does not unlock the other doors.

Closing



If a door is not closed correctly, this warning lamp comes on in the instrument panel screen until the door concerned is closed.

Manual centralised control

System which provides full manual locking or unlocking of the doors and tailgate from the inside.



Locking

- ☞ Press the front of button **A** to lock the vehicle.

If the driver's door is open when you operate the central locking from inside, all of the doors lock with the exception of the driver's door.

Unlocking

- ☞ Press the rear of button **A** to unlock the vehicle.

ACCESS

Emergency control

System which locks or unlocks mechanically the driver's door only in the event of a malfunction of the central locking.

Using the key

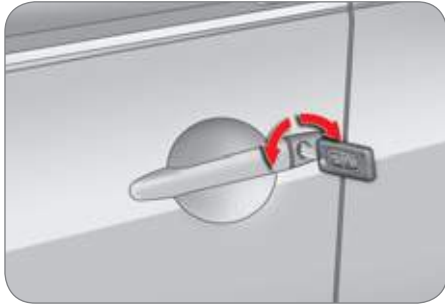

Locking the driver's door

☞ Insert the key in the lock, then turn it to the left.

The other doors are not unlocked.

Unlocking the driver's door

☞ Insert the key in the lock, then turn it to the right.

Locking the front passenger door and the rear doors (from inside)

☞ Tilt the interior control **B** forwards.



Unlocking the front and rear doors (from inside)

☞ Tilt the interior control **B** rearwards.

TAILGATE

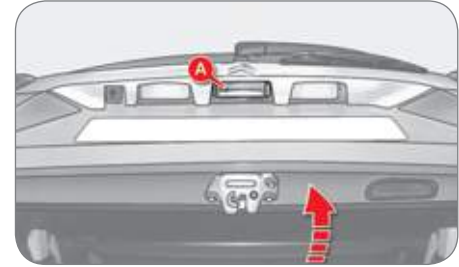

Opening

☞ After unlocking the vehicle using the remote control or the key, press the handle **A** and raise the tailgate.

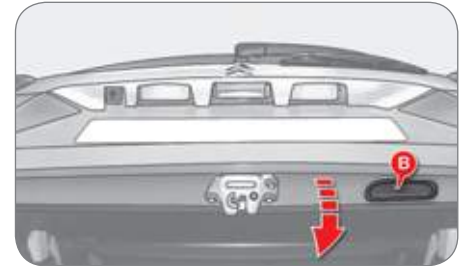

Closing

☞ Pull the handle **B** downwards to guide the tailgate,
☞ release the handle and press the exterior surface of the tailgate gently to close it.

ACCESS

LOWER TAILGATE

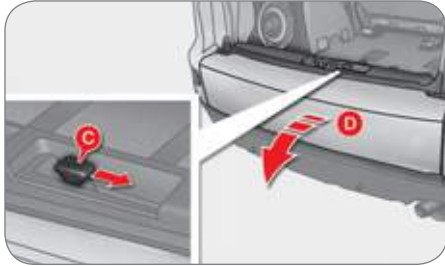

Opening

- Push the handle **C** to the right and tilt the tailgate **D** gently.



Closing

- Raise the tailgate **D**, push it to close it, then check that it is secured correctly.

"Tailgate open" warning



This warning lamp comes on on the instrument panel screen when the tailgate is not closed correctly.

Before opening the tailgate, ensure that no one is within the radius of opening.

For reasons of safety and correct operation, do not drive with the tailgate open.

If the battery is disconnected, the tailgate cannot be opened.

Do not climb onto the lower tailgate and do not subject it to heavy knocks, it may be damaged.

Always close the lower tailgate and check that it is secured correctly before closing the main tailgate.

When closing the lower tailgate, ensure that no person or object is in the proximity of the moving parts to avoid any risk of injury or damage.

Do not open the lower tailgate when a towbar is fitted.

Maximum authorised weight on the lower tailgate when open: **200 kg**.

Tailgate release

This enables the tailgate to be unlocked in the event of a central locking fault.



- Fold back the rear seats to gain access to the tailgate release inside the boot.
- Remove the plastic cap from the opening **A** in the tailgate interior pillar.



- Move the control **B** to the right to unlock and open the tailgate.

SUNROOF

Operation



Complete opening

☞ With the ignition on, push the control rearwards (in the direction 1).

A deflector is deployed gradually on opening to prevent unwanted gusts of air.

The sunroof stops automatically just before complete opening. Push the control again for complete opening.

Complete closing

☞ With the ignition on, push the control forwards (in the direction 2).

The deflector folds down gradually on closing.

Temporary stop

☞ To stop opening or closing, press part 3 of the control or push the control in the opposite direction.

Partial opening

☞ **To open**, with the ignition on, press part 3 of the control.

The rear part of the sunroof opens.

☞ **To close**, with the ignition on, press part 3 of the control.

The rear part of the sunroof closes.

Safety anti-pinch and reinitialisation

If the roof meets an obstacle while it is closing, it stops and opens again.

In the event of unwanted opening of the roof on closing (for example, in the presence of ice) and immediately after the roof has stopped, or after the safety anti-pinch has been triggered five times in succession:

- ☞ press part 3 of the control several times to partially open the roof,
- ☞ when the roof partially opens, continue to press for **more than 3 seconds**,
- ☞ open and close the sunroof completely.

The safety anti-pinch function is not operational during these operations.

ACCESS

! Always remove the key from the ignition when leaving the vehicle, even for a short time.

If the roof meets an obstacle during operation, you must reverse the movement of the roof. To do this, press the control concerned.

When the driver operates the roof control, they must ensure that no one is preventing the roof from closing correctly.

The driver must ensure that passengers use the sunroof correctly.

Be aware of children when operating the roof.

BLIND



The blind is manual, slide it backwards and forwards.

It opens automatically when the roof is opened.

! Check that the sunroof is not open **in tilt mode** before closing the blind.

The blind cannot be closed when the sunroof is open in **sliding mode**.



FUEL TANK

Capacity of the tank: approximately 60 litres.

Low fuel level



When the low fuel level is reached, this indication appears on the instrument panel screen. When it first comes on, you have approximately 10 litres of fuel remaining.

The symbol **flashes slowly** (approximately once per second).



When the symbol begins to **flash rapidly** (approximately twice per second), there is not much fuel remaining in your tank (approximately 5 litres).

You must fill the tank to avoid running out of fuel.

Filling

A label, affixed on the inside of the flap, reminds you of the type of fuel to be used according to your engine.

More than 5 litres of fuel must be added in order to be registered by the fuel gauge.

Location of the cap



This symbol indicates that the fuel tank cap is located on the left-hand side of the vehicle.

Opening the cap may cause an inrush of air. This vacuum, which is completely normal, is caused by the sealing of the fuel system.

To fill the tank safely:

- ☞ **the engine must be switched off,**
- ☞ pull the control **A** located at the bottom left of the driver's seat to release the fuel filler flap,
- ☞ open the fuel filler flap **B**,
- ☞ turn the filler cap **C** to the left,
- ☞ remove the filler cap **C**,
- ☞ fill the tank, but **do not continue after the 3rd cut-off of the nozzle;** this could cause malfunctions.

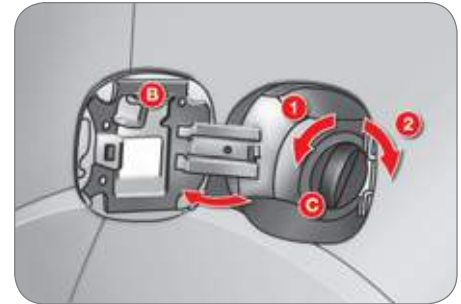
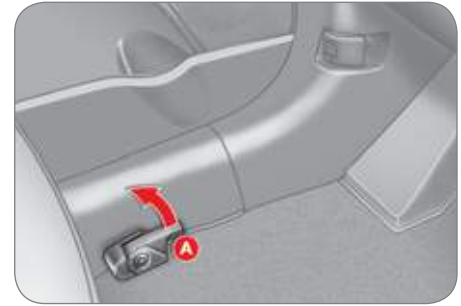

When you have filled the tank:

- ☞ refit the filler cap, inserting the upper part first,
- ☞ screw in the filler cap to the right,
- ☞ close the flap.

1. Opening.
2. Closing.

Ensure that the fuel filler flap is closed correctly.

Quality of the fuel used for petrol engines

The petrol engines are perfectly compatible with E10 or E24 type petrol biofuels (containing 10 % or 24 % ethanol), conforming to European standards EN 228 and EN 15376.

E85 type fuels (containing up to 85 % ethanol) are reserved exclusively for vehicles marketed for the use of this type of fuel (BioFlex vehicles). The quality of the ethanol must comply with European standard EN 15293.

For Brazil only, special vehicles are marketed to run on fuels containing up to 100 % ethanol (E100 type).

Quality of the fuel used for Diesel engines

The Diesel engines are perfectly compatible with biofuels which conform to current and future European standards (Diesel fuel which complies with standard EN 590 mixed with a biofuel which complies with standard EN 14214) available at the pumps (containing up to 7 % Fatty Acid Methyl Ester).

The B30 biofuel can be used in certain Diesel engines; however, this use is subject to strict application of the special servicing conditions. Contact a CITROËN dealer or a qualified workshop.

The use of any other type of (bio)fuel (vegetable or animal oils, pure or diluted, domestic fuel...) is strictly prohibited (risk of damage to the engine and fuel system).



VISIBILITY

LIGHTING STALK

Main lighting

The various front and rear lamps of the vehicle are designed to adapt the driver's visibility progressively in relation to the climatic conditions:

- sidelamps, to be seen,
- dipped beam headlamps to see without dazzling other drivers,
- main beam headlamps to see clearly when the road is clear.

IV

Additional lighting

Other lamps are installed to fulfil the requirements of particular driving conditions:

- rear foglamps to be seen from a distance,
- front foglamps for even better visibility,
- daytime running lamps to be seen during the day.

Certain functions of the lighting stalk (automatic illumination of headlamps, sensitivity) can be configured via the colour screen "Equipment" menu.

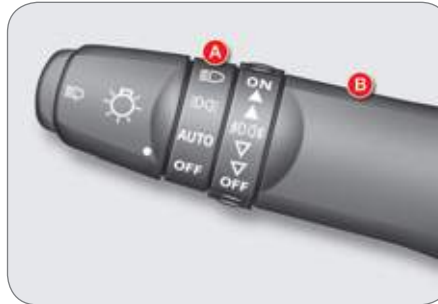

Manual controls

The lighting is controlled directly by the driver by means of the ring **A** and the stalk **B**.

- A.** Main lighting mode selection ring: turn it to position the symbol required facing the mark.



Lamps off.



Automatic illumination of headlamps.



Sidelamps.



Dipped headlamps or main beam headlamps.

- B.** Stalk for switching headlamps: pull the stalk towards you to switch the lighting between dipped and main beam headlamps.

In the lamps off and sidelamps modes, the driver can switch on the main beam headlamps temporarily ("headlamp flash") by maintaining a pull on the stalk.

Displays

Illumination of the corresponding indicator lamp in the instrument panel confirms that the lighting selected is on.

VISIBILITY

Front and rear foglamps



C. foglamps selection ring.

The foglamps operate with the dipped and main beam headlamps.

If condensation is present, switch the headlamps on for a few minutes in order to clear it.



front and rear foglamps

- ☞ To switch on the front foglamps, turn the ring **C** forwards once.
- ☞ To switch on the rear foglamps, turn the ring **C** forwards twice.
- ☞ To switch off the rear foglamps, turn the ring **C** rearwards once.
- ☞ To switch off the front foglamps, turn the ring **C** rearwards twice.

The ring **C** returns to its initial position automatically.

The front foglamps are switched on automatically when you switch on the rear foglamps.

The rear foglamps are switched off automatically when you switch off the dipped/main beam headlamps or the front foglamps.

On vehicles fitted with daytime running lamps, the rear foglamps can be switched on even if the lighting stalk is in the "OFF" position.

! In good or rainy weather, both day and night, the front foglamps and the rear foglamps are prohibited. In these situations, the power of their beams may dazzle other drivers.

Do not forget to switch off the front foglamps and the rear foglamps when they are no longer necessary.

IV

Lighting on reminder

An audible signal when the driver's door is opened warns the driver if the vehicle lighting is on, with the ignition off.

Switching off the lighting stops the audible signal.

VISIBILITY

Daytime running lamps*

On vehicles which are equipped with daytime running lamps, the dipped beam headlamps come on when the vehicle is started.



This warning lamp comes on in the instrument panel.

IV

The instruments and controls (instrument panel, multifunction screen, air conditioning control panel, ...) are illuminated.

Automatic illumination of headlamps

The sidelamps and the dipped beam headlamps come on automatically, without any action on the part of the driver, if a low level of exterior light is detected or if the wipers are switched on.

When the light returns to a sufficient level or the wipers are switched off, the lighting is switched off automatically.

The sensor is located at the base of the windscreen.

Contact a CITROËN dealer or a qualified workshop to adjust the sensitivity of the sensor.

Automatic switching off

When the lights stalk is at "dipped headlamps or main beam headlamps", if the ignition switch is at "LOCK" or "ACC" or if the key has been removed from the ignition switch, the lights switch off automatically **when the driver's door is opened**.



In foggy weather or in snow, the sunshine sensor may detect sufficient light. The lighting will not come on automatically.

Do not cover the sunshine sensor, the associated functions will no longer be controlled.

The sensitivity of the automatic illumination of headlamps can be configured via the colour screen "Equipment" menu.

* According to country.

VISIBILITY

MANUAL HEADLAMP ADJUSTMENT



To avoid dazzling other road users, the height of the headlamps must be adjusted in relation to the load in the vehicle.

5-seat version

0. Driver only or Driver + 1 passenger in the front.
- 1 or 2. 5 occupants (including the driver).
3. 5 occupants (including the driver) + maximum authorised load.
4. Driver + maximum authorised load.

7-seat version

0. Driver only or Driver + 1 passenger in the front.
- 1 or 2. Driver + 1 passenger in the front + 2 passengers on the third bench seat.
3. 7 occupants (including the driver with or without maximum authorised load).
4. Driver + maximum authorised load.

AUTOMATIC HEADLAMP ADJUSTMENT



On vehicles with xenon bulbs: **when stationary**, the system automatically corrects the height of the beam, whatever the load of the vehicle. The driver is then assured of having optimum lighting and not causing a nuisance to other road users.



In cases of malfunction, this message appears in the multifunction screen.

Do not touch the xenon bulbs. Contact a CITROËN dealer or a qualified workshop.

IV

VISIBILITY

WIPER CONTROLS

Programming

An automatic control mode is also available, the automatic rain sensitive windscreen wipers.

Model with intermittent wiping

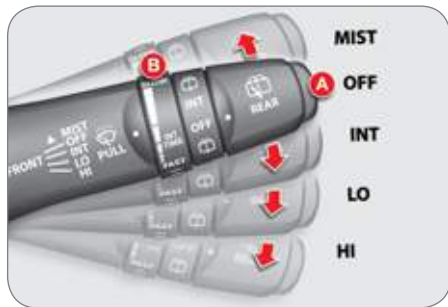

Model with AUTO wiping



Manual controls

The wiper commands are issued directly by the driver by means of the stalk **A** and the ring **B**.

Windscreen wipers

A. wiping speed selection stalk:



single wipe.



park.



intermittent (the speed can be set manually),

or



automatic rain sensitive wipers (the speed can be set manually).



slow.



fast.

B. intermittent operation or rain sensor sensitivity adjustment ring.

You can increase or decrease:

- the wiping frequency when the intermittent mode is active,
- the sensitivity of the rain sensor when the automatic mode is active.
 - "+": high sensitivity.
 - "-": low sensitivity.

Certain windscreen wiper functions (intermittent operation, ...) can be configured via the colour screen "Equipment" menu.

Windscreen wash

Pull the wiper stalk towards you. The windscreen wash then the wipers operate for a set time.

The headlamp wash is also activated if the dipped beam headlamps are on.

Headlamp wash



Press the end of the lighting stalk to activate the headlamp wash, when the dipped beam headlamps are on.

VISIBILITY

Automatic rain sensitive wipers

The windscreen wipers operate automatically, without any action on the part of the driver, if rain is detected (sensor behind the rear view mirror), adapting their speed to the intensity of the rainfall.



Activation

☞ Move the stalk **A** to the "**AUTO**" position.

A message appears on the multifunction screen.



Deactivation

☞ Move the stalk **A** to the "**OFF**" position.

A message appears on the multifunction screen.

Operating fault

Do not cover the rain sensor, linked with the sunshine sensor and located in the centre of the windscreen behind the rear view mirror.



Switch off the automatic rain sensitive wipers when using an automatic car wash.

To protect the rubber of the wiper, it is advisable to deactivate the automatic mode when the vehicle is parked and when the ambient temperature is below 0 °C.

In winter, it is advisable to wait until the windscreen is completely clear of ice before activating the automatic rain sensitive wipers.

Rear wiper



IV

B. rear wiper selection ring:



park.



intermittent wipe.

The wiper wipes twice then switches to intermittent mode with an interval of a few seconds.



wipe with screen wash.

Keep the ring in this position to operate the screen wash with several wipes of the wiper.

The intermittence of the rear wiper can be configured via the colour screen "Equipment" menu.

VISIBILITY

COURTESY LAMPS



IV

Front courtesy lamp

Position 1

The courtesy lamp comes on when a door or the tailgate is opened.

When the door or the tailgate is closed again, the lighting gradually dims for a few seconds before switching off.

However, the courtesy lamp is switched off automatically in the following cases:

- When the doors and the tailgate are closed and the ignition switch is placed in the "ON" position.
- When the doors and the tailgate are closed and you lock the vehicle from inside or using the remote control.

Position 2

The courtesy lamp is off, regardless of whether the doors or tailgate are open or closed.

The durations of lighting of the front courtesy lamps can be configured via the colour screen "Equipment" menu.



Map reading lamps

There are two map reading lamps, one on each side of the courtesy lamp. Press the corresponding lamp lens **A**.

VISIBILITY

Rear courtesy lamp



Position 1 "ON"

The courtesy lamp is permanently on.

Position 2 "●"

The courtesy lamp comes on when a door or the tailgate is opened. When the door or the tailgate is closed again, the lighting gradually dims for a few seconds before switching off.

However, the courtesy lamp is switched off immediately in the following cases:

- When the doors and the tailgate are closed and the ignition switch is placed in the "ON" position.

- When the doors and the tailgate are closed and you lock the vehicle from inside or using the remote control.

Position 3 "OFF"

The courtesy lamp is permanently off.

Boot lamp



Position 1 "ON"

The boot lamp is on, regardless of whether the tailgate is open or closed.

Position 2 "●"

The boot lamp comes on if the tailgate is opened and switches off when the tailgate is closed.

Position 3 "OFF"

The boot lamp is off, regardless of whether the tailgate is open or closed.

Courtesy lamps automatic switch off

To prevent discharging of the battery, the courtesy lamps, map reading lamps and boot lamp switch off automatically after 30 minutes.

The courtesy lamps are switched on again if the ignition switch is placed in the "ON" or "ACC" position, if you open then close a door or the tailgate or if you use the remote control.

The duration of lighting of the rear courtesy lamps can be configured via the colour screen "Equipment" menu.

IV

CHILD SAFETY

GENERAL POINTS RELATING TO CHILD SEATS

Although one of CITROËN's main criteria when designing your vehicle, the safety of your children also depends on you.

For maximum safety, please observe the following recommendations:

- in accordance with European regulations, **all children under the age of 12 or less than one and a half metres tall must travel in approved child seats suited to their weight**, on seats fitted with a seat belt or ISOFIX mountings*,
- **statistically, the safest seats in your vehicle for carrying children are the rear seats**,
- **a child weighing less than 9 kg must travel in the "rearwards-facing" position both in the front and in the rear.**

CITROËN recommends that children should travel in the **rear seats** of your vehicle:

- **"rearwards-facing"** up to the age of 2,
- **"forwards-facing"** over the age of 2.

CHILD SEAT IN THE FRONT

"Rearwards-facing"



When a "rearwards-facing" child seat is installed on the **front passenger seat**, it is essential that the passenger airbag is deactivated. Otherwise, **the child would risk being seriously injured or killed if the airbag were to inflate.**

"Forwards-facing"



When a "forwards-facing" child seat is installed on the **front passenger seat**, adjust the vehicle's seat to the intermediate longitudinal position with the seat back upright and leave the passenger airbag activated.



Intermediate longitudinal position

* The rules for carrying children are specific to each country. Refer to the current legislation in your country.

<https://www.automotive-manuals.net/>

CHILD SAFETY

CHILD SEATS RECOMMENDED BY CITROËN

CITROËN offers a complete range of recommended child seats which are secured using a **three point seat belt**:

Group 0+: from birth to 13 kg



L1

"RÖMER Baby-Safe Plus"
Installed in the rearwards-facing position.

Groups 2 and 3: from 15 to 36 kg



L3

"RECARO Start"



L4

"KLIPPAN Optima"
From the age of 6 years (approximately 22 kg), the booster is used on its own.



L5

"RÖMER KIDFIX"
Can be fitted to the vehicle's ISOFIX mountings.
The child is restrained by the seat belt.

V

CHILD SAFETY



Passenger airbag OFF

Refer to the advice given on the label present on both sides of the passenger's sun visor.

V

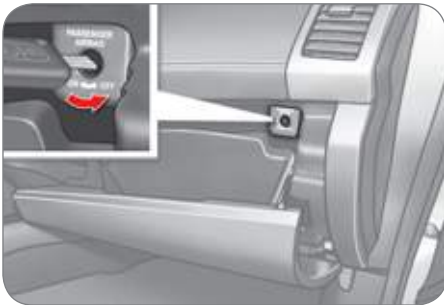

To assure the safety of your child, you must deactivate the passenger's front airbag when you install a child seat in the rearwards facing position on the front passenger's seat. Otherwise, there is a risk that the child could be seriously injured or killed if the airbag were deployed.

<https://www.automotive-manuals.net/>

CHILD SAFETY

LOCATIONS FOR CHILD SEATS SECURED USING THE SEAT BELT

In accordance with European regulations, this table indicates the options for installing child seats secured using a seat belt and universally approved (a) in relation to the weight of the child and the seat in the vehicle.

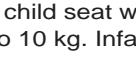
Seat		Weight of the child and indicative age			
		Less than 13 kg (groups 0 (b) and 0+) Up to ≈ 1 year	From 9 to 18 kg (group 1) From 1 to ≈ 3 years	From 15 to 25 kg (group 2) From 3 to ≈ 6 years	From 22 to 36 kg (group 3) From 6 to ≈ 10 years
Front passenger seat (c) with passenger airbag activated		X	X	L3, L4**, L5***	L3, L4**, L5***
Front passenger seat (c) with passenger airbag deactivated		L1	X	L3, L4**, L5***	L3, L4**, L5***
Outer rear seats (row 2)		L1	X	U*	U*
Centre rear seat (row 2)		L1	X	L4*, L5*	L4*, L5*

(a) Universal child seat: child seat which can be installed in all vehicles using the seat belt.

(b) Group 0: from birth to 10 kg. Infant car seats and "car cots" cannot be installed on the front passenger seat.

(c) Consult the legislation in force in your country before installing your child on this seat.

U: seat suitable for the installation of a child seat secured using the seat belt and universally approved, "rear facing" and/or "forward facing".

X: seat not suitable for the installation of a child seat of the weight group indicated.

L-: only the child seats indicated can be installed on the seat concerned (according to country).

* Remove the rear head restraint before fitting a child seat at this position.

** Place the head restraint in the fully up position before fitting a child seat at this position.

*** Remove the front head restraint before fitting a child seat at this position.

<https://www.automotive-manuals.net/>

V

CHILD SAFETY

"ISOFIX" mountings

Your vehicle has been approved in accordance with the **new ISOFIX regulation**. The seats, represented below, are fitted with regulation ISOFIX mountings:



These are three rings for each seat:



- two rings **A**, located between the vehicle seat back and cushion, indicated by a label,



- a ring **B**, used to fix the upper strap, referred to as the **TOP TETHER**, indicated by a label.

This ISOFIX mounting system provides fast, reliable and safe fitting of the child seat in your vehicle.

The **ISOFIX child seats** are fitted with two latches which are secured easily on the two rings **A**.

Some also have an **upper strap** which is attached to the ring **B**.

To attach this strap, remove the vehicle seat's head restraint. Then fix the hook on the ring **B** and tighten the upper strap.

! The incorrect installation of a child seat in a vehicle compromises the child's protection in the event of an accident.

For information regarding the ISOFIX child seats which can be installed in your vehicle, refer to the table showing the locations for ISOFIX child seats.

CHILD SAFETY

ISOFIX CHILD SEAT RECOMMENDED BY CITROËN AND APPROVED FOR YOUR VEHICLE

ISOFIX RÖMER Duo Plus (size category B1)

Group 1: from 9 to 18 kg



Installed in the forward facing position.

Fitted with an upper strap to be secured on the ISOFIX upper ring, referred to as the TOP TETHER.

Three seat body angles: sitting, reclining, lying.

Before fitting this child seat to the outer rear seats of your vehicle, you should:

- incline the front seat backrest as far back as possible or,
- place the rear head restraint in the fully up position.

This child seat can also be used on seats which are not fitted with ISOFIX mountings.

In this case, it must be attached to the vehicle seat using the three point seat belt.

Follow the instructions for fitting the child seat given in the seat manufacturer's installation guide.

<https://www.automotive-manuals.net/>

CHILD SAFETY

LOCATIONS FOR ISOFIX CHILD SEATS

In accordance with European Regulations (ECE 16), this table indicates the options for installing ISOFIX child seats on seats in the vehicle fitted with ISOFIX mountings.

In the case of universal and semi-universal ISOFIX child seats, the ISOFIX size category, determined by a letter from **A** to **G**, is indicated on the child seat next to the ISOFIX logo.

	Weight of the child / indicative age									
	Less than 10 kg (group 0) Up to approx. 6 months		Less than 10 kg (group 0) Less than 13 kg (group 0+) Up to approx. 1 year			From 9 to 18 kg (group 1) From approx. 1 to 3 years				
Type of ISOFIX child seat	infant car seat		"rear facing"			"rear facing"		"forward facing"		
ISOFIX size category	F	G	C	D	E	C	D	A	B	B1
Universal and semi-universal ISOFIX child seats which can be installed on the outer rear seats	X		IL-SU			IL-SU		IUF IL-SU		

IUF: seat suitable for the installation of an Isofix **U**niversal seat, "**F**orward facing" secured using the "**T**op Tether" upper strap.

IL-SU: seat suitable for the installation of an Isofix **S**emi-**U**niversal seat either:

- "rear facing" fitted with a "Top Tether" upper strap or a support,
- "forward facing" fitted with a support.

For advice on securing of the "Top Tether" upper strap, refer to the "ISOFIX mountings" section.

X: seat not suitable for the installation of an ISOFIX seat of the size category indicated.

The head restraint of the vehicle's ISOFIX seat must be removed and stored.

<https://www.automotive-manuals.net/>



ADVICE ON CHILD SEATS

The incorrect installation of a child seat in a vehicle compromises the child's protection in the event of an accident.

Remember to fasten the seat belts or the child seat harnesses **keeping the slack** in relation to the child's body **to a minimum**, even for short journeys.

For optimum installation of the "forward facing" child seat, ensure that the back of the child seat is in contact with the back of the vehicle's seat and that the head restraint does not cause any discomfort.

If the head restraint has to be removed, ensure that it is stored or attached securely to prevent it from being thrown around the vehicle in the event of sharp braking.

Children under the age of 10 must not travel in the "forward facing" position on the front passenger seat, unless the rear seats are already occupied by other children, cannot be used or are absent.

Deactivate the passenger's airbag when a "rear facing" child seat is installed on the front seat. Otherwise, the child would risk being seriously injured or killed if the airbag were to inflate.

Installing a booster seat

The chest part of the seat belt must be positioned on the child's shoulder without touching the neck.

Ensure that the lap part of the seat belt passes correctly over the child's thighs.

CITROËN recommends the use of a booster seat which has a back, fitted with a seat belt guide at shoulder level.

As a safety precaution, do not leave:

- one or more children alone and unsupervised in a vehicle,
- a child or an animal in a vehicle which is exposed to the sun, with the windows closed,
- the keys within reach of children inside the vehicle.

To prevent accidental opening of the doors, use the "Child lock".

Take care not to open the rear windows by more than one third.

To protect young children from the rays of the sun, fit side blinds on the rear windows.

CHILD LOCK

Mechanical system to prevent opening of the rear doors using their interior controls.

The control is located on the edge of each rear door.

Child lock on



☞ Lower the control **A** to position **1**.

Child lock off

☞ Raise the control **A** to position **2**.

SAFETY

DIRECTION INDICATORS



- ☞ Left: lower the lighting stalk passing the point of resistance.
- ☞ Right: raise the lighting stalk passing the point of resistance.

VI

The audible signal can be configured via the colour screen "Equipment" menu.

"Motorway" function

- ☞ Press briefly upwards or downwards, without going beyond the point of resistance; the direction indicators will flash 3 times.

HAZARD WARNING LAMPS

A visual warning by means of the direction indicators to alert other road users to a vehicle breakdown, towing or accident.



- ☞ Press this button, the direction indicators flash. They can operate with the ignition off.

Automatic operation of hazard warning lamps

When braking in an emergency, depending on the deceleration, the hazard warning lamps come on automatically. They switch off automatically the first time you accelerate.

- ☞ You can also switch them off by pressing the button.

HORN

Audible warning to alert other road users to an imminent danger.

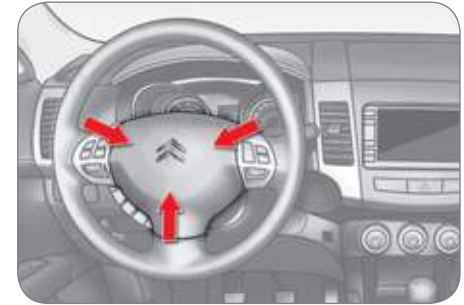

- ☞ Press one of the spokes of the steering wheel.

SAFETY

BRAKING ASSISTANCE SYSTEMS

Group of supplementary systems which help you to obtain optimum braking in complete safety in emergency situations:

- anti-lock braking system (ABS),
- electronic brake force distribution (EBFD).

Anti-lock braking system and electronic brake force distribution

Linked systems which improve the stability and manoeuvrability of your vehicle when braking, in particular on poor or slippery surfaces.

Activation

The anti-lock braking system is active if the vehicle speed is higher than 6 mph (10 km/h). It is deactivated when the vehicle speed falls below 3 mph (5 km/h). The anti-lock braking system comes into operation automatically when there is a risk of wheel lock.

Normal operation of the ABS may make itself felt by slight vibration of the brake pedal.



When braking in an emergency, press very firmly without releasing the pressure.

Operating fault

When the vehicle is stationary



If this warning lamp comes on, accompanied by the indication on the instrument panel screen, it indicates a malfunction of the anti-lock braking system which could result in a loss of control of the vehicle when braking.

Contact a CITROËN dealer or a qualified workshop.

The warning lamp comes on for a few seconds when the ignition is switched on (ON position). If it does not switch off or does not come on, contact a CITROËN dealer or a qualified workshop.

When the vehicle is moving



If this warning lamp comes on continuously it indicates a malfunction of the anti-lock braking system which could result in a loss of control of the vehicle on braking.

You MUST stop as soon as it is safe to do so.

Contact a CITROËN dealer or a qualified workshop.



If these two warning lamps come on, linked with the warnings on the instrument panel screen, they indicate a malfunction of the electronic brake force distribution which could result in a loss of control of the vehicle on braking.

You MUST stop as soon as it is safe to do so.

Contact a CITROËN dealer or a qualified workshop.

The two warning lamps comes on at the same time and the two warnings are displayed alternately in the instrument panel screen.

When replacing wheels (tyres and rims), ensure that they conform to the manufacturer's recommendations.

VI

SAFETY

TRAJECTORY CONTROL SYSTEMS

Associated systems which guarantee the directional stability of the vehicle within the limits of the laws of physics:

- traction control (TCL),
- automatic stability control (ASC).

Traction control and automatic stability control

Traction control optimises traction to prevent wheel spin, by acting on the brakes of the driving wheels and on the engine.

Automatic stability control acts on the brake of one or more wheels and on the engine to keep the vehicle on the trajectory required by the driver.

Activation

These systems are activated automatically each time the vehicle is started.

They operate when the vehicle speed is higher than 10 mph (15 km/h).



They come into operation in the event of a grip or trajectory problem.

This is indicated by flashing of this symbol on the instrument panel screen.

Deactivation

In exceptional conditions (starting a vehicle which is bogged down, stuck in snow, on soft ground, ...), it may be advisable to deactivate the ASC system, so that the wheels can move freely and regain grip.



Press the "ASC OFF" button, located to the left of the steering wheel, until the ASC OFF symbol appears on the instrument panel screen.



The display of this symbol in the top right corner of the instrument panel screen indicates that the ASC and TCL systems are deactivated.

Reactivation

These systems are not reactivated automatically above 30 mph (50 km/h).

Press the "ASC OFF" button again to reactivate them manually.

Switching off of the symbol in the top right corner of the instrument panel screen indicates the reactivation of the ASC and TCL systems.

Operating fault



The displaying of this message on the instrument panel screen indicates a malfunction of these systems.

Contact a CITROËN dealer or a qualified workshop to have the ASC/TCL systems checked.



The ASC/TCL systems offer exceptional safety in normal driving, but this should not encourage the driver to take extra risks or drive at high speed.

The correct functioning of these systems depends on observation of the manufacturer's recommendations on:

- wheels (tyres and rims),
- braking components,
- electronic components,
- assembly and repair procedures.

After an impact, have these systems checked by a CITROËN dealer or a qualified workshop.

SAFETY

SEAT BELTS

Front seat belts

The front seat belts are fitted with a pretensioning and force limiting system.

This system improves safety in the front seats in the event of a front or side impact. Depending on the severity of the impact, the pretensioning system instantly tightens the seat belts against the body of the occupants.

The pretensioning seat belts are active when the ignition is on.

The force limiter reduces the pressure of the seat belt on the chest of the occupant, so improving their protection.

Fastening



- ☞ Pull the strap, then insert the tongue in the buckle **A**.
- ☞ Check that the seat belt is fastened correctly by pulling the strap.

Unfastening

- ☞ Press the red button on the buckle **A**.

Height adjustment

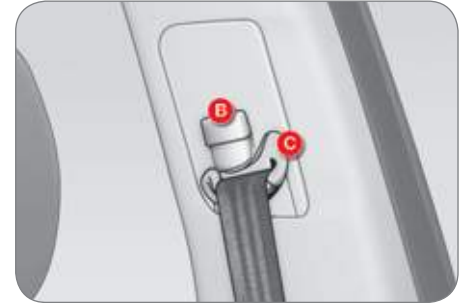

- ☞ to lower the attachment point, press the control **B** and slide the fixing **C** down,
- ☞ to raise the attachment point, press the control **B** and slide the fixing **C** up.

VI

SAFETY

Front seat belt not fastened/ unfastened warning lamp

Driver's seat belt



When the ignition is switched on, this warning lamp comes on accompanied by an audible signal for a few seconds if the driver has not fastened their seat belt.



VI

If the driver does not fasten their seat belt within one minute after switching on the ignition, the warning lamp flashes accompanied by an intermittent audible signal and a display on the instrument panel screen.

The warning lamp, the audible signal and the display stop after approximately 90 seconds and return until the driver fastens their seat belt.

If the seat belt is unfastened **while the vehicle is moving**, you are alerted by the same warnings.

Front passenger's seat belt



When the ignition is switched on, this warning lamp comes on the centre console panel.

It is accompanied by an audible signal for a few seconds if the passenger has not fastened their seat belt.

If the seat belt is unfastened **while the vehicle is moving**, you are alerted by the same warnings.

Rear seat belts

Each rear seat is fitted with a three-point inertia reel seat belt with force limiter.

Fastening

- ☞ Pull the strap, then insert the tongue in the buckle.
- ☞ Check that the seat belt is fastened correctly by pulling the strap.

Unfastening

- ☞ Press the red button on the buckle.

Storing after use

Outer rear seat belts

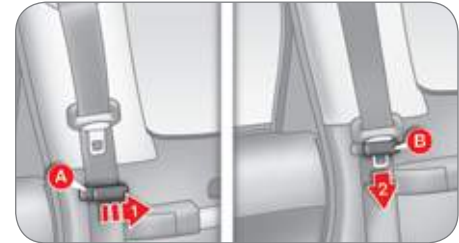

1. Pass the seat belt under the support **A** located on each rear side pillar,
2. Insert the tongue in the slot **B** of the support.

Rear buckles

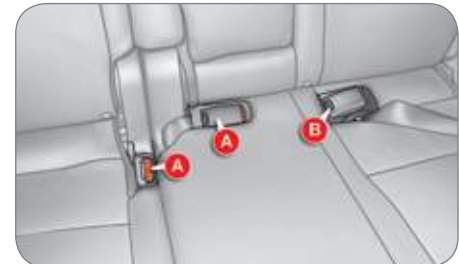

- ☞ Store the buckles in the locations **A** and **B** provided for this purpose in the rear seat cushion.

SAFETY



The driver must ensure that passengers use the seat belts correctly and that they are all restrained securely before setting off.

Wherever you are seated in the vehicle, always fasten your seat belt, even for short journeys.

Do not interchange the seat belt buckles as they will not fulfil their role fully.

The seat belts are fitted with an inertia reel permitting automatic adjustment of the length of the strap to your size. The seat belt is stowed automatically when not in use.

Before and after use, ensure that the seat belt is reeled in correctly.

The lower part of the strap must be positioned as low as possible on the pelvis.

The upper part must be positioned in the hollow of the shoulder.

The inertia reels are fitted with an automatic locking device which comes into operation in the event of a collision, emergency braking or if the vehicle rolls over. You can release the device by pulling firmly on the strap and releasing it so that it reels in slightly.

In order to be effective, a seat belt must:

- be tightened as close to the body as possible,
- be pulled in front of you with a smooth movement, checking that it does not twist,
- be used to restrain only one person,
- not bear any trace of cuts or fraying,
- not be converted or modified to avoid affecting its performance.

In accordance with current safety regulations, for all repairs on your vehicle, go to a qualified workshop with the skills and equipment needed, which a CITROËN dealer is able to provide.

Have your seat belts checked regularly by a CITROËN dealer or a qualified workshop, particularly if the straps show signs of damage.

Clean the seat belt straps with soapy water or a textile cleaning product, sold by CITROËN dealers.

After folding or moving a seat or rear bench seat, ensure that the seat belt is positioned and reeled in correctly.

Recommendations for children

Use a suitable child seat if the passenger is less than 12 years old or shorter than one and a half metres.

Never use the same seat belt to secure more than one person.

Never allow a child to travel on your lap.

In the event of an impact

Depending on the nature and seriousness of the impact, the pretensioning device may be deployed before and independently of the airbags. Deployment of the pretensioners is accompanied by a slight discharge of harmless smoke and a noise, due to the activation of the pyrotechnic cartridge incorporated in the system.

In all cases, the airbag warning lamp comes on.

Following an impact, have the seat belts system checked, and if necessary replaced, by a CITROËN dealer or a qualified workshop.

AIRBAGS

System designed to maximise the safety of the occupants (with the exception of the rear centre passenger) in the event of violent collisions. It supplements the action of the force-limiting seat belts.

If a collision occurs, the electronic detectors record and analyse the front and side impacts sustained in the impact detection zones:

- in the case of a serious impact, the airbags are deployed instantly and protect the occupants of the vehicle (with the exception of the rear centre passenger); immediately after the impact, the airbags deflate rapidly so that they do not hinder visibility or the exit of the occupants,
- in the case of a minor or rear impact or in certain roll-over conditions, the airbags will not be deployed; the seat belt alone is sufficient to provide optimum protection in these situations.

VI

! **The airbags do not operate when the ignition is switched off.**

This equipment will only operate once. If a second impact occurs (during the same or a subsequent accident), the airbag will not operate.

Impact detection zones

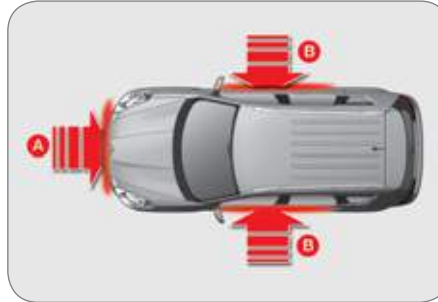

- A.** Front impact zone.
- B.** Side impact zone.

Deployment of the airbag(s) is accompanied by a slight emission of harmless smoke and a noise, due to the activation of the pyrotechnic cartridge incorporated in the system.

This smoke is not harmful, but sensitive individuals may experience slight irritation.

The noise of the detonation may result in a slight loss of hearing for a short time.

Front airbags

System which protects the head and chest of the driver and front passenger in the event of a front impact.

The driver's airbag is fitted in the centre of the steering wheel; the front passenger's airbag is fitted in the dashboard above the glove box.

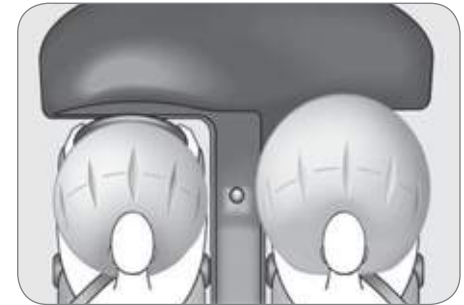

Deployment

The airbags are deployed simultaneously, unless the passenger's front airbag is deactivated, in the event of a serious front impact applied to all or part of the front impact zone **A**, in the longitudinal centreline of the vehicle on a horizontal plane and directed from the front to the rear of the vehicle.

The front airbag inflates between the front occupant of the vehicle and the dashboard to cushion their forward movement.

SAFETY

Deactivation

Only the front passenger's airbag can be deactivated:

- ☞ **with the ignition off**, insert the key in the passenger airbag deactivation switch **A**,
- ☞ turn it to the **"OFF"** position,
- ☞ remove the key.

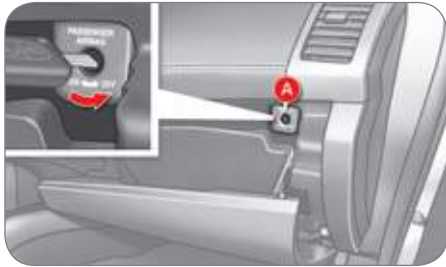

This warning lamp comes on in the centre console panel when the ignition is on and until the airbag is reactivated.



To ensure the safety of your child, the passenger's airbag must be deactivated when you install a "rear facing" child seat on the front passenger seat. Otherwise, the child would risk being seriously injured or killed if the airbag were triggered.

Reactivation

When you remove the child seat, turn switch **A** to the **"ON"** position to reactivate the airbag and so ensure the safety of your front passenger in the event of an impact.

The associated warning lamp goes off.

Operating fault



If this warning lamp comes on on the instrument panel and this display appears on the instrument panel screen, contact a CITROËN dealer or a qualified workshop to have the system checked. The airbags may no longer be deployed in the event of a serious impact.



If the airbag warning lamp and the display come on continuously, do not install a "rear facing" child seat on the front passenger seat. Contact a CITROËN dealer or a qualified workshop.

VI

SAFETY

Lateral airbags

System which protects the driver and passenger in the event of a serious side impact in order to limit the risk of injury to the chest.

Each lateral airbag is fitted in the front seat back frame, on the door side.

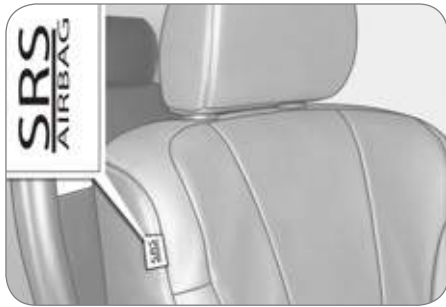

VI

Activation

The lateral airbag is triggered unilaterally in the event of a serious side impact applied to all or part of the side impact zone **B**, perpendicular to the longitudinal centreline of the vehicle on a horizontal plane and directed from the outside towards the inside of the vehicle.

The lateral airbag inflates between the front occupant of the vehicle and the corresponding door trim panel.

Impact detection zones

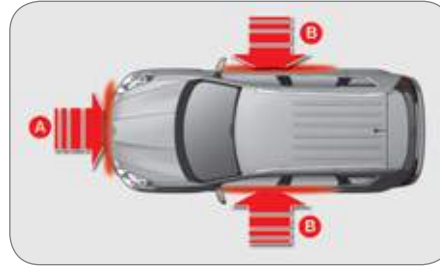

A. Front impact zone.

B. Side impact zone.

Curtain airbags

System which protects the driver and passengers (with the exception of the rear centre passenger and the passengers in row 3) in the event of a serious side impact in order to limit the risk of injury to the head.

Each curtain airbag is fitted in the pillars and the upper section of the passenger compartment.



Deployment

The curtain airbag is deployed at the same time as the corresponding lateral airbag in the event of a serious side impact applied to all or part of the side impact zone **B**, perpendicular to the longitudinal centreline of the vehicle on a horizontal plane and directed from the outside towards the inside of the vehicle.

The curtain airbag inflates between the front or rear occupant of the vehicle and the windows.

! In the event of a minor impact or bump on the side of the vehicle or if the vehicle rolls over, the airbag may not be deployed.

In the event of a rear or front collision, the airbag is not deployed.

Operating fault



If this warning lamp comes on in the instrument panel and this display appears in the instrument panel screen, contact a CITROËN dealer or a qualified workshop to have the system checked. The airbags may no longer be deployed in the event of a serious impact.

! **For the airbags to be fully effective, observe the following safety rules:**

Sit in a normal upright position.

Wear a correctly adjusted seat belt.

Do not leave anything between the occupants and the airbags (a child, pet, object...). This could hamper the operation of the airbags or injure the occupants.

After an accident or if the vehicle has been stolen or broken into, have the airbag systems checked.

All work on the airbag system must be carried out by a CITROËN dealer or a qualified workshop.

Even if all of the precautions mentioned are observed, a risk of injury or of minor burns to the head, chest or arms when an airbag is deployed cannot be ruled out. The bag inflates almost instantly (within a few milliseconds) then deflates within the same time discharging the hot gas via openings provided for this purpose.

Front airbags

Do not drive holding the steering wheel by its spokes or resting your hands on the centre part of the wheel.

Passengers must not place their feet on the dashboard.

If possible, do not smoke as deployment of the airbags can cause burns or the risk of injury from a cigarette or pipe.

Never remove or pierce the steering wheel or hit it violently.

Lateral airbags

Use only approved covers on the seats, compatible with the deployment the lateral airbags. For information on the range of seat covers suitable for your vehicle, you can contact a CITROËN dealer (see "Practical information - § Accessories").

Do not fix or attach anything to the seat backs (clothing...). This could cause injury to the chest or arms if the lateral airbag is deployed.

Do not sit with the upper part of the body any nearer to the door than necessary.

Curtain airbags

Do not fix or attach anything to the roof. This could cause injury to the head if the curtain airbag is deployed.

If fitted on your vehicle, do not remove the grab handles installed on the roof, they play a part in securing the curtain airbags.

DRIVING

PARKING BRAKE

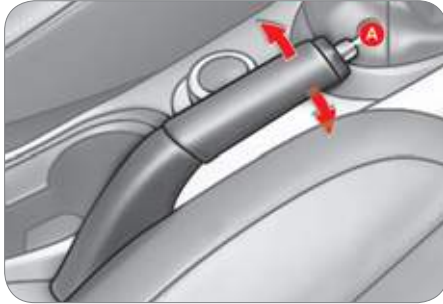

Applying

☞ Pull the parking brake lever up to immobilise your vehicle.

When parking on a slope, direct your wheels towards the pavement and apply the parking brake.

Releasing

☞ Pull the lever up and press the button **A** to release the parking brake.



When the vehicle is being driven, the display of this message indicates that the parking brake is still on or has not been properly released.

5-SPEED MANUAL GEARBOX

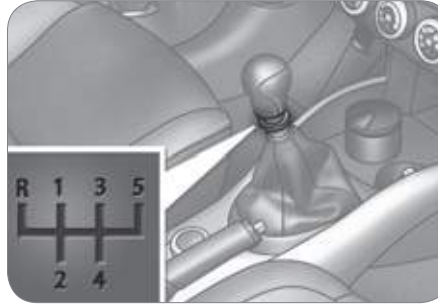

Engaging 5th or 6th gear

☞ Move the gear level fully to the right to change to 5th or 6th gear.

6-SPEED MANUAL GEARBOX

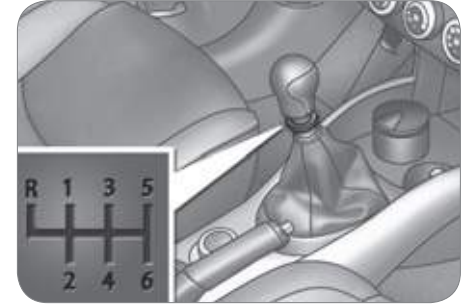

Engaging reverse

☞ Lift the sleeve below the gear knob and move the gear lever to the left and then towards the front.

Reverse gear can only be engaged when the vehicle is stationary with the engine idling.

DRIVING

CVT GEARBOX

The six-speed automatic gearbox offers a choice between the comfort of automatic regulation or the pleasure of manual gear changing.

This gearbox has two driving modes:

- an automated mode for automatic control of the gears by the gearbox and therefore without any action on the part of the driver,
- a sequential mode for manual changing of the gears by the driver using the steering mounted controls or the gear lever.

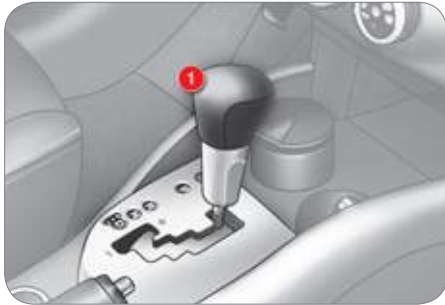

It consists of the following controls:

- a gear lever 1 on the centre console for selecting the driving mode, reverse gear and neutral or for changing gear in sequential mode,



- a "-" steering mounted control paddle 2 for sequential downward gear changes,
- a "+" steering mounted control paddle 3 for sequential upward gear changes.

Gear lever positions

N: neutral.

With your foot on the brake, select this position to start.

R: reverse gear.

With the vehicle stationary, keep your foot on the brake pedal and push the gear lever forwards.

D: automated mode.

Move the lever backwards to select this mode.

+/-: sequential mode with manual gear changing.

Move the lever backwards, then to the left to select this mode, then:

- push forward to change up,
- push backward to change down.

Functions of the steering mounted control paddles

+: manual gear changing in sequential mode.

Press behind the "+" steering mounted control paddle to change up.

-: manual gear changing in sequential mode.

Press behind the "-" steering mounted control paddle to change down.

Moving off

Select position **N**.





Press the brake pedal firmly while starting the engine.

Start the engine. "N" appears in the instrument panel screen.

Select first gear (position **D** or **+/-**) or reverse (position **R**).

Release the parking brake.

Release the brake pedal then accelerate.

"D" or "1" or "R" appear in the instrument panel screen.

Stopping - Starting on a slope

Do not use the accelerator pedal to immobilise the vehicle on a slope, apply the parking brake instead.

When starting on a slope, accelerate gradually while releasing the parking brake.

Switching to sequential mode

Once you have moved off, you can switch to sequential mode by selecting position **+/-**.

"D" disappears and the gears engaged appear in succession in the instrument panel screen.

The gear change requests are only carried out if the engine speed permits it.

Take your foot off the accelerator pedal gently to engage the gear.

At low speeds, when approaching a stop or traffic lights for example, the gearbox changes down to first gear automatically.

Switching to automated mode

Automated mode

After using the sequential mode, you can return to the automated mode by selecting position **D**.

"D" appears in the instrument panel screen.

The gearbox then operates in auto-active mode, without any action on the part of the driver.

It continuously selects the gear most suited to the conditions of:

- driving style,
- road characteristics,
- vehicle load.

To optimise driving comfort and obtain the most suitable gear, avoid sharp variations in the pressure on the accelerator pedal.

Auto sequential mode

In the automated mode, you can take over control temporarily at any time using the steering mounted controls.

The use of these controls permits manual selection of the gears in situations which require a faster changedown than that offered in automated mode (arrival at a roundabout, exit from a car park with a steep gradient, overtaking...).

The gearbox engages the gear requested if the engine speed permits it. The gear engaged appears.

To return to the automated mode, press the back of the **+ / OFF** control for approximately 2 seconds.

Stopping the vehicle

Before switching off the engine, you can:

- move to position **N** to leave the gearbox in neutral.
- leave a gear engaged, such as first or reverse.

In both cases, you must apply the parking brake to immobilise the vehicle.

Operating anomaly

With the ignition on, if the message **"Slow down"** or **"Maintenance required"** appears in the multifunction screen, this indicates a gearbox malfunction.

When a message is displayed, carry out the following operations:

- slow down and stop your vehicle in a safe place,
- place the lever in position **N** and let the engine run,
- open the bonnet to allow the engine to cool.

If the message disappears for a long period, you can set off again.

If the message remains displayed or appears frequently, contact a CITROËN dealer or a qualified workshop without

DRIVING

DCS GEARBOX

The six-speed electronically controlled gearbox offers a choice between the comfort of automatic regulation or the pleasure of manual gear changing.

This gearbox has three driving modes:

- a **manual** mode for changing of the gears by the driver using the steering mounted controls or the gear lever,
- a **"Normal"** automatic mode for economical control of the gears (everyday use),
- a **"Sport"** automatic mode which permits a more dynamic style of driving, with improved acceleration and optimised engine braking.

Displays in the instrument panel



When you move the lever in the gate to select a position, the corresponding indicator or message is displayed in the instrument panel.

P. Park.

R. Reverse.

N. Neutral.

D. Drive (Automatic mode).

NORMAL. Normal mode.

SPORT. Sport mode.

1,2,3,4,5,6. Gear engaged during manual operation.

Gear lever positions



P: park.



With your foot on the brake, this position permits starting of the vehicle.

To exit position **P**, raise the ring on the gear lever.

R: reverse gear.

With the vehicle stationary, keep your foot on the brake pedal and push the gear lever forwards.

N: neutral.

With your foot on the brake, this position also permits starting of the vehicle.

D: automatic mode.

Move the lever rearwards.

+/-: manual mode with gear changing using the lever.

VII

DRIVING

Moving off

Select position **P** or **N**.



Press the brake pedal firmly while starting the engine.



VII

Start the engine.

"**P**" or "**N**" appears in the instrument panel screen.

Select first gear (**D** or **+/-**) or reverse (**R**).

Release the parking brake.

Release the brake pedal then accelerate.

"**D**" or "**1**" or "**R**" appears in the instrument panel screen.

Manual mode

Using the gear lever



Move the gear lever backwards, then to the left to select position **+/-**.

Push forwards (**+**) to change up.

Push backwards (**-**) to change down.

Using the steering mounted controls



Press behind the "**+**" steering mounted control paddle to change up.

Press behind the "**-**" steering mounted control paddle to change down.

The gear change requests are only carried out if the engine speed permits it.

Take your foot off the accelerator pedal gently to engage the gear.

At low speeds, when approaching a stop or traffic lights for example, the gearbox changes down to first gear automatically.

"Normal" automatic mode

Select position **D**.

"**D**" appears in the instrument panel screen.

The gearbox then operates in automatic mode, without any action on the part of the driver.

To optimise driving comfort and obtain the most suitable gear, avoid sharp variations in the pressure on the accelerator pedal.

"Temporary" manual mode

In automatic mode, you can take control temporarily at any time using the steering mounted controls.

The use of these controls permits manual selection of the gears in situations which require a faster change down than that offered in automatic mode (arrival at a roundabout, exit from a car park with a steep gradient, overtaking...).

The gearbox engages the gear requested if the engine speed permits it. The gear engaged appears.

To return to the automatic mode, press the back of the "**+ / OFF**" control for at least 2 seconds.

"Sport" automatic mode

From automatic mode, you can engage "Sport" mode.

With the vehicle moving or stationary, push the thumb wheel **A** forward.

"**SPORT**" appears in the instrument panel screen.

Switching off "Sport" automatic mode

You can return to "Normal" automatic mode at any time:

Push the thumbwheel **A** rearward once.



Stopping the vehicle

Before switching off the engine, you must engage position **P** or **N** to place the gearbox in neutral.

You must apply the parking brake to immobilise the vehicle.

The gear lever must be in position **P** to remove the ignition key.

Hill start assist

To assist you when starting on a gradient, your vehicle is fitted with a system which immobilises it briefly (approximately 2 seconds), the time required to move your foot from the brake pedal to the accelerator pedal. This function is only active when the vehicle has been completely immobilised with your foot on the brake pedal and on certain gradients.

Do not get out of the vehicle during the hill start assist temporary immobilisation phase.

To immobilise the vehicle on a gradient for a longer period, you must use the parking brake, not the accelerator.

When starting on a gradient, accelerate gradually while releasing the parking brake.

Operating fault



With the ignition on, if this warning light comes on, accompanied by vibration in the pedals and the message **"Maintenance required"** on the instrument panel display, this indicates a gearbox malfunction.

If the message is displayed, carry out the following operations:

- slow down and stop your vehicle in a safe place,
- place the lever in position **P** or **N**, apply the parking brake and let the engine run,
- open the bonnet to allow the engine to cool.

If the message disappears for a long period, you can set off again.

If the message remains displayed or appears frequently, contact a CITROËN dealer or a qualified workshop without delay.

Overheating of the engine may result in unwanted declutching of the gearbox.

Reverse gear

Flashing of the indicator **R** in the instrument panel screen, accompanied by an audible signal, indicates a malfunction on engaging the gear:

Press the brake pedal, position the gear lever in position **N** and engage reverse gear again.

FOUR WHEEL DRIVE SYSTEM WITH ELECTRONIC CONTROL

System which permits the selection of a transmission mode in relation to the driving conditions.

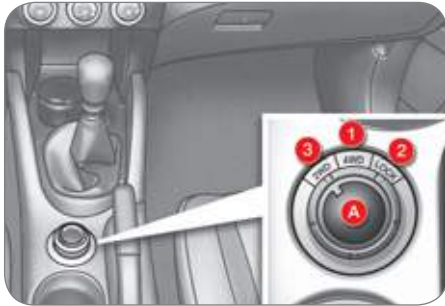

Three transmission modes are available and can be selected manually by the driver in accordance with his requirements.

You can change transmission mode when stationary or while driving at a speed **below 60 mph (100 km/h)**.

The transmission mode can be selected by turning the control **A**.

Selecting the transmission mode

4WD AUTO (position 1)

The vehicle operates with four wheel drive and provides optimum traction regardless of the level of grip.

This is the vehicle's normal and regular operating mode, the distribution of the torque between the front and rear axles is controlled automatically.

The distribution favours the front wheels, the transfer of torque to the rear wheels is managed electronically by the control unit in relation to the level of grip, so providing optimum road holding.

4WD LOCK (position 2)

The vehicle operates with four wheel drive in this mode also.

It is recommended when grip is particularly poor or difficult (sand, mud, slopes, ...).

2WD (position 3)

The vehicle operates with front two wheel drive.

This mode corresponds to use on a tar-macked road on which the driver considers that there is no risk of loss of grip (dry road).

The selection of this mode is recommended when the level of grip permits.

Display in the instrument panel



The transmission mode is displayed in the form of an intermittent display in the instrument panel screen when the transmission mode is selected.

Operating faults



If the selected transmission mode display flashes, the vehicle switches automatically to front "2WD" transmission mode.

It is then no longer possible to select the transmission mode using the control **A**.

If the message "SLOW DOWN" is displayed on the instrument panel, let the transmission cool down then wait for the display to clear before setting off again.

If "4WD" and "LOCK" are displayed alternately and if "MAINTENANCE REQUIRED" is displayed in the instrument panel, the system has failed and the safety system has been activated.

Contact a CITROËN dealer or a qualified workshop without delay.



Do not subject the vehicle to excessive conditions while driving.

As the engine torque is applied to all four wheels, the condition of the tyres has a considerable impact on the performance of the vehicle.

Ensure that all four tyres are in good condition.

Avoid driving the vehicle in sandy or muddy areas or in other areas in which the wheels could spin.

Spinning the wheels places the transmission components under pressure and could cause a serious malfunction.

Do not drive the vehicle through deep water.

Avoid driving over excessively uneven terrain (risk of scraping under the body or of grounding on crossing a bridge).



Have your vehicle towed on a flat-bed.

The vehicle must not be towed with the front or rear wheels on the ground even if it is in front "2WD" (2 wheel drive) mode.

CRUISE CONTROL

System which automatically maintains the vehicle speed at the value programmed by the driver, without any action on the accelerator pedal.

The cruise control is **switched on** manually: the vehicle speed must be 25 mph (40 km/h) minimum and second gear must be engaged in the case of a manual gearbox.

The cruise control is **switched off** manually, by an action on the brake or clutch pedal or if the ASC system is triggered.

The programmed speed can be exceeded temporarily by pressing the accelerator pedal.

To return to the programmed speed, simply release the accelerator pedal.

Switching off the ignition cancels any programmed speed value.

The cruise control cannot, in any circumstances, take the place of the need to comply with speed limits or of the vigilance and responsibility of the driver.

Steering mounted controls

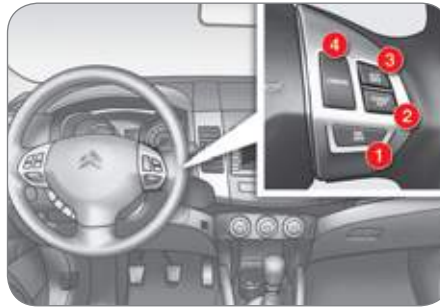

The controls of this system are grouped together on the steering wheel.

1. **"ON/OFF"** button: activation / deactivation of the cruise control mode.
2. **"COAST SET"** button: storing of a driving speed and decreasing of the cruising speed.
3. **"ACC RES"** button: increasing of the cruising speed and recalling of the stored speed.
4. **"CANCEL"** button: switching off of the cruise control.

Display on the instrument panel



When you press button 1, the **"CRUISE"** indicator comes on in the instrument panel.

Programming

- ☞ Press button 1.
- ☞ Set the programmed speed by accelerating to the required speed, then press button 2 **"COAST SET"**.

Increasing the programmed speed

- ☞ Using button **3 "ACC RES"**:
 - successive presses increase the speed in steps of approximately 1 mph (1.6 km/h).
 - a maintained press of this button increases the programmed speed progressively.

Once the speed required has been reached, release the button, the new speed is stored.

- ☞ Using the accelerator pedal:
 - accelerate to reach the speed required, then press button **2 "COAST SET"**. Release the button to store the new speed.

Decreasing the programmed speed

- ☞ Using button **2 "COAST SET"**:
 - successive presses decrease the speed in steps of approximately 1 mph (1.6 km/h).
 - a maintained press of this button decreases the speed progressively.

Once the speed required has been reached, release the button, the new speed is stored.

- ☞ Using the brake pedal:
 - brake to deactivate the cruise control, then press button **2 "COAST SET"**. Release to store the new speed.

Temporary acceleration/ deceleration

Temporary acceleration

Press the accelerator pedal as normal. When the pedal is released, you return to the stored speed.

Temporary deceleration

Press the brake pedal to reduce the speed. To return to the stored speed, press button **3 "ACC RES"**.

Deactivating the function

To deactivate the cruise control:

- ☞ Press the **brake or clutch** pedal, or
- ☞ Press button **1 "ON OFF"**, or
- ☞ Press button **4 "CANCEL"**.

The cruise control may be deactivated automatically:

- ☞ When the vehicle reaches a speed below 20 mph (35 km/h).
- ☞ When the active stability control system (ASC) comes into operation.

Reactivating the function

When the cruise control has been deactivated, you can return to the stored speed by pressing button **3 "ACC RES"** when you reach a minimum speed of 25 mph (40 km/h).



When the cruise control is in operation, pay attention if you press and hold one of the programmed speed adjustment buttons: this can result in a very rapid change in the speed of your vehicle.

Do not use the cruise control on slippery roads or in heavy traffic.

On a steep descent, the cruise control will not be able to prevent the vehicle from exceeding the programmed speed.

To prevent the mat from becoming caught under the pedals:

- ensure that the mat is positioned correctly,
- never fit one mat on top of another.

AUDIBLE REAR PARKING SENSORS

System consisting of proximity sensors installed in the rear bumper.



It detects obstacles (person, vehicle, tree, gate, ...) located behind the vehicle, but it cannot detect obstacles located immediately below the bumper.

Location of the sensors

The vehicle is fitted with four sensors:

- two side sensors **A**
- two central sensors **B**.

An object such as a stake, a road works cone or any other similar object may be detected at the beginning of the manoeuvre but may no longer be detected when the vehicle moves closer to it.

Detection zones

The detection zones differ depending on whether the vehicle is fitted with a towbar.

If you select towbar mode, the towbar zone **C** is excluded from the detection zones.



Vehicle only

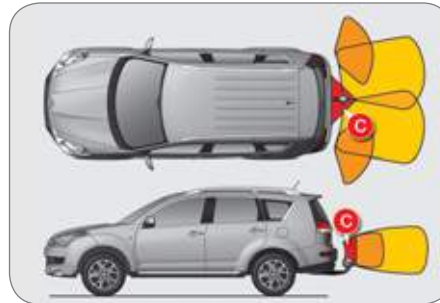

Vehicle fitted with a towbar

Activation

The parking sensors are activated by engaging reverse gear.

The proximity information is indicated by an audible signal which becomes more frequent as the vehicle approaches the obstacle.

When a certain distance between the rear of the vehicle and the obstacle is reached, the audible signal becomes continuous:

Sensors	Distance between vehicle and obstacle less than:
Side A	Approximately 25 cm
Central B without towbar	Approximately 40 cm
Central B with towbar	Approximately 60 cm

The parking sensor system cannot, in any circumstances, take the place of the need for vigilance and responsibility on the part of the driver.

Modification of the detection zones

- ☞ Press button **A** to deactivate the system.
- ☞ Press button **A** again for a few seconds and release it.

The detection zone modification information is indicated by an audible signal:

- **double** signal on vehicles fitted with a towbar,
- **single** signal on vehicles which are not fitted with a towbar.

Deactivation



- ☞ With reverse gear engaged, press button **A**, the indicator lamp goes off, the system is fully deactivated.

Reactivation

- ☞ With reverse gear engaged, press button **A** again, the indicator lamp comes on, the system is reactivated.

Operating fault

If an operating fault occurs, the indicator lamp in button **A** flashes when reverse gear is engaged.

Contact a CITROËN dealer or a qualified workshop.

In bad weather or in winter, check that the sensors are not covered with mud, ice or snow.

REVERSING CAMERA

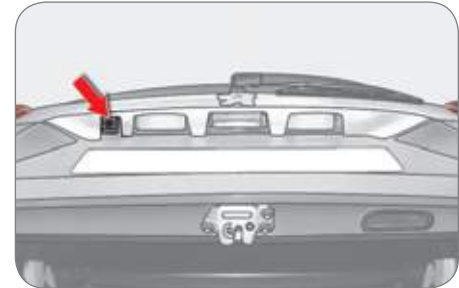

Linked with the navigation option, a reversing camera is activated automatically when reverse gear is engaged.

The colour image is provided on the navigation screen with indication of the limit of the rear bumper and of the general direction of the vehicle.

The red line indicates the distance required to open the lower tailgate.

TOTAL & CITROËN

Partners in performance and protecting the environment

Innovation in the search for performance

For over 40 years, the TOTAL Research and Development departments have developed for CITROËN, lubricants to match the latest technical innovations on CITROËN vehicles, both for competition and for everyday motoring.

For you, this is an assurance that you will obtain the best performance for your engine.

Optimum protection for your engine

By having your CITROËN vehicle serviced with TOTAL lubricants, you are contributing towards improving the life and performances of your engine, while also protecting the environment.



VIII



CITROËN prefers TOTAL



<https://www.automotive-manuals.net/>

CHECKS

OPENING THE BONNET



From inside: pull the release lever **A**, on the left-hand side below the door, towards you.

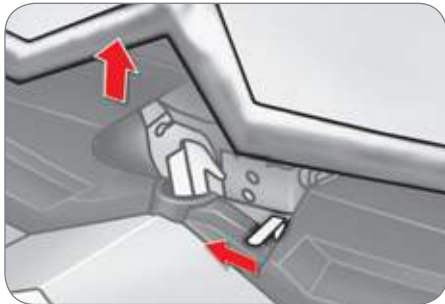

From outside: move the safety catch to the left then raise the bonnet.

Bonnet stay

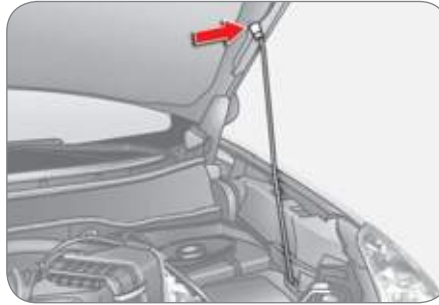

Secure the stay in its housing to hold the bonnet open.

Before closing the bonnet, refit the stay in its clip.

This operation must only be carried out when the vehicle is stationary.

When the engine is hot, handle the exterior safety catch and the bonnet stay with care (risk of burns).

To close

Lower the bonnet and release it at the end of its travel. Check that the bonnet is properly latched.

RUNNING OUT OF FUEL

If you run out of fuel, fill the tank and operate the starter until the engine starts.

Several attempts may be needed before the engine re-starts.

CHECKS

PETROL ENGINE

Access for checking the levels of the various fluids and the replacement of certain components.

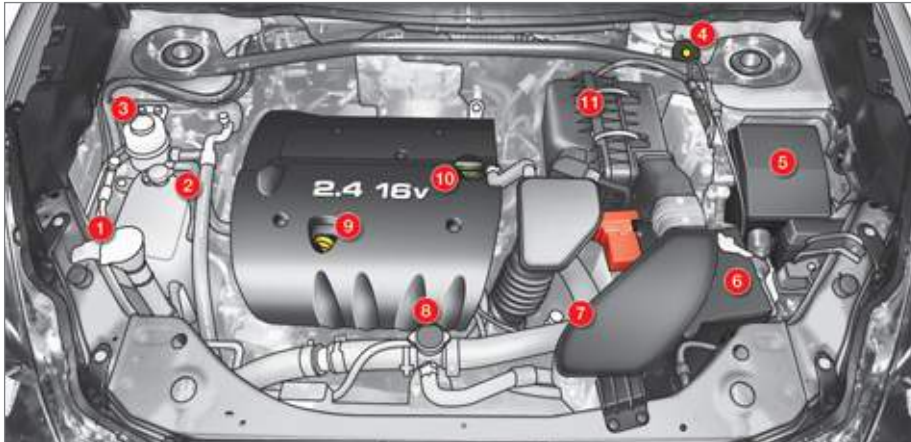

1. Screenwash and headlamp wash reservoir.
2. Coolant reservoir.
3. Power steering fluid reservoir.
4. Brake fluid reservoir.
5. Fusebox.
6. Battery.
7. CVT gearbox dipstick.
8. Radiator cap.
9. Engine oil dipstick.
10. Engine oil filler cap.
11. Air filter.

CHECKS

DIESEL ENGINE

Access for checking the levels of the various fluids and the replacement of certain components.

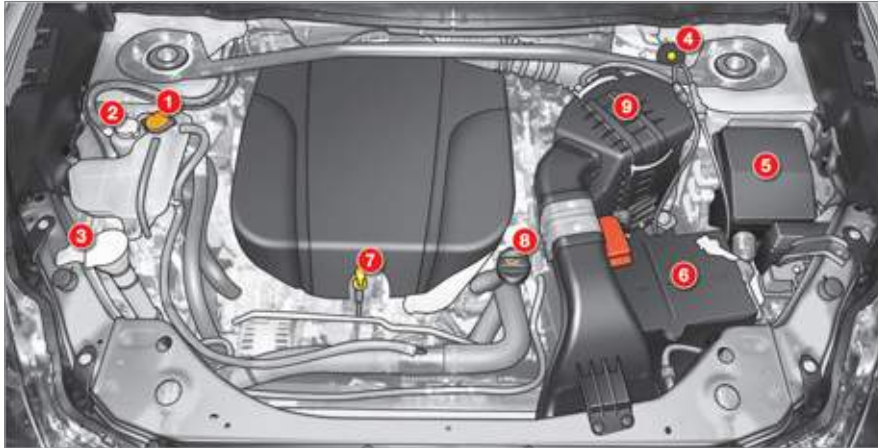

1. Coolant reservoir.
2. Power steering fluid reservoir.
3. Screenwash and headlamp wash reservoir.
4. Brake fluid reservoir.
5. Fusebox.
6. Battery.
7. Engine oil dipstick.
8. Engine oil filler cap.
9. Air filter.

CHECKS

CHECKING LEVELS

Check all of these levels regularly and top them up if necessary, unless otherwise indicated.

If a level drops significantly, have the corresponding system checked by a CITROËN dealer or a qualified workshop.

When working under the bonnet, take care as certain areas of the engine may be extremely hot (risk of burns).

Oil level



The reading will only be correct if the vehicle is on level ground and the engine has been off for more than 30 minutes.

The check is carried out either when the ignition is switched on using the oil level indicator on the instrument panel, or using the dipstick.

It is normal to top up the engine oil between services. The manufacturer recommends that the oil level be checked, and topped up if necessary, every 3 000 miles (5 000 km).

Changing the engine oil

Refer to the servicing booklet for details of the interval for this operation.

In order to maintain the reliability of the engine and emission control system, the use of additives in the engine oil is prohibited.

Oil specification

The oil must correspond to your engine and conform to the manufacturer's recommendations.

Brake fluid level



The brake fluid level should be between the "MAX" and "MIN" marks.

If it is not, check the brake pad wear.

Changing the brake fluid

Refer to the servicing booklet for details of the interval for this operation.

Fluid specification

The brake fluid must conform to the manufacturer's recommendations and fulfil the DOT4 standards.

Coolant level



The coolant level must be measured when the engine is cold and should be between the "LOW" and "FULL" marks.

When the engine is warm, the temperature of the coolant is regulated by the fan. This can operate with the ignition off.

On vehicles which are fitted with a particle emission filter, the fan may operate after the vehicle has been switched off, even if the engine is cold.

In addition, as the cooling system is pressurised, wait at least one hour after switching off the engine before carrying out any work.

To avoid any risk of scalding, unscrew the cap by two turns to allow the pressure to drop. When the pressure has dropped, remove the cap and top up the level.

Changing the coolant fluid

Refer to the servicing booklet for details of the interval for this operation.

Fluid specification

The coolant must conform to the manufacturer's recommendations.

Screenwash and headlamp wash* fluid



Check the fluid level regularly, using the gauge.

Fluid specification

This fluid must conform to the manufacturer's recommendations for optimum cleaning.

Power steering fluid level

Check the fluid level with the engine at idle.

Check that the power steering fluid level is always between the "MAX" and "MIN" marks and top up if necessary.

Fluid specification

This fluid must conform to the manufacturer's recommendations.

*According to country.

CHECKS

Diesel additive level (Diesel with particle emission filter)

The minimum level of this additive is indicated by lighting of the service warning lamp, accompanied by an audible signal and a message on the multifunction screen.

Topping up

This additive must be topped up by a CITROËN dealer or a qualified workshop without delay.

Waste products



Avoid any prolonged contact of used oil or fluids with the skin.

Most of these fluids are harmful to health or indeed very corrosive.



Do not discard used oil or fluids into sewers or onto the ground.

Empty used oil into the containers provided for this purpose at CITROËN dealers (France) or a qualified workshop, or take them to an authorised waste disposal site.

CHECKS

Unless otherwise indicated, check these components in accordance with the servicing booklet and in relation to your engine.

Otherwise, have them checked by a CITROËN dealer or a qualified workshop.

Battery



Check the electrolyte level regularly. If necessary, top up the level with distilled water.

Check that the terminals are clean and correctly tightened, particularly in summer and winter.

When carrying out work on the battery, refer to the "Practical information" section for details of the precautions to be taken before disconnecting the battery and following its reconnection.

Air filter and passenger compartment filter



Refer to the servicing booklet for details of the replacement intervals for these components.

Depending on the environment (dusty atmosphere...) and the use of the vehicle (city driving...), replace them twice as often if necessary (refer to the "Engines" paragraph).

A clogged passenger compartment filter may have an adverse effect on the performance of the air conditioning system and generate undesirable odours.

Particle emission filter (Diesel)

Maintenance of the particle emission filter must be carried out by a CITROËN dealer or a qualified workshop.

Following prolonged operation of the vehicle at very low speed or at idle, you may, exceptionally, notice the emission of water vapour at the exhaust on acceleration. This does not have any adverse effect on the performance of the vehicle or on the environment.

Oil filter



Replace the oil filter each time the engine oil is changed.

Refer to the servicing booklet for details of the replacement interval for this component.



Do not discard the oil filter through public channels, deposit it in the containers dedicated to this use in the CITROËN network (France) or a qualified workshop or take them to an authorised waste disposal site.

CHECKS

Manual gearbox



Refer to the servicing booklet for details of gearbox maintenance.

Transfer box and rear differential



Refer to the servicing booklet for details of the service interval for these components.

Brake pads



Brake wear depends on the style of driving, particularly in the case of vehicles used in town, over short distances. It may be necessary to have the condition of the brakes checked, even between vehicle services.

Unless there is a leak on the circuit, a drop in the brake fluid level indicates that the brake pads are worn.

Brake disc wear



For information on checking brake disc wear, contact a CITROËN dealer or a qualified workshop.

Parking brake



If the parking brake travel is too long or if you notice a loss of effectiveness of this system, the parking brake must be adjusted, even between two services.

This system must be checked by a CITROËN dealer or a qualified workshop. Only use products recommended by CITROËN or products of equivalent quality and specifications.



In order to optimise the operation of units as important as the braking system, CITROËN selects and offers very specific products.

To avoid damaging the electrical units, the use of a high pressure washer in the engine compartment is strictly prohibited.

CHANGING A WHEEL

Access to the tools

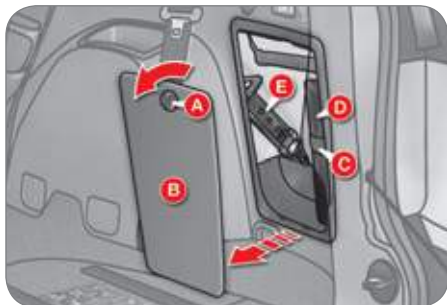

The tools are stored in the storage compartment in the boot right-hand trim.

To gain access to them:

- ☞ open the boot,
- ☞ turn button **A** to the left,
- ☞ remove the cover **B**,
- ☞ remove the fixing band **C** and take out the tool bag **D** containing the tools,
- ☞ take the jack **E** in your hand and remove it from its fixing position.

IX

When storing, take care to secure the tool bag **D** firmly using the fixing band **C**.

List of tools



1. Wheelbrace.
Used to remove the wheel trim and the wheel fixing bolts.
2. Jack.
Used to raise the vehicle.
3. Handle.
Used to extend the jack.



When changing a wheel, ensure that the four wheels are of identical specification and brand.

Other accessories



4. Removable towing eye.
Refer to the "Towing" paragraph.

Wheel with trim

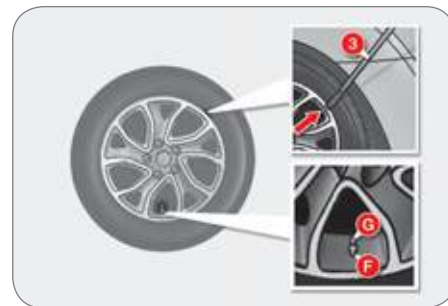

When removing the wheel, remove the trim first using the handle **3**, pulling at the notch.

When refitting the wheel, refit the trim starting by placing its notch **F** (indicated on the back of the trim) opposite the valve **G** and press on its outer edge with the palm of your hand.

Access to the spare wheel in the 7 seat configuration



The "space-saver" spare wheel is installed on the outside, under the boot, supported by a metal carrier.

To gain access to the tools, refer to the "Access to the tools" paragraph.

Fixing the "space-saver" spare wheel

If your vehicle is fitted with alloy wheels, it is normal to notice that the washers do not come into contact with the "space-saver" spare wheel when tightening the bolts on fitting. The wheel is retained by the conical contact of each bolt.

Removing the wheel

- ☞ Open the tailgate and the lower tailgate (refer to the "Access" section).
- ☞ Take out the handle **3** (refer to the "Access to the tools" paragraph).



- ☞ Remove the plastic cover **A** using the handle **3**.

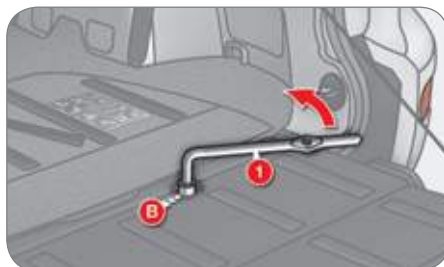

- ☞ Unscrew the spare wheel carrier retaining bolt **B** using the wheelbrace **1**.
- ☞ Close the lower tailgate (refer to the "Access" section).
- ☞ Lift the carrier **C** to detach the hook **D** then allow it to lower.

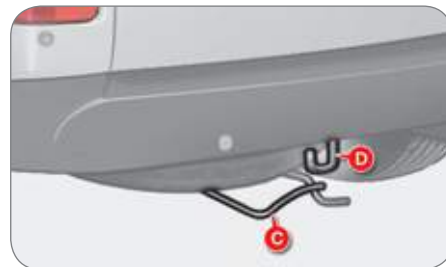

Putting the wheel back in place

- ☞ Put the wheel back in place in its carrier.
- ☞ Lift the carrier **C** and reposition the hook **D**.
- ☞ Open the lower tailgate (refer to the "Access" section).

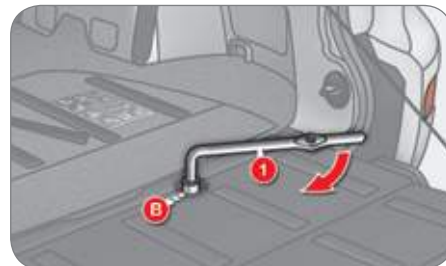

- ☞ Tighten the spare wheel carrier retaining bolt **B** fully using the wheelbrace **1**.
- ☞ Refit the plastic cover **A**, close the lower tailgate and store the tools.

PRACTICAL INFORMATION

Access to the spare wheel in the 5 seat configuration



The **pressed steel** spare wheel is installed on the outside, under the boot, supported by a winch and a plastic carrier.

To gain access to the tools, refer to the "Access to the tools" paragraph.

Fixing the pressed steel spare wheel

If your vehicle is fitted with alloy wheels, it is normal to notice that the washers do not come into contact with the pressed steel spare wheel when tightening the bolts on fitting. The wheel is retained by the conical contact of each bolt.

Removing the wheel

- ☞ Open the tailgate and the lower tailgate (refer to the "Access" section).
- ☞ Take out the handle **3** (refer to the "Access to the tools" paragraph).

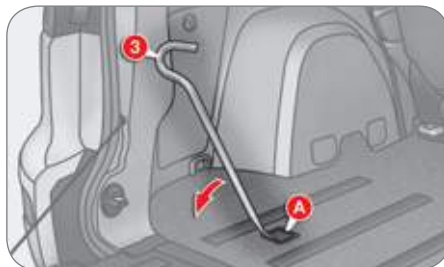

- ☞ Remove the plastic cover **A** using the handle **3**.

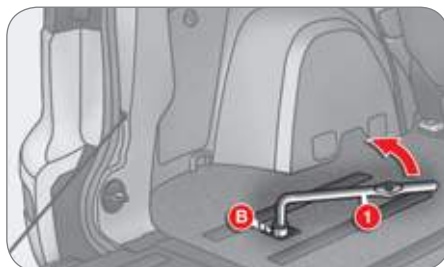

- ☞ Unscrew the retaining bolt **B** fully using the wheelbrace **1**, to unwind the winch cable.
- ☞ Close the lower tailgate (refer to the "Access" section).
- ☞ Detach the hook **C** from the chain.

Unwind the winch cable fully to make unhooking of the chain easier.



Putting the wheel back in place

- ☞ Put the wheel back in place in the carrier.
- ☞ Pass the hook **C** into the chain.
- ☞ Open the lower tailgate (refer to the "Access" section).

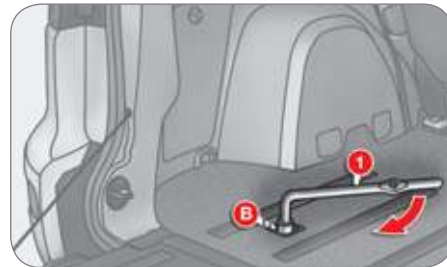

- ☞ Tighten the winch retaining bolt **B** fully using the wheelbrace **1**.
- ☞ Refit the plastic cover **A**, close the lower tailgate and store the tools.

PRACTICAL INFORMATION

Removing a wheel



Parking the vehicle

Immobilise the vehicle where it does not block traffic: if possible, park the vehicle on level, stable and non-slippery ground.

Apply the parking brake, switch off the ignition and engage first gear to lock the wheels.

If necessary, place a chock under the wheel diagonally opposite the wheel to be changed.

Never go underneath a vehicle raised using a jack; use a stand.

List of operations

- ☞ If your vehicle is equipped with security wheel bolts (equipment available as an accessory) fit the security socket **5** on the wheelbrace **1** to slacken the security bolt.
- ☞ Slacken the other bolts using the wheelbrace **1** only.
- ☞ Place the jack **2** in contact with one of the two front **A** or rear **B** locations provided on the underbody, whichever is closest to the wheel to be changed.
- ☞ Extend the jack **2** until its base plate is in contact with the ground. Ensure that the centreline of the jack base plate is directly below the location **A** or **B** used.
- ☞ Raise the vehicle until there is sufficient space between the wheel and the ground to admit the spare (not punctured) wheel easily.
- ☞ Remove the bolts and store them in a clean place.
- ☞ Remove the wheel.



IX

PRACTICAL INFORMATION

Fitting a wheel



List of operations



- ☞ Put the wheel in place on the hub.
- ☞ Screw in the bolts fully by hand.
- ☞ Pre-tighten the security bolt using the wheelbrace 1 fitted with the security socket 5 (if your vehicle is equipped with security wheel bolts).
- ☞ Pre-tighten the other bolts using the wheelbrace 1 only.



- ☞ Tighten the security bolt using the wheelbrace 1 fitted with the security socket 5 (if your vehicle is equipped with security wheel bolts).
- ☞ Tighten the other bolts using the wheelbrace 1 only.
- ☞ Store the tools (refer to the paragraph "Access to the tools").

After changing a wheel

When using the "space-saver" spare wheel, do not exceed a speed of 50 mph (80 km/h).

Have the tightening of the bolts and the pressure of the spare wheel checked by a CITROËN dealer or a qualified workshop without delay.

Have the punctured wheel repaired and replace it on the vehicle as soon as possible.



- ☞ Lower the vehicle fully.

Fitting snow tyres

If you equip your vehicle with snow tyres fitted on steel wheel rims, special bolts available from your CITROËN dealer or a qualified workshop **must** be used.

CHANGING A BULB

Front lamps



1. **Direction indicators (PY21W - 21 W).**
2. **Dipped beam headlamps (H11 - 55 W) or xenon bulb (D2S - 35 W).**
3. **Sidelamps (W5W - 5 W).**
4. **Main beam headlamps (H7 - 55 W).**
5. **Front foglamps (H11 - 55 W).**

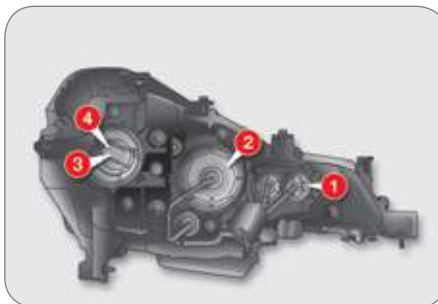

! Handle the bulbs using a dry cloth.

Do not clean the headlamps using a dry or abrasive cloth, or using detergent or solvent products, use a sponge and soapy water.

! **WARNING: RISK OF ELECTROCUTION**

Xenon bulbs must be replaced by a CITROËN dealer or a qualified workshop.

In some weather conditions (e.g. low temperature or humidity), the presence of misting on the internal surface of the glass of the headlamps and rear lamps is normal; it disappears after the lamps have been on for a few minutes.

PRACTICAL INFORMATION

Changing direction indicator bulbs (1)



- ☞ Turn the bulb holder **A** to the left and remove it.
 - ☞ Pull the bulb and change it.
- To refit, carry out these operations in reverse order.

Coloured bulbs must be replaced with bulbs of identical specification and colour.

IX

Access to the bulbs on the left-hand side



When you change a bulb on the left-hand side, remove the relay box fixing nut **B** and move the relay box towards the rear.

Access to the bulbs on the right-hand side

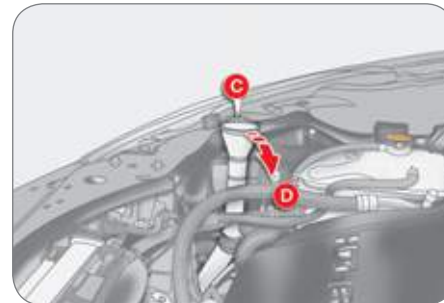

When you change a bulb on the right-hand side:

- ☞ Remove the screenwash reservoir fixing **C** and move the reservoir towards the rear.
- ☞ Remove the coolant reservoir fixing nut **D**.

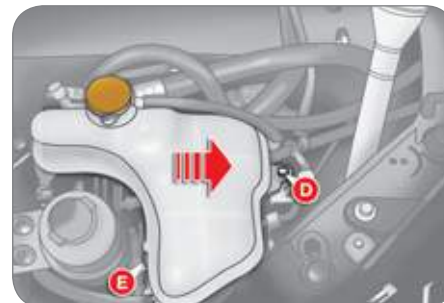

- ☞ Remove the clip **E** and raise the reservoir moving it towards the front.

PRACTICAL INFORMATION

Changing dipped beam headlamp bulbs (2)

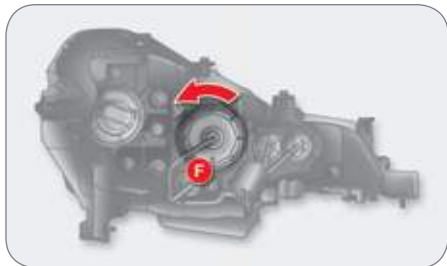

- ☞ Unscrew the cover **F**.
- ☞ Disconnect the connector.



- ☞ Turn the bulb **G** to the left and remove it.
- To refit, carry out these operations in reverse order.

Changing sidelamp bulbs (3)

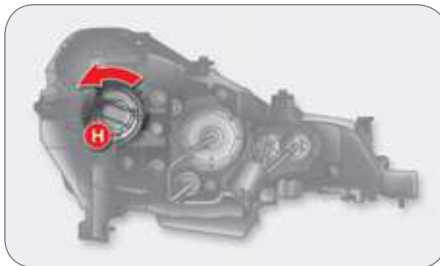

- ☞ Unscrew the cover **H**.
- ☞ Disconnect the connector.



- ☞ Turn the bulb holder **I** a quarter of a turn and remove it.
 - ☞ Pull the bulb and change it.
- To refit, carry out these operations in reverse order.

Changing main beam headlamp bulbs (4)

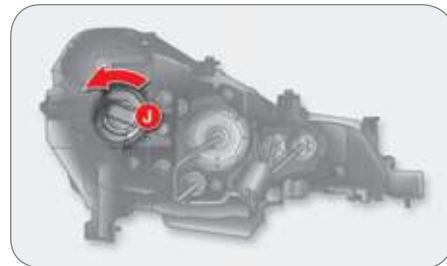

- ☞ Unscrew the cover **J**.
- ☞ Disconnect the connector.



- ☞ Move aside the spring **K** to release the bulb and remove it.
- To refit, carry out these operations in reverse order.

IX

Changing integrated direction indicator side repeaters



- ☞ Push the repeater **A** towards the rear and detach it.
- ☞ Unclip the repeater.
- ☞ Disconnect the repeater connector and change the repeater.

To refit, carry out these operations in reverse order.

To obtain repeaters, contact a CITROËN dealer or a qualified workshop.

Changing foglamp bulbs (5)



- ☞ Turn the wheel fully out for easy access to the flap **A** located in the wheelarch.

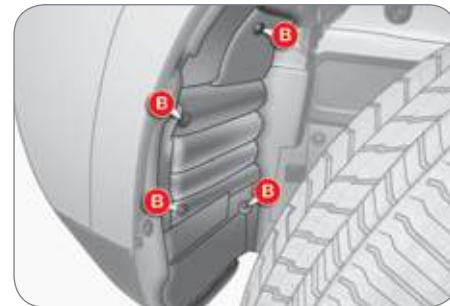

- ☞ Using a screwdriver, remove the four clips **B** located in the wheelarch.

PRACTICAL INFORMATION



☞ Using a screwdriver, remove the three clips **C** located below the bumper.



☞ Lift the access flap **D** located in the wheelarch and slide it downwards.



☞ Disconnect the connector **E**.
☞ Turn the bulb **F** to the left and remove it.

To refit, carry out these operations in reverse order.

Rear lamps



1. Third brake lamp (LEDs).
2. Brake lamps/Sidelamps (21/5 - W21W - 5 W).
3. Direction indicators (WY21W - 21 W).
4. Reversing lamps (W21W - 21 W).
5. Number plate lamps (W5W - 5W).
6. Foglamps (W21W - 21 W).

IX

Amber coloured bulbs, such as the direction indicators, must be replaced with bulbs of identical specification and colour.

Changing the third brake lamp (LEDs)

All work on the LED lamps must be carried out by a CITROËN dealer or a qualified workshop.

Changing brake lamp/sidelamp and direction indicator bulbs

These two bulbs are changed from outside with the tailgate open:

- ☞ Open the tailgate (refer to the "Access" section),



- ☞ Remove the two lamp fixing bolts A,
- ☞ Extract the lamp unit from outside,

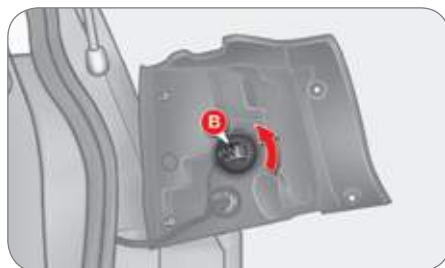

- ☞ Turn the pin B to the left and remove it.
- ☞ Pull the bulb out and change it.

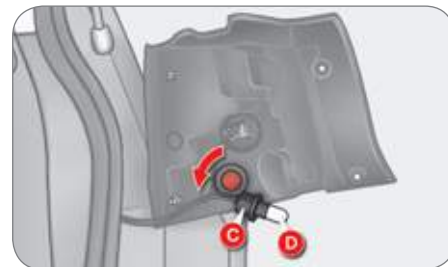

- ☞ Turn the pin C to the left and remove it.
- ☞ Pull the bulb D out and change it.

To refit, carry out these operations in reverse order.

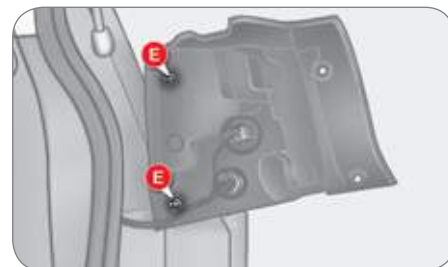

When refitting the lamp unit, align the two pins E with the openings on the vehicle.

PRACTICAL INFORMATION

Changing reversing lamp bulbs

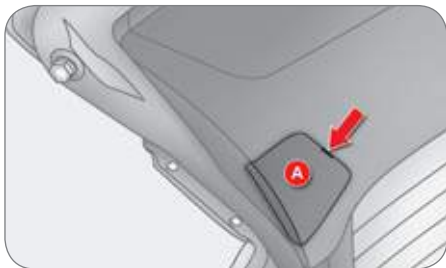

- ☞ Open the tailgate (refer to the "Access" section),
- ☞ From the inside of the tailgate, insert a screwdriver in the opening on the cover **A** to use it as a lever to open the cover.

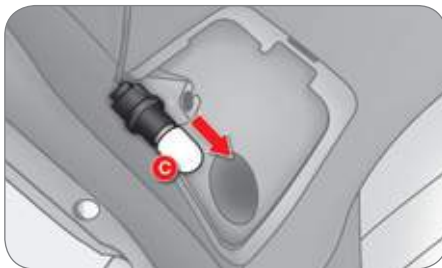

- ☞ Pull the bulb **C** out and change it. To refit, carry out these operations in reverse order.

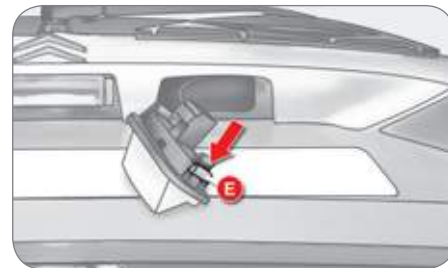

- ☞ Insert a thin screwdriver in the opening on the lens to press the tab **E**.
- ☞ Remove the lens.
- ☞ Pull the bulb out and change it. To refit, carry out these operations in reverse order.

Changing number plate lamp bulbs



- ☞ Turn the pin **B** to the left and remove it.

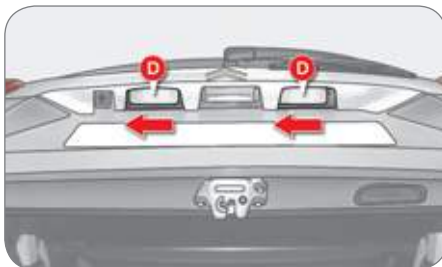

- ☞ Open the tailgate (refer to the "Access" section) to gain access to the number plate lamps **D**,

- ☞ Remove the lamp unit **D** while pressing it to the left.

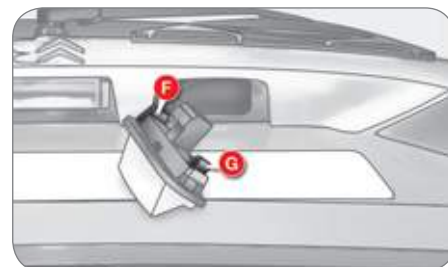

- ☞ To refit the lamp unit, insert the end of the tab **F** first, then align the tab **G**.

Changing foglamp bulbs

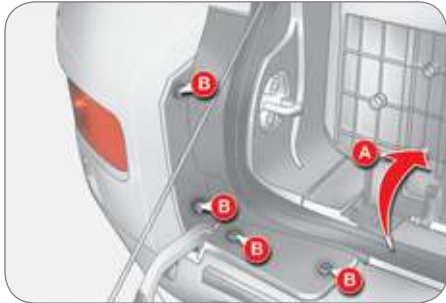

- ☞ Open the tailgate and the lower tailgate (refer to the "Access" section) and fold down the cover **A**.
- ☞ Remove the 4 clips **B** using a screwdriver to detach the lamp cover.

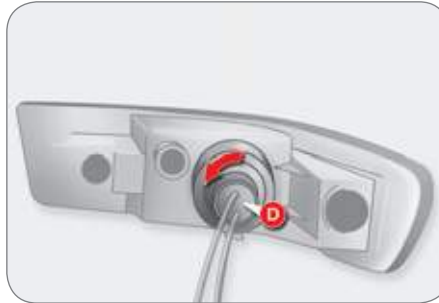

- ☞ Turn the pin and bulb assembly **D** to the left.
 - ☞ Remove the bulb.
- To refit, carry out these operations in reverse order.

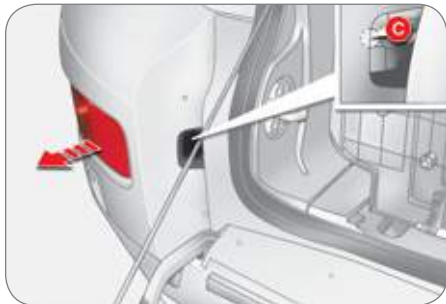

- ☞ Remove the bolts **C** and remove the lamp unit.

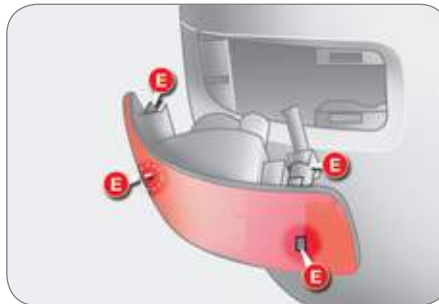

- ☞ When refitting the lamp unit, align the clips **E** with the openings on the bodywork.

PRACTICAL INFORMATION

INTERIOR LAMP BULBS

Front and rear courtesy lamps

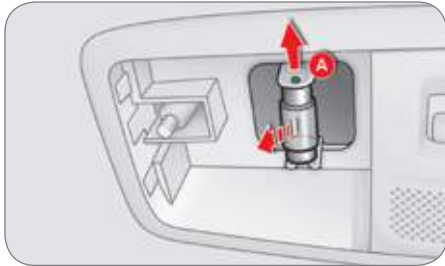

- ☞ Insert a screwdriver to remove the courtesy lamp cover.
 - ☞ Remove the bulb while pressing the tab **A**.
- To refit the cover, align the hooks on the holes located in the body of the vehicle.

Glove box lamp

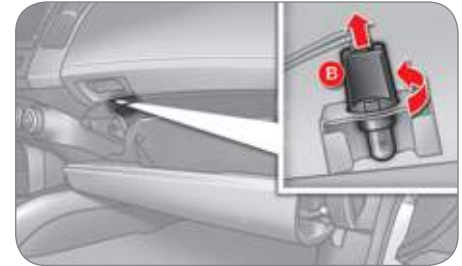

- ☞ Turn the pin **B** anticlockwise and remove it.
- ☞ Remove the bulb.

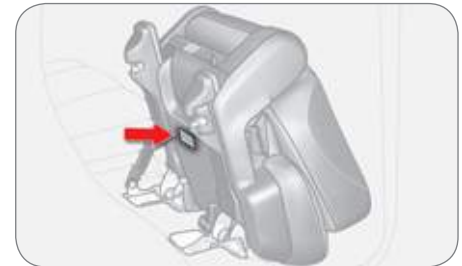

Low level lamp

- ☞ Insert a screwdriver to remove the lamp cover.
- ☞ Remove the bulb.

CHANGING A FUSE

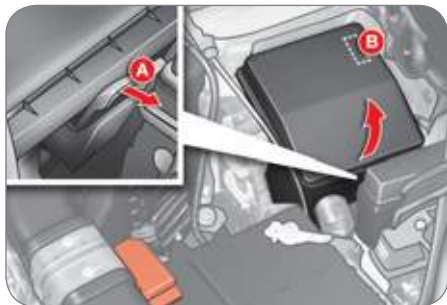

Access to the tools

The extraction tweezers are fitted in the engine compartment fusebox.

To gain access to them:

- ☞ Open the bonnet (refer to the "Access" section),
- ☞ Press on the hook **A** and release the catch,
- ☞ Remove the cover completely,
- ☞ Remove the tweezers **B**.

Changing a fuse

Before changing a fuse, the cause of the failure must be identified and rectified.

- ☞ Identify the faulty fuse by checking the condition of its filament.



Good



Failed

- ☞ Use the special tweezers to extract the fuse from its location.
- ☞ Always replace the faulty fuse with a fuse of the same rating.
- ☞ Check that the number etched on the box, the rating etched on the top and the tables below all agree.

Your vehicle's electrical system is designed to operate with standard or optional equipment.

Before installing other electrical equipment or accessories in your vehicle, contact a CITROËN dealer or a qualified workshop.

! CITROËN will not accept responsibility for the cost incurred in repairing your vehicle or for rectifying the malfunctions resulting from the installation of accessories not supplied and not recommended by CITROËN and not installed in accordance with its instructions, in particular when the consumption of all of the additional equipment connected exceeds 10 milliamperes.

The spare fuses are located on the engine compartment fusebox cover.

PRACTICAL INFORMATION

Dashboard fuses

The fuseboxes are placed in the lower dashboard behind the enclosed storage compartment (left-hand side).



Access to the fuses

- ☞ Open the cover A,
- ☞ Pull it towards you to extract it,
- ☞ Change the fuse (refer to the corresponding paragraph).



Fuse N°	Rating	Functions
1*	30 A	Heating.
2	15 A	Brake lamps, third brake lamp, built-in systems interface.
3	10 A	Rear foglamps.
4	30 A	Windscreen wipers and screenwash.
5	10 A	Diagnostic socket.
6	20 A	Central locking, door mirrors.
7	15 A	Audio equipment, telematics, multifunction screen, Bluetooth system.
8	7.5 A	Remote control key, air conditioning control unit, instrument panel, switch panel, steering mounted controls.
9	15 A	Multifunction screen, instrument panel.
10	15 A	Built-in systems interface.
11	15 A	Rear wiper.
12	7.5 A	Instrument panel, 4 wheel drive control unit, air conditioning control panel, ABS control unit, multifunction screen, automatic headlamp adjustment, heated seats, airbag control unit, steering wheel angle sensor, sunroof, rear screen demisting, remote control.
13	-	Not used.
14	10 A	Ignition switch.
15	20 A	Sunroof.
16	10 A	Door mirrors, audio equipment, telematics.

PRACTICAL INFORMATION

Access to the fuses

- ☞ Open the cover **A**,
- ☞ Pull it towards you to extract it,
- ☞ Change the fuse (refer to the corresponding paragraph).



Fuse N°	Rating	Functions
17	10 A	4 wheel drive control unit.
18	7.5 A	Reversing lamps, parking sensors control unit, reversing camera, airbag control unit.
19	15 A	Accessories socket.
20*	30 A	Electric window controls.
21*	30 A	Rear screen demisting.
22	7.5 A	Heated door mirrors.
23	-	Not used.
24	25 A	Driver's electric seat, footwell lighting, rear bench seat release.
25	30 A	Heated seats.

IX



* The maxi-fuses provide additional protection for the electrical systems. All work on the maxi-fuses must be carried out by a CITROËN dealer or a qualified workshop.

PRACTICAL INFORMATION

Engine compartment fuses

The fusebox is placed in the engine compartment near the battery (left-hand side).



Access to the fuses

- ☞ Open the bonnet (refer to the "Access" section),
- ☞ Press on the hook **A** to release the catch,
- ☞ Remove the cover completely,
- ☞ Change the fuse (refer to the corresponding paragraph),
- ☞ When you have finished, close the cover carefully to ensure sealing of the fusebox.

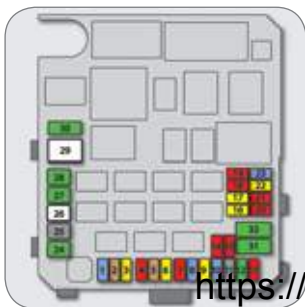

Fuse N°	Rating	Functions
1	15 A	Front foglamps.
2	7 A	Engine ECU 2.4 litre 16 V
3	20 A	CVT automatic gearbox ECU, CVT automatic gearbox relay
4	10 A	Horn.
5	7.5 A	Alternator 2.4 litre 16V
6	20 A	Headlamp wash.
7	10 A	Air conditioning.
8	15 A	Engine ECU 2.4 litre 16 V
9	-	Not used.
10	15 A	Demisting, wipers.
11	-	Not used.
12	-	Not used.
13	-	Not used.
14	10 A	Left-hand main beam headlamp.
15	10 A	Right-hand main beam headlamp.
16	20 A	Left-hand dipped beam headlamp (xenon).
17	20 A	Right-hand dipped beam headlamp (xenon).
18	10 A	Left-hand dipped beam headlamp, manual and automatic headlamp adjustment.
19	10 A	Right-hand dipped beam headlamp.
20	-	Not used.
21	10 A	Ignition coils

<https://www.automotive-manuals.net/>

PRACTICAL INFORMATION

Fuse N°	Rating	Functions
22	20 A	Engine control unit, water in Diesel sensor, injection pump (Diesel), air flow sensor, presence of water sensors, oxygen sensor, camshaft position sensor, canister purge electrovalve, vehicle speed sensor, variable valve timing (VTC) electrovalve, EGR electrovalve.
23	15 A	Petrol pump, fuel gauge.
24*	30 A	Starter motor.
25	-	Not used.
26*	40 A	ABS control unit, ASC control unit.
27*	30 A	ABS control unit, ASC control unit.
28*	30 A	Condenser fan.
29*	40 A	Radiator fan.
30	30 A	Passenger compartment fusebox.
31	30 A	Audio amplifier.
32	30 A	Engine control unit

! * The maxi-fuses provide additional protection for the electrical systems. All work on the maxi-fuses must be carried out by a CITROËN dealer or a qualified workshop.

Spare fuses

IX The spare fuses are located under the engine compartment fusebox cover.

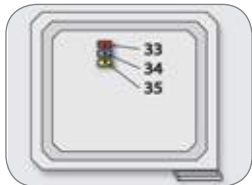

Fuse N°	Rating
33	10 A
34	15 A
35	20 A

The cover does not contain spare fuses with an amperage of 7.5 A, 25 A or 30 A. If one of the fuses with these amperages develops a fault, replace it with the following fuse:

A **7.5 A fuse** must be replaced with the **10 A spare fuse**, a **25 A fuse** with a **20 A spare fuse** and a **30 A fuse** with the **audio system fuse (N° 31)**.

<https://www.automotive-manuals.net/>

PRACTICAL INFORMATION

BATTERY

Access to the battery



The battery **A** is located under the bonnet on the left.

To gain access to it:

- ☞ open the bonnet using the interior release lever, then the exterior safety catch,
- ☞ secure the bonnet stay.

Starting using another battery

Looking for an earth point at the right-hand engine mounting

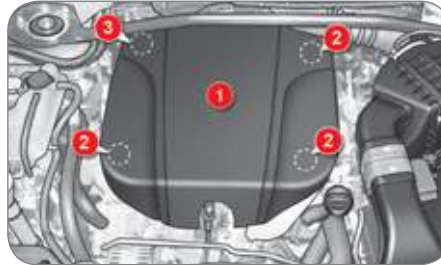

- ☞ Raise the front of the cover **1** to release the three clips **2**.
- ☞ Then pull the cover **1** towards you to release the clip **3** and remove the cover.

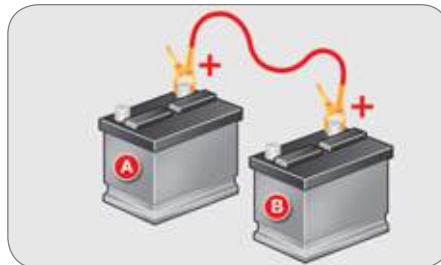

- ☞ Connect the red cable to the positive terminal (+) of the flat battery **A**, then to the positive terminal (+) of the slave battery **B**.

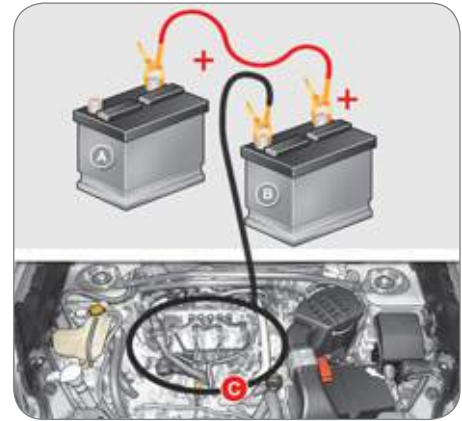

- ☞ Connect one end of the green or black cable to the negative terminal (-) of the slave battery **B**.
- ☞ Connect the other end of the green or black cable to an earth point **C** on the broken down vehicle, as far as possible from the battery (for example, right-hand engine mounting).
- ☞ Start the engine of the assisting vehicle.
- ☞ Operate the starter, let the engine run.
- ☞ Wait until the engine returns to idle and disconnect the cables.

Check the electrolyte level regularly. If necessary, top up the level with distilled water.

Charging the battery using a battery charger

- ☞ Disconnect the battery from the vehicle.
- ☞ Remove the battery and place it in a ventilated area.
- ☞ Remove the top-up caps and top up the level with distilled water if necessary.
- ☞ Connect the battery to the charger observing the instructions for use provided by the manufacturer and start charging.
- ☞ Disconnect the battery from the charger and let it to cool.
- ☞ If necessary, top up the level with distilled water.
- ☞ Clean the top of the battery carefully.
- ☞ Put the top-up caps back in place.
- ☞ Check that the terminals and connectors are clean. If they are covered with sulphate (whitish or greenish deposit), remove them and clean them.
- ☞ Reconnect the battery starting with the positive terminal (+).

When charging the battery, it is normal to observe an increase in temperature and bubbling of the electrolyte.



The batteries contain harmful substances such as sulphuric acid and lead. They must be disposed of in accordance with regulations and must not, in any circumstances, be discarded with household waste.

Take used remote control batteries and vehicle batteries to a special collection point.

It is advisable to disconnect the battery if the vehicle is to be left unused for more than one month.

Do not disconnect the terminals while the engine is running.



Do not charge the batteries without disconnecting the terminals first.

Before disconnecting the battery

Wait 2 minutes after switching off the ignition before disconnecting the battery.

Close the windows, the sunroof, the doors and the tailgate before disconnecting the battery.

Following reconnection of the battery

Following reconnection of the battery, switch on the ignition and wait 1 minute before starting to permit initialisation of the electronic systems. However, if slight difficulties are encountered following this operation, contact a CITROËN dealer or a qualified workshop.

Referring to the corresponding section, you must yourself reinitialise:

- the one-touch electric windows,
- the sunroof,
- the satellite navigation system.



Avoid prolonged contact of the electrolyte with the skin. Most of these fluids are harmful to health and very corrosive.

CHANGING A WIPER BLADE

Removing a front or rear wiper blade

- ☞ Raise the corresponding wiper arm.
- ☞ Remove the wiper blade, sliding it towards the outside.

Fitting a front or rear wiper blade

- ☞ At the front, check the size of the wiper blade as the shorter blade is fitted on the right-hand side of the vehicle.
- ☞ Put the corresponding new wiper blade in place and fix it.
- ☞ Fold down the wiper arm carefully.

TOWING

Access to the tools

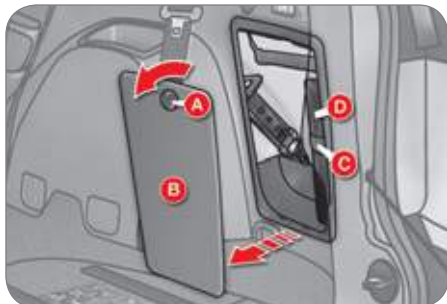

The towing eye and the tools are stored in the storage compartment in the right-hand boot trim.

To gain access to them:

- ☞ open the boot,
- ☞ turn button **A** to the left,
- ☞ remove the cover **B**,
- ☞ remove the fixing band **C** and take out the tool bag **D** containing the tools,
- ☞ take the towing eye and the tools required out of the tool bag.

Having your vehicle towed on a flatbed



- ☞ Below the front bumper, install the towing system on the towing eye **1**.

Place the gear lever in neutral.

! Always have the vehicle towed on a flatbed.

Never have the vehicle towed with the four wheels on the ground, this could damage the transmission.

The vehicle must not be towed with the front or rear wheels on the ground even if it is in front "2WD" (2 wheel drive) mode.

Towing another vehicle

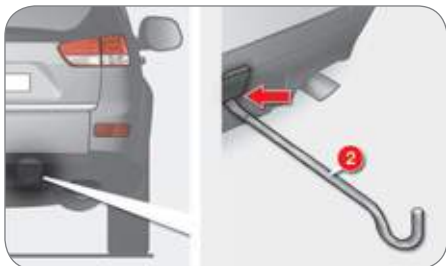

- ☞ On the rear bumper, remove the cover by pulling at the bottom using the jack handle **2**.

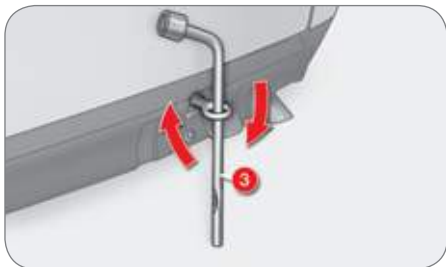

- ☞ Screw in the towing eye fully using the wheelbrace **3**.
- ☞ Install the towbar.
- ☞ Switch on the hazard warning lamps on the towed vehicle.



When being towed with the engine off, there is no longer any braking or steering assistance.

General recommendations

Observe the legislation in force in your country.

Ensure that the weight of the towing vehicle is higher than that of the towed vehicle.

The driver must stay at the wheel of the towed vehicle.

Driving on motorways and fast roads is prohibited when towing.

When towing a vehicle with all four wheels on the ground, always use an approved towing bar; rope and straps are prohibited.

When towing a vehicle with the engine off, there is no longer any power assistance for braking or steering.

In the following cases, you must always call on a professional recovery service:

- vehicle broken down on a motorway or fast road,
- when it is not possible to put the gearbox into neutral, unlock the steering, or release the parking brake,
- towing with only two wheels on the ground,
- where there is no approved towing bar available...

TOWING A TRAILER, CARAVAN, ETC.

Your vehicle is primarily designed for transporting people and luggage, but it may also be used for towing a trailer.



! We recommend the use of genuine CITROËN towbars and their harnesses that have been tested and approved from the design stage of your vehicle and that the fitting of the towbar is entrusted to a CITROËN dealer or a qualified workshop.

If the towbar is not fitted by a CITROËN dealer, it is imperative that it is fitted using the electrical pre-equipment located at the rear of the vehicle and in accordance with the manufacturer's instructions.

Driving with a trailer subjects the towing vehicle to more significant stress and its driver must be particularly careful.

Driving advice

Distribution of loads

☞ Distribute the load in the trailer so that the heaviest items are as close as possible to the axle and the nose weight approaches the maximum permitted without exceeding it.

Air density decreases with altitude, thus reducing engine performance. Above 1 000 metres, the maximum towing load must be reduced by 10 % of the GTW and so on for every 1 000 metres of altitude.

Refer to the "Technical Data" section for details of the weights and towing loads which apply to your vehicle.

Side wind

☞ Take into account the increased sensitivity to side wind.

Cooling

Towing a trailer on a slope increases the temperature of the coolant.

As the fan is electrically controlled, its cooling capacity is not dependent on the engine speed.

☞ To lower the engine speed, reduce your speed.

The maximum towing load on a long slope depends on the gradient and the outside temperature.

In all cases, pay attention to the coolant temperature.



☞ If this message is displayed, **stop your vehicle as soon as it is safe to do so.**

If the message flashes slowly, wait for the engine to cool before topping up the level, if necessary.

If the message flashes rapidly, contact a CITROËN dealer or a qualified workshop without delay.

Braking

Towing a trailer increases the braking distance.

Tyres

☞ Check the tyre pressures of the towing vehicle and of the trailer, observing the recommended pressures.

Lighting

☞ Check the lighting and signalling on the trailer.

! Opening of the lower tailgate is prohibited if a towbar is being used.



FITTING ROOF BARS

Consult a CITROËN dealer or a qualified workshop for the installation of longitudinal roof bars.

When fitting transverse roof bars, ensure that they are positioned correctly as shown by marks on the longitudinal roof bars.

Use accessories recommended by CITROËN and follow the accessory manufacturer's fitting instructions.

In order to place a load on the roof, your vehicle must be fitted with longitudinal roof bars with transverse roof bars fitted on top of these.

The longitudinal roof bars cannot be removed.

Maximum authorised weight on the roof bars, for a loading height not exceeding 40 cm (except bicycle carriers): 80 kg.

If the height exceeds 40 cm, adapt the speed of the vehicle to the condition of the road, to avoid damaging the roof bars and the fixings on the roof.

Please refer to national legislation to comply with the regulations regarding the transportation of objects which are longer than the vehicle.

IX

ACCESSORIES

A wide range of accessories and genuine parts is available from the CITROËN dealer network.

These accessories and parts have been tested and approved for reliability and safety.

They are all adapted to your vehicle and benefit from CITROËN's recommendation and warranty.

"Comfort":

rear parking sensors, side sun blinds, insulated module...

"Transports solutions":

boot liner, dog guard, roof bars, bicycle carrier for roof bars, ski carrier, roof box...

Trailer towbar which must be fitted by a CITROËN dealer or a qualified workshop.

"Style":

PVC door sill protectors, style rear mudflaps, Hortaz 18 inch alloy wheels, chromed door handle shells, diffuser on rear bumper, brushed aluminium look boot sill protector...

"Security and safety":

anti-intrusion alarm, glass etching, wheel security bolts, first aid kit, warning triangle, high visibility vest, stolen vehicle tracking system, child seats and booster cushions, under-inflation detection, anti-slip covers...

"Protection":

mat*, side protective mouldings...

"Multimedia":

MP3/USB audio systems, audio-telephone, amplifiers, satellite navigation systems, hands-free kit, speakers, DVD player, connection kit for MP3 player or portable CD player...

Installation of radio communication transmitters

Before installing any after-market radio communication transmitter, you can contact a CITROËN dealer for the specification of transmitters which can be fitted (frequency, maximum power, aerial position, specific installation requirements), in line with the Vehicle Electromagnetic Compatibility Directive (2004/104/EC).

Depending on the legislation in force in the country, it may be compulsory to have a high visibility safety vest, warning triangle and spare bulbs and fuses available in the vehicle.



The fitting of electrical equipment or accessories which are not recommended by CITROËN may result in a failure of your vehicle's electronic system and excessive electrical consumption.

Please note this precaution. You are advised to contact a CITROËN representative to be shown the range of recommended equipment and accessories.

* To prevent any risk of jamming of the pedals:

- ensure that the mat is positioned and secured correctly,
- never fit one mat on top of another.

TECHNICAL DATA

ENGINES AND GEARBOXES

Model codes	VUSFY0 - VVSFY0	VUSFY9 - VVSFY9	VU4HK8 - VV4HK8	VU4HK8 VU4HK8/1P VV4HK8 VV4HK8/1P
Engine	2.4 litre		2.2 litre HDi PEF	
Cubic capacity (cc)	2 360		2 179	
Bore x stroke (mm)	88 x 97		85 x 96	
EU standard maximum power (kW)	125		115	
Max power engine speed (rpm)	6 000		4 000	
EU standard max torque (Nm)	232		380	
Max torque engine speed (rpm)	4 100		2 000	
Fuel	Unleaded		Diesel	
Catalytic converter	yes		yes	
Particle emission filter (PEF)	no		yes	
Gearbox	Manual (5-speed)	CVT (6-speed)	Manual (6-speed)	DCS (6-speed)
Oil capacity (in litres)				
Engine	-		5.25	

X

TECHNICAL DATA

WEIGHTS AND TOWED LOADS (IN KG)

Engines	2.4 litre				2.2 litre HDi PEF			
Gearbox	Manual (5-speed)		CVT (6-speed)		Manual (6-speed)		DCS (6-speed)	
Model codes	VUSFY0	VVSFY0	VUSFY9	VVSFY9	VU4HK8	VV4HK8	VU4HK8/1P	VV4HK8/1P
Version	5 seats	7 seats	5 seats	7 seats	5 seats	7 seats	5 seats	7 seats
• Kerb weight*	1 650	1 685	1 680	1 715	1 790	1 825	1 810	1 845
• Gross vehicle weight (GVW)	2 290				2 410		2 410	
• Gross train weight (GTW)**	3 870				4 510		4 510	
• Unbraked trailer	750				750		750	
• Braked trailer***	1 500				2 000		2 000	
• Recommended nose weight	75				100		100	

* The kerb weight is equal to the weight without load + driver (75 kg).

**The speed of a towing vehicle must not exceed 60 mph (100 km/h) (comply with the legislation in force in your country).

*** The braked trailer value corresponds to the towing capacities of the vehicle on a 12 % gradient.

High ambient temperatures may result in a reduction in the performance of the vehicle in order to protect the engine; reduce the towed weight by 450 kg when your altitude increases by 1 000 m.

<https://www.automotive-manuals.net/>

TECHNICAL DATA

DIMENSIONS (IN MM)

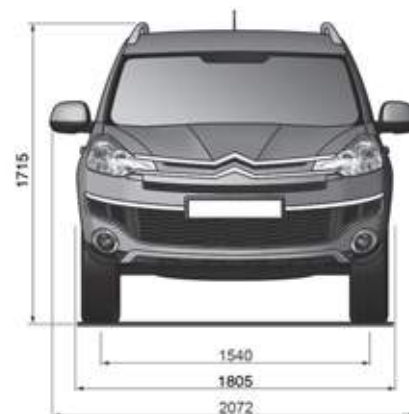

<https://www.automotive-manuals.net/>

IDENTIFICATION MARKINGS



A. Manufacturer's plate.

The Vehicle Identification Number (VIN) is indicated on a plate on the centre pillar, on the passenger's side.

B. Serial number under the bonnet.

The VIN is engraved on the bodywork near the windscreen.

C. Front number plate.

D. Tyres/paint label.

This label is affixed to the driver's door centre pillar.

It indicates the following information:

- tyre pressures, laden and unladen,
- wheel rim and tyre sizes,
- tyre pressure for the spare wheel,
- paint colour code.

The tyre pressures must be checked when cold at least once a month.



Low tyre pressures increase fuel consumption.

AUDIO and TELEMATICS

AUDIO CD SYSTEM

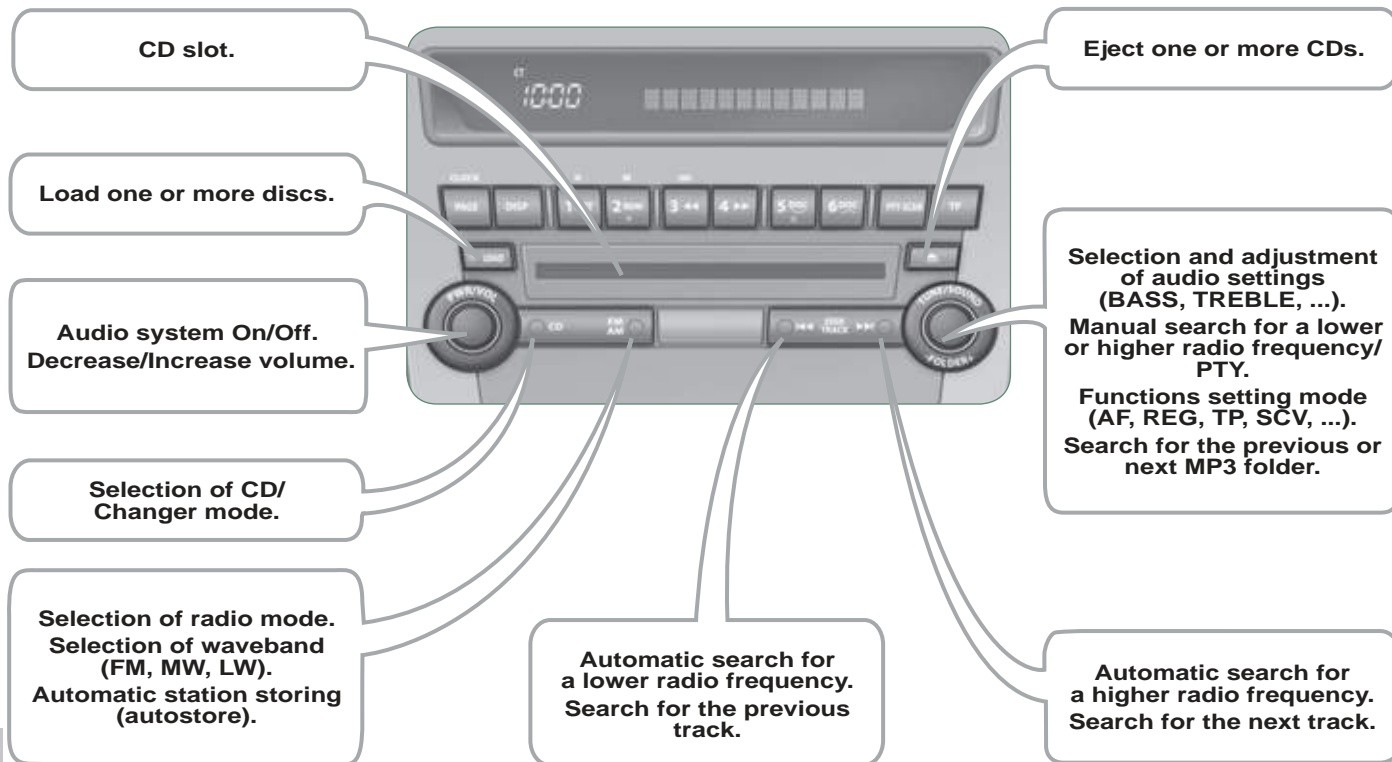

AUDIO and TELEMATICS

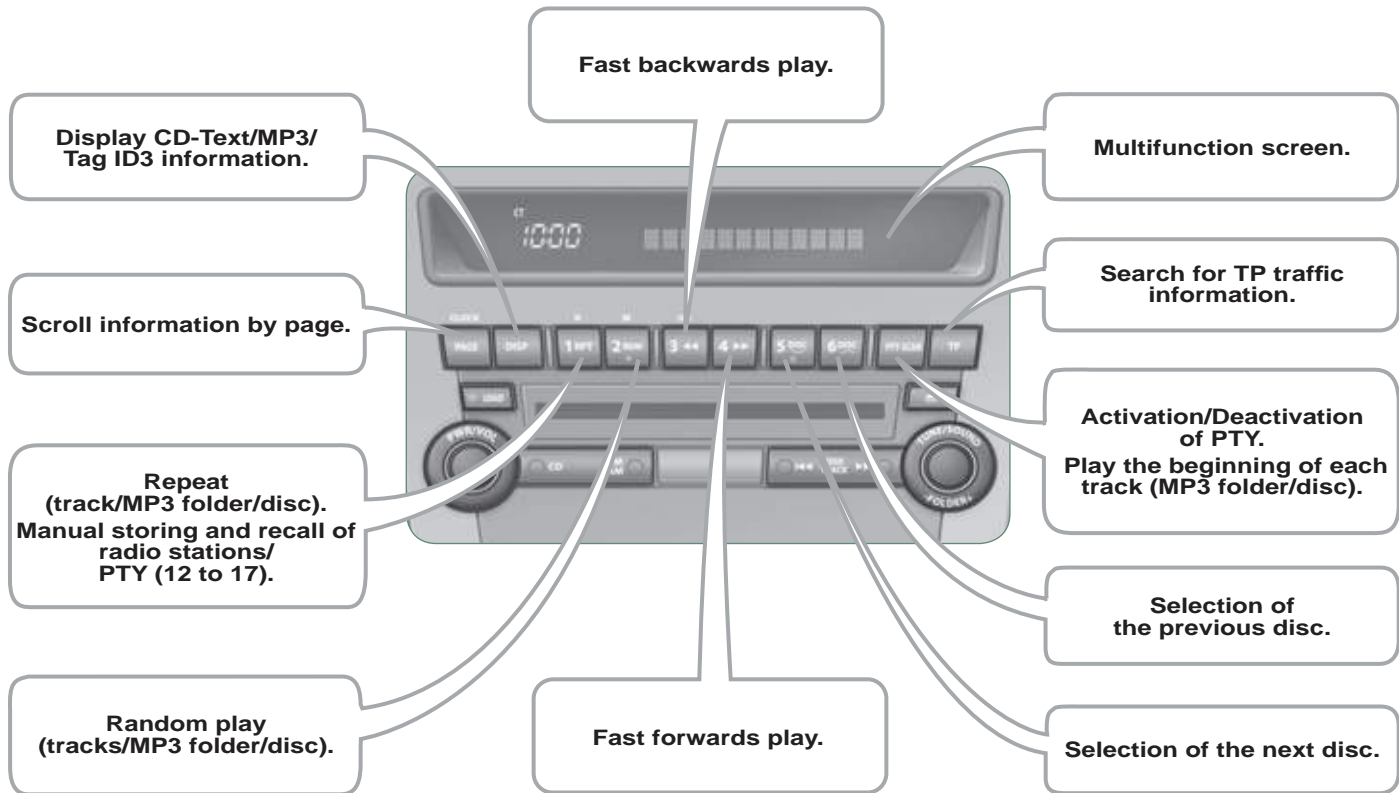

STEERING MOUNTED CONTROLS

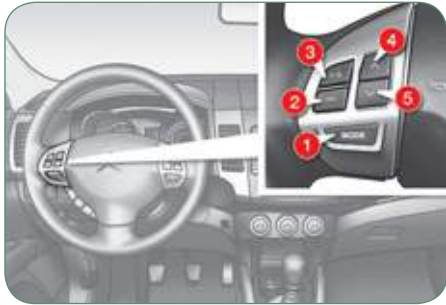

1. **On/Off and selection of radio or CD mode**
2. **Volume decrease**
3. **Volume increase**
4. **Search for a higher radio frequency/
Next track/Fast forwards play**
5. **Search for a lower radio frequency/
Previous track/Fast backwards play**

They can be used when the ignition switch is in the "ON" or "ACC" position.

Switching on

Press button **1** for more than two seconds. The last source selected before switching off comes back into operation.

Switching off

Press button **1** for more than two seconds.

Selecting the source

Press button **1**.

The source changes in the following order: FM1/FM2/FM3/MW/LW/CD/FM1...

Adjusting the volume

Press and hold button **2** or **3** to decrease or increase the volume respectively.

Searching in radio mode

Press button **4** or **5** to search for a higher or lower radio frequency respectively.

Searching in CD mode

Press button **4** or **5** to select the next or previous track on the CD respectively. Press and hold button **4** or **5** for fast forwards or fast backwards playing of the current track of the CD respectively.

While a track is being played, press button **5** once to return to the beginning of this track.

GENERAL FUNCTIONS

Switching on



Press the "PWR" button. The last source selected before switching off resumes operation.

The audio equipment functions can be used when the ignition switch is in the "ON" or "ACC" position.

Switching off

Press the "PWR" button again.

Adjusting the volume



Turn the "VOL" dial respectively to the left to decrease the volume or to the right to increase it.

Setting the audio modes



Press the "SOUND" button several times; the audio modes change in the following order:

SUB PUNCH/TYPE/FIELD/
BASS/MID/TREBLE/FAD-
ER/BALANCE/OFF.

Quick access mode

To access the personalised sound functions quickly, press and hold this button, then turn it to reach the personalised sound setting of your choice.

Release the button to store the setting.

"Hold" mode

If you press this button for more than 2 seconds in the audio setting mode, the system switches to "Hold" mode. The audio mode selected will be retained until you press this button again for more than 2 seconds.

Selecting the musical ambience "TYPE"



Turn the "SOUND" dial; the musical ambiances change in the following order:

CLASSIC/JAZZ/POP/ROCK/
HIP-HOP.

Once the ambience has been selected, press the "SOUND" button to confirm.

"CLASSIC": optimises the acoustics to obtain perfect equalisation of the sound for classical music.

"JAZZ": optimises the acoustics to obtain an ambient sound with specific modulations in the bass, mid tone and treble for jazz.

"POP": optimises the acoustics to obtain clear vocals and modulation of the bass and treble for pop music.

"ROCK": optimises the acoustics to obtain a sound in harmony with the rhythm which places the emphasis on the mid tone for rock music.

"HIP-HOP": optimises the acoustics to obtain a powerful sound and accentuation of the bass for hip-hop music.

The audio setting mode is deactivated when the radio is operated or a CD is played or after approximately 10 seconds without any action.

If the "TYPE" is changed, the sound cuts out briefly.

Selecting the surround effect "FIELD"



Turn the "SOUND" dial; the surround effects change in the following order:
NORMAL/STAGE/LIVE/HALL.

Once the surround effect has been selected, press the "SOUND" button to confirm.

"NORMAL": produces a sound in which the voices are at the front and the instruments surround the listener.

"STAGE": produces a sound in which the voices are immediately facing the listener, as on a stage.

"LIVE": produces a sound similar to that of a live show, in which the sound reaches the listener from all directions.

"HALL": produces a sound similar to that of a concert hall with deflection of the sound.

Setting the bass "BASS"



Turn the "SOUND" dial to set the required bass value.

Setting the mid tone "MID"

Turn the "SOUND" dial to set the required mid tone value.

Setting the treble "TREBLE"

Turn the "SOUND" dial to set the required treble value.

Setting the front/rear sound distribution "FADER"

Turn the "SOUND" dial to set the balance of the volume of the front and rear speakers.

Setting the right/left sound distribution "BALANCE"

Turn the "SOUND" dial to set the balance of the volume of the right and left speakers.

Setting the volume of the bass unit "SUB PUNCH"

Turn the "SOUND" dial to set the volume of the bass unit.

Only vehicles fitted with the "Premium Sound" system can offer the "SUB PUNCH" setting.

If the "SUB PUNCH" is changed, the sound cuts out briefly.

Automatic volume adjustment "SCV"

This permits automatic adjustment of the "VOLUME", "BASS", "MID" and "TREBLE" settings in relation to the vehicle speed.



Press the "SOUND" button for more than two seconds to gain access to the functions setting mode.

Then, press this same button several times; the functions

setting mode changes in the following order:

AF/CT/REG/TP-S/PTY (languages)/SCV/PHONE/OFF.

Turn the "SOUND" dial respectively to the left to deactivate the function or to the right to activate it.

XI

If the "FIELD" is changed, the sound cuts out briefly.

If the value "0" is set, an audible signal will be heard.

RADIO

Selecting radio mode



Press the "PWR" button or the "AM/FM" button to switch on the radio.

Selecting the waveband



Press the "AM/FM" button several times in succession to select the waveband; it changes in the following order: FM1/FM2/FM3/MW/LW/FM1...

Automatic station search



Press the "SEEK ◀◀" or "SEEK ▶▶" button to search the lower frequencies or the higher frequencies respectively.

The search begins automatically and stops at the first station found.

Manual station search



Turn the "TUNE" dial respectively to the left to search the lower frequencies or to the right to search the higher frequencies.

Manual station storing

You can store up to six stations on each waveband.

Storing a new station replaces the previous station.



Press one of the six buttons "1" to "6" until an audible signal is heard.

The sound cuts out then becomes audible again when the station has been stored.

The number of the button and the associated radio frequency appear on the screen.

To recall the pre-set stored setting, press the button and release it within two seconds.

Automatic station storing

Stations can only be stored automatically on wavebands FM3, MW and LW. Storing new stations replaces the previous stations.

This storing can be activated automatically irrespective of the waveband selected.



Press the "AM/FM" button for more than two seconds.

The six stations offering the best reception are stored and classified from the weakest to the strongest on the six corresponding buttons.

Recalling stored stations



Press one of the six buttons "1" to "6". The station corresponding to the waveband selected appears on the screen.

Disconnecting the battery terminals clears the stored radio stations.

"RDS"

The "Radio Data System" (RDS) function on the FM waveband permits:

- access to the display of information, such as the name of the station, ...
- tuning to the same station while travelling through different regions,
- temporary tuning to traffic information announcements.

Most FM stations use RDS. These stations transmit non-audible data in addition to their programmes.

The data transmitted in this way allows you access to various functions, mainly displaying of the name of the station, automatic station following or temporary tuning to traffic information announcements.

The RDS allows you to continue listening to the same station by means of the alternative frequency following. However, in certain conditions, this RDS frequency following cannot be provided throughout the country. Radio stations do not cover the whole country, which explains the loss of reception of the station during a journey.



The "AF", "REG" and "TP" functions can be deactivated or activated via the "TUNE" button functions setting mode.

Alternative frequencies "AF"

Your radio automatically checks and selects the best frequency for the radio station to which it is tuned (if the station broadcasts on several transmitters or frequencies).

The frequency of a radio station covers approximately 30 miles (50 km). The change from one frequency to another explains the temporary loss of reception during a journey.

If the station to which you are listening does not have several frequencies in the region in which you are currently located, you can deactivate the alternative frequency following.

Regional following mode "REG"

Some stations are organised in a network. In different regions, they broadcast different or shared programmes depending on the time of day.

You can follow:

- a regional station only,
- the entire network, with the possibility that you will be listening to a different programme.

On long distance journeys, when the stored station becomes weak, the radio searches first for another frequency for the same station (AF). Then, if this fails, it searches for a frequency broadcasting the regional programme (REG). If this also fails, the radio returns to the stored station.

Traffic information "TP"

The "Traffic Program" (TP) function permits automatic and temporary switching to an FM station broadcasting traffic information.

The radio station or the source that you are listening to at this point is paused.

Once the traffic information has ended, the system switches back to the radio station or the source that you were listening to initially.



Press the "TP" button.

"TP" appears on the display. If the station is compatible, "RDS" also appears.

If the radio detects traffic information, "TRAF INF" appears on the display, followed by the frequency of the broadcasting station, then its name.

The volume is different from that of the previous source.

Following the broadcasting of the traffic information, the volume returns to that of the source prior to the interruption.

When "TP" appears on the display, the radio stops solely at RDS stations broadcasting traffic information.

Emergency broadcasts "ALERT"

An emergency broadcast automatically and temporarily interrupts the FM station or the source that you are listening to.

The message "ALERT" appears on the display and the volume is different from that of the previous source.

Following the emergency broadcast, the message disappears and the volume returns to that of the source prior to the interruption.

Themed type of programme "PTY"

Some stations offer the option of listening to a themed type of programme as a priority, selected from the list available below:

NEWS, AFFAIRS, INFO, SPORT, EDUCATE, DRAMA, CULTURE, SCIENCE, VARIED, POP M, ROCK M, EASY M, LIGHT M, CLASSICS, OTHER M, WEATHER, FINANCE, CHILDREN, SOCIAL, RELIGION, PHONE IN, TRAVEL, LEISURE, JAZZ, COUNTRY, NATION M, OLDIES, FOLK M, DOCUMENT.

Search for a "PTY" broadcast



Press the "PTY" button.

Turn the "TUNE" dial to select the type of programme required.

Two seconds later, the radio searches for a broadcast which corresponds to your selection; the type of PTY selected flashes on the display.

Once the station has been found, its name appears on the display.

You can press the "SEEK ◀" or "SEEK ▶" buttons to find another station.

If no station is found corresponding to your selected type of programme, "NONE" appears on the display for five seconds and the radio returns to the previous station.

Storing a "PTY" programme

You can store up to six PTY programmes. Each new programme stored replaces the previous one.



Turn the "TUNE" dial to set the PTY programme to be stored.

Press one of the six buttons "1" to "6" for more than two seconds.



The sound cuts out then becomes audible again when the programme has been stored.

The number of the button and the associated PTY programme appear on the display.

To recall the pre-set memory setting, press the button and release it within two seconds.

Changing the display language of the "PTY" programme



Press the "TUNE" button for more than two seconds to access the functions setting mode.

Then, press this button several times in succession; the functions setting mode changes in the following order:

AF/CT/REG/TP-S/PTY (languages)/SCV/PHONE/OFF.

Turn the "TUNE" dial to the left or to the right to select the language (ENGLISH, FRANCAIS, DEUTSCH, SVENSK, ESPAGNOL, ITALIANO).

Functions setting mode

This permits activation or deactivation of the functions below.



Press the "TUNE" button for more than two seconds to access the functions setting mode.

Then, press this button several times in succession; the functions setting mode changes in the following order:

AF/CT/REG/TO-S/PTY (languages)/SCV/PHONE/OFF.

Turn the "TUNE" dial respectively to the left to deactivate the function ("OFF") or to the right to activate it ("ON").

CD PLAYER

This can play audio CDs (CD-DA, CD-Text, CD-R/RW) or MP3 CDs.

Selecting CD mode

After inserting a disc, printed face upwards, the player starts automatically.



If the player already contains a disc, press the "CD" button.

"CD", the track number and the playing time appear on the screen.

Insert circular compact discs only.
8 cm compact discs must be inserted in the centre of the player slot.

Ejecting a disc



Press this button to remove the disc from the player. The system automatically switches to radio mode.

Once ejected, if the compact disc is not removed within fifteen seconds, it is reloaded into the player.

Audio CDs

Fast search

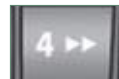

Press and hold button "4" or "▶▶" to carry out a fast backwards or forwards search respectively.

Play begins when the button is released.

Selecting a track



Press button "◀◀" or "▶▶" to select the previous or next track respectively.

Repeating a track

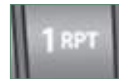

Press the "RPT" button to repeat the play of the current track. "RPT" appears on the screen.

To exit this mode, press this button again.

Random playing of a disc

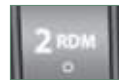

Press the "RDM" button to start random play of the tracks on the disc. "RDM" appears on the screen.

To exit this mode, press this button again.

The "PHONE" is not operational at present.

The functions setting mode is deactivated after approximately 10 seconds without any action.

Playing the beginning of each track



Press the "SCAN" button to start playback of the first ten seconds of each track on the disc. "SCAN" appears on the screen and the corresponding track number flashes.

To exit this mode, press this button again.

On CD-R/RWs, the quality of the playback sound depends on the encoding software, the burning device and the burning speed used.

CD-TEXT DISPLAY

The CD player and the CD changer are compatible with the display of CD-Text information.

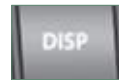

Press the "DISP" button several times in succession; the CD-Text information appears in the following order:

DISC NAME/TRACK NAME/NORMAL DISPLAY MODE.



If the information exceeds 12 characters, press the "PAGE" button to see the rest.

In the absence of CD-Text information to be displayed, "NOTITLE" appears on the screen.

MP3/TAG ID3 CD

The CD player and the CD changer are compatible with the playing of MP3 files.

These must be recorded in ISO9660 Level 1/Level 2, Joliet or Romeo format on CD ROMs, CD-Rs or CD-RWs. The CDs can contain a maximum of 255 files and 100 folders on 16 levels.

The Tag ID3 version 1 can be displayed while playing MP3 files.

In the case of compact discs containing both CD-DA and MP3 files, play automatically begins with the CD-DA files.

To switch play between the two types of file, press the "CD" button for more than two seconds until an audible signal is heard.

While using these compact discs, the "Repeat", "Random play" and "Playing of the beginning of the tracks" functions are only applied to files of the same format.

Selecting an MP3 folder



Turn the "FOLDER" dial respectively to the right to select a folder in ascending order or to the left to select a folder in descending order.

Repeating the tracks in a folder



Press the "RPT" button for more than two seconds to repeat the playing of the tracks contained in the current folder. "D-RPT" appears in the screen.

To exit this mode, press this button again.

Random playing of a folder



Press the "RDM" button to start random playing of the tracks in the current folder. "RDM" appears in the screen.

To exit this mode, press this button again.

Random playing of a disc



Press the "RDM" button for more than two seconds to start random playing of the tracks in all of the folders. "D-RDM" appears in the screen.

To exit this mode, press this button again.

Playing the beginning of each track



Press the "SCAN" button to start playing the first ten seconds of each track in all of the folders. "SCAN" appears in the screen and the corresponding track number flashes.

To exit this mode, press this button again.

MP3/Tag ID3 display

When play begins, "READING" appears in the screen then disappears to make way for the folder number, the track number, the playing time and "MP3".



Press the "DISP" button several times in succession; the MP3 information appears in the following order:

FOLDER NAME/TRACK NAME/NORMAL DISPLAY MODE.



Press the "DISP" button for more than two seconds to activate the Tag ID3 information. "TAG" appears in the screen.

Press the "DISP" button several times in succession; the Tag ID3 information appears in the following order:

ALBUM NAME/TRACK NAME/ARTIST NAME/NORMAL DISPLAY MODE.

To deactivate this information, press the "DISP" button again for more than two seconds.



If the information exceeds 12 characters, press the "PAGE" button to see the rest.

In the absence of MP3 or Tag ID3 information to be displayed, "NOTITLE" appears in the screen.

On CD-R/RWs, the quality of the playing sound depends on the encoding software, the burning device and the burning speed used.

Depending on the flow chart of the MP3 folders and files on the disc, play may not begin immediately.

CD CHANGER

See also "CD-Text display" and "MP3/Tag ID3 CD".

Selecting changer mode

After inserting at least one disc, printed face upwards, the changer starts automatically.



If the changer already contains a disc, press the "CD" button.

"CD", the disc and track numbers and the playing time appear in the screen.

Loading a disc

The CD changer can hold up to 6 CDs.

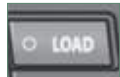

Press the "LOAD" button briefly. "WAIT" appears on the display.

When the changer is ready, the indicator lamp on the "LOAD" button comes on and "LOAD DISC N° (1-6)" appears in the screen.

If several slots are empty, select one using one of the "DISC" buttons.

Insert circular compact discs only.
8 cm compact discs cannot be played by the changer.

Loading all of the discs



Press the "LOAD" button for more than two seconds.

The changer selects an empty slot number from the lowest to the highest and switches to waiting for loading mode.

"LOAD DISC N° (1-6)" appears on the display; insert the disc in the corresponding slot.

The changer automatically selects the next empty slot number and returns to waiting for loading mode.

Repeat these steps until loading is complete. Play begins with the last disc inserted.

Ejecting a disc



Press this button briefly to remove the current disc from the changer.

Ejecting all of the discs



Press this button for more than two seconds. The current disc is ejected.

Once this disc has been removed, the next disc is ejected automatically in its turn.

Repeat these steps until unloading is complete.

Once ejected, if the compact disc is not removed within fifteen seconds it is re-loaded into the changer.

Selecting a disc



Press one of the "DISC" buttons several times in succession until you reach the disc required. The symbol of the disc selected appears in the screen.

Audio CD

Fast search



Press and hold button "◀◀" or "▶▶" to carry out a fast backwards or forwards search respectively.

Play begins when the button is released.

Selecting a track



Press button "◀◀" or "▶▶" to select the previous track or next track respectively.

Repeating a track



Press the "RPT" button to repeat the playing of the current track. "RPT" appears in the screen.

To exit this mode, press this button again.

Repeating a disc



Press the "RPT" button for more than two seconds to repeat the playing of the tracks of the current disc. "D-RPT" appears in the screen.

To exit this mode, press this button again.

Random playing of a disc



Press the "RDM" button to start random playing of the tracks on the disc. "RDM" appears in the screen.

To exit this mode, press this button again.

Random playing on all of the discs



Press the "RDM" button for more than two seconds to start random playing of the tracks on all of the discs. "D-RDM" appears in the screen.

To exit this mode, press this button again.

Playing of the beginning of each track



Press the "SCAN" button to start play of the first ten seconds of each track on the disc. "SCAN" appears in the screen and the corresponding track number flashes.

To exit this mode, press this button again.

On CD-R/RWs, the playback sound quality depends on the encoding software, the burning device and the burning speed used.

AUDIO and TELEMATICS

ERROR MESSAGES

If an error message appears on the screen, refer to the table below to find out what it means and the solution to be applied in order to rectify it.

TEXT	DESCRIPTION	SOLUTION
NO DISC	No disc present. Disc not compatible.	Insert a disc.
ERROR 01	Disc inserted incorrectly. Disc with condensation.	Insert the disc with the printed face upwards. Clean the dampness off the disc.
ERROR 02	Disc dirty, scratched or distorted. Excessive vehicle vibration.	Clean or replace the disc. Try again when the vibration has stopped.
ERROR 03	Error on insertion or ejection. Playing head misaligned.	Eject the disc and insert it again. If it is not ejected, have the audio equipment checked.
ERROR HOT	Triggering of the internal protection against high temperatures.	Wait approximately 30 minutes to allow the audio system to cool.
ERROR	Communication error between the audio system and the external system. External system supply error.	Consult a CITROËN dealer.

AUDIO and TELEMATICS

AUDIO-TELEMATIC SYSTEM

AUDIO: selection of Audio-video (FM, CD, music server, ...) or Navigation (map) display.

VOL: adjustment of audio-video volume.

POWER: audio system on/off (only).

Mute on/off.
Next or previous selection for:

- a radio station,
- an audio track (CD),
- a chapter (DVD).

Setting the audio volume.

Changing the audio-video source (FM, CD, music server, ...).



SCALE: changing the scale of the map.

ENT: confirms the choice of the item selected on the screen.
For certain operations, confirmation is given by contact with the touch screen.

Scrolling the map displayed or selection of an item.



OPEN: tilts the screen and permits access to the CD/DVD. A second press closes the screen.



Move a finger over the screen to operate the system.

Use the buttons offered on the screen.



! For safety reasons, the driver must only carry out operations which require prolonged attention with the vehicle stationary.

AUDIO and TELEMATICS

DESCRIPTION OF THE CONTROLS - MENUS



MODE: **Audio-video** menu for:

- radio,
- audio, MP3 or WMA CD,
- music server,
- DVD.



SET: **Settings** menu for:

- switching off the screen,
- selecting the sound setting,
- selecting the picture quality,
- selecting the language, the time zone or the units,
- selecting the size of the DVD picture,
- selecting the guidance voice, the screen colour schemes or display of the audio-video icon,
- setting certain equipment available in your vehicle.



INFO: **Information** menu for the consultation or adjustment of certain settings for your vehicle.



MENU: **Navigation-guidance** menu for selecting:

- a destination,
- a point of interest (POI),
- an advanced search by POI,
- one of the 20 previous destinations,
- an address stored in the address book,
- the return home,
- certain navigation settings,
- a route demonstration.



NAVI: display of the current location on the **map**.

NAVIGATION-GUIDANCE

GPS

What is the navigation system and the GPS?

The satellite navigation system guides the driver to the destination that he has set in accordance with a chosen route.

Initially, it searches for the destination required by the user, then it calculates the route and finally it provides the visual and audible guidance instructions.



The GPS (Global Positioning System) consists of several satellites distributed around the earth. They continuously transmit digital signals which travel at the speed of light, on 2 different frequencies.

At any given time, the system receives its position in relation to the satellites detected and the time of transmission of the signal.

This enables the telematic unit to calculate its position and therefore that of the vehicle.

A repositioning process using the map database stored on the hard disk allows the vehicle to be positioned on the road network, so improving the accuracy of the vehicle location function.

What precautions should be observed in order to make best use of the system?

Do not place anything on or near the GPS aerial.

Do not use any digital communication equipment (personal computers, etc.) near the GPS aerial.

Do not affix any reflective films or films containing carbon to the windows.

The system's measurements may be inaccurate if the vehicle is:

- in a tunnel or underground car park,
- underneath a two-level motorway,
- in an area with several very high buildings,
- surrounded by closely planted trees.

Depending on the vehicle's situation and the reception of the GPS information, the displayed information may disappear from the screen temporarily.

What is a point of interest (POI)?



A point of interest (POI) is represented by an icon on the map, it represents an airport, a station, a town hall, ...



Up to 40 different icons may be displayed (refer to the section "Points of interest icon").

They are classified in 5 groups and identified by one colour for each group:

- Shops, finance and businesses (Green),
- Vehicles and travel (Dark blue),
- Restaurants (Orange),
- Public places and emergency services (Brown),
- Entertainment and attractions (Blue).

AUDIO and TELEMATICS

Information displayed on the map during navigation

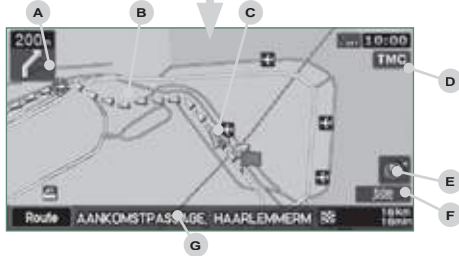

Single map display.

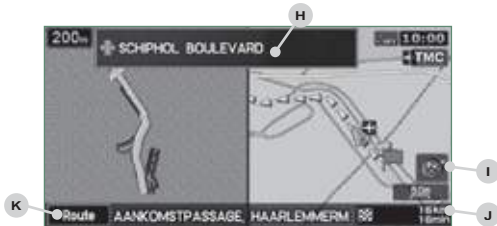

Two-map display.

- A. Manoeuvre icon: indicates whether the driver should turn left or right at the next junction indicated by the guidance and the distance to this junction.
- B. Guidance route: indicates the route to the destination.
- C. Vehicle marker: indicates the position of the vehicle while driving.
- D. TMC icon: displays traffic information such as traffic jams, road works, etc.
When the icon is touched, detailed TMC information can be viewed.
- E. Orientation mark: indicates the orientation of the map displayed.
- F. Map scale: indicates the scale of the map displayed.
- G. Name of the street: indicates the name of the current street.
- H. Direction frame: displays the number of the next road or the name of the next street which the driver should turn into.
- I. Destination/intermediate destination icon: indicates the direction of the destination or intermediate destination.

- J. Destination/intermediate destination information: indicates the distance and the time remaining until the destination or intermediate destination is reached.

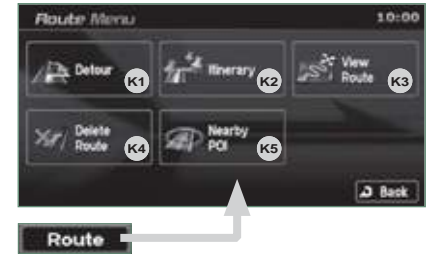

- K. Press for access to the **Route Menu** in order to:
 - K1 - change the route in favour of another making a detour through a specified region,
 - K2 - change the position of the destination, add an intermediate destination and change the route calculation conditions,
 - K3 - display a route by various methods,
 - K4 - delete a route created,
 - K5 - search for points of interest (POI) around the current location.

AUDIO and TELEMATICS

Searching for a destination using an address or points of interest (POI)



A - Select a location using the address or street name of the destination. Select:

A1 - the country,

A2 - the city,

A3 - the street,

A4 - the house number,

A5 - the name of a junction,

A6 - to select the search using either a number or a junction.

B - Select a location using the name of a point of interest (POI). Select:

B1 - the country,

B2 - the city,

B3 - the name of a stored POI,

B4 - a POI category (airport, bowling alley, bus station, car park, service station, hotel, cinema, ...),

B5 - a detailed POI list.

C - Select a location using an advanced search based on a POI:

C1 - around the current location,

C2 - on the current route,

C3 - in the vicinity of the destination,

C4 - on a chosen street,

C5 - along a motorway or in the vicinity of the exit,

C6 - by scrolling the map,

C7 - taking the point of departure of the current route,

C8 - specifying the latitude/longitude coordinates.



AUDIO and TELEMATICS

Searching using previous destinations, a stored address or a return home

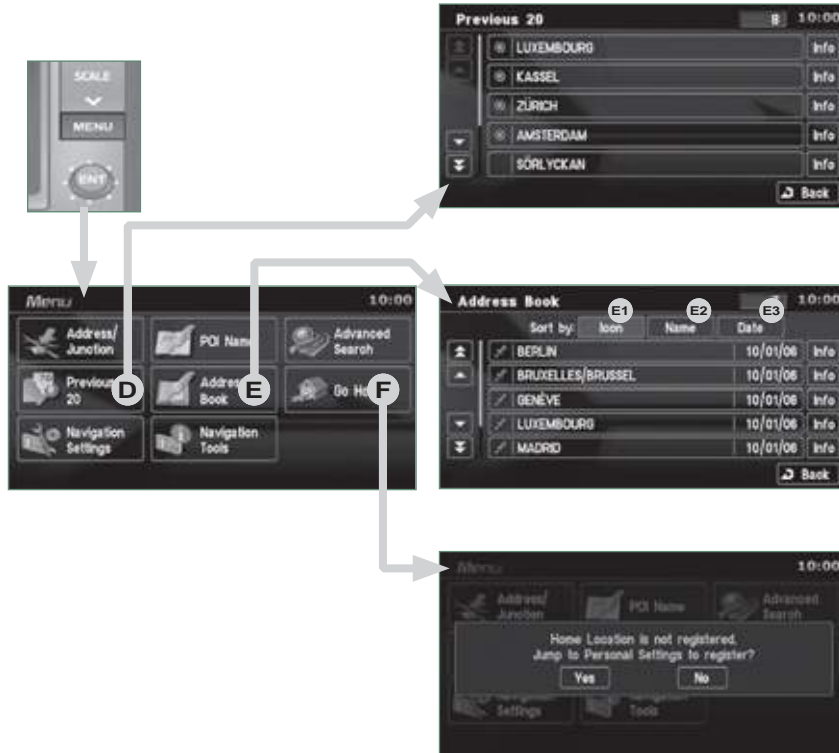

D - Select a location using one of the 20 previous destinations.

E - Select a location using an address stored in the address book. Sort by:

E1 - Icon,

E2 - Name,

E3 - Date.

F - Select a return home directly. Press YES to store your home address (the first time).

AUDIO and TELEMATICS

Navigation settings and information (1/2)

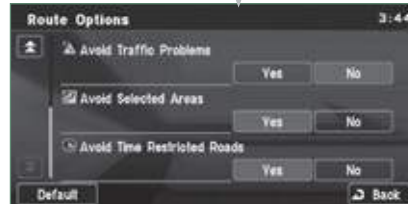

- G - Select the settings of functions linked with the navigation to:
 - G1 - set the screen display parameters such as:
 - display 1 or 2 maps,
 - display or do not display the POIs on the map, display selected icons,
 - change the colours of the map,
 - display or do not display the name of the current street.
 - display or do not display the address of the current street.
 - G2 - set route conditions, such as,
 - avoiding traffic problems,
 - avoiding selected areas,
 - avoiding roads at a certain time.
 - G3 - set the route guidance mode and the displaying of the results of the route search,
 - G4 - save, change or delete a location in the address book,
 - G5 - display and select the traffic information such as traffic jams or road works by selecting dynamic guidance.

AUDIO and TELEMATICS

Navigation settings and information (2/2)

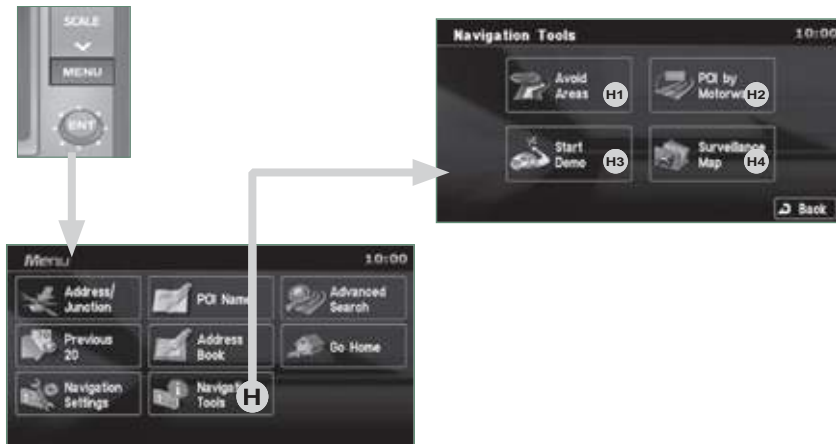

- H - Select basic information relating to the navigation as well as a pre-set route demonstration to:
- H1 - choose to divert your route to avoid certain areas,
- H2 - select a location using an advanced search based on a POI along a motorway or in the vicinity of the motorway exit,
- H3 - start/stop the demonstration,
- H4 - recall a stored map screen.

AUDIO and TELEMATICS

Selecting points of interest (POI) icons displayed on the map



You can select up to 40 types of point of interest icon which are displayed on your map screen.

Press the MENU button then [Navigation Settings].



Press [Screen] then [Select] on the POI line.

Press [4] which is displayed.



Press each POI required.

At each contact with a POI, the display of [α] changes (α = the POI will be displayed on the screen).

General

	Town centre
	Locality

Shops, finance and businesses (Green)

	Major companies
	Shopping centre

Vehicles and travel (Dark blue)

	CITROËN
	Airport
	Bus stop
	Vehicle hire
	Suburban station/station
	Ferry terminal
	Hotel
	Park and ride
	Car park (press +)
	Service station
	Rest area
	Toll booth
	Tourist information
	Railway station

Restaurant (Orange)

	Night life/night club
--	-----------------------

Public places and emergency services (Brown)















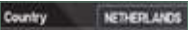

	Town Hall
	Community centre
	Convention/exhibition centre
	Hospital
	University/college

Entertainment and attractions (Blue)

	Theme park
	Bowling alley
	Casino
	Cinema
	Golf course
	Historical monument
	Skating rink
	Marina
	Museum
	Flying club
	Leisure area
	Ski station
	Sports centre
	Theatre/opera
	Tourist attraction
	Vineyard/wine and spirit store





AUDIO and TELEMATICS

Entering an address and starting guidance (1/2)

Press	Explanations	Result
	Press the MENU button.	
	Press [Address/Junction].	
	Press [Country] and enter the name of the country using the touch keypad. When a character of the name of the country is entered, if 5 countries or fewer are recognised, you can select a country from a list which is displayed or press [List].	
  You can select one of the 5 most recently selected countries by pressing [Last 5] on the "Country" line.		
	Press [City] then [Keyword] and enter the name of the city using the touch keypad. When a character of the name of the city is entered, if 5 cities or fewer are recognised, you can select a city from a list which is displayed or press [List].	
  You can select a city using the post code. Press [Post Code] and enter the number.		
  You can select one of the 5 most recently selected cities by pressing [Last 5] on the "City" line.		

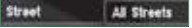

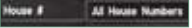

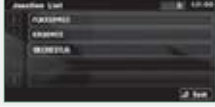
AUDIO and TELEMATICS

Entering an address and starting guidance (2/2)

Press	Explanations	Result
	<p>Press [Street] and enter the name of a street using the touch keypad. When a character of the name of the street is entered, if 5 streets or fewer are recognised, you can select a street from a list which is displayed or press [List].</p>	
	<p>Press [House #] and enter the number of the house using the touch keypad.</p>	
	<p>You can enter the name of a junction instead of the number of the street. Press [Junction] and select the name from a list which is displayed.</p>	

This is the result once all of the information has been entered:









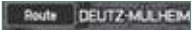

	<p>If you agree with the information press [Set], otherwise press one of the buttons to correct.</p>	
	<p>Press [Start] to start the navigation.</p>	

AUDIO and TELEMATICS

Traffic information

During navigation, the system gives you traffic information received in real time. The system can then suggest a detour route, if dynamic guidance has been activated by pressing MENU, [Navigation settings] then [TMC].



Press	Explanations	Result
	Press [Route].	
	Press [Display new route]. The system offers a detour route (dynamic guidance).	
	Press [Back] and enter to return to the previous screen. The system asks you to confirm or not the new route.	
	Press [Yes] to confirm your choice. The system displays the name of the new route. Press [No] to not register the route.	

AUDIO-VIDEO

Radio, RDS, AF, REG, TP, PTY

What is RDS?

- RDS** Radio Data System (RDS) function on the FM waveband permits:
- tuning to the same station while travelling through different regions (if the transmitters of this station cover the area through which you are travelling),
 - temporary tuning to traffic information announcements,
 - display of the name of the station, etc...

Most FM stations use RDS.

These stations transmit non-audible data in addition to their programmes.

The data transmitted in this way allows you access to various functions, mainly displaying of the name of the station, temporary tuning to traffic information announcements or automatic station following.

RDS allows you to continue listening to the same station by means of the frequency following. However, in certain conditions, this RDS frequency following cannot be provided throughout the country. Radio stations do not cover the whole country, which explains the loss of reception of the station during a journey.

RDS station following

AF Your radio automatically checks and selects the best frequency for the radio station to which it is tuned (if the station broadcasts on several transmitters or frequencies). The frequency of a radio station covers approximately 30 miles (50 km). The change from one frequency to another explains the loss of reception during a journey.

If the station to which you are listening does not have several frequencies in the region in which you are currently located, you can deactivate the automatic frequency following.

Regional following mode

REG Some stations are organised in a network.

In different regions, they broadcast different or shared programmes depending on the time of day.

You can follow:

- a regional station only,
- the entire network, with the possibility that you will be listening to a different programme.

Traffic information function

TP The Traffic Program (TP) function permits automatic and temporary switching to an FM station broadcasting traffic information.

The radio station or the source that you are listening to at this point is paused.

Once the traffic information has ended, the system switches back to the radio station or the source that you were listening to initially.

Programme types

PTY Some stations offer the option of listening to a themed type of programme as a priority, selected from the list available below:

NEWS, AFFAIRS, INFOS, SPORT, EDUCATE, DRAMA, CULTURE, SCIENCE, VARIED, POP M, ROCK M, EASY M, LIGHT M, CLASSICS, OTHER M, WEATHER, FINANCE, CHILDREN, SOCIAL, RELIGION, PHONE IN, TRAVEL, LEISURE, JAZZ, COUNTRY, NATION M, OLDIES, FOLK M, DOCUMENT.

AUDIO and TELEMATICS

Information displayed in Radio mode

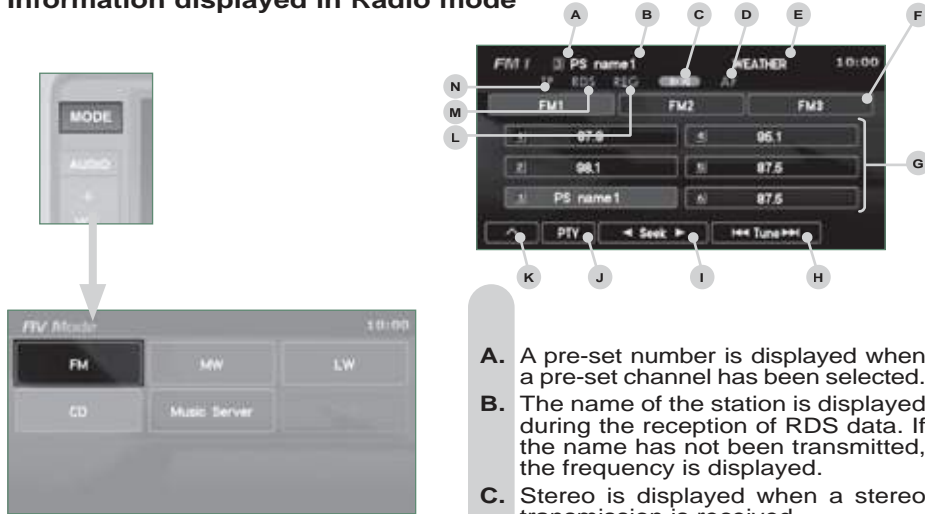















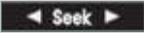

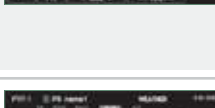

- A. A pre-set number is displayed when a pre-set channel has been selected.
- B. The name of the station is displayed during the reception of RDS data. If the name has not been transmitted, the frequency is displayed.
- C. Stereo is displayed when a stereo transmission is received.
- D. AF is displayed when the AF control function is activated.
- E. PTY (programme type) is displayed if the RDS data received is displayed.
TRAFINF is displayed, during an interruption, for traffic information.
ALARM is displayed, during an interruption, for urgent information.
- F. Display of 6 pre-set stored stations.

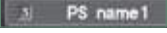
- G. To receive the stored station. Press and hold to store a station.
- H. To change the frequency step by step. Press and hold for scrolling of the frequency.
- I. To search for currently broadcasting stations which can be received in the current location, until a station is found.
- J. To display the programme types pre-setting screen, e.g.: sport, rock, classical, news, ... Press PTY again to exit.
- K. Press this button to display the secondary menu.
- L. REG is displayed during the reception of regional frequencies data.
- M. RDS is displayed during the reception of RDS data.
- N. TP is displayed when the traffic information is in standby mode.









AUDIO and TELEMATICS

Radio, selecting an FM station and storing

Press	Explanations	Result
	Press the MODE button.	
	Press FM. By default the screen shows the FM1 stations.	
	Press [◀ Tune] to decrease the frequency or [Tune ▶] to increase the frequency. The frequency is changed in steps of 0.1 MHz. Continue to press to tune to a station automatically.	
  You can select [◀ Seek] or [Seek ▶] to start a continuous search until the stations which can be received in the current location are detected.		
  You can also start a search by type of programme by pressing [PTY].		
 107.9  PS name 1	Once the frequency has been selected, a long press on the station (e.g. 3) will store it. The name of the station is displayed if it is available.	
   You can start automatic storing on FM3 for 6 stations, which can be received in the current location, by pressing [▲] then [Auto-Store].		

AUDIO and TELEMATICS

Radio, RDS settings

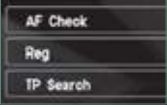
Press	Explanations	Result
	Press the MODE button.	
	Press FM. By default the screen shows the stations on FM1.	
	Press [^].	
	Press [RDS Settings].	
	Press [On] or [Off] to activate or deactivate the functions: <ul style="list-style-type: none">- AF: automatic search for the best frequency,- REG: switch to the regional frequencies,- TP: automatic selection of stations broadcasting traffic information.	

CD player

Your Audio-Telematic system allows you to listen to audio CDs (CDDA, CD-Text, CD-R/RW) or MP3 and WMA CDs.

Playing an audio CD



When the audio CD is inserted in the player, playing of the tracks is automatic and they can be recorded onto the hard disk.

Simultaneous access to the music recognition service "Gracenote CDDB" on the hard disk permits display of the title information.

Recording onto the music server

REC. IN. The tracks of audio CDs (not MP3/WMA) can be recorded onto the hard disk at approximately 4x speed (e.g.: 60 minutes converted to 15 minutes) and stored on the music server.

The sounds recorded may be altered by the noise present and the quality of the sound may differ from the original.

The tracks recorded on the music server cannot be reproduced on another medium (CD-R/RW, HDD, etc...).

Previously recorded tracks cannot be recorded again from the same CD.

Switching off the engine or removing the CD during recording will result in the tracks being faulty.

The operation of the navigation system may slow down during recording.

The recording speed may be slower than 4x due to the processing load on the equipment or the condition of the audio CD.

If jumps or other errors occur, return to the beginning of the track and start the recording again.

Even if there is no gap between the tracks on the CD, a brief silence between tracks is stored on the hard disk.

What is the Gracenote CDDB?



The title information for the track currently being played can be obtained from the "Gracenote CDDB" database stored on the hard disk.

The Gracenote company uses this standard to identify the music and the associated information such as:

- the title of the album,
- the name of the artist,
- the title of the tracks,
- the genre, ...

For further details, consult the site: www.gracenote.com.

The Gracenote CDDB database incorporated in this equipment cannot guarantee the content of the data 100%. You can update this database using a DVD sold separately.

Copyright

Your Audio equipment may allow you to listen to music which is usually protected by copyright in accordance with current national and international standards. Please consult these standards and comply with them.

AUDIO and TELEMATICS

Information displayed in CD mode and recording a CD



The CD button is only active if the player contains a CD.



Press Open to return the screen to the vertical position.

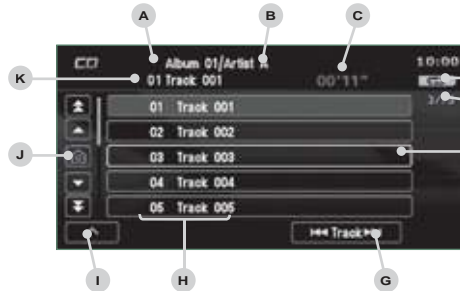

- A. The name of the album is displayed for the track currently being played.
- B. The name of the artist is displayed for the album currently being played.
- C. The playing time of the track currently being played is displayed.
- D. The playing mode currently selected is displayed.
- E. Position of the cursor and total number of tracks on the album.
- F. Displays the item currently selected.
- G. To scroll up or down through the tracks.

Press and hold for fast backwards or forwards playing of a track.







- H. Displays the number and the name of the track. While driving, they are not available and cannot be selected.
- I. To display the secondary menu.
- J. Move the cursor onto the track currently being played.
- K. The number and the name of the track currently being played are displayed.





- L. During recording, this symbol is displayed in red and it switches off when all recording operations are complete. The number indicates the percentage of the total number of tracks on the CD already recorded onto the hard disc. 00 % when only one track has been recorded.
- M. The tracks which have not been recorded are displayed in blue. No symbol is displayed for tracks which have been recorded.

AUDIO and TELEMATICS



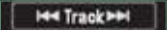

Playing a CD

Press	Explanations	Result
 	Press the MODE button then CD, if the player already contains a CD.	
 	Otherwise, insert a CD in the player, play begins automatically.	

Selecting a track











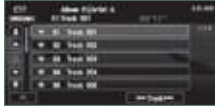

	Press [⏮ Track] to select the previous track or return to the beginning of the track currently being played. Press and hold for fast backwards play.	
	Press [Track ⏭] to select the next track. Press and hold for fast forwards play.	

Changing the play mode

	Press [^] to access the secondary menu.	
	Press [Repeat] to play the track in a loop (repetition). Press [^] then [Repeat] to stop.	
	Press [Scan] to play the beginning of each track for approximately 9 seconds (scan). Press [^] then [Scan] to stop or press the current track (during the 9 seconds) and play begins.	
	Press [Random] to play the tracks in random order. Press [^] then [Random] to stop.	

AUDIO and TELEMATICS

Recording a CD onto the music server (1/3)













Press	Explanations	Result
	<p>Automatic recording of all of the tracks</p> <p>All of the tracks are recorded automatically when a CD is inserted. This automatic recording is programmed by default on leaving the factory.</p>	
	<p>If you have changed the recording mode (manual or first track), while a CD is being played press [^] to access to secondary menu.</p>	
	<p>Press [REC. Setting].</p>	
 	<p>Press [Auto REC.] and confirm by pressing [Back].</p>	
	<p>Next, eject the CD currently being played then insert a CD and the recording of all of the tracks begins.</p>	
 	<p>If you wish to record the CD which is currently being played, press [^] to access the secondary menu and press [REC. Start].</p>	



If another track (already recorded) is selected during recording, the recording continues and the new track selected is played.
If another track (not recorded) is selected, the recording which is in progress stops and the CD returns to the menu screen. This track is played during recording.

AUDIO and TELEMATICS

Recording a CD onto the music server (2/3)

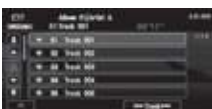













Press	Explanations	Result
 	Manual recording of individual tracks You can record the tracks manually, one by one. After inserting a CD and while it is being played, press [^] to access the secondary menu.	
	Press [REC. Setting].	
 	Press [Manual REC.] and confirm by pressing [Back].	
 	Once the manual programming has been carried out, select the track to be recorded then press [^].	
	Press [REC. Start], the recording of the track selected begins.	



If another track is selected during recording, the recording stops and the new track selected is played.

AUDIO and TELEMATICS

Recording a CD onto the music server (3/3)

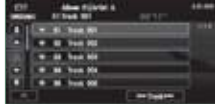
Press	Explanations	Result
 	<p>Automatic recording of the first track</p> <p>You can programme the automatic recording of the first track when a CD is inserted.</p> <p>After inserting a CD and while it is being played, press [^] to access the secondary menu.</p>	
  	<p>Press [REC. Setting] then [Single REC.] and confirm by pressing [Back].</p>	
  	<p>Next, eject the CD which is currently being played then insert a CD and the recording of the first track begins.</p> <p>If you wish to record the first track of the CD which is currently being played, press [^] to access the secondary menu and press [REC. Start].</p>	
	<p>If another track is selected during recording, the recording stops and the track selected is played.</p>	
	<p>Stopping automatic or manual recording</p> <p>During the recording of a CD or of a track on a CD, press [^] to access the secondary menu.</p>	
	<p>Press [REC. Stop], the recording stops.</p>	

AUDIO and TELEMATICS

General notes on the Music Server What is the music server?

Your Audio-Telematic system allows you to copy audio CDs onto a music server, up to 2,500 songs on a 10 Gb hard disk.

The tracks on audio CDs (not MP3 or WMA) can be recorded onto the hard disk at approximately 4x speed and stored on the music server.

Refer to the "Recording a CD" section.

The music server then allows you to manage groups and lists of tracks.

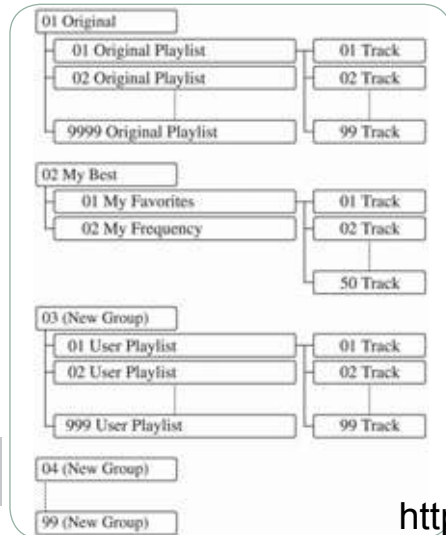

"Original" group, number 01:

01 Original This is the location of the original playlist created automatically (not manual) when a track of an audio CD is recorded.

It is not possible to change its name or delete it.

You can record up to 9999 playlists in this group.

"Original Playlist" lists:

01 Original Playlist These are original playlists created automatically (not manual) when an audio CD is recorded.

The lists and the artists can be renamed or deleted. The genres can also be set.

"My Favorites" list:

01 My Favorites This is the location for storing your favourite tracks.

They can be deleted from the list and the order in which they are played can be changed.

"My Frequency" list:

02 My Frequency This is the location of the playlists used most frequently from the **original** list.

It is not possible to add tracks or change their order.

"My Best" group, number 02:

02 My Best This is the location of the playlists, etc... created automatically from the information read on the music server.

It is not possible to change its name or delete it.

The groups "My Favorites" and "My Frequency" are stored here.

"User Playlist" list:

01 User Playlist This is the location of a playlist of tracks selected by the user from the **original** list.

If you delete a track from the original list, it will be deleted from the user list.

The list and the artist can be renamed or deleted.

It is possible to add tracks or change their order.

"New Group" group for the user, numbers 03 to 99:

03 (New Group) This is the location of the user's playlists.

You can record up to 9999 playlists in this group.

The group can be created, renamed or deleted.

AUDIO and TELEMATICS

Information displayed in Music Server mode

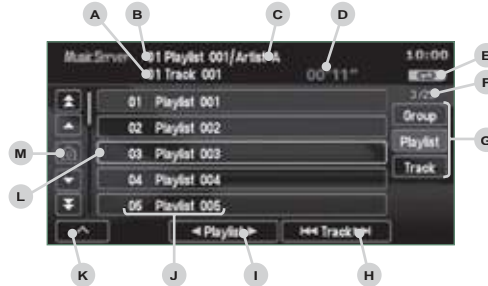
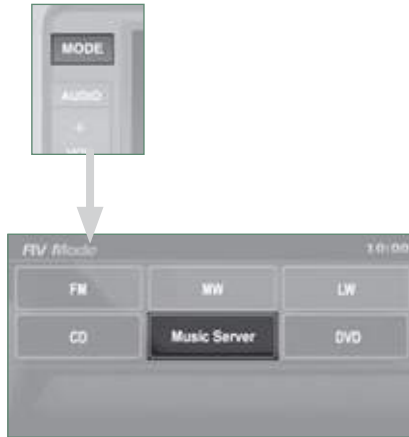



- A. The number and the name of the track currently being played are displayed.
- B. The number and the name of the playlist currently being played are displayed.
- C. The name of the artist is displayed for the playlist currently being played.
- D. The playing time of the track currently being played is displayed.
- E. The playing mode currently selected is displayed.
- F. Group lists: position of the cursor and total number of groups.
Playlists: position of the cursor and total number of playlists.
Track lists: position of the cursor and total number of tracks.

- G. To display the list of groups, the playlist and the list of tracks.
- H. To scroll up or down through the tracks.
Press and hold for fast backwards or forwards playing of a track.
- I. To scroll up or down through the playlists.
- J. Group lists: number and name of the group.
Playlists: number and name of the playlist.
Track lists: number and name of the track.
- K. To display the secondary menu.
- L. Displays the item currently selected.
- M. Move the cursor onto the track currently being played.

AUDIO and TELEMATICS



Playing a track or a playlist on the Music Server

Press	Explanations	Result
 	Press the MODE button then Music Server.	



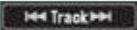

The playlists are played in a loop.
The server can play a track while recording another track from a CD. You must wait until recording is complete before playing the recorded track.

Selecting a track

	Press [⏮ Track] to select the previous track or return to the beginning of the track currently being played. Press and hold for fast backwards play.	
	Press [Track ⏭] to select the next track. Press and hold for fast forwards play.	

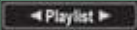
Selecting a playlist

	Press [◀ Playlist] to select the previous playlist.	
	Press [Playlist ▶] to select the next playlist.	



















 Press these buttons to switch between groups, playlists and tracks.
You can also switch the

<https://www.automotive-manuals.net/>

AUDIO and TELEMATICS

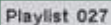
Creating a group and a playlist on the Music Server

Press	Explanations	Result
Creating a group		
	Press [^] to access the secondary menu.	
 	Press [New Group], enter the name of the group and press [SET]. The group is stored on the server.	
Creating a playlist		
 	Press [^] to access the secondary menu then press [Function Settings].	
	Press [New Playlist].	
	Select the group to which the playlist is to be attached. The group must be created first.	
	Enter the name of the playlist and confirm by pressing [SET]. Then select the search method attached to this new list (either from the list or by conditions). The list is stored on the server.	

General notes on MP3/WMA CDs

Playing an MP3/WMA CD



When the MP3/WMA CD is inserted in the player, playing of the tracks is automatic.

The tracks cannot be recorded onto the music server.

You can play CDs with up to 8 levels, 255 folders and 400 files maximum.

What is the MP3/WMA file format?

MP3 is the abbreviation of MPEG-1 Audio Layer 3 and MPG is the abbreviation of Motion Pictures Experts Group, a digital video data compression standard used on media such as video CDs.

The MP3 compression reduces the number of bytes in a song by eliminating the long sound waves in the range of frequencies which are imperceptible to the human ear, so producing high quality audio files with a low volume of data.

This compression divides the size of the content of a conventional audio CD by approximately 10, which means that the content of 10 audio CDs can be recorded onto a single CD-R or CD-RW.

WMA is the abbreviation of Windows Media Audio, another audio data compression standard offered by Microsoft. It can be used to create and save audio files at a compression rate higher than that of the MP3 format.

Windows Media and Microsoft Corporation are trademarks registered in the United States and/or other countries.

Acceptance of the files

Some blank CDs may not be played by your equipment (quality, recording speed...).

When you burn a CD-R or CD-RW, select the ISO 9660 level 1.2 or Joliet burning standard.

To obtain the best acoustic quality possible, select the lowest burning speed.

The MPEG1 and MPEG2 standards are accepted.

Transmission speeds between 32 and 320 kbits/s and scans between 16 kHz and 48 kHz are accepted.

To display the title information (the name of the artist, the title of the album, etc...), the information contained in the ID3 Tags or the WMA Tags must be included in the MP3/WMA files burned onto the disc.

Copyright

Your Audio equipment may allow you to listen to music which is usually protected by copyright in accordance with current national and international standards. Please consult these standards and comply with them.

AUDIO and TELEMATICS

Information displayed in MP3/WMA CD mode

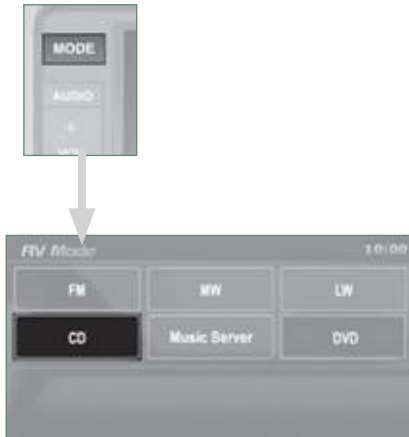

The CD button is only active if the player contains a CD.



Press Open to return the screen to the vertical position.

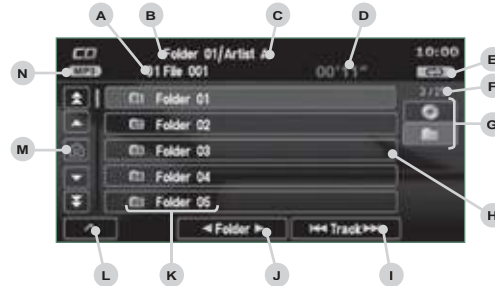





- A. The number and the name of the track currently being played.
- B. The name of the album/folder is displayed for the track currently being played.
- C. The name of the artist is displayed for the track currently being played.
- D. The playing time of the current track is displayed.
- E. The playing mode currently selected is displayed.
- F. Position of the cursor and total number of folders or tracks on the current level.
- G. To display the list of folders of a higher level.
- H. Displays the item currently selected.

- I. To scroll up or down through the tracks.
Press and hold for fast backwards or forwards playing of a track.
- J. To scroll up or down through the folders.
- K. Displays the folder number and the folder name. Plus the lists and numbers of tracks and the name of the file (without extension).
- L. To display the secondary menu.
- M. Move the cursor onto the track currently being played.
- N. Displays the type of medium, MP3 or WMA.



AUDIO and TELEMATICS

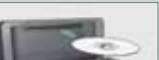

Playing an MP3/WMA CD (1/2)



Press	Explanations	Result
 	Press the MODE button then CD, if the player already contains a CD.	

  Otherwise, insert a CD in the player, play begins automatically.



Moving around the folders

	You can move by one level at a time. Press on the name of a folder and at each press the list of folders of the level below is displayed.	
---	--	---

  These displays indicate the current level:
CD: level 0, folder below: level, folder below that, level 2, etc...
Up to 8 levels maximum.

	Press on the folder above to move up and/or select a level.	
---	---	---









Selecting a folder

	Press [◀ Folder] to select the previous folder.	
	Press [Folder ▶] to select the next folder.	

<https://www.automotive-manuals.net/>

AUDIO and TELEMATICS

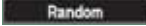
Playing an MP3/WMA CD (2/2)

Press	Explanations	Result
Selecting a track		
	Press [Track Previous] to select the previous track or return to the beginning of the track currently being played. Press and hold for fast backwards play.	
	Press [Track Next] to select the next track. Press and hold for fast forwards play.	
Changing the playing mode		
	Press [Up] to access the secondary menu.	
	Press [Repeat] to play the track selected in a loop (repetition). Press [Repeat] again to play all of the tracks in the selected folder in a loop. Press again to stop.	
	Press [Scan] to play the beginning of each track in each folder for approximately 10 seconds (scanning). Press [Scan] again the play the beginning of each track in the selected folder in a loop. Press again to stop or press on the current track (during the 10 seconds) and play begins.	
	Press [Random] to play all of the tracks in the selected folder in random order. Press [Random] again to play all of the tracks on the CD in random order. Press again to stop.	

AUDIO and TELEMATICS

DVD MODE

Information displayed in DVD mode



The DVD button is only active if the player contains a DVD.



XI Press Open to return the screen to the vertical position.

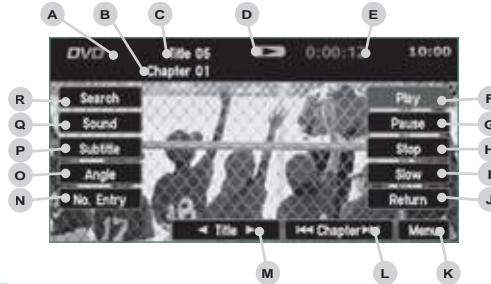

- A.** This icon is displayed when the operation requested cannot be carried out.
- B.** The number of the chapter currently being played is displayed.
- C.** The number of the title currently being played is displayed.
- D.** Symbols display the current status of the player.
- E.** The playing time is displayed.
- F.** To resume normal play when play is paused or during slow-motion play.
- G.** To stop play temporarily.
- H.** To stop play. Press the screen to access the menu.
- I.** For slow-motion play.
- J.** To play the previously selected zone on the disc.

- K.** To display the DVD title menu.
- L.** To scroll up or down through the chapters.
Press and hold for fast backwards or forwards play.
- M.** To scroll up or down through the titles.
- N.** To enter a title or chapter number.
- O.** To change the angle.
- P.** To change the language of the subtitles.
- Q.** To change the language.
- R.** To select a chapter or title or specify a number.



For safety reasons, the video is not displayed while driving, however the audio can be played.

To display the picture and watch a DVD, park the vehicle in a safe place.

AUDIO and TELEMATICS

Playing a DVD

Press

MODE

DVD

Explanations

Press the MODE button then DVD, if the player already contains a DVD.

Result



Otherwise, insert a DVD in the player, the picture is displayed automatically. Press the screen to access the menus.



While driving, only the soundtrack is played and no picture is displayed.



Selecting a chapter

Press [⏮ Chapter] to select the previous chapter or return to the beginning of the chapter currently being played.
Press and hold for fast backwards play.

⏮ Chapter

Press [Chapter ⏭] to select the next chapter.
Press and hold for fast forwards play.

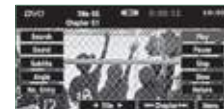

Selecting a title

Press [◀ Title] to select the previous title.

◀ Title ▶

Press [Title ▶] to select the next title.

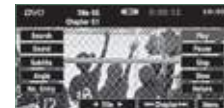

<https://www.automotive-manuals.net/>

AUDIO and TELEMATICS

SETTINGS

Display, sound, picture

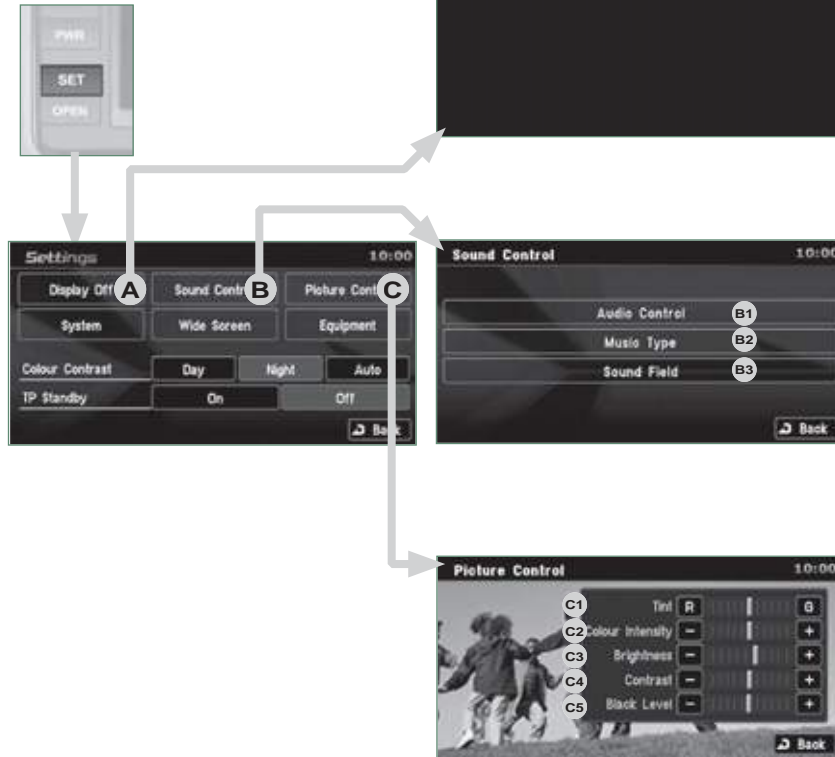

A - Choose to switch off the display.
To switch it back on, touch the screen or press any button.

B - Choose the settings of the sound in the vehicle, if an audio source is selected (FM, CD, ...), for:

B1 - the sound distribution or the volume such as the front-rear balance, the bass, the medium, the treble, the volume adjustment in relation to the vehicle speed,

B2 - the type of music (with surround option) such as classic, jazz, pop, rock, hip hop, country, normal, ...

B3 - the sound field (with surround option) such as stage, live, hall, normal, ...

C - Choose the quality of the picture for:

C1 - the colour (when playing DVDs),

C2 - the intensity of the colours (when playing DVDs),

C3 - the brightness,

C4 - the contrast,

C5 - the level of black.

AUDIO and TELEMATICS

Time and date, language, unit, picture size



- D - Choose the base settings of the system for:
 - D1 - setting of the time by the RDS signal, time zone, summer time,
 - D2 - the language (English, Français, Deutsch, Nederlands, Portuguese, Español, Svenska, Italiano, Dansk),
 - D3 - the units for calculation of the distances (km or miles and °C or °F),
 - D4 - other settings such as:
 - the voice guidance volume,
 - the type of voice guidance voice (female or male),
 - the volume of the operation bleeps (1 to 3 and 0=no bleep),
 - the type of inputting keypad (alphabet or PC),
 - the range of menu colours (red or blue),
 - the displaying or not of the audio playing icons on the map screen,
 - the reinitialisation of the vehicle sensor,
 - the interruption or not of the display when the air conditioning is used.

- E - Choose the size of the DVD picture for:
 - E1 - normal 4/3,
 - E2 - extends the picture evenly to the right and to the left in wide screen mode,
 - E3 - extends the right and left parts only leaving the centre as it stands in wide screen mode,
 - E4 - enlarges the picture in 4/3 format. The top and the bottom are outside the frame.

AUDIO and TELEMATICS

Equipment, contrast, traffic information (TP)

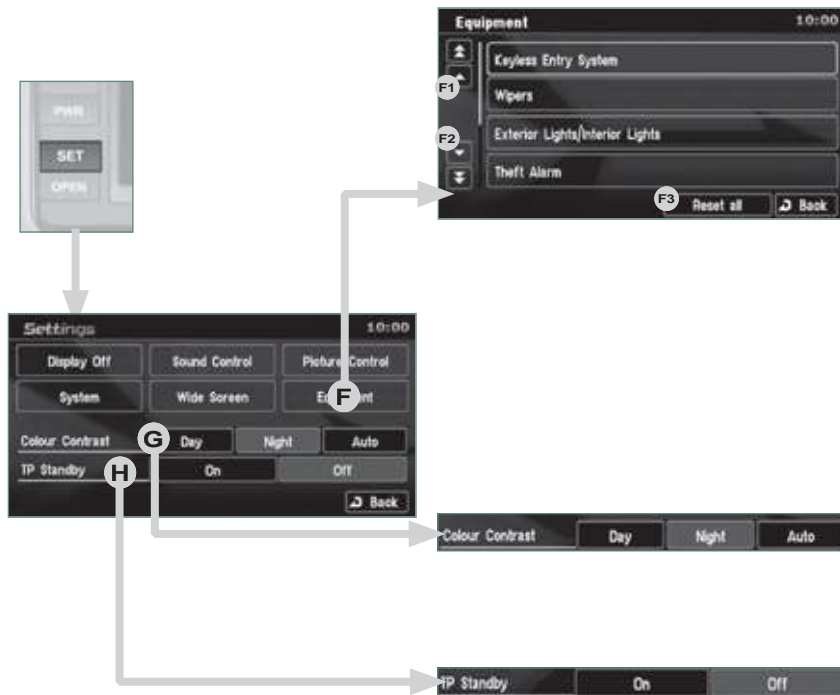

F - Choose to adjust or set the parameters of certain equipment offered in your vehicle (e.g.: unfolding/folding of the mirrors, closing the windows on locking, timing and sensitivity of the automatic lighting, direction indicators motorway function, ...):

F1 - to scroll up the list,

F2 - to scroll down the list,

F3 - to reinitialise all of the settings (manufacturer's settings).
Press each setting to select or change the parameters.

G - Choose to adjust the contrast of the display in relation to the ambient light level (day, night or automatic).

H - Choose to activate or deactivate the traffic information (TP).

AUDIO and TELEMATICS

INFORMATION

System version, satellite



- A - Consult the system information:
- A1 - the software version,
- A2 - the map data version,
- A3 - the system information database version.

To update the versions, insert the DVD containing the new data and follow the instructions on the screen.

- B - Consult the GPS information:
- B1 - the satellite positions diagram with the direction of movement of the vehicle. Plus the position of the satellite signal receivers,
- B2 - the name of the current location,
- B3 - the longitude and latitude of the current location,
- B4 - the position measurement status (2D=3 satellites or fewer, 3D=4 satellites or more),
- B5 - the number of receiving satellites,
- B6 - to have north at the top of the map,
- B7 - to have the direction of the vehicle at the top of the map,
- B8 - to pivot the map from overhead or change the angle of the map.

AUDIO and TELEMATICS

Calendar, trip

The diagram illustrates the navigation flow between the INFO button, the Info screen, the Calendar screen, and the Trip screen. Callout C points to the Calendar screen, and callout D points to the Trip screen. A text box explains that double arrows permit access to the driving information screen, previous or next.

Calendar (OCT, 1, 2008 10:00)

OCT, 2008	SUN	MON	TUE	WED	THU	FRI	SAT
1	2	3	4	5	6	7	
8	9	10	11	12	13	14	
Month	15	16	17	18	19	20	21
← ▶	22	23	24	25	26	27	28
Year	29	30	31				
← ▶							
Anniversary							
							Back

Info (10:00)

- Support Info
- Vehicle Position
- Calendar **C**
- Trip **D**
- Environment
- Air Conditioner
- Mobile Phone

Trip (10:00)

Auto Reset Mode 1/3

Average Speed 40 km/h **D1**

Average Fuel Consumption 13.6 km/l **D2**

Instant Fuel Consumption 11.6 km/l **D3**

D4 Graph **D5** Manual **D6** Back

Trip (10:00)

Distance to Empty 237 km **D6**

Distance Driven after Refueling 340 km **D7**

Driving Time 0:31 **D8**

D7 Refuel **D8** Back

Trip (10:00)

	Lap Time	km	km/h	km/l
→	2:10:50	121.0	---	---
A	2:10:34	120.7	40	11.6
B	---	---	---	---

Stop Lap Reset **D9** **D10** **D11** **D12** Back

C - Make a note on the calendar of special days, birthdays, ...
Use the arrows to find a date and press directly on the day required to enter the event.

D - Consult the driving information:

- D1** - the average speed,
- D2** - the average fuel consumption,
- D3** - the current fuel consumption,
- D4** - for speed and fuel consumption graphs in 5 minute intervals,
- D5** - choose an automatic reinitialisation (key at off for more than 4 hours) or manual reinitialisation (press [Reset]),
- D6** - the distance which can still be travelled (in relation to the fuel remaining and the recent average consumption),
- D7** - the distance travelled since the fuel tank was last filled (press [Refuel] to reinitialise),
- D8** - the driving time (duration between the key being turned to on then to off).

- press [Start] to measure intermediate times with:

- D9** - the duration,
- D10** - the distance,
- D11** - the speed,
- D12** - the fuel consumption.

AUDIO and TELEMATICS

Environment, air conditioning, telephone

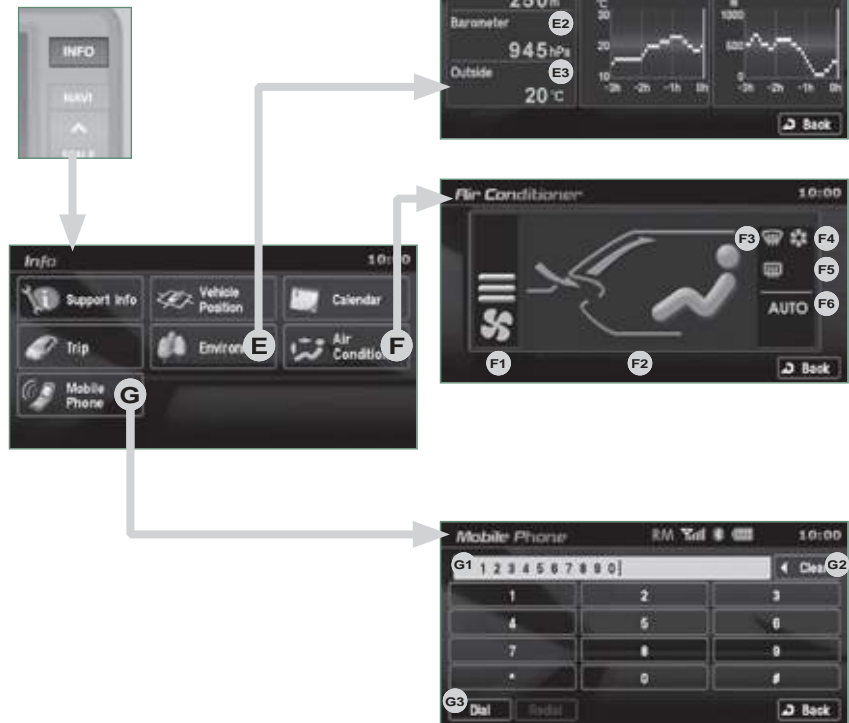

- E** - Consult the environment information:
- E1** - the altitude,
- E2** - the atmospheric pressure,
- E3** - the ambient temperature. The ice symbol flashes if there is a risk of ice.

- F** - Consult the air conditioning conditions:
- F1** - the fan speed indicator,
- F2** - the air selection indicator,
- F3** - the windscreen demisting indicator,
- F4** - the air conditioning indicator,
- F5** - the rear screen demisting indicator,
- F6** - the AUTO mode indicator.

- G** - Make and receive telephone calls:
- G1** - enter the telephone number,
- G2** - delete a character,
- G3** - make the call.

Refer to the hands-free telephone section to connect your Bluetooth® mobile telephone.

AUDIO and TELEMATICS

HANDS-FREE TELEPHONE

General notes

What is the Bluetooth® hands-free telephone with voice recognition?



The system uses wireless communication technology referred to as Bluetooth® which allows you to make hands-free telephone calls in your vehicle via your Bluetooth® compatible mobile telephone.

You can make telephone calls using a microphone located in the courtesy lamp, making use of the simple steering mounted controls or by the voice recognition function with voice commands. Five languages are available: English (by default), Spanish, French, German and Italian.

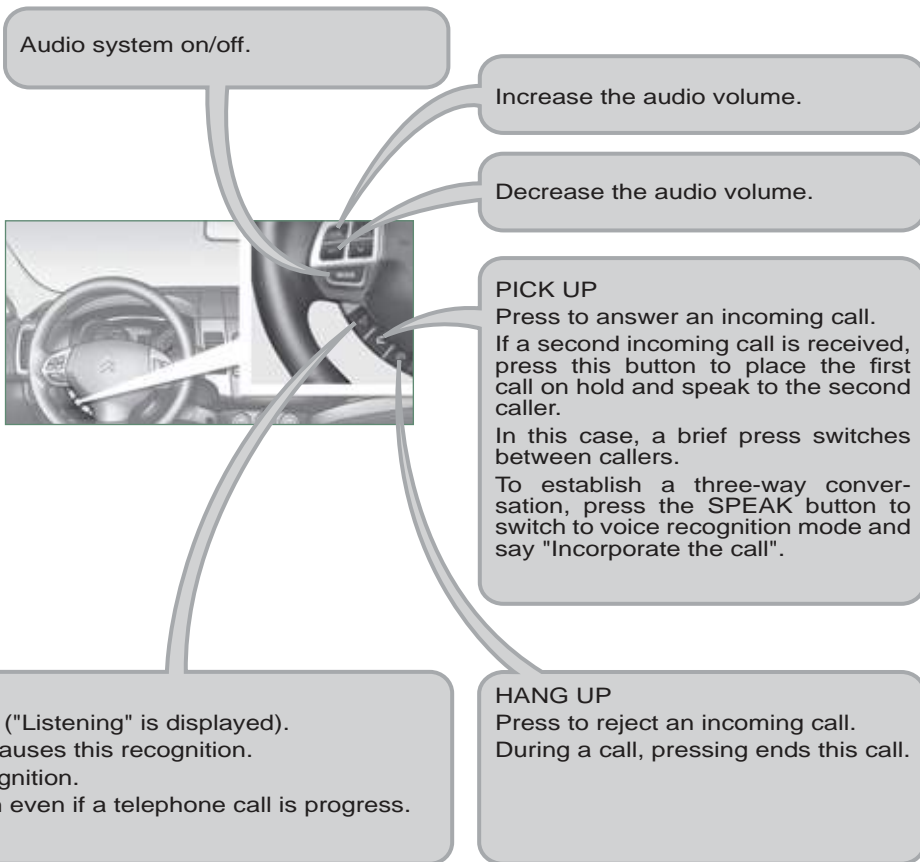

Changing the language, programming the voice

Changing the language of the voice commands

By default, the recognition system is in English.



1 - Press the SPEAK button.



2 - Say "Setup".



3 - Say "Language".

4 - The system says "Select a language: English, Spanish, French, German or Italian".



5 - Say the language of your choice in English, example: say "French" for French.

6 - The system then says "French selected. Is this correct?"



7 - Say "Yes" to start the change of language process or say "No" to return to steps 4 to 7.

8 - The system repeats the language chosen and completes the change of language process.

Programming the user's voice

You can use the user's voice programming function to create a voice model for one person per language.

The characteristics of your voice and your pronunciation are recorded in this model for improved voice recognition.

It is essential that the vehicle is parked in a safe place, with the parking brake applied.

Switch off your telephone during the process to avoid any interruption.



1 - Press the SPEAK button.



2 - Say "Word training".

3 - An explanation message is given.



4 - When you are ready to start, press and hold the SPEAK button.

5 - The system says the first of 45 typical phrases.



6 - Repeat each phrase in the table on the next page.

The system records your voice and moves on to the recording of the next command.

Continue the process until all of the phrases have been recorded.

7 - After reading all the voice commands, the system says "The word enrolment is complete" and ends the process.

If you do not start the programming process within approximately 3 minutes after pressing the SPEAK button, the process is cancelled.

If you press the SPEAK button within 5 seconds following the reading of a voice command, the recording of this command is repeated.

AUDIO and TELEMATICS

Training voice commands

1	# 790 (for # = "Hash")
2	* 671 (for * = "Star")
3	212 - 4 903
4	235 - 3 494
5	315 - 5 657
6	456 - 7 930
7	793 - 5 462
8	794 - 1 826
9	826 - 3 145
10	962 - 7 305
11	(531) 742 - 9 860
12	(632) 807 - 4 591
13	(800) 222 - 5015
14	(888) 555 - 1 212
15	0 123 456 789

16	55 66 77 88 99
17	44 33 22 11 00
18	Call 293 - 5804
19	Call * 350
20	Call 1 (234) 567 - 8 901
21	Dial 639 - 1542
22	Dial # 780
23	Dial (987) 654 - 3210
24	1058# 3794# Send
25	27643# 4321# Send
26	Cancel
27	Continue
28	Emergency number
29	Clear all
30	Help

31	Home, Work, Mobile, Pager
32	List of names
33	No
34	Phone book: Delete
35	Phone book: New entry
36	Previous
37	Phone book: Clear all
38	Redial
39	Repeat the training
40	Configure the confirmation requests
41	Configure the language
42	Configure the matching options
43	Match a telephone
44	Transfer the call
45	Yes

AUDIO and TELEMATICS

Matching your Bluetooth® telephone

The system can register up to 7 Bluetooth® compatible mobile telephones.

The telephone which has the highest level of priority is connected automatically.

It is absolutely essential that the vehicle is parked in a safe place with the parking brake applied.



1 - Press the SPEAK button.



2 - Say "Configure".



3 - Say "Matching options".

4 - The system says "Do you wish to match a telephone, delete a telephone or obtain the list of matched telephones?".



5 - Say "Match a telephone".

6 - The systems says "Please say the 4 digits of a matching code".



7 - Say a 4-digit number which will be recorded as the matching code.



8 - The system confirms the validity of the number spoken, answer "Yes". Say "No" to return to step 7.

Remember this matching code as you must enter it in the telephone in one of the following steps of the matching procedure.

9 - The system says "Start the matching procedure on the telephone. Consult the instructions in the telephone manual".



10 - Consult your mobile telephone's user manual and enter the matching code recorded in step 7 in the telephone.

If the code is incorrect, the system locks. To clear the code:

- check that the telephone's voice recognition is not activated,
- with the ignition on and the audio system active, press the HANG UP button for 2 seconds, 3 times in succession.



11 - When it detects a Bluetooth® compatible mobile telephone, the system says "Please say the name of the telephone".



12 - After the audible signal, allocate a name to the telephone by saying the name of your choice.

13 - The system says "Allocate an order of priority between 1 and 7. One is the highest level of priority".



14 - Say a number between 1 and 7 to establish the level of priority of the mobile telephone.

15 - The system says and confirms the <name of the telephone> and the <number> of its priority.



16 - Answer "Yes" or say "No" to return to step 13.

17 - The systems says "Matching complete" then emits an audible signal and deactivates the voice recognition.

If the system does not detect the Bluetooth® compatible mobile telephone, the matching process stops accompanied by an audible signal.

If you select a level of priority which has already been allocated to another telephone, the system asks you if you wish to replace this level of priority.

Making a telephone call using a number, phone book

A Bluetooth® compatible mobile telephone must be matched with the system.

Using a telephone number



1 - Press the SPEAK button.



2 - Day "Dial".

3 - The system says "Number please".



4 - Say the telephone number.



5 - The system asks you to confirm this number, answer "Yes". Say "No" to return to the previous step.



If your vehicle is fitted with the audio-telematics screen, you can use the press buttons to dial a number then make a call.

Recording a name in the system's phone book

The system has its own phone book, independent of that of the mobile telephone.

It can contain up to 32 names for each language.

Each name in the phone book is associated with 4 locations: HOME, WORK, MOBILE and PAGER.



1 - Press the SPEAK button.



2 - Say "Phone book".

3 - The system says "Select one of the following items: New Entry, Change, List of names, Delete or Clear all, or say Cancel to return to the main menu".

To enter a new number:



4 - Say "New entry".

5 - The system says "Name please".



6 - Say the name of your choice.

7 - The system says "HOME, WORK, MOBILE OR PAGER".



8 - Say the location which corresponds to the number that you wish to record.

9 - The system asks you to confirm the location.



10 - Answer "Yes" or say "No" to return to step 7.

11 - If a telephone number has already been recorded for this location, the system says "The current number is <number>, number please".



12 - If you do not wish to change the telephone number, repeat the original number to retain it, otherwise say the new number.

13 - The system asks you to confirm the number.



14 - Answer "Yes" or say "No" to return to step 11.

Making a telephone call using a name in the phone book, receiving a call

Using a name in the system's phone book

The name must be recorded in the system's phone book.



1 - Press the SPEAK button.



2 - Say "Call".

3 - The system says "Name please".



4 - Say the name of the person that you wish to call.

5 - If several telephone numbers have been recorded for this person, the system says "Do you wish to call <name> {home}, {work}, {mobile} or {pager}?".



6 - Say the location corresponding to the number that you wish to call.

7 - The system request confirmation of the name.



8 - Answer "Yes" or say "No" to return to step 4.

9 - The system says "Call to <name> at <location>" and makes the call.

Redialling the last number



1 - Press the SPEAK button.



2 - Say "Redial".

Receiving a call

The telephone ring is transmitted on the speaker by the front passenger's seat.

If an audio source (CD, radio, ...) is in operation when the call is received, it is placed on mute and only the incoming call is heard.

When the ignition switch is in the ACC or ON position, the audio system is activated automatically if an incoming call is received, even if it was originally off.



1 - Press the PICK UP button.

At the end of the call, the audio system returns to its previous status.

AUDIO and TELEMATICS

Voice commands (1/2)



Press this button to start the voice recognition.

Configure	Divert the call	Home, at home
Phone book	Add a location	Work, at work
Dial	Configure the confirmation requests	Mobile, on mobile
Call	Language	Pager, on pager
Redial	New entry	Help
Emergency number	Delete	Continue
Matching options	Change	All
Match a telephone	Call this number	Cancel
Delete a telephone	Change another entry	Mute
List of matched telephones	Try again	Deactivate mute
Select a telephone	Clear all	Yes
Previous	List of names	No

XI

When the system is waiting for a voice command, say "Help" to obtain a list of commands which can be used in the current situation.

<https://www.automotive-manuals.net/>

AUDIO and TELEMATICS

Voice commands (2/2)



Press this button to start the voice recognition.

Zero	English	Word training
One	Phone book New entry	PIN
Two	Phone book Change	Repeat training
Three	Phone book Delete	Activate
Four	Phone book Clear All	Deactivate
Five	Phone book List of names	Incorporate the call
Six	Configure the confirmation requests	<digits> Send
Seven	Configure Select a telephone	
Eight	Configure the matching options	
Nine	Delete a name	
Star (*)	Configure the language	
Hash (#)	Configure the PIN	

When the system is waiting for a voice command, say "Help" to obtain a list of commands which can be used in the current situation.

<https://www.automotive-manuals.net/>

VISUAL SEARCH

FRONT EXTERIOR

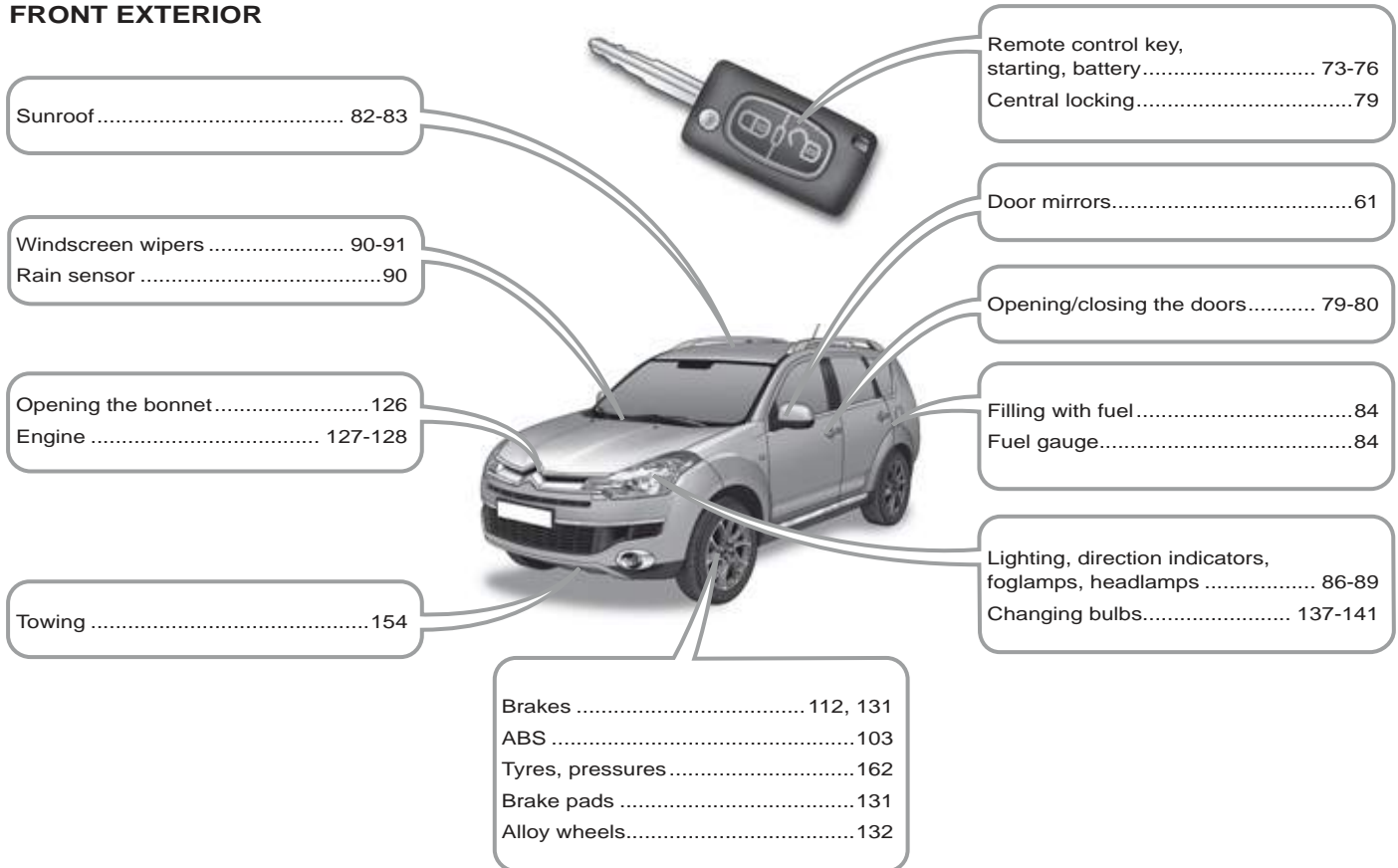

<https://www.automotive-manuals.net/>

VISUAL SEARCH

REAR EXTERIOR

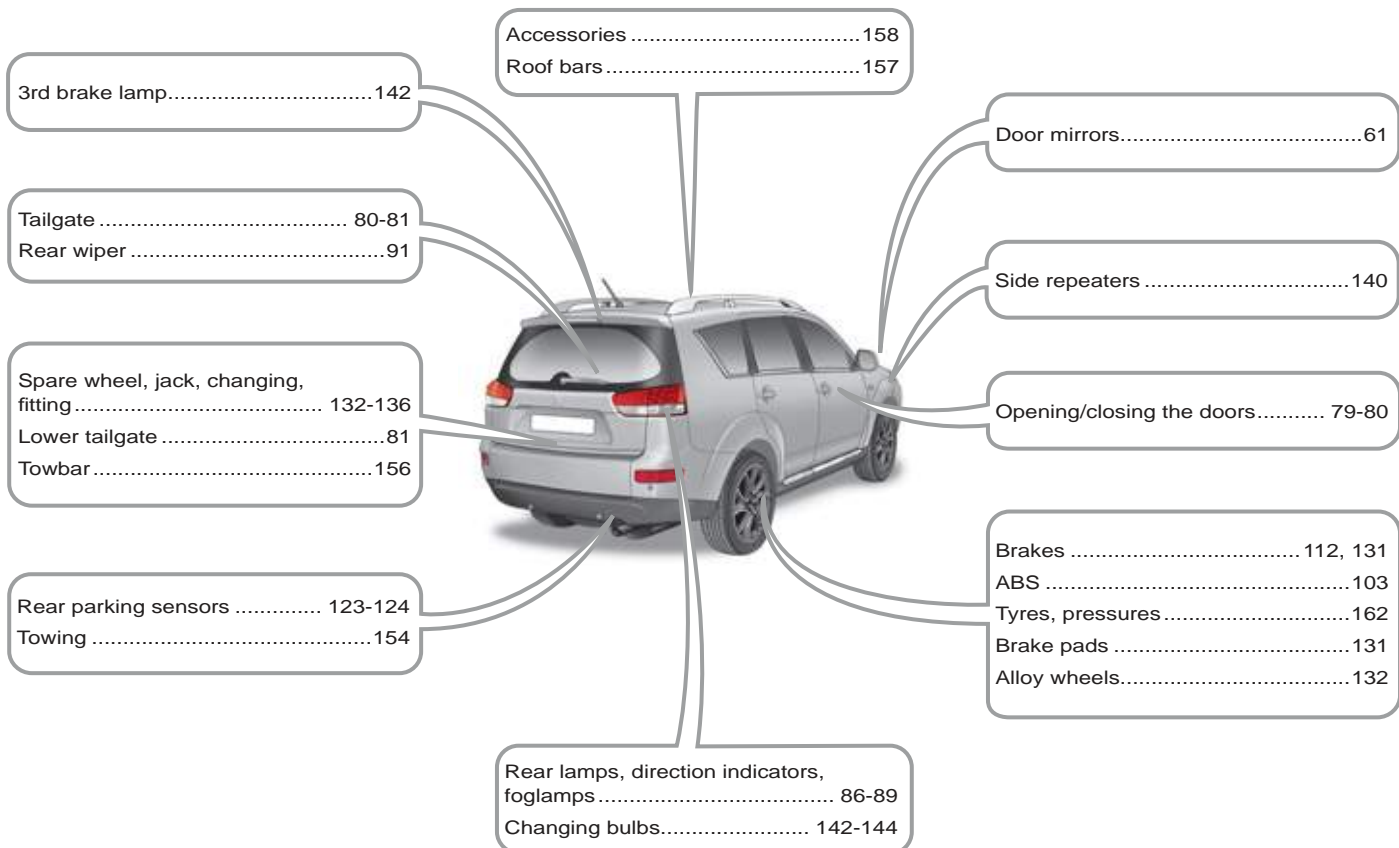

<https://www.automotive-manuals.net/>

VISUAL SEARCH

INSTRUMENTS AND CONTROLS

Instrument panels, dials, speedometer.....21
Warning lamps, messages 22-30
Indicators, screens 31-38
Dashboard lighting dimmer.....41

ASC 104
Fuses..... 146-150

Electric windows 77-78
Electric mirrors.....61

Opening the bonnet.....126

Opening the fuel filler flap.....84

Toll card window63
Courtesy lamps..... 92-93
Rear view mirror62

Tripp computer34
Screens 39-43
Changing the time 39-43
Audio system 164-223

Signal/hazard warning lamps, warning102

Heating 44-49
- vent, demist/defrost,
- automatic air conditioning,
- air recirculation,
- ventilation.

Fittings 64-68
- 12 V socket, ashtray.

Gearbox..... 112-118

Parking brake, handbrake 112

<https://www.automotive-manuals.net/>

VISUAL SEARCH

STEERING MOUNTED CONTROLS

Lighting 86-88
- dipped beam headlamps,
- main beam headlamps,
- foglamp.
Automatic illumination of headlamps.....88
Headlamp wash.....90

Audio system controls166, 178

Headlamp adjustment.....89
Parking sensors..... 123-124
ASC 104

Telephone controls216

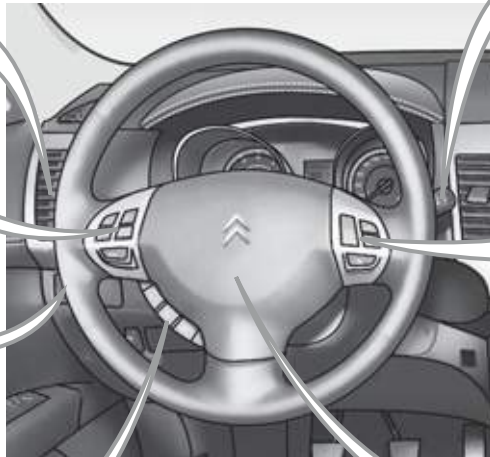

Wipers 90-91
Screenwash..... 90-91

Cruise control 121-122

Steering wheel, adjustment63
Horn..... 102
Airbags 108-111

VISUAL SEARCH

INTERIOR

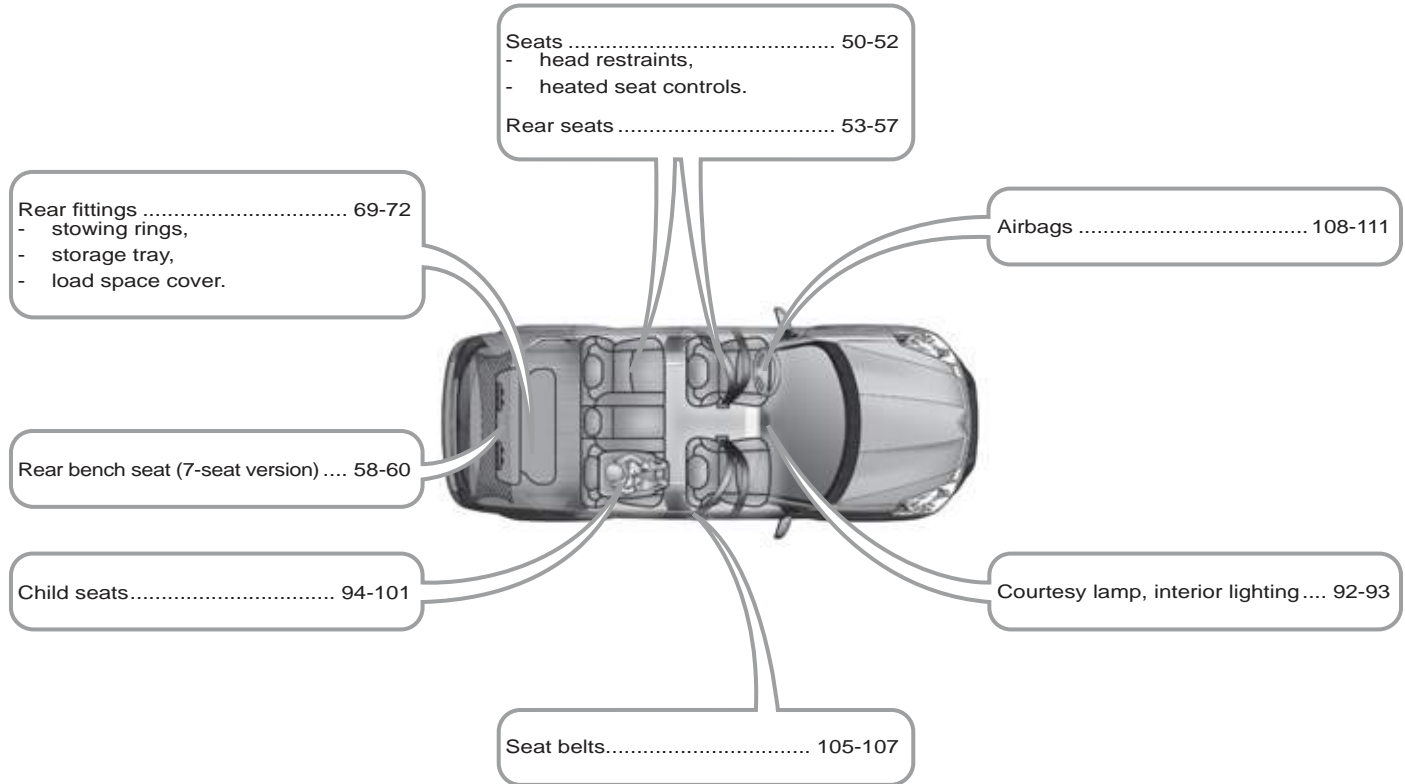

VISUAL SEARCH

TECHNICAL DATA - MAINTENANCE

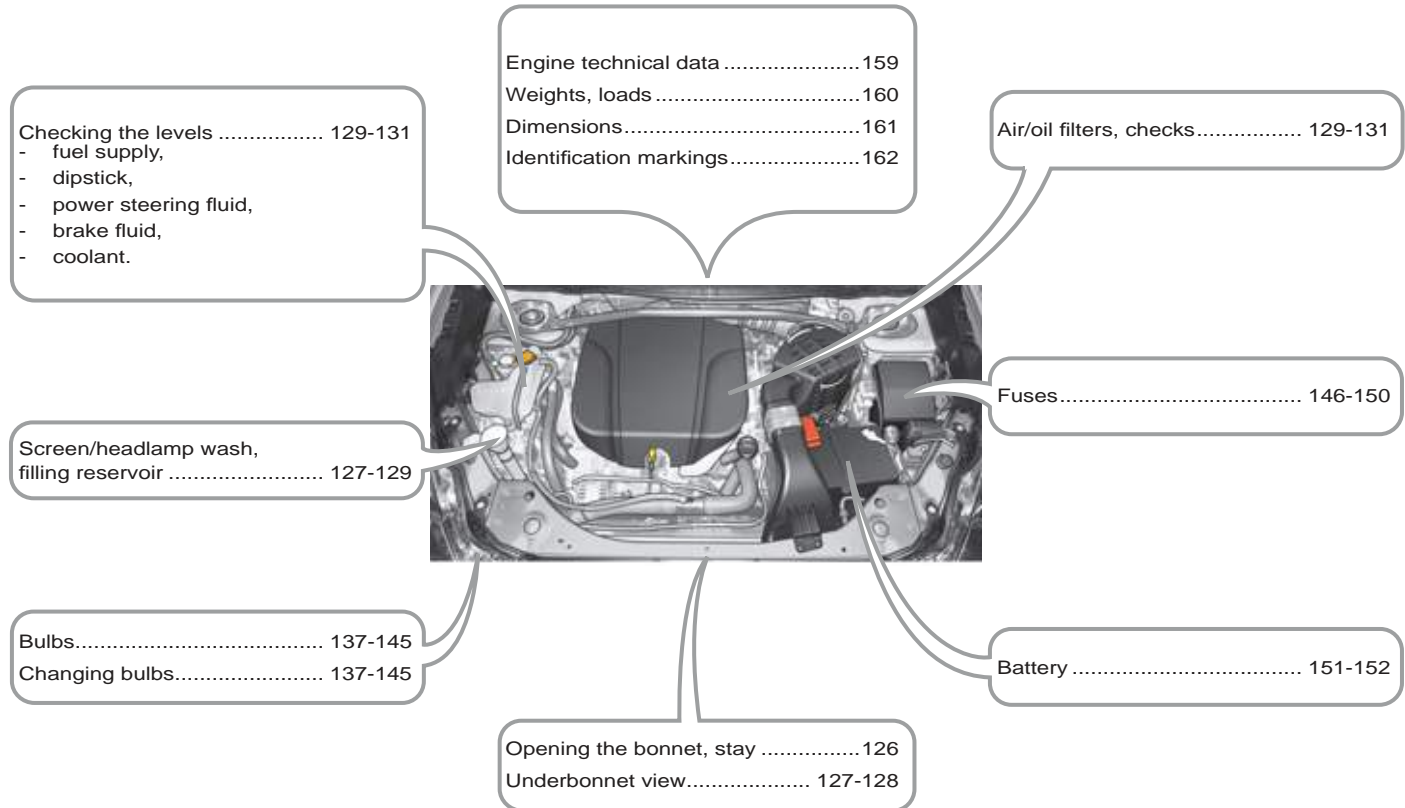

<https://www.automotive-manuals.net/>

ALPHABETICAL INDEX

- A** ABS 103
ABS and EBSD systems..... 103
Accessories 158
Accessory socket,
12V 64, 66, 67, 70, 71
Access to bulbs 137
Access to the 3rd row 54
Adjusting headlamps 89
Adjusting seat belt height 105
Adjusting the steering wheel..... 63
Airbags, curtain..... 110, 111
Airbags, front 108, 111
Airbags, lateral..... 110, 111
Air conditioning 19
Air conditioning, digital..... 46
Air flow 19
Air intake..... 46
Air vents..... 44
Anti-lock braking system (ABS)... 103
Anti-pinch..... 82
Armrest, front..... 52, 64, 66
Armrest, rear..... 54, 69
ASC 104
Ashtray, portable..... 64, 67
Athermic windscreen 63
Audible warning 102
Audio-CD... 169, 170, 172, 175, 177
Audio-telematics 178-182, 186,
190, 191, 194, 196, 197,
202-204, 208-210,
213, 216, 217, 220-222
- B** Audio-video..... 190
Audio system functions..... 178, 179
Audio systems 164, 166, 167,
169, 170, 172, 173, 175,
177-182, 186, 190, 191, 194,
196, 197, 202-204, 208-210,
213, 216, 217, 220-222
Automatic illumination
of headlamps..... 86, 88
Automatic operation
of hazard warning lamps 102
Automatic rain sensitive
windscreen wipers..... 91
Automatic switching off
of lighting 88
- B** Battery 130
Battery, remote control 76
Blind..... 83
Bluetooth (telephone) 220-222
Boot lid..... 81
Bottle holder 64, 69
Brake discs 130
Brake lamps..... 142
Brake pads 130
Braking assistance system 103
Bulbs (changing, type)..... 137, 142
- C** Capacity, fuel tank 84
CD changer 175, 177
CD MP3 194, 196
- C** Changing a bulb 137, 142
Changing a wheel..... 132-135
Changing a wiper blade..... 153
Changing the time 39, 41
Check, particle emission filter... 130
Check, passenger
compartment filter..... 130
Checking the air filter..... 130
Checking the oil filter 130
Checks..... 130
Child seats 94, 95, 97, 101
Cigar lighter 66
Closing the boot..... 80, 81
Colour screen 41, 178, 179
Controls for air conditioning..... 46
Coolant 31, 32
Coolant level..... 129
Coolant temperature
warning lamp 32
Cooled glove box..... 64, 65
Courtesy lamp, front 92
Courtesy lamp, rear 92
Cruise control 121
Cup holder 64, 68, 69
CVT gearbox 113
- D** Deactivating ASC..... 104
Deactivating the passenger
airbag 108
Defrosting 46
Dials..... 21

ALPHABETICAL INDEX

- D** Diesel..... 128
Diesel additive level..... 129
Dimensions..... 161
Dipped beam 137
Direction indicators... 102, 137, 142
Doors 79
DVD (mode)..... 208, 209
Dynamic stability control
(ASC)..... 104
- E** EBFDF..... 103
Eco-driving 19
Economical driving 19
Electronic brake force distribution
(EBFD) 103
Electronic engine immobiliser... 74, 76
Emergency boot release..... 81
Emergency warning lamps 102
Engine, Diesel 29, 85, 128
Engine, petrol 85, 127
Engine compartment 127, 128
Engines..... 159
Environment 19, 76
Error messages
(audio equipment) 177
- F** Filling with fuel..... 84, 85
Fitting a wheel 135
Fittings, boot..... 70
Fittings, front..... 64
- F** Fittings, rear..... 69
Fitting the mat..... 63
Flashing indicators... 102, 137, 142
Foglamps..... 87
Foglamps, rear 142
Folding/unfolding
the door mirrors 61
Folding the rear seats..... 55
Four-wheel drive system 119
Front foglamps..... 87, 137
Front seats..... 50-52
Fuel..... 19, 84, 85
Fuel consumption 19
Fuel filler cap 84
Fuel filler flap 84
Fuel gauge..... 84
Fuel tank..... 84
- G** G.P.S. 180-182, 186
Gearbox, DCS 115
Gearbox, manual..... 130
Gear lever..... 19
Grab handles 69
Guidance 180-182, 186
- H** Hazard warning lamps..... 102
Headlamp adjustment..... 89
Headlamp wash..... 90
Head restraints 52
- H** Heated seats 52
Heating 19, 44, 46
Height adjustment,
steering wheel 63
Horn..... 102
- I** Identification plates..... 162
Indicator lamps, status..... 22
Indicators, direction 102
Inflating tyres 19
Instrument panel..... 21
Instrument panel screen..... 31
Interior fittings..... 64, 69
ISOFIX child seats..... 98-100
ISOFIX mountings 98-100
- J** Jack 132
- K** Keeping children
safe..... 76, 94, 97-101
Key in ignition warning..... 75
Key with remote control 76
- L** Labels, identification..... 162
Lamps, front..... 137
Lamps, rear 142
Level, battery 130
Level, brake fluid 129

ALPHABETICAL INDEX

- L** Level, headlamp wash..... 129
Level, power steering fluid..... 129
Levels and checks..... 127-130
Lighting bulbs
(replacement) 137, 142
Lighting control stalk..... 86
Lighting dimmer..... 43
Lighting on reminder..... 87
Loading..... 19
Load space cover 70, 72
- M** Main beam..... 137
Maintenance 19
Map (colour screen)..... 186
Map reading lamps..... 92
Mat..... 63
Menus (audio)..... 179
Mini fuel level..... 84
Mirror, rear view..... 62
Mirrors, door 61
Motorway function
(direction indicators)..... 102
Mountings for ISOFIX
seats..... 98-100
MP3 CD 204
Music server 194, 197, 202, 203
- N** Navigation..... 180-182, 186
Number plate lamps 142
- O** Oil level..... 129
Opening the boot 80
Opening the fuel filler flap..... 84
Opening the sunroof..... 82
Opening the tailgate 80, 81
Operation indicator lamps..... 22-24
- P** Parking brake 112, 130
Parking sensors, rear 123
Player,
CD MP3..... 166, 172, 177, 196
Protecting children..... 94, 97-101
Puncture 132-134
- R** Radio 169, 170, 190, 191
Range 31, 32
Rear demisting 46
Rear foglamp 87
Rear screen (demisting) 46
Recirculation/exterior air intake ... 46
Recording a CD 194, 197
Reinitialising the sunroof 82
Remote control 76
Removing a wheel 135
Removing the mat 63
Replacing bulbs..... 137, 142
Replacing wiper blades 153
Rev counter 21
Reversing camera 124
- R** Reversing lamps..... 142
Roof bars 157
Running out of fuel (Diesel) 126
- S** Safety for children..... 101
Screen,
instrument panel..... 21, 25-31
Screen, monochrome 39
Screenwash, front..... 90
Screenwash fluid level..... 129
Seat, rear bench 58
Seat adjustment..... 50, 51, 53
Seat belts..... 106, 107
Seat belts warning lamp 105
Seat configurations..... 57
Seats, electric..... 51
Seats, rear 53
Serial number, vehicle 162
Service indicator 31, 33
Servicing..... 19
Settings (Menus) 31
Setting the clock 39, 41
Sidelamps..... 137, 142
Side repeater..... 137
Spare wheel..... 132-135
Speedometer 21
Starting the vehicle 75
Steering mounted controls,
audio..... 166
Stopping the vehicle 75

ALPHABETICAL INDEX

- S** Storage 64, 70
Stowing rings 70, 71
Sunroof 82
Sun visor 63
System, audio-CD ... 169, 170, 172,
175, 177
System, audio-telematics ... 178-182,
186, 190,
191, 194, 196, 197, 202-204,
208-210, 213, 216, 217, 220-222
- T** Tailgate 80
TCL 104
Telephone,
hands-free 216, 217, 220-222
Temperature, coolant 32
Temperature adjustment 46
Third brake lamp 142
Tools 132
Total distance recorder 31, 32
Towbar 156
Towed loads 159
Towing another vehicle 154
TP (Traffic information) 170, 210
Traction control (TCL) 104
Trajectory control systems 104
Transfer box and rear
differential 130
Trip computer 31, 34
Tyre pressures 162
Tyres 19
- V** Vehicle identification 162
Ventilation 44
Video 208, 209
Voice commands 217, 220-222
- W** Warning lamp, low fuel level 84
Warning lamps 22-24
Weights 159
Wheel, changing 132-135
Wheelbrace 132
Windscreen zones for toll/
car park cards 63
Wiper control stalk 90, 91
Wipers 90, 91















This handbook describes all of the equipment available in the whole range.

Your vehicle will be fitted with some of this equipment described in this document, depending on its trim level, version and the specification for the country in which it is sold.

The descriptions and illustrations are given without any obligation. Automobiles CITROËN reserves the right to modify the technical specifications, equipment and accessories without having to update this edition of the handbook.

This document is an integral part of your vehicle. It should be passed on to the new user in the event of sale or transfer.

For any work on your vehicle, use a qualified workshop that has the technical information, competence and equipment required, which a CITROËN dealer is able to provide.

Automobiles CITROËN declares, by application of the provisions of the European regulation (Directive 2000/53) relating to End of Life Vehicles, that it achieves the objectives set by this regulation and that recycled materials are used in the manufacture of the products that it sells.

Reproduction or translation of all or part of this handbook is prohibited without written authorisation from Automobiles CITROËN.

Printed in the EU
Anglais
05-11

CITROËN AUTOMOBILES

Siège social : Immeuble Colisée III, 12 rue Fructidor - 75835 Paris Cedex 17 - France

TÉL. : +33 (0) 1 58 79 79 79 - www.citroën.fr

S.A. au capital de 16 000 000 € - R.C.S. Paris 642 050 199 - Siret 642 050 199 00644 - APE 741 J



11CCR.0040

Anglais

2011 – DOCUMENTATION DE BORD

4Dconcept
Diadeis
Edipro