



CITROËN E-MEHARI

HANDBOOK

CRÉATIVE TECHNOLOGIE

<https://www.automotive-manuals.net/>

Access to the Handbook



From the appropriate Store, download the **Scan MyCitroën** application for smartphone.

Then select:

- the vehicle,
- the print edition appropriate for the date of 1st registration of your vehicle.

Download the content of the vehicle's **Handbook**.



The **Handbook** is available on the CITROËN website, in the "MyCitroën" section or at the following address:
<http://service.citroen.com/ddb/>

Select:

- the language,
- the vehicle, its body style,
- the print edition of your handbook appropriate for the date of 1st registration of your vehicle.



Direct access to the **Handbook**.



This symbol indicates the latest information available.

Welcome

Thank you for choosing an E-MEHARI.

This document presents the information and recommendations required for you to be able to explore your vehicle in complete safety.

Your vehicle will be fitted with only some of the equipment described in this document, depending on its trim level, version and the specification for the country in which it was sold.

The descriptions and illustrations are given as indications only. Automobiles CITROËN reserves the right to modify the technical characteristics, equipment and accessories without having to update this edition of the guide.

If ownership of your vehicle is transferred, please ensure this **Handbook** is passed on to the new owner.

In this document, you will find all of the instructions and recommendations on use that will allow you to enjoy your vehicle to the fullest. It is strongly recommended that you familiarise yourself with it as well as the Maintenance and Warranty Guide which will provide you with information about warranties, servicing and roadside assistance associated with your vehicle.

Key



Safety warning



Additional information



Contributes to the protection of the environment



Left-hand drive vehicle



Right-hand drive vehicle

Contents

<hr/>					
	Overview	■			
Instruments and controls		3			
Presentation of your E-MEHARI		3			
<hr/>					
	Dashboard instruments	1			
Instrument panel		7			
Instruments and indicators on your E-MEHARI		8			
<hr/>					
	Access	2			
RFID personal key ring		10			
Central locking		10			
Doors		11			
Boot floor hatch		12			
Soft Top		12			
Front windows		15			
Rear quarter panels		16			
Rear screen		16			
Boot flap		17			
Hard Top		18			
Removing a roof panel		18			
Front windows		19			
Rear quarter panels		19			
Rear screen		20			
Boot flap and rear screen		20			
<hr/>					
	Ease of use and comfort	3			
Adjusting the driver's seat and the passenger's seat		22			
Front head restraints		23			
Access to the rear seats		23			
Folding rear bench seat		24			
Steering wheel (adjustment)		24			
Mirrors		25			
Ventilation/Heating		26			
Air conditioning (optional)		28			
Interior lighting		29			
Interior fittings		30			
<hr/>					
	Lighting and visibility	4			
Exterior lighting and signalling		31			
Wipers/Screenwash		33			
<hr/>					
	Safety	5			
General safety recommendations		34			
High voltage safety		35			
Anti-theft protection/Electronic immobiliser		36			
Assistance call		36			
ABS – ESP		36			
Seat belts		37			
Airbags		39			
Child seats		42			
Deactivating the passenger's front airbag		43			
ISOFIX mountings (child seats)		47			
Installation of a child seat compatible with the ISOFIX standard		47			
Visual indicators		48			
Horns and audible warnings		49			
<hr/>					
	Driving	6			
Driving recommendations		50			
Driving your E-MEHARI		50			
Starting/Switching off the vehicle		51			
Control pedals		52			
Manual parking brake		53			
Drive selector		54			
Electric power steering system		54			
Tyre under-inflation detection		55			
<hr/>					
	Practical information	7			
Maintaining and servicing your E-MEHARI		57			
Washing precautions		57			
Charging socket panel (access to the charging socket)		58			
Charging your E-MEHARI		58			
Under the bonnet		64			
Hibernation mode		66			
Audio system		67			
<hr/>					
	In the event of a breakdown	8			
Temporary puncture repair kit		69			
Replacing a bulb		69			
Replacing a fuse		70			
<hr/>					
	Technical data	9			
Identification markings/VIN		72			
Technical characteristics		72			
Dimensions/Weights		73			
Tyres/Tyre pressures		74			
Performance		75			
Brakes and suspension		76			
Braking system		76			
<hr/>					
	Alphabetical index	■			

Instruments and controls

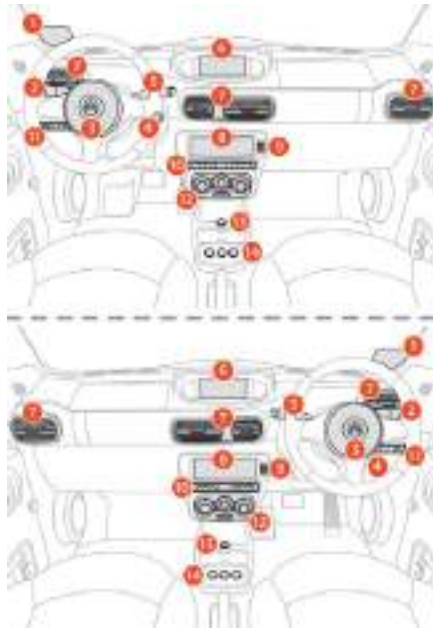

- (1) RFID reader.
- (2) Lighting/Direction indicator control stalk.
- (3) Horn.
- (4) Starting switch.
- (5) Wiper/Screenwash/Pedestrian horn.
- (6) Instrument panel.
- (7) Vents.
- (8) Central storage compartment.
- (9) USB socket.
- (10) Central control panel: assistance call/central locking/hazard warning lamps/air conditioning/automatic air recirculation.
- (11) Side control panel: foglamps/City power steering function/headlamp beam height adjustment.
- (12) Heating system.
- (13) 12 V accessory socket.
- (14) Driving mode selector.

Presentation of your E-MEHARI

An elegant design combined with the latest technology

Your E-MEHARI is an innovative electric vehicle with a new approach to mobility. Some of the vehicle's systems operate differently from those on a conventional internal combustion engine vehicle.

Your E-MEHARI uses energy stored in an LMP® (Lithium Metal Polymer) battery. The LMP® battery has to be charged before you can drive your E-MEHARI. The LMP® battery progressively discharges during use of the vehicle.

If the state of charge of the LMP® battery is at 0%, your E-MEHARI cannot be started: the LMP® battery must be charged.

A full recharge (from 0% to 100%) on a normal domestic power supply (standard charge) takes between 8 and 13 hours on average depending on the electrical system you have installed.

Your E-MEHARI uses two different types of battery: the LMP® battery to drive the vehicle and a 12 V battery, as on a conventional vehicle with an internal combustion engine. The 12 V battery provides the energy needed for operation of the vehicle's systems: e.g. the audio system, the exterior and interior lighting, the windscreen wipers.

To charge the LMP® battery, the vehicle has to be connected to a power supply. To improve its range, your E-MEHARI has an energy recovery system using the braking effect of the electric motor on deceleration.

Your E-MEHARI is a vehicle that emits no polluting gases, such as CO₂, nor micro-particles. Your E-MEHARI is also completely silent.

The LMP® (Lithium Metal Polymer) battery

! Your E-MEHARI contains a high voltage LMP® battery isolated from its surroundings by its unique packaging arrangement. The LMP® battery must only be handled by trained and qualified persons. Never handle the LMP® battery yourself: risk of severe burns, electric shock that could cause serious or fatal injuries and risks for the environment.

NEVER HANDLE THE LMP® BATTERY YOURSELF.

Precautions on the use of the LMP® battery

To avoid damaging the LMP® battery, it is recommended that:

- The vehicle be placed on charge straight away if the charge indicator drops to 0%.
- THE LMP® BATTERY NEVER BE USED FOR ANY OTHER PURPOSE.

! In order to offer its optimum range, your E-MEHARI's LMP® battery must be charged whenever possible, particularly during periods when it is parked for several hours. A battery charged to 100% cannot remain parked for more than 48 hours without being recharged.

i Due to its intrinsic characteristics, and in contrast to Li-ion batteries, the LMP® battery is not sensitive to exterior temperature conditions.

The vehicle's range has been type-approved in accordance with European Regulation ECE 101R01.

For more information on the service life of the LMP® battery, contact your CITROËN customer services.

! IT IS PROHIBITED to recycle or scrap the LMP® battery from your E-MEHARI. The LMP® battery is the property of Bluecar and must never be discarded.

i To help you charge your E-MEHARI's LMP® battery correctly, Bluecar may contact you to tell you that the charge level is becoming too low.

Driving with a discharged LMP® battery

When the level of charge of your LMP® battery becomes too low (20%): a warning lamp appears on the upper screen of the dashboard. Your E-MEHARI must be connected to a charging point that meets CITROËN's specifications without delay. The distance that your E-MEHARI can cover will be very limited and the output from the motor (the torque) will be automatically reduced to increase the potential range.

Precautions related to high voltage

! Your E-MEHARI uses a high voltage battery that can reach 450 volts. The temperature of the system can be high during and after starting and when the vehicle is switched off. Be aware of the high voltage. For more information on **High voltage safety**, refer to the corresponding section.

! Never dismantle, remove, replace or handle the high voltage components, cables and connectors as they can cause serious burns and an electric shock which could cause serious or fatal injuries.

The high voltage cables are orange in colour. There is no part of the high voltage system of your E-MEHARI that can be replaced by the user; this must only be done by a qualified professional.

Take your E-MEHARI to a CITROËN authorised repairer or a qualified professional for all maintenance and repair of the vehicle's high voltage system.

Precautions related to road accidents

! In the event of collision

- **If you can drive the vehicle:** move the vehicle to the side of the road, put the drive selector at position "N" (neutral), apply the manual parking brake and switch off your E-MEHARI.
- **Carry out a visual check of the condition of your E-MEHARI** to verify that no high voltage cable or component is visible. To avoid injury: never touch the cables, the connectors, the charger, the LMP® battery or any other part of the high voltage system on your E-MEHARI. You could suffer an electric shock if exposed cables are visible, whether you are inside or outside the vehicle. Never touch visible electric cables.
- **If the vehicle has sustained a heavy impact to the floor:** stop the vehicle in a safe area and check the condition of your E-MEHARI's floor.
- **If a fire has started in your E-MEHARI:** get out of the vehicle immediately. To extinguish the fire, use an extinguisher specially designed for electrical fires of the ABC, BC or C type. Use of water or the wrong type of extinguisher may cause

serious or even fatal injuries due to electric shock.

- **If your vehicle has to be recovered,** call a CITROËN authorised repairer or a qualified professional and have the front wheels lifted. If the vehicle is towed with the front wheels on the ground, the traction motor may produce electricity. This can damage the systems on your E-MEHARI and cause a fire.
- **If you cannot safely check the condition of your vehicle** because of the level of damage sustained, do not touch your vehicle. Contact the emergency services and specify that you have an electric vehicle. Inform the first to arrive at the scene of the accident that it concerns an electric vehicle.
- **In the event of an accident: you must contact a CITROËN authorised repairer or a qualified professional** who will send a person able to work on a damaged electric vehicle.
- **Observe the driving regulations on the safety of vehicles and third parties.**

Precautions in the event of an electrical failure

In the event of a general electric failure, your E-MEHARI will no longer be driven by the electric motor. As quickly as possible, you must place the vehicle in a safe area observing the driving regulations on road safety (hard shoulder, side of the road, etc.).

Immobilise your E-MEHARI, switch on the hazard warning lamps, get out of the vehicle and stand in a safe place, put on your high-visibility vest and call CITROËN ASSISTANCE, who will contact the emergency and roadside assistance services.

Special aspects of electric vehicles

Be particularly aware of pedestrians, cyclists, children and motorcyclists. Your E-MEHARI is a silent vehicle, and they may not hear you coming, which could give rise to collisions.

To avoid collisions with pedestrians, your E-MEHARI is fitted with a special horn. This special pedestrian horn allows you to announce your approach in a friendly and less aggressive way than would be the case with a conventional horn.

For more information on the **Horns**, refer to the corresponding section.

Before moving off, leave your foot on the brake pedal until you are ready to drive. Before getting out of your E-MEHARI, do not forget to put the drive selector back to position "N", apply the manual parking brake and switch off your vehicle.

- Your E-MEHARI has a system for energy recovery on deceleration. The main goal of the recovery of energy is to recover in the LMP® battery part of the energy generated when the vehicle is slowing down, in order to improve the range of the LMP® battery and thus the driving distance. In your E-MEHARI, it is the braking effect of the electric motor that plays this role.
- Special case: following a full charge of the LMP® battery and during the initial subsequent use of the vehicle, the braking effect of the electric motor may be temporarily reduced. You should adapt your driving as a consequence.
- We therefore recommend that you anticipate the need to slow down as much as possible, so as to obtain the maximum driving range.
- The brake pedal should be used to slow or stop the vehicle according to the road and traffic conditions. Your E-MEHARI's brakes do not provide any energy recovery.

Instrument panel

Instrument panel

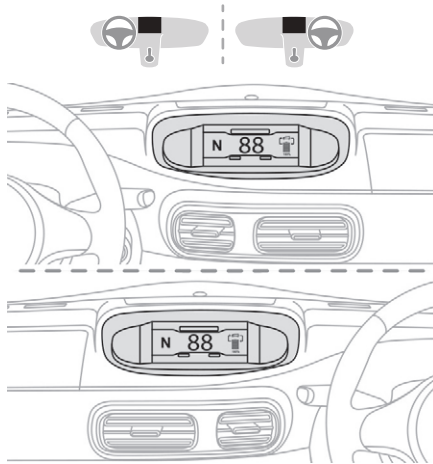

Warning and indicator lamps and instrument panel buttons



- (1) Battery fault.
- (2) Motor fault.
- (3) Charge indicator.
- (4) Instrument panel buttons.

! If warning lamp (1) or (2) is on, you must stop your E-MEHARI as soon as it is safe to do so.

Symbols

 Main beam headlamps

 Sidelamps

 Rear foglamp



Left-hand direction indicator



Right-hand direction indicator



Braking fault



Alert message



Flashing: ESP in action
Fixed: ESP fault



Demisting/defrosting



Passenger compartment heating active



Heating fault



Motor power limited

Dashboard instruments



Motor electrical problem



12 V battery charge low



Battery power limited



Battery electrical problem



Air conditioning active



Air conditioning fault



ABS fault



Power steering problem



Seat belt not fastened



Door open



Central locking



Boot open



Maintenance



Airbags fault



Deactivating the passenger's front airbag



Under-inflation/puncture



Pedestrian horn deactivated



City function activated

Instruments and indicators on your E-MEHARI

Instrument panel configuration menu



Your E-MEHARI's instrument panel is equipped with a configuration menu.

Navigation in this menu is by means of the 4 buttons on the right of the instrument panel:

- Arrows **(1)** and **(2)** navigate through this menu.
- The Squares button **(3)** is used to display the menu and confirm the selections.
- The Circles button **(4)** is used to go back and cancel.

In the menu, you have several choices:

Advanced settings

- Selection of the language.
- Speed units: km/h or mph
- Temperature units: °C or °F
- Reinitialisation of the under-inflation detection system

Setting the clock

- Auto/Manual
- Display format: 12 or 24 hour format

Automatic locking

- Activation/Deactivation of the locking the openings while driving function

Brightness

Setting the brightness in night mode.

Extended dormancy (Hibernation)

For more information on the **Hibernation mode**, refer to the corresponding section.

Consumption, charging, state of charge indicators

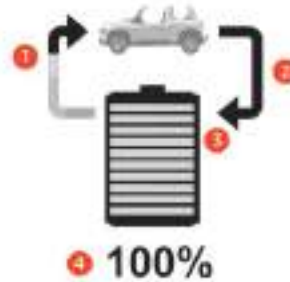

- (1) Image of power demanded.
- (2) Image of energy recovery.
- (3) LMP® battery state of charge indicator.
- (4) Percentage of charge remaining.

Distance recorders



- (1) Total distance covered (in miles (km)).
- (2) Distance covered since the last reset (in miles (km)).

Speedometer, temperature indicator and clock

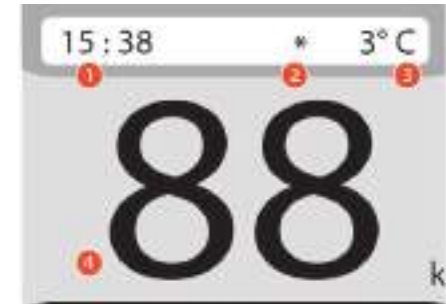

- (1) Clock.
- (2) Risk of ice indicator.
- (3) Exterior temperature.
- (4) Current speed.

RFID (Radio Frequency IDentification) personal key ring

The personal RFID key ring is supplied to you on handover of your E-MEHARI.

It is used to:

- Lock or unlock all the openings: the driver's door, the passenger's door and the boot flap.
- Activate or deactivate driving rights by operating the electronic immobiliser installed in your E-MEHARI.
- Lock or unlock the charging nozzle, as well as the secure compartment located in the boot.

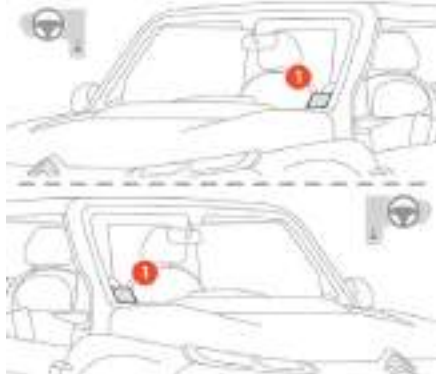

The personal RFID key ring reader (1) is located on the windscreen, driver's side. The reader only responds to your personal RFID key ring.

Unlocking the vehicle



Present your personal RFID key ring in front of the reader (1) located on the windscreen, driver's side.

The indicator lamp on the reader flashes green and the hazard warning lamps flash to confirm the opening of the doors and the driving rights.

Locking the vehicle

With the ignition switched off and the ignition key removed from the switch, present your personal RFID key ring in front of the reader (1) located on the windscreen, driver's side.

The indicator lamp on the reader flashes blue confirming the complete locking of the vehicle.

! Always remove the ignition key from the starting switch before locking your E-MEHARI. Otherwise, your vehicle will remain unlocked and the immobiliser will not be set.

i A non-authorized key ring results in the reader indicator lamp coming on fixed red.

Central locking

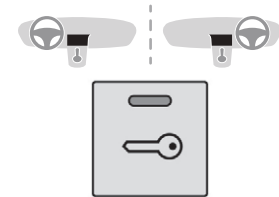

Central locking button lamp:

- Off: active driving with the car unlocked.
- On fixed: active driving with the car locked.
- One flash: inactive driving.
- Three flashes: locking malfunction.

Manual central locking

- Press this button to operate the central locking of the vehicle (doors and boot) from inside the vehicle.

The button indicator lamp comes on.

- Pressing the button again unlocks the vehicle completely.

The button indicator lamp goes off.

Automatic central locking of the doors (anti-intrusion security)

The doors and boot lock automatically when driving, as soon as the speed exceeds 6 mph (10 km/h).

To turn this function on or off (on by default):

- With the ignition on, press the central locking button until a padlock appears in the instrument panel.

! If one of the doors or the boot is open, automatic central locking does not occur: the sound of the locks rebounding can be heard.

! Driving with the doors locked could make access to the passenger compartment by the emergency services more difficult in an emergency.

Back-up procedure

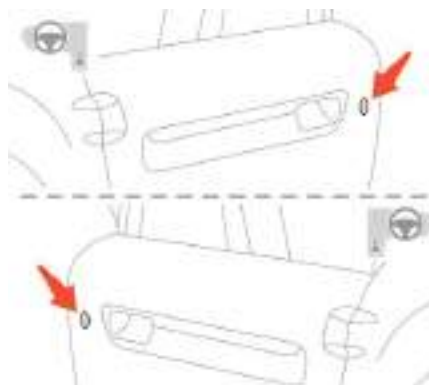

In the event of a malfunction of the RFID reader, you can lock or unlock your vehicle using the key.

Unlocking with the key

Turn the key in the driver's door lock towards the front of the vehicle to unlock.

i Unlocking with the key does not enable your authorisation to start the vehicle. Only the RFID key ring can serve this purpose.

Locking with the key

Turn the key in the driver's door lock towards the rear of the vehicle to lock it.

i Check that the doors and boot are fully closed.

Doors

! Always look in your mirror and check the blind spot for the approach of another vehicle before opening your door. Never leave children unsupervised inside the vehicle. Children could operate the switches and controls. Unsupervised children run the risk of a serious accident.

Access

After unlocking the vehicle using the RFID reader or the key in the barrel, pull the door handle.



(1) Exterior door handle.

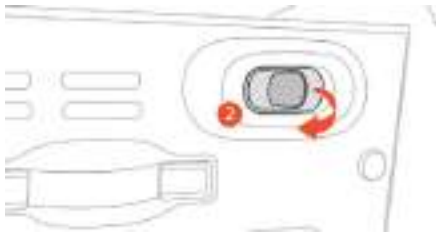

(2) Interior door handle.

Boot floor hatch

This secure compartment is unlocked at the same time as the doors.



To open the boot floor hatch: pull the latch (1) then raise it using the grip (2).

! Ensure that the boot floor hatch is properly closed before starting the vehicle.

Soft Top

Fabric roof

Removing and refitting the roof panels



The front and rear parts are removed and refitted in the same way.

Fitting a roof panel

Engaging the latches

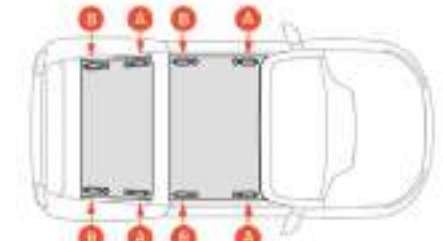

Unlocking the latches

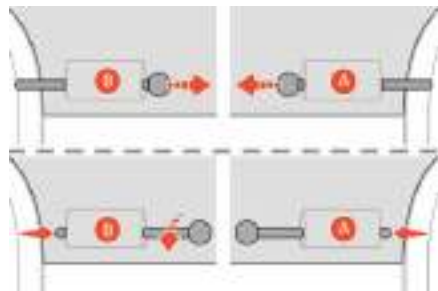

To fix the rear latches **(B)** in the open position, pull them and turn a quarter turn, and they will retain this position.

For the front latches **(A)**, keep pulling to reach the open position.

Locking the latches

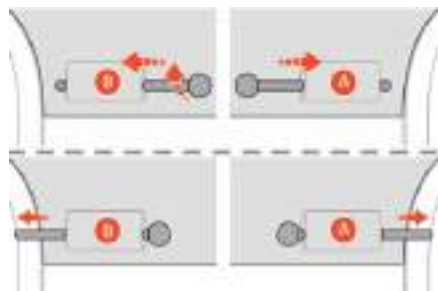

To unfix the rear latches **(B)** and put them in the closed position, turn them a quarter turn and guide their movement.

For the front latches **(A)**, pull then simply let them go to reach the closed position.

Positioning the roof panel



Place the roof panel on one of the sides of the vehicle.



Take care to position it facing the right way, the white labels **(1)** must be directed towards the front of the vehicle.

Fixing and locking the brackets

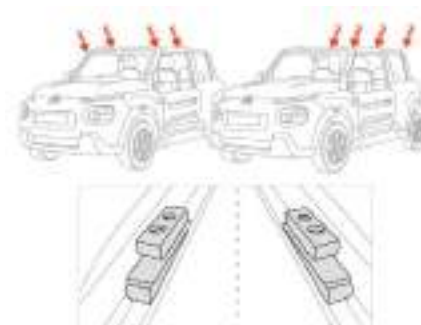

The positioning brackets are arranged on the arches of the vehicle.



Ensure that the locks are in the open position **(1)**, then position the male brackets **(2)** of the panel in the female brackets **(3)** located on the front and rear arches on the side chosen.

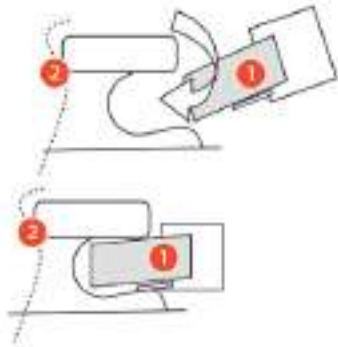

Pivot the panel so that its brackets **(1)** are inserted in those located on the arch **(2)**.



Once the 2 pairs of brackets are in place, press on the panel to retain it on the arches.

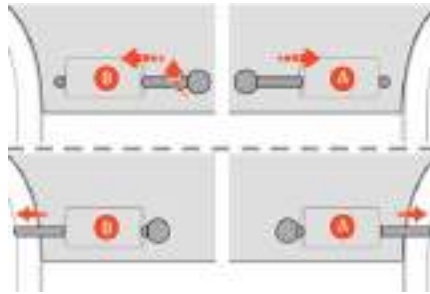

From inside the vehicle, lock the panel at each corner, taking care to put each of the latches **(A)** and **(B)** in the closed position.



Once the first 2 latches are closed, unroll the panel on the arches towards the other side of the vehicle.



Go to the other side of the vehicle and position the other brackets of the panel. Once the panel is positioned correctly, the latches must be closed.

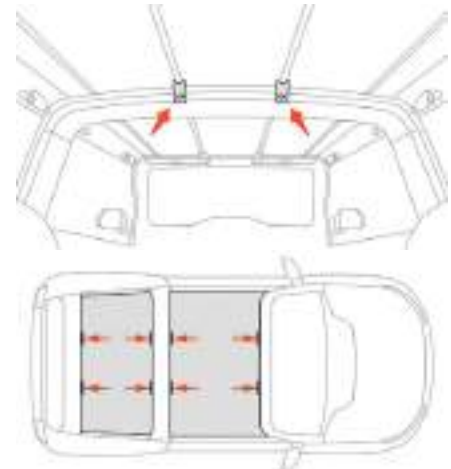

Once the panel is secured and the latches closed, it is necessary to attach each of the panel straps located in the middle by attaching them to the arches of the vehicle.

Check before setting off

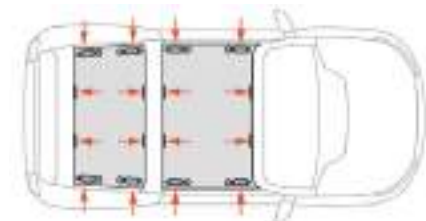

To ensure that the panels are retained correctly while driving, check for each of the panels that the straps and the latches are attached correctly.

Removing a roof panel

Detach the straps positioned in the middle of each panel.
Next, press with your hand on one of the 4 corners of the roof panel to remove and open each of the latches.
Roll up the fabric as you advance.
Repeat the procedure with the other panel if you want to remove it.

Stowing a roof panel

The rolled-up one-piece roof panel can be stowed under the boot floor hatch. For more information on the **Boot floor hatch**, and, in particular, how to open it, refer to the corresponding section.

! Detaching and attaching the fabric roof must only be done with the vehicle stationary.

Front windows

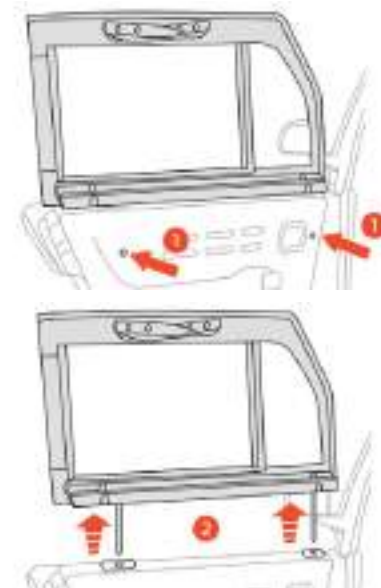

Slacken the screws (1) on the interior side of the door, then remove the released window by pulling it up (2).

2

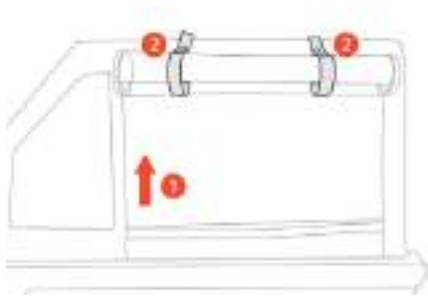

Carry out the operation in reverse order to refit the window.
You can also raise the window by unzipping each side (1) and securing it at the top with the straps provided (2).
When the straps are not in use, they can be used as grab handles.

Rear quarter panels

! Always remove the rear roof panel before removing the quarter panels.

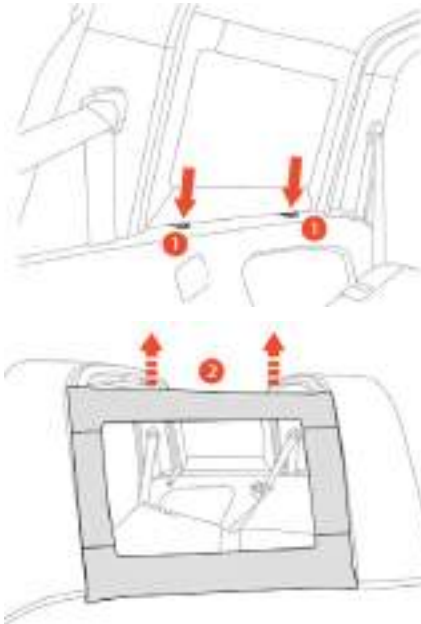

Remove the screws (1) on the interior side, then remove the released quarter panel by pulling it up (2).
Carry out the operation in reverse order to refit the quarter panel.

Rear screen

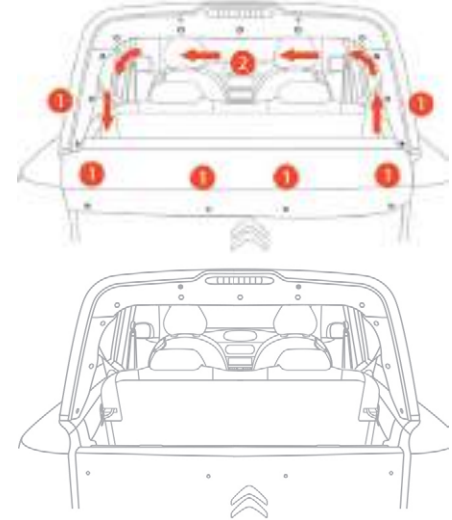

To remove the rear screen, detach the press stud fasteners (1) then unzip the screen (2) from right to left.

! To avoid any risk of tearing, we recommend that you lift or remove the rear screen when lifting or removing the front parts (roof panels, windows or rear quarter panels).

! Always unzip the rear screen from right to left.

Carry out the operation in reverse order to refit the screen.

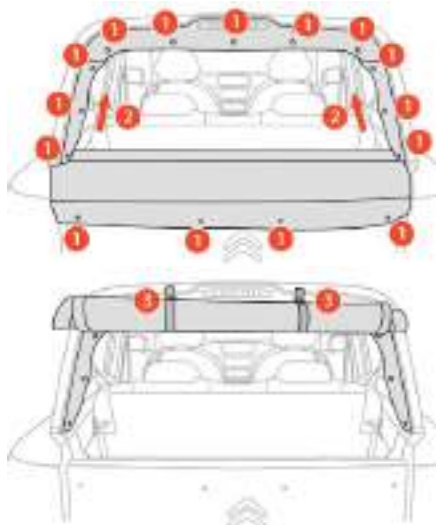

You can also remove the rear screen by detaching the press stud fasteners (1) then unzipping it on each side (2) and clipping it at the top using the straps provided (3) inside the vehicle.

Boot flap

Opening the boot flap



The boot flap on your E-MEHARI is opened by pressing on the grip (1) located in the central flap recess.

! When the flap is lowered, it can support a maximum load of 100 kg.

Closing the boot flap



- Raise the boot flap and guide it into position until the movement is complete.
- Press firmly on the exterior of the boot flap to close it.

! Once raised, check that the boot flap is closed and fully latched home so that it cannot open on its own when the vehicle is moving. Always drive with the boot flap closed. If objects carried extend beyond the boot flap, you should never use the boot flap to jam or retain them.

2

Hard Top Rigid roof

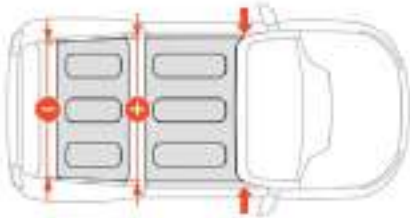

Removing a roof panel

Removing the front roof panel

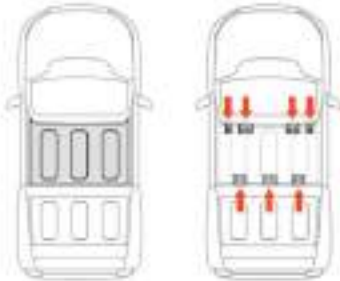

Remove the mounting lugs while another person holds the roof from outside.



Lift the rear part of the panel (1) first, then the front part (2) and release it completely.

Removing the rear roof panel

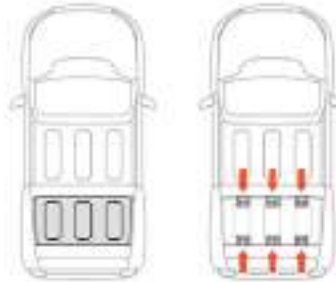

Remove the mounting lugs while another person holds the roof from outside.

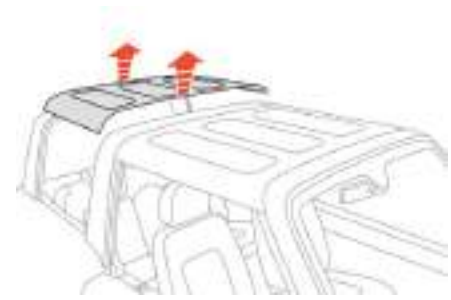

Lift and completely release it.

! To avoid any scratches on the vehicle when removing the roof panels, make sure that all screws and mounting lugs are removed before lifting the roof panels.

Reassembly: proceed in the reverse order to reassemble the roof panels. The mounting lugs must be screwed to the roof panel and engage with the recessed groove of the vehicle's pillars.

Check before setting off

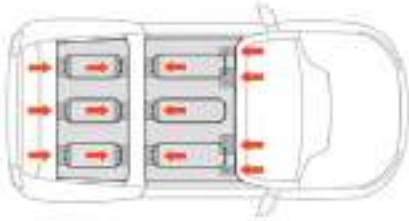

To ensure that the panels are retained correctly while driving, check that each panel is properly positioned and secured.

Front windows

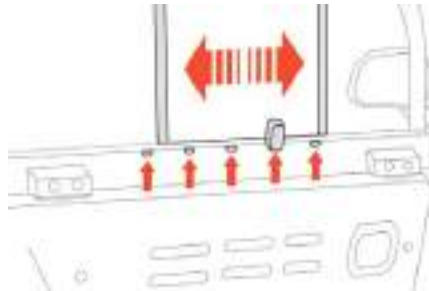

On the Hard Top variant, the opening of the windows can be adjusted. You can select 5 positions.

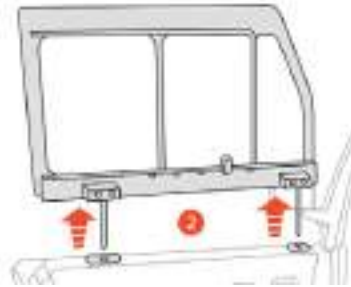

Slacken the two screws **(1)** on the interior side of the door, then remove the released window by pulling it up **(2)**.

Carry out the operation in reverse order to refit the window.

Rear quarter panels

Removing



Remove the screws **(1)** at the bottom part on the interior side, then remove the released quarter panel by pulling it up **(2)**.

2

Refitting

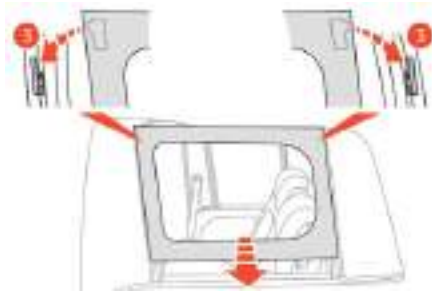

Lean the rear quarter panel against the vehicle in its position from the outside of the vehicle, raise it a few centimetres and slide down until you feel it engage with the brackets **(3)**. Once the rear quarter panel is positioned, replace the screws on the bottom part of the rear quarter panel from inside the vehicle.

Rear screen

! it is recommended that the rear screen always be handled by 2 persons.



To remove the Hard Top rear screen, first open the boot flap.

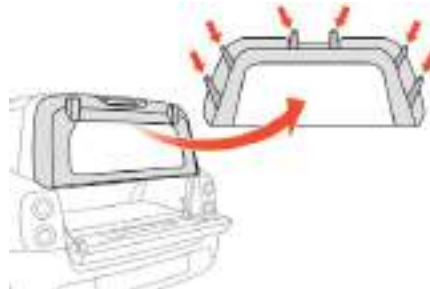

While one person holds the rear screen, the second person slackens the 6 screws inside the vehicle, 2 on the left, 2 at the top and 2 on the right. Once the screws are removed, the person inside the vehicle gets out to help the second person to pull the lower part while raising it slightly.



When the entire assembly is disengaged, lift the rear screen to remove it completely. Carry out the operation in reverse order to refit the screen.

Boot flap and rear screen Opening



When the boot flap is in the open position **(1)**, you can open the rear screen **(2)**.

Closing



Carefully close the rear screen (1) and lift the boot flap.

Press firmly on the exterior of the boot flap to close it.

! Once raised, check that the boot flap is closed and fully latched home so that it cannot open on its own when the vehicle is moving.

Always drive with the boot flap closed.

If objects carried extend beyond the boot flap, you should never use the boot flap to jam or retain them.

! It is recommended to store your various removed components in a secure place in order to keep them in a good condition.

Adjusting the driver's seat and the passenger's seat

! Never leave children unsupervised inside the vehicle. Children could operate the switches and controls. Unsupervised children run the risk of a serious accident.

! The seat belts must be correctly adjusted. The seat belts are more effective when the passenger is seated fully back and down in the seat.

Adjusting the seat forward and backward



Hold the lever up while sliding the seat forward

or backward to the desired position. Release the lever to lock the seat in position. After adjusting the position of the seat, move the seat forward and backward slightly to check that it has locked in place.

! Adjust the seats only when the vehicle is stationary: otherwise the seats might move out of position unexpectedly while the vehicle is moving and lead to loss of control of the vehicle.

! Do not touch the moving parts while adjusting the position of the seat, so as to avoid the risk of injury or damage to the vehicle.

Adjusting the height of the seat cushion

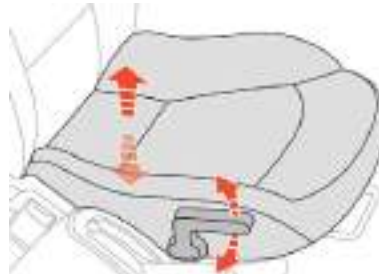

Operate the lever to raise or lower the rear part of the seat to improve the ride comfort.

Adjusting the backrest

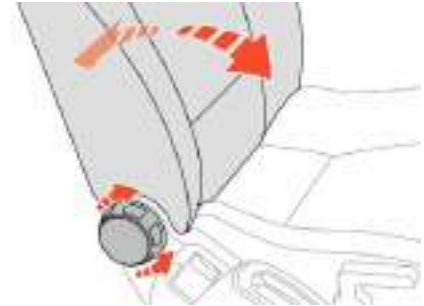

To recline the seat backrest, turn the knob to the rear.

To straighten the backrest, turn the knob forwards.

! Never leave the seat backrest in the reclined position while driving the vehicle; the diagonal belt would not lie in an effective position against the body. Having the seat backrest in a reclined position could increase the risk of serious injury. In the event of an accident, you could be thrown against the belt and suffer injuries to your neck or other serious or fatal injuries. Having the seat backrest in a reclined position also increases the risk of being thrown forward, slipping under the lap belt, giving rise to serious internal injuries.

! The seat backrest must be in the vertical position to ensure effective protection while driving. It is essential to sit fully down in the seat so that the lap seat belt is able to work effectively in the event of an accident. Driving with a seat in the "sleeping" position is prohibited. Adjust the seat to your wishes with the backrest reclined no more than necessary for comfort.

! After adjustment, try to gently tip the seat backrest back and forward to ensure that it has locked into position.

! Before setting off, check that each passenger's head restraint is present and correctly adjusted.

Front head restraints

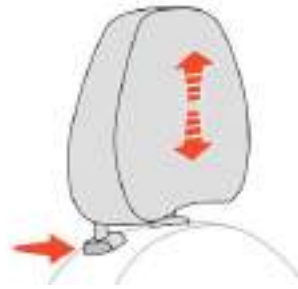

Adjusting a front seat head restraint:

- To raise a head restraint, pull it upwards.
- To remove the head restraint, press the lug and pull the head restraint upwards.
- To put it back in place, engage the head restraint rods in the openings keeping them in line with the seat backrest.
- To lower it, press on the lug and on the head restraint at the same time.

! Never adjust the head restraints while the vehicle is moving. Driving without the head restraints in place is strictly prohibited.

Access to the rear seats

To access the rear bench seat of your E-MEHARI: pull the seat tipping lever of one of the two front seats.



Then tip the seat forward to give access to the rear bench seat of your E-MEHARI.

To return the seat to the normal position: guide the seat backrest to its initial position. Ensure that the seat has latched home correctly before moving off.

3

Folding rear bench seat

Your E-MEHARI has been type-approved as a four-seat vehicle.

The rear bench seat is a folding bench seat for two people.

Only the backrest folds, the cushion remains fixed.

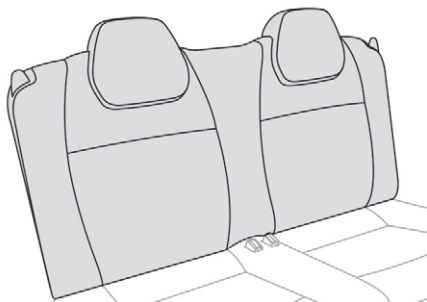

! Your E-MEHARI has been type-approved for use on European roads carrying up to 4 people: the driver and three passengers. You must never carry more than two people on the bench rear seat.

Your E-MEHARI is fitted with 2 rear seat belts.

Any additional passenger, who would not be restrained, would risk serious or fatal injuries and also risk injuring other occupants of the vehicle.

Operation



Pull the controls (1) on each side of the bench seat to release the latches (2).



Fold the backrest (3) forward.

Adjusting the rear head restraints

- To raise a head restraint: pull it up to the desired position.
- To lower a head restraint: push it down to the desired position.

! Never adjust the head restraints while the vehicle is moving.

! Take care not to trap the seat belts and position the seat belt buckles correctly before folding the backrest.

Steering wheel (adjustment)

The height and reach of your E-MEHARI's steering wheel are adjustable.

! Do not adjust the steering wheel while driving the vehicle: this would risk causing a loss of control of the vehicle and could lead to an accident.

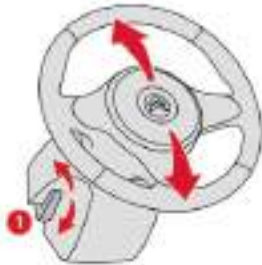

Push the lever **(1)** up to release the locking mechanism and then adjust the position of the steering wheel.

Lower the lever **(1)** to lock the adjustment mechanism in the desired position.

Before driving, check that the adjustment mechanism is locked.

Mirrors

Your E-MEHARI has 3 mirrors:

- Two exterior door mirrors.
- A central interior rear view mirror.

Door mirrors

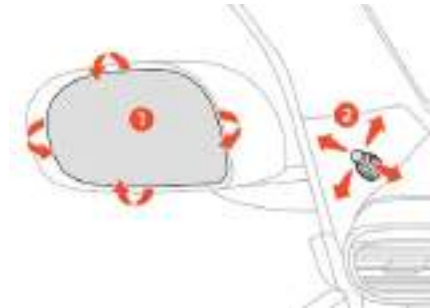

The door mirrors **(1)** are adjustable manually. Direct each mirror using the levers **(2)**.

! Objects seen in the passenger's side door mirror are closer than they appear. Take care when changing direction toward the nearside. Using only the passenger's side door mirror could cause accidents. Make use of the interior rear view mirror and the driver's side door mirror or look behind to estimate distances correctly.

Rear view mirror

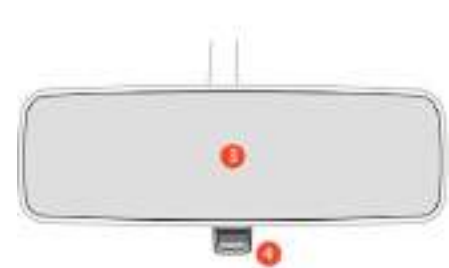

(3) Interior rear view mirror.
(4) Day/night mode control lever.

To adjust the interior rear view mirror: adjust the angle of the mirror to the desired position by hand.

! Objects seen in the interior rear view mirror are closer than they appear.

! Only use the night position when necessary. It reduces the clarity of the mirror.

3

Ventilation/Heating

Air intake

Air entering the heating and ventilation system follows different paths according to the settings made by the driver or passengers.

Air circulating in the passenger compartment is filtered and comes either from outside the vehicle or is recirculated from inside the vehicle.

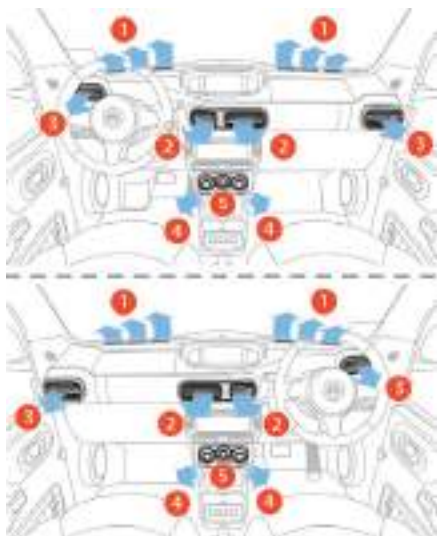

(1) Windscreen demisting/defrosting vents.

- (2) Central air vents.
- (3) Side air vents.
- (4) Footwell air outlets.
- (5) Heating and ventilation controls.

Recommendations on ventilation and heating

Ventilation

Observe the following recommendations for the ventilation system to be fully effective:

- For a uniform distribution of air: take care not to obstruct the air intakes at the bottom of the windscreen or the nozzles, vents and air outlets inside the vehicle.
- Give preference to the intake of exterior air: prolonged use of air recirculation can cause misting of the windscreen and quarter panels.

Heating

It operates directly on energy from your E-MEHARI's LMP® battery. Its use increases the vehicle's consumption of electrical energy and reduces its range. Remember to switch off the heating when it is no longer needed.

The ventilation and heating systems are more effective when the vehicle is fully fitted with its roof and sides.

Heating controls

With automatic air recirculation.

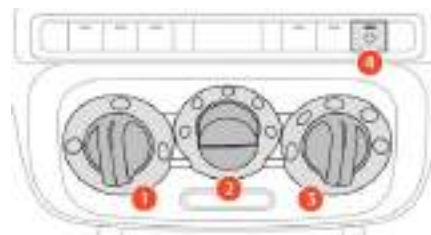

- (1) Air temperature control.
- (2) Air flow control.
- (3) Air distribution control.
- (4) Air recirculation control.

The control for:

- air temperature (1) is used to adjust the temperature of the air delivered,
- air flow (2) is used to adjust the speed of the booster air fan,
- air distribution (3) is used to choose which air vents to use in the passenger compartment,
- air recirculation (4) allows you to limit odours, smoke and any external unpleasantness entering your E-MEHARI's passenger compartment.

Air temperature control

To adjust the temperature of the air delivered

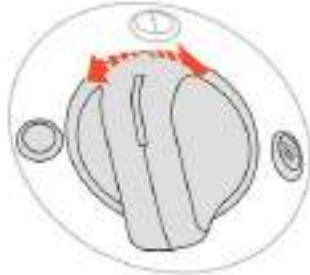

Turn the control knob to the right (red) for hot air.
Turn the control knob to the left (blue) for cool air.

Air flow control

To increase the air flow



Turn the control knob to the right.

To decrease the air flow

Turn the control knob to the left.

i The highest setting gives the fastest demisting/defrosting.

Air distribution control



Depending on your selection, the air flow will be directed to:

- The air vents
- The air vents and footwells
- The footwells
- The footwells and the windscreen
- The windscreen (demisting/defrosting)

3

Automatic air recirculation control

Your E-MEHARI has an air recirculation control.

This air recirculation position is not to be used continuously as it can cause misting.

As soon as you can: return to the exterior air intake position or the central position if you want more heating.

Automatic air recirculation

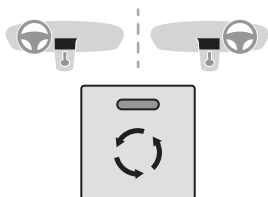

The recirculation of interior air is automatic and is managed according to the exterior temperature so as to optimise comfort. It is possible to activate air recirculation manually by pressing the control button. The indicator lamp in the button then comes on.

Demisting/defrosting

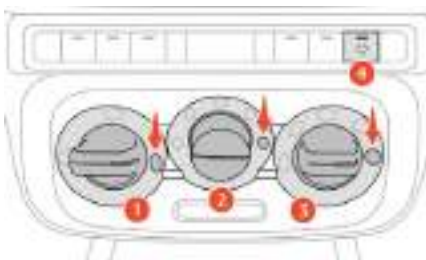

To quickly raise the temperature in the passenger compartment and direct air to the windscreen and quarter panels, several actions are necessary:

- Position the controls for temperature (1), air flow (2) and distribution (3) at the windscreen demisting/defrosting position.
- Do not use the air recirculation control (4).

Advice

Reduce the air flow setting (2) as soon as the higher speed is no longer necessary, so as to limit the energy consumption of your E-MEHARI and optimise its range.

Air conditioning (optional)

Heating and air conditioning controls

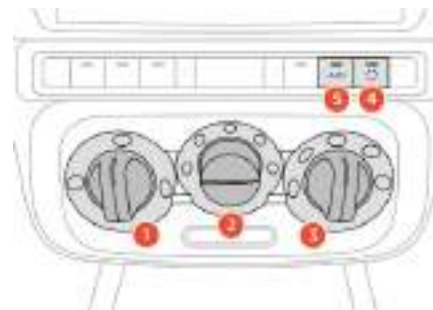

- (1) Air temperature control
- (2) Air flow control
- (3) Air distribution control
- (4) Automatic air recirculation control
- (5) Air conditioning control

Switching on the air conditioning

To switch on the air conditioning ($T^{\circ} > 19^{\circ}\text{C}$), press button (5) and position the temperature control (1) at blue.

A/C

An A/C indicator lamp appears in the instrument panel.

To switch off the air conditioning, press button (5) again.

You can operate the automatic air recirculation to increase the effectiveness and speed of the air conditioning (no demisting/defrosting).

! To be effective, the air conditioning should only be used with the windows closed. If the exterior temperature is below 19°C, the instruction is received but the air conditioning will not come on. If the air flow setting is at minimum when the air conditioning is switched on, the system manages the air flow automatically to optimise ventilation. The condensation created by the air conditioning results in a discharge of water under the vehicle which is perfectly normal.

! **Advice**
Operate the air conditioning system at least once a month to keep it in perfect working order.

Interior lighting

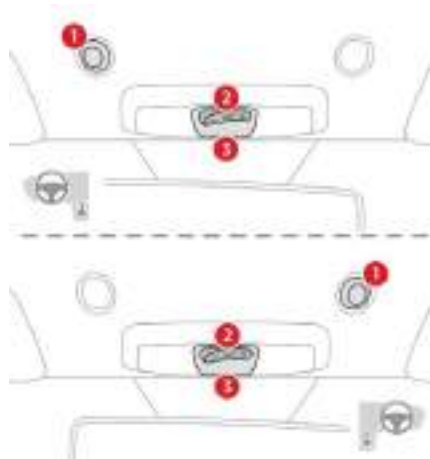

- (1) Assistance call microphone
- (2) Courtesy lamp switch
- (3) Courtesy lamp/Mood lighting

Your E-MEHARI's courtesy lamp comes on automatically on opening the doors and goes off when closing the doors or when you switch the vehicle on.

Courtesy lamp



In this position, the courtesy lamp comes on gradually:

- when the vehicle is unlocked,
- when the key is removed from the ignition,
- when opening a door.

It switches off gradually:

- when the vehicle is locked,
- when the ignition is switched on,
- 30 seconds after the last door is closed.



Permanently off.



Permanent lighting.

- i** In permanent lighting mode, the lighting time varies according to the circumstances:
- when the ignition is off, approximately ten minutes,
 - in energy economy mode, approximately thirty seconds,
 - with the motor running, unlimited.

! Before leaving the vehicle, check that the courtesy lamp is no longer on. This component is powered by the 12 V battery, which could be completely discharged if it is left on.

Interior fittings

General view

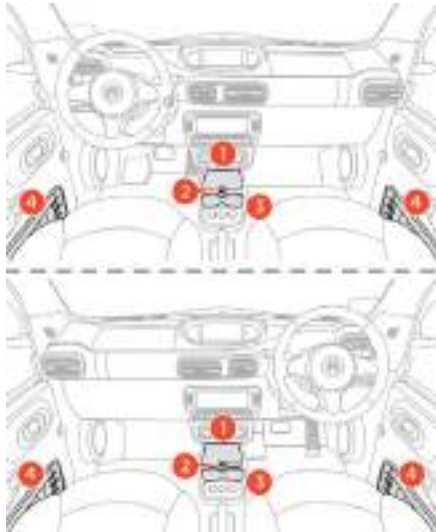

- (1) Central storage compartment.
- (2) 12 V accessory socket (cigarette lighter).
- (3) Cup holders.
- (4) Storage compartments.

12 V socket

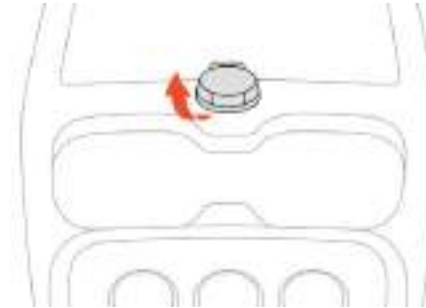

Remove the cap and use a suitable adaptor to connect a 12 V accessory (maximum power 120 W) to the socket.

USB socket for audio system and recharging electronic devices

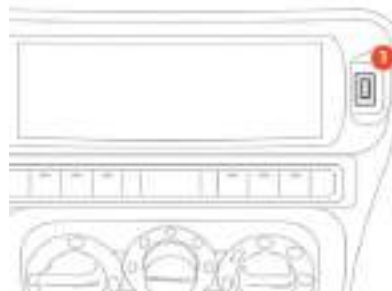

This USB socket (1) can be used to recharge some electronic devices such as mobile phones (although not all are compatible) with a maximum power of 500 mA. The USB socket is also compatible with the vehicle's audio system. For more information on the **Audio system**, refer to the corresponding section.

Exterior lighting and signalling

Exterior lighting

Your E-MEHARI is provided with different types of exterior lighting: daytime running lamps, sidelamps, dipped beam headlamps, main beam headlamps, a reversing lamp and a rear foglamp.

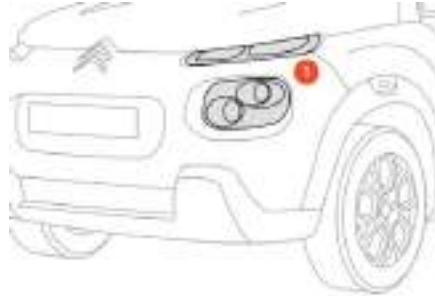

(1) Sidelamps (daytime running lamps)/ direction indicators/dipped beam headlamps/ main beam headlamps.

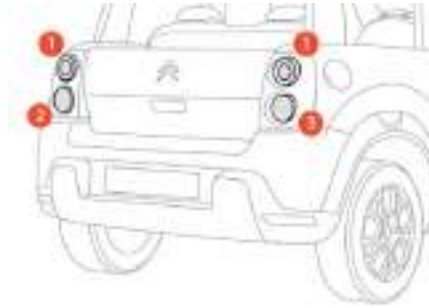

- (1) Rear sidelamps/brake lamps/direction indicators.
- (2) Rear foglamp (left-hand side).
- (3) Reversing lamp (right-hand side).

Exterior lighting control stalk

The exterior lighting control stalk on your E-MEHARI is behind the steering wheel on the left-hand side.

This control stalk is used to operate the exterior lighting and the direction indicators.

The daytime running lamps and sidelamps come on automatically every time the vehicle is started.

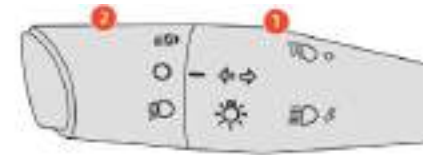

- (1) Headlamp dipping control, for switching between dipped and main beam.
- (2) Exterior lighting control.

Main lighting

Dipped beam headlamps

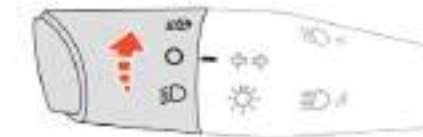

With the ignition on, place the control in this position.

Headlamp dipping control

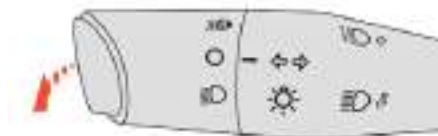

The headlamp dipping action of the lighting control stalk can be used in two ways:

- With the vehicle started, pull the stalk briefly toward you to flash the headlamps.



With the dipped beam headlamps on: pull the stalk toward you to change to main beam.

To change back to dipped beam: pull the stalk toward you again.

Automatic illumination of headlamps



When a low level of external light is detected by the sunshine sensor, the number plate lamps, sidelamps and dipped beam headlamps are switched on automatically, without any action on the part of the driver.

As soon as the level of light becomes sufficient again, the lamps are switched off automatically.

Rear foglamp

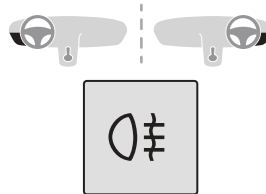

To switch on the rear foglamp:



Put the main control stalk in the dipped beam position.

Press the foglamp control button.

To switch off the foglamp: press the control button again.

! Using the foglamp is prohibited under conditions of normal visibility, both day and night.

In such conditions, the brightness of the lamp could dazzle other drivers.

Do not forget to switch off your foglamp once its use is no longer necessary.

Adjusting the headlamps

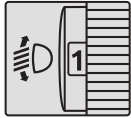

The headlamp beam height on your E-MEHARI should be adjusted according to the load and number of passengers in your vehicle, so as to avoid causing a nuisance to other drivers. Your E-MEHARI has a thumbwheel for adjusting the height of the beams.

Select the desired position using the headlamp beam height adjustment control. Use position "0" when driving without heavy loads.

Wipers/Screenwash

Your E-MEHARI has two windscreen wipers.



To activate the wipers: turn the ring on the control stalk located on the right behind the steering wheel.

3 positions for the control:

- Position 1: intermittent wipe.
- Position 2: continuous wipe.
- Position 3: fast continuous wipe.

Pushing the control stalk down gives a single wipe.

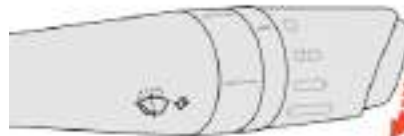

Operation of the screenwash: pull the wiper control stalk towards you.

This action automatically operates the windscreen wipers and the screenwash.

! In low temperatures, use a screenwash fluid with adequate protection against freezing.

! Do not operate the screenwash for more than 30 seconds, as this could lead to a loss of visibility and cause an accident.

! Do not operate the screenwash control when the fluid reservoir is empty.

General safety recommendations

! Labels are attached in different places on your vehicle. They include safety warnings as well as identification information for your vehicle. Do not remove them: they are an integral part of your vehicle.

! For any work on your vehicle, use a qualified workshop that has the technical information, skills and equipment required, all of which a CITROËN dealer is able to provide.

! We draw your attention to the following points:

- The fitting of electrical equipment or accessories not listed by CITROËN may cause excessive current consumption and faults and failures with the electrical system of your vehicle. Contact a CITROËN dealer for information on the range of recommended accessories.
- As a safety measure, access to the diagnostic socket, used for the vehicle's electronic systems, is reserved strictly for CITROËN dealers or qualified workshops, equipped with the special tools required (risk of malfunctions of the vehicle's electronic systems that could cause breakdowns or serious accidents). The manufacturer cannot be held responsible if this advice is not followed.
- Any modification or adaptation not intended or authorised by CITROËN or carried out without meeting the technical requirements defined by the manufacturer will result in the suspension of the legal and contractual warranties.

! Installation of accessory radio communication transmitters

Before installing a radio communication transmitter with an external antenna, you must contact a CITROËN dealer for the specification of transmitters which can be fitted (frequency, maximum power, aerial position, specific installation requirements), in line with the Vehicle Electromagnetic Compatibility Directive (2004/104/EC).

! Depending on country regulations, some safety equipment may be compulsory: high visibility safety vests, warning triangles, breathalysers, spare bulbs, spare fuses, fire extinguisher, first aid kit, mud flaps at the rear of the vehicle, etc.

High voltage safety



This symbol identifies electric components in the vehicle that could present a risk to your safety.

Presentation

Your E-MEHARI has an LMP® battery operating at voltages that can reach 450 V supplying continuous current.

This diagram presents the locations of the different units on your E-MEHARI (LMP® battery, drive train, 12 V battery, RFID reader).

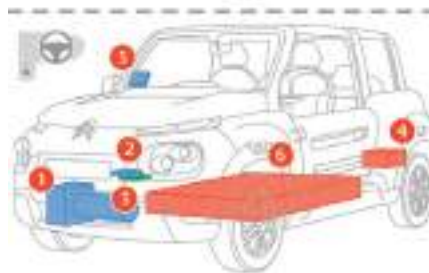
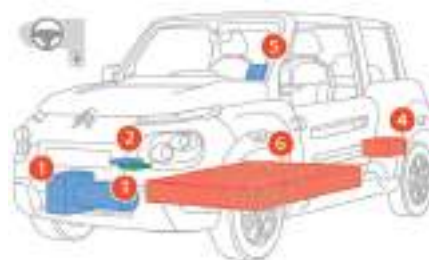

- 1 Drive train
- 2 Passenger compartment fuses
- 3 Power fuses
- 4 12 V battery
- 5 RFID reader
- 6 LMP® battery

! It is strictly prohibited for any non-qualified person to work on your vehicle's high voltage system. Incorrect handling could lead to the creation of an electric arc or electric shock which could cause serious or fatal injuries or burns.

! If there is a problem with your E-MEHARI, please contact CITROËN ASSISTANCE as soon as possible either by telephone or by using the blue assistance call button on the central console of your E-MEHARI. For more information on the **Presentation of your E-MEHARI**, and, in particular, the assistance call, refer to the corresponding sections.

! The servicing and repair of your E-MEHARI must be entrusted to a CITROËN authorised repairer or a qualified professional. This includes all parts of the high voltage system. Handling the components of the high voltage system is strictly prohibited. Only trained and qualified persons can work on these components. CITROËN has a network of authorised repairers trained in working on the high voltage system of the vehicle.

5

Power cut-off in the event of an impact

In the event of an impact or accident, an impact detection system on your E-MEHARI cuts off the vehicle's high voltage power supply.

Anti-theft protection/ Electronic immobiliser

Your E-MEHARI is fitted with an electronic immobiliser.

This immobiliser is directly linked to your personal RFID key ring.

Only your personal RFID key ring gives authorisation to use your E-MEHARI.

! Check that your key is at the STOP position of the starting switch or removed from the starting switch before locking your E-MEHARI.

Assistance call

Your E-MEHARI is equipped with an assistance call control button.

This service puts you in 24/7 contact with an adviser trained to help you take the appropriate action and who will have answers for situations where you may encounter problems.

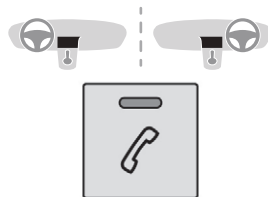

The assistance call button is connected to a hands-free communication system, allowing you to remain attentive while driving your vehicle.

To call CITROËN ASSISTANCE or end the call, press the assistance call button. If you receive a call while you are in the vehicle, the system answers it automatically.

ABS – ESP

! These systems are additional aids when driving in critical situations, allowing the behaviour of the vehicle to be adapted to the driver's wishes. However these systems do not intervene in place of the driver. They cannot extend the vehicle's limits and should not encourage you to drive faster. They cannot, in any circumstances, replace the need for vigilance, or the responsibility of the driver when manoeuvring the vehicle (the driver must always be watchful for sudden events that could occur while driving).

ABS (anti-lock braking system)

The ABS prevents locking of the wheels under heavy braking, so optimising the stopping distance and allowing control of the vehicle to be retained.

In these conditions, avoidance manoeuvres during braking are therefore possible.

In addition, this system optimises the stopping distance on surfaces offering poor grip (wet roads, etc.).

Operation of the system can be felt by vibration in the brake pedal.

The ABS does not improve the "physical" performance possible, which depends on the grip between the tyres and the road.

It follows that the normal safe driving practices must be observed (distance between vehicles, etc.).

! In an emergency, it is recommended that you apply the brakes firmly and continuously. It is not necessary to successively apply and release the brakes (pumping the pedal). The ABS will modulate the brake effort applied.

ABS (warning lamp)

It comes on when the vehicle is switched on and then goes off shortly afterwards.

If it comes on when driving, it signals a fault in the anti-lock braking system.

The braking system then operates as on a vehicle not fitted with ABS. Contact a CITROËN authorised repairer or a qualified professional without delay.

ESP

This system helps retain control of the vehicle in "critical" driving situations (avoiding an obstacle, loss of grip in a corner, etc.).

Principle of operation

A steering wheel sensor provides information on the trajectory wanted by the driver. Other sensors around the vehicle measure the actual trajectory.

The system compares the driver's wishes with the actual trajectory of the vehicle, correcting the latter if necessary by acting on certain brakes and/or the motor power.

ESP (warning lamp)

It comes on when the vehicle is switched on and then goes off shortly afterwards.

The ESP warning lamp flashes in regulation mode, when it is called on to maintain grip.

If it comes on when driving, it signals a fault in the ESP system: contact a CITROËN authorised repairer or a qualified professional without delay.

Seat belts

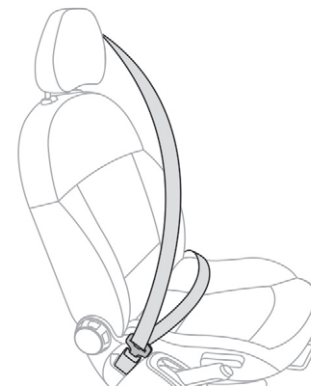

Your E-MEHARI is fitted with four 3-point seat belts:

- One for the driver's seat.
- One for the front passenger's seat.
- Two for the rear bench seat.

To correctly position a seat belt: place the lap strap as low as possible on your hips, correctly adjusted.

Ensure that the diagonal belt passes over your shoulder.

! All persons carried in your E-MEHARI must always wear a seat belt.

5

! Never leave children unsupervised in the vehicle playing with the seat belts. Most current seat belts have an automatic locking reel (ALR). If a seat belt wrapped around a child's neck were to retract or lock, the child could be seriously injured or killed. This can happen even with the vehicle stationary. If this scenario occurs, cut the safety belt as quickly as possible in order to free the child.

! Before fastening the seat belts, check that all of the backrests are vertical and engaged in a latched position. Otherwise, the occupants of the vehicle could be seriously injured during an accident or abrupt stop.

! Never carry an infant or child on your lap and never try to use your seat belt for both of you.

! Take care not to prevent the correct operation of the seat belts.

! Never try to repair or modify the seat belts yourself. Any repair or modification to the seat belts or their components must only be done by a CITROËN dealer.

Fastening

To fasten the seat belt: insert the tongue into the buckle on the corresponding seat and ensure it locks correctly.

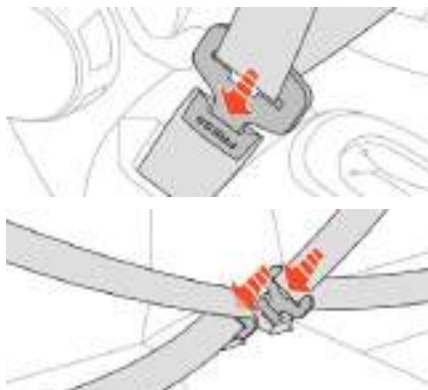

To unfasten the seat belt: press the orange button marked "PRESS". The seat belt will be released automatically.

Seat belt not fastened/unfastened alerts



The instrument panel includes seat belt unfastened warning lamp **A**, as well as unfastened seat belt identification warning lamp **B**.

When the system detects an unfastened seat belt, warning lamp **A** comes on, as well as the corresponding dot(s) in warning lamp **B**.

Front seat belts not fastened alerts



When the ignition is switched on, warning lamp **A** and the corresponding dots in warning lamp **B** come on if the driver and/or front passenger have not fastened their seat belts. At a speed above 12 mph (20 km/h), these warning lamps flash, associated with an audible signal, for two minutes. Beyond this period of time, the warning lamps stay on continuously until the seat belts are fastened.

Rear seat belts not fastened alerts



When the ignition is switched on, with the motor running or the vehicle driving above 6 mph (10 km/h), warning lamp **A** and the corresponding dots in warning lamp **B** come on for around thirty seconds, if one or more rear passengers have not fastened their seat belts.

Seat belts unfastened alert



After the ignition is switched on, warning lamp **A** and the corresponding dots in warning lamp **B** come on if the driver and/or one or more passengers unfasten their seat belts. These warning lamps flash for 30 seconds, accompanied by an audible signal. Beyond this period of time, the warning lamps stay on continuously until the seat belts are fastened.

Airbags

General information

This system contributes towards improving the safety of passengers (with the exception of the rear centre passenger) in the event of violent collisions. The airbags supplement the action of the seat belts fitted with force limiters (with the exception of the rear centre passenger). If a collision occurs, the electronic detectors record and analyse the front and side impacts sustained in the impact detection zones:

- in the event of a serious impact, the airbags are deployed instantly and contribute towards better protection of the passengers (with the exception of the rear centre passenger); immediately after the impact, the airbags deflate rapidly so that they do not hinder visibility or the exit of the passengers,
- in the case of a minor or rear impact or in certain roll-over conditions, the airbags may not be deployed; the seat belt alone contributes towards ensuring your protection in these situations.

! **The airbags do not operate when the ignition is switched off.**

This equipment will only deploy once. If a second impact occurs (during the same or a subsequent accident), the airbag will not be deployed again.

Impact detection zones

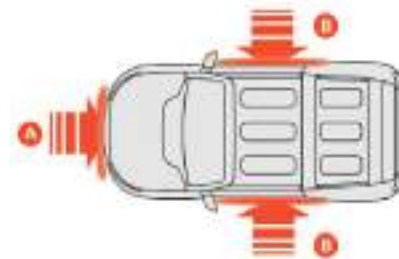

- A.** Front impact zone.
- B.** Side impact zone.

i Airbag deployment generates slight smoke emissions and a noise, due to the activation of the pyrotechnic cartridge incorporated in the system. This smoke is not harmful, but sensitive individuals may experience slight irritation. The detonation noise associated with the deployment of an airbag may result in a slight loss of hearing for a short time.

5

Front airbags

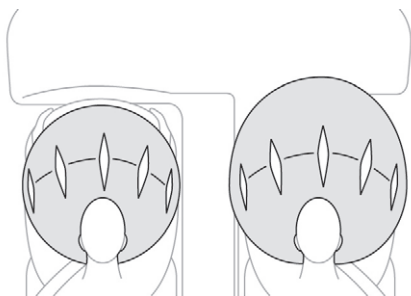

This system protects the driver and front passenger in the event of a severe frontal impact in order to limit the risk of injury to the head and chest.

The driver's airbag is fitted in the centre of the steering wheel; the front passenger's airbag is fitted in the dashboard under the glove box.

Deployment

The airbags are deployed, except the passenger's front airbag if it is deactivated, in the event of a serious front impact to all or part of the front impact zone **A**, in the longitudinal centreline of the vehicle on a horizontal plane and directed from the front to the rear of the vehicle.

The front airbag inflates between the thorax and head of the front occupant of the vehicle and the steering wheel, driver's side, and the dashboard, passenger's side, to cushion their forward movement.

Operating fault

 If this warning lamp on the instrument panel comes on, you must contact a CITROËN dealer or a qualified workshop to have the system checked. The airbags may no longer be deployed in the event of a serious impact.

Lateral airbags



This system protects the driver and front passenger in the event of a severe side impact to minimise the risk of injury to the chest, between hip and shoulder. Each lateral airbag is fitted in the seat backrest frame, door side.

Deployment

The lateral airbag is deployed unilaterally in the event of a severe side impact covering all or part of side impact zone **B**, perpendicular to the longitudinal centreline of the vehicle on a horizontal plane and directed from the outside towards the inside of the vehicle. The lateral airbag inflates between the hip and shoulder of the front passenger and the corresponding door trim panel.

Operating fault

 If this warning lamp on the instrument panel comes on, you must contact a CITROËN dealer or a qualified workshop to have the system checked.

The airbags may no longer be deployed in the event of a serious impact.

! In the event of a minor impact or bump on the side of the vehicle or if the vehicle rolls over, the airbags may not be deployed. In the event of a rear or front collision, none of the lateral airbags are deployed.

Advice

! For the airbags to be fully effective, observe the safety recommendations below.

Adopt a normal and upright sitting position.

Wear a correctly adjusted seat belt.

Do not leave anything between the occupants and the airbags (a child, pet, object, etc.), nor fix or attach anything close to or in the way of the airbag release trajectory; this could cause injuries during their deployment.

Never modify the original definition of your vehicle, particularly in the area directly around the airbags.

After an accident or if the vehicle has been stolen, have the airbag systems checked.

All work on the airbag systems must be carried out by a CITROËN dealer or a qualified workshop.

Even if all of the precautions mentioned are observed, a risk of injury or of minor burns to the head, chest or arms cannot be ruled out when an airbag is deployed. The bag inflates almost instantly (within a few milliseconds) then deflates within the same time discharging hot gas via openings provided for this purpose.

Front airbags

Do not drive holding the steering wheel by its spokes or resting your hands on the centre part of the wheel.

Passengers must not place their feet on the dashboard.

Do not smoke as deployment of the airbags can cause burns or the risk of injury from a cigarette or pipe.

Never remove or pierce the steering wheel or hit it violently.

Do not fit or attach anything to the steering wheel, the dashboard or the passenger's sun visor as this could cause injuries with deployment of the airbags.

Lateral airbags

Use only approved covers on the seats, compatible with the deployment of the lateral airbags. For information on the range of seat covers suitable for your vehicle, you can contact a CITROËN dealer.

Do not attach or hang anything to the seat backrests (clothes, etc.) as this could cause injuries to the thorax or arm when the lateral airbag is deployed.

Do not sit with the upper part of the body any nearer to the door than necessary.

The vehicle's front door panels include side impact sensors.

A damaged door or any unauthorised or incorrectly executed work (modification or repair) on the front doors or their interior trim could compromise the operation of these sensors – risk of malfunction of the lateral airbags!

Such work must only be done by a CITROËN dealer or a qualified workshop.

General points relating to child seats

Although one of the main criteria of CITROËN when designing your vehicle, the safety of your children also depends on you.

For maximum safety, please observe the following recommendations:

- In accordance with European regulations, **all children under the age of 12 or less than one and a half metres tall must travel in an approved child seat suited to their weight** and installed on a vehicle seat fitted with a seat belt or ISOFIX mountings.*
- **Statistically, the safest seats in your vehicle for carrying children are the rear seats.**
- **A child weighing less than 9 kg must travel in the rearward facing position both in the front and in the rear.**

i CITROËN recommends that children should travel on the **rear seats** of your vehicle:

- "rearward facing" up to the age of 3,
- "forward facing" over the age of 3.

* The legislation on carrying children is specific to each country. Consult the legislation in force in your country.

Child seat at the rear

"Rearward facing"

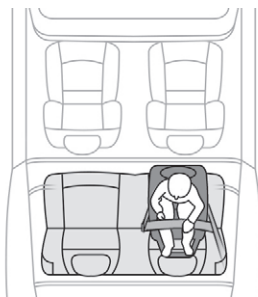

When a "rearward facing" child seat is installed **on a rear passenger seat**, move the vehicle's front seat forward and straighten the backrest so that the rearward facing child seat does not touch the vehicle's front seat.

"Forward facing"

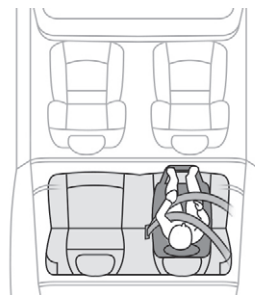

When a "forward facing" child seat is installed **on a rear passenger seat**, move the vehicle's front seat forwards and straighten the backrest so that the legs of the child in the forward facing child seat do not touch the vehicle's front seat.

! Ensure that the seat belt is correctly tensioned.

For child seats with a support leg, ensure that the latter is in firm contact with the floor. If necessary, adjust the front seat of the vehicle.

Child seat at the front

(Refer to the current legislation in your country before installing your child on the front seat.)

"Rearward facing"



When a "rearward facing" child seat is installed on the **front passenger seat**, adjust the seat to the intermediate longitudinal position, with the backrest straightened.

! The passenger's front airbag must be deactivated. Otherwise, **the child would risk being seriously injured or killed if the airbag were deployed.**

"Forward facing"



When a "forward facing" child seat is installed on the **front passenger seat**, adjust the vehicle's seat to the intermediate longitudinal position with seat backrest straightened and leave the passenger's front airbag activated.

i Ensure that the seat belt is correctly tensioned.
For child seats with a support leg, ensure that the latter is in firm contact with the floor. If necessary, adjust the passenger seat.

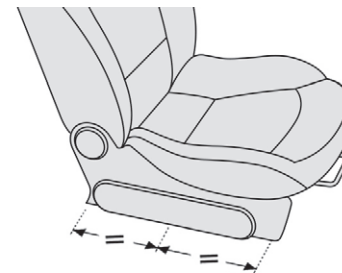

Passenger seat adjusted to the intermediate longitudinal position.

Deactivating the passenger's front airbag

! Never install a "rearward facing" child restraint system on a seat protected by an active front airbag. This could cause the death or serious injury of the child.



5



i For more information on the **Airbags**, refer to the corresponding section.

Deactivating the passenger's front airbag



Only the passenger's front airbag can be deactivated.

- ☞ **With the ignition off**, insert the key in the passenger airbag deactivation switch.

- ☞ Turn it to the **OFF** position.
- ☞ Remove the key, leaving the switch in this position.



When the ignition is on, this warning lamp comes on in the seat belt warning lamps display screen. It stays on while the airbag is deactivated.

! To assure the safety of your child, the passenger's front airbag must be deactivated when you install a rearward facing child seat on the front passenger seat.

Otherwise, the child would risk being seriously injured or killed if the airbag were deployed.

Reactivating the passenger's front airbag

When you remove a **rearward facing** child seat, **with the ignition off**, turn the switch to the **ON** position to reactivate the airbag and so assure the safety of your front passenger in the event of an impact.

AR	لا يجب أبدا تركيب نظام الأمان للطفل الرضيع باتجاه الأمام على مقعد سيارة مجهز بوسادة أمان هوائية أمامية مقلقة، فقد يؤدي هذا إلى التسبب بموت الطفل أو بإصابات خطيرة لديه.
BG	НИКОГА НЕ инсталирайте детско столче на седалка с АКТИВИРАНА предна ВЪЗДУШНА ВЪЗГЛАВНИЦА. Това може да причини СМЪРТ или СЕРИОЗНО НАРАНЯВАНЕ на детето.
CS	NIKDY neumist'ujte dětské zádržné zařízení orientované směrem dozadu na sedadlo chráněné AKTIVOVANÝM čelním AIRBAGEM. Hrozí nebezpečí SMRTI DÍTĚTE nebo VÁŽNĚHO ZRANĚNÍ.
DA	Brug ALDRIG en bagudvendt barnestol på et sæde, der er beskyttet af en AKTIV AIRBAG. BARNET risikerer at blive ALVORLIGT KVÆSTET eller DRÆBT.
DE	Montieren Sie auf einem Sitz mit AKTIVIERTEM Front-Airbag NIEMALS einen Kindersitz oder eine Babyschale entgegen der Fahrtrichtung, das Kind könnte schwere oder sogar tödliche Verletzungen erleiden.
EL	Μη χρησιμοποιείτε ΠΟΤΕ παιδικό κάθισμα με την πλάτη του προς το εμπρός μέρος του αυτοκινήτου, σε μια θέση που προστατεύεται από ΜΕΤΩΠΙΚΟ αερόσακο που είναι ΕΝΕΡΓΟΣ. Αυτό μπορεί να έχει σαν συνέπεια το ΘΑΝΑΤΟ ή το ΣΟΒΑΡΟ ΤΡΑΥΜΑΤΙΣΜΟ του ΠΑΙΔΙΟΥ
EN	NEVER use a rearward facing child restraint on a seat protected by an ACTIVE AIRBAG in front of it, DEATH or SERIOUS INJURY to the CHILD can occur
ES	NO INSTALAR NUNCA un sistema de retención para niños de espaldas al sentido de la marcha en un asiento protegido mediante un AIRBAG frontal ACTIVADO, ya que podría causar lesiones GRAVES o incluso la MUERTE del niño.
ET	Ärge MITTE KUNAGI paigaldage "seljaga sõidusuunas" lapseist juhi kõrvalistmele, mille ESITURVAPADI on AKTIVEERITUD. Turvapadja avanemine võib last TÕSISELT või ELUOHTLIKULT vigastada.
FI	ÄLÄ KOSKAAN aseta lapsen turvaistuinta selkä ajosuuntaan istuimelle, jonka edessä suojana on käyttöön aktivoitu TURVATYYNY. Sen laukeaminen voi aiheuttaa LAPSEN KUOLEMAN tai VAKAVAN LOUKKAANTUMISEN.
FR	NE JAMAIS installer de système de retenue pour enfants faisant face vers l'arrière sur un siège protégé par un COUSSIN GONFLABLE frontal ACTIVÉ. Cela peut provoquer la MORT de l'ENFANT ou le BLESSER GRAVEMENT.
HR	NIKADA ne postavljati dječju sjedalicu leđima u smjeru vožnje na sjedalo zaštićeno UKLJUČENIM prednjim ZRAČNIM JASTUKOM. To bi moglo uzrokovati SMRT ili TEŠKU OZLJEDU djeteta.
HU	SOHA ne használjon menetiránynak háttal beszerelt gyermekülést AKTIVÁLT (BEKAPCSOLT) FRONTLÉGZSÁKKAL védett ülésen. Ez a gyermek HALÁLÁT vagy SÚLYOS SÉRÜLÉSÉT okozhatja.
IT	NON installare MAI seggiolini per bambini posizionati in senso contrario a quello di marcia su un sedile protetto da un AIRBAG frontale ATTIVATO. Ciò potrebbe provocare la MORTE o FERITE GRAVI al bambino.

LT	NIEKADA neįrengkite vaiko prilaikymo priemonės su atgal atgręžtu vaiku ant sėdynės, kuri saugoma VEIKIANČIOS priekinės ORO PAGALVĖS. Išsiskleidus oro pagalvei vaikas gali būti MIRTINAI arba SUNKIAI TRAUMUOTAS.
LV	NEKAD NEuzstādiēt uz aizmuguri vērstu bērnu sēdekļi priekšējā pasažiera sēdvietā, kurā ir AKTIVIZĒTS priekšējais DROŠĪBAS GAISA SPILVENS. Tas var izraisīt BĒRNA NĀVI vai radīt NOPIETNUS IEVAINOJUMUS.
MT	Qatt m'ghandek thalli tifel/tifla marbut f'siggu dahru lejn l-Airbag attiva, ghaliex tista' tikkawza korriment serju jew anke mewt lit-tifel/tifla
NL	Plaats NOOIT een kinderzitje met de rug in de rijrichting op een zitplaats waarvan de AIRBAG is INGESCHAKELD. Bij het afgaan van de airbag kan het KIND LEVENSGEVAARLIJK GEWOND RAKEN
NO	Installer ALDRI et barnesete med ryggen mot kjøreretningen i et sete som er beskyttet med en frontal AKTIVERT KOLLISJONSPUTE, BARNET risikerer å bli DREPT eller HARDT SKADET.
PL	NIGDY nie instalować fotelika dziecięcego w pozycji "tyłem do kierunku jazdy" na siedzeniu wyposażonym w CZOŁOWĄ PODUSZKĘ POWIETRZNAJĄ w stanie AKTYWNYM. Może to doprowadzić do ŚMIERCI DZIECKA lub spowodować u niego POWAŻNE OBRAŻENIA CIAŁA.
PT	NUNCA instale um sistema de retenção para crianças de costas para a estrada num banco protegido por um AIRBAG frontal ACTIVADO. Esta instalação poderá provocar FERIMENTOS GRAVES ou a MORTE da CRIANÇA.
RO	Nu instalati NICIODATA un sistem de retinere pentru copii, dispus cu spatele in directia de mers, pe un loc din vehicul protejat cu AIRBAG frontal ACTIVAT. Aceasta ar putea provoca MOARTEA COPILULUI sau RANIREA lui GRAVA.
RU	ВО ВСЕХ СЛУЧАЯХ ЗАПРЕЩАЕТСЯ использовать обращенное назад детское удерживающее устройство на сиденье, защищенном ФУНКЦИОНИРУЮЩЕЙ ПОДУШКОЙ БЕЗОПАСНОСТИ, установленной перед этим сиденьем. Это может привести к ГИБЕЛИ РЕБЕНКА или НАНЕСЕНИЮ ЕМУ СЕРЬЕЗНЫХ ТЕЛЕСНЫХ ТРАВМ
SK	NIKDY neinštalujte detské zádržné zariadenie orientované smerom dozadu na sedadlo chránené AKTIVOVANÝM čelným AIRBAGOM. Mohlo by dôjsť k SMRTEĽNÉMU alebo VÁŽNEMU PORANENIU DIEŤAŤA.
SL	NIKOLI ne nameščajte otroškega sedeža s hrbtom v smeri vožnje, če je VARNOSTNA BLAZINA pred sprednjim sopotnikovim sedežem AKTIVIRANA. Takšna namestitve lahko povzročijo SMRT OTROKA ali HUDE POŠKODBE.
SR	NIKADA ne koristite dečje sedišta koje se okreće unazad na sedištu zaštićenim AKTIVNIM VAZDUŠNIM JASTUKOM ispred njega, jer mogu nastupiti SMRT ili OZBILJNA POVREDA DETETA.
SV	Passagerarkrockkudden fram MÅSTE vara avaktiverad om en bakåtvänd bilbarnstol installeras på denna plats. Annars riskerar barnet att DÖDAS eller SKADAS ALLVARLIGT.
TR	KESİNLKLE HAVA YASTIĞI AKTİF olan ön koltuğa yûzü arkaya dönük bir çocuk koltuğu yerleştirmeyiniz. Bu ÇOCUĞUN ÖLMESİNE veya ÇOK AĞIR YARALANMASINA sebep olabilir.

ISOFIX mountings (child seats)

(The legislation on carrying children is specific to each country. Refer to the legislation in force in your country.)

ISOFIX is an ISO standard for child seat mountings (ISO standard 13216-1: 1999).

This system avoids the use of the vehicle's seat belts for securing the child seat: two latches on the child seat engage on two anchorage points **(1)** positioned between the seat cushion and backrest at the left-hand and right-hand seating positions of the rear bench seat of your E-MEHARI.

The aim of the ISOFIX system is to facilitate the installation of a child seat and its transfer to another vehicle, while avoiding the problems inherent in fixing systems that use the vehicle's seat belts.

Your E-MEHARI is fitted with ISOFIX mountings at the left-hand and right-hand seating positions of the rear bench seat.

This system simplifies the installation and fixing of a child seat while improving the safety of the installation at the same time.



(1) Locations of ISOFIX mountings.

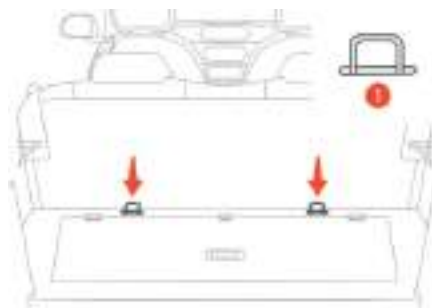

(1) Location of the Top Tether rings for fixing the upper strap.

! The ISOFIX standard is overseen by the International Standards Organisation. Always use child seats compatible with this standard when using the dedicated anchorage points.

! Using a child seat incompatible with the ISOFIX standard may increase the risks of an accident and injury for the child, but also for other occupants of the vehicle.

Installation of a child seat compatible with the ISOFIX standard

! Failure to observe the instructions and warnings related to the installation of a child seat or child restraint system would expose the child and the other occupants of the vehicle to the risk of serious injury in the event of a collision or sudden braking.

! Always use child seats that meet the European standards and carefully follow the installation and fixing instructions provided with the child seat.

5

! Before installing a child seat, check that there is nothing that might interfere with its fixing to the two anchorage points. You will not be able to correctly secure a child seat to the two anchorage points if they are not clear of obstruction.

! A child restraint system in a vehicle parked in the sun can become very hot. Always check the surface of the child seat before placing the child in it, to avoid any risk of injury.

! The incorrect installation of a child seat compromises the protection and safety of the child and the occupants of the vehicle in the event of a collision.

Visual indicators

Direction indicators

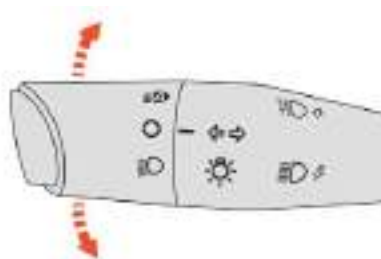

To operate the right-hand direction indicators: push up the control stalk located on the left behind the steering wheel.

To operate the left-hand direction indicators: pull down the control stalk. The control stalk automatically returns to its middle position once the change of direction has been completed.

! Before changing direction, always signal your intention well in advance, using the direction indicators. Before changing direction, check the vehicle's immediate surroundings using the mirrors, also taking account of the blind spots.

! Poorly prepared changes of direction can lead to collisions and accidents.

Hazard warning lamps

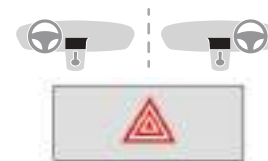

Press the hazard warning lamp button to warn other drivers that you are in abnormal driving or traffic conditions, or have to stop in an unusual place.

When you press the hazard warning lamp button, all of your E-MEHARI's direction indicator lamps and the button indicator lamp flash at the same time.

To switch off the hazard warning lamps: press the button again.

! In the event of stopping in an emergency, always move your vehicle off the carriageway, where possible, to avoid the risk of accident.

! Use the hazard warning lamps only to signal unusual action on your part and only if your vehicle presents a safety risk to other drivers: an emergency stop because of a vehicle failure, the need to drive abnormally slowly, etc...

! While the hazard warning lamps are on, your E-MEHARI's direction indicators can no longer be used to indicate changes of direction.

Horns and audible warnings

"Standard" horn

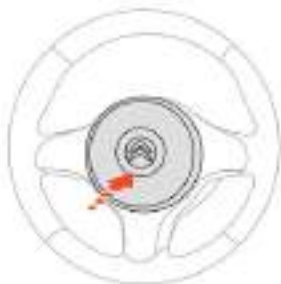

To use the "standard" horn: press the central hub of the steering wheel.

Horn for pedestrians

Operation

Your E-MEHARI produces no noise from its electric motor. It has a special horn for warning pedestrians of your approach. This horn sounds when the vehicle's speed is between approximately 0.6 and 18 mph (1 and 30 km/h).

Deactivation

In certain driving conditions you can deactivate the system.



Make a short press on the end of the wiper control stalk.

Another press reactivates the system.

i Before deactivating the system, make sure that you are not driving in an area frequented by pedestrians.

i The system is reactivated automatically at every new start.

Audible warning emergency services

Your E-MEHARI has an audible warning system should there be a problem with the LMP® battery fitted to the vehicle. A message also appears on the dashboard instrument panel.

For more information on the **Instruments and indicators on your E-MEHARI**, refer to the corresponding section.

If operation of this system is triggered (the audible warning cannot be switched off), you must stop the vehicle as soon as it is safe to do so, get out of the vehicle, and call CITROËN ASSISTANCE.

! Please tell the call handler that your vehicle is an electric vehicle.

! Stay at least ten metres away from your vehicle when an LMP® battery warning has been triggered. An LMP® battery is an energy storage device.

5

Driving recommendations

Observe the driving regulations and remain vigilant whatever the traffic conditions.

Pay close attention to the traffic and keep your hands on the wheel so that you are ready to react at any time to any eventuality.

As a safety measure, the driver must only carry out any operations that require close attention when the vehicle is stationary.

On a long journey, a break every two hours is strongly recommended.

In bad weather, drive smoothly, anticipate the need to brake and increase the distance from other vehicles.

Important!

! Never drive with the parking brake applied – Risk of overheating and damage to the braking system!

! Never leave a vehicle unsupervised with the motor running. If you have to leave your vehicle with the motor running, apply the parking brake and put the drive selector into position **N** or **P**.

Driving on flooded roads

We strongly advise against driving on flooded roads, as this could cause serious damage to the motor or gearbox, as well as to the electrical systems of your vehicle.

If you are obliged to drive through water:



- check that the depth of water does not exceed 6 inches (15 cm), taking account of waves that might be generated by other users,
- drive as slowly as possible. In all cases, do not exceed 6 mph (10 km/h),

On leaving the flooded road, as soon as circumstances allow, make several light brake applications to dry the brake discs and pads.

If in doubt about the state of your vehicle, contact a CITROËN dealer or a qualified workshop.

Driving your E-MEHARI

! Never leave a child or a disabled adult who usually needs help from others alone in the vehicle.
Pets should not be left alone in the vehicle.

! Secure any loads in your vehicle so that they cannot slide about.
Do not load the vehicle higher than the seat backrests.
A badly supported load may result in serious physical injuries if there is an abrupt stop or collision.

! If the vehicle is not handled carefully and in a safe way, you risk losing control of it and causing an accident.

! The following actions may increase the risk of losing control of the vehicle if the tyres are not properly inflated:

- sudden harsh application of the brakes,
- releasing the accelerator pedal suddenly,
- turning the steering wheel too quickly.

Note: The vehicle generally moves towards or pulls in the direction of the under-inflated tyre.

! Never drive under the influence of alcohol or drugs.

The presence of alcohol or drugs in your bloodstream reduces coordination, slows reaction and impairs judgement.

! Driving after taking alcohol or drugs increases the risk of being involved in an accident causing injuries, suffered by yourself or inflicted on others.

Note also that, in the event of an accident, there is a risk that the alcohol or drugs will increase the severity of the injuries suffered.

! Never take medicines that might affect your ability to drive and control the vehicle before setting off.

! Never leave the starting switch in the "MAR" position for a long period when the vehicle is not being used.
This can reduce the range of the vehicle.

! When you stop your vehicle on a rising slope, do not hold the vehicle by pressing the accelerator.
Always use the brake pedal for this.

! Before moving off, check that the position of the drive selector agrees with your intention.

! The drive direction is indicated on the drive selector by illumination of the green ring.

Starting switch

Starting/Switching off the vehicle



The starting switch is located on the right-hand side under the steering wheel.



- (1) STOP position: your E-MEHARI is stationary.
- (2) MAR position: the 12 V battery is connected and the accessories can be used.
- (3) AVV position: switching on the electric motor.

Starting the vehicle

To start your E-MEHARI, you should:

1. Unlock your E-MEHARI using your personal RFID key ring.



2. Insert the key in the starting switch then turn it to the MAR position. The welcome screen appears.
3. When you are invited to do so, turn the key to the AVV position, holding it until you hear an audible signal (beep). Release the key, the switch automatically returns to the MAR position. The message "Ready to move off, Select D or R" appears in the instrument panel screen.



4. Press the brake pedal.
5. Put the drive selector to position "D" (Drive) or "R" (Reverse).
6. Release the manual parking brake.

! Your E-MEHARI is a silent electric vehicle. Your E-MEHARI does not generate any noise when its electrical motor is started. When performing any manoeuvre: please pay increased attention to your environment, especially to pedestrians, cyclists and other vehicles moving on the road.

Switching off the vehicle

To park your E-MEHARI, you should:

1. Place the vehicle in a secure area suitable for parking.
2. Immobilise the vehicle.
3. Put the drive selector to position "N".
4. Apply the manual parking brake.
5. Switch off and remove the key from the starting switch.

Control pedals

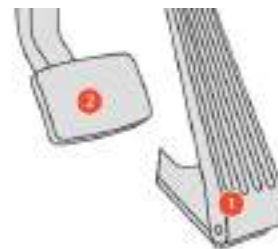

Your E-MEHARI has two control pedals:
(1) Accelerator pedal.
(2) Brake pedal.

! Ensure that the pedals are always freely accessible.

! Loose objects on the driver's side floor may inhibit or prevent operation of the pedals and cause loss of control of the vehicle, increasing the risk of serious or fatal injuries.

Manual parking brake

! Always check that your manual parking brake is applied before leaving the vehicle.

! When parking on a slope, turn the front wheels into the kerb, apply the parking brake and switch off at the starting switch.

! Check that the parking brake is released before moving off. Not releasing the parking brake could result in its failure and cause an accident.

! Never release the parking brake from outside the vehicle.

! Never leave children unsupervised inside the vehicle. They might release the parking brake and cause an accident.

! Only release the brake pedal once the parking brake has been fully applied. Failure to apply the parking brake could allow the vehicle to move on its own and cause an accident.

i In very cold conditions, the manual parking brake could freeze and be impossible to release.

Applying the parking brake

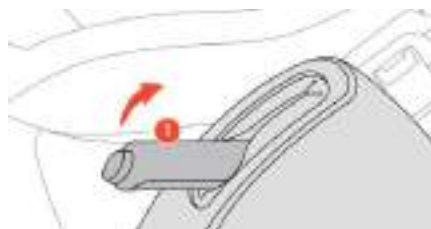

To apply the manual parking brake and immobilise your vehicle, pull the lever **(1)** fully up.



An indicator lamp appears in the instrument panel once the parking brake is applied.

Releasing the parking brake



To release the manual parking brake:

1. Pull slightly on the lever **(1)**.
2. Press the release button **(2)**.
3. Lower the lever fully.

Once the parking brake is completely released, the indicator lamp goes off in the instrument panel.

Drive selector



(1) Drive selector.

Selector modes

- (N) "NEUTRAL" position: no drive engaged.
- (D) "DRIVE" position: forward.
- (R) "REVERSE" position: reverse.

It is essential to keep the brake pedal applied when changing selector position.

! Do not press the accelerator pedal when moving the selector lever from position "N" to position "D" or "R".

! All changes of drive selector position must be made with the vehicle stationary. Failure to follow this advice leads to the risk of an accident.

! Do not change drive direction with the selector when the accelerator pedal is pressed down. This can cause the vehicle to move off suddenly and cause an accident.

Electric power steering system

!  If this warning lamp is visible on your E-MEHARI's instrument panel: your E-MEHARI's power steering has a technical problem.

If this happens, you must contact CITROËN ASSISTANCE as soon as possible. It is recommended that the vehicle not be used while this warning lamp is on: you could lose control of your vehicle, cause an accident and be injured.

The electric power steering system is designed to provide power assistance to the steering when parking or driving at low speed so that you can manoeuvre the vehicle with less effort. When driving in town, the level of electric assistance can be increased by using the City function.

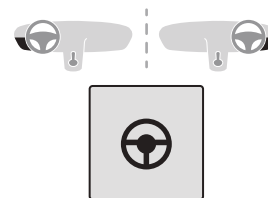

To activate the City function, press the control button.

CITY With the City function activated, the CITY indicator lamp comes on in the instrument panel of your E-MEHARI.

To deactivate the City function: press the control button again. The green "City" indicator lamp goes off.

The City function is switched off automatically when the ignition is switched off.

Tyre under-inflation detection

System which automatically checks the pressures of the tyres while driving.

The system monitors the pressure in all four tyres, once the vehicle is moving.

The system triggers an alert as soon as it detects a drop in the pressure of one or more tyres.

! The tyre under-inflation detection system does not replace the need for vigilance on the part of the driver.

This system still requires you to check the tyre inflation pressure (including the spare wheel, where fitted) every month as well as before a long journey.

Driving with under-inflated tyres impairs handling, extends braking distances and causes premature tyre wear, particularly in adverse conditions (heavy loads, high speeds, long journeys).



Driving with under-inflated tyres increases energy consumption.

i The tyre pressure specifications for your vehicle can be found on the tyre pressure label.

For more information on the **Identification markings**, refer to the corresponding section.

! Tyre pressures should be checked when the tyres are "cold" (vehicle stopped for 1 hour or after a journey of less than 6 miles (10 km) at moderate speeds). Otherwise (when hot), add 0.3 bar to the pressures shown on the label.

Under-inflation alert



It is indicated by this warning lamp coming on, fixed.

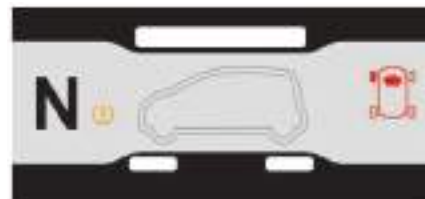

- ☞ Reduce speed immediately, avoid excessive steering movements and sudden braking.
- ☞ Stop as soon as possible, when traffic conditions allow.

! The loss of pressure detected does not always cause visible bulging of the tyre. Do not rely on a simple visual check.

- ☞ If you have a compressor (such as the one in the temporary puncture repair kit), check the pressures of the four tyres when cold. If it is not possible to make this check immediately, drive carefully at reduced speed.

or

- ☞ In the event of a puncture, use the temporary puncture repair kit.

i The alert is kept active until the system is reinitialised.

Reinitialisation

The system must be reinitialised after any adjustment to the pressures of one or more tyres, and after changing one or more wheels.

! Before reinitialising the system, ensure that the pressures of the four tyres are correct for the use of the vehicle and in line with the recommendations on the tyre pressure label.

The under-inflation detection system does not give a warning if a pressure is incorrect at the time of reinitialisation.

The system must be reinitialised with the **ignition on** and the vehicle stationary, via the vehicle's configuration menu, in Advanced settings.

! The under-inflation alert can only be relied on if the reinitialisation of the system has been done with the pressures in the four tyres correctly adjusted.

Maintaining and servicing your E-MEHARI

The maintenance and servicing of your vehicle must be carried out by a CITROËN authorised repairer or a qualified professional and in line with the principles stated in the Maintenance and Warranty Guide.

Washing precautions

! Never wash the charging socket, the traction battery or under the bonnet using a high pressure jet wash: risk of damage to the electrical system.
Never wash the vehicle while it is charging: risk of electric shock that could cause death.

! Cleaning the vehicle by the regular use of a high pressure car wash with rotating brushes is not recommended.

Not recommended for care of the bodywork

- Degreasing or cleaning the mechanical components under the body, parts with hinges, exterior plastic panels using a high pressure jet wash or spraying products not intended for this purpose, such as solvents.
- Washing the vehicle in direct sunlight.
- Removing mud or stains without first soaking with water.

Recommended for care of the bodywork

- Washing your E-MEHARI regularly using car shampoo specifically created for the care of vehicles with plastic body parts (never with abrasive products).
- Rinsing and thoroughly hosing off as soon as possible resinous deposits from trees, fallout from industrial pollution and bird droppings which produce a chemical reaction with the bodywork causing rapid discolouration.

Care of interior trim

Stains should always be dealt with quickly. For all types of stain, you should use warm or cold soapy water based on natural soap. Detergents (washing up liquid, powder products, alcohol-based products, etc.) must not be used.

- Use a soft cloth.
- Rinse and absorb the excess.
- Finish by wiping gently with a dry, soft cloth.

As it is not watertight, the dashboard must never be washed using water.



Only the seats, covered with an impermeable material, and the floor can be washed using a water jet (check first that the drainage holes, located at the front on each side of the central console in the passenger footwells are not blocked).

7

Charging socket panel (access to the charging socket)



The charging socket panel **(1)** on your E-MEHARI cannot be locked.

Opening the charging socket panel gives access to the socket for charging your E-MEHARI.

Your E-MEHARI uses a Type 2 connector which allows charging from your domestic power supply, from a wall box installed at your home, or at a public charging point compatible with this type of socket.

Charging your E-MEHARI

General information

! Your E-MEHARI is an electric vehicle that uses electric current at high voltage. Failing to observe the correct handling instructions can cause serious or fatal injuries. Ensure that you read and follow the charging procedures recommended by CITROËN.

To charge your E-MEHARI, you must use one of the following:

- A charging cable including a CCID unit with a domestic 230 V socket and a Type 2 connector.
- A wall box or a compatible public charging point together with a charging cable with a Type 2 connector.

Never use an extension lead.



1. Type 2 charging nozzle.

Charging the LMP® battery fitted to your E-MEHARI

! In order to offer its optimum range, your E-MEHARI's LMP® battery must be charged whenever possible, particularly during periods when it is parked for several hours. A battery charged to 100% cannot remain parked for more than 48 hours without being recharged.

! To preserve the long service life of the LMP® battery, it must be charged to 100% at least once a month.

A hibernation mode is available to reduce energy consumption from the battery to a minimum.

In this way you can park your E-MEHARI, not connected and therefore with no consumption of electrical energy, for several weeks or even several months.

If the LMP® battery is completely discharged, the 12 V battery could be damaged and require replacement.

At a public or private charging point

You can charge your E-MEHARI at a public or private charging point, provided that you have a suitable cable for the type of charging point.

At home

Using a 16 A power point

If you have a 16 A charging power point or have had one installed by an electrician, you can use it to charge your E-MEHARI.

Using an ordinary domestic power point (230 V/16 A 10 A consumed)

Your E-MEHARI is supplied with a charging cable that has CCID electronic protection, allowing you to charge your E-MEHARI from any 230 V/16 A domestic power point that can support a continuous current of 10 A.

Using this solution, the charging time is longer than if charged from a 16 A power point.

! Never use an extension lead.

Use of CCID charging cable

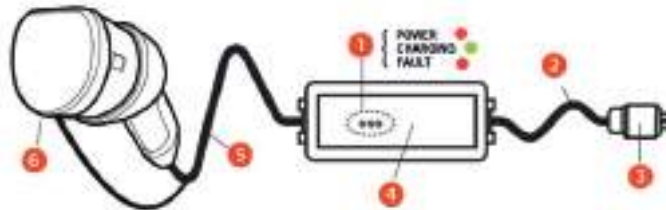

- (1) LEDs
- (2) Cable
- (3) Plug
- (4) Control unit
- (5) Cable
- (6) Protective cover

! Observe the safety rules and follow the steps indicated before use.

- Use only the original charging cable.
 - Do not attempt to dismantle or repair the charging cable.
 - Do not use an extension lead or adapter.
 - Incorrect use of the charging cable would risk causing an accident such as an electrical discharge or fire.
 - Immediately stop using the charging cable if a fault or problem occurs or if the FAULT warning lamp lights up or flashes.
 - Ensure that the plug is not allowed to become wet.
 - Do not touch the terminals on the charging cable or the vehicle's charging socket.
 - Do not use the charging cable if parts of it are broken, frayed, cracked, open or showing any other sign of damage.
 - Keep the charging cable out of reach of children.
 - When using the charging cable, the ambient temperature must not exceed 45 degrees Celsius.
 - Handle the charging cable with care, avoid dropping it and do not pull heavily on the cable or the cord.
- Ensure that the electrical power supply is 220-240 V 50 Hz alternating current.
 - Before connecting the charging cable, check the nominal current indicated on the charging cable, to ensure that the power point and supply circuit are rated sufficiently highly to charge your vehicle.
 - The charging cable allows 10 A of continuous consumption, you must ensure that the electrical installation (socket, cables, etc.) for the charging have this value of nominal current at a minimum and comply with the most recent electrical cable standards and regulations in force in your country or region.
 - The maximum nominal current depends on the country.
 - The socket and wiring circuit must be earthed and protected by a circuit breaker specifically designed for this purpose or a fuse to avoid any accident of electrical origin.
 - Contact a qualified electrician if in any doubt over the power point and wiring circuit.

! The components of your E-MEHARI comply with electromagnetic emission standards. However, as a precaution, if you have a pacemaker or any other electrical medical device, ask your doctor about any precautions to take.

- ! - Component parts may be damaged by incorrect use.
- Ensure that the control unit of the charging cable is placed so that any contact with water is avoided.
- Avoid introducing any foreign bodies or particles into the connector terminals or charging plug.
- Avoid treading on, folding or knotting the cable or cord.
- Avoid using the charging cable during a storm.
- Do not place heavy objects on the charging cable.
- When charging, keep the charging cable away from objects that become hot.
- When the charging cable is not in use, stow it with its protective cover in a cool, dry place that is not exposed to direct sunlight.
- Do not use an extension lead with your charging cable.

Starting the charge

- ! To start charging, the ignition must be switched off, the car must be unlocked with the RFID key ring, and the parking brake activated.



1. Connect the plug (1) to a 230 V/16 A socket that can support a continuous current of 10 A. All the LEDs on the control unit light up for half a second then the POWER warning lamp lights up permanently.

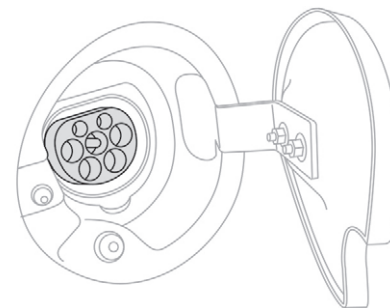

2. Open and hold open the vehicle's charging socket panel (on the right-hand rear wing). Ensure that there is no foreign body in the connector terminals or the charging plug.



3. Push the charging nozzle (2) into the charging socket until it clicks in place. The indicator lamp on the charging shut-off button (1) starts to flash.



4. Charging starts automatically. The CHARGING indicator lamp on the control unit comes on to indicate that charging is in progress.

Several signals indicate that the vehicle's battery is charging:

- The right-hand rear lamp flashes 5 times at the start of the charge.
- The charging indicator lamp (in the form of a green plug) in the display screen flashes continuously.

Flashing green continuously: charging is in progress.

Fixed green: charging is complete.

- The indicator lamp on the charging shut-off button gives the same indication as the charging indicator lamp on the display.

Flashing green continuously: charging is in progress.

Fixed green: charging is complete.

If the central screen is lit, the message "Charging" will be displayed as well as an estimate of the charge time remaining.

! Notes on charging

Once you have connected your E-MEHARI, you have 30 seconds to lock the vehicle.

After this, your E-MEHARI will remain unlocked.

However, as a security measure, the driving permissions will be cancelled.

- If you wish to use your E-MEHARI again, offer up your key ring in front of the RFID reader to regain the driving permissions.
- To lock your E-MEHARI, scan twice. The 1st time will be interpreted as a recovery of the driving permissions, the 2nd time will lock the vehicle.

Stopping the charge

The charging nozzle will only disconnect if your E-MEHARI is unlocked using the personal RFID key ring.

1. Press the charging shut-off button in the charging socket panel, wait until the charging nozzle is unlocked then pull it out. **If you do not remove the charging nozzle within the next 10 seconds, the vehicle starts charging again. You will then have to start the operation again.**
2. Refit the protective cover on the charging nozzle.
3. Disconnect the plug from the power point.

Indications given by the LEDs on the control unit

POWER LED	CHARGING LED	FAULT LED	Description
On for ½ sec.	On for ½ sec.	On for ½ sec.	All of the LEDs come on for ½ second to verify that they work, when the charging cable is plugged into the power point.
On	Off	Off	The charging cable is plugged into the power point. If the Type 2 connector is in the vehicle's charging socket, the charge has finished.
On	On	Off	The vehicle's battery is charging.
On	Off	On/flashing	Fault with the charging cable. Stop using the charging cable immediately and contact CITROËN ASSISTANCE.
Off	Off	Off	No electrical power supply is detected at the power point by the charging cable. Check the circuit breaker for the power point. If the power point electrical supply is correct and all the LEDs do not light up for half a second to verify that they are working properly, the charging cable may be damaged. Stop using it immediately and contact CITROËN ASSISTANCE.

Comparison of charging times

Charging type	Estimated charging time (0-100%)
Charging point: 16 A	8 to 9 hours
230 V/16 A power point 10 A consumed	13 hours

! When charging the vehicle, particularly at the roadside, be especially careful of children when handling the cable and the charging point. The cable reel can operate sharply and cause injury. Children could trap their fingers in the charging point closing mechanism.

7

Under the bonnet

! The underbonnet of the vehicle is a dangerous area that could cause serious injuries.

Under the bonnet of your E-MEHARI there are the vehicle's drive train and the reservoirs containing the fluids needed for the correct operation of your E-MEHARI (brake fluid, coolant and screenwash fluid).

! The drive train is directly powered by the LMP® battery fitted to your E-MEHARI. Never try to do anything to the high voltage components of your vehicle. Incorrect handling of these components could cause an electric shock and serious or fatal injuries.

! Always keep children well away from the underbonnet and never leave them unsupervised.

Opening the bonnet

Your E-MEHARI's bonnet is opened in two steps:



1. Releasing the bonnet: Pull the bonnet release lever (1) located below and to the left of the steering wheel, at the vehicle's left-hand front wheel arch.

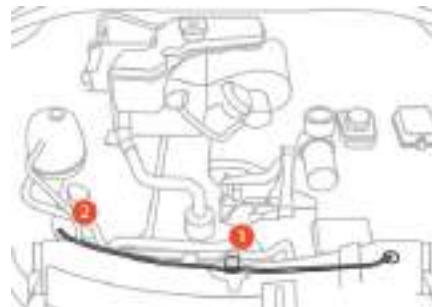

2. Tip the bonnet safety catch (1). Raise and secure the bonnet using the stay (2).



The bonnet stay goes into the red cut-out (3) provided for this purpose.

! When opening the bonnet, ensure that it is always supported by the stay, so as to avoid any injury resulting from the bonnet dropping.

Closing the bonnet

Disengage the stay while holding the bonnet with one hand to avoid its sudden dropping.

Return the stay to its original position and allow the bonnet to drop and latch home.
Check that the bonnet has latched correctly.

! If you notice when driving that the bonnet is not closed correctly, slow down and stop where it is safe to do so, and then close the bonnet correctly.

Underbonnet layout

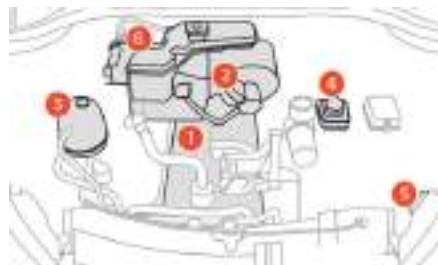

- (1) Drive train
- (2) Your E-MEHARI's heating system
- (3) Motor coolant

- (4) Brake fluid
- (5) Screenwash fluid reservoir
- (6) Heating system fluid

! There are high voltage components under the bonnet of your E-MEHARI. We recommend that you do not attempt to perform maintenance on your vehicle yourself. Incorrect handling of these components could cause an electric shock and serious or fatal injuries.

Brake fluid and motor coolant levels

Make a regular visual check of the brake fluid and coolant levels. These levels should be topped up by a CITROËN authorised repairer or a qualified professional.

! If work is needed on your vehicle, contact a CITROËN authorised repairer or a qualified professional without delay.

Screenwash fluid level

Always perform the following operations in the order indicated before carrying out any operations under the bonnet of your E-MEHARI to top up the screenwash fluid level:

1. Park the vehicle in a safe place
2. Press and hold the brake pedal in this position until you have switched off the ignition
3. Apply the parking brake fully
4. Move the drive selector to position "N"
5. Switch off the ignition and remove the key from the switch
6. Keep children and other persons away from the underbonnet
7. Ensure that the vehicle is correctly immobilised

! Failure to follow the list of operations above risks causing serious injury.

! Always carry out the operations in the order given and always observe the safety recommendations.



To top up the screenwash fluid: remove the cap from the reservoir, place a funnel in the neck of the reservoir and fill the reservoir up to the "MAX" mark.

! In low temperatures, use a screenwash fluid with adequate protection against freezing.

! Always be extremely vigilant when filling the screenwash reservoir and take account of the general safety recommendations mentioned in this handbook.

Hibernation mode

Hibernation mode allows the consumption of energy from the battery to be reduced to a minimum.

In this way you can park your E-MEHARI, not connected and therefore with no consumption of electrical energy, for several weeks or even several months.

Coming out of hibernation mode takes 4 hours and is followed by the charging time (a maximum of between 8 and 13 hours).

! You cannot put your E-MEHARI into hibernation with a battery state of charge of less than 25%.

Going into hibernation mode

Maximum hibernation period depending on the state of charge of the battery

In hibernation, the battery will self-discharge by between 0.5% and 1% per day.

Therefore, the maximum duration of hibernation depending on the battery charge level is:

- 100%: 4 months
- 75% – 99%: 3 months
- 50% – 74%: 2 months
- 25% – 49%: 1 month

1. Move your vehicle close to a charging point.

2. If necessary, unlock your vehicle and disconnect the charging plug.
3. Turn the ignition key to the first position, the screen then displays:



4. Press the settings button (1) on the right of the screen. The screen displays various possible choices.
5. Select "Extended dormancy" using the arrows.



6. Press and hold the settings button for 5 seconds.
7. Switch off the ignition. Entry into hibernation mode is confirmed.

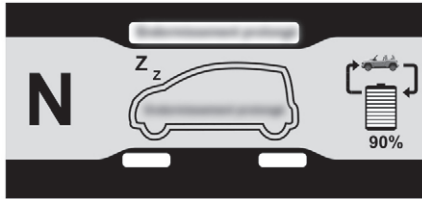

The screen goes off after 30 seconds.
 The switch to hibernation mode takes effect after approximately 4 hours.
 During this time, it is possible to cancel switching to hibernation mode, as well as to unlock or lock the vehicle.
 Once this time has passed, your vehicle can no longer be locked or unlocked.
 If you intend to lock your vehicle, make sure to take out your charging cable beforehand.

! If the vehicle is to be put into hibernation mode for a long period, to prolong the service life of the 12 V ancillaries battery, you can remove it or disconnect its (-) terminal.

labelling the switch to hibernation mode

The switch to hibernation mode takes effect after approximately 4 hours.
 During this time, it is possible to cancel switching to hibernation mode.

1. Press the settings button on the right of the screen. The screen asks if you wish to cancel the hibernation.
2. Press and hold the settings button for 5 seconds to cancel the switch to hibernation mode.

It will not necessarily be possible to use your E-MEHARI right away (a long warm-up phase may take place depending on the time between starting hibernation and cancelling it).
 If the screen displays "Standby – Connect the plug" (with the vehicle logo circled in red), you will not be able to start. Switch off the ignition and connect your E-MEHARI.

Coming out of hibernation mode

You have to be in possession of the charging cable and be able to connect your vehicle to a power supply to be able to wake the vehicle from hibernation.

To come out of hibernation mode, simply connect the charging cable.
 It takes approximately 4 hours for the battery to wake up.
 During this warm-up phase, the indicator lamp on the charging shut-off button and the charging indicator lamp on the display flash rapidly.

! It is imperative that you do not disconnect the vehicle during the warm-up phase.

After the warm-up phase, the charging of the battery begins.
 Wait until the charge level reaches 100% before disconnecting your E-MEHARI.

Audio system Radio

Your E-MEHARI is pre-wired to receive any audio system with ISO connectors.
 You can install the model of your choice.
 However, as your E-MEHARI can only accommodate one audio system, installing a new audio system means that the Bluetooth audio system which is already fitted must be disconnected.

Speakers

Your E-MEHARI is fitted with two speakers for playing music and communicating with CITROËN ASSISTANCE.

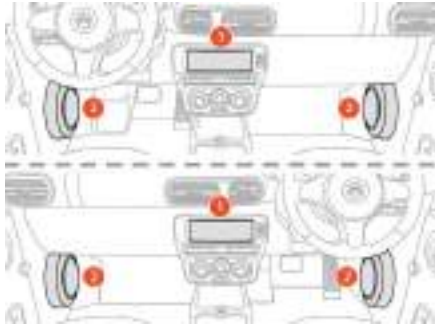

- (1) Audio system housing (available as an accessory)
- (2) Speaker position

Bluetooth® system

A Bluetooth® audio system is already installed in your vehicle. The vehicle is handed over to you with the remote control for the system, as well as a remote control holder that you can fix to the dashboard.

The system allows you to:

- Listen to music with an audio player or a smartphone connected via Bluetooth®, or with a USB peripheral device connected to the socket in the central console.
For more information on the **Interior fittings**, refer to the corresponding section.
- Make and receive telephone calls via Bluetooth® connection in hands-free mode, using the microphone and speakers installed in your E-MEHARI.

Please refer to the user guide for the Bluetooth® system for more details about its use.

Note: the connection modes for iPod®/iPhone® via cable (Apple® "dock" socket) or via auxiliary jack socket are not available.

Temporary puncture repair kit

Access to the repair kit

Your E-MEHARI's puncture repair kit is located under the boot floor hatch.

The boot floor hatch is opened with the grip located at the left-hand side of the boot floor (only if your E-MEHARI is unlocked using your personal RFID key ring).

Using the repair kit

Refer to the instructions provided with the compressor.

! Never remove from a tyre a foreign body that has caused a puncture.

! The sealant product contained in the compressor is toxic and is an irritant. Never ingest it, never spray it onto the body, face or eyes.

! If it is ingested, call the emergency services immediately (fire service, ambulance, etc.) or go to a hospital's emergency department. If it enters the eyes, wash with abundant clean water and consult a doctor without delay. If the symptoms persist, consult a specialist.

! Keep the sealant product out of the reach of children.

! Do not simply throw the old cartridge away after use; take it to your CITROËN authorised repairer or to a waste recovery organisation that specialises in this type of product.

! Once the tyre has been repaired, go to a CITROËN authorised repairer or a qualified professional as soon as possible.

! If you are unable to obtain the desired pressure after a few minutes of operation of the compressor, this means that the tyre cannot be repaired. Contact CITROËN ASSISTANCE who will send a roadside recovery agent.

Replacing a bulb

All maintenance on the vehicle's lamps must be carried out by a CITROËN authorised repairer or a qualified professional.

If a headlamp has to be replaced on your E-MEHARI: go to a CITROËN authorised repairer or a qualified professional.

In the event of a breakdown

Replacing a fuse

Fuses under the bonnet

All maintenance on the vehicle's fuses must be carried out by a CITROËN authorised repairer or a qualified professional.

! Your E-MEHARI is an electric vehicle that includes systems operating at high voltage and high currents. The maintenance on the fuses under the bonnet of your E-MEHARI must be carried out by a qualified person. Incorrect handling could cause an electric shock resulting in serious injury or death.

Fuses in the passenger compartment

If an electric system is not working, check the condition of the fuses.



Remove the nut from the access cover (1) located below the passenger storage compartment.



The tweezers for extracting fuses (1) are located under the bonnet.

To check and replace a fuse:

- Extract the fuse using the tweezers (1)
- Slide it sideways to release it from the tweezers
- It is recommended not to use the free fuse locations
- Do not forget to return the tweezers (1) to their holder

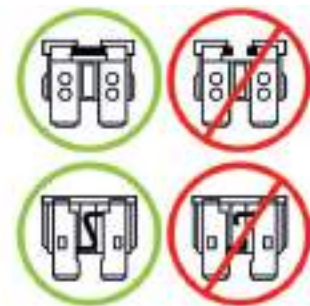

! Check the condition of the fuse and, if necessary, replace it with a new fuse, which must be of the same rating as the original fuse.

A fuse of too high a rating could cause overheating of the electrical system (risk of fire) if there were abnormal current consumption in a circuit.

Fuse allocations in the passenger compartment

The presence of certain fuses depends on the specification level of the vehicle.

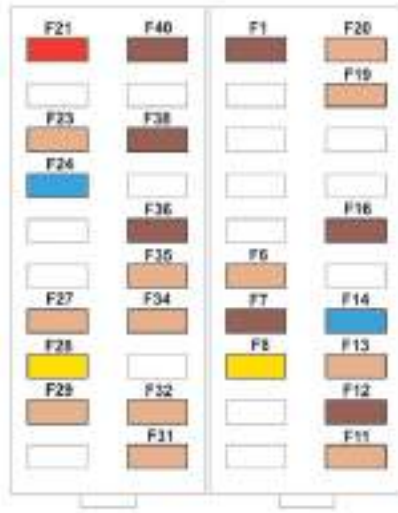

Fuse N°	Rating	Name
F1	7.5 A	+12 V BAT rear foglamp
F6	5 A	+12 V BAT (TPMS) tyre pressures monitoring system ECU
F7	7.5 A	+12 V BAT anti-theft – IER telemetry box
F8	20 A	+12 V BAT radio – setma – bluebox
F11	5 A	+12 V BAT passenger compartment ECU (BCM)
F12	7.5 A	+12 V CTR relay – door CTR signal
F13	5 A	+12 V BAT dashboard
F14	15 A	+12 V BAT horns
F16	7.5 A	+12 V BAT passenger compartment ECU (BCM) – DIAG socket
F19	5 A	Left-hand brake lamp (EU only)
F20	5 A	Right-hand brake lamp (EU only)
F21	10 A	+12 V switched, brake lamps + third lamp
F23	5 A	+12 V switched, passenger compartment cooling fan unit (GMV)
F24	15 A	+12 V switched, 12 V accessory socket
F27	5 A	+12 V switched parking sensors (option)
F28	20 A	+12 V switched, radio – setma – bluebox
F29	5 A	+12 V switched, aerial amplifier
F31	5 A	+12 V switched, airbag control unit
F32	5 A	+12 V switched, IER telemetry box
F34	5 A	+12 V switched, motor management ECU (UCM)
F35	5 A	+12 V switched, ABS/ESP
F36	7.5 A	+12 V switched, illumination of switches ECU – diagnostic socket
F38	7.5 A	+12 V switched, high voltage battery – supervisor
F40	7.5 A	+12 V switched, electric power steering ECU

Identification markings/ VIN

The VIN of a vehicle is a code that allows each vehicle to be identified (Vehicle Identification Number).

The VIN can be found in two places on your E-MEHARI:

- The upper front crossmember
- The rear crossmember



Technical characteristics – Electric motor/LMP® battery/On-board charger

Motor characteristics

Characteristics of the motor in your E-MEHARI	
Type of motor	Permanent magnet
Maximum power	50 kW
Nominal power	35 kW

The LMP® battery

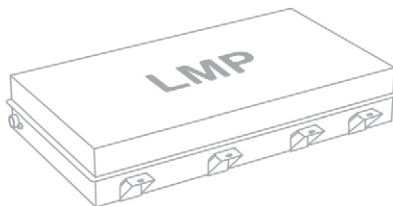

This LMP® battery stores, for an equivalent weight, five times more energy than a traditional battery, and can be recharged in a few hours.

The vehicle's range has been type-approved to European Regulation ECE 101R01.

The LMP® battery is made only of non-polluting materials.

At the end of its life, the LMP® battery will be collected and all of its components will be recycled or reused.

Battery characteristics (general, thermal and electric)

General characteristics	
Volume (L)	300
Weight (kg)	300

Thermal characteristics	
Internal temperature	60°C/80°C
Operating temperature	-20°C/+60°C

Electric characteristics	
Energy	30 kWh
Nominal voltage	410 V
Peak power	45 kW (30 s)
Min/max LMP® battery voltage	300/435 V
Capacity at C/4	75 Ah
Mass density	100 Wh/kg
Volume density	100 Wh/l
Maximum current	140 A

! Your E-MEHARI contains a high voltage LMP® battery isolated from its surroundings by its unique packaging arrangement. The LMP® battery must only be handled by trained and qualified persons.

On-board charger

To make your E-MEHARI as versatile as possible, it is fitted with an internal charger. Your E-MEHARI can be charged from any power point; the charger transforms the supply to suit the LMP® battery.

The charger in your E-MEHARI has the following characteristics:

Characteristics of the charger in your E-MEHARI	
Operating voltage	230 V
Charger current rating	16 A
Charging power rating at 16 A	3,300 W
Charging power rating at 10 A	2,200 W

Dimensions/Weights

Exterior dimensions

Dimensions of your E-MEHARI	
Length	3.81 m
Width	1.87 m (including the mirrors)
Height	1.65 m

Interior dimensions

Interior volumes of your E-MEHARI	
Boot volume	200 litres/800 litres with the bench seat folded
Number of seats	4

Weights

Weights of your E-MEHARI	
Gross vehicle weight (maximum laden weight)	1,838 kg
Kerb weight	1,451 kg

! Exceeding the weights specified above risks damaging your E-MEHARI and could cause an accident and serious injuries. The authorised weights must never be exceeded.

Tyres/Tyre pressures

Tyres fitted to your E-MEHARI	
Size	185/65 R15
Type	"Cross Climate" or equivalent
Brand	Michelin
Spare wheel	None (temporary puncture repair kit)
Tyre pressures	Front 2.4 bar /Rear 2.4 bar

! Check the tyre pressures regularly and always observe the inflation pressures indicated above. Low tyre pressures can cause premature wear of the tyres and introduce the risk of the tyres bursting. The tyre pressures must be regularly checked with the tyres cold, and adjusted if necessary.

! Replace worn tyres only by tyres of the same model as the original fitment, or equivalent, and have them fitted by a tyre fitting specialist.

! The responsibility for having the correct tyre pressures lies with the driver.

! Never exceed the speed rating or load index of the tyres fitted to the vehicle.

! It is for the driver to check the wear of the tyres using the wear indicators in the tyre tread.

Performance

Performance of your E-MEHARI	
Power	50 kW
Maximum speed	68 mph (110 km/h) (limited electronically)
Acceleration 0-37 mph (0-60 km/h)	7.3 seconds

Range

The vehicle's range has been type-approved to European Regulation ECE 101R01. In real use, several factors will vary the range of an electric vehicle; you have some control over these and so can make noticeable improvements in the range.

These factors are:

- speed and driving style
- road profile
- temperature settings
- tyres
- use of electrical accessories
- vehicle loading

Speed and driving style

High speed reduces the range of the vehicle. Sporty driving reduces the range of the vehicle: adopt a smooth driving style.

i Advice

- drive at constant speed
- adapt your driving style to avoid heavy energy consumption
- make use of energy recovery: anticipate the slowing of traffic early by taking your foot off the accelerator or by braking progressively

Road profile

On a hill, rather than trying to maintain your speed, do not depress the accelerator pedal more than on level ground: rather, keep the accelerator pedal in the same position.

Temperature settings

Using the heating or air conditioning reduces the range of the vehicle.

Tyres

Low tyre pressures increase energy consumption. Observe the tyre pressures recommended for your vehicle. When replacing tyres, give preference to tyres of the same brand, size, type and structure as the original fitment. Using tyres of different characteristics significantly reduces the range of the vehicle.

Vehicle loading

Avoid carrying unnecessary loads in the vehicle.

Brakes and suspension

Brakes and suspension on your E-MEHARI	
Brakes	Discs
Front/rear brake disc diameter	257 mm/250 mm
Front suspension	MacPherson
Rear suspension	Trailing arms with stabilising bars
Braking assistance	Electric braking assistance

Braking system

Your E-MEHARI has two braking systems:

- An energy recovery braking system
- A hydraulic braking system

Energy recovery braking system

The level of regeneration braking helping the hydraulic braking depends on the state of charge of the LMP® battery.

If the state of charge of the LMP® battery is 100%, the energy recovery braking does not operate.

Hydraulic braking system

The hydraulic braking system is similar to that used on conventional vehicles.

! When driving on slippery surfaces, take care when braking and accelerating. Sudden braking could cause the wheels to lose grip and lead to an accident and serious injuries.

A

Access, charging socket.....10, 58, 61
 Accessories34
 Adjusting the time7-9
 Advice on driving50
 Airbags39-41, 43-46
 Airbags, curtain.....40-41
 Airbags, front.....40-41, 44
 Airbags, lateral40-41
 Air conditioning28-29
 Anti-theft/Immobiliser10, 36
 Assistance call29, 35-36

B

Battery.....3-6, 66-67, 72-73
 Bonnet.....64-65
 Boot flap17
 Braking.....76
 Brightness.....7-9
 Bulbs69

C

Care of interior trim57
 Care of the bodywork.....57
 Central locking10-11
 Characteristics (components).....72-73
 Charger, built-in73
 Child seats42-43, 47-48
 Conditioning, air.....28-29
 Controls.....7-9
 Coolant, motor65
 Courtesy lamp.....29

D

Dashboard.....7-9
 Daytime running lamps31
 Deactivating the passenger airbag.....40, 43-46
 Demisting/defrosting the windscreen28
 Design3-6
 Dimensions73
 Direction indicators.....31, 48
 Doors.....10-12
 Drive selector.....54

F

Fault, electric.....5-6
 Flap, charging10, 58, 61
 Foglamp, rear.....31-32
 Fuses.....70-71

H

Hard top (rigid roof).....18-21
 Hazard warning lamps48-49
 Headlamps, automatic illumination32
 Headlamps, dipped beam.....31-32
 Headlamps, main beam.....31-32
 Heating26
 Hibernation mode66-67
 High voltage3-6, 35-36, 58, 64-65, 70, 73

I

Identification, vehicle72
 Indicators: speed – time – temperature.....7-9
 Inflating tyres74-75
 Instrument panel.....7-9
 Instruments and controls3
 ISOFIX mountings.....47-48

K

Key ring, personal RFID10-11, 36

L

Lamps, indicator/warning7-9
 Levels65-66
 Lighting, exterior31-33
 Lighting, interior29
 Locking, central.....11-12

M

Maintenance57
 Maintenance, mechanical.....64-66
 Mirrors25
 Mobility, electric3-6
 Motor characteristics72

O

Opening (access).....10-21

P

Parking brake53
 Pedals, control 52-53
 Performance 75
 Power cut-off in an accident35
 Power steering54
 Precautions regarding road traffic accidents 5
 Protecting children 38, 42-48
 Puncture repair kit, temporary69

R

Radio67-68
 Range4, 6, 58, 75
 Recharging the battery58-59, 61-63
 Recorder, total distance7-9

S

Safety, children 38, 42-48
 Safety, high voltage 3-6, 35-36, 58,
 64-65, 70, 73
 Screenwash33
 Screenwash fluid65-66
 Seat belts37-39
 Seat, rear bench 23-24
 Selector, drive54
 Sidelamps31-32
 Socket, 12 V30
 Socket, USB30
 Soft Top (fabric roof) 12-15
 Speakers68
 Starting/Switching off the vehicle51-52
 Steering wheel 24-25
 Suspension76
 Switch, starting51-52
 Symbols7-9

T

Tyres69, 74-75
 Tyre under-inflation detection55-56

U

Under-inflation (detection)55-56
 Under the bonnet64-65

V

Ventilation/Heating 26-28

W

Washing57
 Weights 74
 Windows, front15-16
 Windows, rear16-17



<https://www.automotive-manuals.net/>

<https://www.automotive-manuals.net/>

Automobiles CITROËN declares, by application of the provisions of the European legislation (Directive 2000/53) relating to End of Life Vehicles, that it achieves the objectives set by this legislation and that recycled materials are used in the manufacture of the products that it sells.

Reproduction or translation of all or part of this document is prohibited without written authorisation from Automobiles CITROËN.

Printed in the EU
Anglais

6-17

Automobiles CITROËN

Siège social : 6, rue Fructidor 75017 Paris - France

Tél. : +33 (0) 1 58 79 79 79 - www.citroen.com

Société anonyme au capital de 159 000 000 € - R.C.S. : 642 050 199 R.C.S. Paris - SIRET : 642 050 199 00990 - APE : 7010Z



