

## *OWNER'S MANUAL*

Operation  
Maintenance  
Specifications

All information in this Owner's Manual is current at the time of publication. However, Hyundai Motor India Limited reserves the right to make changes at any time without prior notice and without obligation to incorporate such changes so that our policy of continual product improvement may be carried out.

This manual applies to all variants of this vehicle and includes descriptions and explanations of optional as well as standard equipment.

As a result, you may find material in this manual that does not apply to your specific vehicle.

This manual is provided in non-writable PDF format and can be viewable on any computer or Device compatible with windows 7 & above and PDF reader. Avoid direct sunlight to CD & do not keep it in high temperature zone i.e more than 70 degree celcius.

## **CAUTION: MODIFICATIONS TO YOUR HYUNDAI**

Your Hyundai vehicle should not be modified in any way. Such modifications may adversely affect the performance, safety or durability of your HYUNDAI vehicle and may, in addition, violate conditions of the limited warranties covering the Hyundai vehicle. Certain modifications may also be in violation of regulations established by government agencies in your State/Country.

## **TWO-WAY RADIO OR CELLULAR TELEPHONE INSTALLATION**

Your Hyundai vehicle is equipped with electronic fuel injection and other electronic components. It is possible for an improperly installed/adjusted two-way radio or cellular telephone to adversely affect electronic systems. For this reason, we recommend that you carefully follow the radio manufacturer's instructions or consult your HYUNDAI dealer for precautionary measures or special instructions if you choose to install one of these devices.

## SAFETY AND VEHICLE DAMAGE WARNING

This manual includes information titled as DANGER, WARNING, CAUTION and NOTICE. These titles indicate the following:

### DANGER

**DANGER** indicates a hazardous situation which, if not avoided, will result in death or serious injury.

### WARNING

**WARNING** indicates a hazardous situation which, if not avoided, could result in death or serious injury.

### CAUTION

**CAUTION** indicates a hazardous situation which, if not avoided, could result in minor or moderate injury.

### **NOTICE**

**NOTICE** indicates a situation which, if not avoided, could result in vehicle damage.

## FOREWORD

Thank you for choosing HYUNDAI vehicle. We are pleased to welcome you to the growing number of discriminating people who drive HYUNDAI vehicle. The advanced engineering and high-quality construction of each HYUNDAI vehicle we build is something of which we're very proud.

Your Owner's Manual will introduce you to the features and operation & maintenance of your new HYUNDAI vehicle. It is suggested that you read it carefully because the information it contains can contribute greatly to the satisfaction you receive from your new car.

Hyundai Motor India Limited also recommends that service and maintenance on your vehicle be performed by an authorized HYUNDAI dealer.

## HYUNDAI MOTOR INDIA LIMITED

**Note :** Because future owners will also need the information included in this manual, if you sell this HYUNDAI vehicle, please leave the manual in the vehicle for the new owner's use. Thank you.

### CAUTION

**Severe engine and transaxle damage may result from the use of poor quality fuels and lubricants that do not meet HYUNDAI specifications. You must always use high quality fuels and lubricants that meet the specifications listed on Page 10-5 in the Vehicle Specifications section of the Owner's Manual.**

Copyright 2019 HYUNDAI Motor India limited. All rights reserved. No part of this manual can be reproduced in any retrieval system or transmitted in any form or by any means without the prior written permission of HYUNDAI Motor India Limited.

## HOW TO USE THIS MANUAL

We want to help you get the greatest possible driving pleasure from your vehicle. Your Owner's Manual can assist you in many ways. We strongly recommend that you read the entire manual. In order to minimize the chance of death or injury, you must read the DANGER, WARNING and CAUTION sections in the manual.

Illustrations complement the words in this manual to best explain how to enjoy your vehicle. By reading your manual, you will learn about features, important safety information, and driving tips under various road conditions.

The general layout of the manual is provided in the Table of Contents. Use the index when looking for a specific area or subject; it has an alphabetical listing of all information in your manual.

Sections: This manual has ten chapters plus an index. Each section begins with a brief list of contents so you can tell at a glance if that section has the information you want.

Your safety, and the safety of others, is very important. This Owner's Manual provides you with many safety precautions and operating procedures. This information alerts you to potential hazards that may hurt you or others, as well as damage to your vehicle.

Safety messages found on vehicle labels and in this manual describe these hazards and what to do to avoid or reduce the risks.

Warnings and instructions contained in this manual are for your safety. Failure to follow safety warnings and instructions can lead to serious injury or death.

Throughout this manual DANGER, WARNING, CAUTION, NOTICE and the SAFETY ALERT SYMBOL will be used.



This is the safety alert symbol. It is used to alert you to potential physical injury hazards. Obey all safety messages that follow this symbol to avoid possible injury or death. The safety alert symbol precedes the signal words DANGER, WARNING and CAUTION.

### DANGER

**DANGER** indicates a hazardous situation which, if not avoided, will result in death or serious injury.

### WARNING

**WARNING** indicates a hazardous situation which, if not avoided, could result in death or serious injury.

## TABLE OF CONTENTS

Maintenance Record Sheet	1
Hyundai Warranty Policy	2
Your vehicle at a glance	3
Safety system of your vehicle	4
Convenient features of your vehicle	5
Multimedia System	6
Driving your vehicle	7
What to do in an emergency	8
Maintenance	9
Specifications & Consumer information	10
Index	I

# Maintenance Record Sheet

Maintenance Record Sheet ..... 1-2

# Maintenance Record Sheet

(Repair category - Free Ser./Paid Ser./Running Repair/A c. Repair)

Repair Date	RO No.	Kms.	Repair Category	Details of repair done	Name of Servicing Dealer	Ser. Adv. Sign.	Tech. Sign.



(Repair category - Free Ser./Paid Ser./Running Repair/A c. Repair)

Repair Date	RO No.	Kms.	Repair Category	Details of repair done	Name of Servicing Dealer	Ser. Adv. Sign.	Tech. Sign.

# Maintenance Record Sheet

(Repair category - Free Ser./Paid Ser./Running Repair/A c. Repair)

Repair Date	RO No.	Kms.	Repair Category	Details of repair done	Name of Servicing Dealer	Ser. Adv. Sign.	Tech. Sign.

# Hyundai Warranty Policy

Hyundai new vehicle warranty.....	2-2
Replacement parts warranty .....	2-3
Emission warranty .....	2-5
Hyundai extended warranty.....	2-7

### HYUNDAI NEW VEHICLE WARRANTY

Hyundai Motor India Limited hereinafter called "HMIL", warrants that each new Hyundai vehicle sold shall be free from any defects in material and workmanship, under normal use and maintenance, subject to the following terms and conditions.

#### 1. Warranty period

This warranty shall exist for a period of 36 months from the date of delivery to the first purchaser irrespective of the mileage. However, warranty for  being used for commercial purpose such as Taxi/Tourist operation is 36 months/100,000 kilometers from the date of delivery which soever is earlier. This warranty is transferable to subsequent owner for the remaining warranty period. This warranty is applicable only in India and not transferable to any other country.

#### 2. What is covered

Except as provided in paragraph 3 hereof, our Authorized Dealers shall either repair or replace, any Hyundai genuine part that is acknowledged by HMIL to be defective in material or

workmanship within the warranty period stipulated above, at no cost to the owner of the Hyundai vehicle for parts or labour. Such defective parts which have been replaced will become the property of HMIL.

#### 3. What is not covered

This warranty shall not apply to:

- o Normal maintenance services other than the three free services, including without limitation, cleaning and polishing, minor adjustments, engine tuning, oil/fluid changes, filters replenishment, fastener retightening, wheel balancing, wheel alignment and tyre rotation etc.
  - o Replacement of parts as a result of normal wear and tear such as spark plugs, belts, brake pads and linings, clutch disc/facing, filters, wiper blades, bulbs, fuses, etc.
  - o Damage or failure resulting from:
    - ❖ Negligence of proper maintenance as required in this Owner's Manual and Service Booklet.
    - ❖ Misuse, abuse, accident, theft, flooding or fire.
- ❖ Use of improper or insufficient fuel, fluids or lubricants.
  - ❖ Use of parts other than Hyundai Genuine Parts.
  - ❖ Any device and/or accessories not supplied by HMIL.
  - ❖ Modifications, alterations, tampering or improper repair.
  - ❖ Parts used in applications of which they were not designed or not approved by HMIL.
  - ❖ Slight irregularities not recognised as affecting quality or function of the vehicle or parts, such as slight noise or vibrations, or items considered characteristic of the vehicle.
  - ❖ Airborne "fallout", Industrial fall out, acid rain, hail and wind storms, or other Acts of God.
  - ❖ Paint scratches, dents or similar paint or body damage.
  - v Action of road elements (sand, gravel, dust or road debris) which results in stone chipping of paint or glass.

- o Incidental or consequential damages, including without limitation, loss of time, inconvenience, loss of use of vehicle or commercial loss.

Audio Video Navigation System, Batteries, Wireless Charger, Tyres & Tubes and Audio Systems, originally equipped on Hyundai vehicles are warranted directly by the respective manufacturers and not by HMIL.

This warranty is the entire warranty given by HMIL for Hyundai vehicles and no dealer or its or his agent or employee is authorized to extend or enlarge this warranty and no dealer or its or his agent or employee is authorized to make any oral warranty on HMIL's behalf.

HMIL reserves the right to make any change in design or make any improvement on the vehicle at any time without any obligation to make the same change on vehicles previously sold.

HMIL reserves the right for the final decision in all warranty matters.

### Owner's Responsibilities

- o Proper use, maintenance and care of vehicle in accordance with the instructions contained in this Owner's Manual and Service Booklet. If the vehicle is subject to severe usage conditions, such as operation in extremely dusty, rough, more repeated short distance driving or heavy city traffic during hot weather, maintenance of vehicle should be done more frequently as mentioned in this Owner's Manual and Service Booklet.
- o Retention of maintenance service records. It may be necessary for the customer to show that the required maintenance has been performed, as specified in this Owner's Manual and Service Booklet.
- o Delivery of the vehicle during regular service business hours to any authorized Hyundai Dealer to obtain warranty service.
- o In order to maintain the validity of this Basic Warranty, the vehicle must be serviced by Hyundai Authorized workshop in accordance to the Owner's Manual and Service Booklet.

## PARTS REPLACEMENT WARRANTY

Hyundai Motor India Limited hereinafter called "HMIL", warrants that each new Hyundai Genuine replacement part purchased from and installed by Hyundai Authorized Dealer shall be free from any defects in material or workmanship, under normal use and maintenance, subject to the following terms and conditions.

### 1. Warranty period

This warranty shall exist for a period of 6 months or until the vehicle has been driven for a distance of 10,000 Kilometers from the date of installation of replacement part by Hyundai Authorized Dealer, whichever occurs first.

### 2. What is covered

Except as provided in paragraph 3 hereof, our Authorized Dealer who had sold and installed the replacement part earlier shall either repair or replace the said Hyundai genuine part that is acknowledged by HMIL to be defective in material or workmanship within the warranty period stipu-

lated above, at no cost to the owner of the Hyundai vehicle for parts or labour.

### 3. What is not covered

This warranty shall not apply to:

- o Normal maintenance services of parts such as cleaning, adjustment or replacement (i.e. spark plugs that are oil fouled, lead fouled, or which fail due to the use of low grade fuel).
- o Parts that fail due to abuse, misuse, neglect, alteration or accident or which have been improperly lubricated or repaired.
- o Parts used in applications for which they were not designed or approved by HMIL.
- o Failure due to normal wear of parts.
- o Direct or indirect failures caused by misuse and improper maintenance of vehicle and installation of non-Hyundai parts on the vehicle.
- o Any vehicle on which the odometer reading has been altered so that mileage cannot be accurately determined.

- o Incidental or consequential damages, including without limitation, loss of time, inconvenience, loss of use of vehicle or commercial loss.

This warranty is the entire warranty given by HMIL for Hyundai replacement parts and no dealer or its or his agent or employee is authorized to extend or enlarge this warranty and no dealer or its or his agent or employee is authorized to make any oral warranty on HMIL's behalf.

HMIL reserves the right for the final decision in all warranty matters.

### Owner's Responsibilities

- o Proper use, maintenance and care of the vehicle in accordance with the instructions contained in the Owner's Manual and Service Booklet.
- o Retention of maintenance service records. It may be necessary for the customer to show that the required maintenance has been performed, as specified in this Owner's Manual and Service Booklet.

- o Retention of the customer's copy of the original repair order and its invoice/bill against which the part was replaced.
- o Delivery of the vehicle during regular service business hours to the same Hyundai Authorized Dealer who had sold and installed the replacement part.
- o In order to maintain the validity of this Parts replacement Warranty, the vehicle must be serviced by Hyundai Authorized workshop in accordance to the Owner's Manual and Service Booklet.

### EMISSION WARRANTY

HMIL extends the Mass Emission standards (BSIV) for its vehicle in the following cities:

(1) Delhi/NCR, (2) Mumbai, (3) Chennai, (4) Chennai, (5) Bangalore (6) Hyderabad including Secunderabad, (7) Ahmedabad, (8) Pune, (9) Surat, (10) Kanpur, (11) Agra. (For the vehicles Manufactured on or after 01/04/2010)

(12) Lucknow (13) Sholapur (For the vehicles Manufactured on or after 01/06/2010).

(14) Puduchery, (15) Mathura, (16) vapi, (17) Jamnagar, (18) Ankleshwar, (19) Hissar, (20) Bharatpur, (21) Silvassa, (22) Dama & Diu, (23) Aligarh, (24) Rae Bareilly, (25) Unnao, (26) Karnal, (27) Kurukshetra, (28) Yamunanagar, (29) Valsad, (30) Nizamabad, (31) Medak & (30) Mehboobnagar (For the vehicles Manufactured on or after 01/10/2010).

The Mass Emission Standards (BS III) shall apply to all the states and union territories, except at above. As and when Govt. of India notifies additional/new cities under Mass Emission Standards (BS IV), Such cities would be automatically covered.

Subject to other terms of the warranty policy and the conditions and obligations laid down hereunder, Hyundai Motor India Limited hereinafter called "HMIL", certifies that the components liable to affect the emission of the gaseous pollutants in the vehicle in normal use despite the use to which it may be subjected, comply with the provisions of Rule

115(2) of the Central Motor Vehicle Rules, 1989 hereinafter referred to as the "In-use emission standard", and further warrants that if on examination by a dealer duly authorized by HMIL, the vehicle is discovered to be failing to meet the In-use emission standard as specified in the said rule, our Authorized Dealer shall take such corrective measures as may be necessary and shall at its sole discretion either repair or replace free of charge, such components of emission control system as are specified in paragraph 3 hereof.

### 1. Warranty period

This warranty will be in addition to and run parallel to the New Vehicle Warranty and shall exist for a period of 36 months from the date of delivery to the first purchaser, irrespective of the mileage. This warranty is transferable to subsequent owner for the remaining warranty period.

### 2. What is covered

Our Authorized Dealers shall either repair or replace, any Hyundai genuine part listed in paragraph 3 hereof, that is acknowledged by HMIL to be defective in material or workmanship within the warranty period stipulated above, after examinations carried out to confirm that none of the original settings have been tampered with, at no cost to the owner of the Hyundai vehicle for parts or labour. Such defective parts which have been replaced will become the property of HMIL.

### 3. Emission Warranty Parts List

- 3.1 Engine Control Module System
  - Engine Control Module
  - Crankshaft Position Sensor, Camshaft Position Sensor, Throttle Position Sensor, MAP Sensor, O<sub>2</sub> Sensor, IAT & ECT Sensor
- 3.2 Fuel Metering System
  - Fuel injectors
  - Fuel Pumps
- 3.3 Air Induction System
  - Air Cleaner Housing Assembly

- Throttle Body
  - Intake Manifold
  - Idle Speed Control Actuator
- 3.4 Ignition System
- H.T. Cable Set
  - Ignition Coil
  - Power Transistor
  - Distributor and internal parts
- 3.5 Evaporative Emission Control System
- Vapour Storage Canister
  - Fuel Tank
  - Fuel Filler Tube and Fuel filler Cap
  - Purge Control Solenoid Valve
  - Canister Close Valve
- 3.6 PCV System
- PCV Valve.
  - PCV Hoses
  - Oil Filler Cap
- 3.7 Catalytic Converter System
- Exhaust Manifold
  - Exhaust Pipe Assembly
  - Catalytic Converter
- 3.8 Exhaust Gas Recirculation (EGR) System (Diesel Engines)
- EGR Control System
- 3.9 Miscellaneous items used in above Systems

- Vacuum hoses, clamps, fittings, tubing or mounting hardware used with the above systems. Valves, Switches and Solenoids.

#### 4. What is not covered

This Emission Warranty shall not apply to:

- o Normal maintenance services including without limitation, engine tuning, oil/fluid changes, filters replenishment, etc.
- o Replacement of parts as a result of normal wear and tear such as spark plugs, filters, etc.
- o The vehicle reported without valid 'Pollution Under Control' certificate for the period immediately preceding the test during which the failure is discovered.
- o The vehicle which has been run on adulterated fuel or lubricant or fuel/lubricants other than those specified by HMIL.
- o Damage or failure resulting from:
  - ❖ Negligence of proper maintenance as required in this Owner's Manual and Service

Booklet.

- ❖ Misuse, abuse, accident, theft, flooding or fire.
  - ❖ Use of improper or insufficient fuel, fluids or lubricants.
  - ❖ Any repair carried out other than by Hyundai Authorized Dealer/ Service Centre.
  - ❖ Use of parts other than Hyundai Genuine Parts.
  - ❖ Any device and/or accessories not supplied by HMIL.
  - ❖ Modifications, alterations, tampering or improper repair.
  - ❖ Parts used in applications for which they were not designed or not approved by HMIL.
  - ❖ Any penalties that may be charged by statutory authorities on account of failure to comply with the In-use emission standards.
  - ❖ The vehicle in which the odometer has been tampered with, changed or been disconnected.
- o Any consequential repairs or replacement of parts which may be found necessary to establish compliance to In-use emission



standards, in addition to the replacement of the components covered under Emission Warranty, will not be made free of cost unless such parts are also found to be in warrantable condition within the scope and limit of the New Vehicle Warranty.

- o Incidental or consequential damages, including without limitation, loss of time, inconvenience, loss of use of vehicle or commercial loss.

This warranty is the entire warranty given by HMIL for Hyundai vehicles and no dealer or its or his agent or employee is authorized to extend or enlarge this warranty and no dealer or its or his agent or employee is authorized to make any oral warranty on HMIL's behalf.

HMIL reserves the right to make any change in design or make any improvement on the vehicle at any time without any obligation to make the same change on vehicles previously sold.

HMIL reserves the right for the final decision in all warranty matters.

## OWNER'S RESPONSIBILITIES

- o Proper use, maintenance and care of vehicle in accordance with the instructions contained in this Owner's Manual and Service Booklet. If the vehicle is subject to severe usage conditions, such as operation in extremely dusty, rough, more repeated short distance driving or heavy city traffic during hot weather, maintenance of vehicle should be done more frequently as mentioned in this Owner's Manual and Service Booklet.
- o In order to maintain the validity of this Emission Warranty, the vehicle must be serviced by Hyundai Authorized Dealer or Service Centre in accordance to the Owner's Manual and Service Booklet.
- o Retention of maintenance service records. It may be necessary for the customer to show that the required maintenance has been performed, as specified in this Owner's Manual and Service Booklet.
- o Immediate Delivery of the vehicle to any authorized Hyundai Dealer

- o upon discovery of failure to comply with the In-use emission standard in spite of proper use, maintenance and care of vehicle in accordance with the instructions contained in this Owner's Manual and Service Booklet.
- o Production of "Pollution Under Control" (PUC) certificate valid for the period immediately preceding the test during which the failure is discovered, the test having been carried out either for obtaining a new certificate, or pursuant upon being directed by an officer as referred to in sub-rule (2) of Rule 116 of the Central Motor Vehicles Rules.

## HYUNDAI EXTENDED WARRANTY\*

HMIL offers optional paid extended warranty on selected models, in addition to the basic new vehicle warranty. For more details on Hyundai Extended Warranty please call the nearest dealer or our toll free number 1-800-11-4645

*\*Conditions apply*

## We are pleased to introduce you to our 24 X 7 Hyundai Road Side Assistance Programme

**Our Road Side Assistance number is : 1800 102 4645 (toll free),  
(0124) 2564645 ( call charges apply)**

Hyundai Roadside Assistance is a 24 X 7 emergency support provided in the event of any mechanical/ electrical breakdown and/or road traffic accident of a vehicle.

### Covered events & benefits \*

**Break Down/Accident**



**Roadside repair or vehicle recovery in case of breakdown/road traffic accident.\*\***

**Tire Related**



**Tire Puncture-Replacement of punctured tire with the spare tire.**

**Battery related**



**Dead Battery-Jump start.**

**Key Related**



**Locked keys, lost keys or broken vehicle keys.**

**Fuel related**



**Out of fuel, incorrect fuel or contaminated fuel.**

**\*Terms and conditions apply.**

#### **Terms & Conditions**

- 1). The service is applicable for the basic warranty period of the vehicle.
- 2). The 24 X 7 Road side assistance is available up to a distance of 50 kilometer from an Hyundai authorized dealer workshop.
- 3). The service is applicable for a condition in which the vehicle has been immobile.
- 4). Cost of parts replacement is not included, unless covered under Hyundai Warranty.
- 5). Cost of repairs made to your vehicle is not included, unless it is covered under Hyundai Warranty.

**\*\* : Road traffic accident covered for vehicles sold after 1st March 2014**

## Your vehicle at a glance

Exterior overview (I) .....	3-2
Exterior overview (II) .....	3-3
Interior overview (I) .....	3-4
Interior overview (II) .....	3-5
Instrument panel overview (I).....	3-6
Instrument panel overview (II).....	3-7
Engine compartment .....	3-8

## EXTERIOR OVERVIEW (I)

■ Front view

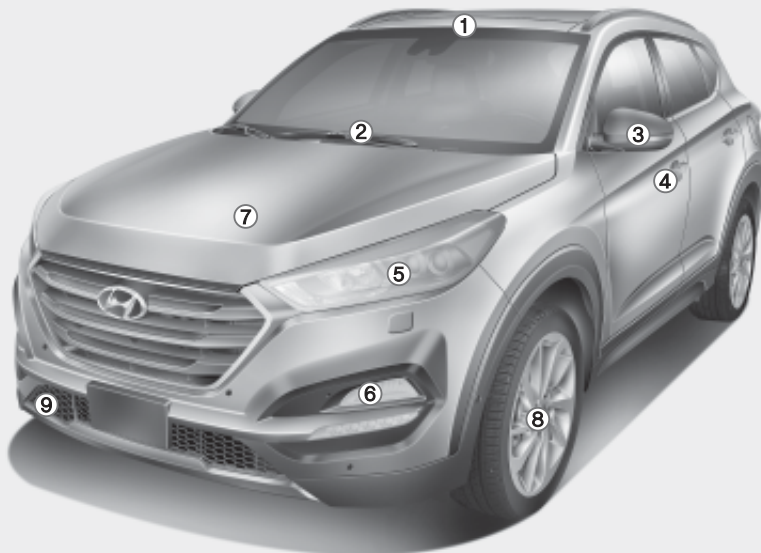

- 1. Panorama sunroof .....5-41
- 2. Front windshield wiper blades .....9-43
- 3. Outside rearview mirror .....5-32
- 4. Door locks.....5-14
- 5. Head light .....9-80
- 6. Front fog light.....9-80
- 7. Hood .....5-46
- 8. Tires and wheels .....9-49
- 9. Towing hook.....8-26

The actual shape may differ from the illustration.

OTL015001L

## EXTERIOR OVERVIEW (II)

■ Rear view

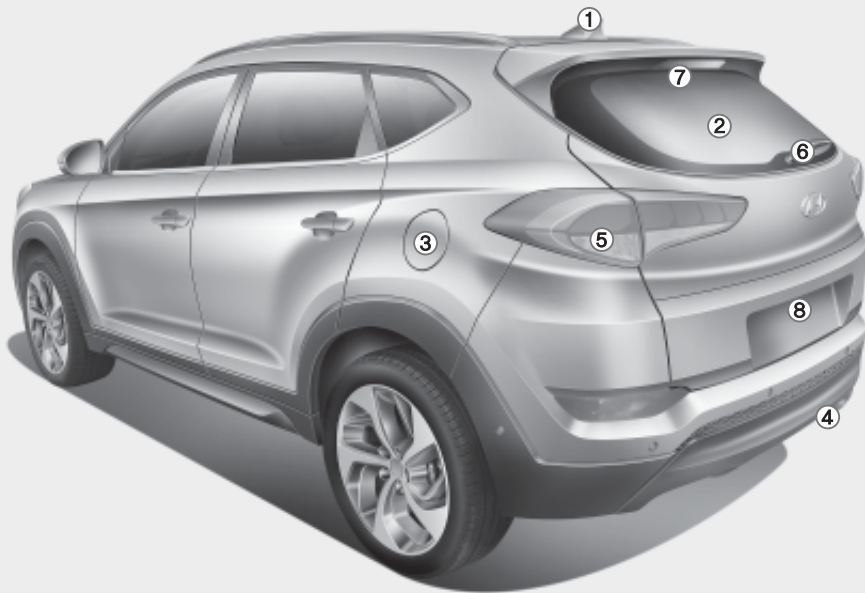

- 1. Antenna .....6-2
- 2. Defroster.....5-144
- 3. Fuel filler door.....5-48
- 4. Towing hook.....8-26
- 5. Rear combination lamp .....9-93
- 6. Rear window wiper blade .....9-44
- 7. High mounted stop lamp .....9-96
- 8. Rearview camera.....5-135

The actual shape may differ from the illustration.

OTL015002L

## INTERIOR OVERVIEW (I)

■ Left-Hand drive type

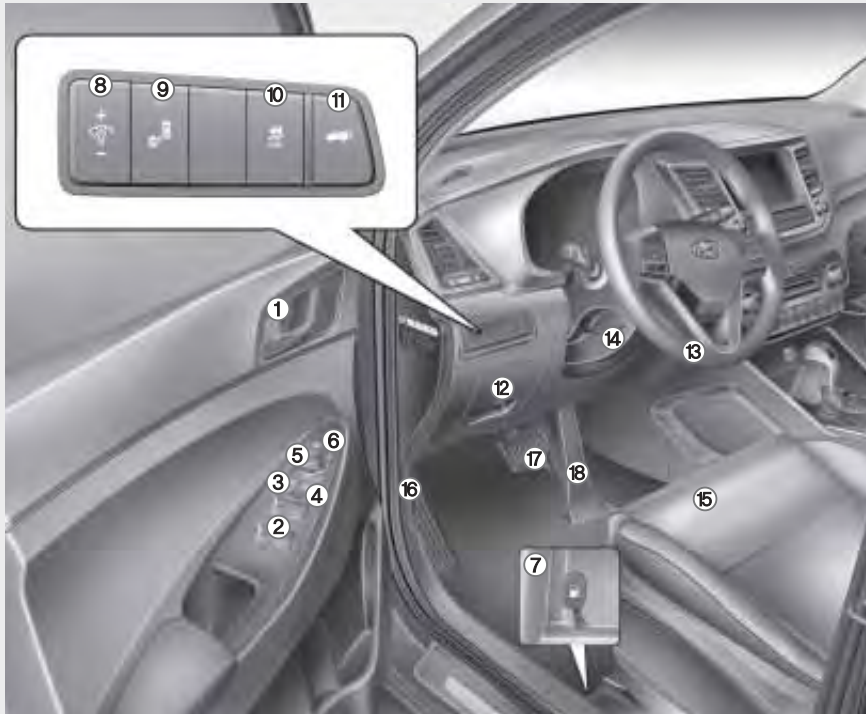

The actual shape may differ from the illustration.

- 1. Door lock/unlock button .....5-16
- 2. Power window switches\* .....5-35
- 3. Central door lock switch\* .....5-17
- 4. Power window lock switch\* .....5-39
- 5. Outside rearview mirror control switch\* .....5-33
- 6. Outside rearview mirror folding button\* .....5-34
- 7. Fuel filler door opener .....5-48
- 8. Instrument panel illumination control switch\* .....5-66
- 9. BSD switch\* .....7-77
- 10. ESC OFF button\* .....7-55
- 11. Power tailgate button\* .....5-53
- 12. Fuse box .....9-63
- 13. Steering wheel .....5-24
- 14. Steering wheel tilt/telescope control\* .....5-25
- 15. Seat .....4-4
- 16. Hood release lever .....5-46
- 17. Brake pedal .....7-40
- 18. Accelerator pedal

\* : if equipped

OTL015003L

## INTERIOR OVERVIEW (II)

■ Right-Hand drive type

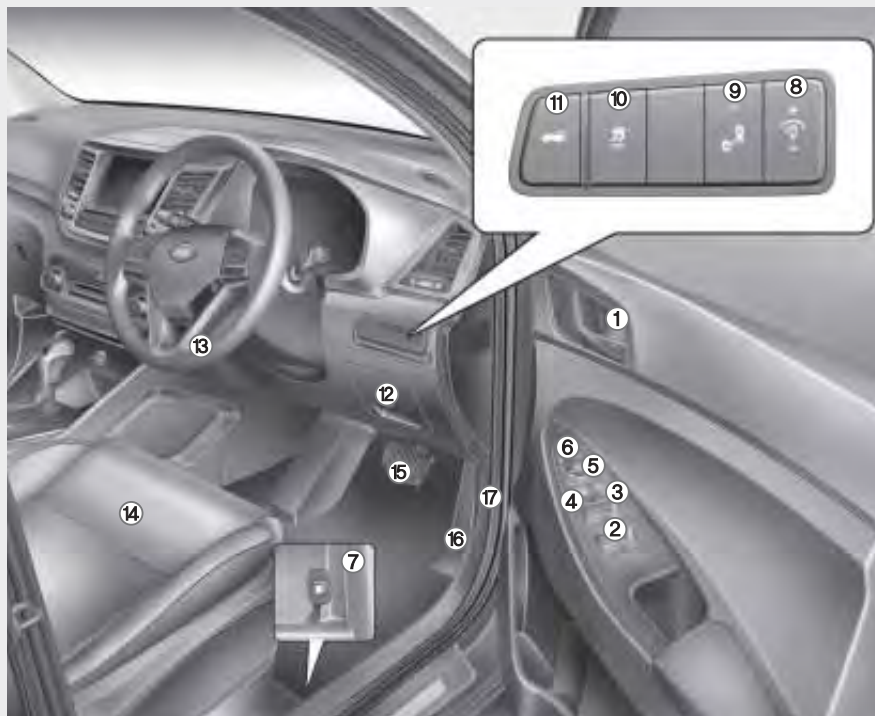

The actual shape may differ from the illustration.

- 1. Door lock/unlock button .....5-16
- 2. Power window switches\* .....5-35
- 3. Central door lock switch\* .....5-17
- 4. Power window lock switch\* .....5-39
- 5. Outside rearview mirror control switch\* .....5-33
- 6. Outside rearview mirror folding button\* .....5-34
- 7. Fuel filler door opener .....5-48
- 8. Instrument panel illumination control switch\* .....5-66
- 9. BSD switch\* .....7-77
- 10. ESC OFF button\* .....7-55
- 11. Power tailgate button\* .....5-53
- 12. Fuse box .....9-63
- 13. Steering wheel .....5-24
- 14. Seat .....4-4
- 15. Brake pedal .....7-40
- 16. Accelerator pedal
- 17. Hood release lever .....5-46

\* : if equipped

OTL015007R

## INSTRUMENT PANEL OVERVIEW (I)

■ Left-Hand drive type

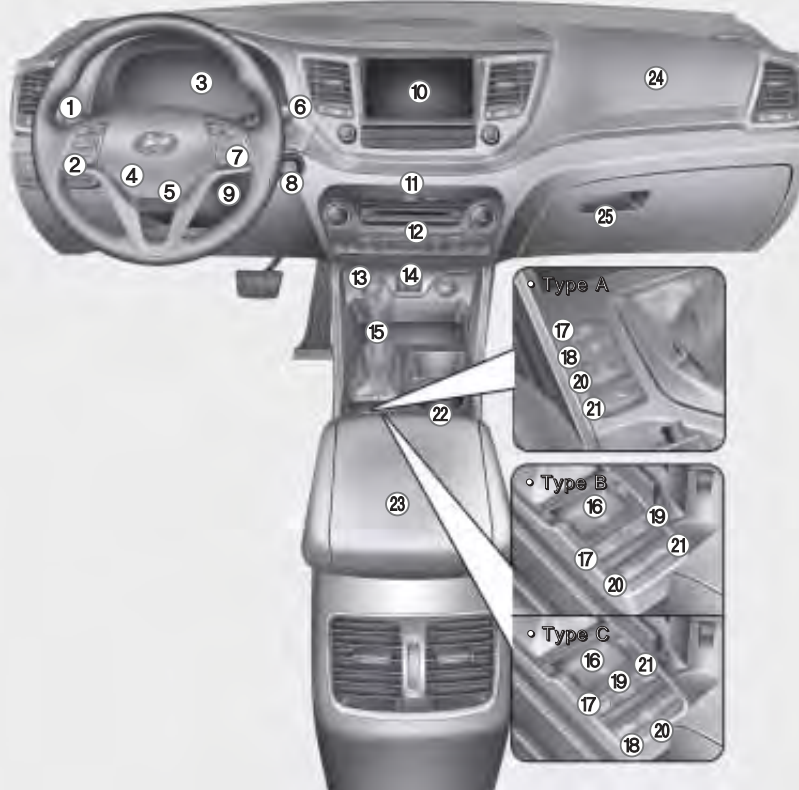

The actual shape may differ from the illustration.

- 1. Light control/Turn signals .....5-116
- 2. Steering wheel audio controls\* .....6-4
- 3. Instrument cluster .....5-64
- 4. Horn .....5-26
- 5. Driver's front air bag .....4-54
- 6. Wiper/Washer.....5-131
- 7. Auto cruise controls\* .....7-84
- 8. Engine start/stop button\* .....7-11
- 9. Ignition switch .....7-6
- 10. Audio/AVN\* .....6-22
- 11. Hazard warning flasher switch. ....8-2
- 12. Climate control system\* ...5-146, 5-158
- 13. Cigarette lighter\* .....5-185
- 14. AUX, USB\* .....6-2
- 15. Shift lever .....7-20, 7-24, 7-31
- 16. EPB switch\*. ....7-44
- 17. Drive mode or  
Flex steering wheel\* .....7-73, 7-71
- 18. DBC button\* .....7-61
- 19. Auto hold button\* .....7-49
- 20. 4WD Lock button\* .....7--65
- 21. Rear parking assist OFF button or  
Parking assist button\* .....5-138, 5-140
- 22. Cup holder\* ..... 5-181
- 23. Console box .....5-178
- 24. Passenger's front air bag\* .....4-54
- 25. Glove box .....5-179

\* : if equipped

OTL015005L



## INSTRUMENT PANEL OVERVIEW (II)

■ Right-Hand drive type



1. Light control/Turn signals .....5-116
  2. Steering wheel audio controls\* .....5-4
  3. Instrument cluster .....5-64
  4. Horn .....5-26
  5. Driver's front air bag. ....4-54
  6. Wiper/Washer.....5-131
  7. Auto cruise controls\* .....7-84
  8. Engine start/stop button\* .....7-11
  9. Audio/AVN\* .....6-22
  10. Hazard warning flasher switch.....8-2
  11. Climate control system\* ..5-146, 5-158
  12. Cigarette lighter\* .....5-185
  13. AUX, USB\* .....6-2
  14. Shift lever .....7-20, 7-24, 7-31
  15. EPB switch\* .....7-44
  16. Auto hold button\* .....7-49
  17. DBC button\* .....7-61
  18. Drive mode or Flex steering wheel\* .....7-73, 7-71
  19. 4WD Lock button\* .....7-65
  20. Rear parking assist OFF button or Parking assist button\* .....5-138,5-140
  21. Cup holder\* .....5-181
  22. Console box .....5-178
  23. Passenger's front air bag\* .....4-54
  24. Glove box .....5-179
- \* : if equipped

The actual shape may differ from the illustration.

OTL015005R

## ENGINE COMPARTMENT

### ■ Gasoline Engine (Nu 2.0 MPI)

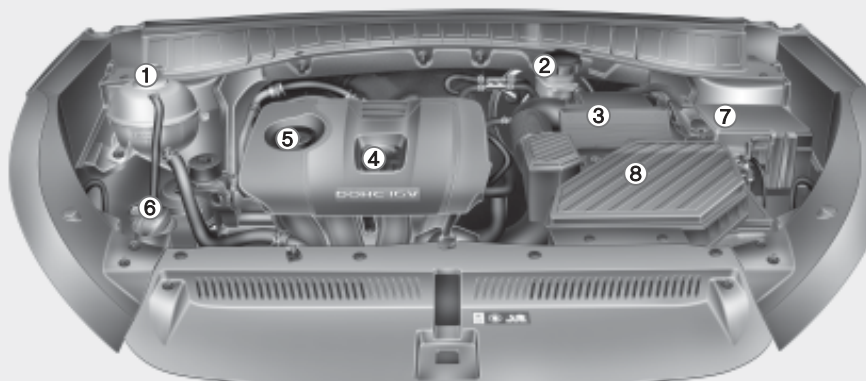

- 1. Engine coolant reservoir .....9-30
- 2. Brake/clutch fluid reservoir .....9-34
- 3. Air cleaner.....9-39
- 4. Engine oil dipstick.....9-28
- 5. Engine oil filler cap .....9-29
- 6. Windshield washer fluid reservoir .....9-36
- 7. Fuse box .....9-63
- 8. Battery .....9-45

The actual engine room in the vehicle may differ from the illustration.

OTLE075002/OTLE075003

■ Diesel Engine (R 2.0 TCI)



- 1. Engine coolant reservoir .....9-30
- 2. Brake/clutch fluid reservoir .....9-34
- 3. Air cleaner .....9-39
- 4. Engine oil dipstick .....9-28
- 5. Engine oil filler cap .....9-29
- 6. Windshield washer fluid reservoir ....9-36
- 7. Fuse box .....9-63
- 8. Battery .....9-45
- 9. Fuel filter .....9-38

The actual engine room in the vehicle may differ from the illustration.

OTL075001

# Safety system of your vehicle

This chapter provides you with important information about how to protect yourself and your passengers. It explains how to properly use your seats and seat belts, and how your air bags work. Additionally, this chapter explains how to properly restrain infants and children in your vehicle.

<b>Important safety precautions</b> .....	4-2	<b>Child Restraint System (CRS)</b> .....	4-38
Always wear your seat belt .....	4-2	Children always in the rear .....	4-38
Restrain all children .....	4-2	Selecting a Child Restraint System (CRS) .....	4-39
Air bag hazards .....	4-2	Installing a Child Restraint System (CRS).....	4-41
Driver distraction .....	4-2	<b>Air bag</b>	
Control your speed .....	4-3	- supplemental restraint system.....	4-50
Keep your vehicle in safe condition .....	4-3	Where are the air bags? .....	4-53
<b>Seats</b> .....	4-4	How does the air bags system operate? .....	4-58
Safety precautions .....	4-6	What to expect after an air bag inflates .....	4-62
Front seats.....	4-7	Do not install a Child Restraint System on the front passenger seat.....	4-63
Rear seats.....	4-14	Why didn't my air bag go off in a collision? .....	4-64
Headrest .....	4-17	SRS care .....	4-69
Seat warmers and air ventilation seats.....	4-21	Additional safety precautions .....	4-70
<b>Seat belts</b> .....	4-25	Air bag warning labels .....	4-71
Seat belt safety precautions .....	4-25		
Seat belt warning light .....	4-26		
Seat belt restraint system .....	4-27		
Additional seat belt safety precautions .....	4-35		
Care of seat belts .....	4-37		

### IMPORTANT SAFETY PRECAUTIONS

You will find many safety precautions and recommendations throughout this section, and throughout this manual. The safety precautions in this section are among the most important.

#### Always wear your seat belt

A seat belt is your best protection in all types of accidents. Air bags are designed to supplement seat belts, not replace them. So even though your vehicle is equipped with air bags, ALWAYS make sure you and your passengers wear your seat belts, and wear them properly.

#### Restrain all children

All children under age 13 should ride in your vehicle properly restrained in a rear seat, not the front seat. Infants and small children should be restrained in an appropriate Child Restraint System. Larger children should use a booster seat with the lap/shoulder belt until they can use the seat belt properly without a booster seat.

#### Air bag hazards

While air bags can save lives, they can also cause serious or fatal injuries to occupants who sit too close to them, or who are not properly restrained. Infants, young children, and short adults are at the greatest risk of being injured by an inflating air bag. Follow all instructions and warnings in this manual.

#### Driver distraction

Driver distraction presents a serious and potentially deadly danger, especially for inexperienced drivers. Safety should be the first concern when behind the wheel and drivers need to be aware of the wide array of potential distractions, such as drowsiness, reaching for objects, eating, personal grooming, other passengers, and using cellular phones.

Drivers can become distracted when they take their eyes and attention off the road or their hands off the wheel to focus on activities other than driving. To reduce your risk of distraction and an accident:

- ALWAYS set up your mobile devices (i.e., MP3 players, phones, navigation units, etc.) when your vehicle is parked or safely stopped.
- ONLY use your mobile device when allowed by laws and conditions permit safe use. NEVER text or email while driving. Most countries have laws prohibiting drivers from texting. Some countries and cities also prohibit drivers from using handheld phones.

- 
- NEVER let the use of a mobile device distract you from driving. You have a responsibility to your passengers and others on the road to always drive safely, with your hands on the wheel as well as your eyes and attention on the road.

### Control your speed

Excessive speed is a major factor in crash injuries and deaths. Generally, the higher the speed, the greater the risk, but serious injuries can also occur at lower speeds. Never drive faster than is safe for current conditions, regardless of the maximum speed posted.

### Keep your vehicle in safe condition

Having a tire blowout or a mechanical failure can be extremely hazardous. To reduce the possibility of such problems, check your tire pressures and condition frequently, and perform all regularly scheduled maintenance.

## SEATS

■ Left-hand drive

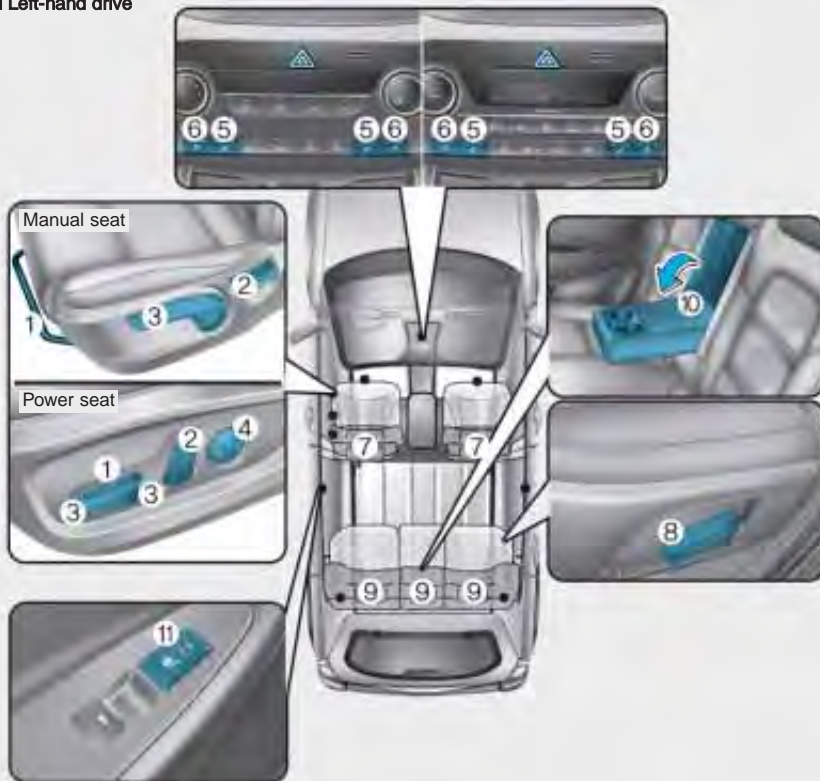

### Front seat

- (1) Forward and backward
- (2) Seatback angle
- (3) Seat cushion height (Driver's seat)
- (4) Lumbar support (Driver's seat)\*
- (5) Seat warmer\*
- (6) Air ventilation seat\*
- (7) Headrest

### 2nd row seat

- (8) Seatback angle and folding
- (9) Headrest
- (10) Armrest
- (11) Seat warmer\*

\* : if equipped

■ Right-hand drive

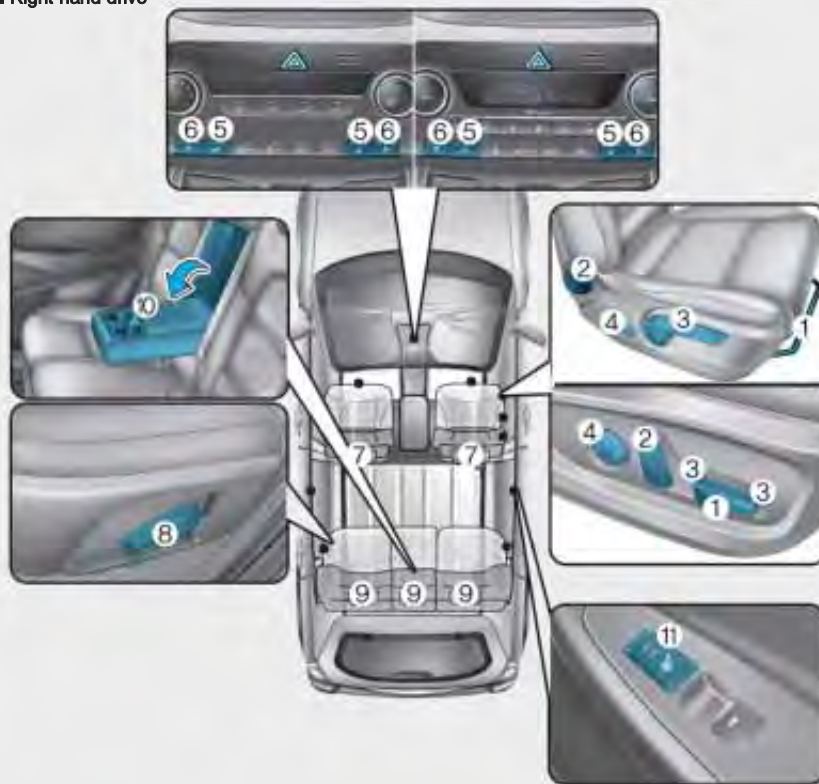

### Front seat

- (1) Forward and backward
- (2) Seatback angle
- (3) Seat cushion height (Driver's seat)
- (4) Lumbar support (Driver's seat)\*
- (5) Seat warmer\*
- (6) Air ventilation seat\*
- (7) Headrest

### 2nd row seat

- (8) Seatback angle and folding
- (9) Headrest
- (10) Armrest
- (11) Seat warmer\*

\* : if equipped

OTL035001R



### Safety precautions

Adjusting the seats so that you are sitting in a safe, comfortable position plays an important role in driver and passenger safety together with the seat belts and air bags in an accident.

#### WARNING

Do not use a cushion that reduces friction between the seat and the passenger. The passenger's hips may slide under the lap portion of the seat belt during an accident or a sudden stop. Serious or fatal internal injuries could result because the seat belt cannot operate properly.

### Air bags

You can take steps to reduce the risk of being injured by an inflating air bag. Sitting too close to an air bag greatly increases the risk of injury in the event the air bag inflates. Move your seat as far back as possible from front air bags, while still maintaining control of the vehicle.

#### WARNING

To reduce the risk of serious injury or death from an inflating air bag, take the following precautions:

- Adjust the driver's seat as far to the rear as possible while maintaining the ability to maintain full control of the vehicle.
- Adjust the front passenger seat as far to the rear as possible.

(Continued)

(Continued)

- Hold the steering wheel by the rim with hands at the 9 o'clock and 3 o'clock positions to minimize the risk of injuries to your hands and arms.
- NEVER place anything or anyone between the air bag.
- Do not allow the front passenger to place feet or legs on the dashboard to minimize the risk of leg injuries.

### Seat belts

Always fasten your seat belt before starting any trip.

At all times, passengers should sit upright and be properly restrained. Infants and small children must be restrained in appropriate Child Restraint Systems. Children who have outgrown a booster seat and adults must be restrained using the seat belts.

#### WARNING

Take the following precautions when adjusting your seat belt:

- NEVER use one seat belt for more than one occupant.
- Always position the seatback upright with the lap portion of the seat belt snug and low across the hips.
- NEVER allow children or small infants to ride in a passenger's lap.

(Continued)

(Continued)

- Do not route the seat belt across your neck, across sharp edges, or reroute the shoulder strap away from your body.
- Do not allow the seat belt to become caught or jammed.

### Front seats

The front seat can be adjusted by using the control switches located on the outside of the seat cushion. Before driving, adjust the seat to the proper position so that you can easily control the steering wheel, foot pedals and controls on the instrument panel.

#### WARNING

Take the following precautions when adjusting your seat:

- NEVER attempt to adjust the seat while the vehicle is moving. The seat could respond with unexpected movement and may cause loss of vehicle control resulting in an accident.
- Do not place anything under the front seats. Loose objects in the driver's foot area could interfere with the operation of the foot pedals, causing an accident.

(Continued)

(Continued)

- Do not allow anything to interfere with the normal position and proper locking of the seatback.
- Do not place a cigarette lighter on the floor or seat. When you operate the seat, gas may exit out of the lighter causing a fire.
- Use extreme caution when picking small objects trapped under the seats or between the seat and the center console. Your hands might be cut or injured by the sharp edges of the seat mechanism.
- If there are occupants in the rear seats, be careful while adjusting the front seat position.

### CAUTION

To prevent injury:

- Do not adjust your seat while wearing your seat belt. Moving the seat cushion forward may cause strong pressure on your abdomen.
- Do not allow your hands or fingers to get caught in the seat mechanisms while the seat is moving.

### *Manual adjustment*

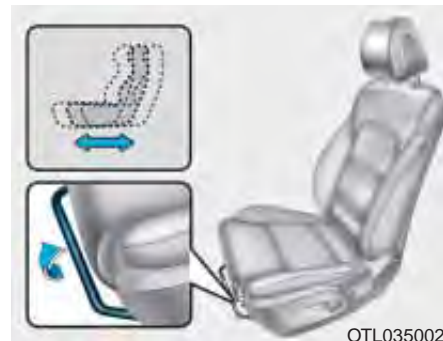

### **Forward and rearward adjustment**

To move the seat forward or rearward:

1. Pull up the seat slide adjustment lever and hold it.
2. Slide the seat to the position you desire.
3. Release the lever and make sure the seat is locked in place. Move forward and rearward without using the lever. If the seat moves, it is not locked properly.

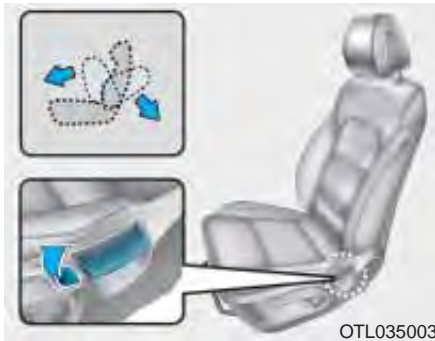

### Seatback angle

To recline the seatback:

1. Lean forward slightly and lift up the seatback lever.
2. Carefully lean back on the seat and adjust the seatback to the position you desire.
3. Release the knob and make sure the seatback is locked in place.

### Reclining seatback

Sitting in a reclined position when the vehicle is in motion can be dangerous. Even when buckled up, the protections of your restraint system (seat belts and/or air bags) is greatly reduced by reclining your seatback.

### **⚠ WARNING**

**NEVER** ride with a reclined seatback when the vehicle is moving.

Riding with a reclined seatback increases your chance of serious or fatal injuries in the event of a collision or sudden stop.

Drivers and passengers should **ALWAYS** sit well back in their seats, properly belted, and with the seatbacks upright.

Seat belts must be snug against your hips and chest to work properly. When the seatback is reclined, the shoulder belt cannot do its job because it will not be snug against your chest. Instead, it will be in front of you. During an accident, you could be thrown into the seat belt, causing neck or other injuries.

The more the seatback is reclined, the greater chance the passenger's hips will slide under the lap belt or the passenger's neck will strike the shoulder belt.

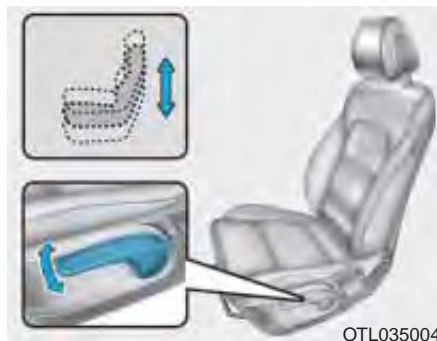

### Seat cushion height (for driver's seat)

To change the height of the seat cushion:

- Push down the lever several times, to lower the seat cushion.
- Pull up the lever several times, to raise the seat cushion.

### *Power adjustment*

The front seat can be adjusted by using the control switches located on the outside of the seat cushion. Before driving, adjust the seat to the proper position so that you can easily control the steering wheel, foot pedals and controls on the instrument panel.

### **⚠ WARNING**

**NEVER** allow children in the vehicle unattended. The power seats are operable when the engine is turned off.

## NOTICE

To prevent damage to the seats:

- Always stop adjusting the seats when the seat has been adjusted as far forward or rearward as possible.
- Do not adjust the seats longer than necessary when the engine is turned off. This may result in unnecessary battery drain.
- Do not operate two or more seats at the same time. This may result in an electrical malfunction.



### Forward and rearward adjustment

To move the seat forward or rearward:

1. Push the control switch forward or rearward.
2. Release the switch once the seat reaches the desired position.

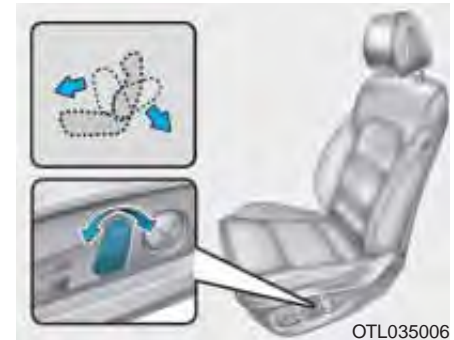

### Seatback angle

To recline the seatback:

1. Push the control switch forward or rearward.
2. Release the switch once the seatback reaches the desired position.

### Reclining seatback

Sitting in a reclined position when the vehicle is in motion can be dangerous. Even when buckled up, the protections of your restraint system (seat belts and air bags) is greatly reduced by reclining your seatback.

#### **⚠ WARNING**

**NEVER** ride with a reclined seatback when the vehicle is moving.

**Riding with a reclined seatback increases your chance of serious or fatal injuries in the event of a collision or sudden stop.**

**Driver and passengers should ALWAYS sit well back in their seats, properly belted, and with the seatbacks upright.**

Seat belts must be snug against your hips and chest to work properly. When the seatback is reclined, the shoulder belt cannot do its job because it will not be snug against your chest. Instead, it will be in front of you. During an accident, you could be thrown into the seat belt, causing neck or other injuries.

The more the seatback is reclined, the greater chance the passenger's hips will slide under the lap belt or the passenger's neck will strike the shoulder belt.



### Seat cushion height

To change the height of the seat cushion:

1. Push the front portion of the control switch up to raise or down to lower the front part of the seat cushion.

Push the rear portion of the control switch up to raise or down to lower the height of the seat cushion.

2. Release the switch once the seat reaches the desired position.

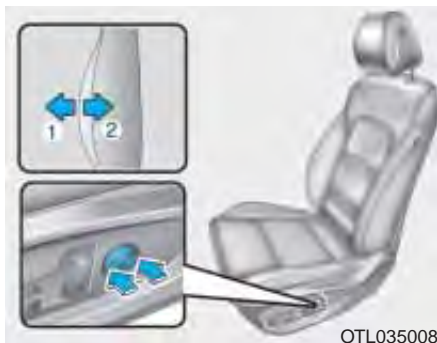

### Lumbar support (for driver's seat, if equipped)

- The lumbar support can be adjusted by pressing the lumbar support switch.
- Press the front portion of the switch (1) to increase support or the rear portion of the switch (2) to decrease support.

### Seatback pocket



The seatback pocket is provided on the back of the front seatbacks.

### CAUTION

Do not put heavy or sharp objects in the seatback pockets. In an accident they could come loose from the pocket and injure occupants.



### Rear seats

#### *Folding the rear seat*

The rear seatbacks can be folded to facilitate carrying long items or to increase the luggage capacity of the vehicle.

#### WARNING

- Never allow passengers to sit on top of the folded down seatback while the vehicle is moving. This is not a proper seating position and no seat belts are available for use. This could result in serious injury or death in case of an accident or sudden stop.
- Objects carried on the folded down seatback should not extend higher than the top of the front seatbacks. This could allow cargo to slide forward and cause injury or damage during sudden stops.

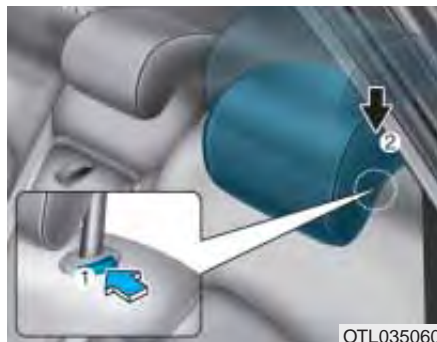

To fold down the rear seatback:

1. Set the front seatback to the upright position and if necessary, slide the front seat forward.
2. Lower the rear head restraints to the lowest position.

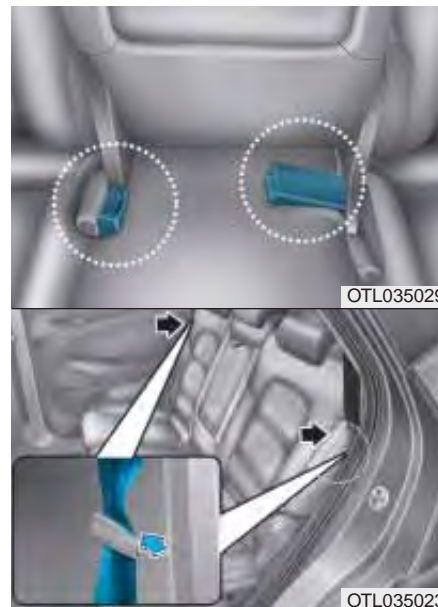

3. Insert the rear seat belt buckle in the pocket between the rear seatback and cushion, and insert the rear seat belt webbing in the guide to prevent the seat belt from being damaged.

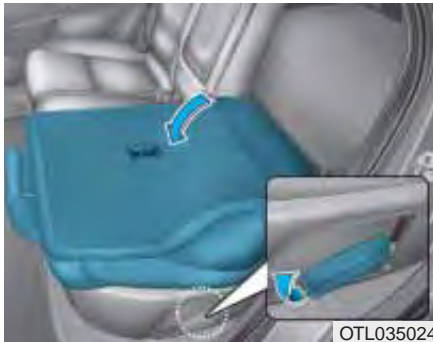

4. Lift up the front portion of the seatback folding lever, then fold the seat toward the front of the vehicle. When you return the seatback to its upright position, always be sure it has locked into position by pushing on the top of the seatback.

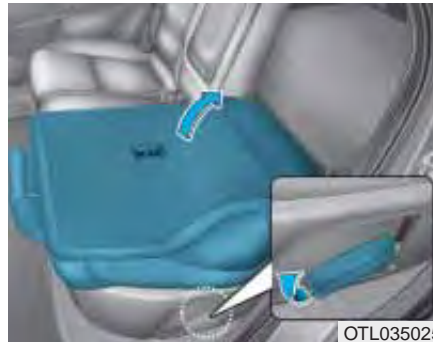

5. To use the rear seat, lift and push the seatback rearward by lifting up and pushing the front portion of the folding lever. Push the seatback firmly until it clicks into place. Make sure the seatback is locked in place.

### **⚠ WARNING**

When returning the rear seatback from a folded to an upright position, hold the seatback and return it slowly. Ensure that the seatback is completely locked into its upright position by pushing on the top of the seatback. In an accident or sudden stop, the unlocked seatback could allow cargo to move forward with great force and enter the passenger compartment, which could result in serious injury or death.

### **⚠ WARNING**

Do not place objects in the rear seats, since they cannot be properly secured and may hit vehicle occupants in a collision causing serious injury or death.

**⚠ WARNING**

Make sure the engine is off, the shift lever is in P (Park), and the parking brake is securely applied whenever loading or unloading cargo. Failure to take these steps may allow the vehicle to move if the shift lever is inadvertently moved to another position.

**Armrest**



The armrest is located in the center of the rear seat. Pull the armrest down from the seatback to use it.



**Cup holder**

To use the center cup holder, pull down the armrest.

## Headrest

The vehicle's front and rear seats have adjustable headrests. The headrests provide comfort for passengers, but more importantly they are designed to help protect passengers from whiplash and other neck and spinal injuries during an accident, especially in a rear impact collision.

### WARNING

To reduce the risk of serious injury or death in an accident, take the following precautions when adjusting your headrests:

- Always properly adjust the headrests for all passengers BEFORE starting the vehicle.
- NEVER let anyone ride in a seat with the headrest removed.

(Continued)

(Continued)



- Adjust the headrests so the middle of the headrests is at the same height as the height of the top of the eyes.
- NEVER adjust the headrest position of the driver's seat when the vehicle is in motion.
- Adjust the headrest as close to the passenger's head as possible. Do not use a seat cushion that holds the body away from the seatback.
- Make sure the headrest locks into position after adjusting it.

### NOTICE

To prevent damage, NEVER hit or pull on the headrests.

### CAUTION

When there is no occupant in the rear seats, adjust the height of the headrest to the lowest position. The rear seat headrest can reduce the visibility of the rear area.

### Front seat headrests

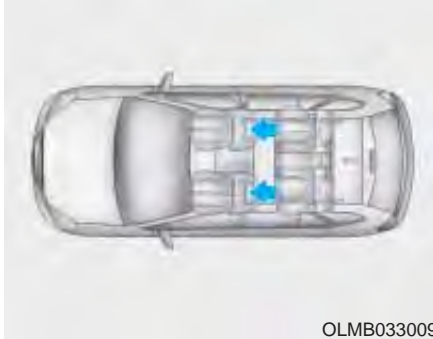

The driver's and front passenger's seats are equipped with adjustable headrests for the passengers safety and comfort.

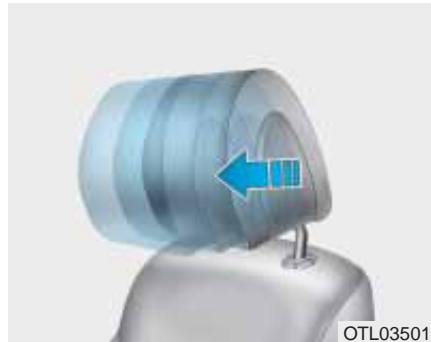

#### Forward and rearward adjustment

The headrest may be adjusted forward to 3 different positions by pulling the headrest forward to the desired detent. To adjust the headrest to its furthest rearwards position, pull it fully forward to the farthest position and release it.

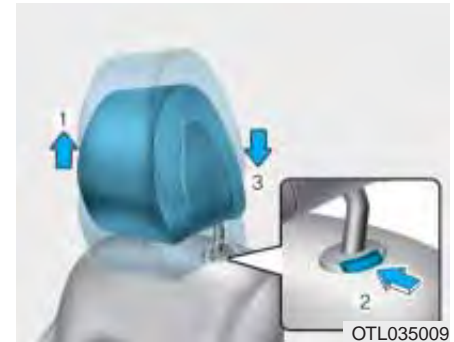

#### Adjusting the height up and down

To raise the headrest:

1. Pull it up to the desired position (1).

To lower the headrest:

1. Push and hold the release button (2) on the headrest support.
2. Lower the headrest to the desired position (3).



#### NOTICE

If you recline the seatback towards the front with the headrest and seat cushion raised, the headrest may come in contact with the sunvisor or other parts of the vehicle.

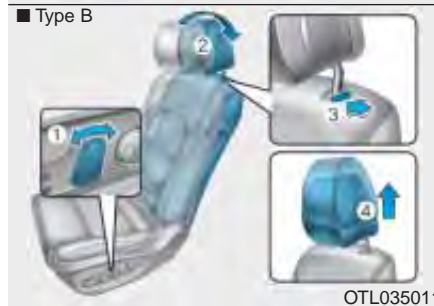
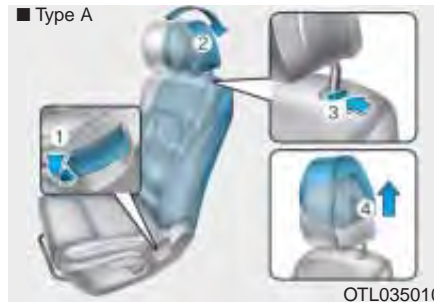

#### Removal/Reinstall

To remove the headrest:

1. Recline the seatback (2) with using the seatback angle lever or switch (1).
2. Raise headrest as far as it can go.
3. Press the headrest release button (3) while pulling the headrest up (4).

3. Press the headrest release button (3) while pulling the headrest up (4).

#### ⚠ WARNING

**NEVER** allow anyone to travel in a seat with the headrest removed.

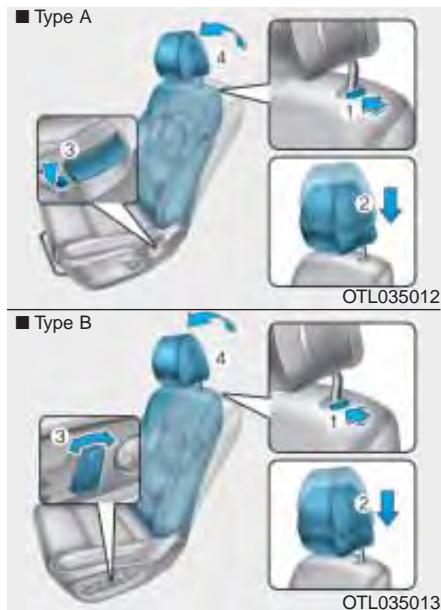

To reinstall the headrest :

1. Recline the seatback.
2. Put the headrest poles (2) into the holes while pressing the release button (1).
3. Adjust the headrest to the appropriate height.

4. Recline the seatback (4) with the seatback angle lever or switch (3).

### **⚠ WARNING**

Always make sure the headrest locks into position after reinstalling and adjusting it properly.

### **Rear seat headrests**

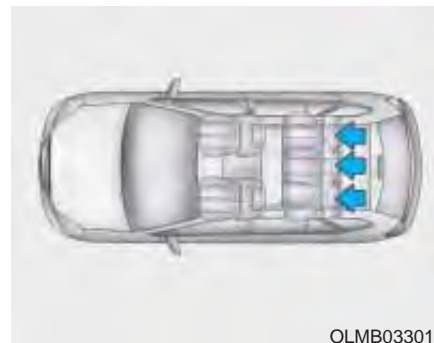

The rear seats are equipped with headrests in all the seating positions for the passenger's safety and comfort.



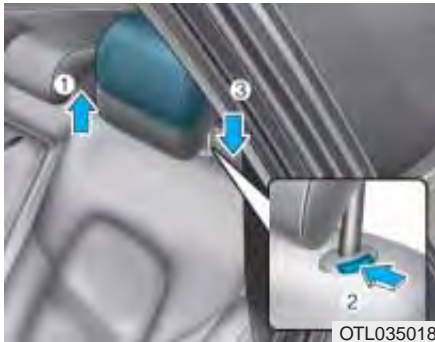

OTL035018

### Adjusting the height up and down

To raise the headrest:

1. Pull it up to the desired position (1).

To lower the headrest:

1. Push and hold the release button (2) on the headrest support.
2. Lower the headrest to the desired position (3).

## Seat warmers and air ventilation seats

### Front seat warmers (if equipped)

Seat warmers are provided to warm the seats during cold weather.

#### **⚠ WARNING**

The seat warmers can cause a **SERIOUS BURN**, even at low temperatures and especially if used for long periods of time.

Passengers must be able to feel if the seat is becoming too warm so they can turn it off, if needed.

People who cannot detect temperature change or pain to the skin should use extreme caution, especially the following types of passengers:

- Infants, children, elderly or disabled persons, or hospital outpatients.
- People with sensitive skin or who burn easily.

(Continued)

(Continued)

- Fatigued individuals.
- Intoxicated individuals.
- People taking medication that can cause drowsiness or sleepiness.

#### **⚠ WARNING**

**NEVER** place anything on the seat that insulates against heat when the seat warmer is in operation, such as a blanket or seat cushion. This may cause the seat warmer to overheat, causing a burn or damage to the seat.



### NOTICE

To prevent damage to the seat warmers and seats:

- Never use a solvent such as paint thinner, benzene, alcohol or gasoline to clean the seats.
- Do not place heavy or sharp objects on seats equipped with seat warmers.
- Do not change the seat cover. It may damage the seat warmer.

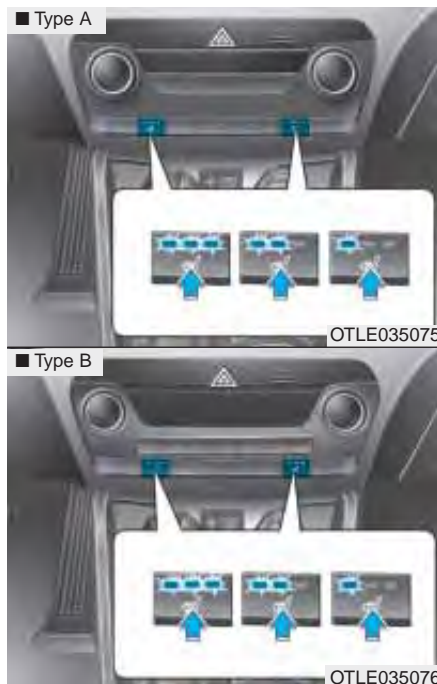

While the engine is running, push either of the switches to warm the driver's seat or front passenger's seat.

During mild weather or under conditions where the operation of the seat warmer is not needed, keep the switches in the OFF position.

- Each time you push the switch, the temperature setting of the seat is changed as follows :

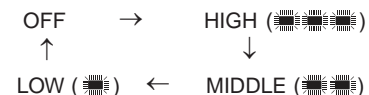

- When pressing the switch for more than 1.5 seconds with the seat warmer operating, the seat warmer will turn OFF.
- The seat warmer defaults to the OFF position whenever the ignition switch is placed to the ON position.

### **i** Information

**With the seat warmer switch in the ON position, the heating system in the seat turns off or on automatically depending on the seat temperature.**

### Front air ventilation seat (if equipped)

■ Type A



■ Type B



The air ventilation seats are provided to cool the front seats by blowing air through small vent holes on the surface of the seat cushions and seatbacks.

When the operation of the air ventilation seat is not needed, keep the switches in the OFF position.

While the engine is running, push the switch to cool the driver's seat or the front passenger's seat (if equipped).

- Each time you push the switch, the airflow changes as follows:

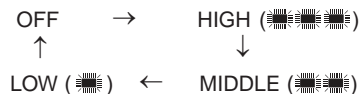

- When pressing the switch for more than 1.5 seconds with the air ventilation seat operating, the operation will turn OFF.
- The air ventilation seats defaults to the OFF position whenever the ignition switch is placed to the ON position.

#### NOTICE

To prevent damage to the air ventilation seat:

- Use the air ventilation seat **ONLY** when the climate control system is on. Using the air ventilation seat for prolonged periods of time with the climate control system off could cause the air ventilation seat to malfunction.
- Never use a solvent such as paint thinner, benzene, alcohol or gasoline to clean the seats.
- Avoid spilling liquids on the surface of the front seats and seatbacks; this may cause the air vent holes to become blocked and not work properly.
- Do not place materials such as plastic bags or newspapers under the seats. They may block the air intake causing the air vents to not work properly.

(Continued)

(Continued)

- Do not change the seat covers. It may damage the air ventilation seat.
- If the air vents do not operate, restart the vehicle. If there is no change, we recommend that you have your vehicle inspected by an authorized HYUNDAI dealer.

### Rear seat warmers (if equipped)



While the engine is running, push either of the switches to warm the rear seat.

During mild weather or under conditions where the operation of the seat warmer is not needed, keep the switches in the OFF position.

Each time you push the switch, the temperature setting of the seat is changed as follows :



The seat warmer defaults to the OFF position whenever the ignition switch is placed to the ON position.

### **i** Information

**With the seat warmer switch in the ON position, the heating system in the seat turns off or on automatically depending on the seat temperature.**

## SEAT BELTS

This section describes how to use the seat belts properly. It also describes some of the things not to do when using seat belts.

### Seat belt safety precautions

Always fasten your seat belt and make sure all passengers have fastened their seat belts before starting any trip. Air bags (if equipped) are designed to supplement the seat belt as an additional safety device, but they are not a substitute. Most countries require all occupants of a vehicle to wear seat belts.

#### WARNING

Seat belts must be used by ALL passengers whenever the vehicle is moving. Take the following precautions when adjusting and wearing seat belts:

- ALWAYS properly restrain children under age 13 in the rear seats.
- NEVER allow children to ride in the front passenger seat. If a child age 13 or older must be seated in the front seat, move the seat as far back as possible and properly restrain them in the seat.
- NEVER allow an infant or child to be carried on an occupant's lap.
- NEVER ride with the seatback reclined when the vehicle is moving.
- Do not allow children to share a seat or seat belt.

(Continued)

(Continued)

- Do not wear the shoulder belt under your arm or behind your back.
- Never wear a seat belt over fragile objects. If there is a sudden stop or impact, the seat belt can damage it.
- Do not use the seat belt if it is twisted. A twisted seat belt will not protect you properly in an accident.
- Do not use a seat belt if the webbing or hardware is damaged.
- Do not latch the seat belt into the buckles of other seats.
- NEVER unfasten the seat belt while driving. This may cause loss of vehicle control resulting in an accident.
- Make sure there is nothing in the buckle interfering with the seat belt latch mechanism. This may prevent the seat belt from fastening securely.

(Continued)

(Continued)

- No modifications or additions should be made by the user which will either prevent the seat belt adjusting devices from operating to remove slack, or prevent the seat belt assembly from being adjusted to remove slack.

### **⚠ WARNING**

Damaged seat belts and seat belt assemblies will not operate properly. Always replace:

- Frayed, contaminated, or damaged webbing.
- Damaged hardware.
- The entire seat belt assembly after it has been worn in an accident, even if damage to webbing or assembly is not apparent.

## Seat belt warning light

### Seat belt warning

■ For driver in instrument cluster

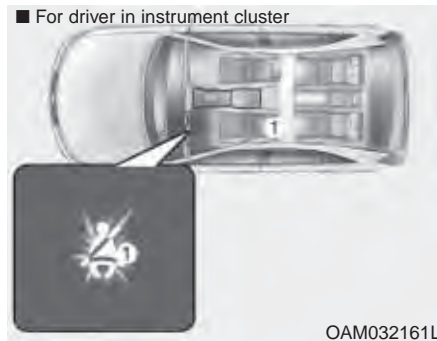

### Driver's seat belt warning

As a reminder to the driver, the seat belt warning light will illuminate for approximately 6 seconds each time you turn the ignition switch ON regardless of belt fastening.

If the driver's seat belt is unfastened after the ignition switch is ON, the seat belt warning light illuminates until the belt is fastened.

If you continue not to fasten the seat belt and you drive over 9km/h, the illuminated warning light will start to blink until you drive under 6km/h. (if equipped)

If you continue not to fasten the seat belt and you drive over 20km/h the seat belt warning chime will sound for approximately 100 seconds and the corresponding warning light will blink. (if equipped)

## Seat belt restraint system

### Lap/shoulder belt



#### To fasten your seat belt:

Pull it out of the retractor and insert the metal tab (1) into the buckle (2). There will be an audible "click" when the tab locks into the buckle.

The seat belt automatically adjusts to the proper length after the lap belt portion is adjusted manually so that it fits snugly around your hips. If you lean forward in a slow, easy motion, the belt will extend and move with you. If there is a sudden stop or impact, the belt will lock into position. It will also lock if you try to lean forward too quickly.

#### NOTICE

If you are not able to smoothly pull enough of the seat belt out from the retractor, firmly pull the seat belt out and release it. After release, you will be able to pull the belt out smoothly.



#### ⚠ WARNING

Improperly positioned seat belts may increase the risk of serious injury in an accident. Take the following precautions when adjusting the seat belt:

- Position the lap portion of the seat belt as low as possible across your hips, not on your waist, so that it fits snugly. This allows your strong pelvic bones to absorb the force of the crash, reducing the chance of internal injuries.

(Continued)

### Rear center seatbelt



#### To fasten your seatbelt:

1. Extract the tongue plate (A) from the hole on the belt assembly cover.



2. Insert the tongue plate (A) into the buckle (A') until an audible "click" is heard, indicating the latch is locked. Make sure the belt is not twisted.

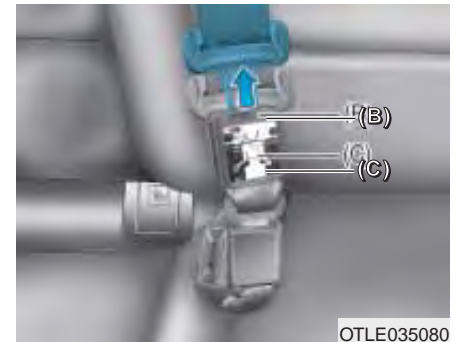

3. Pull out the tongue plate (B) from the pocket (C).





4. Insert the tongue plate (A) into the hole on the belt assembly cover.



**Lap belt (2-point rear center seat belt) (if equipped)**

To fasten the rear center seat belt: Insert the metal tab into the buckle. There will be an audible "click" when the tab locks into the buckle. Make sure the belt is properly locked and that the belt is not twisted.

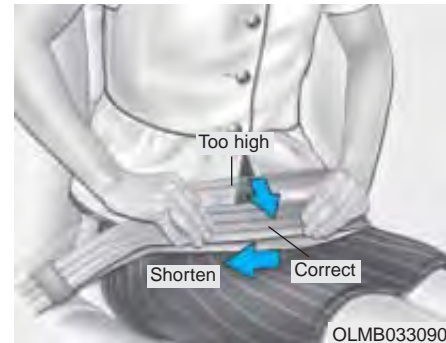

The length must be adjusted manually so it fits snugly around your hip. Fasten the belt and pull the loose end to tighten the belt.

The belt should be placed as low as possible on your hips, not on your waist. If the belt is too high, it could increase the possibility of injury in an accident.



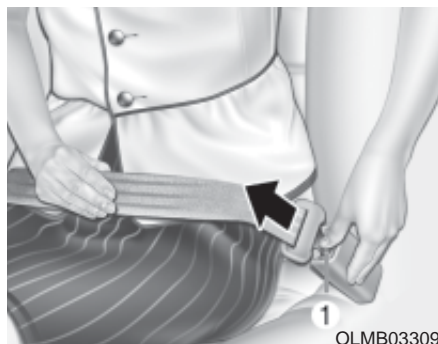

To release the rear center seat belt: Press the release button (1) on the buckle and remove the metal tab from the buckle.

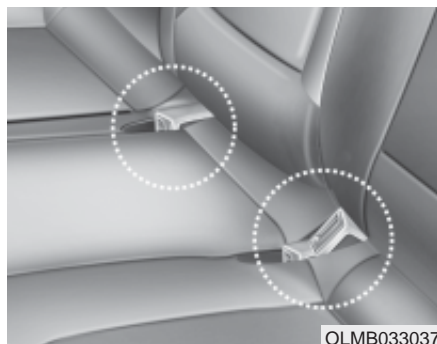

#### Stowing the rear seat belt

The rear seat belt buckles can be stowed in the pocket between the rear seatback and cushion when not in use.

#### *Pre-tensioner seat belt (Driver and front passenger)*



Your vehicle is equipped with driver's and front passenger's Pre-tensioner Seat Belts. The purpose of the pre-tensioner is to make sure the seat belts fit tightly against the occupant's body in certain frontal collisions. The pre-tensioner seat belts may be activated in crashes where the frontal collision is severe enough, together with the air bags.

When the vehicle stops suddenly, or if the occupant tries to lean forward too quickly, the seat belt retractor will lock into position. In certain frontal collisions, the pre-tensioner will activate and pull the seat belt into tighter contact against the occupant's body.

#### Retractor Pretensioner

The purpose of the retractor pretensioner is to make sure that the shoulder belts fit in tightly against the occupant's upper body in certain frontal collisions.

If the system senses excessive tension on the driver or passenger's seat belt when the pre-tensioner system activates, the load limiter inside the retractor pre-tensioner will release some of the pressure on the affected seat belt.

#### WARNING

- Always wear your seat belt and sit properly in your seat.
- Do not use the seat belt if it is loose or twisted. A loose or twisted seat belt will not protect you properly in an accident.
- Do not place anything near the buckle. This may adversely affect the buckle and cause it to function improperly.
- Always replace your pre-tensioners after activation or an accident.
- NEVER inspect, service, repair or replace the pre-tensioners yourself. This must be done by an authorized HYUNDAI dealer.
- Do not hit the seat belt assemblies.

#### WARNING

Do not touch the pre-tensioner seat belt assemblies for several minutes after they have been activated. When the pre-tensioner seat belt mechanism deploys during a collision, the pre-tensioner can become hot and can burn you.

#### CAUTION

Body work on the front area of the vehicle may damage the pre-tensioner seat belt system. Therefore, we recommend that the system be serviced by an authorized HYUNDAI dealer.

## Additional seat belt safety precautions

### Seat belt use during pregnancy

The seat belt should always be used during pregnancy. The best way to protect your unborn child is to protect yourself by always wearing the seat belt.

Pregnant women should always wear a lap-shoulder seat belt. Place the shoulder belt across your chest, routed between your breasts and away from your neck. Place the lap belt below your belly so that it fits **SNUGLY** across your hips and pelvic bone, under the rounded part of the belly.

#### WARNING

**To reduce the risk of serious injury or death to an unborn child during an accident, pregnant women should NEVER place the lap portion of the seat belt above or over the area of the abdomen where the unborn child is located.**

### Seat belt use and children

#### Infant and small children

Most countries have Child Restraint System laws which require children to travel in approved Child Restraint System devices, including booster seats. The age at which seat belts can be used instead of Child Restraint System differs among countries, so you should be aware of the specific requirements in your country, and where you are travelling. Infant and Child Restraint System must be properly placed and installed in a rear seat. For more information refer to the “Child Restraint Systems” in this chapter.

#### WARNING

**ALWAYS properly restrain infants and small children in a Child Restraint System appropriate for the child’s height and weight.**

**To reduce the risk of serious injury or death to a child and other passengers, NEVER hold a child in your lap or arms when the vehicle is moving. The violent forces created during an accident will tear the child from your arms and throw the child against the interior of the vehicle.**

Small children are best protected from injury in an accident when properly restrained in the rear seat by a Child Restraint System that meets the requirements of the Safety Standards of your country. Before buying any Child Restraint System, make sure that it has a label certifying that it meets Safety Standard of your country. The restraint must be appropriate for your child’s height and weight. Check the label on the Child Restraint System for this information. Refer to “Child Restraint Systems” in this chapter.

## WARNING

- **NEVER ride with a reclined seatback when the vehicle is moving.**
- **Riding with a reclined seatback increases your chance of serious or fatal injuries in the event of a collision or sudden stop.**
- **Driver and passengers should always sit well back in their seats, properly belted, and with the seatbacks upright.**

### Care of seat belts

Seat belt systems should never be disassembled or modified. In addition, care should be taken to assure that seat belts and belt hardware are not damaged by seat hinges, doors or other abuse.

#### *Periodic inspection*

All seat belts should be inspected periodically for wear or damage of any kind. Any damaged parts should be replaced as soon as possible.

#### *Keep belts clean and dry*

Seat belts should be kept clean and dry. If belts become dirty, they can be cleaned by using a mild soap solution and warm water. Bleach, dye, strong detergents or abrasives should not be used because they may damage and weaken the fabric.

### *When to replace seat belts*

The entire seat belt assembly or assemblies should be replaced if the vehicle has been involved in an accident. This should be done even if no damage is visible. We recommend that you consult an authorized HYUNDAI dealer.

## CHILD RESTRAINT SYSTEM (CRS)

### Children always in the rear

#### WARNING

**Always properly restrain children in the rear seats of the vehicle, unless the air bag on the front passenger seat is deactivated.**

**Children of all ages are safer when restrained in the rear seat. A child riding in the front passenger seat can be forcefully struck by an inflating air bag resulting in SERIOUS INJURY or DEATH.**

Children under age 13 must always ride in the rear seats and must always be properly restrained to minimize the risk of injury in an accident, sudden stop or sudden maneuver. According to accident statistics, children are safer when properly restrained in the rear seats than in the front seat. Children too large for a Child Restraint System must use the seat belts provided.

Most countries have Child Restraint Systems which require children to travel in approved Child Restraint Systems. The laws governing the age or height/weight restrictions at which seat belts can be used instead of Child Restraint System differs among countries, so you should be aware of the specific requirements in your country, and where you are travelling.

Child Restraint Systems must be properly placed and installed in the rear seat. You must use a commercially available Child Restraint System that meets the requirements of the Safety Standards of your country.

Child Restraint Systems are generally designed to be secured in a vehicle seat by lap belt or the lap belt portion of a lap/shoulder belt, or by a top-tether and/or ISOFIX anchorage in the rear seats of the vehicle.

### *Child Restraint System (CRS) always in the rear*

Infants and younger children must be restrained in an appropriate rearward-facing or forward-facing CRS that has first been properly secured to the rear seat of the vehicle. Read and comply with the instructions for installation and use provided by the manufacturer of the Child Restraint System.

#### WARNING

- **Always follow the Child Restraint System manufacturer's instructions for installation and use.**
- **Always properly restrain your child in the Child Restraint System.**
- **Do not use an infant carrier or a child safety seat that "hooks" over a seatback, it may not provide adequate protection in an accident.**
- **After an accident, we recommend a HYUNDAI dealer check the Child Restraint System, seat belts, ISOFIX anchorages and top-tether anchorages.**

## Selecting a Child Restraint System (CRS)

When selecting a CRS for your child, always:

- Make sure the CRS has a label certifying that it meets applicable Safety Standards of your country.
- Select a Child Restraint System based on your child's height and weight. The required label or the instructions for use typically provide this information.
- Select a Child Restraint System that fits the vehicle seating position where it will be used.
- Read and comply with the warnings and instructions for installation and use provided with the Child Restraint System.

### *Child Restraint System types*

There are three main types of Child Restraint Systems: rearward-facing seats, forward-facing seats, and booster seats. They are classified according to the child's age, height and weight.



### **Rearward-facing Child Restraint System**

A rearward-facing Child Restraint System provides restraint with the seating surface against the back of the child. The harness system holds the child in place, and in an accident, acts to keep the child positioned in the Child Restraint Systems and reduce the stress to the fragile neck and spinal cord.

All children under the age of one year must always ride in a rearward-facing Child Restraint System. There are different types of rearward-facing Child Restraint Systems: infant-only Child Restraint Systems can only be used rearward-facing. Convertible and 3-in-1 Child Restraint Systems typically have higher height and weight limits for the rearward-facing position, allowing you to keep your child rearward-facing for a longer period of time.

Keep using Child Restraint Systems in the rearward-facing position as long as children fit within the height and weight limits allowed by the Child Restraint System's manufacturer.



### Forward-facing Child Restraint System

A forward-facing Child Restraint System provides restraint for the child's body with a harness. Keep children in a forward-facing Child Restraint System with a harness until they reach the top height or weight limit allowed by your Child Restraint System's manufacturer.

Once your child outgrows the forward-facing Child Restraint System, your child is ready for a booster seat.

### Booster seats

A booster seat is Child Restraint System designed to improve the fit of the vehicle's seat belt system. A booster seat positions the seat belt so that it fits properly over the stronger parts of your child's body. Keep your children in booster seats until they are big enough to fit in a seat belt properly.

For a seat belt to fit properly, the lap belt must lie comfortable across the upper thighs, not the stomach. The shoulder belt should lie comfortable across the shoulder and chest and not across the neck or face. Children under age 13 must always be properly restrained to minimize the risk of injury in an accident, sudden stop or sudden maneuver.



## Installing a Child Restraint System (CRS)

### WARNING

Before installing your Child Restraint System always:

Read and follow the instructions provided by the manufacturer of the Child Restraint System.

Failure to follow all warnings and instructions could increase the risk of the **SERIOUS INJURY** or **DEATH** if an accident occurs.

### WARNING

If the vehicle headrest prevents proper installation of a Child Restraint System, the headrest of the respective seating position shall be readjusted or entirely removed.

After selecting a proper Child Restraint System and checking that the Child Restraint System fits properly in the rear of this vehicle, you are ready to install the Child Restraint System according to the manufacturer's instruction. There are three general steps in installing the Child Restraint Systems properly:

- **Properly secure the Child Restraint System to the vehicle.** All Child Restraint System must be secured to the vehicle with the lap belt or lap part of a lap/shoulder belt or with the ISOFIX top-tether and/or ISOFIX anchorage.
- **Make sure the Child Restraint System is firmly secured.** After installing a Child Restraint System to the vehicle, push and pull the seat forward and from side-to-side to verify that it is securely attached to the seat. A Child Restraint System secured with a seat belt should be installed as firmly as possible. However, some side-to-side movement can be expected.

When installing a Child Restraint System, adjust the vehicle seat (up and down, forward and rearward) so that your child fits in the Child Restraint System in a comfortable manner.

- **Secure the child in the Child Restraint System.** Make sure the child is properly strapped in the Child Restraint System according to the Child Restraint System manufacturer's instructions.

### CAUTION

A Child Restraint System in a closed vehicle can become very hot. To prevent burns, check the seating surface and buckles before placing your child in the Child Restraint System.



### ***ISOFIX anchorage and top-tether anchorage (ISOFIX anchorages system) for children***

The ISOFIX system holds a Child Restraint System during driving and in an accident. This system is designed to make installation of the Child Restraint System easier and reduce the possibility of improperly installing your Child Restraint System. The ISOFIX system uses anchors in the vehicle and attachments on the Child Restraint System. The ISOFIX system eliminates the need to use seat belts to secure the Child Restraint System to the rear seats.

ISOFIX anchorages are metal bars built into the vehicle. There are two lower anchors for each ISOFIX seating position that will accommodate a Child Restraint System with lower attachments.

To use the ISOFIX system in your vehicle, you must have a Child Restraint System with ISOFIX attachments. (An ISOFIX Child Restraint System may only be installed if it has vehicle-specific or universal approval in accordance with the requirements of ECE-R44 or ECE-R129.)

The Child Restraint System manufacturer will provide you with instructions on how to use the Child Restraint System with its attachments for the ISOFIX anchorages.

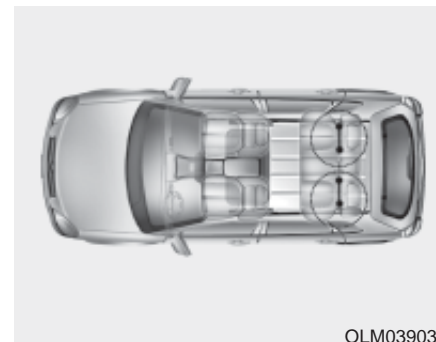

OLM039035

ISOFIX anchorages have been provided in the left and right outboard rear seating positions. Their locations are shown in the illustration. There are no ISOFIX anchorages provided for the center rear seating position.

## ⚠ WARNING

Do not attempt to install a Child Restraint System using ISOFIX anchorages in the rear center seating position. There are no ISOFIX anchorages provided for this seat. Using the outboard seat anchorages, for the CRS installation on the rear center seating position, can damage the anchorages.

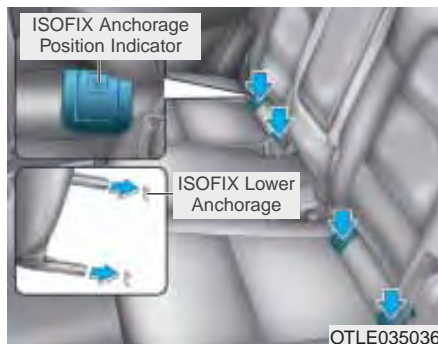

The ISOFIX anchorages symbols are located on the left and right rear seat cushions to identify the position of the ISOFIX anchorages in your vehicle (see arrows in illustration).

Both rear outboard seats are equipped with a pair of ISOFIX anchorages as well as a corresponding top-tether anchorage on the back side of the rear seats.

(Child Restraint Systems with universal approval according to ECE-R44 or ECE-R129 need to be fixed additionally with a top-tether connected to the back side of the rear seats.)

ISOFIX anchorages are located between the seatback and the seat cushion of the rear seat left and right outboard seating positions.

To use the ISOFIX anchorages, push the upper portion of the ISOFIX anchorage cover.

### ***Securing a Child Restraint System with the "ISOFIX Anchorage System"***

To install a ISOFIX-compatible Child Restraint System in either of the rear outboard seating positions:

1. Move the seat belt buckle away from the ISOFIX anchorages.
2. Move any other objects away from the anchors that could prevent a secure connection between the Child Restraint System and the ISOFIX anchorages.
3. Place the Child Restraint System on the vehicle seat, then attach the seat to the ISOFIX anchorages according to the instructions provided by the Child Restraint System manufacturer.
4. Follow the instructions of the Child Restraint System's manufacturer for proper installation and connection of the ISOFIX attachments on the Child Restraint System to the ISOFIX anchorages.

### **⚠ WARNING**

**Take the following precautions when using the ISOFIX system:**

- Read and follow all installation instructions provided with your Child Restraint System.
- To prevent the child from reaching and taking hold of unretracted seat belts, buckle all unused rear seat belts and retract the seat belt webbing behind the child. Children can be strangled if a shoulder belt becomes wrapped around their neck and the seat belt tightens.
- **NEVER** attach more than one Child Restraint System to a single anchorage. This could cause the anchor or attachment to come loose or break.

**(Continued)**

**(Continued)**

- Always have the ISOFIX system inspected by your dealer after an accident. An accident can damage the ISOFIX system and may not properly secure the Child Restraint System.

### Securing a Child Restraint System seat with "Top-tether Anchorage" system



Child Restraint hook holders are located on the rear of the seatbacks.

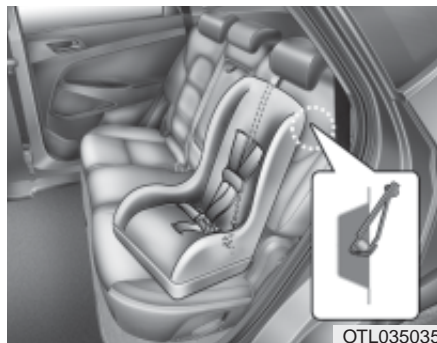

1. Route the Child Restraint System seat strap over the seatback.

For vehicles with adjustable headrest, route the tether strap under the headrest and between the headrest posts, otherwise route the tether strap over the top of the seatback.

2. Connect the top-tether to the top-tether anchorage, then tighten the top-tether according to the instructions of your Child Restraint System's manufacturer to firmly attach the Child Restraint System to the seat.

### WARNING

Take the following precautions when installing the top-tether:

- Read and follow all installation instructions provided with your Child Restraint System.
- **NEVER** attach more than one Child Restraint System to a single ISOFIX top-tether anchorage. This could cause the anchorage or attachment to come loose or break.
- Do not attach the top-tether to anything other than the correct top-tether anchorage. It may not work properly if attached to something else.
- Child Restraint anchorages are designed to withstand only those loads imposed by correctly fitted Child Restraint System.

Under no circumstances are they to be used for adult seat belts or harnesses or for attaching other items or equipment to the vehicle.

### Child Seat Restraint for Vehicle ISOFIX Positions

Suitability of each seating position for ISOFIX Child Restraint Systems according to ECE regulations.

Mass Group	Size Class	Fixture	Vehicle ISOFIX Positions			
			1st	2nd row		
			Passenger	Left Hand	Center	Right Hand
Carrycot	F	ISO/L1	N/A	X	N/A	X
	G	ISO/L2	N/A	X	N/A	X
0 : UP to 10kg	E	ISO/R1	N/A	IL	N/A	IL
0+ : UP to 13kg	E	ISO/R1	N/A	IL	N/A	IL
	D	ISO/R2	N/A	IL	N/A	IL
	C	ISO/R3	N/A	IL	N/A	IL
1 : 9 to 18kg	D	ISO/R2	N/A	IL	N/A	IL
	C	ISO/R3	N/A	IL	N/A	IL
	B	ISO/F2	N/A	IUF, IL	N/A	IUF, IL
	B1	ISO/F2X	N/A	IUF, IL	N/A	IUF, IL
	A	ISO/F3	N/A	IUF, IL	N/A	IUF, IL

IUF = suitable for ISOFIX forward child restraints systems of universal category approved for use in the mass group.

IL = suitable for particular ISOFIX child restraints systems (CRS) given in the attached list. These ISOFIX CRS are those of the "specific vehicle", "restricted" or "semi-universal" categories.

X = ISOFIX position not suitable for ISOFIX child restraint system in this mass group and/or this size class.

\* Both ISO/R2 and ISO/R3 are able to be set up only at the foremost position of the passenger seat.

\* ISOFIX Child Restraint System size classes and fixtures

A - ISO/F3: Full-Height Forward-Facing toddler CRS (height 720mm)

B - ISO/F2: Reduced-Height Forward-Facing toddler CRS (height 650mm)

B1 - ISO/F2X: Reduced-Height Second Version Back Surface Shape Forward-Facing toddler CRS (height 650mm)

C - ISO/R3: Full-Size Rearward-Facing toddler CRS

D - ISO/R2: Reduced-Size Rearward-Facing toddler CRS

E - ISO/R1: Infant-Size Rearward-Facing CRS

F - ISO/L1: Left Lateral Facing position CRS (carry-cot)

G - ISO/L2: Right Lateral Facing position CRS (carry-cot)

### ***Securing a Child Restraint System with a lap/shoulder belt***

When not using the ISOFIX system, all Child Restraint Systems must be secured to a rear seat with the lap part of a lap/shoulder belt.

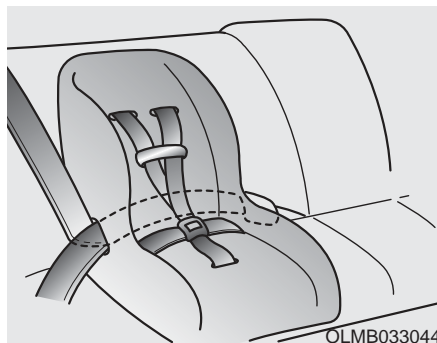

### **Installing a Child Restraint System with a lap/shoulder belt**

To install a Child Restraint System on the rear seats, do the following:

1. Place the Child Restraint System on a rear seat and route the lap/shoulder belt around or through the restraint, following the restraint manufacturer's instructions.

Make sure the seat belt webbing is not twisted.

### ***i* Information**

When using the rear center seat belt, you should also refer to the “3-point Rear Center Seat Belt” in this chapter.



2. Fasten the lap/shoulder belt latch into the buckle. Listen for the distinct “click” sound.

### **i** Information

**Position the release button so that it is easy to access in case of an emergency.**



3. Remove as much slack from the belt as possible by pushing down on the Child Restraint System while feeding the shoulder belt back into the retractor.
4. Push and pull on the Child Restraint System to confirm that the seat belt is holding it firmly in place.

If your CRS manufacturer instructs or recommends you use a ISOFIX top-tether anchorage with the lap/shoulder belt, see page 2-45.

To remove the Child Restraint System, press the release button on the buckle and then pull the lap/shoulder belt out of the restraint and allow the seat belt to retract fully.

### **Child Seat Restraint Suitability for Seat Position using the Seat Belt**

Use child safety seats that have been officially approved and are appropriate for your children. When using the child safety seats, refer to the following table.

Age group	Seating position - 2nd Row			
	Co Driver	Outboard Left	Outboard Right	Rear center
0 : Up to 10 kg	U	U	U	U
0+ : Up to 13 kg	U	U	U	U
I : 9 kg to 18 kg	U	U	U	U
II : 15 kg to 25 kg	U	U	U	U
III : 22 kg to 36 kg	U	U	U	U
<b>Note:</b>	UF Shall not be used for Mass Group 0 & 0+.			

U : Suitable for "universal" category restraints approved for use in this mass group.

**Remarks:-** Co driver seat: Front - 19°, Rear (Outboard & Centre) - 23°, Rearmost position. Seatbelt shoulder anchorage to lowest position.



## AIR BAG – SUPPLEMENTAL RESTRAINT SYSTEM

■ Left-hand drive

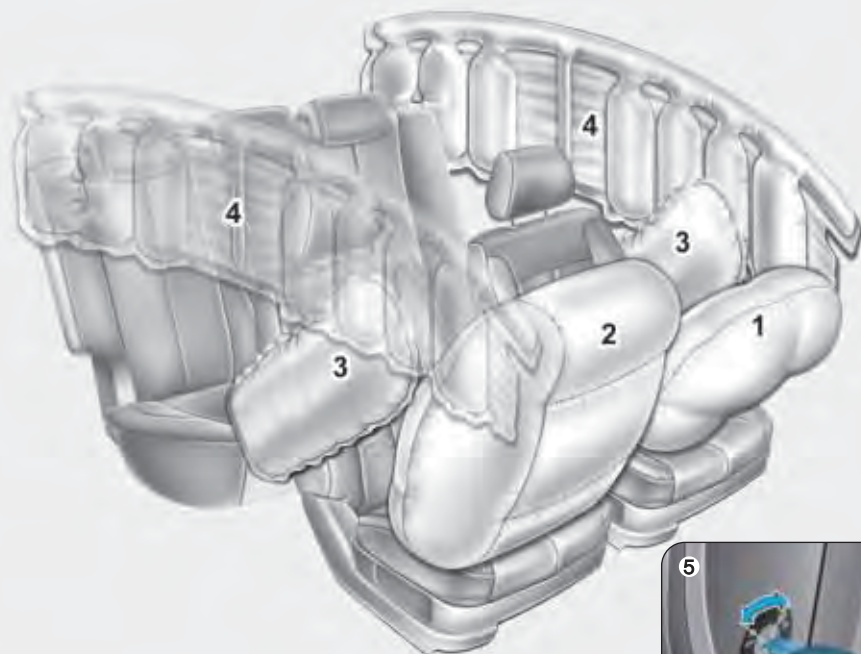

1. Driver's front air bag\*
  2. Passenger's front air bag\*
  3. Side air bag\*
  4. Curtain air bag\*
  5. Front passenger air bag ON/OFF switch\*
- \* : if equipped

The actual air bags in the vehicle may differ from the illustration.

OTL035037/OTLE035081

## ■ Right-hand drive

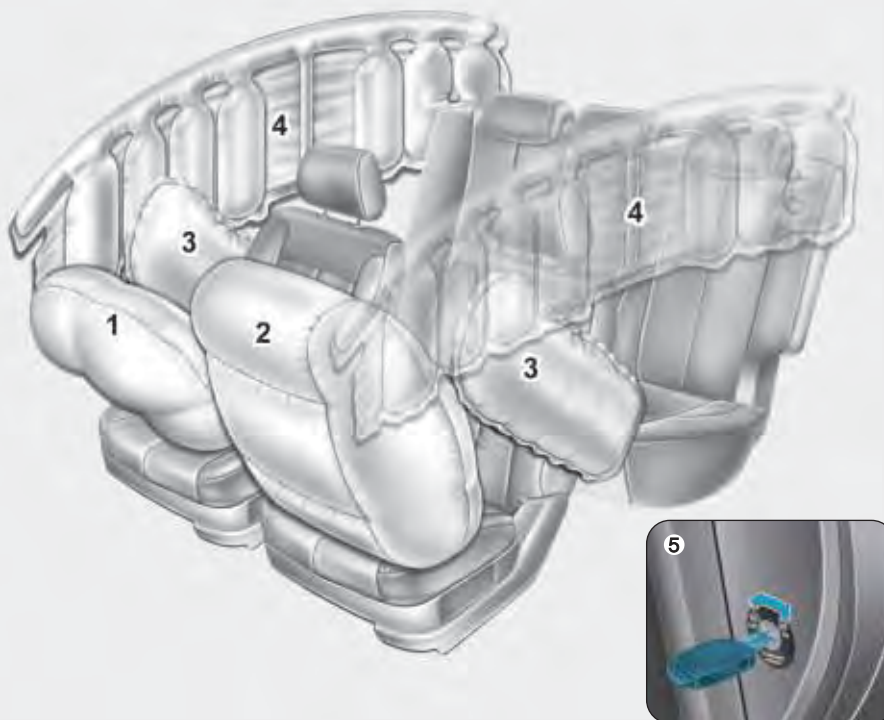

1. Driver's front air bag\*
  2. Passenger's front air bag\*
  3. Side air bag\*
  4. Curtain air bag\*
  5. Front passenger air bag ON/OFF switch\*
- \* : if equipped

The actual air bags in the vehicle may differ from the illustration.

OTL035037R/OTL035077R

The vehicles are equipped with a Supplemental Air Bag System for the driver's seat and front passenger's seats.

The front air bags are designed to supplement the three-point seat belts. For these air bags to provide protection, the seat belts must be worn at all times when driving.

You can be severely injured or killed in an accident if you are not wearing a seat belt. Air bags are designed to supplement seat belts, but do not replace them. Also, air bags are not designed to deploy in every collision. In some accidents, the seat belts are the only restraint protecting you.

### **WARNING**

#### **AIR BAG SAFETY PRECAUTIONS**

**ALWAYS** use seat belts and Child Restraint System - every trip, every time, everyone! Even with air bags, you can be seriously injured or killed in a collision if you are improperly belted or not wearing your seat belt when the air bag inflates.

**NEVER** place a child in any Child Restraint System or booster seat in the front passenger seat. An inflating air bag could forcefully strike the infant or child causing serious or fatal injuries.

**ABC - Always Buckle Children** under age 13 in the back seat. It is the safest place for children of any age to ride. If a child age 13 or older must be seated in the front seat, he or she must be properly belted and the seat should be moved as far back as possible.

All occupants should sit upright with the seatback in an upright position, centered on the seat cushion with their seat belt on, legs comfortably extended and their feet on the floor until the vehicle is parked and the engine is turned off. If an occupant is out of position during an accident, the rapidly deploying air bag may forcefully contact the occupant causing serious or fatal injuries.

You and your passengers should never sit or lean unnecessarily close to the air bags or lean against the door or center console.

Move your seat as far back as possible from front air bags, while still maintaining control of the vehicle.

## Where are the air bags?

### Driver's and passenger's front air bags (if equipped)

- Driver's front air bag
- Left-hand drive



- Right-hand drive



- Passenger's front air bag
- Left-hand drive



- Right-hand drive

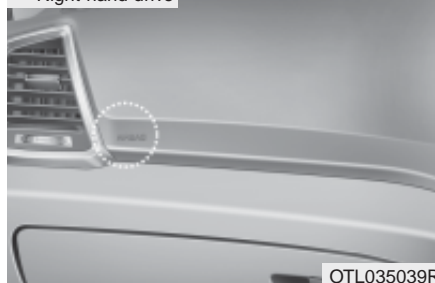

Your vehicle is equipped with a Supplemental Restraint System (SRS) and lap/shoulder belts at both the driver and passenger seating positions.

The SRS consists of air bags which are located in the center of the steering wheel and the passenger's side front panel pad above the glove box.

The air bags are labeled with the letters "AIR BAG" embossed on the pad covers.

The purpose of the SRS is to provide the vehicle's driver and front passengers with additional protection than that offered by the seat belt system alone in case of a frontal impact of sufficient severity.

### WARNING

To reduce the risk of serious injury or death from an inflating front air bags, take the following precautions:

- Seat belts must be worn at all times to help keep occupants positioned properly.
- Move your seat as far back as possible from front air bags, while still maintaining control of the vehicle.

(Continued)

(Continued)

- Never lean against the door or center console.
- Do not allow the front passenger to place their feet or legs on the dashboard.
- No objects (such as crash pad cover, cellular phone holder, cup holder, perfume or stickers) should be placed over or near the air bag modules on the steering wheel, instrument panel, windshield glass, and the front passenger's panel above the glove box. Such objects could cause harm if the vehicle is in a crash severe enough to cause the air bags to deploy.



### Passenger's front air bag ON/OFF switch (if equipped)

The purpose of the switch is to disable the passenger's front air bag in order to transport occupants who are at increased risk for air bag-related injury due to age, size, or medical condition.



To deactivate the passenger's front air bag:

Insert the key or a similar rigid device into the passenger's front air bag ON/OFF switch and turn it to the OFF position. The passenger air bag OFF indicator (⚠️) will illuminate and stay on until the passenger's front air bag is reactivated.



To reactivate the passenger's front air bag:

Insert the key or a similar rigid device into the passenger's front air bag ON/OFF switch and turn it to the ON position. The passenger air bag ON indicator (⊗) will illuminate and stay on for 60 seconds.

### **i** Information

The passenger's front air bag ON/OFF indicator illuminates for about 4 seconds after the ignition switch is placed in the ON position.

### **⚠** WARNING

Never allow an adult passenger to ride in the front passenger seat when the passenger air bag OFF indicator is illuminated. During a collision, the air bag will not inflate if the indicator is illuminated. Turn on the passenger's front air bag or have your passenger move to the rear seat.

### **⚠** WARNING

If the passenger's front air bag ON/OFF switch malfunctions, the following conditions may occur:

- The air bag warning light (⚠) on the instrument panel will illuminate.
- The passenger air bag OFF indicator (⊗) will not illuminate and the ON indicator (⊗) will come on and go off after approximately 60 seconds. The passenger's front air bag will inflate in a frontal impact even though the passenger's front air bag ON/OFF switch is set to the OFF position.
- We recommend that an authorized HYUNDAI dealer inspect the passenger's front air bag ON/OFF switch and the SRS air bag system as soon as possible.



### Side air bags (if equipped)



OTL035040



OTL035041

Your vehicle is equipped with a side air bag in each front seat. The purpose of the air bag is to provide the vehicle's driver and the front passenger with additional protection than that offered by the seat belt alone.

The side air bags are designed to deploy only during certain side impact collisions, depending on the crash severity, angle, speed and point of impact.

The side air bags are not designed to deploy in all side impact situations.

#### **WARNING**

To reduce the risk of serious injury or death from an inflating side air bag, take the following precautions:

- Seat belts must be worn at all times to help keep occupants positioned properly.
- Do not allow passengers to lean their heads or bodies onto doors, put their arms on the doors, stretch their arms out of the window, or place objects between the doors and seats.
- Hold the steering wheel at the 9 o'clock and 3 o'clock positions, to minimize the risk of injuries to your hands and arms.

(Continued)

(Continued)

- Do not use any accessory seat covers. This could reduce or prevent the effectiveness of the system.
- Do not place any objects over the air bag or between the air bag and yourself. Also, do not attach any objects around the area the air bag inflates such as the door, side door glass, front and rear pillar.
- Do not place any objects between the door and the seat. They may become dangerous projectiles if the side air bag inflates.
- Do not install any accessories on the side or near the side air bags.
- Do not put any objects between the side air bag label and seat cushion. It could cause harm if the vehicle is in a crash severe enough to cause the air bags to deploy.

(Continued)

(Continued)

- Do not cause impact to the doors when the ignition switch is in the ON position or this may cause the side air bags to inflate.
- If the seat or seat cover is damaged, we recommend that the system be serviced by an authorized HYUNDAI dealer.

### *Curtain air bags (if equipped)*



OTL035042



OTL035043

Curtain air bags are located along both sides of the roof rails above the front and rear doors.

They are designed to help protect the heads of the front seat occupants and the rear outboard seat occupants in certain side impact collisions.

The curtain air bags are designed to deploy only during certain side impact collisions, depending on the crash severity, angle, speed and impact.

The curtain air bags are not designed to deploy in all side impact situations.

### **⚠ WARNING**

To reduce the risk of serious injury or death from an inflating curtain air bags, take the following precautions:

- All seat occupants must wear seat belts at all times to help keep occupants positioned properly.
- Properly secure Child Restraint System as far away from the door as possible.
- Do not place any objects over the air bag. Also, do not attach any objects around the area the air bag inflates such as the door, side door glass, front and rear pillar, roof side rail.

(Continued)



(Continued)

- Do not hang hard or breakable objects on the clothes hanger.
- Do not allow passengers to lean their heads or bodies onto doors, put their arms on the doors, stretch their arms out of the window, or place objects between the doors and seats.
- Do not open or repair the side curtain air bags.

### How does the air bags system operate?

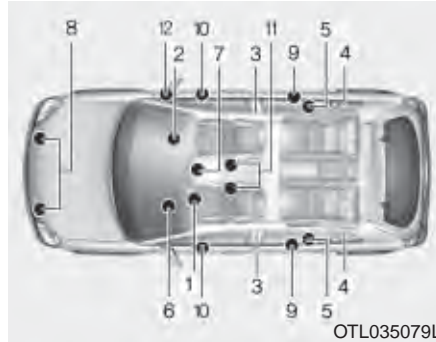

The SRS consists of the following components:

- (1) Driver's front air bag module
- (2) Passenger's front air bag module
- (3) Side air bag modules
- (4) Curtain air bag modules
- (5) Retractor pre-tensioner assemblies
- (6) Air bag warning light
- (7) SRS control module (SRSCM)/ Rollover sensor (if equipped)

- (8) Front impact sensors
- (9) Side impact sensors
- (10) Side pressure sensors
- (11) Driver's and front passenger's seat belt buckle sensors. (if equipped)
- (12) Passenger's front air bag ON/OFF switch (if equipped)

The SRSCM continually monitors SRS components except for buckle sensor while the ignition switch is in the ON position to determine if a crash impact is severe enough to require air bag deployment or pretensioner seat belt deployment.



### SRS warning light

The SRS air bag warning light on the instrument panel will illuminate for about 6 seconds after the ignition switch is turned to the ON position, after which the air bag warning light should go out.

## WARNING

If your SRS malfunctions, the air bag may not inflate properly during an accident increasing the risk of serious injury or death.

If any of the following conditions occur, your SRS is malfunctioning:

- The light does not turn on for approximately six seconds when the ignition switch is in the ON position.
- The light stays on after illuminating for approximately six seconds.
- The light comes on while the vehicle is in motion.
- The light blinks when the engine is running.

We recommend that an authorized HYUNDAI dealer inspect the SRS as soon as possible if any of these conditions occur.

During a frontal collision, sensors will detect the vehicle's deceleration. If the rate of deceleration is high enough, the control unit will inflate the front air bags, at the time and with the force needed.

The front air bags help protect the driver and front passenger by responding to frontal impacts in which seat belts alone cannot provide adequate restraint. When needed, the side air bags help provide protection in the event of a side impact.

- Air bags are activated (able to inflate if necessary) only when the ignition switch is in the ON position.
- Air bags inflate in the event of certain frontal or side collisions to help protect the occupants from serious physical injury.
- There is no single speed at which the air bags will inflate. Generally, air bags are designed to inflate based upon the severity of a collision and its direction. These two factors determine whether the sensors produce an electronic deployment/inflation signal.

- Air bag deployment depends on a number of factors including vehicle speed, angles of impact and the density and stiffness of the vehicles or objects which your vehicle impacts during a collision. The determining factors are not limited to those mentioned above.
- The front air bags will completely inflate and deflate in an instant. It is virtually impossible for you to see the air bags inflate during an accident. It is much more likely that you will simply see the deflated air bags hanging out of their storage compartments after the collision.

- To help provide protection, the air bags must inflate rapidly. The speed of air bag inflation is a consequence of extremely short time in which to inflate the air bag between the occupant and the vehicle structures before the occupant impacts those structures. This speed of inflation reduces the risk of serious or life-threatening injuries and is thus a necessary part of air bag design.

However, the rapid air bag inflation can also cause injuries which can include facial abrasions, bruises and broken bones because the inflation speed also causes the air bags to expand with a great deal of force.

- There are even circumstances under which contact with the air bag can cause fatal injuries, especially if the occupant is positioned excessively close to the air bag.

You can take steps to reduce the risk of being injured by an inflating air bag. The greatest risk is sitting too close to the air bag. An air bag needs space to inflate. It is recommended that drivers sit as far as possible between the center of the steering wheel and the chest while still maintaining control of the vehicle.

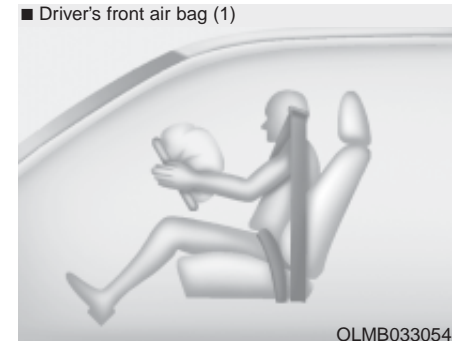

When the SRSCM detects a sufficiently severe impact to the front of the vehicle, it will automatically deploy the front air bags.

■ Driver's front air bag (2)

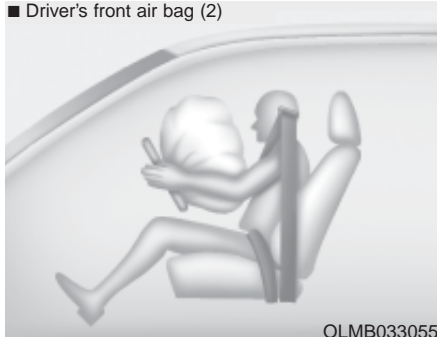

OLMB033055

Upon deployment, tear seams molded directly into the pad covers will separate under pressure from the expansion of the air bags. Further opening of the covers allows full inflation of the air bags.

A fully inflated air bag, in combination with a properly worn seat belt, slows the driver's or the front passenger's forward motion, reducing the risk of head and chest injury.

■ Driver's front air bag (3)

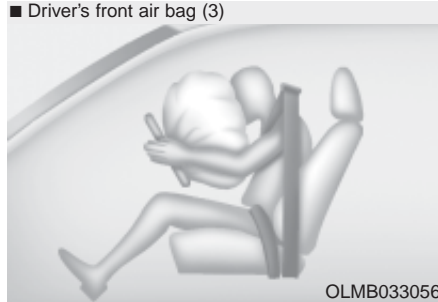

OLMB033056

■ Passenger's front air bag



OLMB033057

After complete inflation, the air bag immediately starts deflating, enabling the driver to maintain forward visibility and the ability to steer or operate other controls.

**⚠ WARNING**

To prevent objects from becoming dangerous projectiles when the passenger's air bag inflates:

- Do not install or place any objects (drink holder, CD holder, stickers, etc.) on the front passenger's panel above the glove box where the passenger's air bag is located.
- Do not install a container of liquid air freshener near the instrument cluster or on the instrument panel surface.

### What to expect after an air bag inflates

After a frontal or side air bag inflates, it will deflate very quickly. Air bag inflation will not prevent the driver from seeing out of the windshield or being able to steer. Curtain air bags may remain partially inflated for some time after they deploy.

#### WARNING

**After an air bag inflates, take the following precautions:**

- **Open your windows and doors as soon as possible after impact to reduce prolonged exposure to the smoke and powder released by the inflating air bag.**
- **Do not touch the air bag storage area's internal components immediately after an air bag has inflated. The parts that come into contact with an inflating air bag may be very hot.**

(Continued)

(Continued)

- **Always wash exposed skin areas thoroughly with cold water and mild soap.**
- **We recommend that an authorized HYUNDAI dealer replace the air bag immediately after deployment. Air bags are designed to be used only once.**

**Noise and smoke from inflating air bag**

When the air bags inflate, they make a loud noise and may produce smoke and powder in the air inside of the vehicle. This is normal and is a result of the ignition of the air bag inflator. After the air bag inflates, you may feel substantial discomfort in breathing because of the contact of your chest with both the seat belt and the air bag, as well as from breathing the smoke and powder. The powder may aggravate asthma for some people. If you experience breathing problems after an air bag deployment, seek medical attention immediately.

Though the smoke and powder are nontoxic, they may cause irritation to the skin, eyes, nose, throat, etc. If this is the case, wash and rinse with cold water immediately and seek medical attention if the symptoms persist.

**Do not install a Child Restraint System on the front passenger seat**

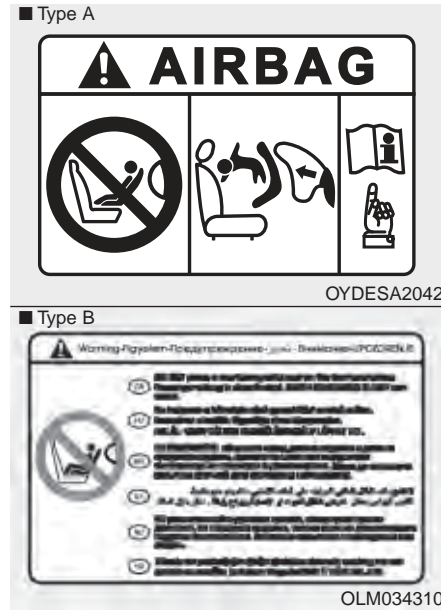

Never install a Child Restraint System in the front passenger's seat. An inflating air bag can forcefully strike a child or restraint resulting in serious or fatal injury.

If your vehicle is equipped with the passenger's front air bag ON/OFF switch, you can activate or deactivate the front passenger's air bag when necessary.

**WARNING**

- Extreme hazard! Do not use a rearward facing Child Restraint System on a seat protected by an air bag in front of it!
- NEVER use a rearward facing Child Restraint System on a seat protected by an ACTIVE AIRBAG in front of it, DEATH or SERIOUS INJURY to the CHILD can occur.
- Never put a Child Restraint System in the front passenger's seat. If the front passenger air bag inflates, it would cause serious or fatal injuries.

### Why didn't my air bag go off in a collision?

There are certain types of accidents in which the air bag would not be expected to provide additional protection. These include rear impacts, second or third collisions in multiple impact accidents, as well as low speed impacts. Damage to the vehicle indicates a collision energy absorption, and is not an indicator of whether or not an air bag should have inflated.

### *Air bag collision sensors (if equipped)*

#### **WARNING**

To reduce the risk of an air bag deploying unexpectedly and causing serious injury or death:

- Do not hit or allow any objects to impact the locations where air bags or sensors are installed.
- Do not perform maintenance on or around the air bag sensors. If the location or angle of the sensors is altered, the air bags may deploy when they should not or may not deploy when they should.
- Do not install bumper guards or replace the bumper with a non-genuine part. This may adversely affect the collision and air bag deployment performance.

(Continued)

(Continued)

- Place the ignition switch to the LOCK/OFF or ACC position, when the vehicle is being towed to prevent inadvertent air bag deployment.
- We recommend that all air bag repairs are conducted by an authorized HYUNDAI dealer.



1. SRS control module
2. Front impact sensor
3. Side pressure sensor (front)
4. Side impact sensor (rear)



OTL035044L/OTL035045/OTL035046L/OTL035047/OTL035048



### Air bag inflation conditions



#### Front air bags

Front air bags are designed to inflate in a frontal collision depending on the severity, speed or angles of impact of the front collision.



#### Side and curtain air bags

Side and curtain air bags are designed to inflate when an impact is detected by side collision sensors depending on the severity, speed or angles of impact resulting from a side impact collision.

Although the driver's and front passenger's air bags are designed to inflate only in frontal collisions, they also may inflate in other types of collisions if the front impact sensors detect a sufficient impact. Side and curtain air bags are designed to inflate only in side impact collisions, but they may inflate in other collisions if the side impact sensors detect a sufficient impact.

If the vehicle chassis is impacted by bumps or objects on unimproved roads, the air bags may deploy. Drive carefully on unimproved roads or on surfaces not designed for vehicle traffic to prevent unintended air bag deployment.

### Air bag non-inflation conditions



In certain low-speed collisions the air bags may not deploy. The air bags are designed not to deploy in such cases because they may not provide benefits beyond the protection of the seat belts.



Front air bags are not designed to inflate in rear collisions, because occupants are moved backward by the force of the impact. In this case, inflated air bags would not provide any additional benefit.



Front air bags may not inflate in side impact collisions, because occupants move in the direction of the collision, and thus in side impacts, front air bag deployment would not provide additional occupant protection.

However, side and curtain air bags may inflate depending on the severity, vehicle speed and angles of impact.

In an angled collision, the force of impact may direct the occupants in a direction where the air bags would not be able to provide any additional benefit, and thus the sensors may not deploy any air bags.

Just before impact, drivers often brake heavily. Such heavy braking lowers the front portion of the vehicle causing it to “ride” under a vehicle with a higher ground clearance. Air bags may not inflate in this “under-ride” situation because deceleration forces that are detected by sensors may be significantly reduced by such “underride” collisions.

Front air bags may not inflate in rollover accidents because front air bag deployment would not provide additional occupant protection.

### Information

- **Vehicles equipped with rollover sensor**

**The side and curtain air bags may inflate in a rollover situation, when it is detected by the rollover sensor.**

- **Vehicles not equipped with rollover sensor**

**The side and/or curtain air bags may inflate when the vehicle is rolled over by a side impact collision, if the vehicle is equipped with side and/or curtain air bags.**

Air bags may not inflate if the vehicle collides with objects such as utility poles or trees, where the point of impact is concentrated and the collision energy is absorbed by the vehicle structure.

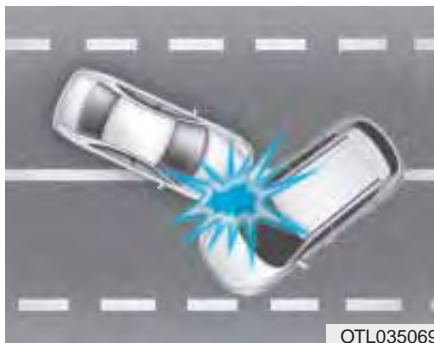

OTL035069

### SRS care

The SRS is virtually maintenance-free and there are no parts you can safely service by yourself. If the SRS air bag warning light does not illuminate when the ignition switch is in the ON position, or continuously remains on, we recommend that the system be immediately inspected by an authorized HYUNDAI dealer.

We recommend any work on the SRS system, such as removing, installing, repairing, or any work on the steering wheel, the front passenger's panel, front seats and roof rails be performed by an authorized HYUNDAI dealer. Improper handling



OTL035064

of the SRS system may result in serious personal injury.



OTL035068

### ⚠ WARNING

To reduce the risk of serious injury or death take the following precautions:

- Do not attempt to modify or disconnect the SRS components or wiring, including the addition of any kind of badges to the pad covers or modifications to the body structure.
- Do not place objects over or near the air bag modules on the steering wheel, instrument panel, and the front passenger's panel above the glove box.
- Clean the air bag pad covers with a soft cloth moistened with plain water. Solvents or cleaners could adversely affect the air bag covers and proper deployment of the system.
- We recommend that inflated air bags be replaced by an authorized HYUNDAI dealer.

(Continued)

(Continued)

- If components of the air bag system must be discarded, or if the vehicle must be scrapped, certain safety precautions must be observed. Consult an authorized HYUNDAI dealer for the necessary information. Failure to follow these precautions could increase the risk of personal injury.

### Additional safety precautions

**Passengers should not move out of or change seats while the vehicle is moving.** A passenger who is not wearing a seat belt during a crash or emergency stop can be thrown against the inside of the vehicle, against other occupants, or be ejected from the vehicle.

**Do not use any accessories on seat belts.** Devices claiming to improve occupant comfort or reposition the seat belt can reduce the protection provided by the seat belt and increase the chance of serious injury in a crash

**Do not modify the front seats.**

Modification of the front seats could interfere with the operation of the supplemental restraint system sensing components or side air bags.

**Do not place items under the front seats.** Placing items under the front seats could interfere with the operation of the supplemental restraint system sensing components and wiring harnesses.

**Do not cause impact to the doors.** Impact to the doors when the ignition switch is in the ON position may cause the air bags to inflate.

### *Adding equipment to or modifying your air bag equipped vehicle*

If you modify your vehicle by changing your vehicle's frame, bumper system, front end or side sheet metal or ride height, this may affect the operation of your vehicle's air bag system.

### Air bag warning labels



Air bag warning labels are attached to alert the passengers of potential risks of the air bag system. Be sure to read all of the information about the air bags that are installed on your vehicle in this Owner's Manual.

## Convenient features of your vehicle

<b>Accessing your vehicle</b> .....	5-4	<b>Panorama sunroof</b> .....	5-41
Remote key .....	5-4	Sunshade .....	5-42
Remote key precautions.....	5-6	Sliding the sunroof .....	5-42
Smart key .....	5-8	Tilting the sunroof .....	5-43
Smart key precautions.....	5-11	Closing the sunroof .....	5-43
Battery replacement .....	5-12	Resetting the sunroof.....	5-45
Immobilizer system .....	5-13	Sunroof open warning.....	5-45
<b>Door locks</b> .....	5-14	<b>Exterior features</b> .....	5-46
Operating door locks from outside the vehicle .....	5-14	Hood .....	5-46
Operating door locks from inside the vehicle .....	5-16	Fuel filler door .....	5-48
Deadlocks .....	5-18	<b>Tailgate</b> .....	5-51
Auto door lock/unlock features .....	5-19	Non-power tailgate .....	5-51
Child-protector rear door locks.....	5-19	Power tailgate.....	5-53
<b>Theft-alarm system</b> .....	5-20	Smart tailgate.....	5-60
Theft-alarm system (For Brazil) .....	5-21	<b>Instrument cluster</b> .....	5-64
<b>Steering wheel</b> .....	5-24	Instrument cluster control .....	5-66
Electric power steering (EPS).....	5-24	LCD display control.....	5-67
Tilt steering / Telescope steering.....	5-25	Gauges .....	5-67
Heated steering wheel.....	5-26	<b>LCD Display</b> .....	5-74
Horn.....	5-26	LCD modes .....	5-74
<b>Mirrors</b> .....	5-27	Trip computer mode .....	5-76
Inside rearview mirror.....	5-27	Turn By Turn (TBT) mode.....	5-76
Outside rearview mirror .....	5-32	A/V mode.....	5-76
<b>Windows</b> .....	5-35	Information mode.....	5-77
Power windows.....	5-35	User settings mode.....	5-79
		Warning messages .....	5-84

<b>Trip computer</b> .....	<b>5-94</b>	<b>Manual climate control system</b> .....	<b>5-146</b>
Overview.....	5-94	Heating and air conditioning.....	5-147
Trip modes .....	5-94	System operation.....	5-153
Trip A/B.....	5-94	System maintenance.....	5-155
Fuel economy.....	5-95	Air Conditioning refrigerant label.....	5-156
<b>Warning and indicator lights</b> .....	<b>5-99</b>	Checking the amount of air conditioner refrigerant and compressor lubricant.....	5-157
Warning lights .....	5-99	<b>Automatic climate control system</b> .....	<b>5-158</b>
Indicator lights.....	5-109	Automatic heating and air conditioning.....	5-159
<b>Light</b> .....	<b>5-116</b>	Manual heating and air conditioning.....	5-160
Exterior lights .....	5-116	System operation.....	5-168
Welcome system .....	5-125	System maintenance.....	5-170
Interior lights.....	5-126	Checking the amount of air conditioner refrigerant and compressor lubricant.....	5-171
<b>Wipers and washers</b> .....	<b>5-131</b>	<b>Windshield defrosting and defogging</b> .....	<b>5-172</b>
Windshield wipers .....	5-132	Manual climate control system .....	5-172
Windshield washers .....	5-132	Automatic climate control system .....	5-173
Rear window wiper and washer switch .....	5-133	Defogging logic.....	5-174
<b>Driver assist system</b> .....	<b>5-135</b>	<b>Climate control additional features</b> .....	<b>5-177</b>
Rear view camera .....	5-135	Cluster ionizer.....	5-177
Rear parking assist system .....	5-136	Sunroof inside air recirculation.....	5-177
Parking Assist System .....	5-139		
<b>Defroster</b> .....	<b>5-144</b>		
Rear window defroster .....	5-144		



<b>Storage compartment</b> .....	<b>5-178</b>
Center console storage .....	5-178
Glove box .....	5-179
Cool box.....	5-179
Sunglass holder .....	5-180
<b>Interior features</b> .....	<b>5-181</b>
Ashtray .....	5-181
Cup holder.....	5-181
Sunvisor .....	5-183
Power outlet.....	5-183
Cigarette lighter .....	5-185
Clock.....	5-185
Clothes hanger .....	5-187
Floor mat anchor(s).....	5-188
Luggage net (holder) .....	5-188
Cargo security screen.....	5-189
Luggage tray.....	5-192
<b>Exterior features</b> .....	<b>5-193</b>
Roof rack .....	5-193

## ACCESSING YOUR VEHICLE

### Remote key (if equipped)



Your HYUNDAI uses a remote key, which you can use to lock or unlock a door (and tailgate) and even start the engine.

1. Door Lock
2. Door Unlock
3. Tailgate Unlock

### Locking

To lock :

1. Close all doors, engine hood and tailgate.
2. Press the Door Lock button (1) on the remote key.
3. The doors will lock. The hazard warning lights will blink. Also, the outside rearview mirror will fold, if the outside rearview mirror folding switch is in the AUTO position (if equipped).
4. Make sure the doors are locked by checking the position of the door lock button inside the vehicle.

### WARNING

**Do not leave the keys in your vehicle with unsupervised children. Unattended children could place the key in the ignition switch and may operate power windows or other controls, or even make the vehicle move, which could result in serious injury or death.**

### Unlocking

To unlock:

1. Press the Door Unlock button (2) on the remote key.
2. The doors will unlock. The hazard warning lights will blink two times. Also, the outside rearview mirror will unfold, if the outside rearview mirror folding switch is in the AUTO position (if equipped).

### Information

**After unlocking the doors, the doors will lock automatically after 30 seconds unless a door is opened.**

### Tailgate unlocking

To unlock:

1. Press the Tailgate Unlock button (3) on the remote key for more than one second.
2. The hazard warning lights will blink two times. The tailgate will unlock. The power tailgate will unlock and then open.(if equipped)

For more details, refer to “Power tailgate” in this chapter.

### **i** Information

- After unlocking the tailgate, the tailgate will lock automatically.
- The word "HOLD" is written on the button to inform you that you must press and hold the button for more than one second.

### Start-up

For detailed information refer to “Key Ignition Switch” in chapter 5.

#### **NOTICE**

To prevent damaging the remote key:

- Keep the remote key away from water or any liquid and fire. If the inside of the remote key gets damp (due to drinks or moisture), or is heated, internal circuit may malfunction, excluding the car from the warranty.
- Avoid dropping or throwing the remote key.
- Protect the remote key from extreme temperatures.

### Mechanical key



If the remote key does not operate normally, you can lock or unlock the door by using the mechanical key.

### Type C

To unfold the key, press the release button then the key will unfold automatically.

To fold the key, fold the key manually while pressing the release button.

#### **NOTICE**

**Do not fold the key without pressing the release button. This may damage the key.**

### Remote key precautions

The remote key will not work if any of the following occur:

- The key is in the ignition switch.
- You exceed the operating distance limit (about 30 m [90 feet]).
- The remote key battery is weak.
- Other vehicles or objects may be blocking the signal.
- The weather is extremely cold.
- The remote key is close to a radio transmitter such as a radio station or an airport which can interfere with normal operation of the remote key.

When the remote key does not work correctly, open and close the door with the mechanical key. If you have a problem with the remote key, it is recommended that you contact an authorized HYUNDAI dealer.

(Continue)

(Continue)

If the remote key is in close proximity to your mobile phone, the signal could be blocked by your mobile phones normal operational signals. This is especially important when the phone is active such as making and receiving calls, text messaging, and/or sending/receiving emails. Avoid placing the remote key and your mobile phone in the same pants or jacket pocket and always try to maintain an adequate distance between the two devices.

**i Information**

Changes or modifications not expressly approved by the party responsible for compliance could void the user's authority to operate the equipment. If the keyless entry system is inoperative due to changes or modifications not expressly approved by the party responsible for compliance, it will not be covered by your manufacturer's vehicle warranty.

**NOTICE**

Keep the remote key away from electromagnetic materials that blocks electromagnetic waves to the key surface.

**Battery replacement**

If the remote key is not working properly, try replacing the battery with a new one.

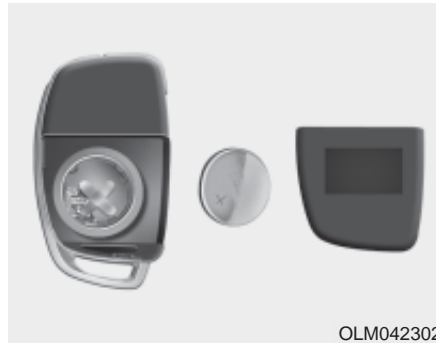

Battery Type: CR2032

To replace the battery:

1. Insert a slim tool into the slot and gently pry open the cover.
2. Remove the old battery and insert the new battery. Make sure the battery position is correct.
3. Reinstall the rear cover of the remote key.

If you suspect your remote key might have sustained some damage, or you feel your remote key is not working correctly, it is recommended that you contact an authorized HYUNDAI dealer.

**i Information**



An inappropriately disposed battery can be harmful to the environment and human health. Dispose the battery according to your local law(s) and regulation.

### Smart key (if equipped)



Your HYUNDAI uses a Smart Key, which you can use to lock or unlock a door (and tailgate) and even start the engine.

1. Door Lock
2. Door Unlock
3. Tailgate Unlock

### Locking



To lock :

1. Close all doors, engine hood and tailgate.
2. Either press the door handle button or press the Door Lock button (1) on the smart key.
3. The hazard warning lights will blink. Also, the outside rearview mirror will fold, if the outside rearview mirror folding switch is in the AUTO position (if equipped).
4. Make sure the doors are locked by checking the position of the door lock button inside the vehicle.

### **i** Information

The door handle button will only operate when the smart key is within 0.7~1 m (28~40 in.) from the outside door handle.

Even though you press the outside door handle button, the doors will not lock and the chime will sound for three seconds if any of the following occur:

- The Smart Key is in the vehicle.
- The Engine Start/Stop button is in ACC or ON position.
- Any door except the tailgate is open.

**WARNING**

Do not leave the Smart Key in your vehicle with unsupervised children. Unattended children could press the Engine Start/ Stop button and may operate power windows or other controls, or even make the vehicle move, which could result in serious injury or death.

**Unlocking**

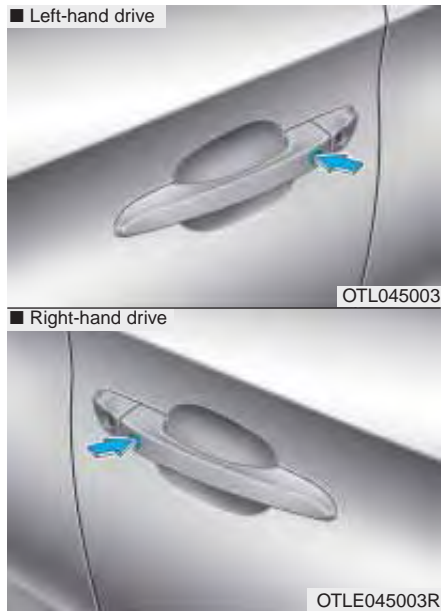

To unlock:

1. Carry the Smart Key.
2. Either press the door handle button or press the Door Unlock button (2) on the smart key.

3. The doors will unlock. The hazard warning lights will blink two times. Also, the outside rearview mirror will unfold, if the outside rearview mirror folding switch is in the AUTO position. (if equipped)

**i Information**

- The door handle button will only operate when the smart key is within 0.7~1 m (28~40 in.) from the outside door handle. Other people can also open the doors without the smart key in possession.
- After unlocking the doors, the doors will lock automatically after 30 seconds unless a door is opened.

### **Tailgate unlocking**

To unlock:

1. Carry the smart key.
2. Either press the tailgate handle button or press the Tailgate Unlock button (3) on the smart key for more than one second.
3. The hazard warning lights will blink two times. The tailgate will unlock. The power tailgate will unlock and then open.(if equipped)

For more details, refer to “Power tailgate” in this chapter.

### **i Information**

After unlocking the tailgate, the tailgate will lock automatically after 30 seconds unless the tailgate is opened.

### **Start-up**

You can start the engine without inserting the key. For detailed information refer to the Engine Start/Stop button in chapter 5.

#### **NOTICE**

To prevent damaging the smart key:

- Keep the smart key away from water or any liquid and fire. If the inside of the smart key gets damp (due to drinks or moisture), or is heated, internal circuit may malfunction, excluding the car from the warranty.
- Avoid dropping or throwing the smart key.
- Protect the smart key from extreme temperatures.

### **Mechanical key**

If the Smart Key does not operate normally, you can lock or unlock the door by using the mechanical key.



OIB044175E

Press and hold the release button (1) and remove the mechanical key (2). Insert the mechanical key into the key hole on the door.

To reinstall the mechanical key, put the key into the hole and push it until a click sound is heard.



### ***Loss of a smart key***

A maximum of two smart keys can be registered to a single vehicle. If you happen to lose your smart key, it is recommended that you should immediately take the vehicle and remaining key to your authorized HYUNDAI dealer or tow the vehicle, if necessary.

### **Smart key precautions**

The smart key will not work if any of the following occur:

- The smart key is close to a radio transmitter such as a radio station or an airport which can interfere with normal operation of the transmitter.
- The smart key is near a mobile two way radio system or a cellular phone.
- Another vehicle's smart key is being operated close to your vehicle.

When the smart key does not work correctly, open and close the door with the mechanical key. If you have a problem with the smart key, it is recommended that you contact an authorized HYUNDAI dealer.

If the smart key is in close proximity to your mobile phone, the signal could be blocked by your mobile phones normal operational signals. This is especially important when the phone is active such as making and receiving calls, text messaging, and/or sending/receiving emails. Avoid placing the smart key and your mobile phone in the same pants or jacket pocket and always try to maintain an adequate distance between the two devices.

## Immobilizer system (if equipped)

The immobilizer system protects your vehicle from theft. If an improperly coded key (or other device) is used, the engine's fuel system is disabled.

When the ignition switch is placed in the ON position, the immobilizer system indicator should come on briefly, then go off. If the indicator starts to blink, the system does not recognize the coding of the key.

Place the ignition switch to the LOCK/OFF position, then place the ignition switch to the ON position again.

The system may not recognize your key's coding if another immobilizer key or other metal object (i.e., key chain) is near the key. The engine may not start because the metal may interrupt the transponder signal from transmitting normally.

If the system repeatedly does not recognize the coding of the key, it is recommended that you contact your HYUNDAI dealer.

Do not attempt to alter this system or add other devices to it. Electrical problems could result that may make your vehicle inoperable.

### WARNING

**In order to prevent theft of your vehicle, do not leave spare keys anywhere in your vehicle. Your immobilizer password is a customer unique password and should be kept confidential.**

### NOTICE

**The transponder in your key is an important part of the immobilizer system. It is designed to give years of trouble-free service, however you should avoid exposure to moisture, static electricity and rough handling. Immobilizer system malfunction could occur.**

## DOOR LOCKS

### Operating door locks from outside the vehicle

#### Mechanical key

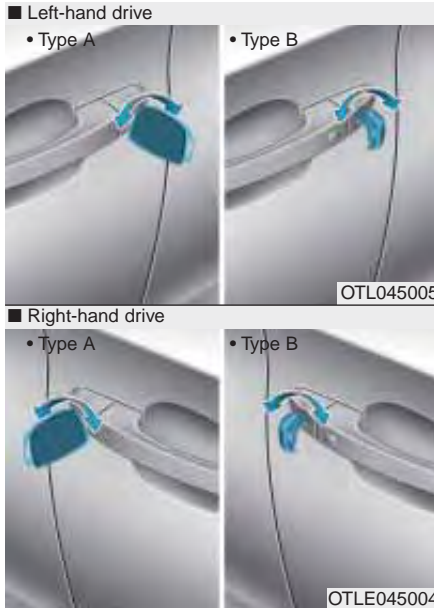

Turn the key toward the rear of the vehicle to unlock and toward the front of the vehicle to lock.

If you lock/unlock the driver's door with a key, all vehicle doors will lock/unlock automatically. (if equipped with the central door lock system)

Once the doors are unlocked, they may be opened by pulling the door handle.

When closing the door, push the door by hand. Make sure that doors are closed securely.

#### Remote key



To lock the doors, press the Door Lock button (1) on the remote key.

To unlock the doors, press the Door Unlock button (2) on the remote key.

Once the doors are unlocked, they may be opened by pulling the door handle.

When closing the door, push the door by hand. Make sure that doors are closed securely.

## **i** Information

- In cold and wet climates, door lock and door mechanisms may not work properly due to freezing conditions.
- If the door is locked/unlocked multiple times in rapid succession with either the vehicle key or door lock switch, the system may stop operating temporarily in order to protect the circuit and prevent damage to system components.

### Smart key

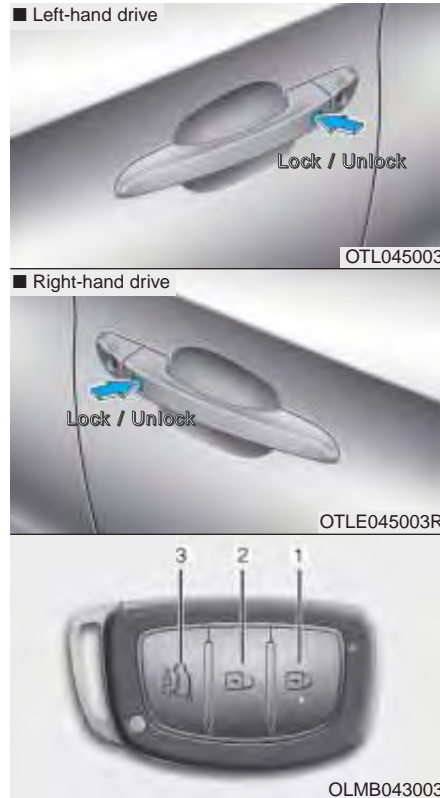

1. Door lock
2. Door unlock
3. Tailgate open

To lock the doors, press the button on the outside door handle while carrying the smart key with you or press the door lock button on the smart key.

To unlock the doors, press the button on the outside door handle while carrying the smart key with you or press the door unlock button on the smart key.

Once the doors are unlocked, they may be opened by pulling the door handle.

When closing the door, push the door by hand. Make sure that doors are closed securely.

### **i** Information

- In cold and wet climates, door lock and door mechanisms may not work properly due to freezing conditions.
- If the door is locked/unlocked multiple times in rapid succession with either the vehicle key or door lock switch, the system may stop operating temporarily in order to protect the circuit and prevent damage to system components.

### Operating door locks from inside the vehicle

#### *With the door lock button*



- To unlock a door, push the door lock button (1) to the “Unlock” position. The red mark (2) on the door lock button will be visible.
- To lock a door, push the door lock button (1) to the “Lock” position. If the door is locked properly, the red mark (2) on the door lock button will not be visible.
- To open a door, pull the door handle (3) outward.
- If the inner door handle of the driver’s (or front passenger’s) door is pulled when the door lock button is in the lock position, the button is unlocked and door opens.
- Front doors cannot be locked if the key is in the ignition switch and any front door is open.
- Doors cannot be locked if the smart key is in the vehicle and any door is open.

## **i** Information

If a power door lock ever fails to function while you are in the vehicle try one or more of the following techniques to exit:

Operate the door unlock feature repeatedly (both electronic and manual) while simultaneously pulling on the door handle.

Operate the other door locks and handles, front and rear.

Lower a front window and use the mechanical key to unlock the door from outside.

### *With the central door lock switch (if equipped)*

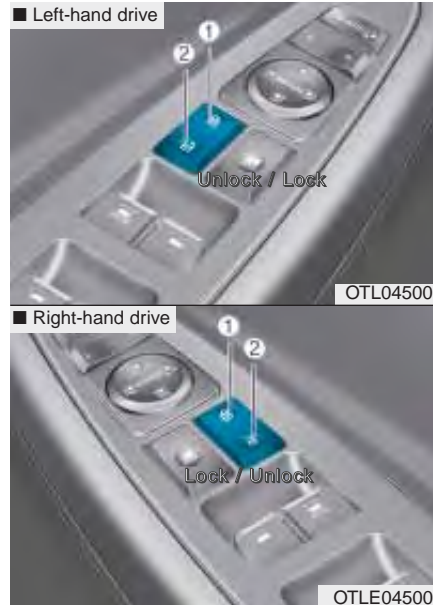

When pressing the (🔒) portion (1) of the switch, all vehicle doors will lock.

- If the key is in the ignition switch and any door is opened, the doors will not lock even though the lock button (1) of the central door lock switch is pressed.
- If the smart key is in the vehicle and any door is opened, the doors will not lock even though the lock button (1) of the central door lock switch is pressed.

When pressing the (🔓) portion (2) of the switch, all vehicle doors will unlock.

### WARNING

The doors should always be fully closed and locked while the vehicle is in motion. If the doors are unlocked, the risk of being thrown from the vehicle in a crash is increased.

### WARNING

Do not leave children or animals unattended in your vehicle. An enclosed vehicle can become extremely hot, causing death or serious injury to unattended children or animals who cannot escape the vehicle. Children might operate features of the vehicle that could injure them, or they could encounter other harm, possibly from someone gaining entry to the vehicle.

### WARNING

#### Always secure your vehicle

Leaving your vehicle unlocked increases the potential risk to you or others from someone hiding in your vehicle.

To secure your vehicle, while depressing the brake, move the shift lever to the P (Park) position (for automatic transaxle/dual clutch transmission) or first gear or R (Reverse, for manual transaxle), engage the parking brake, and place the ignition switch in the LOCK/OFF position, close all windows, lock all doors, and always take the key with you.

### WARNING

Opening a door when something is approaching may cause damage or injury. Be careful when opening doors and watch for vehicles, motorcycles, bicycles or pedestrians approaching the vehicle in the path of the door.

## Deadlocks (if equipped)

Some vehicles are equipped with a deadlock system. Deadlocks prevent opening of a door from either inside or outside the vehicle once the deadlocks have been activated providing an additional measure of vehicle security.

To lock the vehicle using the deadlock function, the doors must be locked by using the transmitter or smart key. To unlock the vehicle, the transmitter or smart key must be used again.

### WARNING

Do not lock the doors with the transmitter or the smart key with anybody left in the vehicle. The passenger in the vehicle cannot unlock the doors with the door lock button. For example, if the door is locked with the transmitter, the passenger in the vehicle cannot unlock the door without the transmitter.

## Auto door lock/unlock features

### *Impact sensing door unlock system (if equipped)*

All doors will be automatically unlocked when an impact causes the air bags to deploy.

### *Speed sensing door lock system (if equipped)*

All doors will be automatically locked when vehicle speed exceeds 15 km/h (9 mph).

You can activate or deactivate the Auto Door Lock/Unlock features from the User Settings Mode on the LCD display. **For more details, refer to "LCD Display" in this chapter.**

## Child-protector rear door locks



The child safety lock is provided to help prevent children seated in the rear from accidentally opening the rear doors. The rear door safety locks should be used whenever children are in the vehicle.

The child safety lock is located on the edge of each rear door. When the child safety lock is in the lock position (1), the rear door will not open if the inner door handle (2) is pulled.

To lock the child safety lock, insert a key (or screwdriver) into the hole and turn it to the lock position.

To allow a rear door to be opened from inside the vehicle, unlock the child safety lock.

### **WARNING**

**If children accidentally open the rear doors while the vehicle is in motion, they could fall out of the vehicle. The rear door safety locks should always be used whenever children are in the vehicle.**



### THEFT-ALARM SYSTEM (IF EQUIPPED)

This system helps to protect your vehicle and valuables. The horn will sound and the hazard warning lights will blink continuously if any of the following occurs:

- A door is opened without using the remote key or smart key.
- The tailgate is opened without using the remote key or smart key.
- The engine hood is opened.

The alarm continues for 30 seconds, then the system resets. To turn off the alarm, unlock the doors with the remote key or smart key.

The Theft Alarm System automatically sets 30 seconds after you lock the doors and the tailgate. For the system to activate, you must lock the doors and the tailgate from outside the vehicle with the remote key or smart key or by pressing the button on the outside of the door handles with the smart key in your possession.

The hazard warning lights will blink and the chime will sound once to indicate the system is armed.

Once the security system is set, opening any door, the tailgate, or the hood without using the remote key or smart key will cause the alarm to activate.

The Theft Alarm System will not set if the hood, the tailgate, or any door is not fully closed. If the system will not set, check the hood, the tailgate, or the doors are fully closed.

Do not attempt to alter this system or add other devices to it.

#### **i** Information

- **Do not lock the doors until all passengers have left the vehicle. If the remaining passenger leaves the vehicle when the system is armed, the alarm will be activated.**
- **If the vehicle is not disarmed with the remote key or smart key, open the doors by using the mechanical key and place the ignition switch in the ON position (for remote key) or start the engine (for smart key) and wait for 30 seconds.**
- **When the system is disarmed but a door or tailgate is not opened within 30 seconds, the system will be rearmed.**



#### **i** Information

Vehicles equipped with a theft alarm system will have a label attached to the vehicle with the following words:

1. WARNING
2. SECURITY SYSTEM

## Theft-alarm system (For Brazil)

### Intrusion/tilt sensor ON/OFF condition (For Brazil, if equipped)



The intrusion/tilt sensor detects movement inside the vehicle and inclination of the vehicle after locking.

- To cancel the sensor operation, press the sensor ON/OFF button when the system is in the "Disarmed" stage and the ignition switch or Engine Start/Stop button is in the OFF position. The button light will turn on to indicate that the sensor is deactivated.

- If you press the button again or turn the ignition switch or Engine Start/Stop button to the ON position, the sensor will be activated again.

If the system is armed when the sensor is in the OFF status, the intrusion/tilt sensor will not operate. But, the alarm will be activated when the system meets the "intrusion/tilt sensor off condition" of "Theft alarm" stage. Refer to the follow page.

**Deactivate the intrusion/tilt sensor if there are any chances the vehicle tilts by the outward influences.**

For example,

- When the vehicle is transported by train, boat or trailer.
- When the vehicle is parked at a parking tower.

Otherwise, the horn may sound inadvertently.

### **i** Information

- **Make sure all windows are close while the sensor operates. If not, the sensor detects the inadvertent movement inside the vehicle (for example, blowing a wind or entering a butterfly) and it makes the horn sounds.**
- **If boxes are piled high in the vehicle, the sensor may not detect the movement behind the boxes. Also the boxes may drop and it makes the horn sounds.**
- **If the sensor is stained with foreign matter such as cosmetics, spray type air freshener, or spray type window cleaner, the sensor may not operate normally.**

### ***Theft-alarm stage***

The alarm will be activated if any of the following occurs while the system is armed.

### ***Without the intrusion/tilt sensor (or intrusion/tilt sensor off condition (if equipped))***

- A front or rear door is opened without using the transmitter (or smart key).
- The tailgate is opened without using the transmitter (or smart key).
- The engine hood is opened.

The horn will sound and the hazard warning lights will blink continuously for 30 seconds, unless the system is disarmed. To turn off the system, unlock the doors with the transmitter (or smart key).

### ***Intrusion/tilt sensor on position (if equipped)***

- Someone or something moves in the vehicle.
- The inclination of the vehicle is changed to the certain degree.
- A front or rear door is opened without using the transmitter (or smart key).
- The tailgate is opened without using the transmitter (or smart key).
- The engine hood is opened.

The horn will sound and the hazard warning lights will blink continuously for 30 seconds, unless the system is disarmed. To turn off the system, unlock the doors with the transmitter (or smart key).

### ***Disarmed stage***

The system will be disarmed when the door unlock button is pressed.

After the doors are unlocked, the hazard warning lights will blink twice to indicate that the system is disarmed.

After pressing the unlock button, if any door (or tailgate) is not opened within 30 seconds, the system will be rearmed

- If the vehicle is equipped with the remote window up/down system; the windows are also closed.

### ***i* Information**

- **If the system is not disarmed with the transmitter, open the door with the key and insert the key into the ignition switch, turn the ignition switch to the ON position and wait for 30 seconds. Then the system will be disarmed.**
- **If you lose your keys, we recommend that you consult with an authorized HYUNDAI dealer.**

## STEERING WHEEL

### Electric power steering (EPS)

The system assists you with steering the vehicle. If the engine is off or if the power steering system becomes inoperative, the vehicle may still be steered, but it will require increased steering effort.

Also, the steering effort becomes heavier as the vehicle's speed increases and becomes lighter as the vehicle's speed decreases for better control of the steering wheel.

Should you notice any change in the effort required to steer during normal vehicle operation, we recommend that the system be checked by an authorized HYUNDAI dealer.

#### NOTICE

If the Electric Power Steering System does not operate normally, the warning light (⊖!) will illuminate on the instrument cluster. The steering wheel may become difficult to control or operate. Take your vehicle to an authorized HYUNDAI dealer and have the system checked as soon as possible.

#### Information

The following symptoms may occur during normal vehicle operation:

- The steering effort may be high immediately after placing the ignition switch or the Engine Start/Stop button in the ON position.

This happens as the system performs the EPS system diagnostics. When the diagnostics is completed, the steering wheel will return to its normal condition.

(Continued)

(Continued)

- A click noise may be heard from the EPS relay after the ignition switch is placed to the ON or LOCK/OFF position (Without Smart key system).

A click noise may be heard from the EPS relay after the Engine Start/Stop button is in the ON or OFF position. (With Smart key system)

- Motor noise may be heard when the vehicle is at a stop or at a low driving speed.
- When you operate the steering wheel in low temperature, the steering effort may be high and abnormal noise may occur. If temperature rises, the noise will disappear. This is a normal condition.
- When the vehicle is stationary, if you turn the steering wheel all the way to the left or right continuously, the steering wheel effort increases. This is not a system malfunction. As time passes, the steering wheel effort will return to its normal condition.

## Tilt steering / Telescope steering (if equipped)

### WARNING

Never adjust the steering wheel while driving. You may lose steering control and cause severe personal injury, death or accidents.

### Information

After adjustment, sometimes the lock-release lever may not lock the steering wheel.

It is not a malfunction. This occurs when two gears are not engaged correctly. In this case, adjust the steering wheel again and then lock the steering wheel.



OTL045010

Pull down the lock-release lever (1) on the steering wheel column and adjust the steering wheel angle (2) and position (3). Move the steering wheel, so it points toward your chest, not toward your face. Make sure you can see the instrument panel warning lights and gauges.

After adjusting, pull up the lock-release lever (1) to lock the steering wheel in place. Push the steering wheel both up and down to be certain it is locked in position. Always adjust the position of the steering wheel before driving.

### Heated steering wheel (if equipped)

■ Type A

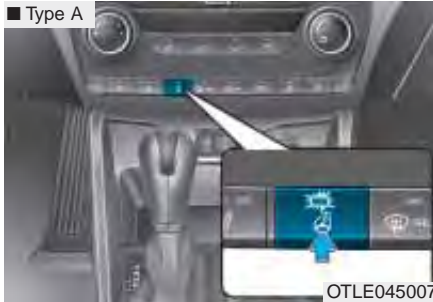

■ Type B

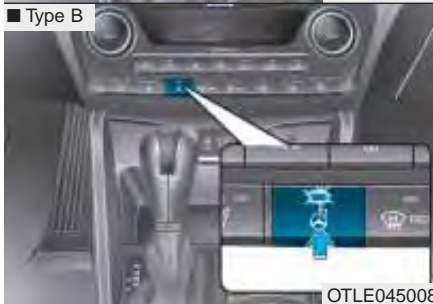

When the ignition switch is in the ON position or when the engine is running, press the heated steering wheel button to warm the steering wheel. The indicator on the button will illuminate.

To turn the heated steering wheel off, press the button again. The indicator on the button will turn off.

#### **i** Information

The heated steering wheel will turn off automatically approximately 30 minutes after the heated steering wheel is turned on.

When the engine is turned off during the engine and the heated steering wheel is on, the timer function of heated steering wheel will be reset.

To reuse heated steering wheel, press button again.

#### **NOTICE**

Do not install any cover or accessory on the steering wheel. This cover or accessory could cause damage to the heated steering wheel system.

### Horn



To sound the horn, press the area indicated by the horn symbol on your steering wheel (see illustration). The horn will operate only when this area is pressed.

#### **NOTICE**

Do not strike the horn severely to operate it, or hit it with your fist. Do not press on the horn with a sharp-pointed object.

## MIRRORS

### Inside rearview mirror

Before you start driving, adjust the rearview mirror to the center on the view through the rear window.

#### WARNING

Make sure your line of sight is not obstructed. Do not place objects in the rear seat, cargo area, or behind the rear headrests which could interfere with your vision through the rear window.

#### WARNING

To prevent serious injury during an accident or deployment of the air bag, do not modify the rearview mirror and do not install a wide mirror.

#### WARNING

NEVER adjust the mirror while driving. This may cause loss of vehicle control resulting in an accident.

#### NOTICE

When cleaning the mirror, use a paper towel or similar material dampened with glass cleaner. Do not spray glass cleaner directly on the mirror as that may cause the liquid cleaner to enter the mirror housing.

### **Day/night rearview mirror (if equipped)**



Make this adjustment before you start driving and while the day/night lever is in the day position.

Pull the day/night lever toward you to reduce glare from the headlights of the vehicles behind you during night driving.

*Remember that you lose some rearview clarity in the night position.*

### **Electric Chromic Mirror (ECM) (if equipped)**

The electric rearview mirror automatically controls the glare from the headlamp of the car behind you in nighttime or low light driving conditions.

When the engine is running, the glare is automatically controlled by the sensor mounted in the rearview mirror. The sensor detects the light level around the vehicle, and automatically adjusts to control the headlamp glare from vehicles behind you.

Whenever the shift lever is placed in R (Reverse), the mirror will automatically go to the brightest setting in order to improve the drivers view behind the vehicle.

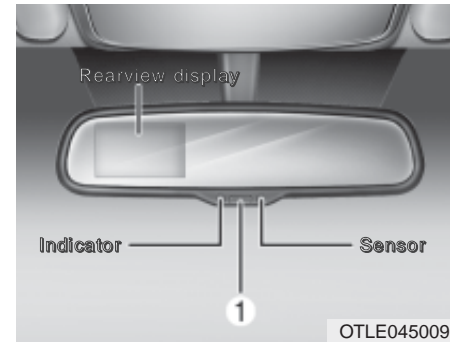

### **To operate the electric rearview mirror:**

- Press the ON/OFF button (1) to turn the automatic dimming function off. The mirror indicator light will turn off.

Press the ON/OFF button (1) to turn the automatic dimming function on. The mirror indicator light will illuminate.

- The mirror defaults to the ON position whenever the ignition switch or the Engine Start/Stop button is in the ON position.



**Electric chromic mirror (ECM) with compass (if equipped)**

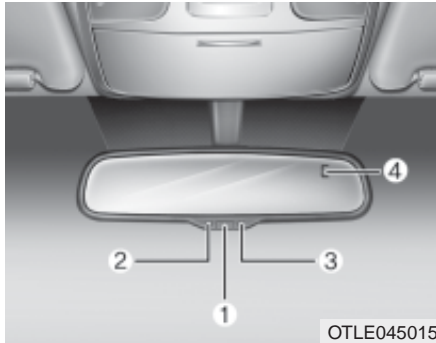

1. Feature Control Button
2. Status Indicator LED
3. Rear Light Sensor
4. Display Window

Automatic dimming rear view mirror controls automatically the glare of headlights of the vehicle behind you when it turned on by pressing and holding the button for more than 3 but less than 6 seconds. It is turned off by pressing and holding the button for same time once more.

**1. To operate Compass feature**

Press and release the compass button, then the vehicle's directional heading will be displayed. Pressing and releasing the button again will turn off the display.

Heading display

- E : East
- W : West
- S : South
- N : North
- ex) NE : North East

### Outside rearview mirror



Be sure to adjust mirror angles before driving.

Your vehicle is equipped with both left-hand and right-hand outside rearview mirrors.

The mirror can be adjusted remotely with the remote switch.

The mirror heads can be folded to prevent damage during an automatic car wash or when passing through a narrow street.

#### WARNING

- The right outside rearview mirror is convex. In some countries, the left outside rearview mirror is also convex. Objects seen in the mirror are closer than they appear.
- Use your interior rearview mirror or turn your head and look to determine the actual distance of following vehicles when changing lanes.

#### WARNING

**Do not adjust or fold the outside rearview mirrors while driving. This may cause loss of vehicle control resulting in an accident.**

#### CAUTION

- Do not scrape ice off the mirror face; this may damage the surface of the glass.
- If the mirror is jammed with ice, do not adjust the mirror by force. Use an approved spray de-icer (not radiator antifreeze) spray, or a sponge or soft cloth with very warm water, or move the vehicle to a warm place and allow the ice to melt.



2. Use the mirror adjustment control (2) to position the selected mirror up, down, left or right.
3. After adjustment, put the button into neutral (center) position to prevent inadvertent adjustment.

**NOTICE**

- The mirrors stop moving when they reach the maximum adjusting angles, but the motor continues to operate while the switch is pressed. Do not press the switch longer than necessary, the motor may be damaged.
- Do not attempt to adjust the outside rearview mirror by hand or the motor may be damaged.

**Folding the outside rearview mirror**

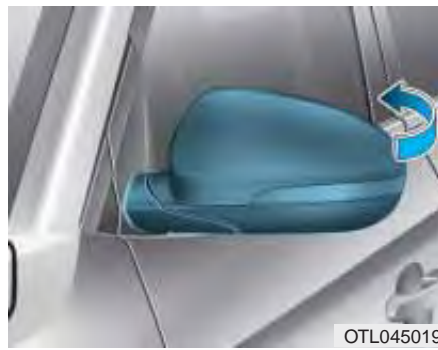

**Manual type**

To fold the outside rearview mirror, grasp the housing of the mirror and then fold it toward the rear of the vehicle.

Adjusting the rearview mirrors:

1. Press either the L (Front left side) or R (Front right side) button (1) to select the rearview mirror you would like to adjust.

### ■ Left-hand drive



### ■ Right-hand drive



### Electric type (if equipped)

Left-hand drive

**Left** : The mirror will unfold.

**Right** : The mirror will fold.

Right-hand drive

**Left** : The mirror will fold.

**Right** : The mirror will unfold.

### Center (AUTO) :

The mirror will fold or unfold automatically as follows:

- Without smart key system
  - The mirror will fold or unfold when the door is locked or unlocked by the transmitter. (if equipped)
- With smart key system
  - The mirror will fold or unfold when the door is locked or unlocked by the smart key.
  - The mirror will fold or unfold when the door is locked or unlocked by the button on the outside door handle.
  - The mirror will unfold when you approach the vehicle (all doors closed and locked) with a smart key in possession. (if equipped)

### NOTICE

The electric type outside rearview mirror operates even though the ignition switch is in the OFF position. However, to prevent unnecessary battery discharge, do not adjust the mirrors longer than necessary while the engine is not running.

### NOTICE

Do not fold the electric type outside rearview mirror by hand. It could cause motor failure.

## WINDOWS

### Power windows

■ Left-hand drive

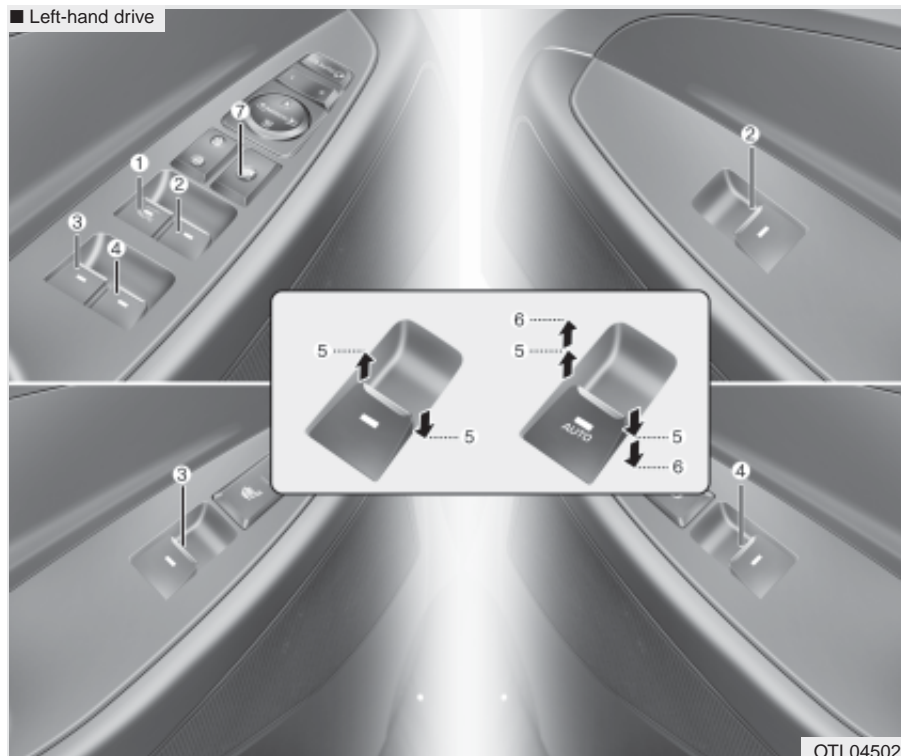

OTL045023

- (1) Driver's door power window switch
- (2) Front passenger's door power window switch
- (3) Rear door (left) power window switch
- (4) Rear door (right) power window switch
- (5) Window opening and closing
- (6) Automatic power window\*
- (7) Power window lock switch

\* : if equipped

## Convenient features of your vehicle

■ Right-hand drive

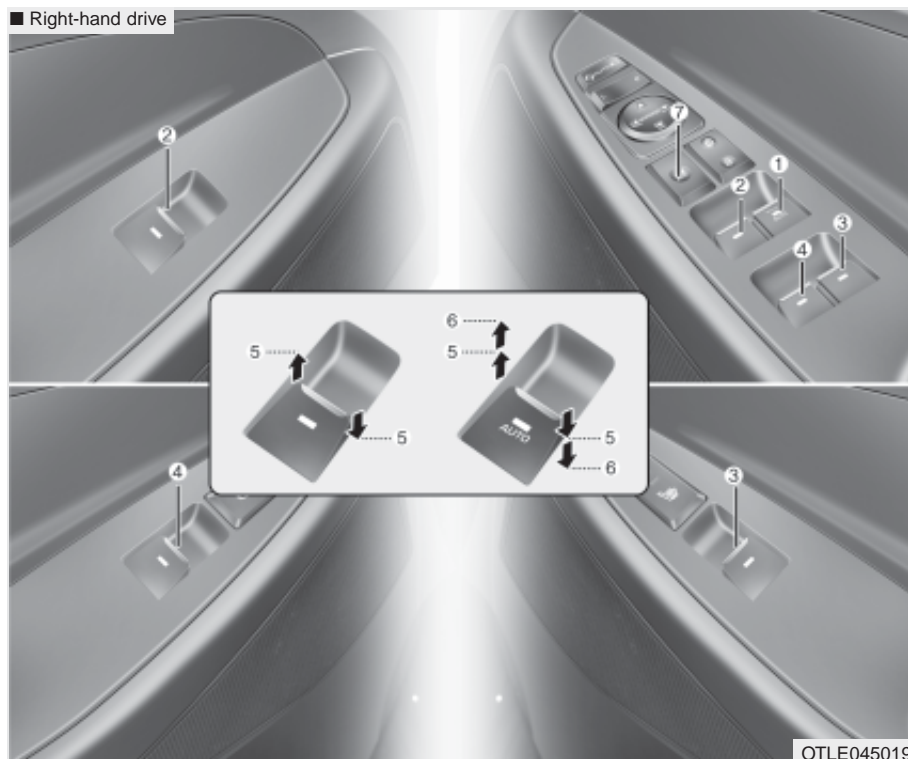

- (1) Driver's door power window switch
- (2) Front passenger's door power window switch
- (3) Rear door (right) power window switch
- (4) Rear door (left) power window switch
- (5) Window opening and closing
- (6) Automatic power window\*
- (7) Power window lock switch

\* : if equipped

OTLE045019

The ignition switch must be in the ON position to be able to raise or lower the windows. Each door has a Power Window switch to control that door's window. The driver has a Power Window Lock switch which can block the operation of passenger windows. The power windows will operate for approximately 30 seconds after the ignition switch is placed in the ACC or OFF position. However, if the front doors are opened, the Power Windows cannot be operated even within the 30 second period.

**⚠ WARNING**

To avoid serious injury or death, do not extend your head, arms or body outside the windows while driving.

**i Information**

- In cold and wet climates, power windows may not work properly due to freezing conditions.
- While driving with the rear windows down or with the sunroof (if equipped) opened (or partially opened), your vehicle may demonstrate a wind buffeting or pulsation noise. This noise is normal and can be reduced or eliminated by taking the following actions. If the noise occurs with one or both of the rear windows down, partially lower both front windows approximately 2.5 cm (1 inch). If you experience the noise with the sunroof open, slightly close the sunroof.

**Window opening and closing**

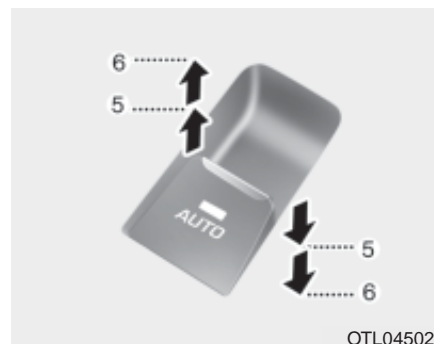

OTL045024

To open:

Press the window switch down to the first detent position (5). Release the switch when you want the window to stop.

To close:

Pull the window switch up to the first detent position (5). Release the window switch when you want the window to stop.

### ***Auto up/down window (if equipped)***

Pressing or pulling up the power window switch momentarily to the second detent position (6) completely lowers or lifts the window even when the switch is released. To stop the window at the desired position while the window is in operation, pull up or press down and release the switch.

### ***To reset the power windows***

If the power windows do not operate normally, the automatic power window system must be reset as follows:

1. Place the ignition switch to the ON position.
2. Close the window and continue pulling up on the power window switch for at least one second.

If the power windows do not operate properly after resetting, it is recommended that the system be checked by an authorized HYUNDAI dealer.

### ***Automatic reversal (if equipped)***



If a window senses any obstacle while it is closing automatically, it will stop and lower approximately 30 cm (12 inches) to allow the object to be cleared.

If the window detects the resistance while the power window switch is pulled up continuously, the window will stop upward movement then lower approximately 2.5 cm (1 inch).

If the power window switch is pulled up continuously again within 5 seconds after the window is lowered by the automatic window reversal feature, the automatic window reversal will not operate.



## **i** Information

The automatic reverse feature is only active when the “Auto Up” feature is used by fully pulling up the switch to the second detent.

### **⚠ WARNING**

Make sure body parts or other objects are safely out of the way before closing the windows to avoid injuries or vehicle damage.

Objects less than 4 mm (0.16 inch) in diameter caught between the window glass and the upper window channel may not be detected by the automatic reverse window and the window will not stop and reverse direction.

## **Power window lock switch**

■ Left-hand drive



■ Right-hand drive



The driver can disable the power window switches on the rear passengers' doors by pressing the power window lock switch.

When the power window lock switch is pressed:

- The driver's master control can operate all the power windows.
- The front passenger's control can operate the front passenger's power window.
- The rear passenger's control cannot operate the rear passengers' power window.

### **⚠ WARNING**

Do not allow children to play with the power windows. Keep the driver's door power window lock switch in the LOCK position. Serious injury or death can result from unintentional window operation by a child.

### NOTICE

- To prevent possible damage to the power window system, do not open or close two windows or more at the same time. This will also ensure the longevity of the fuse.
- Never try to operate the main switch on the driver's door and the individual door window switch in opposite directions at the same time. If this is done, the window will stop and cannot be opened or closed.

### WARNING

- NEVER leave the keys in your vehicle with unsupervised children, when the engine is running.
- NEVER leave any child unattended in the vehicle. Even very young children may inadvertently cause the vehicle to move, entangle themselves in the windows, or otherwise injure themselves or others.
- Always double check to make sure all arms, hands, head and other obstructions are safely out of the way before closing a window.

(Continued)

(Continued)

- Do not allow children to play with the power windows. Keep the driver's door power window lock switch in the LOCK position (pressed). Serious injury can result from unintentional window operation by the child.
- Do not extend your head, arms or body outside the windows while driving.

## PANORAMA SUNROOF (IF EQUIPPED)



If your vehicle is equipped with a sunroof, you can slide or tilt your sunroof with the sunroof control lever located on the overhead console.

The ignition switch must be in the ON position before you can open or close the sunroof.

### **i** Information

- In cold and wet climates, the sunroof may not work properly due to freezing conditions.
- After washing the car or after there is rain, be sure to wipe off any water that is on the sunroof before operating it.

### **NOTICE**

- Do not continue to move the sunroof control lever after the sunroof is fully opened, closed, or tilted. Damage to the motor or system components could occur.
- Make sure the sunroof is closed fully when leaving your vehicle. If the sunroof is open, rain or snow may leak through the sunroof and wet the interior as well as cause theft.

### **WARNING**

- Make sure heads, other body parts or objects are out of the way before using the sunroof.
- Do not leave the engine running and the key in your vehicle with unsupervised children.

Unattended children could operate the sunroof, which could result in serious injury.

### **WARNING**

Never adjust the sunroof or sunshade while driving. This could result in loss of control and an accident that may cause death, serious injury, or property damage.

### Sunshade



- To open the sunshade, pull the sunroof control lever backward (1) to the first detent position.
- To close the sunshade when the sunroof glass is closed, push the sunroof control lever forward (2).

To stop the sliding at any point, pull or push the sunroof control lever momentarily.

### Sliding the sunroof

*When the sunshade is closed*



If you pull the sunroof control lever backward, the sunshade will slide all the way open then the sunroof glass will slide all the way open. To stop the sunroof movement at any point, pull or push the sunroof control lever momentarily.

*When the sunshade is opened*

If you pull the sunroof control lever backward, the sunroof glass will slide all the way open. To stop the sunroof movement at any point, pull or push the sunroof control lever momentarily.

### **i** Information

**Only the front glass of the panorama sunroof opens and closes.**

## Tilting the sunroof

### *When the sunshade is closed*



OTL045029

If you push the sunroof control lever upward, the sunshade will slide open then the sunroof glass will tilt.

To stop the sunroof movement at any point, pull or push the sunroof control lever momentarily.

### *When the sunshade is opened*

If you push the sunroof control lever upward, the sunroof glass will tilt.

To stop the sunroof movement at any point, pull or push the sunroof control lever momentarily.

## Closing the sunroof



OTL045030

### *To close the sunroof glass only*

Push the sunroof control lever forward to the first detent position or pull the lever downward.

### *To close the sunroof glass with the sunshade*

Push the sunroof control lever forward to the second detent position. The sunroof glass will close then the sunshade close automatically.

To stop the sunroof movement at any point, pull or push the sunroof control lever momentarily.

### Automatic reversal

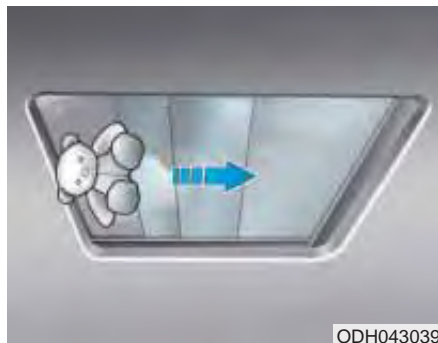

If an object or part of the body is detected while the sunroof glass or sunshade is closing automatically, it will reverse the direction, and then stop.

The auto reverse function does not work if a tiny obstacle is between the sliding glass or sunshade and the sunroof sash. You should always check that all passengers and objects are away from the sunroof before closing it.

### WARNING

- Make sure heads, other body parts or other objects are safely out of the way before closing the sunroof to avoid injuries or vehicle damage.
- To avoid serious injury or death, do not extend your head, arms or body outside the sunroof while driving.
- A panorama sunroof is made of glass, therefore it may break in an accident. If you do not have your seat belt on, you may stick out of the broken glass and get injured or killed. For all passengers safety, have an appropriate protection on (ex. seat belt, child restraint system, etc.).

### NOTICE

- Periodically remove any dirt that may accumulate on the sunroof guide rail or between the sunroof and roof panel, which can make a noise.
- Do not try to open the sunroof when the temperature is below freezing or when the sunroof is covered with snow or ice, the motor could be damaged. In cold and wet climates, the sunroof may not work properly.

### Information

After the vehicle is washed or in a rainstorm, be sure to wipe off any water that is on the sunroof before operating it.

## Resetting the sunroof



Sunroof needs to be reset if (in the followings)

- Battery is discharged or disconnected or the related fuse has been replaced or disconnected
- The one-touch sliding function of the sunroof does not normally operate

1. Turn the engine on and close the sunroof glass and sunshade completely.
2. Release the control lever.

3. Push the sunroof control lever forward in the direction of close (about 10 seconds) until the sunroof slightly moves. Then, release the lever.

4. Push the sunroof control lever forward in the direction of close until the sunroof operates as follows:

Sunshade Open → Glass Tilt Open  
→ Glass Slide Open → Glass Slide  
Close → Sunshade Close

Then, release the control lever.

When this is complete, the sunroof system is reset.

For more details, contact an authorized HYUNDAI dealer.

### Information

**If you do not reset the sunroof, it may not work properly.**

## Sunroof open warning (if equipped)



If the driver removes the ignition key (Smart key : turns off the engine) and opens the driver-side door when the sunroof is not fully closed, the warning chime will sound for approximately 3 seconds and sunroof open image will appear on the LCD display.

Close the sunroof securely when leaving your vehicle.

## EXTERIOR FEATURES

### Hood

#### Opening the hood

■ Left-hand drive



■ Right-hand drive



1. Park the vehicle and set the parking brake.
2. Pull the release lever to unlatch the hood. The hood should pop open slightly.



3. Go to the front of the vehicle, raise the hood slightly, push up the secondary latch (1) inside of the hood center and lift the hood (2).



4. Pull out the stay rod.
5. Hold the hood opened with the stay rod (1).

#### WARNING

- Grasp the stay rod in the area wrapped in rubber. The rubber will help prevent you from being burned by hot metal when the engine is hot.
- The stay rod must be inserted completely into the hole provided whenever you inspect the engine compartment. This will prevent the hood from falling and possibly injuring you.



### ***Closing the hood***

1. Before closing the hood, check the following:
  - All filler caps in engine compartment must be correctly installed.
  - Gloves, rags or any other combustible material must be removed from the engine compartment.
2. Return the stay rod to its clip to prevent it from rattling.
3. Lower the hood halfway (lifted approximately 30cm from the closed position) and push down to securely lock in place. Then double check to be sure the hood is secure.

 **WARNING**

**Always double check to be sure that the hood is firmly latched before driving away. Check there is no hood open warning light or message displayed on the instrument cluster. If the hood is not latched while the vehicle is moving, the chime will sound to warn the driver the hood is not fully latched. Driving with the hood opened may cause a total loss of visibility, which might result in an accident.**

 **WARNING**

- Before closing the hood, ensure that all obstructions are removed from the hood opening. Closing the hood with an obstruction present in the hood opening may result in property damage or severe personal injury.
- Do not leave gloves, rags or any other combustible material in the engine compartment. Doing so may cause a heat-induced fire.
- Do not move the vehicle with the hood raised. The view will be blocked and the hood could fall or be damaged.

### Fuel filler door

#### Opening the fuel filler door



The fuel filler door must be opened from inside the vehicle by pulling up on the fuel-filler door opener.

1. Turn the engine off.
2. To open the fuel filler door, pull the fuel filler door opener up.



3. Pull the fuel filler door (1) out to fully open.
4. To remove the fuel tank cap (2), turn it counterclockwise. You may hear a hissing noise as the pressure inside the tank equalizes.
5. Place the cap on the fuel filler door.

#### **i** Information

If the fuel filler door does not open because ice has formed around it, tap lightly or push on the door to break the ice and release the door. Do not pry on the door. If necessary, spray around the door with an approved de-icer fluid (do not use radiator anti-freeze) or move the vehicle to a warm place and allow the ice to melt.

- Use only approved portable plastic fuel containers designed to carry and store gasoline.
- Do not use matches or a lighter and do not smoke or leave a lit cigarette in your vehicle while at a gas station, especially during refueling.
- Do not over-fill or top-off your vehicle tank, which can cause gasoline spillage.
- If a fire breaks out during refueling, leave the vicinity of the vehicle, and immediately contact the manager of the gas station and then contact the local fire department. Follow any safety instructions they provide.

(Continued)

(Continued)

- If pressurized fuel sprays out, it can cover your clothes or skin and thus subject you to the risk of fire and burns. Always remove the fuel cap carefully and slowly. If the cap is venting fuel or if you hear a hissing sound, wait until the condition stops before completely removing the cap.
- Always check that the fuel cap is installed securely to prevent fuel spillage in the event of an accident.

### **i** Information

Make sure to refuel your vehicle according to the "Fuel Requirements" suggested in the Introduction chapter.

#### **NOTICE**

- Do not spill fuel on the exterior surfaces of the vehicle. Any type of fuel spilled on painted surfaces may damage the paint.
- If the fuel filler cap requires replacement, use only a genuine HYUNDAI cap or the equivalent specified for your vehicle. An incorrect fuel filler cap can result in a serious malfunction of the fuel system or emission control system.

## TAILGATE

### Non-power tailgate

#### Opening the tailgate



- The tailgate is locked or unlocked when all doors are locked or unlocked with the key, transmitter, smart key or central door lock/unlock switch.
- Only the tailgate is unlocked if the tailgate unlock button on the transmitter or smart key is pressed for approximately 1 second.
- If unlocked, the tailgate can be opened by pressing the handle and pulling it up.

- Once the tailgate is opened and then closed, the tailgate locks automatically. (All doors must be locked.)

#### **i** Information

In cold and wet climates, door lock and door mechanisms may not work properly due to freezing conditions.

#### **⚠** WARNING

The tailgate swings upward. Make sure no objects or people are near the rear of the vehicle when opening the tailgate.

#### **⚠** CAUTION

Make certain that you close the tailgate before driving your vehicle. Possible damage may occur to the tailgate lift cylinders and attaching hardware if the tailgate is not closed prior to driving.

#### Closing the tailgate



Lower and push down the tailgate firmly. Make sure that the tailgate is securely latched.

#### **⚠** WARNING

Make sure your hands, feet and other parts of your body are safely out of the way before closing the tailgate.

**⚠ CAUTION**

Make sure nothing is near the tailgate latch and striker while closing the tailgate. It may damage the tailgate's latch.

**⚠ WARNING**

**Exhaust fumes**

If you drive with the tailgate opened, you will draw dangerous exhaust fumes into your vehicle which can cause serious injury or death to vehicle occupants.

If you must drive with the tailgate opened, keep the air vents and all windows open so that additional outside air comes into the vehicle.

**⚠ WARNING**

**Rear cargo area**

Occupants should never ride in the rear cargo area where no restraints are available. To avoid injury in the event of an accident or sudden stops, occupants should always be properly restrained.

***Emergency tailgate safety release***

Your vehicle is equipped with the



emergency tailgate safety release lever located on the bottom of the tailgate. When someone is inadvertently locked in the luggage compartment. The tailgate can be opened by doing as follows:

1. Remove the cover.
2. Push the release lever to the right.
3. Push up the tailgate.

## WARNING

- For emergencies, be fully aware of the location of the emergency tailgate safety release lever in the vehicle and how to open the tailgate if you are accidentally locked in the luggage compartment.
- No one should be allowed to occupy the luggage compartment of the vehicle at any time. The luggage compartment is a very dangerous location in the event of a crash.
- Use the release lever for emergencies only. Use with extreme caution, especially while the vehicle is in motion.

## Power tailgate (if equipped)

### Power tailgate button

■ Left-hand drive



■ Right-hand drive



If ignition switch is ON position, the power tailgate can operate when the automatic shift lever is in P (Park) or manual shift lever is in N (Neutral).

To activate or de-activate the power tailgate, go to User Setting Mode and select the Power Tailgate on the LCD display.

For more details, refer to “LCD Display” in this chapter.

■ Power tailgate handle switch

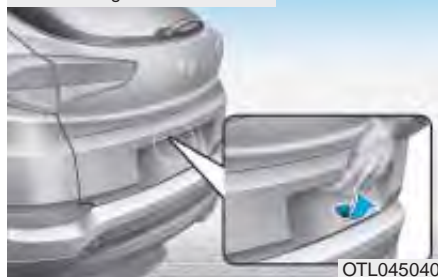

OTL045040

■ Power tailgate inner switch



OTL045041

### WARNING

Never leave children or animals unattended in your vehicle. Children or animals might operate the power tailgate that could result in injury to themselves or others, or damage the vehicle.

### WARNING

Make sure there are no people or objects around the tailgate before operating the power tailgate. Wait until the tailgate is opened fully and stopped before loading or unloading cargo or passengers from the vehicle.

### CAUTION

Do not close or open the power tailgate manually. This may cause damage to the power tailgate. If it is necessary to close or open the power tailgate manually when the battery is discharged or disconnected, do not apply excessive force.

## Opening the tailgate

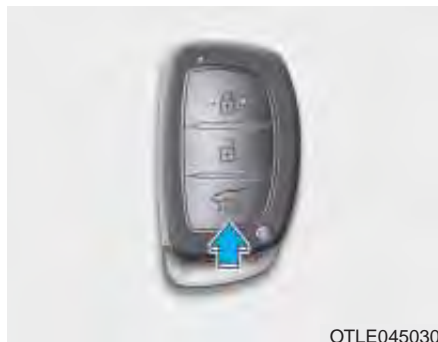

The power tailgate will open automatically by doing one of the following:

- Press the tailgate unlock button on the transmitter or smart key for approximately one second.



- Press the power tailgate button for approximately one second.

For emergency stop while operating, press the power tailgate button shortly.



- Press the tailgate handle switch carrying the smart key with you.



### Closing the tailgate

■ Left-hand drive



■ Right-hand drive



- Press the power tailgate button for approximately one second when the tailgate is opened.

The tailgate will close and lock automatically.

For emergency stop while operating, press the power tailgate button shortly.



- Press the power tailgate inner switch for approximately one second when the tailgate is opened. The tailgate will close and lock automatically.

### **Power tailgate non-opening conditions**

The tailgate does not open when the vehicle is in motion.

#### **⚠ WARNING**

The chime will sound if you drive with the tailgate opened. Stop your vehicle immediately at a safe place and check if your tailgate is opened.

#### **⚠ CAUTION**

Operating the power tailgate more than 5 times continuously could cause damages to the operating motor. In this case, the system enters into a thermal protection mode. In thermal protection mode, the power tailgate can not operate and the chime will sound for 3 times by any switch inputs. Leave your power tailgate system for rest about 1 minute and then operate.

#### **i Information**

- The power tailgate can be operated when the engine is not running. However the power tailgate operation consumes large amounts of vehicle electric power. To prevent the battery from being discharged, do not operate it excessively. (e.g.: more than approximately 10 times repeatedly.)
- To prevent the battery from being discharged, do not leave the power tailgate in the open position for a long time.
- Do not modify or repair any part of the power tailgate by yourself. We recommend that you contact an authorized HYUNDAI dealer.
- When jacking up the vehicle to change a tire or repair the vehicle, do not operate the power tailgate. This could cause the power tailgate to operate improperly.
- In cold and wet climates, the power tailgate may not work properly due to freezing conditions.

### **Automatic reversal**



During power opening and closing if the power tailgate is blocked by an object or part of the body, the power tailgate will detect the resistance.

- If the resistance is detected while opening the tailgate, it will stop and move in the opposite direction.
- If the resistance is detected while closing the tailgate, it will stop and move in the opposite direction.

However, if the resistance is weak such as from an object that is thin or soft, or the tailgate is near the latched position, the automatic stop and reversal may not detect the resistance.

If the automatic reversal feature operates continuously more than twice during opening or closing operation, the power tailgate may stop at that position. At this time, close the tailgate manually and operate the tailgate automatically again.

### WARNING

**Never intentionally place any object or part of your body in the path of the power tailgate to make sure the automatic reversal operates.**

### CAUTION

**Do not put heavy stuffs on the power tailgate before you operate the power tailgate.  
Additional weight on tailgate could cause damages to the system.**

### ***How to reset the power tailgate***

If the battery has been discharged or disconnected, or if the related fuse has been replaced or disconnected, for the power tailgate to operate normally, reset the power tailgate as follow:

1. Automatic Transaxle / Dual Clutch Transmission :  
Put the shifte lever is in P (Park).  
Manual Transaxle :  
Put the shifte lever is in N (Neutral).
2. While Pressing the power tailgate inner switch, press the tailgate handle switch for more than 3 seconds. (the chime will sound)
3. Close the tailgate manually.

If the power tailgate does not work properly after the above procedure, we recommend that the system be checked by an authorized HYUNDAI dealer.

### Information

**If the power tailgate does not operate normally, check again if the gear position is in right position.**

### Power tailgate opening height user setting



The driver may set the height of a fully opened tailgate by following the below instruction.

1. Position the tailgate manually to the height you prefer.
2. Press the power tailgate inner switch for more than 3 seconds.
3. Close the tailgate manually after hearing the buzzer sound.

The tailgate will open to the height the driver has set up.

### WARNING

#### Exhaust fumes

If you drive with the tailgate opened, you will draw dangerous exhaust fumes into your vehicle which can cause serious injury or death to vehicle occupants.

If you must drive with the tailgate opened, keep the air vents and all windows open so that additional outside air comes into the vehicle.

### WARNING

#### Rear cargo area

**Occupants should never ride in the rear cargo area where no restraints are available. To avoid injury in the event of an accident or sudden stops, occupants should always be properly restrained.**

### Emergency tailgate safety release

Your vehicle is equipped with the



emergency tailgate safety release lever located on the bottom of the tailgate. When someone is inadvertently locked in the luggage compartment, the tailgate can be opened by doing as follows:

1. Remove the cover.
2. Push the release lever to the right.
3. Push up the tailgate.

### WARNING

- For emergencies, be fully aware of the location of the emergency tailgate safety release lever in the vehicle and how to open the tailgate if you are accidentally locked in the luggage compartment.
- No one should be allowed to occupy the luggage compartment of the vehicle at any time. The luggage compartment is a very dangerous location in the event of a crash.
- Use the release lever for emergencies only. Use with extreme caution, especially while the vehicle is in motion.

### Smart tailgate (if equipped)



On the vehicle equipped with a smart key, the tailgate can be opened with no-touch activation using the Smart tailgate system.

### *How to use the Smart Tailgate*

The tailgate can be opened with no-touch activation satisfying all the conditions below.

- After 15 seconds when all doors are closed and locked
- Positioned in the detecting area for more than 3 seconds.

### Information

- The Smart Tailgate does not operate when:
  - The smart key is detected within 15 seconds after the doors are closed and locked, and is continuously detected.
  - The smart key is detected within 15 seconds after the doors are closed and locked, and 1.5 m (60 in.) from the front door handles. (for vehicles equipped with Welcome Light)
  - A door is not locked or closed.
  - The smart key is in the vehicle.

## 1. Setting

To activate the Smart Tailgate, go to User Settings Mode and select Smart Tailgate on the LCD display.

※ For more details, refer to "LCD Display" in this chapter.



## 2. Detect and Alert

If you are positioned in the detecting area (50 ~100 cm (20 ~ 40 in.) behind the vehicle) carrying a smart key, the hazard warning lights will blink and chime will sound for about 3 seconds to alert you the smart key has been detected and the tailgate will open.

### **i** Information

**Do not approach the detecting area if you do not want the tailgate to open. If you have unintentionally entered the detecting area and the hazard warning lights and chime starts to operate, leave the detecting area with the smart key. The tailgate will stay closed.**



## 3. Automatic opening

The hazard warning lights will blink and chime will sound 2 times and then the tailgate will slowly open.

**⚠ WARNING**

- Make certain that you close the tailgate before driving your vehicle.
- Make sure there are no people or objects around the tailgate before opening or closing the tailgate.
- Make sure objects in the rear cargo area do not come out when opening the tailgate on the slope way. It may cause serious injury.
- Make sure to deactivate the Smart tailgate function when washing your vehicle. Otherwise, the tailgate may open inadvertently.
- The key should be kept out of reach of children. Children may inadvertently open the Smart Tailgate while playing around the rear area of the vehicle.

*How to deactivate the Smart Tailgate function using the smart key*



1. Door lock
2. Door unlock
3. Tailgate open

If you press any button of the smart key during the Detect and Alert stage, the Smart Tailgate function will be deactivated.

Make sure to be aware of how to deactivate the Smart Tailgate function for emergency situations.

**i Information**

- If you press the door unlock button (2), the Smart Tailgate function will be deactivated temporarily. But, if you do not open any door for 30 seconds, the Smart Tailgate function will be activated again.
- If you press the tailgate open button (3) for more than 1 second, the tailgate opens.
- If you press the door lock button (1) or tailgate open button (3) when the Smart Tailgate function is not in the Detect and Alert stage, the Smart Tailgate function will not be deactivated.
- In case you have deactivated the Smart Tailgate function by pressing the smart key button and opened a door, the Smart Tailgate function can be activated again by closing and locking all doors.



### Detecting area



- The Smart Tailgate operates with a welcome alert if the smart key is detected within 50 ~ 100 cm (20 ~ 40 in.) from the tailgate.
- The alert stops at once if the smart key is positioned outside the detecting area during the Detect and Alert stage.

### **i** Information

- The Smart Tailgate function will not work if any of the following occurs:
  - The smart key is close to a radio transmitter such as a radio station or an airport which can interfere with normal operation of the transmitter.
  - The smart key is near a mobile two way radio system or a cellular phone.
  - Another vehicle's smart key is being operated close to your vehicle.
- The detecting range may decrease or increase when :
  - One side of the tire is raised to replace a tire or to inspect the vehicle.
  - The vehicle is slantingly parked on a slope or unpaved road, etc.



## INSTRUMENT CLUSTER

### ■ Type A

- Gasoline engine



### ■ Type B (If equipped)

- Gasoline engine

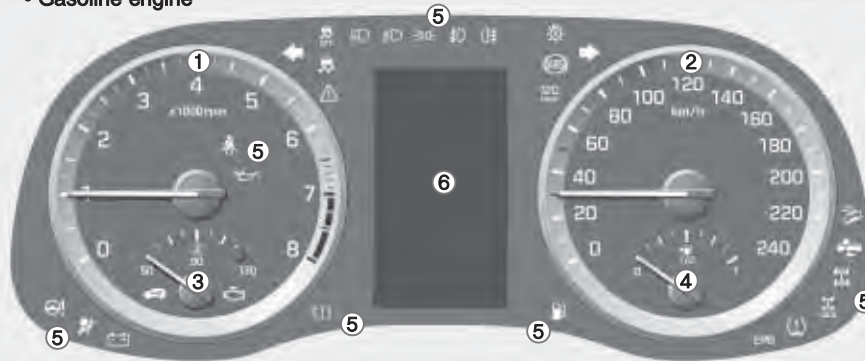

1. Tachometer
2. Speedometer
3. Engine coolant temperature gauge
4. Fuel gauge
5. Warning and indicator lights
6. LCD display (including Trip computer)

※ The actual cluster in the vehicle may differ from the illustration.  
For more details, refer to the "Gauges" in this chapter.

OTLE047100/OTLE047101

■ Type A  
• Diesel engine



■ Type B  
• Diesel engine

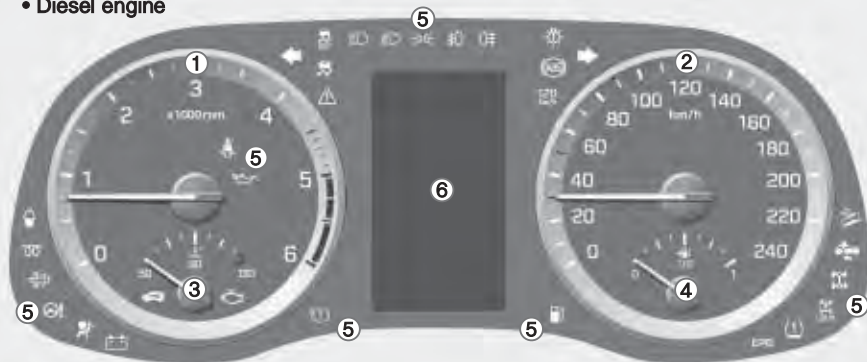

1. Tachometer
2. Speedometer
3. Engine coolant temperature gauge
4. Fuel gauge
5. Warning and indicator lights
6. LCD display (including Trip computer)

\* The actual cluster in the vehicle may differ from the illustration.  
For more details, refer to the "Gauges" in this chapter.

OTLE047100L/OTLE047101L

### Instrument cluster control

#### Instrument panel illumination



When the vehicle's parking lights or headlights are on, press the illumination control button to adjust the brightness of the instrument panel illumination.

When pressing the illumination control button, the interior switch illumination intensity is also adjusted.

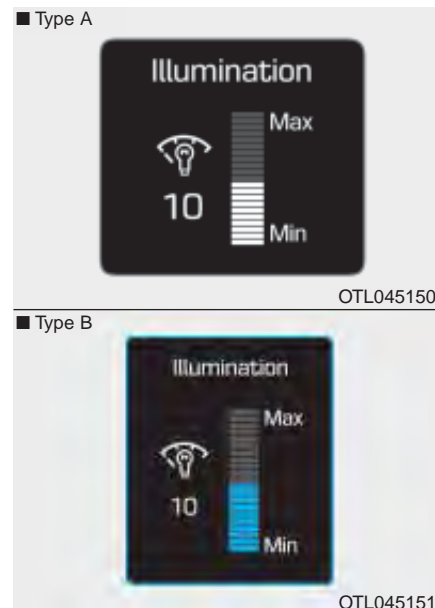
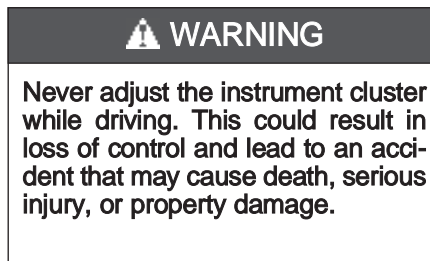

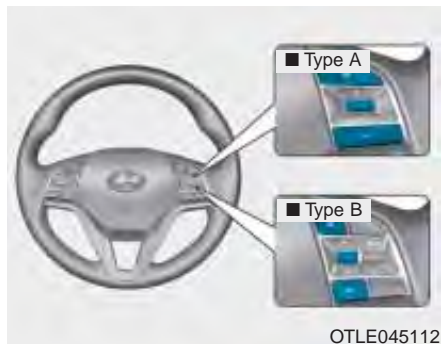

- The brightness of the instrument panel illumination is displayed.
- If the brightness reaches to the maximum or minimum level, an alarm will sound.

## LCD display control



The LCD display modes can be changed by using the control buttons.

- (1)  : MODE button for changing modes
- (2)  : MOVE switch for changing items
- (3) OK : SELECT/RESET button for setting or resetting the selected item

For the LCD modes, refer to “LCD Display” in this chapter.

## Gauges

### Speedometer

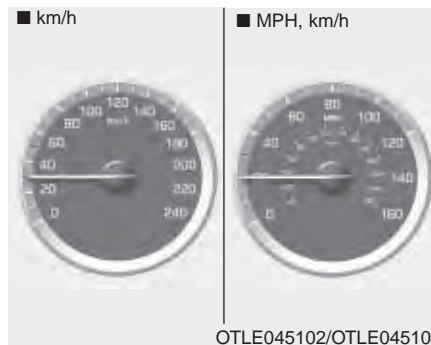

The speedometer indicates the speed of the vehicle and is calibrated in miles per hour (MPH) and/or kilometers per hour (km/h).

### Tachometer

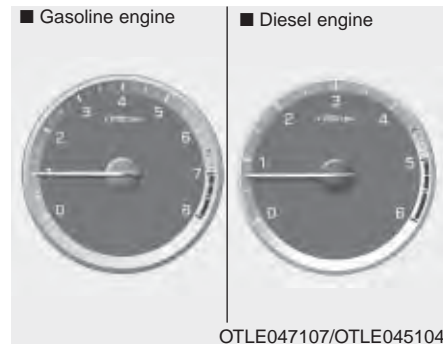

The tachometer indicates the approximate number of engine revolutions per minute (rpm).

Use the tachometer to select the correct shift points and to prevent lugging and/or over-revving the engine.

#### NOTICE

**Do not operate the engine within the tachometer's RED ZONE. This may cause severe engine damage.**

### Engine Coolant Temperature gauge

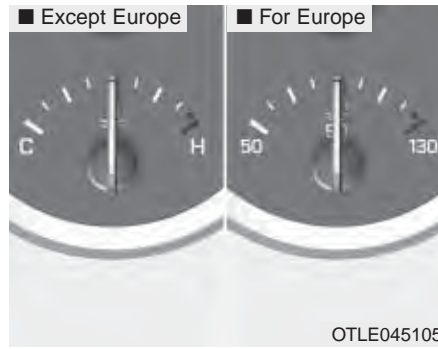

This gauge indicates the temperature of the engine coolant when the ignition switch or Engine Start/Stop button is in the ON position.

#### NOTICE

If the gauge pointer moves beyond the normal range area toward the "130 or H" position, it indicates overheating that may damage the engine.

Do not continue driving with an overheated engine. If your vehicle overheats, refer to "If the Engine Overheats" in chapter 6.

#### WARNING

**Never remove the radiator cap when the engine is hot. The engine coolant is under pressure and could cause severe burns. Wait until the engine is cool before adding coolant to the reservoir.**

### Fuel Gauge

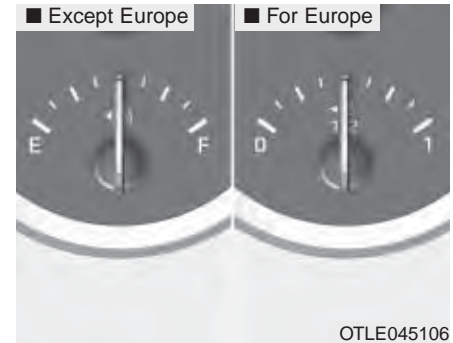

This gauge indicates the approximate amount of fuel remaining in the fuel tank.

- User Settings Mode in the Cluster : You can change the temperature unit in the “Other Features - Temperature unit” .
- Automatic climate control system : While pressing the OFF button, press the AUTO button for 3 seconds or more.

### *Icy Road Warning Light (if equipped)*

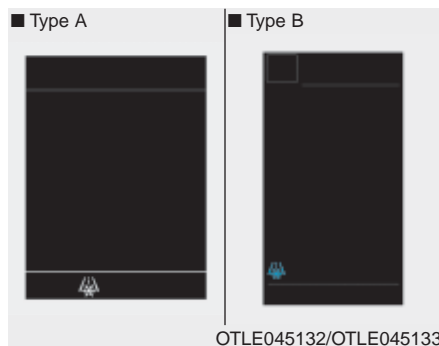

This warning light is to warn the driver the road may be icy.

When the following conditions occur, the warning light (including Outside Temperature Gauge) blinks 10 times and then illuminates, and also warning chime sounds 3 times.

- The temperature on the Outside Temperature Gauge is below approximately 4°C (39°F).

### **i** Information

**If the icy road warning light appears while driving, you should drive more attentively and safely refraining from over-speeding, rapid acceleration, sudden braking or sharp turning, etc.**

### Transaxle Shift Indicator



#### Automatic Transaxle Shift Indicator (if equipped)

This indicator displays which automatic transaxle shift lever is selected.

- Park : P
- Reverse : R
- Neutral : N
- Drive : D
- Sports Mode : 1, 2, 3, 4, 5, 6

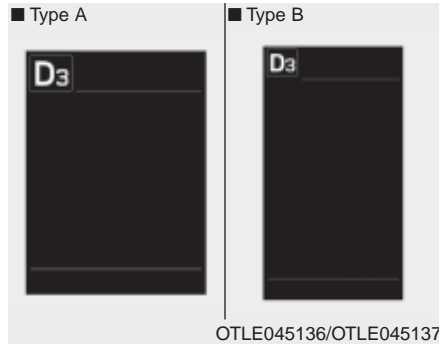

#### Dual Clutch Transmission Shift Indicator (if equipped)

This indicator displays which shift lever is selected.

- Park : P
- Reverse : R
- Neutral : N
- Drive : D
- Sports Mode : D1, D2, D3, D4, D5, D6, D7

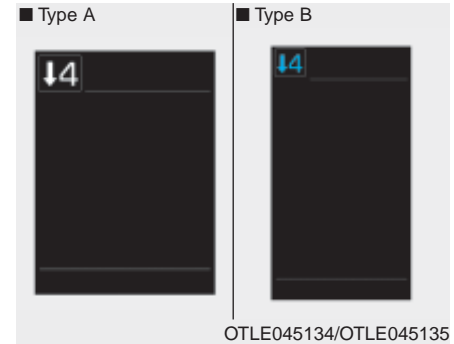

#### Automatic Transaxle Shift Indicator/ Dual Clutch Transmission Shift Indicator (if equipped)

In the Sports Mode, this indicator informs which gear is desired while driving to save fuel.

## Convenient features of your vehicle

- Automatic transaxle shift indicator
  - Shifting up : ▲2, ▲3, ▲4, ▲5, ▲6
  - Shifting down : ▼1, ▼2, ▼3, ▼4, ▼5
- Dual clutch transmission shift indicator
  - Shifting up : ▲2, ▲3, ▲4, ▲5, ▲6, ▲7
  - Shifting down : ▼1, ▼2, ▼3, ▼4, ▼5, ▼6

For example

- ▲3 : Indicates that shifting up to the 3rd gear is desired (currently the shift lever is in the 2nd or 1st gear).
- ▼3 : Indicates that shifting down to the 3rd gear is desired (currently the shift lever is in the 4th, 5th, or 6th gear).

When the system is not working properly, the indicator is not displayed.

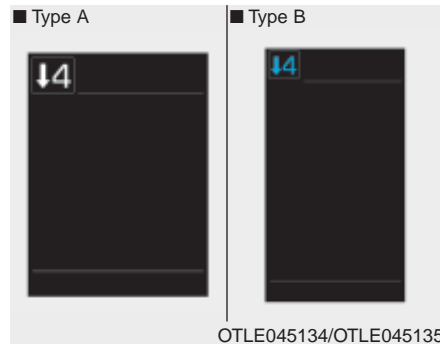

### Manual Transaxle Shift Indicator (if equipped)

This indicator informs which gear is desired while driving to save fuel.

- Shifting up : ▲2, ▲3, ▲4, ▲5, ▲6
- Shifting down : ▼1, ▼2, ▼3, ▼4, ▼5

For example

- ▲3 : Indicates that shifting up to the 3rd gear is desired (currently the shift lever is in the 2nd or 1st gear).
- ▼3 : Indicates that shifting down to the 3rd gear is desired (currently the shift lever is in the 4th, 5th, or 6th gear).

When the system is not working properly, the indicator is not displayed.



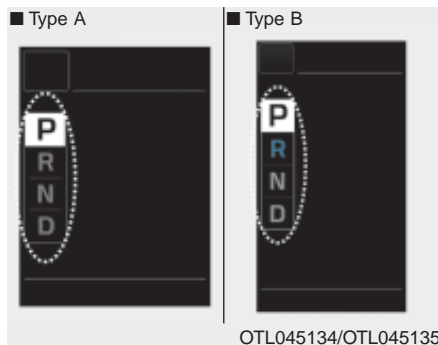

### Shift Indicator Pop-up (if equipped)

The pop-up that indicates the current gear position is displayed in the cluster for about 2 seconds when shifting into other positions (P/R/N/D).

### Odometer









The odometer indicates the total distance that the vehicle has been driven and should be used to determine when periodic maintenance should be performed.

- Odometer range : 0~ 1,599,999 km  
or 999,999mi.

## LCD DISPLAY

### LCD modes

Modes	Symbol	Explanation
Trip Computer		This mode displays driving information like the tripmeter, fuel economy, and so on. For more details, refer to "Trip Computer" in this chapter.
Turn By Turn (TBT) (if equipped)		This mode displays the state of the navigation.
A/V (If equipped)		This mode displays the state of the A/V system.
Information	 or  or 	This mode informs of the service interval (mileage or days) and warning messages related to the Blind Spot Detection system, and so on.
User Settings		On this mode, you can change settings of the doors, lamps, and so on.

For controlling the LCD modes, refer to "LCD Display Control" in this chapter.

**Edit settings after engaging parking brake / Edit settings after shifting to P**

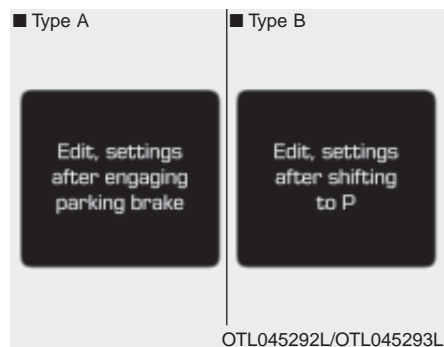

This warning message illuminates if you try to select the other User Settings item when driving.

- Automatic transaxle/  
dual clutch transmission

For safety, change the User Settings after parking the vehicle, applying the parking brake and moving the shift lever to P (Park) position.

- Manual transaxle

For safety, change the User Settings after engaging parking brake.

**Quick guide (Help, if equipped)**

If you press and hold the OK button in the User Settings Mode, explanation about the selected item is displayed in the cluster.

### Trip computer mode

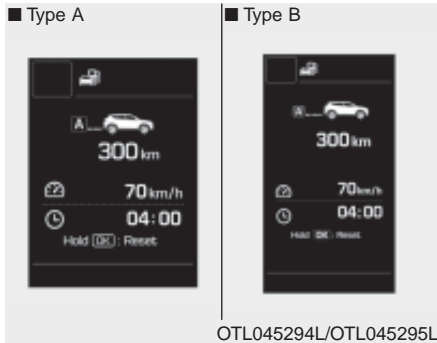

This mode displays driving information like the tripmeter, fuel economy, and so on.

For more details, refer to “Trip Computer” in this chapter.

### Turn By Turn (TBT) mode (if equipped)

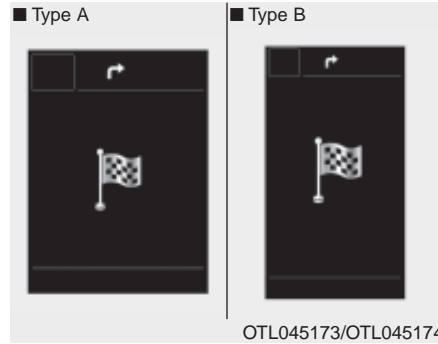

This mode displays the state of the navigation.

### A/V mode (if equipped)

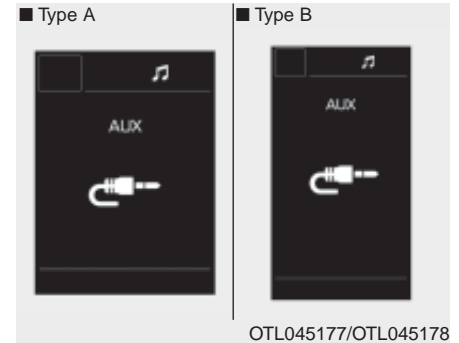

This mode displays the state of the A/V system.

## Information mode

### Service Interval



#### Service in

It calculates and displays when you need a scheduled maintenance service (mileage or days).

If the remaining mileage or time reaches 1,500 km (900 miles) or 30 days, "Service in" message is displayed for several seconds each time you set the ignition switch or Engine Start/Stop button to the ON position.

For the setting of the service interval, refer to "User Settings Mode" of the LCD display.

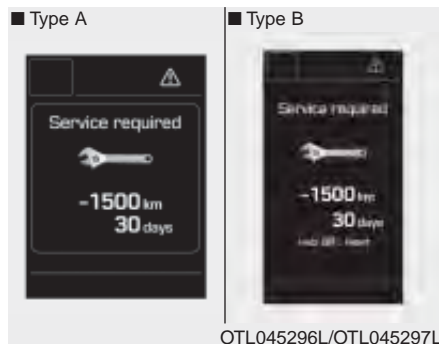

#### Service required

If you do not have your vehicle serviced according to the already inputted service interval, "Service required" message is displayed for several seconds each time you set the ignition switch or Engine Start/Stop button to the ON position.

To reset the service interval to the mileage and days you inputted before:

- Activate the reset mode by pressing the OK button for more than 5 seconds, then press the OK button again for more than 1 second (Europe).
- Press the OK button for more than 1 second (Except Europe).

## User settings mode

On this mode, you can change setting of the instrument cluster, doors, lamps, and so on.

### Driving Assist (if equipped)

Items	Explanation
RCTA (Rear Cross Traffic Alert, if equipped)	To activate or deactivate the RCTA system. <b>For more details, refer to "Rear Cross Traffic Alert (RCTA)" in chapter 5.</b>
Speed Limit Information Function (if equipped)	If this item is checked, the speed limit information function will be activated. <b>For more details, refer to "Speed Limit Information Function" in chapter 5.</b>

## Light

Items	Explanation
One Touch Turn Signal	<ul style="list-style-type: none"><li>• Off: The one touch turn signal function will be deactivated.</li><li>• 3, 5, 7 Flashes : The lane change signals will blink 3, 5, or 7 times when the turn signal lever is moved slightly.</li></ul> <p><b>For more details, refer to "Light" in this chapter.</b></p>
Head Lamp Delay	<ul style="list-style-type: none"><li>• If this item checked, the head lamp delay function will be activated.</li></ul>
Welcome light (if equipped)	<ul style="list-style-type: none"><li>• If this item checked, the welcome light function will be activated.</li></ul>

### Sound

Items	Explanation
Park Assist System Vol. (if equipped)	<ul style="list-style-type: none"> <li>Adjust the Park Assist System volume. (Level 1~3)</li> </ul> <b>For more details, refer to "Parking Assist System" in this chapter.</b>
BSD (Blind Spot Detection) Sound (if equipped)	<ul style="list-style-type: none"> <li>If this item checked, the blind spot detection sound will be activated.</li> </ul> <b>For more details, refer to "Blind Spot Detection System" in chapter 5.</b>
Welcome sound (if equipped)	<ul style="list-style-type: none"> <li>If this item checked, the welcome sound function will be activated.</li> </ul>

### Service interval

Items	Explanation
Service Interval (Except Europe)	<p>On this mode, you can activate the service interval function with mileage (km or mi.) and period (days).</p> <ul style="list-style-type: none"> <li>Off : The service interval function will be deactivated.</li> <li>On : You can set the service interval (mileage and days).</li> </ul> <b>For more details, refer to "Information Mode" in this chapter.</b>



## Other features

Items	Explanation
Fuel Economy Auto Reset	<ul style="list-style-type: none"> <li>• Off : The average fuel economy will not reset automatically whenever refueling.</li> <li>• After Ignition : The average fuel economy will reset automatically when driving.</li> <li>• After Refueling : The average fuel economy will reset automatically when refueling.</li> </ul> <p><b>For more details, refer to “Trip Computer” in this chapter.</b></p>
Steering position	If this item checked, the steering position will be displayed on the LCD.
Auto Rear Wiper	<ul style="list-style-type: none"> <li>• Off : The Auto Rear Wiper function will be deactivated.</li> <li>• ON : If you move the shift lever from D to R when the front wiper operates, the rear wiper will operate automatically. Then, if you move the shift lever from R to D, the rear wiper will stop.</li> </ul>
Fuel Economy Unit	Choose the fuel economy unit. (Km/L, L/100)
Temperature Unit	Choose the temperature unit. (°C,°F)
Tire Pressure Unit (if equipped)	Choose the tire pressure unit. (psi, kPa, Bar)
Gear Position Pop-up	If this item checked, the gear position will be displayed on the LCD when you move the shift lever.
Language	Choose the language.

### Warning messages (if equipped)

**Shift to "P" position  
(for smart key system and auto-  
matic transaxle/dual clutch trans-  
mission)**

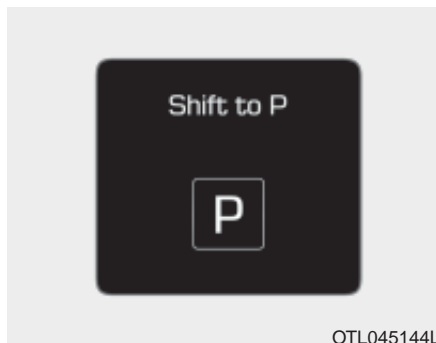

- This warning message illuminates if you try to turn off the engine without the shift lever in P (Park) position.
- At this time, the Engine Start/Stop button turns to the ACC position (If you press the Engine Start/Stop button once more, it will turn to the ON position).

### Low Key Battery (for smart key system)

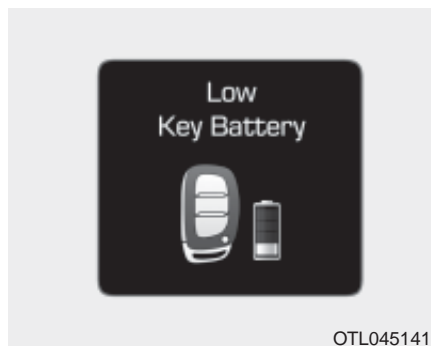

- This warning message illuminates if the battery of the smart key is discharged when the Engine Start/Stop button changes to the OFF position.

### Press start button while turning wheel (for smart key system)



- This warning message illuminates if the steering wheel does not unlock normally when the Engine Start/Stop button is pressed.
- It means that you should press the Engine Start/Stop button while turning the steering wheel right and left.

**Steering wheel unlocked  
(for smart key system)**

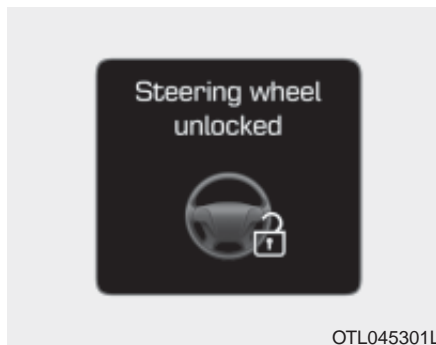

OTL045301L

- This warning message illuminates if the steering wheel does not lock when the Engine Start/Stop button changes to the OFF position.

**Check steering wheel lock  
system (for smart key system)**

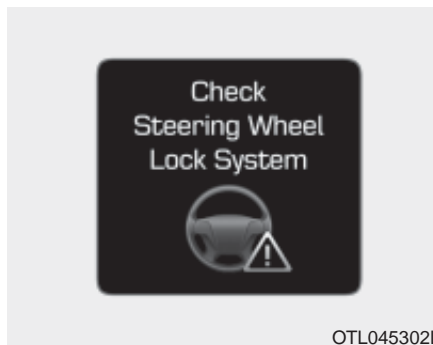

OTL045302L

- This warning message illuminates if the steering wheel does not lock normally when the Engine Start/Stop button changes to the OFF position.

**Press brake pedal to start engine  
(for smart key system and automatic transaxle)**

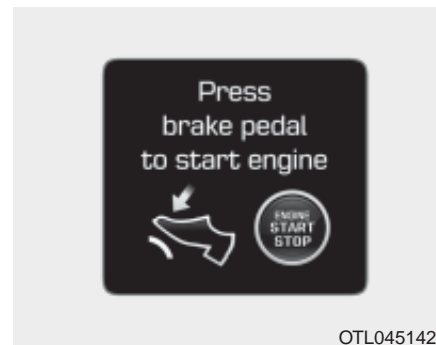

OTL045142L

- This warning message illuminates if the Engine Start/Stop button changes to the ACC position twice by pressing the button repeatedly without depressing the brake pedal.
- It means that you should depress the brake pedal to start the engine.

**Press clutch pedal to start engine  
(for smart key system and manual  
transaxle)**

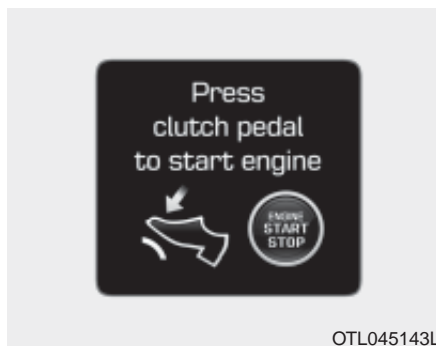

This warning message illuminates if the Engine Start/Stop button is in the ACC position twice by pressing the button repeatedly without depressing the clutch pedal.

Depress the clutch pedal to start the engine.

**Key not in vehicle  
(for smart key system)**

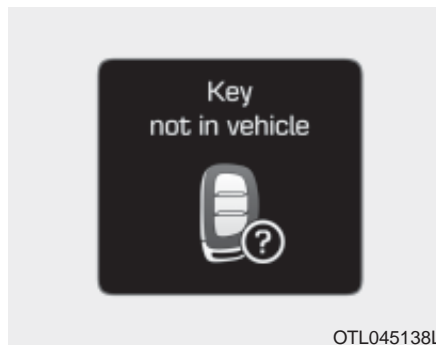

- This warning message illuminates if the smart key is not in the vehicle when you press the Engine Start/Stop button.
- It means that you always have the smart key with you.

**Key not detected  
(for smart key system)**

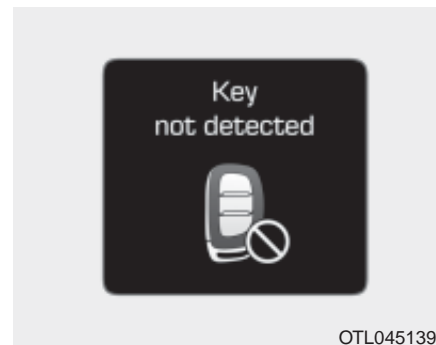

- This warning message illuminates if the smart key is not detected when you press the Engine Start/Stop button.

**Press start button again  
(for smart key system)**



OTL045145L

- This warning message illuminates if you can not operate the Engine Start/Stop button when there is a problem with the Engine Start/Stop button system.
- It means that you could start the engine by pressing the Engine Start/Stop button once more.
- If the warning illuminates each time you press the Engine Start/Stop button, we recommend that you have the vehicle inspected by an authorized HYUNDAI dealer.

**Press "START" button with key  
(for smart key system)**



OTL045140L

- This warning message illuminates if you press the Engine Start/Stop button while the warning message "Key not detected" is illuminating.
- At this time, the immobilizer indicator light blinks.

**Check "BRAKE SWITCH" fuse (for smart key system and automatic transaxle/dual clutch transmission)**

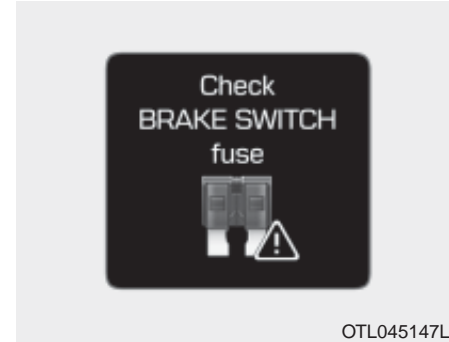

OTL045147L

- This warning message illuminates if the brake switch fuse is disconnected.
- It means that you should replace the fuse with a new one. If that is not possible, you can start the engine by pressing the Engine Start/Stop button for 10 seconds in the ACC position.

**Shift to "P" or "N" to start engine (for smart key system and automatic transaxle/dual clutch transmission)**

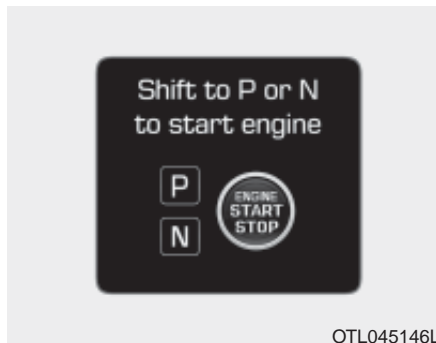

- This warning message illuminates if you try to start the engine with the shift lever not in the P (Park) or N (Neutral) position.

### **i** Information

You can start the engine with the shift lever in the N (Neutral) position. But, for your safety, we recommend that you start the engine with the shift lever in the P (Park) position.

### **Door, Hood, Tailgate Open**

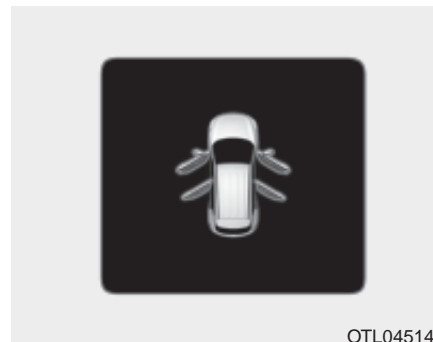

- It means that any door, hood, or tailgate is open.

### **⚠ CAUTION**

**Before driving the vehicle, you should confirm that the door/hood/tailgate is fully closed.**

**Also, check there is no door/hood/tailgate open warning light or message displayed on the instrument cluster.**

**Sunroof Open (if equipped)**

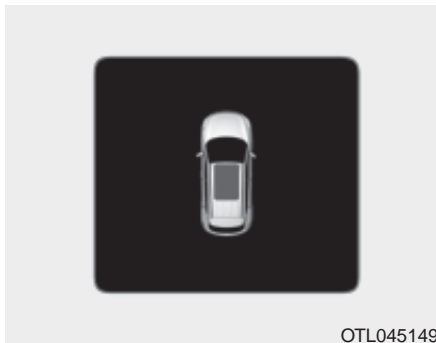

This warning message illuminates if you turn off the engine when the sunroof is open.

**Heated Steering Wheel On (if equipped)**

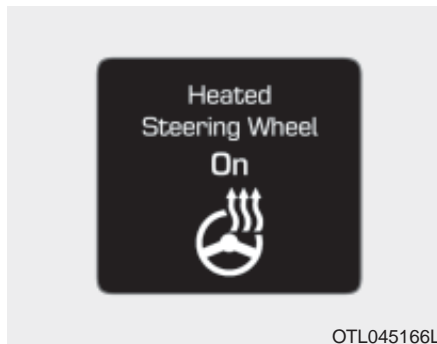

- This warning message illuminates if you turn on the heated steering wheel.

For more details, refer to “Heated Steering Wheel” in this chapter.

**Heated Steering Wheel Off (if equipped)**

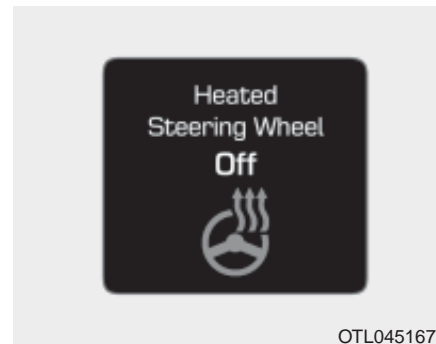

- This warning message illuminates if you turn off the heated steering wheel.

For more details, refer to “Heated Steering Wheel” in this chapter.

*Low Tire Pressure (if equipped)*



- This warning message illuminates if the tire pressure is low with the Engine Start/Stop button in ON position.

**For more details, refer to "Tire Pressure Monitoring System (TPMS)" in chapter 6.**

*Turn on "FUSE SWITCH"*



- This warning message illuminates if the fuse switch located on the fuse box under the steering wheel is OFF.
- It means that you should turn the fuse switch on.

**For more details, refer to "Fuses" in chapter 7.**

*Align steering wheel (if equipped)*



- This warning message illuminates if you start the engine when the steering wheel is turned to more than 90 degrees to the left or right.
- It means that you should turn the steering wheel and make the angle of the steering wheel be less than 30 degrees.



### *Steering wheel aligning is completed (if equipped)*

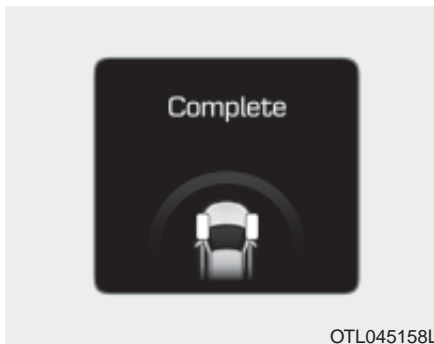

OTL045158L

- If the steering wheel aligning is completed after “Align steering wheel” warning message is displayed, this message is displayed for 2 seconds.

### *Low Washer Fluid (if equipped)*

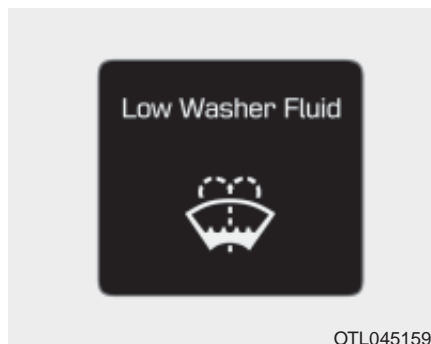

OTL045159L

- This warning message illuminates on the service reminder mode if the washer fluid level in the reservoir is nearly empty.
- It means that you should refill the washer fluid.

### *Low Fuel*

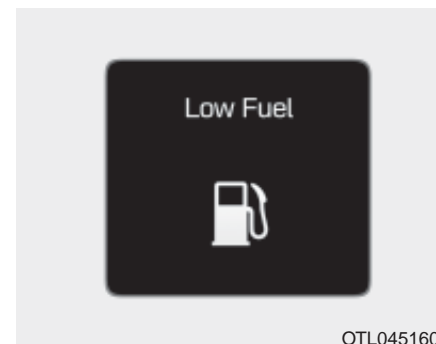

OTL045160L

- This warning message illuminates if the fuel tank is nearly empty.
  - When the low fuel level warning light is illuminates.
  - When the trip computer displays “--- km(or mile)” as distance to empty.

Add fuel as soon as possible.

### Engine has overheated

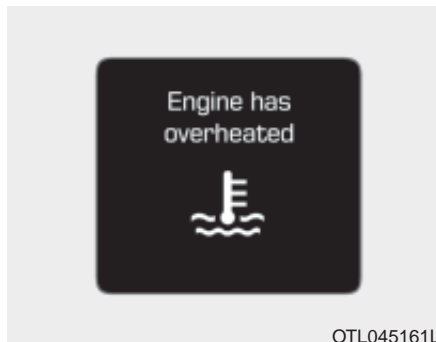

- This warning message illuminates when the engine coolant temperature is above 120°C (248°F). This means that the engine is overheated and may be damaged.

If your vehicle is overheated, refer to “Overheating” in chapter 6.

### Check headlight (if equipped)

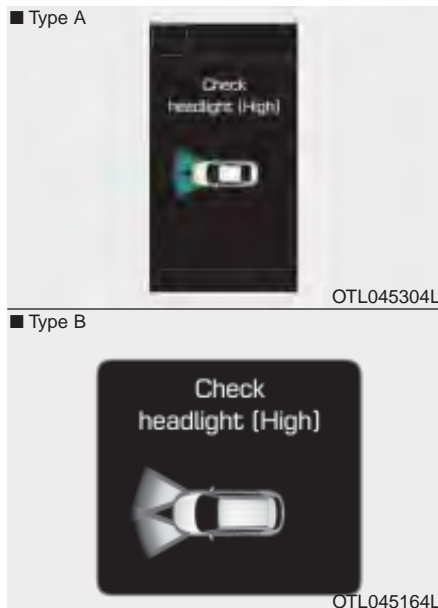

This warning message illuminates if there is a malfunction (burned-out bulb except LED lamp or circuit malfunction) with the headlamp. In this case, have your vehicle inspected by an authorized HYUNDAI dealer.

### NOTICE

- When replacing the bulb, use the same wattage bulb.  
For more information, refer to “BULB WATTAGE” in chapter 8.
- If the different wattage bulb is equipped with the vehicle, this warning message is not displayed.

### ***Diesel Particulate Filter (DPF) warning (for Diesel engine)***



This warning message illuminates if the DPF system has a malfunction. At this time, DPF warning light also blinks.

In this case, we recommend that you have the DPF system checked by an authorized HYUNDAI dealer.

**For more details, refer to “Warning Lights” in this chapter.**

## TRIP COMPUTER

### Overview

#### Description

The trip computer is a microcomputer-controlled driver information system that displays information related to driving.

#### Information

Some driving information stored in the trip computer (for example Average Vehicle Speed) resets if the battery is disconnected.

### Trip modes

To change the trip mode, rotate the MOVE switch “▲, ▼” on the steering wheel.

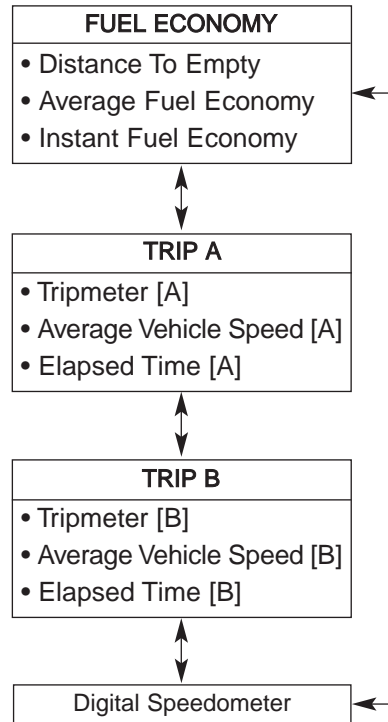

### Trip A/B (km or mile, km/h or MPH)

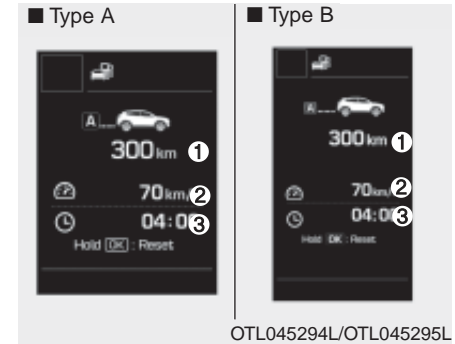

#### Tripmeter (1)

- The tripmeter is the total driving distance since the last tripmeter reset.
  - Distance range: 0.0 ~ 9999.9 km or mi.
- To reset the tripmeter, press the [OK] button on the steering wheel for more than 1 second when the tripmeter is displayed.

### Average Vehicle Speed (2)

- The average vehicle speed is calculated by the total driving distance and driving time since the last average vehicle speed reset.
  - 0~240 km/h or 0~160 MPH
- To reset the average vehicle speed, press the [OK] button on the steering wheel for more than 1 second when the average vehicle speed is displayed.

### **i** Information

- The average vehicle speed is not displayed if the driving distance is less than 300 meters (0.19 miles) or the driving time is less than 10 seconds since the ignition switch or the Engine Start/Stop button is turned to ON.
- Even if the vehicle is not in motion, the average vehicle speed keeps calculating while the engine is running.

### Elapsed Time (3)

- The elapsed time is the total driving time since the last elapsed time reset.
  - Time range (hh:mm): 00:00 ~ 99:59
- To reset the elapsed time, press the [OK] button on the steering wheel for more than 1 second when the elapsed time is displayed.

### **i** Information

Even if the vehicle is not in motion, the elapsed time keeps calculating while the engine is running.

### Fuel economy (km or mile, L/100km, km/L or MPG)



### Distance To Empty (1)

- The distance to empty is the estimated distance the vehicle can be driven with the remaining fuel.
  - Distance range: 1 ~ 9999 km or 1 ~ 9999 mi.
- If the estimated distance is below 1 km (1 mi.), the trip computer will display “---” as distance to empty.

### **i** Information

- **If the vehicle is not on level ground or the battery power has been interrupted, the distance to empty function may not operate correctly.**
- **The distance to empty may differ from the actual driving distance as it is an estimate of the available driving distance.**
- **The trip computer may not register additional fuel if less than 6 liters (1.6 gallons) of fuel are added to the vehicle.**
- **The fuel economy and distance to empty may vary significantly based on driving conditions, driving habits, and condition of the vehicle.**

### **Average Fuel Economy (2)**

- The average fuel economy is calculated by the total driving distance and fuel consumption since the last average fuel economy reset.
  - Fuel economy range: 0.0 ~ 99.9 L/100km, km/L or MPG
- The average fuel economy can be reset both manually and automatically.

### **Manual reset**

To clear the average fuel economy manually, press the [OK] button on the steering wheel for more than 1 second when the average fuel economy is displayed.

### **Automatic reset**

To make the average fuel economy be reset automatically whenever refueling, select the “After refueling” mode in User Setting menu of the LCD display (**Refer to “LCD Display”**).

Under “After refueling” mode, the average fuel economy will be cleared to zero (---) when the vehicle speed exceeds 1 km/h after refueling more than 6 liters (1.6 gallons).

## **i** Information

The average fuel economy is not displayed for more accurate calculation if the vehicle does not drive more than 10 seconds or 300 meters (0.19 miles) since the ignition switch or the Engine Start/Stop button is turned to ON.

### **Instant Fuel Economy (3)**

- This mode displays the instant fuel economy during the last few seconds when the vehicle speed is more than 10 km/h (6.2 MPH).
  - Fuel economy range: 0 ~ 30 L/100km, km/L or 0 ~ 50 MPG

### **Digital Speedometer (km/h or MPH)**

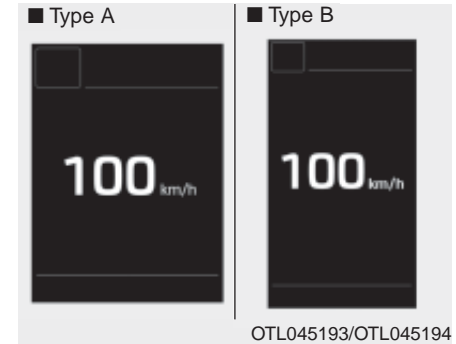

This message shows the speed of the vehicle (km/h, MPH).

### **One time driving information mode (km or mile, L/100km or MPG)**

This display shows trip distance (1),

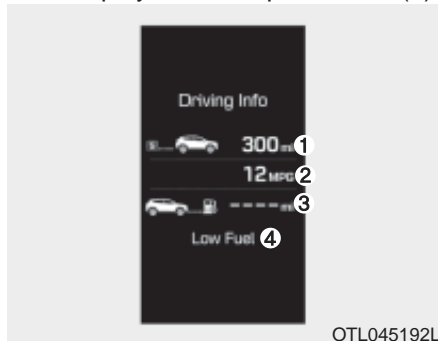

average fuel economy (2) and the vehicle can be driven with the remaining fuel (3).

This information is displayed for a few seconds when you turn off the engine and then goes off automatically. The information provided is calculated according to each trip.

If the estimated distance is below 1km (1 mi.), the distance to empty (3) will display as "---" and a refuel message will appear (4).

### **i Information**

**If “Sunroof Open” warning message is displayed in the cluster, this display may not be displayed in the cluster.**



## WARNING AND INDICATOR LIGHTS

### Warning lights

#### **i** Information

Make sure that all warning lights are OFF after starting the engine. If any light is still ON, this indicates a situation that needs attention.

#### *Air bag Warning Light*



#### **This warning light illuminates:**

- Once you set the ignition switch or the Engine Start/Stop button to the ON position.
  - It illuminates for approximately 6 seconds and then goes off.
- When there is a malfunction with the SRS.

In this case, we recommend that you have the vehicle inspected by an authorized HYUNDAI dealer.

#### *Seat Belt Warning Light*



This warning light informs the driver that the seat belt is not fastened.

For more details, refer to the “Seat Belts” in chapter 2.

### ***Parking Brake & Brake Fluid Warning Light***



#### **This warning light illuminates:**

- Once you set the ignition switch or the Engine Start/Stop button to the ON position.
  - It illuminates for approximately 3 seconds
  - It remains on if the parking brake is applied.
- When the parking brake is applied.
- When the brake fluid level in the reservoir is low.
  - If the warning light illuminates with the parking brake released, it indicates the brake fluid level in reservoir is low.

#### **If the brake fluid level in the reservoir is low:**

1. Drive carefully to the nearest safe location and stop your vehicle.
2. With the engine stopped, check the brake fluid level immediately and add fluid as required (**For more details, refer to “Brake Fluid” in chapter 7**). Then check all brake components for fluid leaks. If any leak on brake system is still found, the warning light remains on, or the brakes do not operate properly, do not drive the vehicle.

In this case, we recommend that you have the vehicle towed to an authorized HYUNDAI dealer and inspected.

#### **Dual-diagonal braking system**

Your vehicle is equipped with dual-diagonal braking systems. This means you still have braking on two wheels even if one of the dual systems should fail.

With only one of the dual systems working, more than normal pedal travel and greater pedal pressure are required to stop the vehicle.

Also, the vehicle will not stop in as short a distance with only a portion of the brake system working.

If the brakes fail while you are driving, shift to a lower gear for additional engine braking and stop the vehicle as soon as it is safe to do so.

**⚠ WARNING**

**Parking Brake & Brake Fluid Warning Light**

Driving the vehicle with a warning light ON is dangerous. If the Parking Brake & Brake Fluid Warning Light illuminates with the parking brake released, it indicates that the brake fluid level is low.

In this case, we recommend that you have the vehicle inspected by an authorized HYUNDAI dealer.

**Anti-lock Brake System (ABS) Warning Light**



**This warning light illuminates:**

- Once you set the ignition switch or the Engine Start/Stop button to the ON position.
  - It illuminates for approximately 3 seconds and then goes off.
- When there is a malfunction with the ABS (The normal braking system will still be operational without the assistance of the anti-lock brake system).

In this case, we recommend that you have the vehicle inspected by an authorized HYUNDAI dealer.

**Electronic Brake force Distribution (EBD) System Warning Light**



**These two warning lights illuminate at the same time while driving:**

- When the ABS and regular brake system may not work normally. In this case, we recommend that you have the vehicle inspected by an authorized HYUNDAI dealer.

 **WARNING**

**Electronic Brake force Distribution (EBD) System Warning Light**

When both ABS and Parking Brake & Brake Fluid Warning Lights are on, the brake system will not work normally and you may experience an unexpected and dangerous situation during sudden braking.

In this case, avoid high speed driving and abrupt braking.

We recommend you have the vehicle inspected by an authorized HYUNDAI dealer as soon as possible.

 **Information - Electronic Brake force Distribution (EBD) System Warning Light**

When the ABS Warning Light is on or both ABS and Parking Brake & Brake Fluid Warning Lights are on, the speedometer, odometer, or tripmeter may not work. Also, the EPS Warning Light may illuminate and the steering effort may increase or decrease.

In this case, we recommend you have the vehicle inspected by an authorized HYUNDAI dealer as soon as possible.

**Electronic Parking Brake (EPB) Warning Light (if equipped)**

**EPB**

**This warning light illuminates:**

- Once you set the ignition switch or the Engine Start/Stop button to the ON position.
  - It illuminates for approximately 3 seconds and then goes off.
- When there is a malfunction with the EPB.

In this case, we recommend that you have the vehicle inspected by an authorized HYUNDAI dealer.

 **Information - Electronic Parking Brake (EPB) Warning Light**

The Electronic Parking Brake (EPB) Warning Light may illuminate when the Electronic Stability control (ESC) Indicator Light comes on to indicate that the ESC is not working properly (This does not indicate malfunction of the EPB).

## Electric Power Steering (EPS) Warning Light



### This warning light illuminates:

- Once you set the ignition switch or the Engine Start/Stop button to the ON position.
  - This indicator light comes on after the ignition key is turned to the ON position and then goes out after approximately 3 seconds.
- When there is a malfunction with the EPS.

In this case, we recommend that you have the vehicle inspected by an authorized HYUNDAI dealer.

## Malfunction Indicator Lamp (MIL)



### This warning light illuminates:

- Once you set the ignition switch or the Engine Start/Stop button to the ON position.
  - It remains on until the engine is started.
- When there is a malfunction with the emission control system.
  - In this case, we recommend that you have the vehicle inspected by an authorized HYUNDAI dealer.

### **NOTICE** - Malfunction Indicator Lamp (MIL)

Driving with the Malfunction Indicator Lamp (MIL) on may cause damage to the emission control systems which could affect drivability and/or fuel economy.

### **NOTICE** - Gasoline Engine

If the Malfunction Indicator Lamp (MIL) illuminates, potential catalytic converter damage is possible which could result in loss of engine power.

In this case, we recommend that you have the vehicle inspected by an authorized HYUNDAI dealer as soon as possible.

### CAUTION

#### Diesel Engine

If the Malfunction Indicator Lamp (MIL) blinks, some error related to the injection quantity adjustment occurs which could result in loss of engine power, combustion noise and poor emission.

In this case, we recommend that you have the engine control system inspected by an authorized HYUNDAI dealer.

### **Charging System Warning Light**



#### **This warning light illuminates:**

- Once you set the ignition switch or the Engine Start/Stop button to the ON position.
  - It remains on until the engine is started.
- When there is a malfunction with either the alternator or electrical charging system.

**If there is a malfunction with either the alternator or electrical charging system:**

1. Drive carefully to the nearest safe location and stop your vehicle.
2. Turn the engine off and check the alternator drive belt for looseness or breakage.

If the belt is adjusted properly, there may be a problem in the electrical charging system.

In this case, we recommend that you have the vehicle inspected by an authorized HYUNDAI dealer as soon as possible.

### **Engine Oil Pressure Warning Light**



#### **This warning light illuminates:**

- Once you set the ignition switch or the Engine Start/Stop button to the ON position.
  - It remains on until the engine is started.
- When the engine oil pressure is low.

#### **If the engine oil pressure is low:**

1. Drive carefully to the nearest safe location and stop your vehicle.
2. Turn the engine off and check the engine oil level (**For more details, refer to “Engine Oil” in chapter 7**). If the level is low, add oil as required.

If the warning light remains on after adding oil or if oil is not available, we recommend that you have the vehicle inspected by an authorized HYUNDAI dealer as soon as possible.

**NOTICE** - Engine Oil Pressure Warning Light

- If the engine does not stop immediately after the Engine Oil Pressure Warning Light is illuminated, severe damage could result.
- If the warning light stays on while the engine is running, it indicates that there may be serious engine damage or malfunction. In this case,
  1. Stop the vehicle as soon as it is safe to do so.
  2. Turn off the engine and check the oil level. If the oil level is low, fill the engine oil to the proper level.
  3. Start the engine again. If the warning light stays on after the engine is started, turn the engine off immediately. In this case, we recommend that you have the vehicle inspected by an authorized HYUNDAI dealer.

**Low Fuel Level Warning Light**



**This warning light illuminates:**  
When the fuel tank is nearly empty.

**If the fuel tank is nearly empty:**  
Add fuel as soon as possible.

**NOTICE** - Low Fuel Level

Driving with the Low Fuel Level warning light on or with the fuel level below "0 or E" can cause the engine to misfire and damage the catalytic converter (if equipped).

**Overspeed Warning Light (if equipped)**

**120 km/h**

**This warning light blinks:**

- When you drive the vehicle more than 120 km/h.
  - This is to prevent you from driving your vehicle with overspeed.
  - The overspeed warning chime also sound for approximately 5 seconds.

### **Master Warning Light**



#### **This indicator light illuminates:**

- When there is a malfunction on the below systems.
  - Low washer fluid (if equipped)
  - Blind Spot Detection (BSD) malfunction (if equipped)
  - Tire Pressure Monitoring System (TPMS, if equipped)
  - Service reminder and so on.

To identify the details of the warning, look at the LCD display.

### **Low Tire Pressure Warning Light (if equipped)**



#### **This warning light illuminates:**

- Once you set Engine Start/Stop button to the ON position.
  - It illuminates for approximately 3 seconds and then goes off.
- When one or more of your tires are significantly underinflated (The location of the underinflated tires are displayed on the LCD display).

For more details, refer to “Tire Pressure Monitoring System (TPMS)” in chapter 6.

This warning light remains on after blinking for approximately 60 seconds or repeats blinking and off at the intervals of approximately 3 seconds:

- When there is a malfunction with the TPMS.

In this case, we recommend that you have the vehicle inspected by an authorized HYUNDAI dealer as soon as possible.

For more details, refer to “Tire Pressure Monitoring System (TPMS)” in chapter 6.



## WARNING

### Safe Stopping

- The TPMS cannot alert you to severe and sudden tire damage caused by external factors.
- If you notice any vehicle instability, immediately take your foot off the accelerator pedal, apply the brakes gradually with light force, and slowly move to a safe position off the road.

## Fuel Filter Warning Light (Diesel Engine)



### This warning light illuminates:

- Once you set the ignition switch or Engine Start/Stop Button to the ON position.
  - It illuminates for approximately 3 seconds and then goes off.
- When water has accumulated inside the fuel filter.  
In this case, remove the water from the fuel filter.

For more details, refer to “Fuel Filter” in chapter 7.

## CAUTION

### Fuel Filter Warning Light

- When the Fuel Filter Warning Light illuminates, engine power (vehicle speed & idle speed) may decrease.
- If you keep driving with the warning light on, engine parts (injector, common rail, high pressure fuel pump) may be damaged. If this occurs, we recommend that you have the vehicle inspected by an authorized HYUNDAI dealer as soon as possible.

### 4 Wheel Drive (4WD) Warning Light (if equipped)



#### This warning light illuminates:

- Once you set the ignition switch or Engine Start/Stop Button to the ON position.
  - It illuminates for approximately 3 seconds and then goes off.
- When there is a malfunction with the 4WD system.

In this case, we recommend that you have the vehicle inspected by an authorized HYUNDAI dealer.

### Headlight Warning Light (if equipped)



#### This warning light illuminates:

This warning light illuminates if there is a malfunction (burned-out bulb except LED light or circuit malfunction) with the exterior lights (headlight, brake light, fog light, etc.). In this case, we recommend that you have your vehicle inspected by an authorized HYUNDAI dealer.

#### **i** Information

- **When replacing the bulb, use the same wattage bulb.**  
**For more information, refer to “BULB WATTAGE” in chapter 8.**
- **If a bulb with different wattage is installed in the vehicle, this warning message is not displayed.**

### Exhaust System (DPF) Warning Light (Diesel Engine)



#### This warning light illuminates:

- When there is a malfunction with Diesel Particulate Filter (DPF) system.
- When this warning light illuminates, it may turn off after driving the vehicle:
  - at more than 60km/h (37 mph), or
  - at more than 2nd gear with 1500 ~ 2000 engine rpm for a certain time (for about 25 minutes).

If the this warning light blinks in spite of the procedure (at this time LCD warning message will be displayed), we recommend that you have the DPF system checked by an authorized HYUNDAI dealer.

**NOTICE** - Diesel Engine with DPF  
If you continue to drive with the DPF warning light blinking for a long time, the DPF system can be damaged and fuel consumption can worsen.

### Indicator lights

#### *Electronic Stability Control (ESC) Indicator Light (if equipped)*



**This indicator light illuminates:**

- Once you set the ignition switch or the Engine Start/Stop button to the ON position.
  - It illuminates for approximately 3 seconds and then goes off.
- When there is a malfunction with the ESC system.

In this case, we recommend that you have the vehicle inspected by an authorized HYUNDAI dealer.

**This indicator light blinks:**

While the ESC is operating.

For more details, refer to “Electronic Stability Control (ESC)” in chapter 5.

#### *Electronic Stability Control (ESC) OFF Indicator Light (if equipped)*



**This indicator light illuminates:**

- Once you set the ignition switch or the Engine Start/Stop button to the ON position.
  - It illuminates for approximately 3 seconds and then goes off.
- When you deactivate the ESC system by pressing the ESC OFF button.

For more details, refer to “Electronic Stability Control (ESC)” in chapter 5.

### ***Immobilizer Indicator Light (without smart key) (if equipped)***



#### **This indicator light illuminates:**

When the vehicle detects the immobilizer in your key properly while the ignition switch is ON.

- At this time, you can start the engine.
- The indicator light goes off after starting the engine.

#### **This indicator light blinks:**

When there is a malfunction with the immobilizer system.

In this case, we recommend that you have the vehicle inspected by an authorized HYUNDAI dealer.

### ***Immobilizer Indicator Light (With Smart Key) (if equipped)***



#### **This indicator light illuminates for up to 30 seconds:**

- When the vehicle detects the smart key in the vehicle properly while the Engine Start/Stop button is ACC or ON.
  - At this time, you can start the engine.
  - The indicator light goes off after starting the engine.

#### **This indicator light blinks for a few seconds:**

- When the smart key is not in the vehicle.
  - At this time, you can not start the engine.

#### **This indicator light illuminates for 2 seconds and goes off:**

- When the vehicle can not detect the smart key which is in the vehicle while the Engine Start/Stop button is ON.

In this case, we recommend that you have the vehicle inspected by an authorized HYUNDAI dealer.

**This indicator light blinks:**

- When the battery of the smart key is weak.
  - At this time, you can not start the engine. However, you can start the engine if you press the Engine Start/Stop button with the smart key. **(For more details, refer to “Starting the Engine” in chapter 5).**
- When there is a malfunction with the immobilizer system.
 

In this case, we recommend that you have the vehicle inspected by an authorized HYUNDAI dealer.

**Turn Signal Indicator Light**

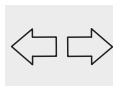

**This indicator light blinks:**

- When you turn the turn signal light on.

If any of the following occurs, there may a malfunction with the turn signal system. In this case, we recommend that you have the vehicle inspected by an authorized HYUNDAI dealer.

- The indicator light does not blink but illuminates.
- The indicator light blinks more rapidly.
- The indicator light does not illuminate at all.

**Low Beam Indicator Light (if equipped)**



**This indicator light illuminates:**

- When the headlights are on.

**High Beam Indicator Light**



**This indicator light illuminates:**

- When the headlights are on and in the high beam position
- When the turn signal lever is pulled into the Flash-to-Pass position.

### *Light ON Indicator Light*



**This indicator light illuminates:**

- When the tail lights or headlights are on.

### *Front Fog Indicator Light (if equipped)*



**This indicator light illuminates:**

- When the front fog lights are on.

### *Rear Fog Indicator Light (if equipped)*



**This indicator light illuminates:**

- When the rear fog lights are on.

### *Glow Indicator Light (Diesel Engine)*



**This indicator light illuminates:**

- When the engine is being preheated with the ignition switch or Engine Start/Stop Button in the ON position.
  - The engine can be started after the glow indicator light goes off.
  - The illumination time varies with the engine coolant temperature, air temperature, and battery condition.

If the indicator light remains on or blinks after the engine has warmed up or while driving, there may be a malfunction with the engine preheating system.

In this case, we recommend that you have the vehicle inspected by an authorized HYUNDAI dealer.

**i** Information

If the engine does not start within 10 seconds after the preheating is completed, set the ignition switch or Engine Start/Stop Button to the LOCK or OFF position for 10 seconds and then to the ON position in order to preheat the engine again.

**4 Wheel Drive (4WD) LOCK Indicator Light (if equipped)**



This indicator light illuminates:

- Once you set the ignition switch or Engine Start/Stop Button to the ON position.
  - It illuminates for approximately 3 seconds and then goes off.
- When you select 4WD Lock mode by pressing the 4WD LOCK button.
  - The 4WD LOCK mode is to increase the drive power when driving on wet pavement, snow covered roads and/or off-road.

 <b>CAUTION</b>
<b>4WD Lock Mode</b>
Do not use 4WD LOCK mode on dry paved roads or highway, it can cause noise, vibration or damage of 4WD related parts.

**Cruise Indicator Light (if equipped)** ■ Type A

CRUISE

■ Type B



This indicator light illuminates:

- When the cruise control system is enabled.

For more details, refer to "Cruise Control System" in chapter 5.

**Cruise SET Indicator Light (if equipped)**

SET

This indicator light illuminates:

- When the cruise control speed is set.

For more details, refer to "Cruise Control System" in chapter 5.

### *AUTO HOLD Indicator Light (if equipped)*

The icon consists of the words "AUTO" and "HOLD" stacked vertically in a bold, sans-serif font, enclosed within a light gray rounded rectangular border.

#### **This indicator light illuminates:**

- [White] When you activate the auto hold system by pressing the AUTO HOLD button.
- [Green] When you stop the vehicle completely by depressing the brake pedal with the auto hold system activated.
- [Yellow] When there is a malfunction with the auto hold system.

In this case, we recommend that you have the vehicle inspected by an authorized HYUNDAI dealer.

**For more details, refer to "Auto Hold" in chapter 5.**

### *SPORT Mode Indicator Light (if equipped)*

The icon consists of the word "SPORT" in a bold, sans-serif font, enclosed within a light gray rounded rectangular border.

#### **This indicator light illuminates**

- When you select "SPORT" mode as drive mode.

**For more details, refer to "Drive Mode Integrated Control System" in chapter 5.**

### *ECO Mode Indicator Light (if equipped)*

The icon consists of the word "ECO" in a bold, sans-serif font, enclosed within a light gray rounded rectangular border.

#### **This indicator light illuminates:**

- When you select "ECO" mode as drive mode.

**For more details, refer to "Drive Mode Integrated Control System" in chapter 5.**

#### **WARNING**

**Do not watch the ECO indicator light while driving. This will distract you and may cause an accident that results in severe personal injury.**



***Downhill Brake Control  
(DBC) Indicator Light  
(if equipped)***



**This warning light illuminates:**

- Once you set the ignition switch or Engine Start/Stop Button to the ON position.
  - It illuminates for approximately 3 seconds and then goes off.
- When you activate the DBC system by pressing the DBC button.

**This warning light blinks:**

- When the DBC is operating.

**This warning light illuminates yellow:**

- When there is a malfunction with the DBC system.

In this case, we recommend that you have the vehicle inspected by an authorized HYUNDAI dealer.

**For more details, refer to "Downhill Brake Control (DBC) System" in chapter 5.**

## LIGHT

### Exterior lights

#### Lighting control

■ Left-hand drive

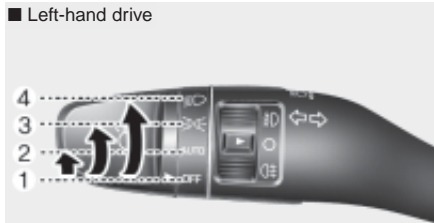

OTL045251L

■ Right-hand drive

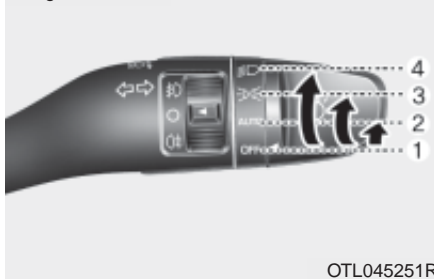

OTL045251R

To operate the lights, turn the knob at the end of the control lever to one of the following positions:

- (1) OFF (O) position
- (2) AUTO light position (if equipped)
- (3) Parking lamp position
- (4) Headlamp position



#### AUTO light position (if equipped)

When the light switch is in the AUTO position, the parking lamp and headlamp will be turned ON or OFF automatically depending on the amount of light outside the vehicle.

Even with the AUTO light feature in operation, it is recommended to manually turn ON the lamps when driving at night or in a fog, or when you enter dark areas, such as tunnels and parking facilities.

**NOTICE**

- Do not cover or spill anything on the sensor (1) located on the instrument panel.
- Do not clean the sensor using a window cleaner, the cleanser may leave a light film which could interfere with sensor operation.
- If your vehicle has window tint or other types of metallic coating on the front windshield, the AUTO light system may not work properly.



**Parking lamp position (ㇿ)**

The parking lamp, license plate lamp and instrument panel lamp are turned ON.



**Headlamp position (ㇾ)**

The headlamp, parking lamp, license plate lamp and instrument panel lamp are turned ON.

**i** Information

The ignition switch button must be in the ON position to turn on the headlamp.

**High beam operation**

■ Left-hand drive



■ Right-hand drive



To turn on the high beam headlamp, push the lever away from you. The lever will return to its original position. The high beam indicator will light when the headlamp high beams are switched on.

To turn off the high beam headlamp, pull the lever towards you. The low beams will turn on.

**WARNING**

Do not use high beam when there are other vehicles approaching you. Using high beam could obstruct the other driver's vision.



OTL045254L



OTL045254R

To flash the high beam headlamp, pull the lever towards you, then release the lever. The high beams will remain ON as long as you hold the lever towards you.

**Turn signals and lane change signals**



OTL045257L

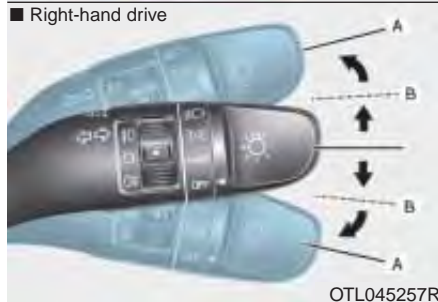

OTL045257R

To signal a turn, push down on the lever for a left turn or up for a right turn in position (A). To signal a lane change, move the turn signal lever slightly and hold it in position (B).

The lever will return to the OFF position when released or when the turn is completed.

If an indicator stays on and does not flash or if it flashes abnormally, one of the turn signal bulbs may be burned out and will require replacement.

### One-touch turn signal function (if equipped)

To activate an one-touch turn signal function, move the turn signal lever slightly and then release it. The lane change signals will blink 3, 5 or 7 times.

You can activate/deactivate the One Touch Turn Signal function or choose the number of blinking (3, 5, or 7) from the User Settings Mode on the LCD display. **For more details, refer to "LCD Display" in this chapter.**

### Front fog lamp (if equipped)

■ Left-hand drive



■ Right-hand drive



Fog lamps are used to provide improved visibility when visibility is poor due to fog, rain or snow, etc. Use the switch next to the headlamp switch to turn the fog lamps ON and OFF.

1. Turn on the parking lamp.
2. Turn the light switch (1) to the front fog lamp position.
3. To turn off the front fog lamp, turn the light switch to the front fog lamp position again or turn off the parking lamp.

### NOTICE

When in operation, the fog lamps consume large amounts of vehicle electrical power. Only use the fog lamps when visibility is poor.

### Rear fog lamp (if equipped)

■ Left-hand drive



■ Right-hand drive



### Vehicle with front fog lamp

To turn on the rear fog lamp:

Position the light switch in the parking lamp position, turn the light switch to the front fog lamp position, and then turn the lamp switch (1) to the rear fog lamp position.

■ Left-hand drive



■ Right-hand drive



### Vehicle without front fog lamp

To turn on the rear fog lamp:

Position the light switch in the headlamp position, and then turn the light switch (1) to the rear fog lamp position.

To turn the rear fog lamps off, do one of the following:

- Turn off the headlamp switch.
- Turn the light switch to the rear fog lamp position again.
- When the light switch is in the parking lamp position, if you turn off the front fog lamp, the rear fog lamp will also turn off.

### ***Battery saver function***

The purpose of this feature is to prevent the battery from being discharged. The system automatically turns off the parking lamp when the driver turns the engine off and opens the driver-side door.

With this feature, the parking lamps will turn off automatically if the driver parks on the side of road at night.

If necessary, to keep the lamps on when the engine is turned off, perform the following:

- 1) Open the driver-side door.
- 2) Turn the parking lamps OFF and ON again using the light switch on the steering column.

### ***Headlamp delay function (if equipped)***

If you place the ignition switch in to the ACC or OFF position with the headlamps ON, the headlamps (and/or parking lamps) remain on for about 5 minutes. However, with the engine off if the driver's door is opened and closed, the headlamps (and/or parking lamps) are turned off after 15 seconds.

The headlamps (and/or parking lamps) can be turned off by pressing the lock button on the smart key twice or turning the light switch to the OFF or AUTO position. However, if you turn the light switch to the AUTO position when it is dark outside, the headlamps will not be turned off.

You can activate or deactivate the Headlamp Delay function from the User Settings Mode on the LCD display. **For more details, refer to "LCD Display" in this chapter.**



## NOTICE

If the driver gets out of the vehicle through other doors (except driver's door), the battery saver function does not operate and the headlamp delay function does not turn off automatically. Therefore, it causes the battery to be discharged. In this case, make sure to turn off the lamp before getting out of the vehicle.

## Daytime running light (DRL) (if equipped)

The Daytime Running Lights (DRL) can make it easier for others to see the front of your vehicle during the day, especially after dawn and before sunset.

The DRL system will turn the dedicated lamp OFF when:

1. The headlights or front fog lights are in the ON position.
2. The parking switch is in the ON position.
3. The engine is turned off.

## Headlight leveling device (if equipped)

■ Left-hand drive



■ Right-hand drive



## Manual type

To adjust the headlight beam level according to the number of the passengers and loading weight in the luggage area, turn the beam leveling switch.

The higher the number of the switch position, the lower the headlight beam level. Always keep the headlight beam at the proper leveling position, or headlights may dazzle other road users.

Listed below are the examples of proper switch settings. For loading conditions other than those listed below, adjust the switch position so that the beam level may be the nearest as the condition obtained according to the list.

Loading condition	Switch position
Driver only	0
Driver + Front passenger	0
Full passengers (including driver)	1
Full passengers (including driver) + Maximum permissible loading	2
Driver + Maximum permissible loading	3

### Automatic type

It automatically adjusts the headlight beam level according to the number of passengers and loading weight in the luggage area.

And it offers proper headlight beam under various conditions.

### WARNING

**If it does not work properly even though your car is inclined backward according to passenger's posture, or the headlight beam is irradiated to the high or low position, we recommend that the system be inspected by an authorized HYUNDAI dealer.**

**Do not attempt to inspect or replace the wiring yourself.**

### Headlamp washer (if equipped)



Washer fluid will be sprayed on the headlamps at the same time you operate the windshield washer when:

1. The ignition switch is in the ON position.
2. The light switch is in the headlamp position (low beam).

### Information

- Check the headlamp washers periodically to confirm that the washer fluid is being sprayed properly onto the headlamp lenses.
- The headlamp washer can be operated 15 minutes after the last operation.

## Welcome system (if equipped)

### Welcome light (if equipped)



OTL045076

### Puddle lamp (if equipped)

When all the doors (and tailgate) are closed and locked, the puddle lamp will come on for about 15 seconds if any of the below is performed.

- When the door unlock button is pressed on the remote key or smart key.
- When the button of the outside door handle is pressed.
- When the vehicle is approached with the smart key in possession. (if equipped)

Also, if the outside rearview mirror folding switch is in the AUTO position, the outside rearview mirror will unfold automatically.

### Door handle lamp (if equipped)

When all the doors (and tailgate) are closed and locked, the door handle lamp will come on for about 15 seconds if any of the below is performed.

- When the door unlock button is pressed on the remote key or smart key.
- When the button of the outside door handle is pressed.
- When the vehicle is approached with the smart key in possession.

### Headlamp and Parking lamp

When the headlamp (lamp switch in the headlamp or AUTO position) is on and all doors (and tailgate) are locked and closed, the parking lamp and headlamp will come on for 15 seconds if/or any of the below is performed.

- When the door unlock button is pressed on the remote key or smart key.

At this time, if you press the door lock or unlock button, the parking lamp and headlamp will turn off immediately.

You can activate or deactivate the Welcome Light from the User Settings Mode on the LCD display. **For more details, refer to "LCD Display" in this chapter.**

### *Interior lamp*

When the interior lamp switch is in the DOOR position and all doors (and tailgate) are closed and locked, the room lamp will come on for 30 seconds if any of the below is performed.

- When the door unlock button is pressed on the remote key or smart key.
- When the button of the outside door handle is pressed.

At this time, if you press the door lock or unlock button, the room lamp will turn off immediately.

### Interior lights

#### **NOTICE**

**Do not use the interior lights for extended periods when the engine is turned off or the battery will discharge.**

#### **WARNING**

**Do not use the interior lights when driving in the dark. The interior lights may obscure your view and cause an accident.**

### *Interior lamp AUTO cut*

The interior lamps will automatically go off approximately 20 minutes after the engine is turned off and the doors closed. If a door is opened, the lamp will go off 40 minutes after the engine is turned off. If the doors are locked by the smart key and the vehicle enters the armed stage of the theft alarm system, the lamps will go off five seconds later.

## Front lamps

### ■ Type A



OTL045079

### ■ Type B



OTL045080

- (1) Front Map Lamp
- (2) Front Room Lamp
- (3) Front Door Lamp

## Front map lamp

Press the map lamp lens (1) to turn ON the map lamp. Re-press the map lamp cover to turn OFF the map lamp.

## Front room lamp

-  :

(Type A) Press the button to turn ON the room lamp for the front/rear seats.

(Type B) Press the button to turn ON the room lamp for the front/rear seats. Re-press the button to turn OFF the room lamp.

-  :

(Type A) Press the button to turn OFF the room lamp for the front/rear seats.

## Front door lamp ( )

The room lamp for the front/rear seats is automatically turned ON for approximately 30 seconds, when a door is opened.

The room lamp for the front/rear seats is automatically turned ON for approximately 15 seconds, when the remote key (smart key) unlocks the doors. The room lamp fades out, when the ignition switch is pressed to the ON position in 15 seconds. The room lamp remains ON up to 20 minutes, when a door is opened with the ignition switch in the either the ACC or OFF position.

### Rear lamps

■ Type A



■ Type B



### Rear Room Lamp Switch ( ):

Press this button to turn the room lamp on and off.

### NOTICE

Do not leave the lamp switches on for an extended period of time when the engine is turned off.

### Tailgate room lamp



The tailgate room lamp comes on when the tailgate is opened.

### NOTICE

The tailgate lamp comes on as long as the tailgate lid is open. To prevent unnecessary charging system drain, close the tailgate lid securely after using the tailgate.

### Glove box lamp



The glove box lamp comes on when the glove box is opened.

If the glove box is not closed, the lamp will turn off after 20 minutes.



#### NOTICE

To prevent unnecessary charging system drain, close the glove box securely after using the glove box.

### Vanity mirror lamp



Push the switch to turn the light on or off.

-  : The lamp will turn on if this button is pressed.
-  : The lamp will turn off if this button is pressed.

#### NOTICE

Always have the switch in the off position when the vanity mirror lamp is not in use. If the sunvisor is closed without the lamp off, it may discharge the battery or damage the sunvisor.

### ***Puddle lamp (if equipped)***

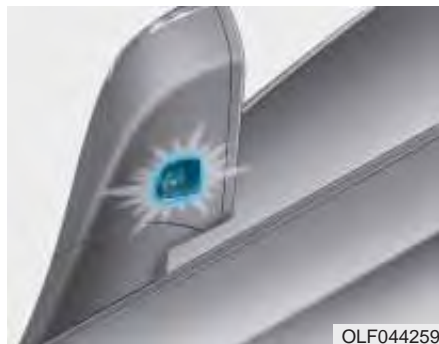

### **Welcome light**

When all doors (and tailgate) are closed and locked, the puddle lamp will come on for 15 seconds if the door is unlocked by the smart key or outside door handle button.

**For more details, refer to "Welcome System" in this chapter.**

### **Escort light**

When the ignition switch is in the OFF position and the driver's door is opened, the puddle lamp will come on for 30 seconds. If the driver's door is closed within the 30 seconds, the puddle lamp will turn off after 15 seconds. If the driver's door is closed and locked, the puddle lamp will turn off immediately.

The Puddle Lamp Escort Light will turn on only the first time the driver's door is opened after the engine is turned off.



## WIPERS AND WASHERS

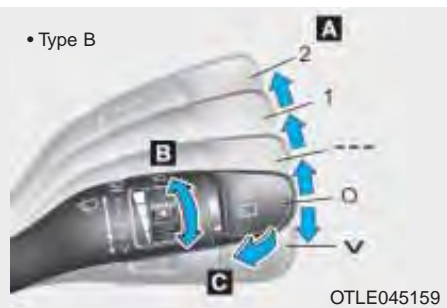
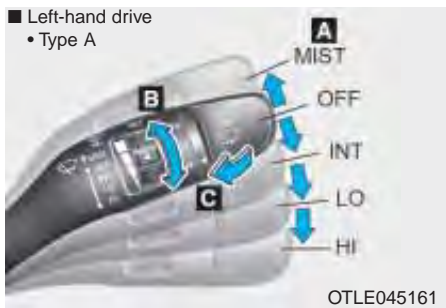

- A : Wiper speed control (front)**
- MIST – Single wipe
  - O / OFF – Off
  - --- / INT – Intermittent wipe
  - AUTO\* – Auto control wipe
  - 1 / LO– Low wiper speed
  - 2 / HI – High wiper speed

- B : Intermittent control wipe time adjustment**

- C : Wash with brief wipes (front)\***

- D : Rear wiper/washer control\***
- HI / 2 – High wiper speed
  - LO / 1 – Low wiper speed
  - OFF / O – Off

- E : Wash with brief wipes (rear)**

\* : if equipped

### Windshield wipers

Operates as follows when the ignition switch is turned ON.

**MIST** : For a single wiping cycle, move the lever to this (MIST) position and release it. The wipers will operate continuously if the lever is held in this position.

**O/OFF** : Wiper is not in operation

**---/INT** : Wiper operates intermittently at the same wiping intervals. Use this mode in light rain or mist. To vary the speed setting, turn the speed control knob.

**1/LO** : Normal wiper speed

**2/HI** : Fast wiper speed

### **i** Information

**If there is heavy accumulation of snow or ice on the windshield, defrost the windshield for about 10 minutes, or until the snow and/or ice is removed before using the windshield wipers to ensure proper operation.**

**If you do not remove the snow and/or ice before using the wiper and washer, it may damage the wiper and washer system.**

### Windshield washers

- Left-hand drive
  - Type A

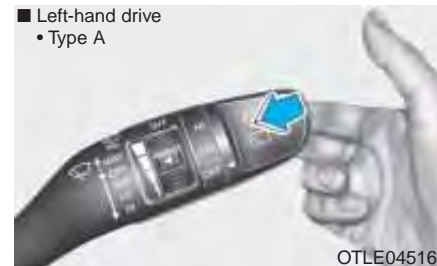

- Type B

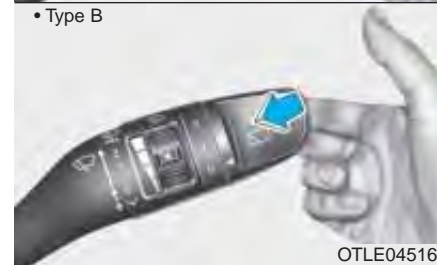

- Right-hand drive



In the OFF (O) position, pull the lever gently toward you to spray washer fluid on the windshield and to run the wipers 1-3 cycles. The spray and wiper operation will continue until you release the lever.

If the washer does not work, you may need to add washer fluid to the washer fluid reservoir.

If equipped with the Headlamp Washer, washer fluid will be sprayed on the headlamp at the same time you operate the windshield washer when:

1. The ignition switch is in the ON position.
2. The light switch is in the headlamp position.

### WARNING

When the outside temperature is below freezing, **ALWAYS** warm the windshield using the defroster to prevent the washer fluid from freezing on the windshield and obscuring your vision which could result in an accident and serious injury or death.

### CAUTION

- To prevent possible damage to the washer pump, do not operate the washer when the fluid reservoir is empty.
- To prevent possible damage to the wipers or windshield, do not operate the wipers when the windshield is dry.
- To prevent damage to the wiper arms and other components, do not attempt to move the wipers manually.
- To prevent possible damage to the wipers and washer system, use anti-freezing washer fluids in the winter season or cold weather.

## Rear window wiper and washer switch (if equipped)



## Convenient features of your vehicle

The rear window wiper and washer switch is located at the end of the wiper and washer switch lever. Turn the switch to the desired position to operate the rear wiper and washer.

HI / 2 – High wiper speed

LO / 1– Low wiper speed

OFF / O – Off



Push the lever away from you to spray rear washer fluid and to run the rear wipers 1~3 cycles. The spray and wiper operation will continue until you release the lever. (if equipped)

## DRIVER ASSIST SYSTEM

### Rear view camera (if equipped)



The Rear View Camera will activate when the engine is running and the shift lever is in the R (Reverse) position.

This is a supplemental system that shows behind the vehicle through the mirror or navigation display while backing-up.

#### ■ Type A

The rear view camera can be turned off by pressing the ON/OFF button when the rear view camera is activated. Press the ON/OFF button once more to turn on the rear view camera when the engine is running and the shift lever is in R (Reverse).

#### WARNING

**The rear camera display is not a safety device. It only serves to assist the driver in identifying objects directly behind the middle of the vehicle. The camera does NOT cover the complete area behind the vehicle.**

### WARNING

- Never rely solely on the rear camera display when backing-up.
- ALWAYS look around your vehicle to make sure there are no objects or obstacles before moving the vehicle in any direction to prevent a collision.
- Always pay close attention when the vehicle is driven close to objects, particularly pedestrians, and especially children.

### Information

Always keep the camera lens clean. The camera may not work normally if the lens is covered with foreign material.

### Rear parking assist system (if equipped)



The Rear Parking Assist System assists the driver during reverse movement of the vehicle by chiming if any object is sensed within the distance of 120 cm (50 inches) behind the vehicle.

This system is a supplemental system that senses objects within the range and location of the sensors, it cannot detect objects in other areas where sensors are not installed.

### WARNING



- ALWAYS look around your vehicle to make sure there are not any objects or obstacles before moving the vehicle in any direction to prevent a collision.
- Always pay close attention when the vehicle is driven close to objects, particularly pedestrians, and especially children.
- Be aware that some objects may not be visible on the screen or be detected by the sensors, due to the objects distance, size or material, all of which can limit the effectiveness of the sensor.

## Operation of the Rear Parking Assist System

### Operating condition

- This system will activate when backing up with the ignition switch in the ON position. However, if vehicle speed exceeds 5 km/h (3 mph), the system may not detect objects.
- If vehicle speed exceeds 10 km/h (6 mph), the system will not warn you even though objects are detected.
- When more than two objects are sensed at the same time, the closest one will be recognized first.

### Types of warning sound and indicator

Types of warning sound	Indicator
When an object is 120 cm to 60 cm (47 in. to 24 in.) from the rear bumper : Buzzer beeps intermittently.	
When an object is 60 cm to 30 cm (24 in. to 12 in.) from the rear bumper : Buzzer beeps more frequently.	
When an object is within 30 cm (12 in.) of the rear bumper : Buzzer beeps continuously.	

### NOTICE

- The indicator may differ from the illustration as objects or sensors status. If the indicator blinks, we recommend that you have your vehicle checked by an authorized HYUNDAI dealer.
- If the audible warning does not sound or if the buzzer sounds intermittently when shifting into R (Reverse) position, this may indicate a malfunction with the Parking Assist System. If this occurs, we recommend that you have your vehicle checked by an authorized HYUNDAI dealer as soon as possible.



**To turn off the Rear Parking Assist System (if equipped)**



Push the button to turn off the Rear Parking Assist System. The indicator light on the button will turn on.

**Non-operational conditions of Parking Assist System**

The Rear Parking Assist System may not operate normally when:

- Moisture is frozen to the sensor.
- Sensor is covered with foreign matter, such as snow or water, or the sensor cover is blocked.

There is a possibility of the Rear Parking Assist System malfunction when:

- Driving on uneven road surfaces such as unpaved roads, gravel, bumps, or gradient.
- Objects generating excessive noise such as vehicle horns, loud motorcycle engines, or truck air brakes can interfere with the sensor.
- Heavy rain or water spray is present.
- Wireless transmitters or mobile phones are present near the sensor.
- The sensor is covered with snow.
- Any non-factory equipment or accessories have been installed, or if the vehicle bumper height or sensor installation has been modified.



**Detecting range may decrease when:**

- Outside air temperature is extremely hot or cold.
- Undetectable objects smaller than 1 m (40 inches) and narrower than 14 cm (6 inches) in diameter.

**The following objects may not be recognized by the sensor:**

- Sharp or slim objects such as ropes, chains or small poles.
- Objects, which tend to absorb sensor frequency such as clothes, spongy material or snow.

**NOTICE**

Sensor may not recognize objects less than 30 cm (12 inches) from the sensor, or it may sense an incorrect distance.

**NOTICE**

Do not push, scratch or strike the sensor with any hard objects that could damage the surface of the sensor. Sensor damage could occur.

**WARNING**

Your new vehicle warranty does not cover any accidents or damage to the vehicle or injuries to its occupants related to a Rear Parking Assist System. Always drive safely and cautiously.

**Parking Assist System (if equipped)**

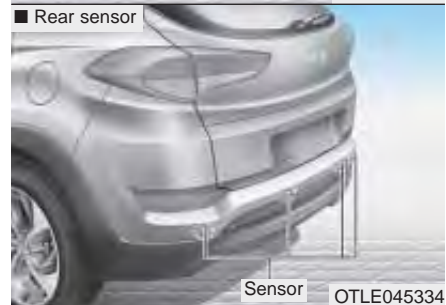
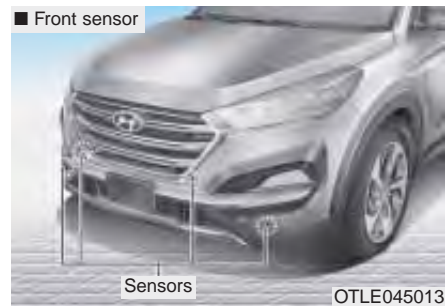

The Parking Assist System assists the driver during movement of the vehicle by chiming if any object is sensed within the distance of 100 cm (39 inches) in front and 120 cm (47 inches) behind the vehicle.

This system is a supplemental system that senses objects within the range and location of the sensors, it cannot detect objects in other areas where sensors are not installed.

### WARNING

- ALWAYS look around your vehicle to make sure there are not any objects or obstacles before moving the vehicle in any direction to prevent a collision.
- Always pay close attention when the vehicle is driven close to objects, particularly pedestrians, and especially children.
- Be aware that some objects may not be visible on the screen or be detected by the sensors, due to the objects distance, size or material, all of which can limit the effectiveness of the sensor.

### Operation of the Parking Assist System









### Operating condition

- This system will activate when the Parking Assist System button is pressed with the engine running.

- The Parking Assist System button turns on automatically and activates the Parking Assist System when you move the shift lever to the R (Reverse) position. However, if vehicle speed exceeds 10 km/h (6 mph), the system will not warn you even though objects are detected, and if vehicle speed exceeds 20 km/h (12 mph), the system will turn off automatically. To turn on the system, press the Parking Assist System button.
- When more than two objects are sensed at the same time, the closest one will be recognized first.

**Types of warning sound and indicator**

Distance from object		Warning indicator		Warning sound
		When driving forward	When driving rearward	
100cm~61cm	Front		-	Buzzer beeps intermittently
120cm~61cm	Rear	-		Buzzer beeps intermittently
60cm~31cm	Front			Buzzer beeps frequently
	Rear	-		Buzzer beeps frequently
30cm	Front			Buzzer sounds continuously
	Rear	-		Buzzer sounds continuously

**NOTICE**

- The indicator may differ from the illustration as objects or sensors status. If the indicator blinks, we recommend that the system be checked by an authorized HYUNDAI dealer.
- If the audible warning does not sound or if the buzzer sounds intermittently when shifting into R (Reverse) position, this may indicate a malfunction with the Parking Assist System. If this occurs, we recommend that you have your vehicle checked by an authorized HYUNDAI dealer as soon as possible.

### ***Non-operational conditions of Parking Assist System***

**Parking Assist System may not operate normally when:**

- Moisture is frozen to the sensor.
- Sensor is covered with foreign matter, such as snow or water, or the sensor cover is blocked.

**There is a possibility of Parking Assist System malfunction when:**

- Driving on uneven road surfaces such as unpaved roads, gravel, bumps, or gradient.
- Objects generating excessive noise such as vehicle horns, loud motorcycle engines, or truck air brakes can interfere with the sensor.
- Heavy rain or water spray is present.
- Wireless transmitters or mobile phones are present near the sensor.
- The sensor is covered with snow.
- Any non-factory equipment or accessories have been installed, or if the vehicle bumper height or sensor installation has been modified.

**Detecting range may decrease when:**

- Outside air temperature is extremely hot or cold.
- Undetectable objects smaller than 1 m and narrower than 14 cm in diameter.

**The following objects may not be recognized by the sensor:**

- Sharp or slim objects such as ropes, chains or small poles.
- Objects, which tend to absorb sensor frequency such as clothes, spongy material or snow.

**i** Information

Sensor may not recognize objects less than 30 cm from the sensor, or it may sense an incorrect distance.

**NOTICE**

Do not push, scratch or strike the sensor with any hard objects that could damage the surface of the sensor. Sensor damage could occur.

**⚠ WARNING**

Your new vehicle warranty does not cover any accidents or damage to the vehicle or injuries to its occupants related to a Parking Assist System. Always drive safely and cautiously.

## DEFROSTER

### NOTICE

To prevent damage to the conductors bonded to the inside surface of the rear window, never use sharp instruments or window cleaners containing abrasives to clean the window.

### **i** Information

If you want to defrost and defog the front windshield, refer to “Windshield Defrosting and Defogging” in this chapter.

### Rear window defroster

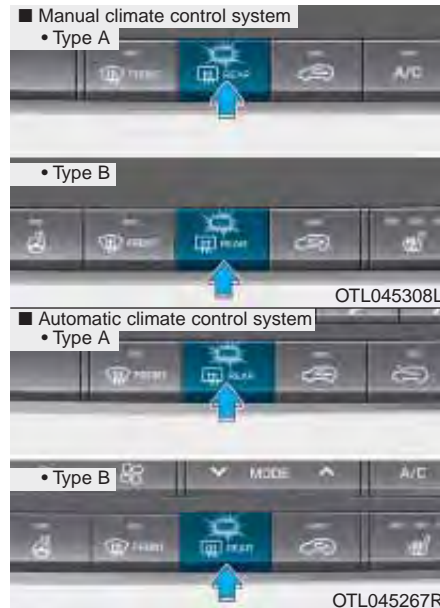

The defroster heats the window to remove frost, fog and thin ice from the interior and exterior of the rear window, while engine is running.

- To activate the rear window defroster, press the rear window defroster button located in the center facia switch panel. The indicator on the rear window defroster button illuminates when the defroster is ON.
- To turn off the defroster, press the rear window defroster button again.

### **i** Information

- If there is heavy accumulation of snow on the rear window, brush it off before operating the rear defroster.
- The rear window defroster automatically turns off after approximately 20 minutes or when the Engine Start/Stop button is in the OFF position.

---

***Outside mirror defroster  
(if equipped)***

If your vehicle is equipped with the outside mirror defrosters, they will operate at the same time you turn on the rear window defroster.

***Front wiper deicer (if equipped)***

If your vehicle is equipped with the wiper deicer, it will operate at the same time you turn on the rear window defroster.

## MANUAL CLIMATE CONTROL SYSTEM (IF EQUIPPED)

### ■ Type A



1. Fan speed control knob
2. Temperature control knob
3. Mode selection buttons
4. Front windshield defroster button
5. Rear window defroster button
6. Air intake control button
7. A/C (Air conditioning) button\*

\* : if equipped

### ■ Type B





OTL045207/OTL045207R



## Heating and air conditioning

1. Start the engine.
2. Set the mode to the desired position.

To improve the effectiveness of heating and cooling :

- Heating: 
- Cooling: 

3. Set the temperature control to the desired position.
4. Set the air intake control to the outside (fresh) air position.
5. Set the fan speed control to the desired speed.
6. If air conditioning is desired, turn the air conditioning system on.

## Mode selection

■ Left-hand drive

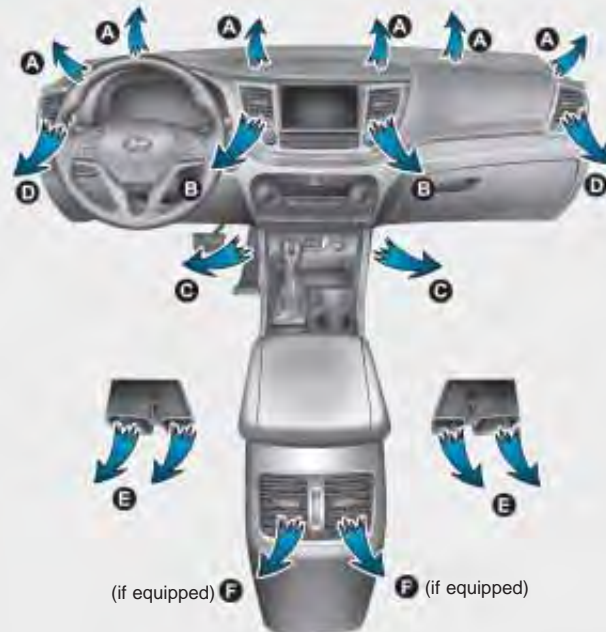

OTLE045173

## Convenient features of your vehicle

### ■ Right-hand drive



OTL045503R

### ■ Type A



### ■ Type B



The mode selection button controls the direction of the air flow through the ventilation system.

Air can be directed to the floor, dashboard outlets, or windshield. Five symbols are used to represent Face, Bi-Level, Floor, Floor-Defrost and Defrost air position.



**Face-Level (B, D, F)**

Air flow is directed toward the upper body and face. Additionally, each outlet can be controlled to direct the air discharged from the outlet.



**Bi-Level (B, C, D, E, F)**

Air flow is directed towards the face and the floor.



**Floor-Level (A, C, E, D)**

Most of the air flow is directed to the floor, with a small amount of the air being directed to the windshield and side window defrosters.



**Floor/Defrost-Level (A, C, D, E)**

Most of the air flow is directed to the floor and the windshield with a small amount directed to the side window defrosters.



**Defrost-Level (A, D)**

Most of the air flow is directed to the windshield with a small amount of air directed to the side window defrosters.



OTL045209

**MAX A/C (if equipped)**

To operate the MAX A/C, turn the mode selection knob to extreme left. Air flow is directed toward the upper body and face.

In this mode, the air conditioning and the recirculated air position will be selected automatically.

■ Left-hand drive



OTL045086

■ Right-hand drive



OTL045086R

### Instrument panel vents

The outlet vents can be opened or closed separately using the thumb-wheel.

Also, you can adjust the direction of air delivery from these vents using the vent control lever as shown.

### Temperature control (if equipped)



OTLE045287R

The temperature control knob allows you to control the temperature of the air flowing from the ventilation system. To change the air temperature in the passenger compartment, turn the knob to the right position for warm and hot air or left position for cooler air.

### Air intake control

■ Type A



OTL045211L

■ Type B



OTL045211R

This is used to select outside (fresh) air position or recirculated air position. To change the air intake control position, press the control button.

### Recirculated air position



With the recirculated air position selected, air from the passenger compartment will be drawn through the heating system and heated or cooled according to the function selected.

### Outside (fresh) air position



With the outside (fresh) air position selected, air enters the vehicle from outside and is heated or cooled according to the function selected.

### **i** Information

It should be noted that prolonged operation of the heater in the recirculated air position (without air conditioning selected) will cause fogging of the windshield and side windows and the air within the passenger compartment will become stale.

In addition, prolonged use of the air conditioning with the recirculated air position selected will result in excessively dry air in the passenger compartment.

### **⚠** WARNING

- Continuous operation of the climate control system in the recirculated air position may allow humidity to increase inside the vehicle which may fog the glass and obscure visibility.
- Do not sleep in a vehicle with air conditioning or heating system on. It may cause serious harm or death due to a drop in the oxygen level and/or body temperature.
- Continuous operation of the climate control system in the recirculated air position can cause drowsiness or sleepiness, and loss of vehicle control. Set the air intake control to the outside (fresh) air position as much as possible while driving.

### **i** Information

### Fan speed control



OTL045212

The ignition switch must be in the ON position for fan operation.

The fan speed control knob allows you to control the fan speed of the air flowing from the ventilation system. To change the fan speed, turn the knob to the right for higher speed or left for lower speed.



OTLE045288R

#### To turn off the fan

To turn off the fan, turn the fan speed control knob to the "0" position.

#### **NOTICE**

**Operating fan speed when the Engine ignition switch is in the ON position could cause the battery to discharge. Operate fan speed when the engine is running.**

### Air conditioning (A/C) (if equipped)



OTL045213L

Press the A/C button to turn the air conditioning system on (indicator light will illuminate). Press the button again to turn the air conditioning system off.



## System operation

### Ventilation

1. Set the mode to the  position.
2. Set the air intake control to the outside (fresh) air position.
3. Set the temperature control to the desired position.
4. Set the fan speed control to the desired speed.

### Heating

1. Set the mode to the  position.
2. Set the air intake control to the outside (fresh) air position.
3. Set the temperature control to the desired position.
4. Set the fan speed control to the desired speed.
5. If dehumidified heating is desired, turn the air conditioning system (if equipped) on.

If the windshield fogs up, set the mode to the  or  position.

### Operation Tips

- To keep dust or unpleasant fumes from entering the car through the ventilation system, temporarily set the air intake control to the recirculated air position. Be sure to return the control to the fresh air position when the irritation has passed to keep fresh air in the vehicle. This will help keep the driver alert and comfortable.
- Air for the heating/cooling system is drawn in through the grilles just ahead of the windshield. Care should be taken that these are not blocked by leaves, snow, ice or other obstructions.
- To prevent interior fog on the windshield, set the air intake control to the fresh air position and fan speed to the desired position, turn on the air conditioning system, and adjust the temperature control to desired temperature.

### Air conditioning

HYUNDAI Air Conditioning Systems are filled with R-134a or R-1234yf refrigerant.

1. Start the engine. Push the air conditioning button.
2. Set the mode to the  position.
3. Set the air intake control to the outside air or recirculated air position.
4. Adjust the fan speed control and temperature control to maintain maximum comfort.

### Information

**Your vehicle is filled with R-134a or R-1234yf according to the regulation in your country at the time of production. You can find out which air conditioning refrigerant is applied to your vehicle on the label located inside of the hood. Refer to chapter 8 for the location of the air conditioning refrigerant label.**



### NOTICE

- The refrigerant system should only be serviced by trained and certified technicians to insure proper and safe operation.
- The refrigerant system should be serviced in a well-ventilated place.
- The air conditioning evaporator (cooling coil) shall never be repaired or replaced with one removed from a used or salvaged vehicle and new replacement MAC evaporators shall be certified (and labeled) as meeting SAE Standard J2842.

### **i** Information

- When using the air conditioning system, monitor the temperature gauge closely while driving up hills or in heavy traffic when outside temperatures are high. Air conditioning system operation may cause engine overheating. Continue to use the blower fan but turn the air conditioning system off if the temperature gauge indicates engine overheating.
- When opening the windows in humid weather air conditioning may create water droplets inside the vehicle. Since excessive water droplets may cause damage to electrical equipment, air conditioning should only be used with the windows closed.

### Air conditioning system operation tips

- If the vehicle has been parked in direct sunlight during hot weather, open the windows for a short time to let the hot air inside the vehicle escape.
- To help reduce moisture inside of the windows on rainy or humid days, decrease the humidity inside the vehicle by operating the air conditioning system.
- During air conditioning system operation, you may occasionally notice a slight change in engine speed as the air conditioning compressor cycles. This is a normal system operation characteristic.
- Use the air conditioning system every month only for a few minutes to ensure maximum system performance.
- When using the air conditioning system, you may notice clear water dripping (or even puddling) on the ground under the passenger side of the vehicle. This is a normal system operation characteristic.



- Operating the air conditioning system in the recirculated air position provides maximum cooling, however, continual operation in this mode may cause the air inside the vehicle to become stale.
- During cooling operation, you may occasionally notice a misty air flow because of rapid cooling and humid air intake. This is a normal system operation characteristics.

### System maintenance

#### Climate control air filter

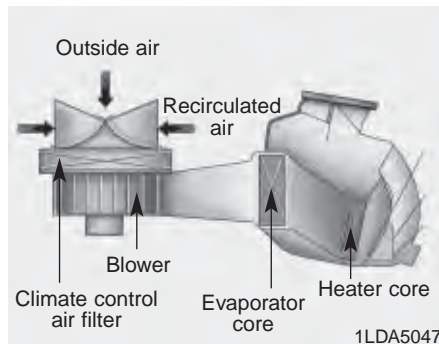

The climate control air filter installed behind the glove box filters the dust or other pollutants that come into the vehicle from the outside through the heating and air conditioning system. If dust or other pollutants accumulate in the filter over a period of time, the air flow from the air vents may decrease, resulting in moisture accumulation on the inside of the windshield even when the outside (fresh) air position is selected. If this happens, we recommend that the climate control air filter be replaced by an authorized HYUNDAI dealer.

#### **i** Information

- Replace the filter according to the Maintenance Schedule.

If the car is being driven in severe conditions such as dusty, rough roads, more frequent climate control air filter inspections and changes are required.

- When the air flow rate suddenly decreases, we recommend that the system be checked by an authorized HYUNDAI dealer.

#### **i** Information

It is important that the correct type and amount of oil and refrigerant is used. Otherwise, damage to the compressor and abnormal system operation may occur.

**⚠ WARNING**

We recommend that the air conditioning system be serviced by an authorized HYUNDAI dealer.

Improper service may cause serious injury to the person performing the service.

### Air Conditioning refrigerant label

The actual Air Conditioning refrigerant



label in the vehicle may differ from the illustration.

Each symbols and specification on air conditioning refrigerant label means as below :

1. Classification of refrigerant
2. Amount of refrigerant
3. Classification of Compressor Lubricant

You can find out which air conditioning refrigerant is applied to your vehicle on the label located inside of the hood. Refer to chapter 8 for the location of the air conditioning refrigerant label.

## Checking the amount of air conditioner refrigerant and compressor lubricant

When the amount of refrigerant is low, the performance of the air conditioning is reduced. Overfilling also has a bad influence on the air conditioning system.

Therefore, if abnormal operation is found, we recommend that the system be inspected by an authorized HYUNDAI dealer.

### WARNING

#### Vehicles equipped with R-134a



Because the refrigerant is at very high pressure, the air conditioning system should only be serviced by trained and certified technicians. It is important that the correct type and amount of oil and refrigerant is used.

Otherwise, it may cause damage to the vehicle and personal injury.

### WARNING

#### Vehicles equipped with R-1234yf



Because the refrigerant is mildly flammable at very high pressure, the air conditioning system should only be serviced by trained and certified technicians. It is important that the correct type and amount of oil and refrigerant is used.

Otherwise, it may cause damage to the vehicle and personal injury.

We recommend the air conditioning system be serviced by an authorized HYUNDAI dealer.

## AUTOMATIC CLIMATE CONTROL SYSTEM (IF EQUIPPED)

### ■ Type A



1. Passenger temperature control knob
2. Driver's temperature control knob
3. SYNC button
4. AUTO (automatic control) button
5. OFF button
6. Fan speed control button
7. Mode selection button
8. Air conditioning button
9. Front windshield defrost button
10. Rear window defrost button
11. Air intake control button
12. Climate control information screen

### ■ Type B



OTLE045267R/OTLE045266R

## Automatic heating and air conditioning



OTL045215

1. Press the AUTO button.

The modes, fan speeds, air intake and air-conditioning will be controlled automatically according to the temperature setting.



OTL045216

2. Turn the temperature control knob to set the desired temperature.

### **i** Information

- To turn the automatic operation off, select any button of the following:
  - Mode selection button
  - Front windshield defrost button (Press the button one more time to deselect the front windshield defroster function. The 'AUTO' sign will illuminate on the information display once again.)
  - Fan speed control button
- **The selected function will be controlled manually while other functions operate automatically.**
- For your convenience, use the AUTO button and set the temperature to 23°C (73°F).





### **i** Information

**Never place anything near the sensor to ensure better control of the heating and cooling system.**

### Manual heating and air conditioning

The heating and cooling system can be controlled manually by pushing buttons other than the AUTO button. In this case, the system works sequentially according to the order of buttons selected. When pressing any button except the AUTO button while using automatic operation, the functions not selected will be controlled automatically.

1. Start the engine.
2. Set the mode to the desired position.  
For improving the effectiveness of heating and cooling;
  - Heating: 
  - Cooling: 
3. Set the temperature control to the desired position.

4. Set the air intake control to the outside (fresh) air position.
5. Set the fan speed control to the desired speed.
6. If air conditioning is desired, turn the air conditioning system on.  
Press the AUTO button in order to convert to full automatic control of the system.

## Mode selection

■ Left-hand drive



OTL045249

■ Right-hand drive

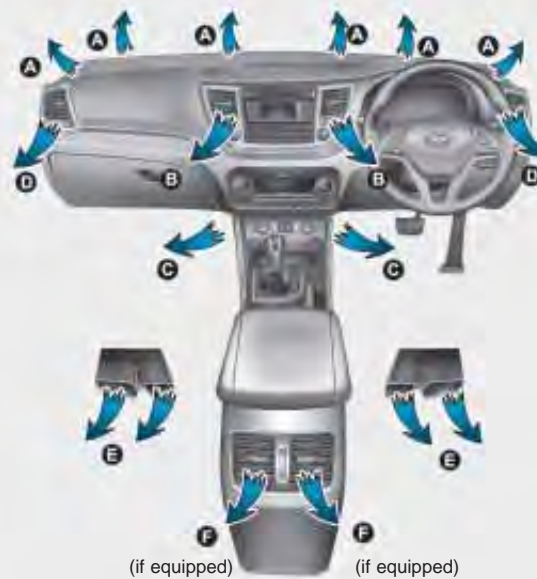

OTL045249R

## Convenient features of your vehicle

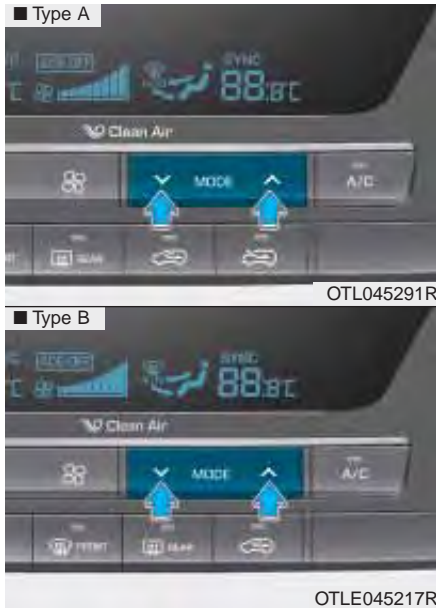

The mode selection button controls the direction of the air flow through the ventilation system.



### Face-Level (B, D, F)

Air flow is directed toward the upper body and face. Additionally, each outlet can be controlled to direct the air discharged from the outlet.



### Floor-Level (A, C, D, E)

Most of the air flow is directed to the floor, with a small amount of the air being directed to the windshield and side window defrosters.



### Bi-Level (B, C, D, E, F)

Air flow is directed towards the face and the floor.



### Floor/Defrost-Level (A, C, D, E)

Most of the air flow is directed to the floor and the windshield with a small amount directed to the side window defrosters.





### Defrost-Level (A)

Most of the air flow is directed to the windshield with a small amount of air directed to the side window defrosters.



### Instrument panel vents

The outlet vents can be opened or closed separately using the thumb-wheel. To close the vent, rotate it left (Rear : down) to the maximum position. To open the vent, rotate it right (Rear : up) to the desired position.

Also, you can adjust the direction of air delivery from these vents using the vent control lever as shown.

### Temperature control



Turn the temperature control knob to set the desired temperature.



### Adjusting the driver and passenger side temperature equally

- Press the “SYNC” button to adjust the driver and passenger side temperature equally.  
The passenger side temperature will be set to the same temperature as the driver side temperature.
- Turn the driver side temperature control knob. The driver and passenger side temperature will be adjusted equally.

### Adjusting the driver and passenger side temperature individually

- Press the “SYNC” button again to adjust the driver and passenger side temperature individually. The illumination of button turns off.
- Operate the driver side temperature control knob to adjust the driver side temperature.
- Operate the passenger side temperature control knob to adjust the passenger side temperature.

### Temperature conversion

If the battery has been discharged or disconnected, the temperature mode display will reset to Centigrade.

This is a normal condition. You can switch the temperature mode between Centigrade to Fahrenheit as follows;

- Automatic climate control system  
While pressing the OFF button, press the AUTO button for 3 seconds or more. The display will change from Centigrade to Fahrenheit, or from Fahrenheit to Centigrade.
- "User setting mode" in the cluster :  
You can change the temperature unit in the "Other features - Temperature unit"

### Air intake control



This is used to select the outside (fresh) air position or recirculated air position.

To change the air intake control position, push the control button.

### Recirculated air position



With the recirculated air position selected, air from the passenger compartment will be drawn through the heating system and heated or cooled according to the function selected.

### Outside (fresh) air position

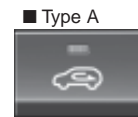

With the outside (fresh) air position selected, air enters the vehicle from outside and is heated or cooled according to the function selected.

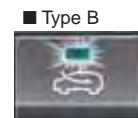

### **i** Information

Prolonged operation of the heater in the recirculated air position (without air conditioning selected) may cause fogging of the windshield and side windows and the air within the passenger compartment may become stale.

In addition, prolonged use of the air conditioning with the recirculated air position selected will result in excessively dry air in the passenger compartment.

### **⚠** WARNING

- Continued climate control system operation in the recirculated air position may allow humidity to increase inside the vehicle which may fog the glass and obscure visibility.
- Do not sleep in a vehicle with the air conditioning or heating system on. It may cause serious harm or death due to a drop in the oxygen level and/or body temperature.
- Continued climate control system operation in the recirculated air position can cause drowsiness or sleepiness, and loss of vehicle control. Set the air intake control to the outside (fresh) air position as much as possible while driving.

### *Fan speed control*



The fan speed can be set to the desired speed by pushing the fan speed control button.

The higher the fan speed is, the more air is delivered.

Pressing the OFF button turns off the fan.

#### NOTICE

Operating fan speed when the ignition switch is in the ON position could cause the battery to discharge. Operate fan speed when the engine is running.

### Air conditioning



Push the A/C button to turn the air conditioning system on (indicator light will illuminate).

Push the button again to turn the air conditioning system off.

### OFF mode





Push the OFF button of the front to turn off the air climate control system. However, you can still operate the mode and air intake buttons as long as the ignition switch is in the ON position.

### System operation

#### Ventilation

1. Set the mode to the  position.
2. Set the air intake control to the outside (fresh) air position.
3. Set the temperature control to the desired position.
4. Set the fan speed control to the desired speed.

#### Heating

1. Set the mode to the  position.
2. Set the air intake control to the outside (fresh) air position.
3. Set the temperature control to the desired position.
4. Set the fan speed control to the desired speed.
5. If dehumidified heating is desired, turn the air conditioning system on.
  - If the windshield fogs up, set the mode to the  or  position.

#### Operation Tips

- To keep dust or unpleasant fumes from entering the vehicle through the ventilation system, temporarily set the air intake control to the recirculated air position. Be sure to return the control to the fresh air position when the irritation has passed to keep fresh air in the vehicle. This will help keep the driver alert and comfortable.
- Air for the heating/cooling system is drawn in through the grilles just ahead of the windshield. Care should be taken that these are not blocked by leaves, snow, ice or other obstructions.
- To prevent interior fog on the windshield, set the air intake control to the fresh air position and fan speed to the desired position, turn on the air conditioning system, and adjust the temperature control to desired temperature.

#### Air conditioning

HYUNDAI Air Conditioning Systems are filled with R-134a or R-1234yf refrigerant.

1. Start the engine. Push the air conditioning button.
2. Set the mode to the  position.
3. Set the air intake control to the outside air or recirculated air position.
4. Adjust the fan speed control and temperature control to maintain maximum comfort.

#### Information

**Your vehicle is filled with R-134a or R-1234yf according to the regulation in your country at the time of production. You can find out which air conditioning refrigerant is applied to your vehicle on the label located inside of the hood. Refer to chapter 8 for the location of the air conditioning refrigerant label.**

## NOTICE

- The refrigerant system should only be serviced by trained and certified technicians to insure proper and safe operation.
- The refrigerant system should be serviced in a well-ventilated place.
- The air conditioning evaporator (cooling coil) shall never be repaired or replaced with one removed from a used or salvaged vehicle and new replacement MAC evaporators shall be certified (and labeled) as meeting SAE Standard J2842.

## **i** Information

- When using the air conditioning system, monitor the temperature gauge closely while driving up hills or in heavy traffic when outside temperatures are high. Air conditioning system operation may cause engine overheating. Continue to use the blower fan but turn the air conditioning system off if the temperature gauge indicates engine overheating.

(Continued)

(Continued)

- When opening the windows in humid weather air conditioning may create water droplets inside the vehicle. Since excessive water droplets may cause damage to electrical equipment, air conditioning should only be used with the windows closed.

## Air conditioning system operation tips

- If the vehicle has been parked in direct sunlight during hot weather, open the windows for a short time to let the hot air inside the vehicle escape.
- Use air conditioning to reduce humidity and moisture inside the vehicle on rainy or humid days.
- During air conditioning system operation, you may occasionally notice a slight change in engine speed as the air conditioning compressor cycles. This is a normal system operation characteristic.

- Use the air conditioning system every month only for a few minutes to ensure maximum system performance.
- When using the air conditioning system, you may notice clear water dripping (or even puddling) on the ground under the passenger side of the vehicle. This is a normal system operation characteristic.
- Operating the air conditioning system in the recirculated air position provides maximum cooling, however, continual operation in this mode may cause the air inside the vehicle to become stale.
- During cooling operation, you may occasionally notice a misty air flow because of rapid cooling and humid air intake. This is a normal system operation characteristic.



### System maintenance

#### Climate control air filter

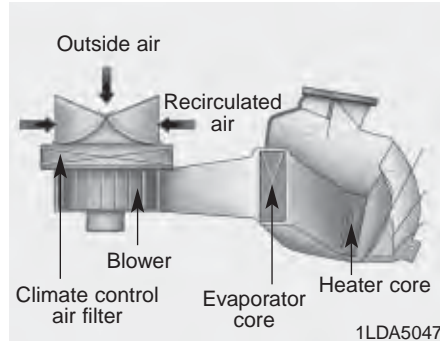

The climate control air filter installed behind the glove box filters the dust or other pollutants that come into the vehicle from the outside through the heating and air conditioning system. If dust or other pollutants accumulate in the filter over a period of time, the air flow from the air vents may decrease, resulting in moisture accumulation on the inside of the windshield even when the outside (fresh) air position is selected. If this happens, we recommend that the climate control air filter be replaced by an authorized HYUNDAI dealer.

#### **i** Information

- Replace the filter according to the Maintenance Schedule.

If the car is being driven in severe conditions such as dusty, rough roads, more frequent climate control air filter inspections and changes are required.

- When the air flow rate suddenly decreases, we recommend that the system be checked by an authorized HYUNDAI dealer.

### Air Conditioning refrigerant label

The actual Air Conditioning refrigerant



ant label in the vehicle may differ from the illustration.



Each symbols and specification on air conditioning refrigerant label means as below :

1. Classification of refrigerant
2. Amount of refrigerant
3. Classification of Compressor lubricant

You can find out which air conditioning refrigerant is applied to your vehicle on the label located inside of the hood. Refer to chapter 8 for the location of the air conditioning refrigerant label.

### Checking the amount of air conditioner refrigerant and compressor lubricant

When the amount of refrigerant is low, the performance of the air conditioning is reduced. Overfilling also has a bad influence on the air conditioning system.

Therefore, if abnormal operation is found, we recommend that the system be inspected by an authorized HYUNDAI dealer.

 **WARNING**

Vehicles equipped with R-134a

 Because the refrigerant is at very high pressure, the air conditioning system should only be serviced by trained and certified technicians. It is important that the correct type and amount of oil and refrigerant is used.

Otherwise, it may cause damage to the vehicle and personal injury.

 **WARNING**

Vehicles equipped with R-1234yf

 Because the refrigerant is mildly inflammable at very high pressure, the air conditioning system should only be serviced by trained and certified technicians. It is important that the correct type and amount of oil and refrigerant is used.



 Otherwise, it may cause damage to the vehicle and personal injury.

We recommend the air conditioning system be serviced by an authorized HYUNDAI dealer.

## WINDSHIELD DEFROSTING AND DEFOGGING

### ⚠ WARNING

#### Windshield heating



Do not use the  or  position during cooling operation in extremely humid weather. The difference between the temperature of the outside air and that of the windshield could cause the outer surface of the windshield to fog up, causing loss of visibility. In this case, set the mode selection knob or button to the  position and fan speed control knob or button to lower speed.

- For maximum defrosting, set the temperature control to the extreme right/hot position and the fan speed control to the highest speed.
- If warm air to the floor is desired while defrosting or defogging, set the mode to the floor-defrost position.
- Before driving, clear all snow and ice from the windshield, rear window, outside rear view mirrors, and all side windows.
- Clear all snow and ice from the hood and air inlet in the cowl grill to improve heater and defroster efficiency and to reduce the probability of fogging up inside of the windshield.

### Manual climate control system

#### To defog inside windshield



1. Select any fan speed except “0” position.
2. Select desired temperature.
3. Select the  or  position.
4. The outside (fresh) air will be selected automatically. Additionally, the air conditioning (if equipped) will automatically operate if the mode is selected to the  position.

If the air conditioning and outside (fresh) air position are not selected automatically, press the corresponding button manually.

### To defrost outside windshield



1. Set the fan speed to the highest (extreme right) position.
2. Set the temperature to the extreme hot position.
3. Select the position.
4. The outside (fresh) air and air conditioning (if equipped) will be selected automatically.

### Automatic climate control system

#### To defog inside windshield

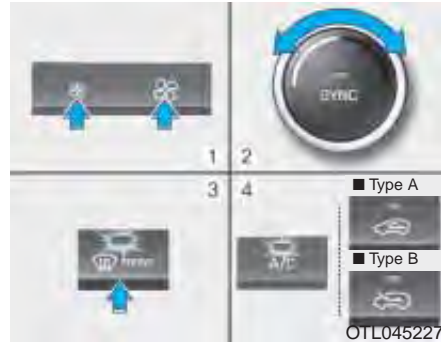



1. Select desired fan speed.
2. Select desired temperature.
3. Press the defroster button ().
4. The air-conditioning will turn on according to the detected ambient temperature, outside (fresh) air position and higher fan speed will be selected automatically.

If the air-conditioning, outside (fresh) air position and higher fan speed are not selected automatically, adjust the corresponding button or knob manually.

If the position is selected, lower fan speed is controlled to higher fan speed.

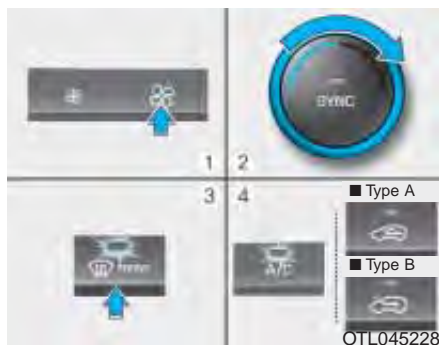

### To defrost outside windshield



1. Set fan speed to the highest position.
2. Set temperature to the extreme hot (HI) position.
3. Press the defroster button (  ).
4. The air-conditioning will turn on according to the detected ambient temperature and outside (fresh) air position will be selected automatically.

If the  position is selected, lower fan speed is controlled to higher fan speed.

### Defogging logic (if equipped)

To reduce the probability of fogging up the inside of the windshield, the air intake or air conditioning are controlled automatically according to certain conditions such as  or  position. To cancel or return the defogging logic, do the following.

### Manual climate control system

1. Turn the ignition switch to the ON position.
2. Press the defroster button (  ).
3. Press the air intake control button at least 5 times within 10 seconds.

The indicator on the air intake button blinks 3 times with 0.5 seconds of interval. It indicates that the defogging logic is canceled or returned to the programmed status.

If the battery has been discharged or disconnected, it resets to the defog logic status.

### **Automatic climate control system**

1. Turn the ignition switch to the ON position.
2. Press the defroster button (  ).
3. While pressing the air conditioning button (A/C), press the air intake control button at least 5 times within 3 seconds.

The climate control information screen will blink 3 times with 0.5 seconds of interval. It indicates that the defogging logic is canceled or returned to the programmed status.

If the battery has been discharged or disconnected, it resets to the defog logic status.

### **Auto defogging system (only for automatic climate control system, if equipped)**



Auto defogging reduces the possibility of fogging up the inside of the windshield by automatically sensing the moisture of inside the windshield.

The auto defogging system operates when the heater or air conditioning is on.

### ***i* Information**

The auto defogging system may not operate normally, when the outside temperature is below -10 °C.



When the Auto Defogging System operates, the indicator will illuminate.

If higher level of moisture are sensed in the vehicle, the Auto Defogging System will operate in the following order:

Step 1 : Outside air position

Step 2 : Operating the air conditioning

Step 3 : Blowing air toward the windshield

Step 4 : Increasing air flow toward the windshield

If the air conditioning is off or recirculated air position is manually selected while Auto Defogging System is ON, the Auto Defogging System Indicator will blink 3 times to signal that the manual operation has been canceled.

### To cancel or reset the Auto Defogging System

Press the front windshield defroster button for 3 seconds when the ignition switch is in the ON position. When the Auto Defogging System is canceled, ADS OFF symbol will blink 3 times and the ADS OFF will be displayed on the climate control information screen.

When the Auto Defogging System is reset, ADS OFF symbol will blink 6 times without a signal.

### **i** Information

- When the air conditioning is turned on by Auto defogging system, if you try to turn off the air conditioning, the indicator will blink 3 times and the air conditioning will not be turned off.
- For efficiency, do not select recirculated air position while Auto defogging system is operating.

### **NOTICE**

Do not remove the sensor cover located on the upper end of the driver side windshield glass.

Damage to system parts could occur and may not be covered by your vehicle warranty.

---

## CLIMATE CONTROL ADDITIONAL FEATURES

### Cluster ionizer (if equipped)

When the ignition switch is in the ON position, the clean air function turns on automatically.

Also, the clean air function turns off automatically, when the ignition switch is in the OFF position.

### Sunroof inside air recirculation (if equipped)

If the sunroof opens while the heater or Air Conditioning system operates, the outside (fresh) air will be selected automatically for ventilating the car. Then, if you select the recirculated air position, the outside (fresh) air will be selected automatically after 3 minutes.

If you close the sunroof, the intake mode will be changed to the previous selected mode.

## STORAGE COMPARTMENT

### WARNING

Never store cigarette lighters, propane cylinders, or other flammable/explosive materials in the vehicle. These items may catch fire and/or explode if the vehicle is exposed to hot temperatures for extended periods.

### WARNING

ALWAYS keep the storage compartment covers closed securely while driving. Items inside your vehicle are moving as fast as the vehicle. If you have to stop or turn quickly, or if there is a crash, the items may fly out of the compartment and may cause an injury if they strike the driver or a passenger.

### NOTICE

To avoid possible theft, do not leave valuables in the storage compartments.

## Center console storage

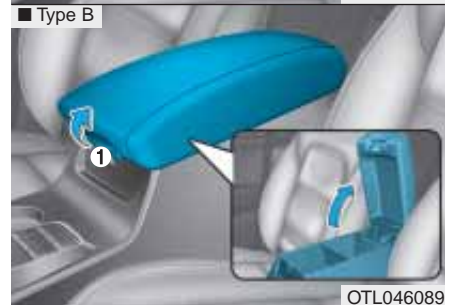
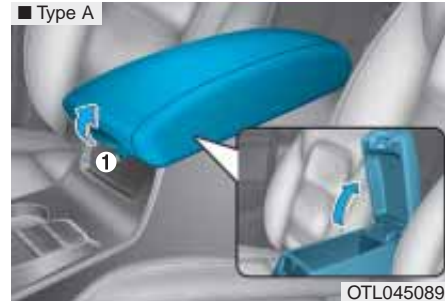

To open :  
Pull the lever (1).



## Glove box

■ Left-hand drive



■ Right-hand drive



To open the glove box, pull the handle and the glove box will automatically open. Close the glove box after use.

## WARNING

**ALWAYS** close the glove box door after use.

An open glove box door can cause serious injury to the passenger in an accident, even if the passenger is wearing a seat belt.

## Cool box (if equipped)

■ Left-hand drive



■ Right-hand drive



You can keep beverage cans or other items cool in the glove box.

1. Turn on the air conditioning.
2. Slide the open/close lever (1) of the vent installed in the glove box to the open position.
3. When the cool box is not used, slide the lever (1) to the closed position.

### NOTICE

If some items in the cool box block the vent, the cooling effectiveness of the cool box is reduced.

### Sunglass holder (if equipped)



To open:

Press the cover and the holder will slowly open. Place your sunglasses in the compartment door with the lenses facing out.

To close:

Push back into position.

Make sure the sunglass holder is closed while driving.

### ⚠ WARNING

- Do not keep objects except sunglasses inside the sunglass holder. Such objects can be thrown from the holder in the event of a sudden stop or an accident, possibly injuring the passengers in the vehicle.
- Do not open the sunglass holder while the vehicle is moving. The rear view mirror of the vehicle can be blocked by an open sunglass holder.
- Do not put the glasses forcibly into a sunglass holder. It may cause personal injury if you try to open it forcibly when the glasses are jammed in holder.

## INTERIOR FEATURES

### Ashtray (if equipped)



To use the ashtray, open the cover.

To clean the ashtray:

The plastic receptacle should be removed by lifting the plastic ashtray receptacle upward after turning the cover counterclockwise and pulling it out.

### WARNING

Putting lit cigarettes or matches in an ashtray with other combustible materials may cause a fire.

### Cup holder

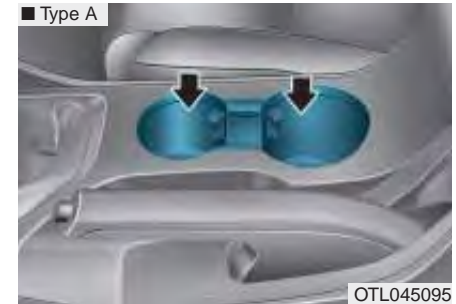

### Front

Cups or small beverages cups may be placed in the cup holders.

For the right-hand drive vehicles, the illustration is reversed.



### **Rear**

To open the cover:

Pull the armrest down to use the cup holders.

### **⚠ WARNING**

- Avoid abrupt starting and braking when the cup holder is in use to prevent spilling your drink. If hot liquid spills, you could be burned. Such a burn to the driver could cause loss of vehicle control resulting in an accident.
- Do not place uncovered or unsecured cups, bottles, cans, etc., in the cup holder containing hot liquid while the vehicle is in motion. Injuries may result in the event of sudden stop or collision.
- Only use soft cups in the cup holders. Hard objects can injure you in an accident.

### **⚠ WARNING**

Keep cans or bottles out of direct sun light and do not put them in a hot vehicle. It may explode.

### **NOTICE**

- Keep your drinks sealed while driving to prevent spilling your drink. If liquid spills, it may get into the vehicle's electrical/electronic system and damage electrical/electronic parts.
- When cleaning spilled liquids, do not dry the cup holder at high temperature. This may damage the cup holder.

## Sunvisor



OTL045097

To use a sunvisor, pull it downward. To use a sunvisor for a side window, pull it downward, unsnap it from the bracket (1) and swing it to the side (2). To use the vanity mirror, pull down the sunvisor and slide the mirror cover (3). Adjust the sunvisor forward or backward (4) as needed. Use the ticket holder (5 and 6) to hold tickets.

### **i** Information

Close the vanity mirror cover securely and return the sunvisor to its original position after use.

### **⚠** WARNING

For your safety, do not block your view when using the sunvisor.

### **NOTICE**

- Do not put several tickets in the ticket holder at one time. This could cause damage to the ticket holder.
- Avoid putting a plastic card such as a credit card in the ticket holder located in the outside of the sunvisor. This could cause damage to the plastic card.

## Power outlet (if equipped)



5

Convenient features of your vehicle

The power outlet is designed to provide power for mobile telephones or other devices designed to operate with vehicle electrical systems. The devices should draw less than 120 W(Watt) with the engine running.

### WARNING

Avoid electrical shocks. Do not place your fingers or foreign objects (pin, etc.) into a power outlet or touch the power outlet with a wet hand.

### NOTICE

To prevent damage to the Power Outlets :

- Use the power outlet only when the engine is running and remove the accessory plug after use. Using the accessory plug for prolonged periods of time with the engine off could cause the battery to discharge.
- Only use 12V electric accessories which are less than 120W (Watt) in electric capacity.
- Adjust the air-conditioner or heater to the lowest operating level when using the power outlet.
- Close the cover when not in use.

(Continued)

(Continued)

- Some electronic devices can cause electronic interference when plugged into a vehicle's power outlet. These devices may cause excessive audio static and malfunctions in other electronic systems or devices used in your vehicle.
- Push the plug in as far as it will go. If good contact is not made, the plug may overheat and the fuse may open.
- Plug in battery equipped electrical/electronic devices with reverse current protection. The current from the battery may flow into the vehicle's electrical/electronic system and cause system malfunction.

## Cigarette lighter (if equipped)

■ Left-hand drive



■ Right-hand drive



To use the cigarette lighter, the ignition switch must be in the ACC or ON position.

Push the cigarette lighter all the way into its socket. When the element is heated, the lighter will pop out to the “ready” position.

We recommend that you use parts for replacement from an authorized HYUNDAI dealer.

### WARNING

- Do not hold the lighter in after it is already heated because it will overheat.
- If the lighter does not pop out within 30 seconds, remove it to prevent overheating.
- Do not insert foreign objects into the socket of the cigarette lighter. It may damage the cigarette lighter.

### NOTICE

Only a genuine HYUNDAI lighter should be used in the cigarette lighter socket. The use of plug-in accessories (shavers, hand-held vacuums, and coffee pots, etc.) may damage the socket or cause electrical failure.

## Clock

### WARNING

Do not adjust the clock while driving. You may lose your steering control and cause severe personal injury or accidents.



### *With Audio system*



Whenever the battery terminals or related fuses are disconnected, you must reset the time.

To set the time :

The ignition switch must be in the ACC position or the ON position.

- H (Hour)

Press the "H" button to advance the time displayed by one hour.

- M (Minute)

Press the "M" button to advance the time displayed by one minute.

- Display conversion

To change the 12 hour format to the 24 hour format, press the "H" and "M" button simultaneously for more than 4 seconds.

For example, if the "H" and "M" button is pressed when the time is 10:15 p.m., the display will change to 22:15

### *With AVN system (if equipped)*



You can set the clock by using the AVN system.



### GPS Time ON

The clock is automatically updated through the AVN system.

### GPS Time OFF

The clock can be manually adjusted.

1. Select "System Settings" on the "INFO/Setup" screen.
2. Select the "Clock".
3. Select the "Date/Time settings".
4. Set the time date and time by touching the (▲ / ▼) on the screen.

For more details, please refer to the separate manual that was supplied with your vehicle.

### Clothes hanger (if equipped)

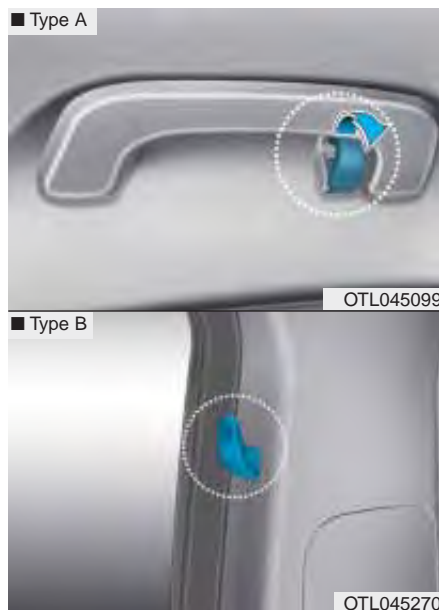

To hang items, pull the hanger down. (Type A)

These hangers are not designed to hold large or heavy items.

### WARNING

Do not hang other objects such as hangers or hard objects except clothes. Also, do not put heavy, sharp or breakable objects in the clothe pockets. In an accident or when the curtain air bag is inflated, it may cause vehicle damage or personal injury.

### Floor mat anchor(s) (if equipped)

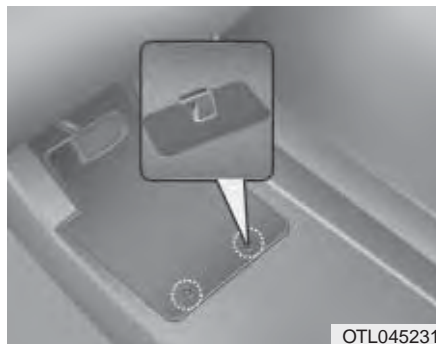

ALWAYS use the Floor Mat Anchors to attach the front floor mats to the vehicle. The anchors on the front floor carpet keep the floor mats from sliding forward.

### WARNING

The following must be observed when installing ANY floor mat to the vehicle.

- Ensure that the floor mats are securely attached to the vehicle's floor mat anchor(s) before driving the vehicle.
- Do not use ANY floor mat that cannot be firmly attached to the vehicle's floor mat anchors.
- Do not stack floor mats on top of one another (e.g. all-weather rubber mat on top of a carpeted floor mat). Only a single floor mat should be installed in each position.

**IMPORTANT** - Your vehicle was manufactured with driver's side floor mat anchors that are designed to securely hold the floor mat in place. To avoid any interference with pedal operation, HYUNDAI recommends that the HYUNDAI floor mat designed for use in your vehicle be installed.

### Luggage net (holder)



To keep items from shifting in the cargo area, you can use the four holders located in the cargo area to attach the luggage net.

If necessary, we recommend that you contact your authorized HYUNDAI dealer to obtain a luggage net.

### **NOTICE**

Vehicles equipped with a luggage rail system may use the shackles to hook the luggage net.

**CAUTION**

To prevent damage to the goods or the vehicle, care should be taken when carrying fragile or bulky objects in the luggage compartment.

**WARNING**

To avoid eye injury, **DO NOT** overstretch the luggage net. **ALWAYS** keep your face and body out of the luggage net's recoil path. **DO NOT** use the luggage net when the strap has visible signs of wear or damage.

**Cargo security screen (if equipped)**



Use the cargo security screen to hide items stored in the cargo area.

*To use the cargo security screen*



1. Pull the cargo security screen towards the rear of the vehicle by the handle (1).
2. Insert the guide pin into the guide (2).

**NOTICE**

Pull out the cargo security screen with the handle in the center to prevent the guide pin from falling out of the guide.

When the cargo security screen is not in use:

1. Pull the cargo security screen backward and up to release it from the guides.
2. The cargo security screen will automatically slide back in.

### NOTICE

The cargo security screen may not automatically slide back in if the cargo security screen is not fully pulled out. Fully pull it out and then let go.

*To remove the cargo security screen*



1. Push in the guide pin.
2. While pushing the guide pin, pull out the cargo security screen.



3. Open the luggage tray and keep the cargo security screen in the tray.

*To remove the cargo security screen from the luggage tray*

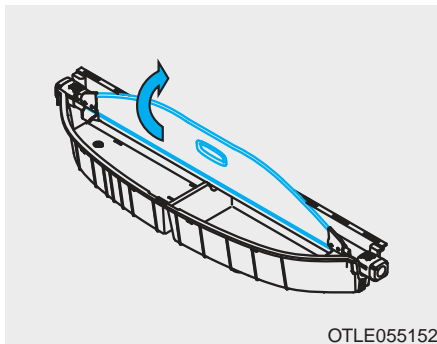

1. Pull up the screen board.

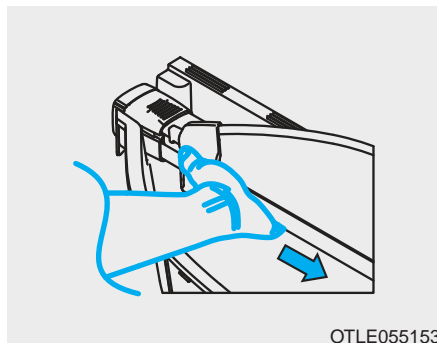

2. Push in the guide pin.

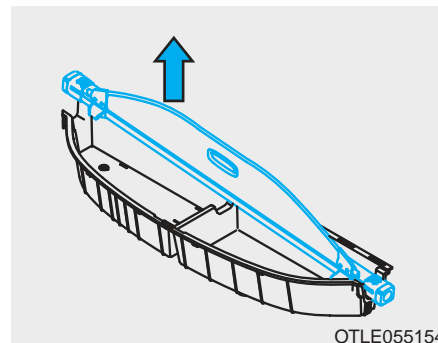

3. While pushing the guide pin, pull out the cargo security screen.

### NOTICE

Since the cargo security screen may be damaged or malformed, do not put luggage on it when it is used.

### ⚠ WARNING

- Do not place objects on the cargo security screen. Such objects may be thrown about inside the vehicle and possibly injure vehicle occupants during an accident or when braking.
- Never allow anyone to ride in the luggage compartment. It is designed for luggage only.
- Maintain the balance of the vehicle and locate the weight as forward as possible.

### Luggage tray



You can place a first aid kit, a reflector triangle, tools, etc. in the box for easy access.

- Grasp the handle on the top of the cover and lift it.

## EXTERIOR FEATURES

### Roof rack (if equipped)



OTL045502L

If the vehicle has a roof rack, you can load cargo on top of your vehicle.

**NOTICE**

If the vehicle is equipped with a sunroof or a panorama roof, be sure not to position cargo onto the roof rack in such a way that it could interfere with sunroof or a panorama roof operation.

**NOTICE**

- When carrying cargo on the roof rack, take the necessary precautions to make sure the cargo does not damage the roof of the vehicle.
- When carrying large objects on the roof rack, make sure they do not exceed the overall roof length or width.

**WARNING**

- The following specification is the maximum weight that can be loaded onto the roof rack. Distribute the load as evenly as possible onto the roof rack and secure the load firmly.

ROOF RACK	100 kg (220 lbs.) EVENLY DISTRIBUTED
-----------	---

Loading cargo or luggage in excess of the specified weight limit on the roof rack may damage your vehicle.

(Continued)

(Continued)

- The vehicle center of gravity will be higher when items are loaded onto the roof rack. Avoid sudden starts, braking, sharp turns, abrupt maneuvers or high speeds that may result in loss of vehicle control or rollover resulting in an accident.
- Always drive slowly and turn corners carefully when carrying items on the roof rack. Severe wind updrafts, caused by passing vehicles or natural causes, can cause sudden upward pressure on items loaded on the roof rack. This is especially true when carrying large, flat items such as wood panels or mattresses. This could cause the items to fall off the roof rack and cause damage to your vehicle or others around you.
- To prevent damage or loss of cargo while driving, check frequently before or while driving to make sure the items on the roof rack are securely fastened.

# Multimedia System

<b>Multimedia system</b> .....	6-2
AUX, USB and iPod® port .....	6-2
Antenna .....	6-3
Steering wheel audio control .....	6-4
Audio / Video / Navigation system (AVN) .....	6-5
<i>Bluetooth</i> ® Wireless Technology hands-free .....	6-5
How vehicle audio works .....	6-6
Caring for disc .....	6-8
MP3 File Information .....	6-8
<b>System controllers and functions</b> .....	6-22
Audio Head unit (For Europe)	
- RDS, Bluetooth equipped model .....	6-22
- RDS, No Bluetooth equipped model .....	6-24
- No RDS, Bluetooth equipped model .....	6-26
- No RDS, No Bluetooth equipped model .....	6-28
Audio Head unit (Except Europe)	
- Bluetooth equipped model .....	6-30
- No Bluetooth equipped model .....	6-32
Setup (For Europe) .....	6-34
Setup (Except Europe) .....	6-43
Radio : FM, AM (For RDS Model) .....	6-51
Radio : FM, AM (Except RDS Model) .....	6-53



## MULTIMEDIA SYSTEM

### **i** Information

- If you install an aftermarket HID headlamp, your vehicle's audio and electronic device may malfunction.
- Prevent chemicals such as perfume, cosmetic oil, sun cream, hand cleaner, and air freshener from contacting the interior parts because they may cause damage or discoloration.

### AUX, USB and iPod® port



You can use an AUX port to connect audio devices and an USB port to plug in an USB and also in an iPod® port.

### **i** Information

When using a portable audio device connected to the power outlet, noise may occur during playback. If this happens, use the power source of the portable audio device.

\* iPod® is a trademark of Apple Inc.

## Antenna

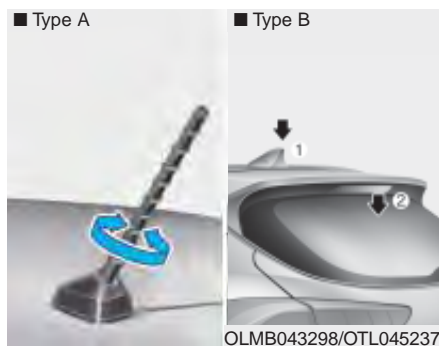

### Roof antenna (Type A)

The roof antenna receives both AM and FM broadcast signals. Rotate the roof antenna in a counterclockwise direction to remove it. Rotate it in a clockwise direction to reinstall it.

### Shark fin antenna (Type B)

The shark fin antenna receives transmitted data. (for example: GPS and DAB signals)

#### NOTICE

Remove the antenna by rotating it in a counter-clockwise direction, before entering a place with a low floor height. If not, the antenna may be damaged.

Securely install the antenna in the upright position. This is to guarantee proper signal reception. However, you may fold and remove the antenna, before parking the vehicle or loading the luggage on the roof rack.

Do not load the luggage near the antenna. This is to guarantee proper signal reception.

Steering wheel audio controls  
(if equipped)

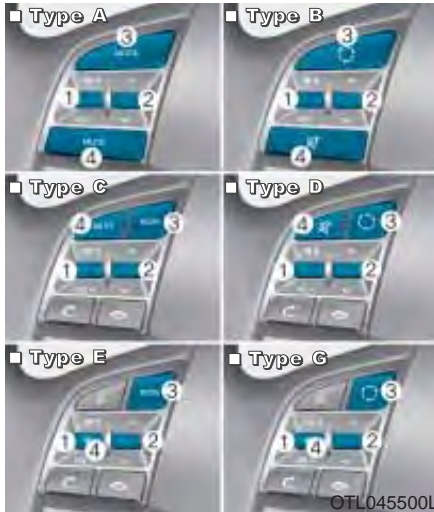

The audio control buttons on the steering wheel are provided for your convenient audio control, while safely driving.

**NOTICE**

Do not operate audio remote control buttons simultaneously

VOLUME (VOL + / - ) (1)

- Move the VOLUME lever up to increase volume.
- Move the VOLUME lever down to decrease volume.

SEEK/PRESET ( ^ / v ) (2)

If the SEEK/PRESET lever is moved up or down and held for 0.8 second or more, it will function in the following modes.

**RADIO mode**

It will function as the AUTO SEEK select button. It will SEEK until you release the button.

**MEDIA mode**

It will function as the FF/REW button.

If the SEEK/PRESET lever is moved up or down, it will function in the following modes.

**RADIO mode**

It will function as the PRESET STATION UP/DOWN button.

**MEDIA mode**

It will function as the TRACK UP/DOWN button.

MODE (  ) (3)

Press the MODE button to select Radio, Disc, or AUX.

MUTE (  ) (4, if equipped)

- Press the button to mute the sound.
- Press the button again to activate the sound.

**i** Information

**Detailed information for audio control buttons are described in the following pages in this chapter.**

## Audio / Video / Navigation Bluetooth Wireless system (AVN)(if equipped) Technology hands-free (if equipped)

Detailed information for the AVN system is described in a separately supplied manual.



■ Type A



■ Type B



You can use the phone wirelessly by using the Bluetooth Wireless Technology.

- (1) Call / Answer button
- (2) Call end button
- (3) Microphone

- Audio : For detailed information, refer to “AUDIO” in this chapter.
- AVN : Detailed information for the Bluetooth Wireless Technology hands-free is described in the manual supplied separately.

### How Vehicle Audio Works

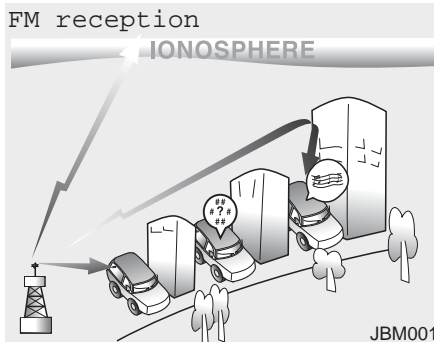

AM and FM radio signals are broadcast from transmitter towers located around your city. They are intercepted by the radio antenna on your vehicle. This signal is then processed by the radio and sent to your vehicle speakers.

When a strong radio signal has reached your vehicle, the precise engineering of your audio system ensures the best possible quality reproduction. However, in some cases the signal coming to your vehicle may not be strong and clear.

This can be due to factors, such as the distance from the radio station, closeness of other strong radio stations or the presence of buildings, bridges or other large obstructions in the area.

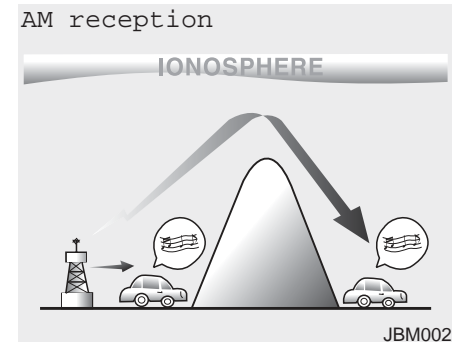

AM broadcasts can be received at greater distances than FM broadcasts. This is because AM radio waves are transmitted at low frequencies. These long distance, low frequency radio waves can follow the curvature of the earth rather than travelling straight. In addition, they curve around obstructions resulting in better signal coverage.

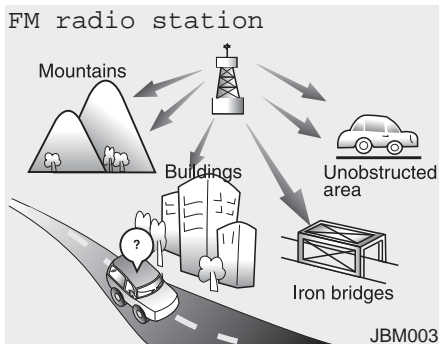

FM broadcasts are transmitted at high frequencies and do not bend to follow the earth's surface. Because of this, FM broadcasts generally begin to fade within short distances from the station. Also, FM signals are easily affected by buildings, mountains, and obstructions. This can lead to undesirable or unpleasant listening conditions which might lead you to believe a problem exists with your radio. The following conditions are normal and do not indicate radio trouble :

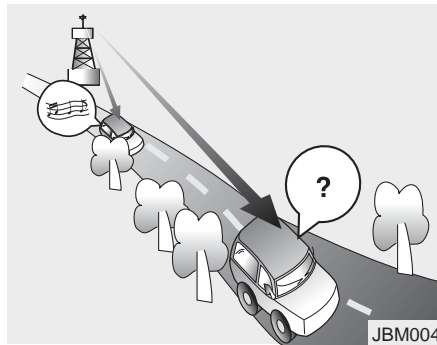

- **Fading** - As your vehicle moves away from the radio station, the signal will weaken and sound will begin to fade. When this occurs, we suggest that you select another stronger station.
- **Flutter/Static** - Weak FM signals or large obstructions between the transmitter and your radio can disturb the signal causing static or fluttering noises to occur. Reducing the treble level may lessen this effect until the disturbance clears.

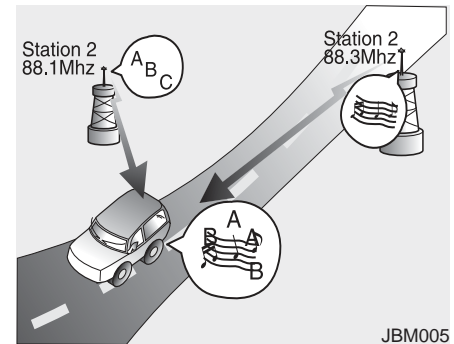

- **Station Swapping** - As an FM signal weakens, another more powerful signal near the same frequency may begin to play. This is because your radio is designed to lock onto the clearest signal. If this occurs, select another station with a stronger signal.
- **Multi-Path Cancellation** - Radio signals being received from several directions can cause distortion or fluttering. This can be caused by a direct and reflected signal from the same station, or by signals from two stations with close frequencies. If this occurs, select another station until the condition has passed.

### Caring for Disc

- If the temperature inside the car is too high, open the car windows to ventilate before using the system.
- It is illegal to copy and use MP3/WMA files without permission. Use CDs that are created only by lawful means.
- Do not apply volatile agents, such as benzene and thinner, normal cleaners and magnetic sprays made for analogue disc onto CDs.
- To prevent the disc surface from getting damaged, hold CDs by the edges or the center hole only.
- Clean the disc surface with a piece of soft cloth before playback (wipe it from the center to the outside edge).
- Do not damage the disc surface or attach pieces of sticky tape or paper.
- Make certain only CDs are inserted into the CD player (Do not insert more than one CD at a time).
- Keep CDs in their cases after use to protect them from scratches or dirt.

- Depending on the type of CD-R/CD-RW CDs, certain CDs may not operate normally according to the manufacturing companies. In such circumstances, continued use may cause malfunctions to your audio system.



#### Information

- Playing an Incompatible Copy Protected Audio CD

**Some copy protected CDs, which do not comply with international audio CD standards (Red Book), may not play on your car audio. Please note that inability to properly play a copy protected CD may indicate that the CD is defective, not the CD player.**

### MP3 File Information

#### Supported Audio Formats

File System	ISO 9660 Level 1
	ISO 9660 Level 2
	Romeo / Juliet (128 characters)
Audio Compression	MPEG1 Audio Layer3
	MPEG2 Audio Layer3
	MPEG2.5 Audio Layer3
	Windows Media Audio Ver 7.X & 8.X

- \* File formats that do not comply with the above formats may not be properly recognized or play without properly displaying file names or other information.

(Continued)

- If your iPhone® is connected to both the *Bluetooth*® Wireless Technology and USB, the sound may not be properly played. In your iPhone®, select the Dock connector or *Bluetooth*® Wireless Technology to change the sound output (source).
- iPod mode cannot be operated when the iPod® cannot be recognized due to versions that do not support communication protocols.
- For fifth generation iPod® Nano devices, the iPod® may not be recognized when the battery level is low. Please charge the iPod® for use.
- Search/play orders shown within the iPod® device may differ with the orders shown within the audio system.
- If the iPod® malfunctions due to an iPod® device defect, reset the iPod® and try again. (To learn more, refer to your iPod® manual)

(Continued)

(Continued)

- Some iPod®s may not sync with the System depending on its version. If the Media is removed before the Media is recognized, then the system may not properly restore the previously operated mode. (iPod® charging is not supported.)

**i** Information

- Using the AUX device

- If an external device connector is connected with the AUX terminal, then AUX mode will automatically operate. Once the connector is disconnected, the previous mode will be restored.
- AUX mode can be used only when an external audio player (camcorder, car VCR, etc.) has been connected.
- The AUX volume can be controlled separately from other audio modes.
- Connecting a connector jack to the AUX terminal without an external device will convert the system to AUX mode, but only output noise. When an external device is not being used, also remove the connector jack.

(Continued)



(Continued)

- When the external device power is connected to the power jack, playing the external device may output noise. In such cases, disconnect the power connection before use.
- Fully insert the AUX cable to the AUX jack upon use.



Information

- Before using the Bluetooth® handsfree

What is Bluetooth®

- Bluetooth® refers to a short-distance wireless networking technology which uses a 2.4GHz ~ 2.48GHz frequency to connect various devices within a certain distance.
- Supported within PCs, external devices, Bluetooth® phones, PDAs, various electronic devices, and automotive environments, Bluetooth® allows data to be transmitted at high speeds without having to use a connector cable.
- Bluetooth® Handsfree refers to a device which allows the user to conveniently make phone calls with Bluetooth® mobile phones through the audio system.
- Bluetooth® Handsfree may not be supported in some mobile phones. To learn more about mobile device compatibility.



Information

- Precautions for safe driving

- Bluetooth® Handsfree is a feature that enables drivers to practice safe driving. Connecting the head unit with a Bluetooth® phone allows the user to conveniently make and receive calls and use contacts. Before using Bluetooth®, carefully read the contents of this user's manual.
- Excessive use or operations while driving may lead to negligent driving practices and result in accidents. Refrain from excessive operations while driving.
- Viewing the screen for prolonged periods of time is dangerous and may lead to accidents. When driving, view the screen only for short periods of time.

**i** Information

-When connecting a Bluetooth® phone

- Before connecting the head unit with the mobile phone, check to see that the mobile phone supports Bluetooth® features.
- Even if the phone supports Bluetooth®, the phone will not be found during device searches if the phone has been set to hidden state or the Bluetooth® power is turned off. Disable the hidden state or turn on the Bluetooth® power prior to searching/connecting with the Head unit.
- Bluetooth phone is automatically connected when the ignition on.
- If you do not want automatic connection with your Bluetooth® device, turn off the Bluetooth® feature within your mobile phone.
- The Handsfree call volume and quality may differ depending on the mobile phone.

(Continued)

(Continued)

- Park the vehicle when connecting the head unit with the mobile phone.
- Bluetooth® connection may become intermittently disconnected in some mobile phones. Follow these steps to try again.
  1. Within the mobile phone, turn the Bluetooth® function off/on and try again.
  2. Turn the mobile phone power Off/On and try again.
  3. Completely remove the mobile phone battery, reboot, and then again.
  4. Reboot the Audio System and try again.
  5. Delete all paired devices, pair and try again.
- Handsfree call quality and volume may differ depending on the model of your mobile phone.

- i** Information
- Using the Bluetooth® Wireless Technology cellular phone
  - Do not use a cellular phone or perform *Bluetooth*® Wireless Technology settings (e.g. pairing a phone) while driving.
  - Some *Bluetooth*® Wireless Technology -enabled phones may not be recognized by the system or fully compatible with the system.
  - Before using *Bluetooth*® Wireless Technology related features of the audio system, refer your phone's User's Manual for phone-side *Bluetooth*® Wireless Technology operations.
  - The phone must be paired to the audio system to use *Bluetooth*® Wireless Technology related features.

(Continued)

(Continued)

- You will not be able to use the hands-free feature when your phone (in the car) is outside of the cellular service area (e.g. in a tunnel, in an underground, in a mountainous area, etc.).
- If the cellular phone signal is poor or the vehicle's interior noise is too loud, it may be difficult to hear the other person's voice during a call.
- Do not place the phone near or inside metallic objects, otherwise communications with *Bluetooth*® Wireless Technology system or cellular service stations can be disturbed.
- While a phone is connected through *Bluetooth*® Wireless Technology your phone may discharge quicker than usual for additional *Bluetooth*® Wireless Technology-related operations.

(Continued)

(Continued)

- Some cellular phones or other devices may cause interference noise or malfunction to audio system. In this case, store the device in a different location may resolve the condition.
  - Phone contact names should be saved in English or they may not be displayed correctly.
  - If Priority is set upon vehicle ignition(IGN/ACC ON), the *Bluetooth*® Wireless Technology phone will be automatically connected. Even if you are outside, the *Bluetooth*® Wireless Technology phone will be automatically connected once you are in the vicinity of the vehicle.
- If you do not want automatic *Bluetooth*® Wireless Technology connection, turn the *Bluetooth*® Wireless Technology feature off.

(Continued)

(Continued)

- The hands-free call volume and quality may differ depending on the mobile phone type.
- *Bluetooth*® Wireless Technology features can be used only when the mobile phone has been paired and connected with the device. For more information on pairing and connecting *Bluetooth*® Wireless Technology enabled mobile phones, refer to the “Phone Setup” section.
- When a *Bluetooth*® Wireless Technology mobile phone is connected, a (📶) icon will appear at the top of the screen. If a (📶) icon is not displayed, this indicates that a *Bluetooth*® Wireless Technology enabled device has not been connected. You must connect the device before use. For more information on *Bluetooth*® Wireless Technology mobile phones, refer to the “Phone Setup” section.

(Continued)

(Continued)

- Pairing and connecting a *Bluetooth*® Wireless Technology enabled mobile phone will work only when the *Bluetooth*® Wireless Technology option within your mobile phone has been turned on. (Methods of turning on the *Bluetooth*® Wireless Technology enabled feature may differ depending on the mobile phone.)
- In some mobile phones, starting the ignition while talking through *Bluetooth*® Wireless Technology enabled handsfree call will result in the call becoming disconnected. (Switch the call back to your mobile phone when starting the ignition.)
- Some features may not be supported in some *Bluetooth*® Wireless Technology mobile phone and devices.

(Continued)

## System Controllers and Functions

\* Display and settings may differ depending on the selected audio.

Audio Head Unit (For EUROPE)  
- RDS, Bluetooth equipped model



Name	Description
①	Ejects the disc.
② <b>RADIO</b>	<ul style="list-style-type: none"> <li>• Convert to Radio mode.</li> <li>• Each time the key is pressed, the mode is changed in order of FM1, FM2, FMA, AM, AMA.</li> </ul>

Name	Description
③ <b>MEDIA</b>	<p>Each time the key is pressed, the mode is changed in order of CD, USB, iPod<sup>®</sup>, AUX, My Music, BT Audio modes.</p> <p>* In Setup&gt;Display, the media pop up screen will be displayed when [Mode Pop up] is turned <b>On</b>.</p> <p>* When the pop up screen is displayed, use the  TUNE knob or keys <b>1</b> ~ <b>6</b> to select the desired mode.</p>
④	<p>Converts to Phone mode.</p> <p>* When a phone is not connected, the connection screen is displayed.</p>
⑤ <b>SEEK TRACK</b>	<ul style="list-style-type: none"> <li>• Radio mode : Automatically searches for broadcast frequencies.</li> <li>• CD, USB, iPod<sup>®</sup>, My Music modes : <ul style="list-style-type: none"> <li>- Shortly press the key : Moves to next or previous song(file).</li> <li>- Press and hold the key : Rewinds or fast-forwards the current song(file).</li> </ul> </li> </ul>
⑥  POWER/VOLUME knob	<ul style="list-style-type: none"> <li>•  Power Knob : Turns power On/Off by pressing the knob.</li> <li>•  Volume Knob : Sets volume by turning the knob left/right.</li> </ul>
⑦ <b>1</b> ~ <b>6</b> (Preset)	<ul style="list-style-type: none"> <li>• Radio mode : Saves frequencies (channels) or receives saved frequencies (channels).</li> <li>• CD, USB, iPod<sup>®</sup>, My Music modes <ul style="list-style-type: none"> <li>- <b>1 RPT</b> : Repeat</li> <li>- <b>2 RDM</b> : Random</li> </ul> </li> </ul>



Name	Description
⑧	Each time the button is shortly pressed, it sets the screen Off → Screen On → Screen Off. * Audio operation is maintained and only the screen will be turned Off. In the screen Off state, press any key to turn the screen On again.
⑨	Set TA(Traffic Announcement) feature On/Off.
⑩	<ul style="list-style-type: none"> <li>• Shortly press the key : Moves to the Display, Sound, Clock, Phone, System setting modes.</li> <li>• Press and hold the key : Moves to clock settings</li> </ul>
⑪	Displays menus for the current mode.
⑫	MP3 CD, USB, iPod modes : Folder Search. * May differ depending on the selected audio.
⑬	<ul style="list-style-type: none"> <li>• Radio mode : Changes frequency by turning the knob left/right.</li> <li>• CD, USB, iPod modes : Searches songs (files) by turning the knob left/right.</li> </ul> * When the desired song is displayed, press the knob to play the song.







## - RDS, No Bluetooth equipped model



Name	Description
① <b>▲</b>	Ejects the disc.
② <b>FM</b>	<ul style="list-style-type: none"> <li>Changes to FM mode.</li> <li>Each time the key is pressed, the mode is changed in order of FM1 → FM2.</li> </ul>
③ <b>AM</b>	Changes to AM mode.

Name	Description
④ <b>MEDIA</b>	<p>Each time the key is pressed, the mode is changed in order of CD, USB, iPod<sup>®</sup>, AUX modes.</p> <p>* In Setup&gt;Display, the media pop up screen will be displayed when [Mode Pop up] is turned <b>On</b>.</p> <p>* When the pop up screen is displayed, use the <b>TUNE</b> knob or keys <b>1</b> ~ <b>6</b> to select the desired mode.</p>
⑤ <b>SEEK TRACK</b>	<ul style="list-style-type: none"> <li>Radio mode : Automatically searches for broadcast frequencies.</li> <li>CD, USB, iPod<sup>®</sup> modes : <ul style="list-style-type: none"> <li>Shortly press the key : Moves to next or previous song(file).</li> <li>Press and hold the key : Rewinds or fast-forwards the current song(file).</li> </ul> </li> </ul>
⑥ <b>POWER/VOLUME knob</b>	<ul style="list-style-type: none"> <li><b>Power Knob</b> : Turns power On/Off by pressing the knob.</li> <li><b>Volume Knob</b> : Sets volume by turning the knob left/right.</li> </ul>
⑦ <b>1 ~ 6 (Preset)</b>	<ul style="list-style-type: none"> <li>Radio mode : Saves frequencies (channels) or receives saved frequencies (channels).</li> <li>CD, USB, iPod<sup>®</sup> modes <ul style="list-style-type: none"> <li><b>1 RPT</b> : Repeat</li> <li><b>2 RDM</b> : Random</li> </ul> </li> </ul>



Name	Description
⑧ 	Each time the button is shortly pressed, it sets the screen Off → Screen On → Screen Off. * Audio operation is maintained and only the screen will be turned Off. In the screen Off state, press any key to turn the screen On again.
⑨ 	Set TA(Traffic Announcement) feature On/Off.
⑩ 	<ul style="list-style-type: none"> <li>• Shortly press the key : Moves to the Display, Sound, Clock, Phone, System setting modes.</li> <li>• Press and hold the key : Moves to clock settings</li> </ul>
⑪ 	Displays menus for the current mode.
⑫ 	MP3 CD, USB modes : Folder Search. * May differ depending on the selected audio.
⑬  TUNE knob	<ul style="list-style-type: none"> <li>• Radio mode : Changes frequency by turning the knob left/right.</li> <li>• CD, USB, iPod<sup>®</sup> modes : Searches songs (files) by turning the knob left/right.</li> <li>* When the desired song is displayed, press the knob to play the song.</li> </ul>



## - No RDS, Bluetooth equipped model



Name	Description
①	Ejects the disc.
② <b>RADIO</b>	<ul style="list-style-type: none"> <li>• Convert to Radio mode.</li> <li>• Each time the key is pressed, the mode is changed in order of FM1, FM2, FMA, AM, AMA.</li> </ul>

Name	Description
③ <b>MEDIA</b>	<p>Each time the key is pressed, the mode is changed in order of CD, USB, iPod<sup>®</sup>, AUX, My Music, BT Audio modes.</p> <p>* In Setup&gt;Display, the media pop up screen will be displayed when [Mode Pop up] is turned <b>On</b>.</p> <p>* When the pop up screen is displayed, use the  TUNE knob or keys <b>1</b> ~ <b>6</b> to select the desired mode.</p>
④	<p>Converts to Phone mode.</p> <p>* When a phone is not connected, the connection screen is displayed.</p>
⑤	<ul style="list-style-type: none"> <li>• Radio mode : Automatically searches for broadcast frequencies.</li> <li>• CD, USB, iPod<sup>®</sup>, My Music modes : <ul style="list-style-type: none"> <li>- Shortly press the key : Moves to next or previous song(file).</li> <li>- Press and hold the key : Rewinds or fast-forwards the current song(file).</li> </ul> </li> </ul>
⑥	<ul style="list-style-type: none"> <li>•  Power Knob : Turns power On/Off by pressing the knob.</li> <li>•  Volume Knob : Sets volume by turning the knob left/right.</li> </ul>
⑦ <b>1</b> ~ <b>6</b> (Preset)	<ul style="list-style-type: none"> <li>• Radio mode : Saves frequencies (channels) or receives saved frequencies (channels).</li> <li>• CD, USB, iPod<sup>®</sup>, My Music modes <ul style="list-style-type: none"> <li>- <b>1 RPT</b> : Repeat</li> <li>- <b>2 RDM</b> : Random</li> </ul> </li> </ul>



Name	Description
⑧	<p>Each time the button is shortly pressed, it sets the screen Off → Screen On → Screen Off.</p> <p>* Audio operation is maintained and only the screen will be turned Off. In the screen Off state, press any key to turn the screen On again.</p>

Name	Description
⑨ <b>SCAN</b>	<ul style="list-style-type: none"> <li>• Radio mode</li> <li>- Shortly press the key : Previews each broadcast for 5 seconds each.</li> <li>- Press and hold the key : Previews the broadcasts saved in Preset <b>1</b> ~ <b>6</b> for 5 seconds each.</li> <li>* Press the <b>SCAN</b> key again to continue listening to the current frequency.</li> <li>• CD, USB, iPod<sup>®</sup> modes</li> <li>- Shortly press the key : Previews each song (file) for 10 seconds each.</li> <li>* Press the <b>SCAN</b> key again to continue listening to the current song (file).</li> </ul>
⑩	<ul style="list-style-type: none"> <li>• Shortly press the key : Moves to the Display, Sound, Clock, Phone, System setting modes.</li> <li>• Press and hold the key : Moves to clock settings</li> </ul>
⑪ <b>MENU</b>	Displays menus for the current mode.
⑫	<p>MP3 CD, USB modes : Folder Search.</p> <p>* May differ depending on the selected audio.</p>
⑬  TUNE knob	<ul style="list-style-type: none"> <li>• Radio mode : Changes frequency by turning the knob left/right.</li> <li>• CD, USB, iPod<sup>®</sup> modes : Searches songs (files) by turning the knob left/right.</li> <li>* When the desired song is displayed, press the knob to play the song.</li> </ul>

## - No RDS, No Bluetooth equipped model

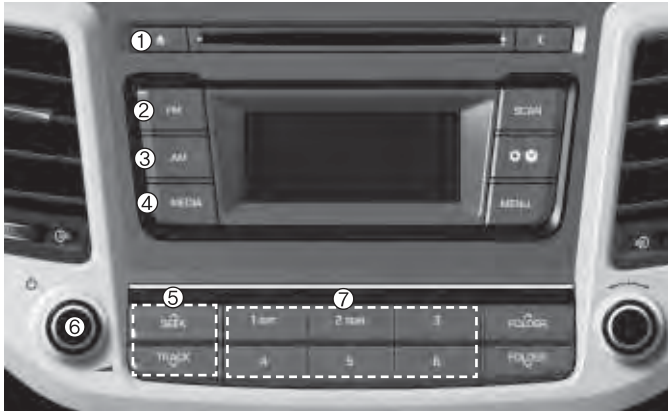

Name	Description
① <b>▲</b>	Ejects the disc.
② <b>FM</b>	<ul style="list-style-type: none"> <li>• Changes to FM mode.</li> <li>• Each time the key is pressed, the mode changed in order of FM1 → FM2.</li> </ul>
③ <b>AM</b>	Changes to AM mode.

Name	Description
④ <b>MEDIA</b>	<p>Each time the key is pressed, the mode is changed in order of CD, USB, iPod<sup>®</sup>, AUX modes.</p> <p>* In Setup&gt;Display, the media pop up screen will be displayed when [Mode Pop up] is turned <b>On</b>.</p> <p>* When the pop up screen is displayed, use the <b>TUNE</b> knob or keys <b>1</b> ~ <b>5</b> to select the desired mode.</p>
⑤ <b>SEEK TRACK</b>	<ul style="list-style-type: none"> <li>• Radio mode : Automatically searches for broadcast frequencies.</li> <li>• CD, USB, iPod<sup>®</sup> modes : <ul style="list-style-type: none"> <li>- Shortly press the key : Moves to next or previous song(file).</li> <li>- Press and hold the key : Rewinds or fast-forwards the current song(file).</li> </ul> </li> </ul>
⑥ <b>POWER/VOLUME knob</b>	<ul style="list-style-type: none"> <li>• <b>Power Knob</b> : Turns power On/Off by pressing the knob.</li> <li>• <b>Volume Knob</b> : Sets volume by turning the knob left/right.</li> </ul>
⑦ <b>1 ~ 6 (Preset)</b>	<ul style="list-style-type: none"> <li>• Radio mode : Saves frequencies (channels) or receives saved frequencies (channels).</li> <li>• CD, USB, iPod<sup>®</sup> modes <ul style="list-style-type: none"> <li>- <b>1 RPT</b> : Repeat</li> <li>- <b>2 RDM</b> : Random</li> </ul> </li> </ul>

## Audio Head Unit (Except EUROPE) - Bluetooth equipped model



Name	Description
①	Ejects the disc.
② <b>RADIO</b>	<ul style="list-style-type: none"> <li>• Convert to Radio mode.</li> <li>• Each time the key is pressed, the mode is changed in order of FM1, FM2, AM.</li> </ul>

Name	Description
③ <b>MEDIA</b>	<p>Each time the key is pressed, the mode is changed in order of CD, USB, iPod<sup>®</sup>, AUX, My Music, BT Audio modes.</p> <p>* In Setup&gt;Display, the media pop up screen will be displayed when [Mode Pop up] is turned <b>On</b>.</p> <p>* When the pop up screen is displayed, use the  TUNE knob or keys <b>1</b> ~ <b>6</b> to select the desired mode.</p>
④ <b>PHONE</b>	<p>Converts to Phone mode</p> <p>* When a phone is not connected, the connection screen is displayed.</p>
⑤	<ul style="list-style-type: none"> <li>• Radio mode : Automatically searches for broadcast frequencies.</li> <li>• CD, USB, iPod<sup>®</sup>, My Music modes : <ul style="list-style-type: none"> <li>- Shortly press the key : Moves to next or previous song(file).</li> <li>- Press and hold the key : Rewinds or fast-forwards the current song(file).</li> </ul> </li> </ul>
⑥	<ul style="list-style-type: none"> <li>•  Power Knob : Turns power On/Off by pressing the knob.</li> <li>•  Volume Knob : Sets volume by turning the knob left/right.</li> </ul>
⑦ <b>1</b> ~ <b>6</b> (Preset)	<ul style="list-style-type: none"> <li>• Radio mode : Saves frequencies (channels) or receives saved frequencies (channels).</li> <li>• CD, USB, iPod<sup>®</sup>, My Music modes <ul style="list-style-type: none"> <li>- <b>1 RPT</b> : Repeat</li> <li>- <b>2 RDM</b> : Random</li> </ul> </li> </ul>



Name	Description
⑧ <b>DISP</b>	Each time the button is shortly pressed, it sets the screen Off → Screen On → Screen Off. * Audio operation is maintained and only the screen will be turned Off. In the screen Off state, press any key to turn the screen On again.

Name	Description
⑨ <b>SCAN</b>	<ul style="list-style-type: none"> <li>• Radio mode</li> <li>- Shortly press the key : Previews each broadcast for 5 seconds each.</li> <li>- Press and hold the key : Previews the broadcasts saved in Preset <b>1</b> ~ <b>6</b> for 5 seconds each.</li> <li>* Press the <b>SCAN</b> key again to continue listening to the current frequency.</li> <li>• CD, USB, iPod<sup>®</sup> modes</li> <li>- Shortly press the key : Previews each song (file) for 10 seconds each.</li> <li>* Press the <b>SCAN</b> key again to continue listening to the current song (file).</li> </ul>
⑩ <b>SETUP/CLOCK</b>	<ul style="list-style-type: none"> <li>• Shortly press the key : Moves to the Display, Sound, Clock, Phone, System setting modes.</li> <li>• Press and hold the key : Moves to clock settings</li> </ul>
⑪ <b>MENU</b>	Displays menus for the current mode.
⑫ <b>FOLDER</b> <b>FOLDER</b>	MP3 CD, USB modes : Folder Search. * May differ depending on the selected audio.
⑬ <b>TUNE knob</b>	<ul style="list-style-type: none"> <li>• Radio mode : Changes frequency by turning the knob left/right.</li> <li>• CD, USB, iPod<sup>®</sup> modes : Searches songs (files) by turning the knob left/right.</li> <li>* When the desired song is displayed, press the knob to play the song.</li> </ul>

## - No Bluetooth equipped model



Name	Description
① <b>▲</b>	Ejects the disc.
② <b>FM</b>	<ul style="list-style-type: none"> <li>• Changes to FM mode.</li> <li>• Each time the key is pressed, the mode changed in order of FM1 → FM2.</li> </ul>
③ <b>AM</b>	Changes to AM mode.

Name	Description
④ <b>MEDIA</b>	<ul style="list-style-type: none"> <li>• Each time the key is pressed, the mode is changed in order of CD, USB, iPod<sup>®</sup>, AUX modes.</li> <li>* In Setup&gt;Display, the media pop up screen will be displayed when [Mode Pop up] is turned <b>On</b>.</li> <li>* When the pop up screen is displayed, use the <b>TUNE</b> knob or keys <b>1</b> ~ <b>5</b> to select the desired mode.</li> </ul>
⑤ <b>SEEK TRACK</b>	<ul style="list-style-type: none"> <li>• Radio mode : Automatically searches for broadcast frequencies.</li> <li>• CD, USB, iPod<sup>®</sup> modes : <ul style="list-style-type: none"> <li>- Shortly press the key : Moves to next or previous song(file).</li> <li>- Press and hold the key : Rewinds or fast-forwards the current song(file).</li> </ul> </li> </ul>
⑥ <b>POWER/VOLUME knob</b>	<ul style="list-style-type: none"> <li>• <b>Power Knob</b> : Turns power On/Off by pressing the knob.</li> <li>• <b>Volume Knob</b> : Sets volume by turning the knob left/right.</li> </ul>
⑦ <b>1 ~ 6 (Preset)</b>	<ul style="list-style-type: none"> <li>• Radio mode : Saves frequencies (channels) or receives saved frequencies (channels).</li> <li>• CD, USB, iPod<sup>®</sup> modes <ul style="list-style-type: none"> <li>- <b>1 RPT</b> : Repeat</li> <li>- <b>2 RDM</b> : Random</li> </ul> </li> </ul>



Name	Description
⑧ <b>DISP</b>	Each time the button is shortly pressed, it sets the screen Off → Screen On → Screen Off. * Audio operation is maintained and only the screen will be turned Off. In the screen Off state, press any key to turn the screen On again.

Name	Description
⑨ <b>SCAN</b>	<ul style="list-style-type: none"> <li>• Radio mode</li> <li>- Shortly press the key : Previews each broadcast for 5 seconds each.</li> <li>- Press and hold the key : Previews the broadcasts saved in Preset <b>1</b> ~ <b>6</b> for 5 seconds each.</li> <li>* Press the <b>SCAN</b> key again to continue listening to the current frequency.</li> <li>• CD, USB, iPod<sup>®</sup> modes</li> <li>- Shortly press the key : Previews each song (file) for 10 seconds each.</li> <li>* Press the <b>SCAN</b> key again to continue listening to the current song (file).</li> </ul>
⑩ <b>SETUP CLOCK</b>	<ul style="list-style-type: none"> <li>• Shortly press the key : Moves to the Display, Sound, Clock, Phone, System setting modes.</li> <li>• Press and hold the key : Moves to clock settings</li> </ul>
⑪ <b>MENU</b>	Displays menus for the current mode.
⑫ <b>FOLDER</b> <b>FOLDER</b>	MP3 CD, USB modes : Folder Search. * May differ depending on the selected audio.
⑬ <b>TUNE knob</b>	<ul style="list-style-type: none"> <li>• Radio mode : Changes frequency by turning the knob left/right.</li> <li>• CD, USB, iPod<sup>®</sup> modes : Searches songs (files) by turning the knob left/right.</li> <li>* When the desired song is displayed, press the knob to play the song.</li> </ul>

## Setup (For EUROPE)

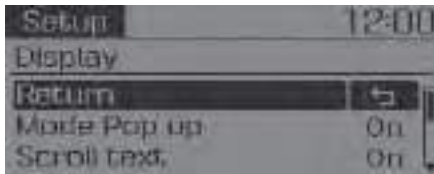

### Display Settings

Press the  key ▶ Select [Display] through  TUNE knob or  key ▶ Select menu through  TUNE knob





Mode Pop up

[Mode Pop up] ▶ Changes  selection mode

- During On state, press the  or  key to display the mode change pop up screen.

Scroll text

[Scroll text] ▶ Set 

-  : Maintains scroll
-  : Scrolls only one (1) time.

Song Info

When playing an MP3 file, select the desired display info from 'Folder/File' or 'Album/Artist/Song'.

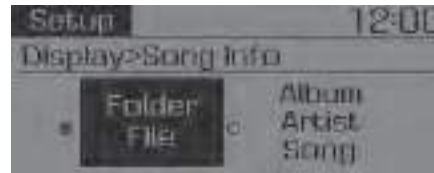

### Sound Settings

Press the  key ▶ Select [Sound] through  TUNE knob or  key ▶ Select menu through  TUNE knob





### AST (Auto Store)

Press the **MENU** key ▶ Set [**1**AST] through **TUNE** knob or **1 RPT** key.

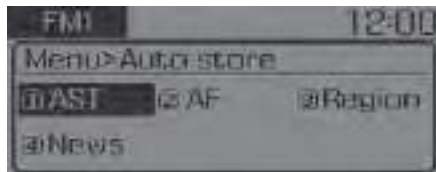

Select AST (Auto Store) to save frequencies with superior reception to presets **1** ~ **6**. If no frequencies are received, then the most recently received frequency will be broadcast.

\* Saves only to the Preset memory **1** ~ **6** of FMA or AMA mode.

### AF (Alternative Frequency)

Press the **MENU** key ▶ Set [**2**AF] through **TUNE** knob or **2 RDM** key.

The Alternative Frequency option can be turned On/Off.

### Region

Press the **MENU** key ▶ Set [**3**Region] through **TUNE** knob or **3** key.

The Region option can be turned On/Off.

### News

Press the **MENU** key ▶ Set [**4**News] through **TUNE** knob or **4** key.

The News option can be turned On/Off.

### Info Volume

Info Volume refers to the sound volume upon receiving News or Traffic information.

The info volume can be controlled by turning the **VOL** knob left/right while a news or traffic broadcast is playing.

\* AF, Region, and News are RDS Radio menus.

## Radio : FM, AM (Except RDS Model)

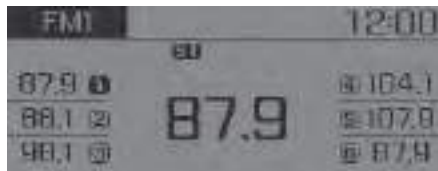

### SEEK

Press the **SEEK** key

- Shortly pressing the key : Changes the frequency.
- Pressing and holding the key : Automatically searches for the next frequency.

### Preset SEEK

Press the **1** ~ **6** key

- Shortly pressing the key : Plays the frequency saved in the corresponding key.
- Pressing and holding the key : Pressing and holding the desired key from **1** ~ **6** will save the currently playing broadcast to the selected key and sound a BEEP.

### SCAN

Press the **SCAN** key

- Shortly pressing the key : The broadcast frequency increases and previews each broadcast for 5 seconds each. After scanning all frequencies, returns and plays the current broadcast frequency.
- Pressing and holding the key : Previews the broadcasts saved in Preset **1** ~ **6** for 5 seconds each.

### Selecting through manual search

Turn the **TUNE** knob left/right to adjust the frequency.

### Menu

Press the **MENU** key ▶ Select [**A**. Store] through the **TUNE** knob or **1 RPT** key

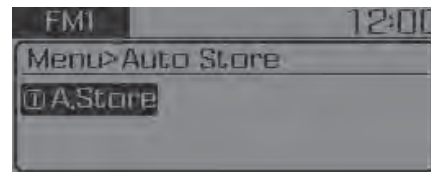

### [**A**.Store

Saves broadcasts with superior reception to **1** ~ **6** keys. If no frequencies are received, then the most recently received frequency will be broadcast.

### MENU : Audio CD

In CD mode, press **MENU** key.

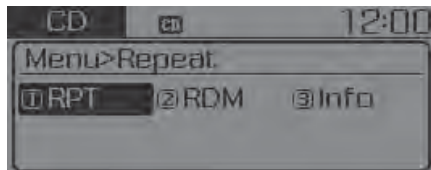

#### Repeat

Set [**1 RPT**] through the **TUNE** knob or **1 RPT** key to repeat the current song.

\* Press RPT again to turn off.

#### Random

Set [**2 RDM**] through the **TUNE** knob or **2 RDM** key to randomly play songs within the CD.

\* Press RDM again to turn off.

#### Information

Set [**3 Info**] through the **TUNE** knob or **3** key to display information of the current song.

\* Press the **MENU** key to turn off info display.

### MENU : MP3 CD / USB

In MP3 CD / USB mode, press **MENU** key.

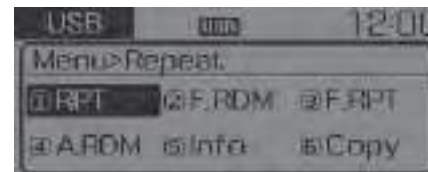

#### Repeat

Set [**1 RPT**] through the **TUNE** knob or **1 RPT** key to repeat the current song.

\* Press RPT again to turn off.

#### Folder Random

Set [**2 F.RDM**] through the **TUNE** knob or **2 RDM** key to randomly play songs within the current folder.

\* Press F.RDM again to turn off.

### Folder Repeat

Set [**3**F.RPT] through the **TUNE** knob or **3** key to repeat songs within the current folder.

\* Press F.RPT again to turn off.

### All Random

Set [**4**A.RDM] through the **TUNE** knob or **4** key to randomly play all songs within the CD / USB.

\* Press A.RDM again to turn off.

### Information

Set [**5**Info] through the **TUNE** knob or **5** key to display information of the current song.

\* Press the **MENU** key to turn off info display.

### Copy (If equipped)

Set [**6**Copy] through the **TUNE** knob or **6** key.

\* This is used to copy the current song into My Music. You can play the copied Music in My Music mode.

\* If another key is pressed while copying is in progress, a pop up asking you whether to cancel copying is displayed.

\* If another media is connected or inserted (USB, CD, iPod<sup>®</sup>, AUX) while copying is in progress, copying is canceled.

\* Music will not be played while copying is in progress.

### MENU : iPod

In iPod mode, press **MENU** key.

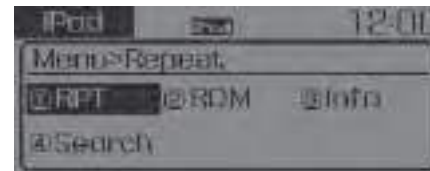

### Repeat

Set [**1**RPT] through the **TUNE** knob or **1 RPT** key to repeat the current song.

\* Press RPT again to turn repeat off.

### Random

Set [**2**RDM] through the **TUNE** knob or **2 RDM** key.

Plays all songs within the currently playing category in random order.

\* Press RDM again to turn off.

### Information

Set [3]Info through the TUNE knob or **3** key.

Displays information of the current song.

\* Press the **MENU** key to turn off info display.

### Search

Set [4]Search through the TUNE knob or **4** key.

Displays iPod® category list.

\* Searching iPod<sup>fi</sup> category is **MENU** key pressed, move to parent category.

### MENU : My Music Mode (If equipped)

In My Music mode, press **MENU** key.

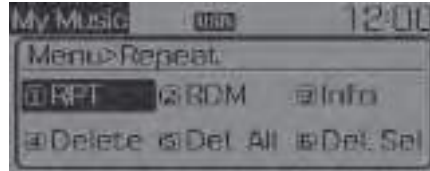

### Repeat

Set [1]RPT through the TUNE knob or **1 RPT** key.

Repeats the currently playing song.

\* Press RPT again to turn repeat off.

### Random

Set [2]RDM through the TUNE knob or **2 RDM** key.

Plays all songs within the currently playing folder in random order.

\* Press RDM again to turn random off.

### Information

Set [3]Info through the TUNE knob or **3** key.

Displays information of the current song.

\* Press the **MENU** key to turn off info display.

### Delete

Set [4]Delete through the TUNE knob or **4** key.

• Deletes currently playing file

In the play screen, pressing delete will delete the currently playing song.

• Deletes file from list

↓ Select the file you wish to delete by using the TUNE knob.

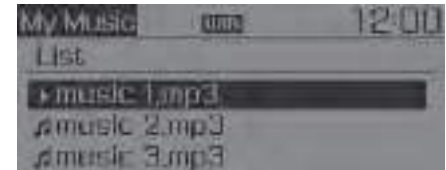

➡ Press the **MENU** key and select the delete menu to delete the selected file.

### Delete All

Set [5]Del.All] through the TUNE knob or [5] key.

Deletes all songs of My Music.

### Delete Selection

Press the [MENU] key▶Set [6]Del.Sel] through the TUNE knob or [6] key.

Songs within My Music are selected and deleted.

Select the songs you wish to delete from the list.

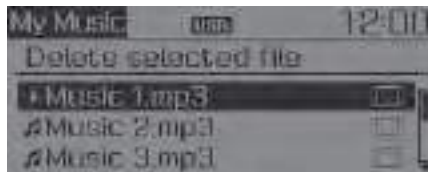

After selecting, press the [MENU] key and select the delete menu.

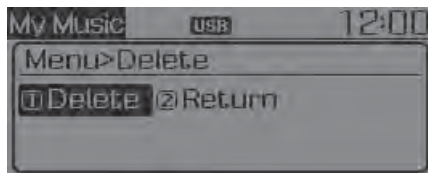

### AUX

AUX is used to play external MEDIA currently connected with the AUX terminal.

AUX mode will automatically start when an external device is connected to the AUX terminal.

If an external device is connected, you can also press the [MEDIA] key to change to AUX mode.

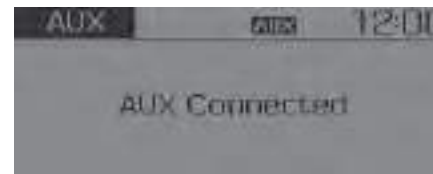

\* AUX mode cannot be started unless there is an external device connected to the AUX terminal.

**i** Information  
- USING THE AUX

**Fully insert the AUX cable into the AUX terminal for use.**

### Making a call using the Steering wheel remote controll



\* The actual feature in the vehicle may differ from the illustration.





Name	Description
① MODE	<ul style="list-style-type: none"><li>• Each time this key is pressed, the mode is changed in order of FM1 → FM2 → FMA → AM → AMA → CD → USB(iPod) → AUX.</li><li>• If the media is not connected or a disc is not inserted, corresponding modes will be disabled.</li></ul>
② VOL+ VOL-	Raises or lowers speaker volume.
③ MUTE	Mutes audio volume.

## Making a call using the Steering wheel remote controller (For Bluetooth equipped



### Model )

\* The actual feature in the vehicle may differ from the illustration.

Name	Description
① MUTE	Mutes the microphone during a call.
② MODE	<ul style="list-style-type: none"> <li>Each time this key is pressed, the mode is changed in order of FM1 → FM2 → FMA → AM → AMA → CD → USB(iPod) → AUX → My Music → BT Audio</li> <li>If the media is not connected or a disc is not inserted, corresponding modes will be disabled.</li> </ul>
③ VOL+ VOL-	Raises or lowers speaker volume.
④  key	<p>Places and transfers calls.</p> <ul style="list-style-type: none"> <li>Check call history and making call</li> <li>♫ Shortly press (under 0.8 seconds) the  key on the steering remote controller. <ul style="list-style-type: none"> <li>⇒ The call history list will be displayed on the screen.</li> </ul> </li> <li>♫ Press the  key again to connect a call to the selected number.</li> <li>Redialing the most recently called number</li> <li>♫ Press and hold (over 0.8 seconds) the  key on the steering remote controller. <ul style="list-style-type: none"> <li>⇒ The most recently called number is redialed.</li> </ul> </li> </ul>
⑤  key	Ends calls or cancels functions.



### Phone MENU (For EUROPE)

Press the  key to display three menus (Call History, Phone Book, Phone Setup).

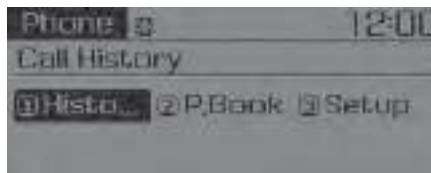

#### Call History

Press the  key ▶ Set [1 History] through the  TUNE knob or  key.

The call history is displayed and can be used to select a number and make a call.

If call history does not exist, a screen asking whether to download call history is displayed. (The download feature may not be supported in some mobile phones)

#### Phone Book

Press the  key ▶ Set [2 P.Book] through the  TUNE knob or  key.

The phone book is displayed and can be used to select a number and make a call.

\* If more than one number is saved to one contact, then a screen showing the mobile phone number, Home and office number is displayed. Select the desired number to make the call.

\* If phone book do not exist, a screen asking whether to download phone book is displayed. (The download feature may not be supported in some mobile phones)

#### Phone Setup

Press the  key ▶ Set [3 Setup] through the  TUNE knob or  key.

The Bluetooth<sup>®</sup> Wireless Technology mobile phone setup screen is displayed. For more information, refer to "Phone Setup".

## Phone MENU (Except EUROPE )

Press the **PHONE** key to display three menus (Call History, Contacts, Phone Setup).

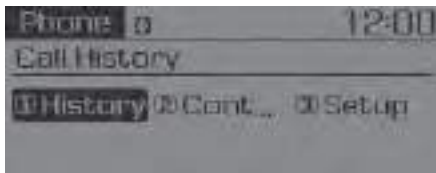

### Call History

Press the **PHONE** key ▶ Set [**1** History] through the **TUNE** knob or **1 RPT** key.

The call history is displayed and can be used to select a number and make a call.

If call history does not exist, a screen asking whether to download call history is displayed. (The download feature may not be supported in some mobile phones)

### Contacts

Press the **PHONE** key ▶ Set [**2** Contacts] through the **TUNE** knob or **2 RDM** key.

The Contacts are displayed and can be used to select a number and make a call.

※ If more than one number is saved to one contact, then a screen showing the mobile phone number, Home and office number is displayed. Select the desired number to make the call.

※ If Contacts do not exist, a screen asking whether to download Contacts is displayed. (The download feature may not be supported in some mobile phones)

### Phone Setup

Press the **PHONE** key ▶ Set [**3** Setup] through the **TUNE** knob or **3** key.

The Bluetooth Wireless Technology mobile phone setup screen is displayed. For more information, refer to "Phone Setup".

## Driving your vehicle

<b>Before driving</b> .....	7-4
Before entering the vehicle .....	7-4
Before starting.....	7-4
<b>Ignition switch</b> .....	7-6
Key ignition switch.....	7-6
Engine Start/Stop button.....	7-11
<b>Manual transaxle</b> .....	7-20
Manual transaxle operation .....	7-20
Good driving practices.....	7-22
<b>Automatic transaxle</b> .....	7-24
Automatic transaxle operation .....	7-24
Parking.....	7-29
Good driving practices.....	7-29
<b>Dual clutch transmission</b> .....	7-31
Dual clutch transmission operation.....	7-31
Parking .....	7-38
Good driving practices .....	7-38
<b>Braking system</b> .....	7-40
Power brakes .....	7-40
Disc brakes wear indicator .....	7-41
Parking brake .....	7-41
Electronic Parking Brake (EPB) .....	7-44
AUTO HOLD .....	7-49
Anti-lock Brake System (ABS) .....	7-53
Electronic Stability Control (ESC) .....	7-55
Vehicle Stability Management (VSM).....	7-59
Hill-Start Assist Control (HAC) .....	7-60
Downhill Brake Control (DBC) .....	7-61
Good braking practices.....	7-63
<b>Four wheel drive (4WD)</b> .....	7-64
4WD operation .....	7-65
Emergency precautions.....	7-69
<b>Flex steering wheel</b> .....	7-71
<b>Drive mode integrated control system</b> .....	7-73
<b>Blind spot detection system (BSD)</b> .....	7-76
BSD (Blind Spot Detection) /	
LCA (Lane Change Assist).....	7-77
RCTA (Rear Cross Traffic Alert) .....	7-80
<b>Cruise control</b> .....	7-84
Cruise control operation .....	7-84
<b>Special driving conditions</b> .....	7-91
Hazardous driving conditions.....	7-91
Rocking the vehicle .....	7-91
Smooth cornering .....	7-92
Driving at night .....	7-92
Driving in the rain .....	7-92
Driving in flooded areas.....	7-93
Highway driving .....	7-93
Reducing the risk of a rollover .....	7-94

**Winter driving**.....7-95  
    Snow or icy conditions .....7-95  
    Winter Precautions .....7-97  
**Vehicle weight**.....7-100  
    Overloading .....7-100

## WARNING

### **Carbon monoxide (CO) gas is toxic. Breathing CO can cause unconsciousness and death.**

Engine exhaust contains carbon monoxide which cannot be seen or smelled.

#### **Do not inhale engine exhaust.**

If at any time you smell engine exhaust inside the vehicle, open the windows immediately. Exposure to CO can cause unconsciousness and death by asphyxiation.

#### **Be sure the exhaust system does not leak.**

The exhaust system should be checked whenever the vehicle is raised to change the oil or for any other purpose. If you hear a change in the sound of the exhaust or if you drive over something that strikes the underneath side of the vehicle, we recommend that the exhaust system be checked as soon as possible by an authorized HYUNDAI dealer.

#### **Do not run the engine in an enclosed area.**

Letting the engine idle in your garage, even with the garage door open, is a hazardous practice. Run the engine only long enough to start the engine and to move the vehicle out of the garage.

#### **Avoid idling the engine for prolonged periods with people inside the vehicle.**

If it is necessary to idle the engine for a prolonged period with people inside the vehicle, be sure to do so only in an open area with the air intake set at "Fresh" and fan control set to high so fresh air is drawn into the interior.

#### **Keep the air intakes clear.**

To assure proper operation of the ventilation system, keep the ventilation air intakes located in front of the windshield clear of snow, ice, leaves, or other obstructions.

#### **If you must drive with the tailgate open:**

Close all windows.

Open instrument panel air vents.

Set the air intake control at "Fresh", the air flow control at "Floor" or "Face", and the fan control set to high.

### BEFORE DRIVING

#### Before entering the vehicle

- Be sure all windows, outside mirror(s), and outside lights are clean and unobstructed.
- Remove frost, snow, or ice.
- Visually check the tires for uneven wear and damage.
- Check under the vehicle for any sign of leaks.
- Be sure there are no obstacles behind you if you intend to back up.

#### Before starting

- Make sure the hood, the trunk, and the doors are securely closed and locked.
- Adjust the position of the seat and steering wheel.
- Adjust the inside and outside rearview mirrors.
- Verify all the lights work.
- Fasten your seatbelt. Check that all passengers have fastened their seatbelts.
- Check the gauges and indicators in the instrument panel and the messages on the instrument display when the ignition switch is in the ON position.
- Check that any items you are carrying are stored properly or fastened down securely.



#### WARNING

To reduce the risk of **SERIOUS INJURY** or **DEATH**, take the following precautions:

- **ALWAYS** wear your seat belt. All passengers must be properly belted whenever the vehicle is moving. For more information, refer to "Seat Belts" in chapter 2.
- **Always drive defensively.** Assume other drivers or pedestrians may be careless and make mistakes.
- **Stay focused on the task of driving.** Driver distraction can cause accidents.
- **Leave plenty of space between you and the vehicle in front of you.**

 **WARNING**

**NEVER** drink or take drugs and drive.

Drinking or taking drugs and driving is dangerous and may result in an accident and **SERIOUS INJURY** or **DEATH**.

Drunk driving is the number one contributor to the highway death toll each year. Even a small amount of alcohol will affect your reflexes, perceptions and judgment. Just one drink can reduce your ability to respond to changing conditions and emergencies and your reaction time gets worse with each additional drink.

Driving while under the influence of drugs is as dangerous or more dangerous than driving under the influence of alcohol.

(Continued)

(Continued)

You are much more likely to have a serious accident if you drink or take drugs and drive. If you are drinking or taking drugs, don't drive. Do not ride with a driver who has been drinking or taking drugs. Choose a designated driver or call a taxi.

## IGNITION SWITCH

### WARNING

To reduce the risk of **SERIOUS INJURY** or **DEATH**, take the following precautions:

- **NEVER** allow children or any person who is unfamiliar with the vehicle to touch the ignition switch or related parts. Unexpected and sudden vehicle movement can occur.
- **NEVER** reach through the steering wheel for the ignition switch, or any other control, while the vehicle is in motion. The presence of your hand or arm in this area may cause a loss of vehicle control resulting in an accident.

### Key ignition switch

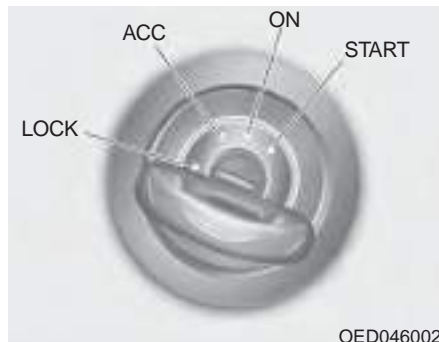

### WARNING

- **NEVER** turn the ignition switch to the LOCK or ACC position while the vehicle is in motion except in an emergency. This will result in the engine turning off and loss of power assist for the steering and brake systems. This may lead to loss of directional control and braking function, which could cause an accident.

(Continued)

(Continued)

- Before leaving the driver's seat, always make sure the shift lever is in 1<sup>st</sup> gear (for manual transaxle vehicle) or P (Park, for automatic transaxle/ dual clutch transmission vehicle) position, apply the parking brake, and turn ignition switch to the LOCK position. Unexpected vehicle movement may occur if these precautions are not followed.



### *Key ignition switch positions*

<b>Switch Position</b>	<b>Action</b>	<b>Notes</b>
<b>LOCK</b>	<p>To turn the ignition switch to the LOCK position, push the key in slightly at the ACC position and turn the key towards the LOCK position.</p> <p>The ignition key can be removed in the LOCK position.</p> <p>The steering wheel locks to protect the vehicle from theft. (if equipped)</p>	
<b>ACC</b>	<p>Electrical accessories are usable.</p> <p>The steering wheel unlocks.</p>	<p>If difficulty is experienced turning the ignition switch to the ACC position, turn the key while turning the steering wheel right and left to release tension.</p>
<b>ON</b>	<p>This is the normal key position when the engine has started.</p> <p>All features and accessories are usable.</p> <p>The warning lights can be checked when you turn the ignition switch from ACC to ON.</p>	<p>Do not leave the ignition switch in the ON position when the engine is not running to prevent the battery from discharging.</p>
<b>START</b>	<p>To start the engine, turn the ignition switch to the START position.</p> <p>The switch returns to the ON position when you let go of the key.</p>	<p>The engine will crank until you release the key.</p>

### Starting the engine

#### **WARNING**

- **Always wear appropriate shoes when operating your vehicle. Unsuitable shoes, such as high heels, ski boots, sandals, flip-flops, etc., may interfere with your ability to use the brake, accelerator and clutch pedals.**
- **Do not start the vehicle with the accelerator pedal depressed. The vehicle can move and lead to an accident.**
- **Wait until the engine rpm is normal. The vehicle may suddenly move if the brake pedal is released when the rpm is high.**

### Starting the gasoline engine

Vehicle with manual transaxle:

1. Make sure the parking brake is applied.
2. Make sure the shift lever is in neutral.
3. Depress the clutch and brake pedals.
4. Turn the ignition switch to the START position. Hold the key (maximum of 10 seconds) until the engine starts and release it.

Vehicle with automatic transaxle/dual clutch transmission:

1. Make sure the parking brake is applied.
2. Make sure the shift lever is in P (Park).
3. Depress the brake pedal.
4. Turn the ignition switch to the START position. Hold the key (maximum of 10 seconds) until the engine starts and release it.

## **i** Information

- **Do not wait for the engine to warm up while the vehicle remains stationary.**



**Start driving at moderate engine speeds. (Steep accelerating and decelerating should be avoided.)**

- **Always start the vehicle with your foot on the brake pedal. Do not depress the accelerator while starting the vehicle. Do not race the engine while warming it up.**



### Starting the diesel engine

To start the diesel engine when the engine is cold, it has to be pre-heated before starting the engine and then have to be warmed up before starting to drive.

Vehicle with manual transaxle:

1. Make sure the parking brake is applied.
2. Make sure the shift lever is in neutral.
3. Depress the clutch and brake pedals.
4. Turn the ignition switch to the ON position to pre-heat the engine. The glow indicator light (  ) will illuminate.
5. When the glow indicator light (  ) goes out, turn the key ignition switch to the START position. Hold the key (maximum of 10 seconds) until the engine starts and release it.

Vehicle with automatic transaxle:

1. Make sure the parking brake is applied.
2. Make sure the shift lever is in P (Park).
3. Depress the brake pedal.
4. Turn the ignition switch to the ON position to pre-heat the engine. The glow indicator light (  ) will illuminate.
5. When the glow indicator light (  ) goes out, turn the key ignition switch to the START position. Hold the key (maximum of 10 seconds) until the engine starts and release it.

### **NOTICE**

**If the engine does not start within 10 seconds after preheating is completed, turn the ignition switch once more to the LOCK position and wait for 10 seconds. Then turn the ignition switch to the ON position in order to preheat the engine again.**

### Starting and stopping the engine for turbocharger intercooler

1. Do not race or accelerate the engine immediately after starting the engine.

If the engine is cold, idle for several seconds before sufficient lubrication is ensured in the turbo charger unit.

2. After high speed or extended driving that requires heavy engine load, idle the engine about 1 minute before turning the engine off.

This idle time will allow the turbocharger to cool prior to shutting the engine off.

#### **NOTICE**

**Do not turn off the engine immediately after it has been subjected to a heavy load. Doing so may cause severe damage to the engine or turbo charger unit.**

#### **NOTICE**

**To prevent damage to the vehicle:**

- Do not hold the ignition key in the START position for more than 10 seconds. Wait 5 to 10 seconds before trying again.
- Do not turn the ignition switch to the START position with the engine running. It may damage the starter.
- If traffic and road conditions permit, you may put the shift lever in the N (Neutral) position while the vehicle is still moving and turn the ignition switch to the START position in an attempt to restart the engine.
- Do not push or tow your vehicle to start the engine.

## Engine Start/Stop button



Whenever the front door is opened, the Engine Start/Stop button will illuminate and will go off 30 seconds after the door is closed. (if equipped)

### WARNING

To turn the engine off in an emergency:

Press and hold the Engine Start/Stop button for more than two seconds OR Rapidly press and release the Engine Start/Stop button three times (within three seconds).



If the vehicle is still moving, you can restart the engine without depressing the brake pedal by pressing the Engine Start/Stop button with the shift lever in the N (Neutral) position.

### WARNING



- NEVER press the Engine Start/Stop button while the vehicle is in motion except in an emergency. This will result in the engine turning off and loss of power assist for the steering and brake systems. This may lead to loss of directional control and braking function, which could cause an accident.
- Before leaving the driver's seat, always make sure the shift lever is in the P (Park) position, set the parking brake, press the Engine Start/ Stop button to the OFF position, and take the Smart Key with you. Unexpected vehicle movement may occur if these precautions are not followed.

**Engine Stop/Start button positions**

- Vehicle with manual transaxle



Button Position	Action	Notes
<p><b>OFF</b></p> 	<p>To turn off the engine, stop the vehicle and then press the Engine Start/Stop button. The steering wheel locks to protect the vehicle from theft. (if equipped)</p>	<p>If the steering wheel is not locked properly when you open the driver's door, the warning chime will sound.</p>
<p><b>ACC</b></p> 	<p>Press the Engine Start/Stop button when the button is in the OFF position without depressing the clutch pedal. Electrical accessories are usable. The steering wheel unlocks.</p>	<p>If you leave the Engine Start/Stop button in the ACC position for more than one hour, the battery power will turn off automatically to prevent the battery from discharging.  If the steering wheel doesn't unlock properly, the Engine Start/Stop button will not work. Press the Engine Start/Stop button while turning the steering wheel right and left to release tension.</p>

- Vehicle with manual transaxle

Button Position	Action	Notes
<p data-bbox="244 283 294 309"><b>ON</b></p> 	<p data-bbox="409 291 926 373">Press the Engine Start/Stop button while it is in the ACC position without depressing the clutch pedal.</p> <p data-bbox="409 383 915 438">The warning lights can be checked before the engine is started.</p>	<p data-bbox="959 291 1488 373">Do not leave the Engine Start/Stop button in the ON position when the engine is not running to prevent the battery from discharging.</p>
<p data-bbox="224 589 315 615"><b>START</b></p> 	<p data-bbox="409 595 926 677">To start the engine, depress the clutch and brake pedals and press the Engine Start/Stop button with the shift lever in neutral.</p>	<p data-bbox="959 595 1447 706">If you press the Engine Start/Stop button without depressing the clutch pedal, the engine does not start and the Engine Start/Stop button changes as follows:</p> <p data-bbox="959 712 1389 742"><b>OFF → ACC → ON → OFF or ACC</b></p>



**Engine Stop/Start button positions**

- Vehicle with automatic transaxle/dual clutch transmission

Button Position	Action	Notes
<p data-bbox="244 315 299 342"><b>OFF</b></p> 	<p data-bbox="411 322 939 520">To turn off the engine, press the Engine Start/Stop button with shift lever in P (Park). When you press the Engine Start/Stop button without the shift lever in P (Park), the Engine Start/Stop button does not turn to the OFF position, but turns to the ACC position.</p> <p data-bbox="411 533 939 589">The steering wheel locks to protect the vehicle from theft. (if equipped)</p>	<p data-bbox="959 322 1500 403">If the steering wheel is not locked properly when you open the driver's door, the warning chime will sound.</p>
<p data-bbox="244 618 299 645"><b>ACC</b></p> 	<p data-bbox="411 625 901 706">Press the Engine Start/Stop button when the button is in the OFF position without depressing the brake pedal.</p> <p data-bbox="411 719 814 742">Electrical accessories are usable.</p> <p data-bbox="411 754 748 777">The steering wheel unlocks.</p>	<p data-bbox="959 625 1500 735">If you leave the Engine Start/Stop button in the ACC position for more than one hour, the battery power will turn off automatically to prevent the battery from discharging.</p> <p data-bbox="959 747 1493 880">If the steering wheel doesn't unlock properly, the Engine Start/Stop button will not work. Press the Engine Start/Stop button while turning the steering wheel right and left to release tension.</p>



- Vehicle with automatic transaxle/dual clutch transmission

Button Position	Action	Notes
<p data-bbox="244 283 294 309"><b>ON</b></p> 	<p data-bbox="409 291 925 373">Press the Engine Start/Stop button while it is in the ACC position without depressing the brake pedal.</p> <p data-bbox="409 383 911 439">The warning lights can be checked before the engine is started.</p>	<p data-bbox="958 291 1495 373">Do not leave the Engine Start/Stop button in the ON position when the engine is not running to prevent the battery from discharging.</p>
<p data-bbox="224 589 317 615"><b>START</b></p> 	<p data-bbox="409 595 938 705">To start the engine, depress the brake pedal and press the Engine Start/Stop button with the shift lever in the P (Park) or in the N (Neutral) position.</p> <p data-bbox="409 715 892 771">For your safety, start the engine with the shift lever in the P (Park) position.</p>	<p data-bbox="958 595 1450 705">If you press the Engine Start/Stop button without depressing the brake pedal, the engine does not start and the Engine Start/Stop button changes as follows:</p> <p data-bbox="958 715 1390 740"><b>OFF → ACC → ON → OFF or ACC</b></p>

## Starting the engine

### WARNING

- Always wear appropriate shoes when operating your vehicle. Unsuitable shoes, such as high heels, ski boots, sandals, flip-flops, etc., may interfere with your ability to use the brake, accelerator and clutch pedals.
- Do not start the vehicle with the accelerator pedal depressed.  
The vehicle can move and lead to an accident.
- Wait until the engine rpm is normal. The vehicle may suddenly move if the brake pedal is released when the rpm is high.

### Information

- The engine will start by pressing the Engine Start/Stop button, only when the smart key is in the vehicle.
- Even if the smart key is in the vehicle, if it is far away from the driver, the engine may not start.
- When the Engine Start/Stop button is in the ACC or ON position, if any door is open, the system checks for the smart key. If the smart key is not in the vehicle, the " " indicator will blink and the warning "Key not in vehicle" will come on, and if all doors are closed, the chime will also sound for about 5 seconds. Keep the smart key in the vehicle when using the ACC position or if the vehicle engine is ON.

## Starting the gasoline engine

Vehicle with manual transaxle:

1. Always carry the smart key with you.
2. Make sure the parking brake is applied.
3. Make sure the shift lever is in neutral.
4. Depress the clutch and brake pedals.
5. Press the Engine Start/Stop button.

Vehicle with automatic transaxle/dual clutch transmission:

1. Always carry the smart key with you.
2. Make sure the parking brake is applied.
3. Make sure the shift lever is in P (Park).
4. Depress the brake pedal.
5. Press the Engine Start/Stop button.

## **i** Information

- **Do not wait for the engine to warm up while the vehicle remains stationary.**



**Start driving at moderate engine speeds. (Steep accelerating and decelerating should be avoided.)**

- **Always start the vehicle with your foot on the brake pedal. Do not depress the accelerator while starting the vehicle. Do not race the engine while warming it up.**



### **Starting the diesel engine**

To start the diesel engine when the engine is cold, it has to be pre-heated before starting the engine and then have to be warmed up before starting to drive.

Vehicle with manual transaxle:

1. Always carry the smart key with you.
2. Make sure the parking brake is applied.
3. Make sure the shift lever is in neutral.
4. Depress the clutch and brake pedal.
5. Press the Engine Start/Stop button.
6. Continue depressing the brake pedal until the glow indicator light (  ) goes out.
7. When the glow indicator light (  ) goes out, the engine will start.

Vehicle with automatic transaxle:

1. Always carry the smart key with you.
2. Make sure the parking brake is applied.
3. Make sure the shift lever is in P (Park).
4. Depress the brake pedal.
5. Press the Engine Start/Stop button.
6. Continue depressing the brake pedal until the glow indicator light (  ) goes out.
7. When the glow indicator light (  ) goes out, the engine will start.

### **NOTICE**

**If the Engine Start/Stop button is pressed while the engine is pre-heating, the engine may start.**

### Starting and stopping the engine for turbocharger intercooler

1. Do not race or accelerate the engine immediately after starting the engine.  
If the engine is cold, idle for several seconds before sufficient lubrication is ensured in the turbo charger unit.
2. After high speed or extended driving that requires heavy engine load, idle the engine about 1 minute before turning the engine off. This idle time will allow the turbocharger to cool prior to shutting the engine off.

#### **NOTICE**

Do not turn off the engine immediately after it has been subjected to a heavy load. Doing so may cause severe damage to the engine or turbo charger unit.

#### **NOTICE**

To prevent damage to the vehicle:

- If the engine stalls while you are in motion, do not attempt to move the shift lever to the P (Park) position.  
If traffic and road conditions permit, you may put the shift lever in the N (Neutral) position while the vehicle is still moving and press the Engine Start/Stop button in an attempt to restart the engine.
- Do not push or tow your vehicle to start the engine.

#### **NOTICE**

To prevent damage to the vehicle:

Do not press the Engine Start/ Stop button for more than 10 seconds except when the stop lamp fuse is blown.

When the stop lamp fuse is blown, you can't start the engine normally. Replace the fuse with a new one. If you are not able to replace the fuse, you can start the engine by pressing and holding the Engine Start/Stop button for 10 seconds with the Engine Start/ Stop button in the ACC position.

For your safety always depress the brake and/or clutch pedal before starting the engine.



### **i** Information

If the smart key battery is weak or the smart key does not work correctly, you can start the engine by pressing the Engine Start/Stop button with the smart key in the direction of the picture above.

## MANUAL TRANSAXLE (IF EQUIPPED)

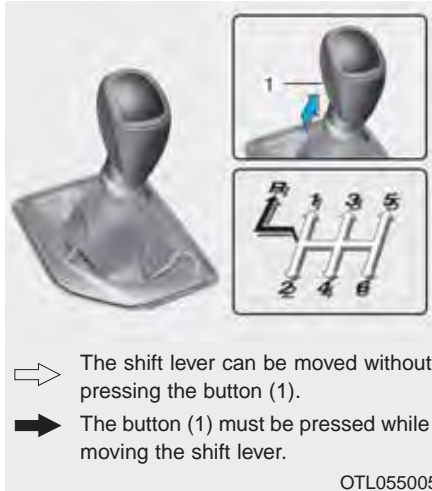

- The shift lever can be moved without pressing the button (1).
- The button (1) must be pressed while moving the shift lever.

OTL055005

### Manual transaxle operation

The manual transaxle has 6 forward gears. The transaxle is fully synchronized in all forward gears so shifting to either a higher or a lower gear is easily accomplished.

#### WARNING

**Before leaving the driver's seat, always make sure the shift lever is in 1<sup>st</sup> gear when the vehicle is parked on a uphill and in R (Reverse) on a downhill, set the parking brake, and place the ignition switch in the LOCK/OFF position. Unexpected vehicle movement may occur if these precautions are not followed.**

To shift to R (Reverse), make sure the vehicle has completely stopped, and then move the shift lever to neutral before moving into R (Reverse).

When you've come to a complete stop and it's hard to shift into 1<sup>st</sup> gear or R (Reverse):

1. Put the shift lever in neutral and release the clutch pedal.
2. Depress the clutch pedal, and then shift into first or R (Reverse) gear.

#### Information

**During cold weather, shifting may be difficult until the transaxle lubricant has warmed up.**

### *Using the clutch*

The clutch pedal should be depressed all the way to the floor before:

- Starting the engine  
The engine will not start without depressing the clutch pedal.
- Shifting

When releasing the clutch pedal, release it slowly. The clutch pedal should always be released while driving.

### **NOTICE**

**To prevent unnecessary wear or damage to the clutch:**

- **Do not rest your foot on the clutch pedal while driving.**
- **Do not hold the vehicle with the clutch on an incline, while waiting for the traffic light, etc.**
- **Always depress the clutch pedal down fully to prevent noise or damage.**
- **Do not start with the 2<sup>nd</sup> (second) gear engaged except when you start on a slippery road.**

### *Downshifting*

Downshift when you must slow down in heavy traffic or drive up a steep hill to prevent engine load.

Also, downshifting reduces the chance of stalling and can accelerate when you need to increase your speed again.

When the vehicle is going downhill, downshifting helps maintain safe speed by providing brake power from the engine and enables less wear on the brakes.

### NOTICE

To prevent damage to the engine, clutch and transaxle:

- When downshifting from 5th gear to 4th gear, be careful not to inadvertently push the shift lever sideways engaging the 2<sup>nd</sup> gear. A drastic downshift may cause the engine speed to increase to the point the tachometer will enter the red-zone.
- Do not downshift more than two gear at a time or downshift the gear when the engine is running at high speed (5,000 RPM or higher). Such a downshifting may damage the engine, clutch and the transaxle.

### Good driving practices

- Never take the vehicle out of gear and coast down a hill. This is extremely dangerous.
- Don't "ride" the brakes. This can cause the brakes and related parts to overheat and malfunction.

When you are driving down a long hill, slow down and shift to a lower gear. Engine braking will help slow down the vehicle.

- Slow down before shifting to a lower gear. This will help avoid over-revving the engine, which can cause damage.
- Slow down when you encounter cross winds. This gives you much better control of your vehicle.
- Be sure the vehicle is completely stopped before you shift into R (Reverse) to prevent damage to the transaxle.

- Exercise extreme caution when driving on a slippery surface. Be especially careful when braking, accelerating or shifting gears. On a slippery surface, an abrupt change in vehicle speed can cause the drive wheels to lose traction and may cause loss of vehicle control resulting in an accident

### WARNING

**Do not use the engine brake (shifting from a higher gear to lower gear) rapidly on slippery roads. The vehicle may slip causing an accident.**



## WARNING

To reduce the risk of **SERIOUS INJURY** or **DEATH**:

- **ALWAYS** wear your seatbelt. In a collision, an unbelted occupant is significantly more likely to be seriously injured or killed than a properly belted occupant.
- Avoid high speeds when cornering or turning.
- Do not make quick steering wheel movements, such as sharp lane changes or fast, sharp turns.
- The risk of rollover is greatly increased if you lose control of your vehicle at highway speeds.
- Loss of control often occurs if two or more wheels drop off the roadway and the driver oversteers to reenter the roadway.

(Continued)

(Continued)

- In the event your vehicle leaves

the roadway, do not steer sharply. Instead, slow down before pulling back into the travel lanes.

- **HYUNDAI** recommends you follow all posted speed limits.

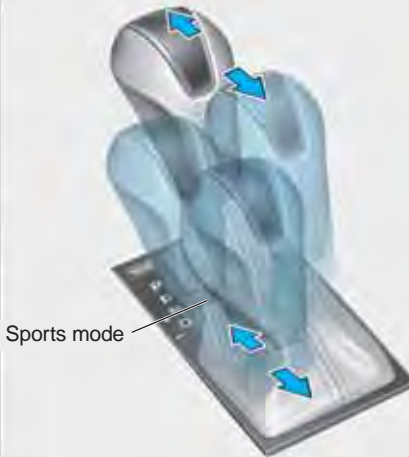
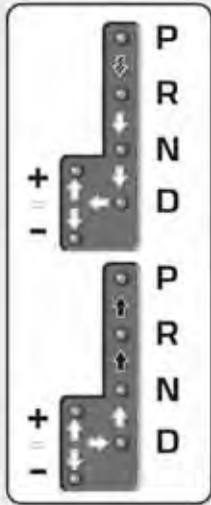

## AUTOMATIC TRANSAXLE (IF EQUIPPED)

### ■ Left-hand drive

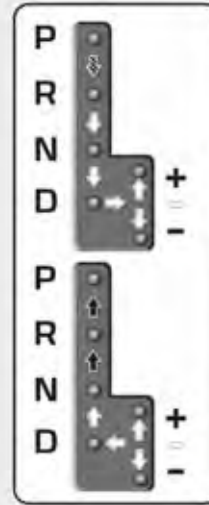

### ■ Right-hand drive



-  Depress the brake pedal and press the shift button while moving the shift lever.
-  Press the shift button while moving the shift lever.
-  The shift lever can freely operate.

OTL055006/OTL055006R

### Automatic transaxle operation

The automatic transaxle has six forward speeds and one reverse speed. The individual speeds are selected automatically in the D (Drive) position.

 **WARNING**

To reduce the risk of serious injury or death:

- **ALWAYS** check the surrounding areas near your vehicle for people, especially children, before shifting a vehicle into D (Drive) or R (Reverse).
- Before leaving the driver's seat, always make sure the shift lever is in the P (Park) position, then set the parking brake, and place the ignition switch in the LOCK/OFF position. Unexpected and sudden vehicle movement can occur if these precautions are not followed.
- Do not use the engine brake (shifting from a high gear to lower gear) rapidly on slippery roads. The vehicle may slip causing an accident.

The indicator in the instrument cluster displays the shift lever position when the ignition switch is in the ON position.

***P (Park)***

Always come to a complete stop before shifting into P (Park).

To shift from P (Park), you must depress firmly on the brake pedal and make sure your foot is off the accelerator pedal.

**If you have done all of the above and still cannot shift the lever out of P (Park), see "Shift-Lock Release" in this chapter.**

The shift lever must be in P (Park) before turning the engine off.

 **WARNING**

- Shifting into P (Park) while the vehicle is in motion may cause you to lose control of the vehicle.
- After the vehicle has stopped, always make sure the shift lever is in P (Park), apply the parking brake, and turn the engine off.
- Do not use the P (Park) position in place of the parking brake.

### ***R (Reverse)***

Use this position to drive the vehicle backward.

#### **NOTICE**

**Always come to a complete stop before shifting into or out of R (Reverse); you may damage the transaxle if you shift into R (Reverse) while the vehicle is in motion.**

### ***N (Neutral)***

The wheels and transaxle are not engaged.

Use N (Neutral) if you need to restart a stalled engine, or if it is necessary to stop with the engine ON. Shift into P (Park) if you need to leave your vehicle for any reason.

Always depress the brake pedal when you are shifting from N (Neutral) to another gear.

#### **WARNING**

**Do not shift into gear unless your foot is firmly on the brake pedal. Shifting into gear when the engine is running at high speed can cause the vehicle to move very rapidly. You could lose control of the vehicle and hit people or objects.**

### ***D (Drive)***

This is the normal driving position. The transaxle will automatically shift through a 6-gear sequence, providing the best fuel economy and power.

For extra power when passing another vehicle or driving uphill, depress the accelerator fully. The transaxle will automatically downshift to the next lower gear (or gears, as appropriate).

The DRIVE MODE switch, located on the shift lever console, allows the driver to switch from NORMAL mode to SPORT or ECO mode. (if equipped)

**For more information, refer to "Drive Mode Integrated Control System" later in this chapter.**

## Sports mode

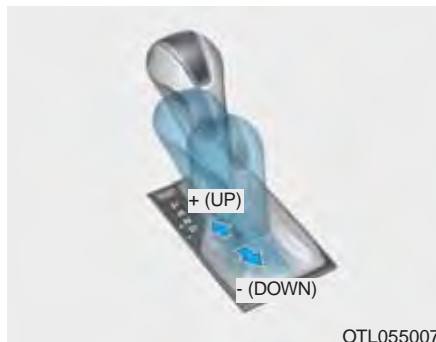

OTL055007

Whether the vehicle is stationary or in motion, sports mode is selected by pushing the shift lever from the D (Drive) position into the manual gate. To return to D (Drive) range operation, push the shift lever back into the main gate.

In Sports Mode, moving the shift lever backwards and forwards will allow you to select the desired range of gears for the current driving conditions.

- + (Up) : Push the lever forward once to shift up one gear.
- (Down) : Pull the lever backwards once to shift down one gear.

### **i** Information

- **Only the six forward gears can be selected. To reverse or park the vehicle, move the shift lever to the R (Reverse) or P (Park) position as required.**
- **Downshifts are made automatically when the vehicle slows down. When the vehicle stops, 1<sup>st</sup> gear is automatically selected.**
- **When the engine rpm approaches the red zone the transaxle will upshift automatically.**

(Continued)

(Continued)

- **If the driver presses the lever to + (Up) or - (Down) position, the transaxle may not make the requested gear change if the next gear is outside of the allowable engine rpm range. The driver must execute upshifts in accordance with road conditions, taking care to keep the engine rpms below the red zone.**
- **When driving on a slippery road, push the shift lever forward into the + (Up) position. This causes the transaxle to shift into the 2<sup>nd</sup> gear which is better for smooth driving on a slippery road. Push the shift lever to the - (Down) side to shift back to the 1<sup>st</sup> gear.**

### **Shift-lock system**

For your safety, the automatic transaxle has a shift-lock system which prevents shifting the transaxle from P (Park) into R (Reverse) unless the brake pedal is depressed. To shift the transaxle from P (Park) into R (Reverse):

1. Depress and hold the brake pedal.
2. Start the engine or place the ignition switch in the ON position.
3. Move the shift lever.

### **Shift-lock release**

If the shift lever cannot be moved from the P (Park) position into R (Reverse) position with the brake pedal depressed, continue depressing the brake, and then do the following:



1. Place the ignition switch in the LOCK/OFF position.
2. Apply the parking brake.
3. Carefully remove the cap (1) covering the shift-lock access hole.
4. Insert a tool (e.g. flathead screwdriver) into the access hole and press down on the tool.
5. Move the shift lever while holding down the screwdriver.
6. Remove the tool from the shiftlock release access hole then install the cap.
7. Depress the brake pedal, and then restart the engine.

If you need to use the shift-lock release, we recommend that the system be inspected by an authorized HYUNDAI dealer immediately.

### ***Ignition key interlock system (if equipped)***

The ignition key cannot be removed unless the shift lever is in the P (Park) position.

### **Parking**

Always come to a complete stop and continue to depress the brake pedal. Move the shift lever into the P (Park) position, apply the parking brake, and place the ignition switch in the LOCK/OFF position. Take the Key with you when exiting the vehicle.

#### **WARNING**

**When you stay in the vehicle with the engine running, be careful not to depress the accelerator pedal for a long period of time. The engine or exhaust system may overheat and start a fire.**

**The exhaust gas and the exhaust system are very hot. Keep away from the exhaust system components.**

**Do not stop or park over flammable materials, such as dry grass, paper or leaves. They may ignite and cause a fire.**

### **Good driving practices**

- Never move the shift lever from P (Park) or N (Neutral) to any other position with the accelerator pedal depressed.
- Never move the shift lever into P (Park) when the vehicle is in motion.

Be sure the vehicle is completely stopped before you attempt to shift into R (Reverse) or D (Drive).

- Do not move the shift lever to N (Neutral) when driving. Doing so may result in an accident because of a loss of engine braking and the transaxle could be damaged.
- Do not drive with your foot resting on the brake pedal. Even light, but consistent pedal pressure can result in the brakes overheating, brake wear and possibly even brake failure.
- When driving in sports mode, slow down before shifting to a lower gear. Otherwise, the lower gear may not be engaged if the engine rpms are outside of the allowable range.

- Always apply the parking brake when leaving the vehicle. Do not depend on placing the transaxle in P (Park) to keep the vehicle from moving.
- Exercise extreme caution when driving on a slippery surface. Be especially careful when braking, accelerating or shifting gears. On a slippery surface, an abrupt change in vehicle speed can cause the drive wheels to lose traction and may cause loss of vehicle control resulting in an accident
- Optimum vehicle performance and economy is obtained by smoothly depressing and releasing the accelerator.

### WARNING

To reduce the risk of **SERIOUS INJURY or DEATH:**

- **ALWAYS** wear your seatbelt. In a collision, an unbelted occupant is significantly more likely to be seriously injured or killed than a properly belted occupant.
- Avoid high speeds when cornering or turning.
- Do not make quick steering wheel movements, such as sharp lane changes or fast, sharp turns.
- The risk of rollover is greatly increased if you lose control of your vehicle at highway speeds.
- Loss of control often occurs if two or more wheels drop off the roadway and the driver oversteers to reenter the roadway.

(Continued)

(Continued)

- In the event your vehicle leaves the roadway, do not steer sharply. Instead, slow down before pulling back into the travel lanes.
- HYUNDAI recommends you follow all posted speed limits.





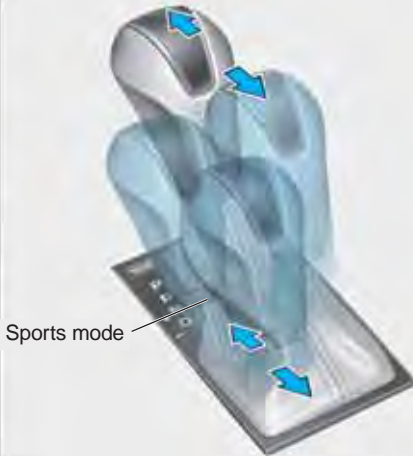
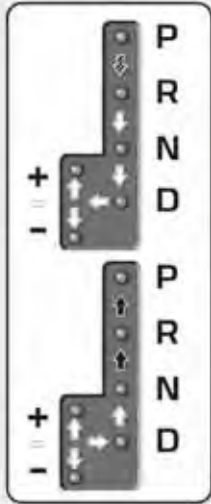

## DUAL CLUTCH TRANSMISSION (IF EQUIPPED)

■ Left-hand drive

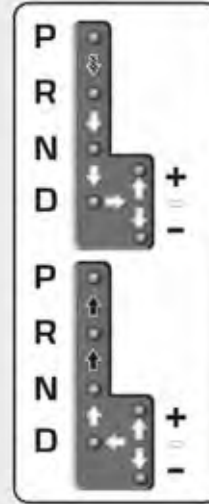

■ Right-hand drive



-  Depress the brake pedal and press the shift button while moving the shift lever.
-  Press the shift button while moving the shift lever.
-  The shift lever can freely operate.

OTL055006/OTL055006R

### Dual clutch transmission operation

The dual clutch transmission has 7 forward speeds and one reverse speed. The individual speeds are selected automatically in the D (Drive) position.

 **WARNING**

To reduce the risk of serious injury or death:

- **ALWAYS** check the surrounding areas near your vehicle for people, especially children, before shifting a vehicle into D (Drive) or R (Reverse).
- Before leaving the driver's seat, always make sure the shift lever is in the P (Park) position, then set the parking brake, and place the ignition switch in the LOCK/OFF position. Unexpected and sudden vehicle movement can occur if these precautions are not followed.

(Continued)

(Continued)

- Do not use the engine brake (shifting from a high gear to lower gear) rapidly on slippery roads. The vehicle may slip causing an accident.
- The dual clutch transmission gives the driving feel of a manual transaxle, yet provides the ease of a fully automatic transaxle. Unlike a traditional automatic transaxle, the gear shifting can be felt (and heard) on the dual clutch transmission
  - Think of it as an automatically shifting manual transaxle.
  - Shift into Drive range and get fully automatic shifting, similar to a conventional automatic transaxle.
- Dual clutch transmission adopts dry-type dual clutch, which is different from torque converter of automatic transaxle, and shows better acceleration performance during driving. But, initial launch might be little bit slower than Automatic Transaxle.
- The dry-type clutch transfers torque and provides a direct driving feeling which may feel different from a conventional automatic transaxle with a torque converter. This may be more noticeable when starting from a stop or low vehicle speed.
- When rapidly accelerating at low vehicle speed, engine could rev at high rpm depending on vehicle drive condition.
- For smooth launch uphill, press down the accelerator pedal smoothly depending on the current conditions.
- If you release your foot from the accelerator pedal at low vehicle speed, you may feel strong engine brake, which is similar to manual transaxle.

- When driving downhill, you may use Sports Mode to downshift to a lower gear in order to control your speed without using the brake pedal excessively.
- When you turn the engine on and off, you may hear clicking sounds as the system goes through a self test. This is a normal sound for the Dual clutch transmission.



- To hold the vehicle on a hill use the foot brake or the parking brake. If the vehicle is held by applying the accelerator pedal on a hill the clutch and transmission will be overheated resulting in damage. At this time, a warning message will appear on the LCD display and you may feel a vibration.

(Continued)

(Continued)

- If the clutch becomes overheated by excessive use of the clutch to hold on a hill, you may notice a shudder feeling and a blinking display on the instrument cluster. When this occurs, the clutch is disabled until the clutch cools to normal temperatures. If this occurs, pull over to a safe location, shift into P (Park) and apply the foot brake for a few minutes.
- If the LCD warning is active, the foot brake must be applied.
- Ignoring the warnings can lead to damage to the transmission.
- If the display continues to blink, for your safety, we recommend that you contact an authorized HYUNDAI dealer and have the system checked.

(Continued)

(Continued)



- Under certain conditions such as repeated launch on steep grades, the clutch in the transmission could overheat. When the clutch is overheated, the safe protection mode engages.

(Continued)

(Continued)

If the safe protection mode engages, the gear position indicator on the cluster blinks with a chime sound. At this time, a warning message will appear on the LCD display and driving may not be smooth.

If you ignore this warning, the driving condition may become worse. To return the normal driving condition, stop the vehicle and apply the foot brake for a few minutes before driving off.

- Gear shifts may be more noticeable than a conventional automatic transaxle. This is a normal characteristic of this type of dual clutch transmission.
- During the first 1,500 km (1,000 miles), you may feel that the vehicle may not be smooth when accelerating at low speed. During this break-in period, the shift quality and performance of your new vehicle is continuously optimized.

(Continued)

(Continued)

- Always come to a complete stop before shifting into D (Drive) or R (Reverse).
- Do not put the shift lever in N (Neutral) while driving.

### **Transmission ranges**

The indicator in the instrument cluster displays the shift lever position when the ignition switch is in the ON position.

#### **P (Park)**

Always come to a complete stop before shifting into P (Park).

To shift from P (Park), you must depress firmly on the brake pedal and make sure your foot is off the accelerator pedal.

**If you have done all of the above and still cannot shift the lever out of P (Park), see "Shift-Lock Release" in this chapter.**

The shift lever must be in P (Park) before turning the engine off.

### **WARNING**

- **Shifting into P (Park) while the vehicle is in motion may cause you to lose control of the vehicle.**
- **After the vehicle has stopped, always make sure the shift lever is in P (Park), apply the parking brake, and turn the engine off.**
- **Do not use the P (Park) position in place of the parking brake.**

#### **R (Reverse)**

Use this position to drive the vehicle backward.

#### **NOTICE**

**Always come to a complete stop before shifting into or out of R (Reverse); you may damage the transaxle if you shift into R (Reverse) while the vehicle is in motion.**

#### **N (Neutral)**

The wheels and transaxle are not engaged.

Use N (Neutral) if you need to restart a stalled engine, or if it is necessary to stop with the engine ON. Shift into P (Park) if you need to leave your vehicle for any reason.

Always depress the brake pedal when you are shifting from N (Neutral) to another gear.

### D (Drive)

This is the normal driving position. The transmission will automatically shift through a 7-gear sequence, providing the best fuel economy and power.

For extra power when passing another vehicle or driving uphill, depress the accelerator fully. The transmission will automatically downshift to the next lower gear (or gears, as appropriate).

The DRIVE MODE switch, located on the shift lever console, allows the driver to switch from NORMAL mode to SPORT or ECO mode. (if equipped)

**For more information, refer to "Drive Mode Integrated Control System" later in this chapter.**



OTL055007

### Sports mode

Whether the vehicle is stationary or in motion, sports mode is selected by pushing the shift lever from the D (Drive) position into the manual gate. To return to D (Drive) range operation, push the shift lever back into the main gate.

In sports mode, moving the shift lever backwards and forwards will allow you to make gearshifts rapidly.

Up (+) : Push the lever forward once to shift up one gear.

Down (-) : Pull the lever backwards once to shift down one gear.

### **i** Information

- Only the seven forward gears can be selected. To reverse or park the vehicle, move the shift lever to the R (Reverse) or P (Park) position as required.
- Downshifts are made automatically when the vehicle slows down. When the vehicle stops, 1st gear is automatically selected.
- When the engine rpm approaches the red zone the transmission will upshift automatically.
- If the driver presses the lever to + (Up) or - (Down) position, the transmission may not make the requested gear change if the next gear is outside of the allowable engine rpm range. The driver must execute upshifts in accordance with road conditions, taking care to keep the engine rpms below the red zone.

(Continued)

(Continued)

- When driving on a slippery road, push the shift lever forward into the + (Up) position. This causes the transmission to shift into the 2nd gear which is better for smooth driving on a slippery road. Push the shift lever to the - (Down) side to shift back to the 1st gear.

### ***Shift-lock system***

For your safety, the dual clutch transmission has a shift-lock system which prevents shifting the transmission from P (Park) into R (Reverse) unless the brake pedal is depressed.

To shift the transmission from P (Park) into R (Reverse):

1. Depress and hold the brake pedal.
2. Start the engine or place the ignition switch in the ON position.
3. Move the shift lever.

### ***Shift-lock release***

If the shift lever cannot be moved from the P (Park) position into R (Reverse) position with the brake pedal depressed, continue depressing the brake, and then do the following:



1. Place the ignition switch in the LOCK/OFF position.
2. Apply the parking brake.
3. Carefully remove the cap (1) covering the shift-lock access hole.
4. Insert a tool (e.g. flathead screwdriver) into the access hole and press down on the tool.
5. Move the shift lever while holding down the screwdriver.
6. Remove the tool from the shiftlock release access hole then install the cap.
7. Depress the brake pedal, and then restart the engine.

If you need to use the shift-lock release, we recommend that the system be inspected by an authorized HYUNDAI dealer immediately.

### ***Ignition key interlock system (if equipped)***

The ignition key cannot be removed unless the shift lever is in the P (Park) position.

### **Parking**

Always come to a complete stop and continue to depress the brake pedal. Move the shift lever into the P (Park) position, apply the parking brake, and place the ignition switch in the LOCK/OFF position. Take the Key with you when exiting the vehicle.

#### **WARNING**

**When you stay in the vehicle with the engine running, be careful not to depress the accelerator pedal for a long period of time. The engine or exhaust system may overheat and start a fire.**

**The exhaust gas and the exhaust system are very hot. Keep away from the exhaust system components.**

**Do not stop or park over flammable materials, such as dry grass, paper or leaves. They may ignite and cause a fire.**

### **Good driving practices**

- Never move the shift lever from P (Park) or N (Neutral) to any other position with the accelerator pedal depressed.
- Never move the shift lever into P (Park) when the vehicle is in motion.

Be sure the vehicle is completely stopped before you attempt to shift into R (Reverse) or D (Drive).

- Do not move the shift lever to N (Neutral) when driving. Doing so may result in an accident because of a loss of engine braking and the transmission could be damaged.
- Do not drive with your foot resting on the brake pedal. Even light, but consistent pedal pressure can result in the brakes overheating, brake wear and possibly even brake failure.
- When driving in sports mode, slow down before shifting to a lower gear. Otherwise, the lower gear may not be engaged if the engine rpms are outside of the allowable range.



- Always apply the parking brake when leaving the vehicle. Do not depend on placing the transmission in P (Park) to keep the vehicle from moving.
- Exercise extreme caution when driving on a slippery surface. Be especially careful when braking, accelerating or shifting gears. On a slippery surface, an abrupt change in vehicle speed can cause the drive wheels to lose traction and may cause loss of vehicle control resulting in an accident
- Optimum vehicle performance and economy is obtained by smoothly depressing and releasing the accelerator.

 **WARNING**

To reduce the risk of **SERIOUS INJURY or DEATH:**

- **ALWAYS** wear your seatbelt. In a collision, an unbelted occupant is significantly more likely to be seriously injured or killed than a properly belted occupant.
- Avoid high speeds when cornering or turning.
- Do not make quick steering wheel movements, such as sharp lane changes or fast, sharp turns.
- The risk of rollover is greatly increased if you lose control of your vehicle at highway speeds.
- Loss of control often occurs if two or more wheels drop off the roadway and the driver over steers to reenter the roadway.

(Continued)

(Continued)

- In the event your vehicle leaves the roadway, do not steer sharply. Instead, slow down before pulling back into the travel lanes.
- **HYUNDAI** recommends you follow all posted speed limits.

## BRAKING SYSTEM

### Power brakes

Your vehicle has power-assisted brakes that adjust automatically through normal usage.

If the engine is not running or is turned off while driving, the power assist for the brakes will not work. You can still stop your vehicle by applying greater force to the brake pedal than typical. The stopping distance, however, will be longer than with power brakes.

When the engine is not running, the reserve brake power is partially depleted each time the brake pedal is applied. Do not pump the brake pedal when the power assist has been interrupted.

Pump the brake pedal only when necessary to maintain steering control on slippery surfaces.

### WARNING

Take the following precautions:

- Do not drive with your foot resting on the brake pedal. This will create abnormal high brake temperatures, excessive brake lining and pad wear, and increased stopping distances.
- When descending a long or steep hill, shift to a lower gear and avoid continuous application of the brakes. Applying the brakes continuously will cause the brakes to overheat and could result in a temporary loss of braking performance.

(Continued)

(Continued)

- Wet brakes may impair the vehicle's ability to safely slow down; the vehicle may also pull to one side when the brakes are applied. Applying the brakes lightly will indicate whether they have been affected in this way. Always test your brakes in this fashion after driving through deep water. To dry the brakes, lightly tap the brake pedal to heat up the brakes while maintaining a safe forward speed until brake performance returns to normal. Avoid driving at high speeds until the brakes function correctly.

## Disc brakes wear indicator

When your brake pads are worn and new pads are required, you will hear a high pitched warning sound from your front or rear brakes. You may hear this sound come and go or it may occur whenever you depress the brake pedal.

Please remember some driving conditions or climates may cause a brake squeal when you first apply (or lightly apply) the brakes. This is normal and does not indicate a problem with your brakes.

### NOTICE

**To avoid costly brake repairs, do not continue to drive with worn brake pads.**

### **i** Information

Always replace brake pads as complete front or rear axle sets.

## Parking brake (if equipped)

### *Applying the parking brake*

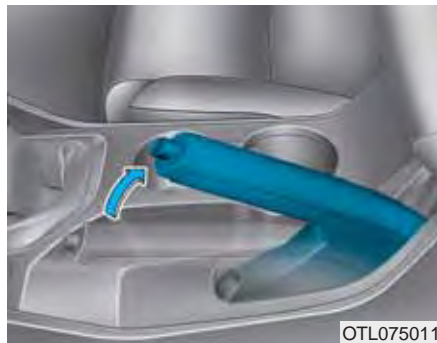

### Hand type

Always set the parking brake before leaving the vehicle, to apply:

Firmly depress the brake pedal.

Pull up the parking brake lever as far as possible.



### Foot type

To engage the parking brake, first apply the foot brake and then depress the parking brake pedal down as far as possible.

### **⚠** WARNING

**To reduce the risk of SERIOUS INJURY or DEATH, do not operate the parking brake while the vehicle is moving except in an emergency situation. It could damage the brake system and lead to an accident.**

## Releasing the parking brake

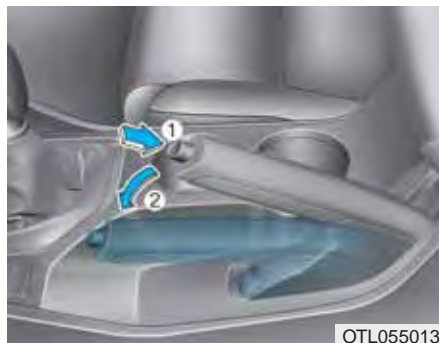

### Hand type

To release:

Firmly depress the brake pedal.

Slightly pull up the parking brake lever.

While pressing the release button (1), lower the parking brake (2).



### Foot type

To release:

Firmly depress the brake pedal.

Depress the parking brake pedal down and it will release automatically.

If the parking brake does not release or does not release all the way, we recommend that the system be checked by an authorized HYUNDAI dealer.

## WARNING

- Whenever leaving the vehicle or parking, always come to a complete stop and continue to depress the brake pedal. Move the shift lever into the 1<sup>st</sup> gear (for manual transaxle vehicle) or P (Park, for automatic transaxle/dual clutch transmission vehicle) position, then apply the parking brake, and place the ignition switch in the LOCK/OFF position.  
Vehicles with the parking brake not fully engaged are at risk for moving inadvertently and causing injury to yourself or others.
- NEVER allow anyone who is unfamiliar with the vehicle to touch the parking brake. If the parking brake is released unintentionally, serious injury may occur.
- Only release the parking brake when you are seated inside the vehicle with your foot firmly on the brake pedal.

## NOTICE

- Do not apply the accelerator pedal while the parking brake is engaged. If you depress the accelerator pedal with the parking brake engaged, warning will sound. Damage to the parking brake may occur.
- Driving with the parking brake on can overheat the braking system and cause premature wear or damage to brake parts. Make sure the parking brake is released and the Brake Warning Light is off before driving.



Check the Parking Brake Warning Light by placing the ignition switch to the ON position (do not start the engine).

This light will be illuminated when the parking brake is applied with the ignition switch in the START or ON position.

Before driving, be sure the parking brake is released and the Brake Warning Light is OFF.

If the Parking Brake Warning Light remains on after the parking brake is released while engine is running, there may be a malfunction in the brake system. Immediate attention is necessary.

If at all possible, cease driving the vehicle immediately. If that is not possible, use extreme caution while operating the vehicle and only continue to drive the vehicle until you can reach a safe location.

### Electronic Parking Brake (EPB) (if equipped)

#### Applying the parking brake



#### To apply the EPB (Electronic Parking Brake):

1. Depress the brake pedal.
2. Pull up the EPB switch.

Make sure the Parking Brake Warning Light comes on.

Also, the EPB is applied automatically if the [AUTO HOLD] switch is on when the engine is turned off. However, if you press the EPB switch within one second after the engine is turned off, the EPB will not be applied.

#### WARNING

To reduce the risk of **SERIOUS INJURY** or **DEATH**, do not operate the EPB while the vehicle is moving except in an emergency situation. It could damage the brake system and lead to an accident.

#### Releasing the parking brake



To release the EPB (Electronic Parking Brake), press the EPB switch in the following condition:

- Place the Engine Start/Stop button in the ON position.
- Depress the brake pedal.

Make sure the Parking Brake Warning Light goes off.

### To release EPB (Electronic Parking Brake) automatically:

- Shift lever in P (Park)

With the engine running depress the brake pedal and shift out of P (Park) to R (Rear) or D (Drive).

- Shift lever in N (Neutral)

With the engine running depress the brake pedal and shift out of N (Neutral) to R (Rear) or D (Drive).

- Automatic transaxle/Dual clutch transmission vehicle

1. Start the engine.
2. Fasten the driver's seat belt.
3. Close the driver's door, engine hood and tailgate.
4. Depress the accelerator pedal while the shift lever is in R (Rear), D (Drive) or Sports mode.

Make sure the Parking Brake Warning light goes off.

### **i** Information

- For your safety, you can engage the EPB even though the Engine Stop/Start button is in the OFF position, but you cannot release it.
- For your safety, depress the brake pedal and release the parking brake manually with the EPB switch when you drive downhill or when backing up the vehicle.

### **NOTICE**

- If the parking brake warning light is still on even though the EPB has been released, we recommend that the system be checked by an authorized HYUNDAI dealer.
- Do not drive your vehicle with the EPB applied. It may cause excessive brake pad and brake rotor wear.

### When the EPB (Electronic Parking Brake) does not release:

We recommend that you contact an authorized HYUNDAI dealer by loading the vehicle on a flatbed tow truck and have the system checked.

### EPB (Electronic Parking Brake) may be automatically applied when:

- The EPB is overheated
- It is requested by other systems
- The engine is turned off with the EPB applied

### **i** Information

If the driver turns the engine off while Auto Hold is operating, EPB will be automatically applied. However, if you press the EPB switch within one second after the engine is turned off, the EPB will not be applied.

### Warning messages

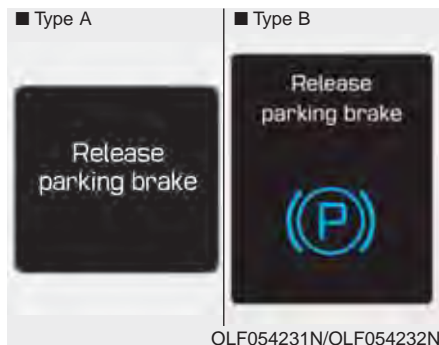

#### Release parking brake

- When you try to drive with the EPB applied, a warning will sound and a message will appear.
- If the driver's seat belt is unfastened and the engine hood or tailgate is opened, a warning will sound and a message will appear.
- When there is a problem with the vehicle, a warning may sound and a message may appear.

If the situation occurs, depress the brake pedal and release EPB by pressing the EPB switch.

### WARNING

- Whenever leaving the vehicle or parking, always come to a complete stop and continue to depress the brake pedal.

Move the shift lever into the P (Park) position, press the EPB switch, and press the Engine Start/Stop button to the OFF position. Take the Smart Key with you when exiting the vehicle.

Vehicles not fully engaged in P (Park) with the parking brake set are at risk for moving inadvertently and causing injury to yourself or others.

- NEVER allow anyone who is unfamiliar with the vehicle to touch the EPB switch. If the EPB is released unintentionally, serious injury may occur.
- Only release the EPB when you are seated inside the vehicle with your foot firmly on the brake pedal.

### NOTICE

- Do not apply the accelerator pedal while the parking brake is engaged. If you depress the accelerator pedal with the EPB engaged, a warning will sound and a message will appear. Damage to the parking brake may occur.
- Driving with the parking brake on can overheat the braking system and cause premature wear or damage to brake parts. Make sure the EPB is released and the Parking Brake Warning Light is off before driving.



## **i** Information

- A clicking sound may be heard while operating or releasing the EPB. These conditions are normal and indicate that the EPB is functioning properly.
- When leaving your keys with a parking attendant or assistant, make sure to inform him/her how to operate the EPB.



### **AUTO HOLD deactivating. Press brake pedal**

When the conversion from Auto Hold to EPB is not working properly a warning will sound and a message will appear.



### **Parking brake automatically locked**

If the EPB is applied while Auto Hold is activated, a warning will sound and a message will appear.

### **EPB malfunction indicator (if equipped)**



If the EPB malfunction indicator remains on, comes on while driving, or does not come on when the Engine Start/Stop button is changed to the ON position, this indicates that the EPB may have malfunctioned.

If this occurs, we recommend that the system be checked by an authorized HYUNDAI dealer.

The EPB malfunction indicator may illuminate when the ESC indicator comes on to indicate that the ESC is not working properly, but it does not indicate a malfunction of the EPB.

### **NOTICE**

- If the EPB warning light is still on, we recommend that the system be checked by an authorized HYUNDAI dealer.
- If the parking brake warning light does not illuminate or blinks even though the EPB switch was pulled up, the EPB may not be applied.
- If the parking brake warning light blinks when the EPB warning light is on, press the switch, and then pull it up. Repeat this one more time. If the EPB warning does not go off, we recommend that the system be checked by an authorized HYUNDAI dealer.

### **Emergency braking**

If there is a problem with the brake pedal while driving, emergency braking is possible by pulling up and holding the EPB switch. Braking is possible only while you are holding the EPB switch.

### **WARNING**

Do not operate the parking brake while the vehicle is moving except in an emergency situation. It could damage the brake system and lead to a severe accident.

### **i Information**

During emergency braking, the parking brake warning light will illuminate to indicate that the system is operating.

## NOTICE

If you continuously notice a noise or burning smell when the EPB is used for emergency braking, we recommend that the system be checked by an authorized HYUNDAI dealer.

### When the EPB (Electronic Parking Brake) does not release

If the EPB does not release normally, we recommend that you contact an authorized HYUNDAI dealer by loading the vehicle on a flatbed tow truck and have the system checked.

## AUTO HOLD (if equipped)

This feature keeps the brake applied when the shift lever is in D (Drive), R (Reverse), N (Neutral) or Sports Mode with the feature enabled and when the brake pedal has been depressed to stop the vehicle.

### To apply :



1. With the driver's door, engine hood and tailgate closed, fasten the driver's seat belt or depress the brake pedal and then press the [AUTO HOLD] switch. The white AUTO HOLD indicator will come on and the system will be in the standby position.



2. When you stop the vehicle completely by depressing the brake pedal, the AUTO HOLD indicator changes from white to green.
3. The vehicle will remain stationary even if you release the brake pedal.
4. If EPB is applied, Auto Hold will be released.

### To release :

If you press the accelerator pedal with the shift lever in R (Reverse), D (Drive) or sports mode, the Auto Hold will be released automatically and the vehicle will start to move. The indicator changes from green to white.

### WARNING

**When the AUTO HOLD is automatically released by depressing the accelerator pedal, always take a look around your vehicle.**  
**Slowly depress the accelerator pedal for a smooth start.**

### To cancel :



1. Depress the brake pedal.
  2. Press the [AUTO HOLD] switch.
- The AUTO HOLD indicator will turn off.

## WARNING

To prevent, unexpected and sudden vehicle movement, ALWAYS press your foot on the brake pedal to cancel the Auto Hold before you:

- Drive downhill.
- Drive the vehicle in R (Reverse).
- Park the vehicle.

## Information

- The Auto Hold does not operate when:
  - The driver's seat belt is unfastened and driver's door is opened
  - The engine hood is opened
  - The tailgate is opened
  - The shift lever is in P (Park)
  - The EPB is applied
- For your safety, the Auto Hold automatically switches to EPB when:
  - The driver's seat belt is unfastened and driver's door is opened
  - The engine hood is opened with the shift lever is in D (Drive)
  - The tailgate is opened with the shift lever is in R (Reverse)
  - The vehicle stops for more than 10 minutes
  - The vehicle stands on a steep slope
  - The vehicle moves several times

(Continued)

(Continued)

In these cases, the brake warning light comes on, the AUTO HOLD indicator changes from green to white, and a warning sound and a message will appear to inform you that EPB has been automatically engaged. Before driving off again, press foot brake pedal, check the surrounding area near your vehicle and release parking brake manually with the EPB switch.

- If the AUTO HOLD indicator changes to yellow, the Auto Hold is not working properly. We recommend that you contact an authorized HYUNDAI dealer.
- While operating Auto Hold, you may hear mechanical noise. However, it is normal operating noise.

**⚠ WARNING**

- Press the accelerator pedal slowly when you start the vehicle.
- For your safety, cancel the Auto Hold when you drive downhill, back up the vehicle or park the vehicle.

**NOTICE**

If there is a malfunction with the driver's door, engine hood or trunk open detection system, the Auto Hold may not work properly.

We recommend that you contact an authorized HYUNDAI dealer.

**Warning messages**

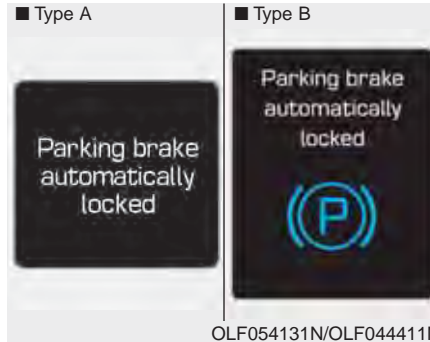

**Parking brake automatically locked**

When the EPB is applied from Auto Hold, a warning will sound and a message will appear.



**AUTO HOLD deactivating.  
Press brake pedal**

When the conversion from Auto Hold to EPB is not working properly a warning will sound and a message will appear.

**NOTICE**

When this message is displayed, the Auto Hold and EPB may not operate. For your safety, depress the brake pedal.

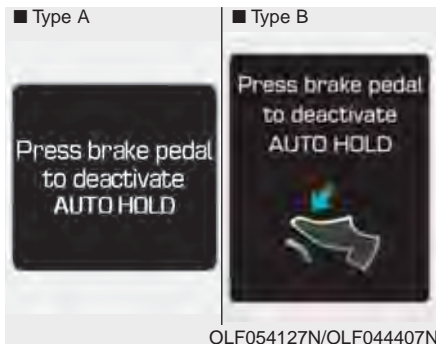

### Press brake pedal to deactivate AUTO HOLD

If you did not apply the brake pedal when you release the Auto Hold by pressing the [AUTO HOLD] switch, a warning will sound and a message will appear.



### AUTO HOLD conditions not met. Close door, hood, trunk, and fasten seatbelt

When you press the [AUTO HOLD] switch, if the driver's door, engine hood and tailgate are not closed or the driver's seat belt is unfastened, a warning will sound and a message will appear on the LCD display. At this moment, press the [AUTO HOLD] button after closing the driver's door, engine hood and tailgate and fastening the seat belt.

## Anti-lock Brake System (ABS)

### WARNING

An Anti-Lock Braking System (ABS) or an Electronic Stability Control (ESC) system will not prevent accidents due to improper or dangerous driving maneuvers. Even though vehicle control is improved during emergency braking, always maintain a safe distance between you and objects ahead of you. Vehicle speeds should always be reduced during extreme road conditions. The braking distance for cars equipped with ABS or ESC may be longer than for those without these systems in the following road conditions.

- Drive your vehicle at reduced speeds during the following conditions:
- Rough, gravel or snow-covered roads.

(Continued)

(Continued)

- On roads where the road surface is pitted or has different surface height.
- Tire chains are installed on your vehicle.

**The safety features of an ABS or ESC equipped vehicle should not be tested by high speed driving or cornering. This could endanger the safety of yourself or others.**

ABS is an electronic braking system that helps prevent a braking skid. ABS allows the driver to steer and brake at the same time.

### **Using ABS**

To obtain the maximum benefit from your ABS in an emergency situation, do not attempt to modulate your brake pressure and do not try to pump your brakes. Depress your brake pedal as hard as possible.

When you apply your brakes under conditions which may lock the wheels, you may hear sounds from the brakes, or feel a corresponding sensation in the brake pedal. This is normal and it means your ABS is active.

ABS does not reduce the time or distance it takes to stop the vehicle.

Always maintain a safe distance from the vehicle in front of you.

ABS will not prevent a skid that results from sudden changes in direction, such as trying to take a corner too fast or making a sudden lane change. Always drive at a safe speed for the road and weather conditions.

ABS cannot prevent a loss of stability. Always steer moderately when braking hard. Severe or sharp steering wheel movement can still cause your vehicle to veer into oncoming traffic or off the road.

On loose or uneven road surfaces, operation of the anti-lock brake system may result in a longer stopping distance than for vehicles equipped with a conventional brake system.

The ABS warning light () will stay on for several seconds after the Engine Start/Stop button is in the ON position. During that time, the ABS will go through self-diagnosis and the light will go off if everything is normal. If the light stays on, you may have a problem with your ABS. We recommend that you contact an authorized HYUNDAI dealer as soon as possible.



## ⚠ WARNING

If the ABS warning light (Ⓜ<sub>ABS</sub>) is on and stays on, you may have a problem with the ABS. Your power brakes will work normally. To reduce the risk of serious injury or death, we recommend that you contact your HYUNDAI dealer as soon as possible.

## NOTICE

When you drive on a road having poor traction, such as an icy road, and apply your brakes continuously, the ABS will be active continuously and the ABS warning light (Ⓜ<sub>ABS</sub>) may illuminate. Pull your car over to a safe place and turn the engine off.

Restart the engine. If the ABS warning light is off, then your ABS system is normal.

Otherwise, you may have a problem with your ABS system. We recommend that you contact an authorized HYUNDAI dealer as soon as possible.

## **i** Information

When you jump start your vehicle because of a drained battery, the ABS warning light (Ⓜ<sub>ABS</sub>) may turn on at the same time. This happens because of the low battery voltage. It does not mean your ABS is malfunctioning. Have the battery recharged before driving the vehicle.

## Electronic Stability Control (ESC) (if equipped)



The Electronic Stability Control (ESC) system helps to stabilize the vehicle during cornering maneuvers.

ESC checks where you are steering and where the vehicle is actually going. ESC applies braking pressure to any one of the vehicle's brakes and intervenes in the engine management system to assist the driver with keeping the vehicle on the intended path. It is not a substitute for safe driving practices. Always adjust your speed and driving to the road conditions.

### **WARNING**

**Never drive too fast for the road conditions or too quickly when cornering. The ESC system will not prevent accidents.**

**Excessive speed in turns, abrupt maneuvers, and hydroplaning on wet surfaces can result in severe accidents.**

### **ESC operation**

#### **ESC ON condition**

When the ignition switch is in the ON position, the ESC and the ESC OFF indicator lights illuminate for approximately three seconds and goes off, then the ESC is turned on.

### **When operating**



When the ESC is in operation, the ESC indicator light blinks:

- When you apply your brakes under conditions which may lock the wheels, you may hear sounds from the brakes, or feel a corresponding sensation in the brake pedal. This is normal and it means your ESC is active.
- When the ESC activates, the engine may not respond to the accelerator as it does under routine conditions.
- If the Cruise Control was in use when the ESC activates, the Cruise Control automatically disengages. The Cruise Control can be reengaged when the road conditions allow. **See "Cruise Control System" later in this chapter.** (if equipped)
- When moving out of the mud or driving on a slippery road, the engine rpm (revolutions per minute) may not increase even if you press the accelerator pedal deeply. This is to maintain the stability and traction of the vehicle and does not indicate a problem.

## ESC OFF condition



To cancel ESC operation :

### • State 1



Press the ESC OFF button shortly (ESC OFF indicator light and message illuminates). At this state, the engine control function does not operate. The traction control function does not operate but only the brake control function operates.

### • State 2



Press the ESC OFF button for more than 3 seconds. ESC OFF indicator light and message illuminates and ESC OFF warning chime will sound. At this state, the engine control function and brake control function does not operate. The vehicle stability control function does not operate any more.

If the ignition switch is placed to the LOCK/OFF position when ESC is off, ESC remains off. Upon restarting the engine, the ESC will automatically turn on again.

## Indicator lights

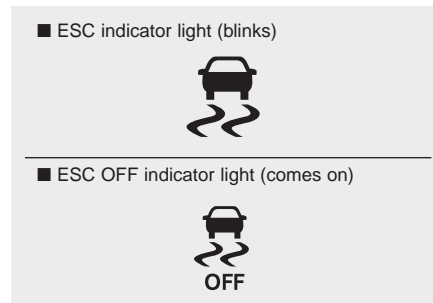

When the ignition switch is pressed to the ON position, the ESC indicator light illuminates, then goes off if the ESC system is operating normally.

The ESC indicator light blinks whenever the ESC is operating.

If ESC indicator light stays on, your vehicle may have a malfunction with the ESC system. When this warning light illuminates we recommend that the vehicle be checked by an authorized HYUNDAI dealer as soon as possible.

The ESC OFF indicator light comes on when the ESC is turned off with the button.

### WARNING

When the ESC is blinking, this indicates the ESC is active:

Drive slowly and NEVER attempt to accelerate. NEVER turn the ESC off while the ESC indicator light is blinking or you may lose control of the vehicle resulting in an accident.

### NOTICE

Driving with tires or wheels in various sizes may fail the normal operation of the ESC system. Before replacing tires, make sure they are in the same size as others. Never drive the vehicle, which is installed with the tires of different diameters.

### *ESC OFF usage*

#### When Driving

The ESC OFF mode should only be used briefly to help free the vehicle if stuck in snow or mud by temporarily stopping operation of the ESC to maintain wheel torque.

To turn ESC off while driving, press the ESC OFF button while driving on a flat road surface.

### NOTICE

To prevent damage to the transaxle:

- Do not allow wheel(s) of one axle to spin excessively while the ESC, ABS, and parking brake warning lights are displayed. The repairs would not be covered by the vehicle warranty. Reduce engine power and do not spin the wheel(s) excessively while these lights are displayed.
- When operating the vehicle on a dynamometer, make sure the ESC is turned off (ESC OFF light illuminated).

### Information

Turning the ESC off does not affect ABS or standard brake system operation.

## Vehicle Stability Management (VSM) (if equipped)

Vehicle Stability Management (VSM) helps ensure the vehicle stays stable when accelerating or braking suddenly on wet, slippery and rough roads where traction over the four tires can suddenly become uneven.

### WARNING

Take the following precautions when using the Vehicle Stability Management (VSM):

- **ALWAYS** check the speed and the distance to the vehicle ahead. The VSM is not a substitute for safe driving practices.
- **Never** drive too fast for the road conditions. The VSM system will not prevent accidents. Excessive speed in bad weather, slippery and uneven roads can result in severe accidents.

## VSM operation

### VSM ON condition

The VSM operates when:

- The Electronic Stability Control (ESC) is on.
- Vehicle speed is approximately above 15 km/h (9 mph) on curve roads.
- Vehicle speed is approximately above 20 km/h (12 mph) when the vehicle is braking on rough roads.

### When operating

When you apply your brakes under conditions which may activate the ESC, you may hear sounds from the brakes, or feel a corresponding sensation in the brake pedal. This is normal and it means your VSM is active.

## Information

The VSM does not operate when:



- **Driving on bank road such as gradient or incline**
- **Driving rearward.**
- **ESC OFF indicator light is on.**
- **EPS (Electronic Power Steering) warning light (  ) is on.**

### VSM OFF condition

To cancel VSM operation, press the ESC OFF button. ESC OFF indicator light (  ) will illuminate.

To turn on VSM, press the ESC OFF button again. The ESC OFF indicator light will go out.

#### WARNING

If ESC indicator light (  ) or EPS warning light (  ) stays on, your vehicle may have a malfunction with the VSM system. When the warning light illuminates we recommend that the vehicle be checked by an authorized HYUNDAI dealer as soon as possible.

#### NOTICE

Driving with varying tire or wheel sizes may cause the ESC system to malfunction. When replacing tires, make sure they are the same size as your original tires for this vehicle.

### Hill-Start Assist Control (HAC) (if equipped)

A vehicle has the tendency to slide backwards on a steep slope, before depressing the accelerator after a stop. The HAC prevents the vehicle from sliding backwards by automatically operating the brake systems for about 2 seconds. The brake systems are automatically released, when the accelerator pedal is depressed.

#### WARNING

The HAC is activated only for about 2 seconds, so always depress the accelerator pedal to begin driving upwards after a stop.

#### Information

- The HAC does not operate when the shift lever is in P (Park) or N (Neutral)
- The HAC activates even when the ESC (Electronic Stability Control) is off. However, it does not activate, when the ESC does not normally operate.

## Downhill Brake Control (DBC) (if equipped)



The Downhill Brake Control (DBC) supports the driver come down a steep hill without depressing the brake pedal.

It slows down the vehicle under 8 km/h (5mph) (for automatic transaxle/dual clutch transmission) or 8 km/h (5 mph) (for manual transaxle vehicles) and lets the driver concentrate on steering the vehicle.





### WARNING

Always turn off the DBC on normal roads. The DBC might activate inadvertently from the standby mode when driving through speed bumps or making sharp curves.

### NOTICE

- The DBC defaults to the OFF position whenever the ignition switch is placed in the ON position.
- Noise or vibration may occur from the brakes when the DBC is activated.
- The rear stop light comes on when DBC is activated.

**DBC operation**

Mode	Indicator light	Description
Standby	 illuminated	Press the DBC button when vehicle speed is under 40km/h (25mph). The DBC system will turn ON and enter the standby mode. The system does not turn ON if vehicle speed is over 40km/h (25mph).
Activated	 blinks	In the standby mode, if vehicle speed is under 35km/h (22mph) while driving down a steep hill, the DBC will activate automatically.
Temporarily deactivated	 illuminated	In the activated mode, the DBC will temporarily deactivate under the following conditions: <ul style="list-style-type: none"> <li>• The hill is not steep enough.</li> <li>• The brake pedal or accelerator pedal is depressed.</li> </ul> If the above conditions are gone, the DBC will automatically activate again.
OFF	 not illuminated	The DBC will turn OFF under the following conditions: <ul style="list-style-type: none"> <li>• The DBC button is pressed again.</li> <li>• Vehicle speed is over 60km/h (38mph).</li> </ul>

 **WARNING**

**If the DBC red indicator light illuminates, the system may have overheated or have malfunctioned. When the warning light illuminates even though the DBC system has cooled off, we recommend that the vehicle be checked by an authorized HYUNDAI dealer as soon as possible.**



## NOTICE

- The DBC may not deactivate on steep inclines even though the brake or accelerator pedal is depressed.
- Do not turn on the DBC when driving with shift lever in 3<sup>rd</sup> gear (and above) for vehicles with manual transaxle. The engine may stop if the DBC system is activated.
- The DBC does not operate when:
  - The shift lever is in P (Park).
  - The ESC is activated.

## Good braking practices

### WARNING

Whenever leaving the vehicle or parking, always come to a complete stop and continue to depress the brake pedal. Move the shift lever into the P (Park) position, then apply the parking brake, and place the Engine Start/Stop button in the OFF position.

Vehicles with the parking brake not fully engaged are at risk for moving inadvertently and causing injury to yourself or others.

Wet brakes can be dangerous! The brakes may get wet if the vehicle is driven through standing water or if it is washed. Your vehicle will not stop as quickly if the brakes are wet. Wet brakes may cause the vehicle to pull to one side.

To dry the brakes, apply the brakes lightly until the braking action returns to normal, taking care to keep the vehicle under control at all times. If the braking action does not return to normal, stop as soon as it is safe to do so and we recommend that you call an authorized HYUNDAI dealer for assistance.

DO NOT drive with your foot resting on the brake pedal. Even light, but constant pedal pressure can result in the brakes overheating, brake wear, and possibly even brake failure.

If a tire goes flat while you are driving, apply the brakes gently and keep the vehicle pointed straight ahead while you slow down. When you are moving slowly enough for it to be safe to do so, pull off the road and stop in a safe location.

Keep your foot firmly on the brake pedal when the vehicle is stopped to prevent the vehicle from rolling forward.

## FOUR WHEEL DRIVE (4WD) (IF EQUIPPED)

The Four Wheel Drive (4WD) System delivers engine power to all front and rear wheels for maximum traction. 4WD is useful when extra traction is required on roads such as slippery, muddy, wet, or snow-covered roads.

Occasional off-road use such as established unpaved roads and trails are OK. It is always important that the driver carefully reduces the speed to a level that does not exceed the safe operating speed for those conditions.

### WARNING

To reduce the risk of **SERIOUS INJURY** or **DEATH**:





- Do not drive in conditions that exceed the vehicles intended design such as challenging off-road conditions.
- Avoid high speeds when cornering or turning.
- Do not make quick steering wheel movements, such as sharp lane changes or fast, sharp turns.
- The risk of a rollover is greatly increased if you lose control of your vehicle at highway speeds.
- Loss of control often occurs if two or more wheels drop off the roadway and the driver oversteers to reenter the roadway.
- In the event your vehicle leaves the roadway, do not steer sharply. Instead, slow down before pulling back into the travel lanes.

### NOTICE



- Do not drive in water if the level is higher than the bottom of the vehicle.
- Check your brake condition once you are out of mud or water. Depress the brake pedal several times as you move slowly until you feel normal braking return.
- Shorten your scheduled maintenance interval if you drive in off-road conditions such as sand, mud or water (see "Maintenance Under Severe Usage Conditions" in chapter 7).
- Always wash your vehicle thoroughly after off road use, especially the bottom of the vehicle.
- Be sure to equip the vehicle with four tires of the same size and type.
- Make sure that a full time 4WD vehicle is towed by a flat bed tow truck.

## 4WD operation

### Four Wheel Drive (4WD) mode selection

Transfer mode	Selection button	Indicator light	Description
<b>4WD AUTO</b> (4WD LOCK is deactivated)		 (not illuminated)	<p>In the 4WD AUTO mode, under normal operating conditions, the vehicle operates similar to conventional 2WD vehicles. If the system determines there is a need for four wheel drive, the engine's driving power is distributed to all four wheels automatically.</p> <p>Use this mode when driving on normal roads.</p>
<b>4WD LOCK</b>		 (illuminated)	<p>In the 4WD LOCK mode, the system is deactivated when vehicle speed is over 30 km/h (19 mph) and the mode is shifted to 4WD AUTO mode. If the vehicle speed slows down to 30 km/h (19 mph), the mode shifts back to the 4WD LOCK mode.</p> <p>Use this mode when driving up or down steep inclines, driving off-road, driving on sandy and muddy roads, etc. to maximize traction</p>

### WARNING

If 4WD warning light (  ) stays on the instrument cluster, your vehicle may have a malfunction with the 4WD system. When the 4WD warning light (  ) illuminates we recommend that the vehicle be checked by an authorized HYUNDAI dealer as soon as possible.



### CAUTION

When driving on normal roads, deactivate the 4WD LOCK mode by pushing the 4WD LOCK button (4WD LOCK indicator light goes off). Driving on normal roads with the 4WD LOCK mode, especially, when cornering may cause mechanical noise or vibration. The noise and vibration will disappear when the 4WD LOCK mode is deactivated. Prolong driving with the noise and vibration may damage some parts of the power train.

### NOTICE

When the 4WD LOCK mode is deactivated, a sensation may be felt as the driving power is delivered entirely to the front wheels.

### *For safe 4WD operation*

#### **Before driving**

- Make sure all passengers are wearing seat belts.
- Sit upright and closer to the steering wheel than usual. Adjust the steering wheel to a position comfortable for you to drive.

### **Driving on snow-covered or icy roads**

- Start off slowly by applying the accelerator pedal gently.
- Use snow tires or tire chains.
- Keep sufficient distance between your vehicle and the vehicle in front of you.
- Use engine braking during deceleration.
- Avoid speeding, rapid acceleration, sudden brake applications, and sharp turns to prevent skids.

### Driving in sand or mud

- Maintain slow and constant speed.
- Use tire chains driving in mud if necessary.
- Keep sufficient distance between your vehicle and the vehicle in front of you.
- Reduce vehicle speed and always check the road condition.
- Avoid speeding, rapid acceleration, sudden brake applications, and sharp turns to prevent getting stuck.



### CAUTION

When the vehicle is stuck in snow, sand or mud, place a non-slip material under the drive wheels to provide traction OR Slowly spin the wheels in forward and reverse directions which causes a rocking motion that may free the vehicle. However, avoid running the engine continuously at high rpm, doing so may damage the 4WD system.

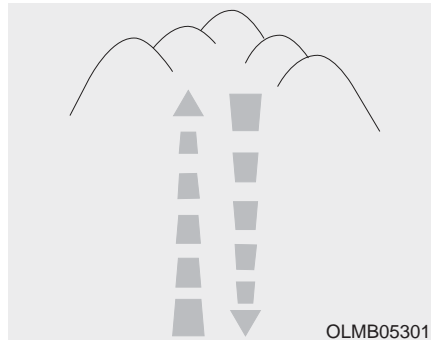

### Driving up or down hills

- Driving uphill
  - Before starting off, check if it is possible to drive uphill.
  - Drive as straight as possible.
- Driving downhill
  - Do not change gear while driving downhill. Select gear before driving downhill.
  - Drive as slowly using engine braking while driving downhill.
  - Drive straight as possible.



### WARNING

Exercise extreme caution driving up or down steep hills. The vehicle may flip depending on the grade, terrain and water/ mud conditions.



### WARNING

Do not drive across the contour of steep hills. A slight change in the wheel angle can destabilize the vehicle, or a stable vehicle may lose stability if the vehicle stops its forward motion. Your vehicle may roll over and lead to a serious injury or death.

### Driving through water

- Try to avoid driving in deep standing water. It may stall your engine and clog your exhaust pipes.
- If you need to drive in water, stop your vehicle, set the vehicle in 4WD LOCK mode and drive under 8 km/h (5mph).
- Do not change gear while driving in water.



### CAUTION

Always drive slowly in water. If you drive too fast, water may get into the engine compartment and wet the ignition system causing your vehicle to suddenly stop.

### Additional driving conditions

- Become familiar with the off-road conditions before driving.
- Always pay attention when driving off-road and avoid dangerous areas.
- Drive slowly when driving in heavy wind.
- Reduce vehicle speed when cornering. The center of gravity of 4WD vehicles is higher than conventional 2WD vehicles, making them more likely to roll over when you rapidly turn corners.



OTLE055003

- Always hold the steering wheel firmly when you are driving off-road.

#### **WARNING**

Do not grab the inside of the steering wheel when you are driving off-road. You may hurt your arm by a sudden steering maneuver or from steering wheel rebound due to an impact with objects on the ground. You could lose control of the steering wheel which may lead to serious injury or death.

## Emergency precautions

### *Tires*

Do not use tire and wheel with different size and type from the one originally installed on your vehicle. It can affect the safety and performance of your vehicle, which could lead to steering failure or rollover causing serious injury.

When replacing the tires, be sure to equip all four tires with the tire and wheel of the same size, type, tread, brand and load-carrying capacity. If you equip your vehicle with any tire/wheel combination not recommended by HYUNDAI for off-road driving, you should not use these tires for highway driving.

#### **WARNING**

Never start or run the engine while a full-time 4WD vehicle is raised on a jack. The vehicle can slip or roll off a jack causing serious injury or death to you or those nearby.

### *Towing*

4WD vehicles must be towed with a wheel lift and dollies or flatbed equipment with all the wheels off the ground. For more information, refer to "Towing" in chapter 6.

### *Dynamometer testing*

A full-time 4WD vehicle must be tested on a special four wheel chassis dynamometer.



A full-time 4WD vehicle should not be tested on a 2WD roll tester. If a 2WD roll tester must be used, perform the following procedure:

1. Check the tire pressures recommended for your vehicle.
2. Place the front wheels on the roll tester for a speedometer test as shown in the illustration.
3. Release the parking brake.
4. Place the rear wheels on the temporary free roller as shown in the illustration.

### CAUTION

- Never engage the parking brake while performing the test.
- When the vehicle is lifted up, do not operate the front and rear wheel separately. All four wheels should be operated.

### WARNING

**Keep away from the front of the vehicle while the vehicle is in gear on the dynamometer. The vehicle can jump forward and cause serious injury or death.**



## FLEX STEERING WHEEL (IF EQUIPPED)



The flex steering wheel controls the steering effort in accordance with the driver's preference and road conditions.

The driver can select a desired steering effort by pressing the steering mode button.

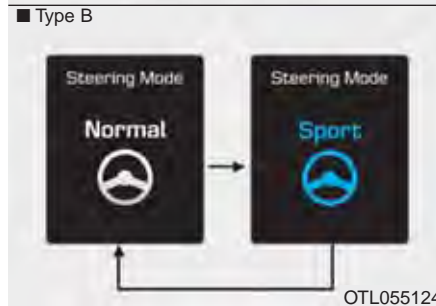
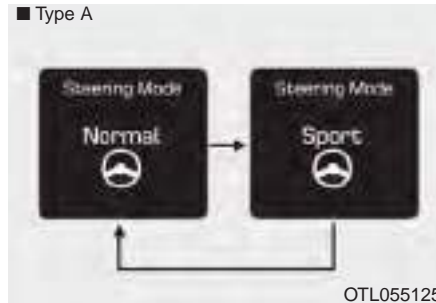

The steering mode options appear on the LCD display, when the driver presses the steering mode button.

Press the steering mode button within 4 seconds to scroll through the steering mode options.

If the steering mode button is not pressed within 4 seconds, the LCD display will change to the previous screen.

### Normal mode



The normal steering mode offers normal steering effort.

### Sport mode

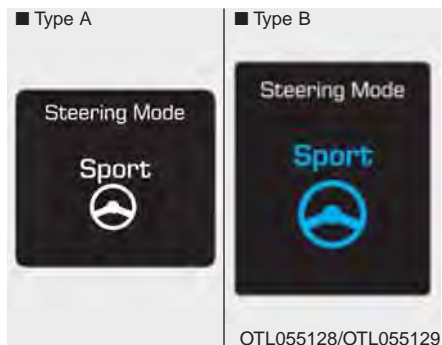

The sport steering mode offers high steering effort, making the wheel steering heavier. The sport steering mode is often used for driving on a highway.

### CAUTION

- When the driver presses the steering mode button while driving, it changes the steering mode option on the LCD display. However, it does not immediately change the steering effort for your safety. Upon completing the wheel steering, the steering tension is automatically set to the selected mode.
- Pay great caution while changing through modes, when the vehicle is in motion.
- The flex steering wheel does not operate, when the Electronic Power Steering (EPS) does not properly operate.

## DRIVE MODE INTEGRATED CONTROL SYSTEM (IF EQUIPPED)



The drive mode may be selected according to the driver's preference or road condition.

The system resets to be in the NORMAL mode (except for ECO mode), when the engine is restarted.

### **i** Information

If there is a problem with the instrument cluster, the drive mode will be in **NORMAL** mode and may not change to **ECO** mode or **SPORT** mode.

The mode changes, as below, whenever the **DRIVE MODE** button is pressed.

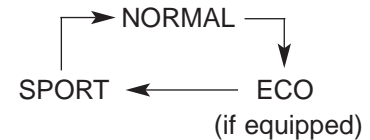

When **NORMAL** mode is selected, it is not displayed on the instrument cluster.

### *ECO mode (if equipped)*



The ECO mode is a guidance for fuel efficient driving.

- When the ECO mode is selected by pressing the DRIVE MODE button, the ECO indicator (green color) will illuminate.
- Restarting of the engine in the ECO mode resets the DRIVE mode to the ECO mode.

### **i** Information

**Fuel efficiency depends on the driver's driving habit and road condition.**

### **When the ECO mode is activated:**

- The acceleration response may be slightly reduced as the accelerator pedal is depressed moderately.
- The air conditioner performance may be limited.
- The shift pattern of the automatic transaxle or dual clutch transmission may change.
- The engine noise may get louder.

The above situations are normal conditions when the ECO mode is activated to improve fuel efficiency.

### **Limitation of the ECO mode operation:**

If the following conditions occur while the ECO mode is operating, the system operation is limited even though there is no change in the ECO indicator.

- When the coolant temperature is low:  
The system will be limited until engine performance becomes normal.
- When driving up a hill:  
The system will be limited to gain power when driving uphill because engine torque is restricted.
- When using the automatic transaxle or dual clutch transmission Sports mode:  
The system will be limited according to the shift location.
- When the accelerator pedal is deeply depressed for a few seconds: The system will be limited, judging that the driver wants to speed up.

## **SPORT mode**

The image shows a rectangular icon with the word "SPORT" in a bold, sans-serif font. The icon is white with a black border and is set against a light gray background.

SPORT mode manages the driving dynamics by automatically adjusting the steering wheel, engine and transaxle system.

- When the SPORT mode is selected by pressing the DRIVE MODE button, the SPORT indicator (yellow color) will illuminate.
- Restarting of the engine in the SPORT mode resets the DRIVE mode to the NORMAL mode. Thus, when necessary, reselect the SPORT mode.
- When the SPORT mode is activated:
  - The RPM (revolutions per minutes) level is maintained over a certain length of time, even after releasing the accelerator.
  - Up-shifting timing is delayed, while accelerating.

### ***i* Information**

**In the SPORT mode, the fuel efficiency may decrease.**

## BLIND SPOT DETECTION SYSTEM (BSD) (IF EQUIPPED)

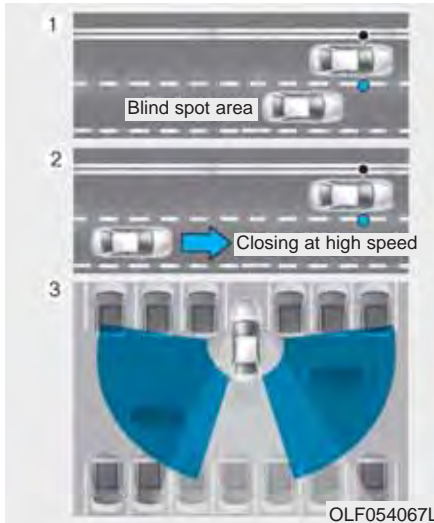

The Blind Spot Detection System (BSD) uses a radar sensor to alert the driver.

It monitors the rear area of the vehicle and provides information to the driver.

### (1) BSD (Blind Spot Detection)

The detection range varies in accordance with a driving speed. When your vehicle faster than the other vehicles, the system will not warn you.

### (2) LCA (Lane Change Assist)

When a vehicle approaches you at a high speed, the system will warn you.

### (3) RCTA (Rear Cross Traffic Alert)

When your vehicle moves backwards, and when the sensor detects the approaching vehicle in the left and right side, the system will warn you.

## WARNING

- Always check the road condition while driving for unexpected situations even though the Blind Spot Detection System (BSD) is operating.
- The Blind Spot Detection System (BSD) is a supplemental system to assist you. Do not entirely rely on the system. Always pay attention, while driving, for your safety.
- The Blind Spot Detection System (BSD) is not a substitute for proper and safe driving. Always drive safely and use caution when changing lanes or backing the vehicle up. The Blind Spot Detection System (BSD) may not detect every object alongside the vehicle.

## BSD (Blind Spot Detection) / LCA (Lane Change Assist) (if equipped)

### Operating conditions

■ Left-hand drive



■ Right-hand drive



To operate:

Press the BSD switch with the Ignition switch in the ON position.

The indicator illuminates on the switch. If vehicle speed exceeds 30 km/h (20 mph) the system will activate.

To cancel:

Press the BSD switch again. The indicator on the switch will go off.

When the system is not used, turn the system off by turning off the switch.

### **i** Information

- If the engine is turned off then on again, the BSD system returns to the previous state.
- When the system is turned on, the warning light will illuminate for 3 seconds on the outside rearview mirror.

### Warning type

The system will activate when:

1. The system is on.
2. The vehicle speed is above about 30 km/h (20 mph).
3. Vehicles behind are detected.

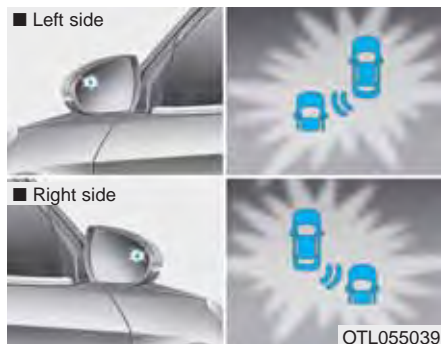

### First stage alert

If a vehicle is detected within the boundary of the system, a warning light will illuminate on the outside rearview mirror.

If the detected vehicle is not in warning range, the warning will turn off according to driving conditions.



### Second stage alert

The second stage alarm will activate when:

1. The first stage alert is on.
2. The turn signal light is on to change a lane.

When the second stage alert is activated, a warning light will blink on the outside rearview mirror and an alarm will sound.

If you turn off the turn signal light, the second stage alert will be deactivated.



### Detecting sensor



The sensors are located inside the rear bumper.

Always keep the rear bumper clean for proper operation of the system.

### Warning message

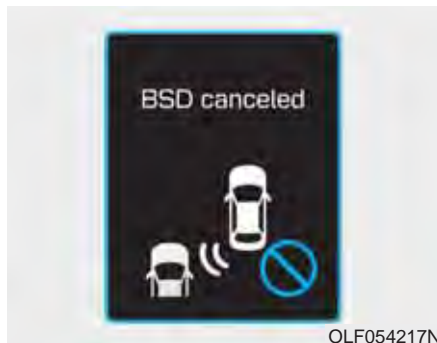

- This warning message may appear when :
  - There are foreign substances on the rear bumper
  - Driving in rural areas with little traffic or open terrains such as wide expanse of desert
  - There is heavy snow or rain

The light on the switch and the system will turn off automatically.

When the message is displayed due to a foreign substance, remove the foreign substance on the rear bumper. After the foreign substance is removed, if you drive for approximately 10 minutes, the system will work normally.

If the system does not operate normally after removing the substance or is not in a situation mentioned above, we recommend that you take your vehicle to an authorized HYUNDAI dealer and have the system checked.



If there is a problem with the BSD system, a warning message will appear and the light on the switch will turn off. The system will turn off automatically. We recommend that you have your vehicle inspected by an authorized HYUNDAI dealer.

### RCTA (Rear Cross Traffic Alert)

When your vehicle starts to move backwards after parking, the sensor detects any approaching vehicles from the left and right sides and warns the driver.

#### *Operating conditions*

To operate:

Go to the User Settings mode (Driving Assist) and select Rear Cross Traffic Alert on the LCD display (**For more details, refer to "LCD Display" in chapter 3.**). The system will turn on and standby to activate. The system will activate when vehicle speed is below 10 km/h (6.2 mph) with the shift lever in R (Reverse).

#### **i** Information

**The RCTA (Rear Cross Traffic Alert) detecting range is about 0.5m ~ 20m. A vehicle will be detected if the vehicle speed is 4km/h ~ 36km/h within the detecting range. However, the detecting range may change under different conditions. Always pay attention to the surroundings.**

## Warning type

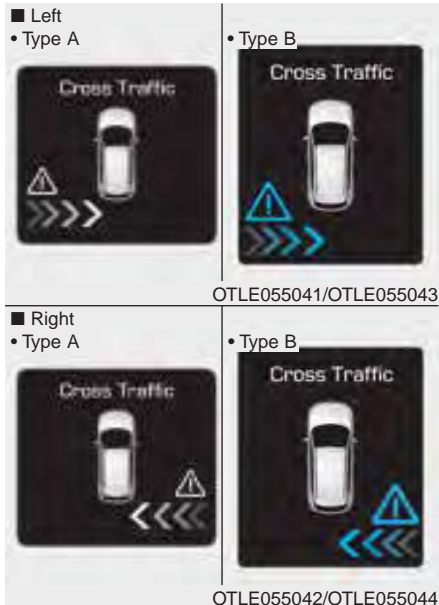

If the vehicle detected by the sensors approaches your vehicle, the warning chime will sound, the warning light on the outside rearview mirror will blink and a message will appear on the LCD display.

## **i** Information

- If the detected vehicle is out of the sensing range of your vehicle, move the vehicle away from the detected object slowly; the warning will be cancelled.
- The system may not operate properly due to other factors or circumstances. Always pay attention to your surrounding.
- If your vehicle's left or right side bumper is blinded by barrier or vehicles, the system sensing ability may be reduced.

## **⚠** WARNING

- The warning light on the outside rearview mirror will illuminate whenever a vehicle is detected at the rear side by the system.  
To avoid accidents, do not focus only on the warning light and neglect to see the surrounding of the vehicle.
- Drive safely even though the vehicle is equipped with a Blind Spot Detection System (BSD) and Rear Cross Traffic Alert (RCTA). Do not solely rely on the system but check your surrounding before changing lanes or backing the vehicle up.  
The system may not alert the driver in some conditions so always check the surroundings while driving.

(Continued)

(Continued)

- The Blind Spot Detection System (BSD) and Rear Cross Traffic Alert (RCTA) are not a substitute for proper and safe driving practices. Always drive safely and use caution when changing lanes or backing the vehicles up. The Blind Spot Detection System (BSD) may not detect every object alongside the vehicle.

### **NOTICE**

- The system may not properly operate, when the bumper is replaced, or when a repair work is done near the sensor.
- The sensing range differs according to the roads width. When the road is narrow, the system may detect other vehicles in the next lane.
- The system may turn off due to strong electromagnetic waves.

### ***Non-operating condition***

**Outside rearview mirror may not alert the driver when:**

- The outside rearview mirror housing is damaged or covered with debris.
- The window is covered with debris.
- The windows are severely tinted.

## DRIVER'S ATTENTION

The driver must be cautious in the below situations, because the system may not detect other vehicles or objects in certain circumstances.

- The vehicle drives on a curved road or through a tollgate.
- The sensor is polluted with rain, snow, mud, etc.
- The rear bumper, in which the sensor is located, is covered or blocked with a foreign matter such as a sticker, a bumper guard, a bicycle stand, etc.
- The rear bumper is damaged, or the sensor is out of the original default position.
- The vehicle height gets lower or higher due to heavy loading in a trunk, abnormal tire pressure, etc.
- The vehicle drives in a bad weather such as heavy rain or snow.

(Continued)

(Continued)

- There is a fixed object near the vehicle, such as a guardrail.
- A big vehicle is near such as a bus or truck.
- A motorcycle or bicycle is near.
- A flat trailer is near.
- If the vehicle has started at the same time as the vehicle next to you and has accelerated.
- When the other vehicle passes at a very fast speed.
- While changing lanes.
- While going down or up a steep road where the height of the lane is different.
- When the other vehicle approaches very close.
- When a trailer or carrier is installed.
- When the temperature near the rear bumper area is high or low.

(Continued)

(Continued)

- When the sensors are blocked by other vehicles, walls or parking-lot pillars.
- When the detected vehicle also moves back, as your vehicle drives back.
- If there are small things like shopping cart and baby carriage.
- If there is low height vehicle like sport vehicle.
- When other vehicles are close to your vehicle.
- When the vehicle in the next lane moves two lanes away from you OR when the vehicle two lanes away moves to the next lane from you.
- When driving on wet surface.

## CRUISE CONTROL (IF EQUIPPED)

### Cruise Control operation



1. CRUISE indicator
2. SET indicator

The Cruise Control system allows you to drive at speeds above 30 km/h (20 mph) without depressing the accelerator pedal.

#### WARNING

Take the following precautions:

- If the Cruise Control is left on, (CRUISE indicator light in the instrument cluster is illuminated) the Cruise Control can be activated unintentionally. Keep the Cruise Control system off (CRUISE indicator light OFF) when the Cruise Control is not in use, to avoid inadvertently setting a speed.
- Use the Cruise Control system only when traveling on open highways in good weather.

(Continued)

(Continued)

- Do not use the Cruise Control when it may be unsafe to keep the vehicle at a constant speed:
  - Driving in heavy or varying speed traffic.
  - On slippery (rainy, icy or snow covered) roads.
  - Hilly or winding roads.
  - Very windy areas.
  - Do not use cruise control when towing a trailer.

#### NOTICE

During cruise-speed driving of a manual transaxle vehicle, do not shift into neutral without depressing the clutch pedal, since the engine will be overrevved. If this happens, depress the clutch pedal or press the cruise control ON / OFF button.

## **i** Information

- During normal cruise control operation, when the SET switch is activated or reactivated after applying the brakes, the cruise control will energize after approximately 3 seconds. This delay is normal.
- To activate cruise control, depress the brake pedal at least once after turning the ignition switch to the ON position or starting the engine. This is to check if the brake switch which is important part to cancel cruise control is in normal condition.

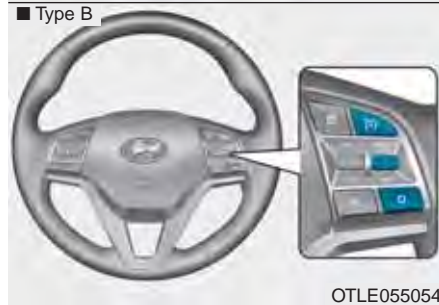

### Cruise control switch

CANCEL/O : Cancels cruise control operation.

CRUISE /  : Turns cruise control system on or off.

RES+: Resumes or increases cruise control speed.

SET-: Sets or decreases cruise control speed.

## *To set Cruise Control speed*



1. Press the CRUISE /  button on the steering wheel to turn the system on. The CRUISE indicator will illuminate.

- Accelerate to the desired speed, which must be more than 30 km/h (20 mph).

### **i** Information - Manual transaxle

For manual transaxle vehicles, you should depress the brake pedal at least once to set the cruise control after starting the engine.

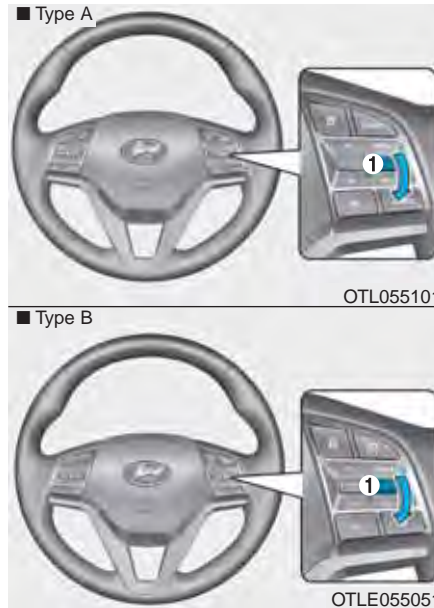

- Push the lever (1) down (SET -), and release it. The SET indicator light will illuminate.
- Release the accelerator pedal.

### **i** Information

On a steep slope, the vehicle may slightly slow down or speed up, while driving uphill or downhill.



### To increase Cruise Control speed

- Push the lever (1) up (RES+) and

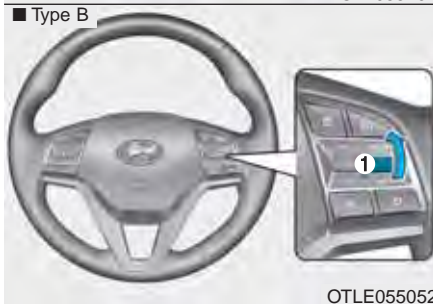

hold it, while monitoring the SET speed on the instrument cluster.

Release the lever when the desired speed is shown and the vehicle will accelerate to that speed.

- Push the lever (1) up (RES+) and release it immediately. The cruising speed will increase 2.0 km/h (1.2 mph) each time the lever is operated in this manner.
- Depress the accelerator pedal. When the vehicle attains the desired speed, push the lever (1) down (SET-).

### To decrease Cruise Control speed

- Push the lever (1) down (SET-) and

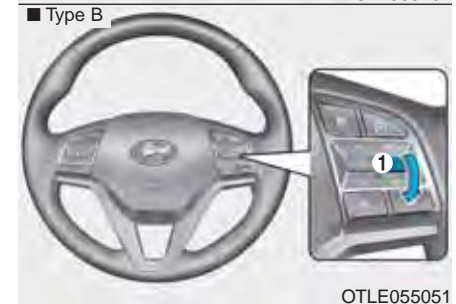

hold it. Your vehicle will gradually slow down. Release the lever at the speed you want to maintain.

- Push the lever (1) down (SET-) and release it immediately. The cruising speed will decrease 2.0 km/h (1.2 mph) each time the lever is operated in this manner.
- Lightly tap the brake pedal. When the vehicle attains the desired speed, push the lever (1) down (SET-).

### ***To temporarily accelerate with the Cruise Control ON***

Depress the accelerator pedal. When you take your foot off the accelerator, the vehicle will return to the previously set speed.

If you push the lever down (SET-) at the increased speed, the Cruise Control will maintain the increased speed.

### ***Cruise Control will be canceled when:***



- Depressing the brake pedal.
- Depressing the clutch pedal. (for manual transaxle vehicle)

- Pressing the CANCEL / O button located on the steering wheel.
- Pressing the CRUISE /  button. Both the CRUISE indicator and the SET indicator will turn OFF.
- Moving the shift lever into N (Neutral). (for automatic transaxle/ dual clutch transmission)
- Decreasing the vehicle speed lower than the speed by 20 km/h (12 mph).
- Decreasing the vehicle speed to less than approximately 30 km/h (20 mph).
- The ESC (Electronic Stability Control) is operating.
- Downshifting to the 2<sup>nd</sup> gear in Sports Mode.

### Information

Each of the above actions will cancel Cruise Control operation (the SET indicator light in the instrument cluster will go off), but only pressing the CRUISE button will turn the system off. If you wish to resume Cruise Control operation, push the lever up (RES+) located on your steering wheel. You will return to your previously preset speed, unless the system was turned off using the CRUISE button.

### To resume preset Cruising speed

Push the lever (1) up (RES+). If the

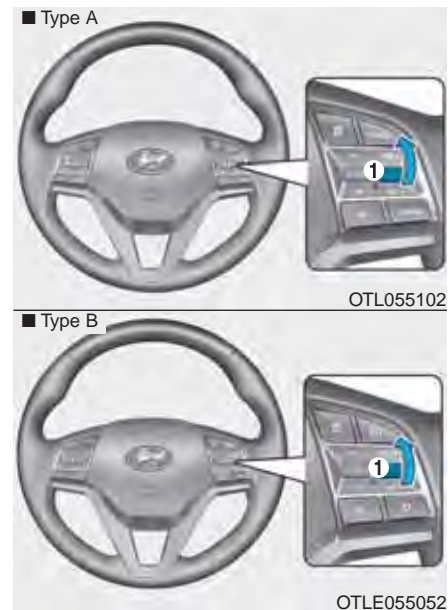

vehicle speed is over 30 km/h (20 mph), the vehicle will resume the preset speed.

### To turn Cruise Control off

#### ■ Type A



OTL055100

#### ■ Type B



OTLE055050

- Press the CRUISE /  button (the CRUISE indicator light will go off).
- Turn the engine OFF.

## SPECIAL DRIVING CONDITIONS

### Hazardous driving conditions

When hazardous driving elements are encountered such as water, snow, ice, mud and sand, take the bellow suggestions:

- Drive cautiously and keep a longer braking distance.
- Avoid abrupt braking or steering.
- When your vehicle is stuck in snow, mud, or sand, use the second gear. Accelerate slowly to avoid unnecessary wheel spinning.
- Put sand, rock salt, tire chains or other non-slip materials under the wheels to provide additional traction while being stuck in ice, snow, or mud.

#### WARNING

**Downshifting with an automatic transaxle while driving on slippery surfaces can cause an accident. The sudden change in tire speed could cause the tires to skid. Be careful when downshifting on slippery surfaces.**

### Rocking the vehicle

If it is necessary to rock the vehicle to free it from snow, sand, or mud, first turn the steering wheel right and left to clear the area around your front wheels. Then, shift back and forth between R (Reverse) and a forward gear.

Try to avoid spinning the wheels, and do not race the engine.

To prevent transaxle wear, wait until the wheels stop spinning before shifting gears. Release the accelerator pedal while shifting, and press lightly on the accelerator pedal while the transaxle is in gear. Slowly spinning the wheels in forward and reverse directions causes a rocking motion that may free the vehicle.

#### WARNING

**If the tires spin at high speed the tires can explode, and you or others may be injured. Do not attempt this procedure if people or objects are anywhere near the vehicle.**

**The vehicle can overheat causing an engine compartment fire or other damage. Spin the wheels as little as possible and avoid spinning the wheels at speeds over 56 km/h (35 mph) as indicated on the speedometer.**

### **i** Information

The ESC system (if equipped) must be turned OFF before rocking the vehicle.

### **NOTICE**

If you are still stuck after rocking the vehicle a few times, have the vehicle pulled out by a tow vehicle to avoid engine overheating, possible damage to the transaxle, and tire damage. See "Towing" in chapter 6.

### Smooth cornering

Avoid braking or gear changing in corners, especially when roads are wet. Ideally, corners should always be taken under gentle acceleration.

### Driving at night

Night driving presents more hazards than driving in the daylight. Here are some important tips to remember:

- Slow down and keep more distance between you and other vehicles, as it may be more difficult to see at night, especially in areas where there may not be any street lights.
- Adjust your mirrors to reduce the glare from other driver's headlamps.
- Keep your headlamps clean and properly aimed. Dirty or improperly aimed headlamps will make it much more difficult to see at night.
- Avoid staring directly at the headlamps of oncoming vehicles. You could be temporarily blinded, and it will take several seconds for your eyes to readjust to the darkness.

### Driving in the rain

Rain and wet roads can make driving dangerous. Here are a few things to consider when driving in the rain or on slick pavement:

- Slow down and allow extra following distance. A heavy rainfall makes it harder to see and increases the distance needed to stop your vehicle.
- Turn OFF your Cruise Control. (if equipped)
- Replace your windshield wiper blades when they show signs of streaking or missing areas on the windshield.
- Be sure your tires have enough tread. If your tires do not have enough tread, making a quick stop on wet pavement can cause a skid and possibly lead to an accident. **See "Tire Tread" in chapter 7.**
- Turn on your headlamps to make it easier for others to see you.
- Driving too fast through large puddles can affect your brakes. If you must go through puddles, try to drive through them slowly.

- If you believe your brakes may be wet, apply them lightly while driving until normal braking operation returns.

### ***Hydroplaning***

If the road is wet enough and you are going fast enough, your vehicle may have little or no contact with the road surface and actually ride on the water. The best advice is SLOW DOWN when the road is wet.

**The risk of hydroplaning increases as the depth of tire tread decreases, refer to "Tire Tread" in chapter 7.**

### **Driving in flooded areas**

Avoid driving through flooded areas unless you are sure the water is no higher than the bottom of the wheel hub. Drive through any water slowly. Allow adequate stopping distance because brake performance may be reduced.

After driving through water, dry the brakes by gently applying them several times while the vehicle is moving slowly.

### **Highway driving**

#### ***Tires***

Adjust the tire inflation, as specified. Under-inflation may overheat or damage the tires.

Do not install worn-out or damaged tires, which may reduce traction or fail the braking operation.

#### ***i* Information**

**Never over-inflate your tires above the maximum inflation pressure, as specified on your tires.**

#### ***Fuel, engine coolant and engine oil***

Driving at a high speed consumes more fuel than driving at a slow speed, such as in an urban area. Do not forget to check both the engine coolant and engine oil.

#### ***Drive belt***

A loose or damaged drive belt may overheat the engine.

### Reducing the risk of a rollover

Your multi-purpose passenger vehicle is defined as a Sports Utility Vehicle (SUV). SUV's have higher ground clearance and a narrower track to make them capable of performing in a wide variety of off-road applications. The specific design characteristics give them a higher center of gravity than ordinary vehicles making them more likely to roll over if you make abrupt turns. Utility vehicles have a significantly higher rollover rate than other types of vehicles. Due to this risk, driver and passengers are strongly recommended to buckle their seat belts. In a rollover crash, an unbelted person is significantly more likely to die than a person wearing a seat belt.

There are steps that a driver can make to reduce the risk of a rollover. If at all possible, avoid sharp turns or abrupt maneuvers, do not load your vehicle with heavy cargo on the roof, and never modify your vehicle in any way.

#### WARNING

**Utility vehicles have a significantly higher rollover rate than other types of vehicles. To prevent rollovers or loss of control:**

- Take corners at slower speeds than you would with a passenger vehicle.
- Avoid sharp turns and abrupt maneuvers.
- Do not modify your vehicle in any way that you would raise the center of gravity.
- Keep tires properly inflated.
- Do not carry heavy cargo on the roof.

#### WARNING

**In a rollover crash, an unbelted person is significantly more likely to die than a person wearing a seat belt. Make sure all passengers are wearing their seat belts.**



## WINTER DRIVING

The severe weather conditions of winter quickly wear out tires and cause other problems. To minimize winter driving problems, you should take the following suggestions:

### Snow or icy conditions

You need to keep sufficient distance between your vehicle and the vehicle in front of you.

Apply the brakes gently. Speeding, rapid acceleration, sudden brake applications, and sharp turns are potentially very hazardous practices. During deceleration, use engine braking to the fullest extent. Sudden brake applications on snowy or icy roads may cause skids to occur.

To drive your vehicle in deep snow, it may be necessary to use snow tires or to install tire chains on your tires.

Always carry emergency equipment. Some of the items you may want to carry include tire chains, tow straps or chains, a flashlight, emergency flares, sand, a shovel, jumper cables, a window scraper, gloves, ground cloth, coveralls, a blanket, etc.

### Snow tires

#### WARNING

**Snow tires should be equivalent in size and type to the vehicle's standard tires. Otherwise, the safety and handling of your vehicle may be adversely affected.**

If you mount snow tires on your vehicle, make sure to use radial tires of the same size and load range as the original tires. Mount snow tires on all four wheels to balance your vehicle's handling in all weather conditions. The traction provided by snow tires on dry roads may not be as high as your vehicle's original equipment tires. Check with the tire dealer for maximum speed recommendations.

#### Information

**Do not install studded tires without first checking local and municipal regulations for possible restrictions against their use.**

### Tire chains



Since the sidewalls of radial tires are thinner than other types of tires, they may be damaged by mounting some types of tire chains on them. Therefore, the use of snow tires is recommended instead of tire chains. Do not mount tire chains on vehicles equipped with aluminum wheels; if unavoidable use a wire type chain. If tire chains must be used, use genuine HYUNDAI parts and install the tire chain after reviewing the instructions provided with the tire chains. Damage to your vehicle caused by improper tire chain use is not covered by your vehicle manufacturer's warranty.

#### **WARNING**

The use of tire chains may adversely affect vehicle handling:

- Drive less than 30 km/h (20 mph) or the chain manufacturer's recommended speed limit, whichever is lower.
- Drive carefully and avoid bumps, holes, sharp turns, and other road hazards, which may cause the vehicle to bounce.
- Avoid sharp turns or locked wheel braking.

#### **Information**

- Install tire chains on the front tires. It should be noted that installing tire chains on the tires will provide a greater driving force, but will not prevent side skids.
- Do not install studded tires without first checking local and municipal regulations for possible restrictions against their use.

## Chain Installation

When installing tire chains, follow the manufacturer's instructions and mount them as tightly possible. Drive slowly (less than 30 km/h (20 mph)) with chains installed. If you hear the chains contacting the body or chassis, stop and tighten them. If they still make contact, slow down until the noise stops. Remove the tire chains as soon as you begin driving on cleared roads.

When mounting snow chains, park the vehicle on level ground away from traffic. Turn on the vehicle Hazard Warning Flasher and place a triangular emergency warning device behind the vehicle (if available). Always place the vehicle in P (Park), apply the parking brake and turn off the engine before installing snow chains.

## NOTICE

When using tire chains:

- **Wrong size chains or improperly installed chains can damage your vehicle's brake lines, suspension, body and wheels.**
- **Use SAE "S" class or wire chains.**
- **If you hear noise caused by chains contacting the body, retighten the chain to prevent contact with the vehicle body.**
- **To prevent body damage, retighten the chains after driving 0.5~1.0 km (0.3~0.6 miles).**
- **Do not use tire chains on vehicles equipped with aluminum wheels. If unavoidable, use a wire type chain.**
- **Use wire chains less than 15 mm (0.59 in) wide to prevent damage to the chain's connection.**

## Winter Precautions

### Use high quality ethylene glycol coolant

Your vehicle is delivered with high quality ethylene glycol coolant in the cooling system. It is the only type of coolant that should be used because it helps prevent corrosion in the cooling system, lubricates the water pump and prevents freezing. Be sure to replace or replenish your coolant in accordance with the maintenance schedule in section 7. Before winter, have your coolant tested to assure that its freezing point is sufficient for the temperatures anticipated during the winter.

### **Check battery and cables**

The winter temperature increases the battery consumption. **Inspect the battery and cables, as specified in the chapter 7.** The battery charging level can be checked by an authorized HYUNDAI dealer or in a service station.

### **Change to "winter weight" oil if necessary**

In some regions during winter, it is recommended to use the "winter weight" oil with lower viscosity. For further information, refer to the chapter 8. When you are not sure about a type of winter weight oil, consult an authorized HYUNDAI dealer.

### **Check spark plugs and ignition system**

**Inspect the spark plugs, as specified in the chapter 7.** If necessary, replace them. Also check all ignition wirings and components for any cracks, wear-out, and damage.

### **To prevent locks from freezing**

To prevent the locks from being frozen, spray approved de-icing fluid or glycerin into key holes. When a lock opening is already covered with ice, spray approved de-icing fluid over the ice to remove it. When an internal part of a lock freezes, try to thaw it with a heated key. Carefully use the heated key to avoid an injury.

### **Use approved window washer anti-freeze solution in system**

To prevent the window washer from being frozen, add authorized window washer anti-freeze solution, as specified on the window washer container. Window washer anti-freeze solution is available from an authorized HYUNDAI dealer, and so are the most vehicle accessory outlets. Do not use engine coolant or other types of anti-freeze solution to prevent any damage to the vehicle paint.

---

**Do not let your parking brake freeze**

Under some conditions your parking brake can freeze in the engaged position. This is most likely to happen when there is an accumulation of snow or ice around or near the rear brakes or if the brakes are wet. When there is the risk that your parking brake may freeze, temporarily apply it with the shift lever in P (Park). Also, block the rear wheels in advance, so the vehicle may not roll. Then, release the parking brake.

**Do not let ice and snow accumulate underneath**

Under some conditions, snow and ice can build up under the fenders and interfere with the steering. When driving in such conditions during the severe winter, you should check underneath the vehicle on a regular basis, so that moving the front wheels and the steering components is unblocked.

**Carry emergency equipment**

In accordance with weather conditions, you should carry appropriate emergency equipment, while driving. Some of the items you may want to carry include tire chains, tow straps or chains, flashlight, emergency flares, sand, shovel, jumper cables, window scraper, gloves, ground cloth, coveralls, blanket, etc.

**Do not place objects or materials in the engine compartment**

Putting objects or materials in the engine compartment may cause an engine failure or combustion, because those may block the engine cooling. Such damage will not be covered by the manufacturer's warranty.

### VEHICLE WEIGHT

Two labels on your driver's door sill show how much weight your vehicle was designed to carry: the Tire and Loading Information Label and the Certification Label.

Before loading your vehicle, familiarize yourself with the following terms for determining your vehicle's weight ratings, from the vehicle's specifications and the Certification Label:

#### Base Curb Weight

This is the weight of the vehicle including a full tank of fuel and all standard equipment. It does not include passengers, cargo, or optional equipment.

#### Vehicle Curb Weight

This is the weight of your new vehicle when you picked it up from your dealer plus any aftermarket equipment.

#### Cargo Weight

This figure includes all weight added to the Base Curb Weight, including cargo and optional equipment.

#### GAW (Gross Axle Weight)

This is the total weight placed on each axle (front and rear) - including vehicle curb weight and all payload.

#### GAWR (Gross Axle Weight Rating)

This is the maximum allowable weight that can be carried by a single axle (front or rear). These numbers are shown on the Certification Label. The total load on each axle must never exceed its GAWR.

#### GVW (Gross Vehicle Weight)

This is the Base Curb Weight plus actual Cargo Weight plus passengers.

#### GVWR (Gross Vehicle Weight Rating)

This is the maximum allowable weight of the fully loaded vehicle (including all options, equipment, passengers and cargo). The GVWR is shown on the Certification Label located on the driver's door sill.

### Overloading



#### WARNING

The Gross Axle Weight Rating (GAWR) and the Gross Vehicle Weight Rating (GVWR) for your vehicle are on the Certification Label attached to the driver's (or front passenger's) door. Exceeding these ratings can cause an accident or vehicle damage. You can calculate the weight of your load by weighing the items (and people) before putting them in the vehicle. Be careful not to overload your vehicle.

## What to do in an emergency

Hazard warning flasher .....	8-2	If you have a flat tire.....	8-17
In case of an emergency while driving .....	8-3	Jack and tools .....	8-17
If the engine stalls while driving .....	8-3	Changing tires .....	8-18
If the engine stalls at a crossroad or crossing .....	8-3	Jack label.....	8-23
If you have a flat tire while driving.....	8-3	EC Declaration of conformity for Jack.....	8-24
If the engine will not start .....	8-4	<b>Towing</b> .....	8-25
If the engine doesn't turn over or turns		Towing service .....	8-25
over slowly .....	8-4	Removable towing hook .....	8-26
If the engine turns over normally but doesn't		Emergency towing .....	8-27
start.....	8-4	<b>Emergency commodity</b> .....	8-29
Jump starting .....	8-5	Fire extinguisher .....	8-29
If the engine overheats .....	8-8	First aid kit.....	8-29
Tire pressure monitoring system (TPMS).....	8-10	Triangle reflector .....	8-29
Check tire pressure .....	8-10	Tire pressure gauge .....	8-29
Tire pressure monitoring system .....	8-11		
TPMS (Tire Pressure Monitoring System)			
malfunction indicator .....	8-13		
Changing a tire with TPMS.....	8-14		

## HAZARD WARNING FLASHER

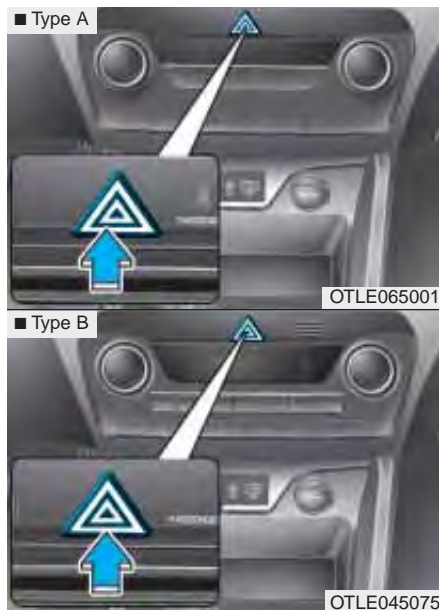

The hazard warning flasher serves as a warning to other drivers to exercise extreme caution when approaching, overtaking, or passing your vehicle.

It should be used whenever emergency repairs are being made or when the vehicle is stopped near the edge of a roadway.

To turn the hazard warning flasher on or off, press the hazard warning flasher button with the Engine Start/Stop button in any position. The button is located in the center fascia panel. All turn signal lights will flash simultaneously.

- The hazard warning flasher operates whether your vehicle is running or not.
- The turn signals do not work when the hazard flasher is on.



## IN CASE OF AN EMERGENCY WHILE DRIVING

### If the engine stalls while driving

- Reduce your speed gradually, keeping a straight line. Move cautiously off the road to a safe place.
- Turn on your hazard warning flasher.
- Try to start the engine again. If your vehicle will not start, we recommend that you contact an authorized HYUNDAI dealer.

### If the engine stalls at a crossroad or crossing

If the engine stalls at a crossroad or crossing, if safe to do so, move the shift lever to the N (Neutral) position and then push the vehicle to a safe location.

### If you have a flat tire while driving

If a tire goes flat while you are driving:

- Take your foot off the accelerator pedal and let the vehicle slow down while driving straight ahead. Do not apply the brakes immediately or attempt to pull off the road as this may cause loss of vehicle control resulting in an accident. When the vehicle has slowed to such a speed that it is safe to do so, brake carefully and pull off the road. Drive off the road as far as possible and park on firm, level ground. If you are on a divided highway, do not park in the median area between the two traffic lanes.

- When the vehicle is stopped, press the hazard warning flasher button, move the shift lever into P (Park, for automatic transaxle/dual clutch transmission vehicle) or neutral (for manual transaxle vehicle), apply the parking brake, and place the ignition switch in the LOCK/OFF position.
- Have all passengers get out of the vehicle. Be sure they all get out on the side of the vehicle that is away from traffic.
- When changing a flat tire, follow the instructions provided later in this chapter.

## IF THE ENGINE WILL NOT START

### If the engine doesn't turn over or turns over slowly

- Be sure the shift lever is in N or P (Neutral or Park, for automatic transaxle/dual clutch transmission vehicle) if it is an automatic transaxle vehicle. The engine starts only when the shift lever is in N (Neutral) or P (Park).
- Check the battery connections to be sure they are clean and tight.
- Turn on the interior light. If the light dims or goes out when you operate the starter, the battery is drained.

Do not push or pull the vehicle to start it. This could cause damage to your vehicle. See instructions for "Jump Starting" provided in this chapter.

### If the engine turns over normally but doesn't start

- Check the fuel level and add fuel if necessary.

If the engine still does not start, we recommend that you call an authorized HYUNDAI dealer for assistance.



### CAUTION

**Push or pull starting the vehicle may cause the catalytic converter to overload which can lead to damage to the emission control system.**

## JUMP STARTING

Jump starting can be dangerous if done incorrectly. Follow the jump starting procedure in this section to avoid serious injury or damage to your vehicle. If in doubt about how to properly jump start your vehicle, we strongly recommend that you have a service technician or towing service do it for you.

### WARNING

To prevent **SERIOUS INJURY** or **DEATH** to you or bystanders, always follow these precautions when working near or handling the battery:



Always read and follow instructions carefully when handling a battery.



Wear eye protection designed to protect the eyes from acid splashes.



Keep all flames, sparks, or smoking materials away from the battery.



Hydrogen is always present in battery cells, is highly combustible, and may explode if ignited.



Keep batteries out of reach of children.

(Continued)

(Continued)



Batteries contain sulfuric acid which is highly corrosive. Do not allow acid to contact your eyes, skin or clothing.

If acid gets into your eyes, flush your eyes with clean water for at least 15 minutes and get immediate medical attention. If acid gets on your skin, thoroughly wash the area. If you feel pain or a burning sensation, get medical attention immediately.

- When lifting a plastic-cased battery, excessive pressure on the case may cause battery acid to leak. Lift with a battery carrier or with your hands on opposite corners.
- Do not attempt to jump start your vehicle if your battery is frozen.

(Continued)

(Continued)

- NEVER attempt to recharge the battery when the vehicle's battery cables are connected to the battery.
- The electrical ignition system works with high voltage. NEVER touch these components with the engine running or when the Engine Start/Stop button is in the ON position.
- Do not allow the (+) and (-) jumper cables to touch. It may cause sparks.
- The battery may rupture or explode when you jump start with a low or frozen battery.

### NOTICE

To prevent damage to your vehicle:

- Only use a 12-volt power supply (battery or jumper system) to jump start your vehicle.
- Do not attempt to jump start your vehicle by push-starting.

### Information



Pb

An inappropriately disposed battery can be harmful to the environment and human health. Dispose the battery according to your local law(s) or regulations.

### *Jump starting procedure*

1. Position the vehicles close enough that the jumper cables will reach, but do not allow the vehicles to touch.
2. Avoid fans or any moving parts in the engine compartment at all times, even when the vehicles are turned off.
3. Turn off all electrical devices such as radios, lights, air conditioning, etc. Put the vehicles in P (Park, for automatic transaxle/dual clutch transmission vehicle) or neutral (for manual transaxle vehicle), and set the parking brakes. Turn both vehicles OFF.

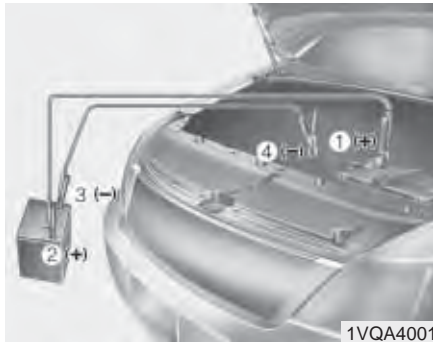

4. Connect the jumper cables in the exact sequence shown in the illustration. First connect one jumper cable to the red, positive (+) jumper terminal of your vehicle (1).
5. Connect the other end of the jumper cable to the red, positive (+) battery/jumper terminal of the assisting vehicle (2).
6. Connect the second jumper cable to the black, negative (-) battery/chassis ground of the assisting vehicle (3).

7. Connect the other end of the second jumper cable to the black, negative (-) chassis ground of your vehicle (4).

Do not allow the jumper cables to contact anything except the correct battery or jumper terminals or the correct ground. Do not lean over the battery when making connections.

8. Start the engine of the assisting vehicle and let it run at approximately 2,000 rpm for a few minutes. Then start your vehicle.

If your vehicle will not start after a few attempts, it probably requires servicing. In this event please seek qualified assistance. If the cause of your battery discharging is not apparent, have your vehicle checked by an authorized HYUNDAI dealer.

Disconnect the jumper cables in the exact reverse order you connected them:

1. Disconnect the jumper cable from the black, negative (-) chassis ground of your vehicle (4).
2. Disconnect the other end of the jumper cable from the black, negative (-) battery/chassis ground of the assisting vehicle (3).
3. Disconnect the second jumper cable from the red, positive (+) battery/jumper terminal of the assisting vehicle (2).
4. Disconnect the other end of the jumper cable from the red, positive (+) jumper terminal of your vehicle (1).

## IF THE ENGINE OVERHEATS



If your temperature gauge indicates overheating, you experience a loss of power, or hear loud pinging or knocking, the engine may be overheating. If this happens, you should:

1. Pull off the road and stop as soon as it is safe to do so.
2. Place the shift lever in P (Park, for automatic transaxle/dual clutch transmission vehicle) or neutral (for manual transaxle vehicle) and set the parking brake. If the air conditioning is ON, turn it OFF.

3. If engine coolant is running out under the vehicle or steam is coming out from the hood, stop the engine. Do not open the hood until the coolant has stopped running or the steaming has stopped. If there is no visible loss of engine coolant and no steam, leave the engine running and check to be sure the engine cooling fan is operating. If the fan is not running, turn the engine off.

**⚠ WARNING**

**While the engine is running, keep hands, clothing and tools away from the moving parts such as the cooling fan and drive belt to prevent serious injury.**

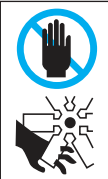

4. Check for coolant leaking from the radiator, hoses or under the vehicle. (If the air conditioning had been in use, it is normal for cold water to be draining from it when you stop.)
5. If engine coolant is leaking out, stop the engine immediately and we recommend that you call an authorized HYUNDAI dealer for assistance.

## ⚠ WARNING

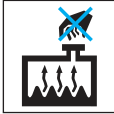

**NEVER** remove the radiator cap or the drain plug while the engine and radiator are hot. Hot coolant and

steam may blow out under pressure, causing serious injury.

Turn the engine off and wait until the engine cools down. Use extreme care when removing the radiator cap. Wrap a thick towel around it, and turn it counterclockwise slowly to the first stop. Step back while the pressure is released from the cooling system. When you are sure all the pressure has been released, press down on the cap, using a thick towel, and continue turning counterclockwise to remove it.

6. If you cannot find the cause of the overheating, wait until the engine temperature has returned to normal. Then, if coolant has been lost, carefully add coolant to the reservoir to bring the fluid level in the reservoir up to the halfway mark.
7. Proceed with caution, keeping alert for further signs of overheating. If overheating happens again, we recommend that you call an authorized HYUNDAI dealer for assistance.

## ⚠ CAUTION

- Serious loss of coolant indicates a leak in the cooling system and we recommend the system be checked by an authorized HYUNDAI dealer.
- When the engine overheats from low engine coolant, suddenly adding engine coolant may cause cracks in the engine. To prevent damage, add engine coolant slowly in small quantities.

## TIRE PRESSURE MONITORING SYSTEM (TPMS) (IF EQUIPPED)



- (1) Low Tire Pressure Telltale/  
TPMS Malfunction Indicator
- (2) Low tire pressure position telltale  
and tire pressure telltale  
(Shown on the LCD display)

### Check tire pressure

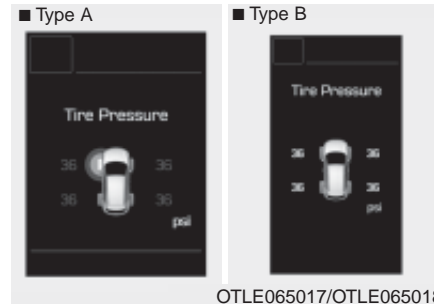

- You can check the tire pressure in the information mode on the cluster.  
**Refer to "User settings mode" in chapter 3.**
- Tire pressure is displayed 1~2 minutes later after driving.
- If tire pressure is not displayed when the vehicle is stopped, "Drive to display" message displays. After driving, check the tire pressure.

- You can change the tire pressure unit in the user settings mode on the cluster.
  - psi, kpa, bar (**Refer to "User settings mode" in chapter 3.**)



## Tire pressure monitoring system

Each tire, including the spare (if pro-

### WARNING

**Over-inflation or under-inflation can reduce tire life, adversely affect vehicle handling, and lead to sudden tire failure that may cause loss of vehicle control resulting in an accident.**

vided), should be checked monthly when cold and inflated to the inflation pressure recommended by the vehicle manufacturer on the vehicle placard or tire inflation pressure label. (If your vehicle has tires of a different size than the size indicated on the vehicle placard or tire inflation pressure label, you should determine the proper tire inflation pressure for those tires.)

As an added safety feature, your vehicle has been equipped with a tire pressure monitoring system (TPMS) that illuminates a low tire pressure telltale when one or more of your tires is significantly under-inflated. Accordingly, when the low tire pressure telltale illuminates, you should stop and check your tires as soon as possible, and inflate them to the proper pressure. Driving on a significantly under-inflated tire causes the tire to overheat and can lead to tire failure. Under-inflation also reduces fuel efficiency and tire tread life, and may affect the vehicle's handling and stopping ability.

Please note that the TPMS is not a substitute for proper tire maintenance, and it is the driver's responsibility to maintain correct tire pressure, even if under-inflation has not reached the level to trigger illumination of the TPMS low tire pressure telltale.

Your vehicle has also been equipped with a TPMS malfunction indicator to indicate when the system is not operating properly. The TPMS malfunction indicator is combined with the low tire pressure telltale. When the system detects a malfunction, the telltale will flash for approximately one minute and then remain continuously illuminated. This sequence will continue upon subsequent vehicle start-ups as long as the malfunction exists. When the malfunction indicator is illuminated, the system may not be able to detect or signal low tire pressure as intended.

TPMS malfunctions may occur for a variety of reasons, including the installation of replacement or alternate tires or wheels on the vehicle that prevent the TPMS from functioning properly. Always check the TPMS malfunction telltale after replacing one or more tires or wheels on your vehicle to ensure that the replacement or alternate tires and wheels allow the TPMS to continue to function properly.

### NOTICE

If any of the below happens, we recommend that the system be checked by an authorized HYUNDAI dealer.

1. The low tire pressure telltale/TPMS malfunction indicator does not illuminate for 3 seconds when Engine Start/Stop button is turned to the ON or engine is running.
2. The TPMS malfunction indicator remains illuminated after blinking for approximately 1 minute.
3. The Low tire pressure position telltale remains illuminated.



### Low tire pressure telltale

### Low tire pressure position telltale and tire pressure telltale



When the tire pressure monitoring system warning indicators are illuminated and warning message displayed on the cluster LCD display, one or more of your tires is significantly under-inflated. The low tire pressure position telltale light will indicate which tire is significantly under-inflated by illuminating the corresponding position light.

If either telltale illuminates, immediately reduce your speed, avoid hard cornering and anticipate increased stopping distances. You should stop and check your tires as soon as possible. Inflate the tires to the proper pressure as indicated on the vehicle's placard or tire inflation pressure label located on the driver's side center pillar outer panel. If you cannot reach a service station or if the tire cannot hold the newly added air, replace the low pressure tire with a spare tire.

If you drive the vehicle for about 10 minutes at speeds above 25 km/h after replacing the low pressure tire with the spare tire, the below will happen:

- The TPMS malfunction indicator may blink for approximately 1 minute and then remain continuously illuminated because the TPMS sensor is not mounted on the spare wheel.

**NOTICE**

The spare tire is not equipped with a tire pressure sensor.

 **CAUTION**

In winter or cold weather, the low tire pressure telltale may illuminate if the tire pressure was adjusted to the recommended tire inflation pressure in warm weather. It does not mean your TPMS is malfunctioning because the decreased temperature leads to a lowering of tire pressure.

When you drive your vehicle from a warm area to a cold area or from a cold area to a warm area, or the outside temperature is higher or lower, you should check the tire inflation pressure and adjust the tires to the recommended tire inflation pressure.

 **WARNING**

**Low pressure damage**

Significantly low tire pressure makes the vehicle unstable and can contribute to loss of vehicle control and increased braking distances.

Continued driving on low pressure tires can cause the tires to over-heat and fail.



**TPMS (Tire Pressure Monitoring System) malfunction indicator**

The TPMS malfunction indicator will illuminate after it blinks for approximately one minute when there is a problem with the Tire Pressure Monitoring System.

We recommend that the system be checked by an authorized HYUNDAI dealer.

**NOTICE**

If there is a malfunction with the TPMS, the low tire pressure position telltale will not be displayed even though the vehicle has an under-inflated tire.

### CAUTION

- The TPMS malfunction indicator may blink for approximately 1 minute and then remain continuously illuminated if the vehicle is moving around electric power supply cables or radios transmitter such as at police stations, government and public offices, broadcasting stations, military installations, airports, or transmitting towers, etc. This can interfere with normal operation of the Tire Pressure Monitoring System (TPMS).
- The TPMS malfunction indicator may blink for approximately 1 minute and then remain continuously illuminated if snow chains are used or some separate electronic devices such as notebook computer, mobile charger, remote starter or navigation etc., are used in the vehicle.

This can interfere with normal operation of the Tire Pressure Monitoring System (TPMS).

### Changing a tire with TPMS

If you have a flat tire, the low Tire Pressure and Position telltales will come on. We recommend that the system be checked by an authorized HYUNDAI dealer.

### CAUTION

**NEVER use a puncture-repairing agent to repair and/or inflate a low pressure tire. The tire sealant can damage the tire pressure sensor. If used, you will have to replace the tire pressure sensor.**

Each wheel is equipped with a tire pressure sensor mounted inside the tire behind the valve stem. You must use TPMS specific wheels. It is recommended that you have your tires serviced by an authorized HYUNDAI dealer.

If you drive the vehicle for about 10 minutes at speeds above 25 km/h after replacing the low pressure tire with the spare tire, the below will happen:

- The TPMS malfunction indicator may blink for approximately 1 minute and then remain continuously illuminated because the TPMS sensor is not mounted on the spare wheel.

You may not be able identify a low tire by simply looking at it. Always use a good quality tire pressure gauge to measure the tire's inflation pressure. Please note that a tire that is hot (from being driven) will have a higher pressure measurement than a tire that is cold (from sitting stationary for at least 3 hours and driven less than 1.6 km (1 mile) during that 3 hour period).

Allow the tire to cool before measuring the inflation pressure. Always be sure the tire is cold before inflating to the recommended pressure.

A cold tire means the vehicle has been sitting for 3 hours and driven for less than 1.6 km (1 mile) in that 3 hour period.

### WARNING

#### TPMS

- **The TPMS cannot alert you to severe and sudden tire damage caused by external factors such as nails or road debris.**
- **If you feel any vehicle instability, immediately take your foot off the accelerator, apply the brakes gradually and with light force, and slowly move to a safe position off the road.**

### WARNING

#### Protecting TPMS

**Tampering with, modifying, or disabling the Tire Pressure Monitoring System (TPMS) components may interfere with the system's ability to warn the driver of low tire pressure conditions and/or TPMS malfunctions. Tampering with, modifying, or disabling the Tire Pressure Monitoring System (TPMS) components may void the warranty for that portion of the vehicle.**

**⚠ WARNING**

**For EUROPE**

- Do not modify the vehicle; it may interfere with the TPMS function.
- The wheels on the market do not have a TPMS sensor.

For your safety, we recommend that you use parts for replacement from an authorized HYUNDAI dealer.

- If you use the wheels on the market, use a TPMS sensor approved by a HYUNDAI dealer. If your vehicle is not equipped with a TPMS sensor or TPMS does not work properly, you may fail the periodic vehicle inspection conducted in your country.

(Continued)

(Continued)

**\*All vehicles sold in the EUROPE market during below period must be equipped with TPMS.**

- New model vehicle :  
Nov. 1, 2012 ~
- Current model vehicle :  
Nov. 1, 2014~ (Based on vehicle registrations)

## IF YOU HAVE A FLAT TIRE

### WARNING

Changing a tire can be dangerous. Follow the instructions in this section when changing a tire to reduce the risk of serious injury or death.

### CAUTION

Be careful as you use the jack handle to stay clear of the flat end. The flat end has sharp edges that could cause cuts.

### Jack and tools



- (1) Jack handle
- (2) Jack
- (3) Wheel nut wrench

The jack, jack handle, and wheel nut wrench are stored in the luggage compartment under the luggage box cover.

The jack is provided for emergency tire changing only.



Turn the winged hold down bolt counterclockwise to remove the spare tire.

Store the spare tire in the same compartment by turning the winged hold down bolt clockwise.

To prevent the spare tire and tools from "rattling", store them in their proper location.



If it is hard to loosen the tire hold-down wing bolt by hand, you can loosen it easily using the jack handle.

1. Put the jack handle (1) inside of the tire hold-down wing bolt.
2. Turn the tire hold-down wing bolt counterclockwise with the jack handle.

### Changing tires

#### **WARNING**

A vehicle can slip or roll off of a jack causing serious injury or death to you or those nearby. Take the following safety precautions:

- Do not get under a vehicle that is supported by a jack.
- **NEVER** attempt to change a tire in the lane of traffic. **ALWAYS** move the vehicle completely off the road on level, firm ground away from traffic before trying to change a tire. If you cannot find a level, firm place off the road, call a towing service for assistance.
- Be sure to use the jack provided with the vehicle.

(Continued)

(Continued)

- **ALWAYS** place the jack on the designated jacking positions on the vehicle and **NEVER** on the bumpers or any other part of the vehicle for jacking support.
- Do not start or run the engine while the vehicle is on the jack.
- Do not allow anyone to remain in the vehicle while it is on the jack.
- Keep children away from the road and the vehicle.



Follow these steps to change your vehicle's tire:

1. Park on a level, firm surface.
2. Move the shift lever into P (Park, for automatic transaxle/dual clutch transmission vehicle) or neutral (for manual transaxle vehicle), apply the parking brake, and place the ignition switch in the LOCK/OFF position.
3. Press the hazard warning flasher button.
4. Remove the wheel lug nut wrench, jack, jack handle, and spare tire from the vehicle.



5. Block both the front and rear of the tire diagonally opposite of the tire you are changing.



6. Loosen the wheel lug nuts counterclockwise one turn each in the order shown above, but do not remove any lug nuts until the tire has been raised off of the ground.

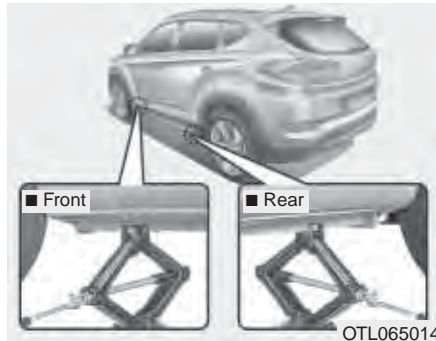

7. Place the jack at the designated jacking position under the frame closest to the tire you are changing. The jacking positions are plates welded to the frame with two notches and two dimples. Never jack any other position or part of the vehicle. It may damage to the side seal molding.



8. Insert the jack handle into the jack and turn it clockwise, raising the vehicle until the tire clears the ground. Make sure the vehicle is stable on the jack.

9. Loosen the lug nuts with the wheel lug nut wrench and remove them with your fingers. Remove the wheel from the studs and lay it flat on the ground out of the way. Remove any dirt or debris from the studs, mounting surfaces, and wheel.
10. Install the spare tire onto the studs of the hub.
11. Tighten the lug nuts with your fingers onto the studs with the smaller end of the lug nuts closest to the wheel.
12. Lower the vehicle to the ground by turning the jack handle counterclockwise.



OTL065007

13. Use the wheel lug nut wrench to tighten the lug nuts in the order shown. Double-check each lug nut until they are tight. After changing tires, we recommend that an authorized HYUNDAI dealer tighten the lug nuts to their proper torque as soon as possible. **The wheel lug nut should be tightened to 9~11 kgf·m (65~79 lbf·ft).**

If you have a tire gauge, check the tire pressure (see "Tires and Wheels" in chapter 8 for tire pressure instructions.). If the pressure is lower or higher than recommended, drive slowly to the nearest service station and adjust it to the recommended pressure. Always reinstall the valve cap after checking or adjusting tire pressure. If the cap is not replaced, air may leak from the tire. If you lose a valve cap, buy another and install it as soon as possible. After changing tires, secure the flat tire and return the jack and tools to their proper storage locations.

#### NOTICE

**Check the tire pressure as soon as possible after installing a spare tire. Adjust it to the recommended pressure.**

#### ⚠ CAUTION

**Your vehicle has metric threads on the studs and lug nuts. Make certain during tire changing that the same nuts that were removed are reinstalled. If you have to replace your lug nuts make sure they have metric threads to avoid damaging the studs and ensure the wheel is properly secured to the hub. We recommend that you consult an authorized HYUNDAI dealer for assistance.**

If any of the equipment such as the jack, lug nuts, studs, or other equipment is damaged or in poor condition, do not attempt to change the tire and call for assistance.

### ***Use of compact spare tires (if equipped)***

Compact spare tires are designed for emergency use only. Drive carefully on the compact spare tire and always follow the safety precautions.

#### **⚠ WARNING**

To prevent compact spare tire failure and loss of control possibly resulting in an accident:

- Use the compact spare tire only in an emergency.
- NEVER operate your vehicle over 80 km/h (50 mph).
- Do not exceed the vehicle's maximum load rating or the load carrying capacity shown on the sidewall of the compact spare tire.
- Do not use the compact spare tire continuously. Repair or replace the original tire as soon as possible to avoid failure of the compact spare tire.

When driving with the compact spare tire mounted to your vehicle:

- Check the tire pressure after installing the compact spare tire. The compact spare tire should be inflated to 420 kPa (60 psi).
- Do not take this vehicle through an automatic car wash while the compact spare tire is installed.
- Do not use the compact spare tire on any other vehicle because this tire has been designed especially for your vehicle.
- The compact spare tire's tread life is shorter than a regular tire. Inspect your compact spare tire regularly and replace worn compact spare tires with the same size and design, mounted on the same wheel.
- Do not use more than one compact spare tire at a time.
- Do not tow a trailer while the compact spare tire is installed.

#### **NOTICE**

**When the original tire and wheel are repaired and reinstalled on the vehicle, the lug nut torque must be set correctly. The correct lug nut tightening torque is 9-11 kgf-m (65-79 lbf-ft).**

## ⚠ CAUTION

To prevent damaging the compact spare tire and your vehicle:

- Drive slowly enough for the road conditions to avoid all hazards, such as a potholes or debris.
- Avoid driving over obstacles. The compact spare tire diameter is smaller than the diameter of a conventional tire and reduces the ground clearance approximately 25 mm (1 inch).
- Do not use tire chains on the compact spare tire. Because of the smaller size, a tire chain will not fit properly.
- Do not use the compact spare tire on any other wheels, nor should standard tires, snow tires, wheel covers or trim rings be used with the compact spare wheel.

## Jack label

### ■ Example

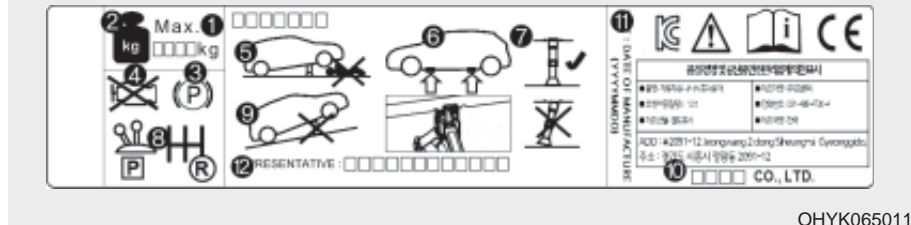

OHYK065011

The actual Jack label in the vehicle may differ from the illustration. For more detailed specifications, refer to the label attached to the jack.

1. Model Name
2. Maximum allowable load
3. When using the jack, set your parking brake.
4. When using the jack, stop the engine.
5. Do not get under a vehicle that is supported by a jack.
6. The designated locations under the frame
7. When supporting the vehicle, the base plate of jack must be vertical under the lifting point.
8. Shift into Reverse gear on vehicles with manual transaxle or move the shift lever to the P position on vehicles with automatic transaxle/dual clutch transmission.
9. The jack should be used on firm level ground.
10. Jack manufacture
11. Production date
12. Representative company and address

## EC Declaration of conformity for Jack

**CE**

**EC Declaration of Conformity**  
according to EC Machinery Directive 2006/42/EC

We, **FRONTEC CO., LTD.**  
2091-12 Jeongwang 20-dong Sheungui Gyonggi-do Korea  
declare under our sole responsibility that the product:

Product: **JACK-ASSY**  
Type Designation: **1200KG, 1000KG, 800KG, 700KG, 500KG**  
Serial No.: **NA (prototype)**  
Year of Manufacture: **2012**

To affirm this declaration makes it is conformity with the following provisions of cited harmonized standards:

EN ISO12100	Safety of machinery - General principles for design - HAS (ANSI/ISO 10218)
EN 18461	Modes of transport jacks and associated lifting equipment

I hereby the provisions of Directive 2006/42/EC: Declare on the approximation of the use of Article 6(1)(a) (1) machinery (14) (15) (16) (17) (18) (19) (20) (21) (22) (23) (24) (25) (26) (27) (28) (29) (30) (31) (32) (33) (34) (35) (36) (37) (38) (39) (40) (41) (42) (43) (44) (45) (46) (47) (48) (49) (50) (51) (52) (53) (54) (55) (56) (57) (58) (59) (60) (61) (62) (63) (64) (65) (66) (67) (68) (69) (70) (71) (72) (73) (74) (75) (76) (77) (78) (79) (80) (81) (82) (83) (84) (85) (86) (87) (88) (89) (90) (91) (92) (93) (94) (95) (96) (97) (98) (99) (100) (101) (102) (103) (104) (105) (106) (107) (108) (109) (110) (111) (112) (113) (114) (115) (116) (117) (118) (119) (120) (121) (122) (123) (124) (125) (126) (127) (128) (129) (130) (131) (132) (133) (134) (135) (136) (137) (138) (139) (140) (141) (142) (143) (144) (145) (146) (147) (148) (149) (150) (151) (152) (153) (154) (155) (156) (157) (158) (159) (160) (161) (162) (163) (164) (165) (166) (167) (168) (169) (170) (171) (172) (173) (174) (175) (176) (177) (178) (179) (180) (181) (182) (183) (184) (185) (186) (187) (188) (189) (190) (191) (192) (193) (194) (195) (196) (197) (198) (199) (200) (201) (202) (203) (204) (205) (206) (207) (208) (209) (210) (211) (212) (213) (214) (215) (216) (217) (218) (219) (220) (221) (222) (223) (224) (225) (226) (227) (228) (229) (230) (231) (232) (233) (234) (235) (236) (237) (238) (239) (240) (241) (242) (243) (244) (245) (246) (247) (248) (249) (250) (251) (252) (253) (254) (255) (256) (257) (258) (259) (260) (261) (262) (263) (264) (265) (266) (267) (268) (269) (270) (271) (272) (273) (274) (275) (276) (277) (278) (279) (280) (281) (282) (283) (284) (285) (286) (287) (288) (289) (290) (291) (292) (293) (294) (295) (296) (297) (298) (299) (300) (301) (302) (303) (304) (305) (306) (307) (308) (309) (310) (311) (312) (313) (314) (315) (316) (317) (318) (319) (320) (321) (322) (323) (324) (325) (326) (327) (328) (329) (330) (331) (332) (333) (334) (335) (336) (337) (338) (339) (340) (341) (342) (343) (344) (345) (346) (347) (348) (349) (350) (351) (352) (353) (354) (355) (356) (357) (358) (359) (360) (361) (362) (363) (364) (365) (366) (367) (368) (369) (370) (371) (372) (373) (374) (375) (376) (377) (378) (379) (380) (381) (382) (383) (384) (385) (386) (387) (388) (389) (390) (391) (392) (393) (394) (395) (396) (397) (398) (399) (400) (401) (402) (403) (404) (405) (406) (407) (408) (409) (410) (411) (412) (413) (414) (415) (416) (417) (418) (419) (420) (421) (422) (423) (424) (425) (426) (427) (428) (429) (430) (431) (432) (433) (434) (435) (436) (437) (438) (439) (440) (441) (442) (443) (444) (445) (446) (447) (448) (449) (450) (451) (452) (453) (454) (455) (456) (457) (458) (459) (460) (461) (462) (463) (464) (465) (466) (467) (468) (469) (470) (471) (472) (473) (474) (475) (476) (477) (478) (479) (480) (481) (482) (483) (484) (485) (486) (487) (488) (489) (490) (491) (492) (493) (494) (495) (496) (497) (498) (499) (500) (501) (502) (503) (504) (505) (506) (507) (508) (509) (510) (511) (512) (513) (514) (515) (516) (517) (518) (519) (520) (521) (522) (523) (524) (525) (526) (527) (528) (529) (530) (531) (532) (533) (534) (535) (536) (537) (538) (539) (540) (541) (542) (543) (544) (545) (546) (547) (548) (549) (550) (551) (552) (553) (554) (555) (556) (557) (558) (559) (560) (561) (562) (563) (564) (565) (566) (567) (568) (569) (570) (571) (572) (573) (574) (575) (576) (577) (578) (579) (580) (581) (582) (583) (584) (585) (586) (587) (588) (589) (590) (591) (592) (593) (594) (595) (596) (597) (598) (599) (600) (601) (602) (603) (604) (605) (606) (607) (608) (609) (610) (611) (612) (613) (614) (615) (616) (617) (618) (619) (620) (621) (622) (623) (624) (625) (626) (627) (628) (629) (630) (631) (632) (633) (634) (635) (636) (637) (638) (639) (640) (641) (642) (643) (644) (645) (646) (647) (648) (649) (650) (651) (652) (653) (654) (655) (656) (657) (658) (659) (660) (661) (662) (663) (664) (665) (666) (667) (668) (669) (670) (671) (672) (673) (674) (675) (676) (677) (678) (679) (680) (681) (682) (683) (684) (685) (686) (687) (688) (689) (690) (691) (692) (693) (694) (695) (696) (697) (698) (699) (700) (701) (702) (703) (704) (705) (706) (707) (708) (709) (710) (711) (712) (713) (714) (715) (716) (717) (718) (719) (720) (721) (722) (723) (724) (725) (726) (727) (728) (729) (730) (731) (732) (733) (734) (735) (736) (737) (738) (739) (740) (741) (742) (743) (744) (745) (746) (747) (748) (749) (750) (751) (752) (753) (754) (755) (756) (757) (758) (759) (760) (761) (762) (763) (764) (765) (766) (767) (768) (769) (770) (771) (772) (773) (774) (775) (776) (777) (778) (779) (780) (781) (782) (783) (784) (785) (786) (787) (788) (789) (790) (791) (792) (793) (794) (795) (796) (797) (798) (799) (800) (801) (802) (803) (804) (805) (806) (807) (808) (809) (810) (811) (812) (813) (814) (815) (816) (817) (818) (819) (820) (821) (822) (823) (824) (825) (826) (827) (828) (829) (830) (831) (832) (833) (834) (835) (836) (837) (838) (839) (840) (841) (842) (843) (844) (845) (846) (847) (848) (849) (850) (851) (852) (853) (854) (855) (856) (857) (858) (859) (860) (861) (862) (863) (864) (865) (866) (867) (868) (869) (870) (871) (872) (873) (874) (875) (876) (877) (878) (879) (880) (881) (882) (883) (884) (885) (886) (887) (888) (889) (890) (891) (892) (893) (894) (895) (896) (897) (898) (899) (900) (901) (902) (903) (904) (905) (906) (907) (908) (909) (910) (911) (912) (913) (914) (915) (916) (917) (918) (919) (920) (921) (922) (923) (924) (925) (926) (927) (928) (929) (930) (931) (932) (933) (934) (935) (936) (937) (938) (939) (940) (941) (942) (943) (944) (945) (946) (947) (948) (949) (950) (951) (952) (953) (954) (955) (956) (957) (958) (959) (960) (961) (962) (963) (964) (965) (966) (967) (968) (969) (970) (971) (972) (973) (974) (975) (976) (977) (978) (979) (980) (981) (982) (983) (984) (985) (986) (987) (988) (989) (990) (991) (992) (993) (994) (995) (996) (997) (998) (999) (1000)

Shungui Gyonggi-do, Korea, 15.07.2012, **SOJHONG, MIN**, President  
(Place date, date of issue, Name and signature or equivalent marking of authorized person)

TTCF (Issuing Location):  
Address: **WIDZERSKA 206, 750-20 WYDER MISTEK, CIELENOWICE, CZESKI REPUBLIC**  
Trade Name: **Jack**  
Company name: **HANNA LLC, CZESKI REPUBLIC**

JACKDOC14F

## TOWING

### Towing service

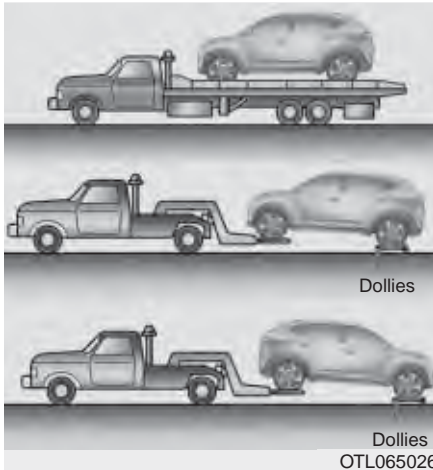

If emergency towing is necessary, we recommend having it done by an authorized HYUNDAI dealer or a commercial tow-truck service. Proper lifting and towing procedures are necessary to prevent damage to the vehicle. The use of wheel dollies or flatbed is recommended.

It is acceptable to tow the vehicle with the rear wheels on the ground (without dollies) and the front wheels off the ground.

If any of the loaded wheels or suspension components are damaged or the vehicle is being towed with the front wheels on the ground, use a towing dolly under the front wheels.

When being towed by a commercial tow truck and wheel dollies are not used, the front of the vehicle should always be lifted, not the rear.

For 4WD vehicles, it must be towed with a wheel lift and dollies or flatbed equipment with all the wheels off the ground.

**⚠ CAUTION**

**A 4WD vehicle should never be towed with the wheels on the ground. This can cause serious damage to the transaxle or the 4WD system.**



**⚠ CAUTION**

- Do not tow the vehicle with the front wheels on the ground as this may cause damage to the vehicle.
- Do not tow with sling-type equipment. Use wheel lift or flatbed equipment.



### **⚠ WARNING**

If your vehicle is equipped with a rollover sensor, place the ignition switch in the LOCK/OFF or ACC position when the vehicle is being towed. The side impact and curtain air bag may deploy if the sensor detects the situation as a rollover.

When towing your vehicle in an emergency without wheel dollies:

1. Place the ignition switch in the ACC position.
2. Place the shift lever in N (Neutral).
3. Release the parking brake.

### **⚠ CAUTION**

Failure to place the shift lever in N (Neutral) may cause internal damage to the transaxle.

## Removable towing hook

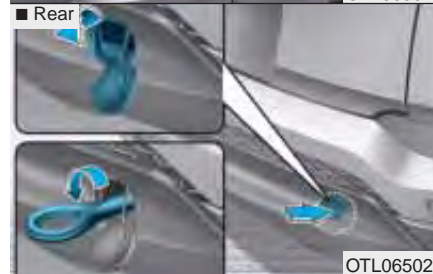

1. Open the tailgate, and remove the towing hook from the tool case.
2. Remove the hole cover pressing the lower part of the cover on the front bumper.
3. Install the towing hook by turning it clockwise into the hole until it is fully secured.
4. Remove the towing hook and install the cover after use.



## Emergency towing



If towing is necessary, we recommend you have it done by an authorized HYUNDAI dealer or a commercial tow truck service.

If towing service is not available in an emergency, your vehicle may be temporarily towed using a cable or chain secured to the emergency towing hook at the front (or rear) of the vehicle.

Use extreme caution when towing the vehicle with a cable or chain. A driver must be in the vehicle to steer it and operate the brakes.

Towing in this manner may be done only on hard-surfaced roads for a short distance and at low speeds. Also, the wheels, axles, power train, steering and brakes must all be in good condition.

Always follow these emergency towing precautions:

- Place the ignition switch in the ACC position so the steering wheel is not locked.
- Place the shift lever in N (Neutral).
- Release the parking brake.
- Depress the brake pedal with more force than normal since you will have reduced braking performance.
- More steering effort will be required because the power steering system will be disabled.
- Use a vehicle heavier than your own to tow your vehicle.
- The drivers of both vehicles should communicate with each other frequently.
- Before emergency towing, check that the hook is not broken or damaged.
- Fasten the towing cable or chain securely to the hook.
- Do not jerk the hook. Apply steady and even force.

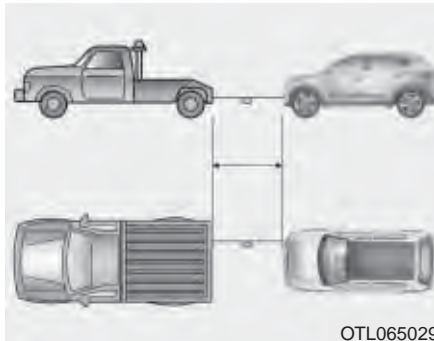

- Use a towing cable or chain less than 5 m (16 feet) long. Attach a white or red cloth (about 30 cm (12 inches) wide) in the middle of the cable or chain for easy visibility.
- Drive carefully so the towing cable or chain remains tight during towing.
- Before towing, check the automatic transaxle/dual clutch transmission for fluid leaks under your vehicle. If the automatic transaxle fluid is leaking, flatbed equipment or a towing dolly must be used.

### CAUTION

To avoid damage to your vehicle and vehicle components when towing:

- Always pull straight ahead when using the towing hooks. Do not pull from the side or at a vertical angle.
- Do not use the towing hooks to pull a vehicle out of mud, sand or other conditions from which the vehicle cannot be driven out under its own power.
- Limit the vehicle speed to 15 km/h (10 mph) and drive less than 1.5 km (1 mile) when towing to avoid serious damage to the automatic transaxle/ dual clutch transmission.

## EMERGENCY COMMODITY (IF EQUIPPED)

Your vehicle is equipped with emergency commodities to help you respond to emergency situation.

### Fire extinguisher

If there is small fire and you know how to use the fire extinguisher, follow these steps carefully.

1. Pull out the safety pin at the top of the extinguisher that keeps the handle from being accidentally pressed.
2. Aim the nozzle towards the base of the fire.
3. Stand approximately 2.5 m (8 ft) away from the fire and squeeze the handle to discharge the extinguisher. If you release the handle, the discharge will stop.
4. Sweep the nozzle back and forth at the base of the fire. After the fire appears to be out, watch carefully since it may re-ignite.

### First aid kit

Supplies for use in giving first aid such as scissors, bandage and adhesive tape, etc. are provided.

### Triangle reflector

Place the triangle reflector on the road to warn oncoming vehicles during emergencies, such as when the vehicle is parked by the roadside due to problems.

### Tire pressure gauge (if equipped)

Tires normally lose some air in day-to-day use, and you may have to add a air periodically and usually it is not a sign of a leaking tire, but of normal wear. Always check tire pressure when the tires are cold because tire pressure increases with temperature.

To check the tire pressure, take the following steps:

1. Unscrew the inflation valve cap that is located on the rim of the tire.
2. Press and hold the gauge against the tire valve. Some air will leak as you begin and more will leak if you don't press the gauge in firmly.
3. A firm non-leaking push will activate the gauge.
4. Read the tire pressure on the gauge to see whether the tire pressure is low or high.
5. Adjust the tire pressure to the specified pressure. Refer to "Tires and Wheels" in chapter 8.
6. Reinstall the inflation valve cap.

# Maintenance

<b>Engine compartment</b> .....	9-3	<b>Air cleaner</b> .....	9-39
<b>Maintenance services</b> .....	9-5	Filter replacement.....	9-39
Owner's responsibility .....	9-5	<b>Climate control air filter</b> .....	9-41
Owner maintenance precautions .....	9-5	Filter inspection.....	9-41
<b>Owner maintenance</b> .....	9-7	Filter replacement.....	9-41
Owner maintenance schedule.....	9-8	<b>Wiper blades</b> .....	9-42
<b>Scheduled maintenance services</b> .....	9-10	Blade inspection .....	9-42
<b>Explanation of scheduled maintenance items</b> ..	9-24	Blade replacement .....	9-42
<b>Engine oil</b> .....	9-28	<b>Battery</b> .....	9-45
Checking the engine oil level .....	9-28	For best battery service.....	9-45
Checking the engine oil and filter .....	9-29	Battery capacity label .....	9-47
<b>Engine coolant</b> .....	9-30	Battery recharging .....	9-47
Checking the coolant level .....	9-30	Reset items .....	9-48
Changing the coolant.....	9-33	<b>Tires and wheels</b> .....	9-49
<b>Brake/clutch fluid</b> .....	9-34	Tire care .....	9-49
Checking the brake/clutch fluid level.....	9-34	Recommended cold tire inflation pressures.....	9-49
<b>Washer fluid</b> .....	9-36	Checking tire inflation pressure .....	9-51
Checking the washer fluid level.....	9-36	Tire rotation .....	9-52
<b>Parking brake</b> .....	9-37	Wheel alignment and tire balance .....	9-53
Checking the parking brake .....	9-37	Tire replacement .....	9-53
<b>Fuel filter (For Diesel)</b> .....	9-38	Wheel replacement .....	9-55
Draining water from fuel filter.....	9-38	Tire traction.....	9-55
Fuel filter cartridge replacement.....	9-38	Tire maintenance .....	9-55
		Tire sidewall labeling.....	9-55
		Low aspect ratio tire .....	9-60

<b>Fuses</b> .....	9-61
Fuse/Relay panel description .....	9-67
<b>Light bulbs</b> .....	9-79
Headlamp, Static bending lamp, position lamp, turn signal lamp and fog lamp light bulb replacement.....	9-80
Side repeater lamp replacement .....	9-87
Headlamp and front fog lamp aiming (For Europe) ..	9-88
Rear combination light bulb replacement.....	9-93
High mounted stop lamp replacement.....	9-96
License plate light bulb replacement .....	9-96
Interior light bulb replacement.....	9-97
<b>Appearance care</b> .....	9-99
Exterior care .....	9-99
Interior care .....	9-105
<b>Emission control system</b> .....	9-107
Crankcase emission control system.....	9-107
Evaporative emission control system .....	9-107
Exhaust emission control system .....	9-108

## ENGINE COMPARTMENT

### ■ Gasoline Engine (Nu 2.0 MPI)

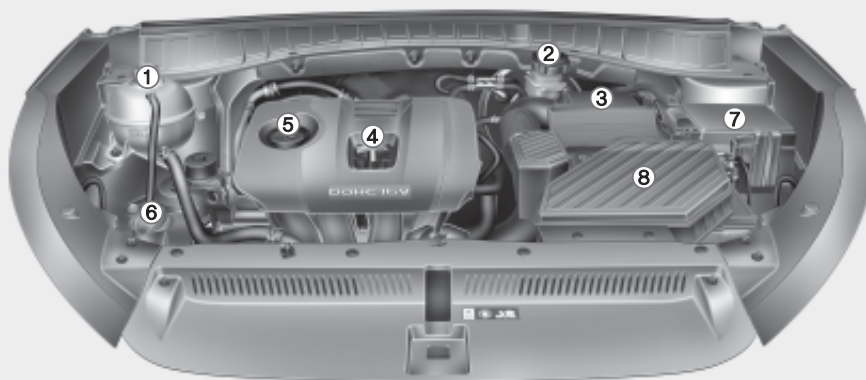

1. Engine coolant reservoir
  2. Brake/clutch\* fluid reservoir
  3. Air cleaner
  4. Engine oil dipstick
  5. Engine oil filler cap
  6. Windshield washer fluid reservoir
  7. Fuse box
  8. Battery
- \* : if equipped

The actual engine room in the vehicle may differ from the illustration.

OTLE075002/OTLE075003

### ■ Diesel Engine (R 2.0 TCI)



1. Engine coolant reservoir
2. Brake/clutch\* fluid reservoir
3. Air cleaner
4. Engine oil dipstick
5. Engine oil filler cap
6. Windshield washer fluid reservoir
7. Fuse box
8. Battery
9. Fuel filter

\* : if equipped

The actual engine room in the vehicle may differ from the illustration.

OTL075001

## MAINTENANCE SERVICES

You should exercise the utmost care to prevent damage to your vehicle and injury to yourself whenever performing any maintenance or inspection procedures.

We recommend you have your vehicle maintained and repaired by an authorized HYUNDAI dealer. An authorized HYUNDAI dealer meets HYUNDAI's high service quality standards and receives technical support from HYUNDAI in order to provide you with a high level of service satisfaction.

### Owner's responsibility

Maintenance service and record retention are the owner's responsibility.

You should retain documents that show proper maintenance has been performed on your vehicle in accordance with the scheduled maintenance service charts shown on the following pages. You need this information to establish your compliance with the servicing and maintenance requirements of your vehicle warranties.

Detailed warranty information is provided in your Service Passport.

Repairs and adjustments required as a result of improper maintenance or a lack of required maintenance are not covered.

### Owner maintenance precautions

Inadequate, incomplete or insufficient servicing may result in operational problems with your vehicle that could lead to vehicle damage, an accident, or personal injury. This chapter provides instructions only for the maintenance items that are easy to perform. Several procedures can be done only by an authorized HYUNDAI dealer with special tools.

Your vehicle should not be modified in any way. Such modifications may adversely affect the performance, safety or durability of your vehicle and may, in addition, violate conditions of the limited warranties covering the vehicle.



### **NOTICE**

Improper owner maintenance during the warranty period may affect warranty coverage. For details, read the separate Service Passport provided with the vehicle. If you're unsure about any servicing or maintenance procedure, we recommend that the system be serviced by an authorized HYUNDAI dealer.

## OWNER MAINTENANCE

### WARNING

Performing maintenance work on a vehicle can be dangerous. If you lack sufficient knowledge and experience or the proper tools and equipment to do the work, we recommend that the system be serviced by an authorized HYUNDAI dealer. ALWAYS follow these precautions for performing maintenance work:

- Park your vehicle on level ground, move the shift lever into the P (Park, for automatic transaxle/Dual clutch transmission vehicle) position, apply the parking brake, place the ignition switch in the LOCK/OFF position.
- Block the tires (front and back) to prevent the vehicle from moving. Remove loose clothing or jewelry that can become entangled in moving parts.

(Continued)

(Continued)

- If you must run the engine during maintenance, do so out doors or in an area with plenty of ventilation.
- Keep flames, sparks, or smoking materials away from the battery and fuel-related parts.

The following lists are vehicle checks and inspections that should be performed by the owner or an authorized HYUNDAI dealer at the frequencies indicated to help ensure safe, dependable operation of your vehicle.

Any adverse conditions should be brought to the attention of your dealer as soon as possible.

These Owner Maintenance vehicle checks are generally not covered by warranties and you may be charged for labor, parts and lubricants used.

**⚠ WARNING**

**Diesel Engine**

Never manipulate or modify the injection system while running the diesel engine or within 30 seconds after turning OFF the diesel engine. The high-pressure pump, high-pressure pipes, rail, and injectors are still subject to the high pressure right after stopping the diesel engine. When the fuel leakage vents out, it may cause serious body injury. Any people, who are implemented with the artificial cardiac pacemaker, should remain away from the ECU or the wiring harness by at least 30 cm, while running the diesel engine. The high currents of the electric engine control system produce a considerable amount of magnetic fields.

**Owner maintenance schedule**

***When you stop for fuel:***

- Check the engine oil level.
- Check coolant level in the engine coolant reservoir.
- Check the windshield washer fluid level.
- Check for low or under-inflated tires.

**⚠ WARNING**

**Be careful when checking your engine coolant level when the engine is hot. This may result in coolant being blown out of the opening and cause serious burns and other injuries.**

***While operating your vehicle:***

- Note any changes in the sound of the exhaust or any smell of exhaust fumes in the vehicle.
- Check for vibrations in the steering wheel. Notice if there is any increased steering effort or looseness in the steering wheel, or change in its straight-ahead position.
- Notice if your vehicle constantly turns slightly or “pulls” to one side when traveling on smooth, level road.
- When stopping, listen and check for unusual sounds, pulling to one side, increased brake pedal travel or “hard-to-push” brake pedal.
- If any slipping or changes in the operation of your transaxle occurs, check the transaxle fluid level.
- Check the automatic transaxle/dual clutch transmission P (Park) function.
- Check the parking brake.
- Check for fluid leaks under your vehicle (water dripping from the air conditioning system during or after use is normal).

***At least monthly:***

- Check coolant level in the engine coolant reservoir.
- Check the operation of all exterior lights, including the stoplights, turn signals and hazard warning flashers.
- Check the inflation pressures of all tires including the spare for tires that are worn, show uneven wear, or are damaged.
- Check for loose wheel lug nuts.

***At least twice a year:  
(i.e., every Spring and Fall)***

- Check radiator, heater and air conditioning hoses for leaks or damage.
- Check windshield washer spray and wiper operation. Clean wiper blades with clean cloth dampened with washer fluid.
- Check headlamp alignment.
- Check muffler, exhaust pipes, shields and clamps.
- Check the seat belts for wear and function.

***At least once a year:***

- Clean body and door drain holes.
- Lubricate door hinges and hood hinges.
- Lubricate door and hood locks and latches.
- Lubricate door rubber weather strips.
- Check the air conditioning system.
- Inspect and lubricate automatic transaxle linkage and controls.
- Clean the battery and terminals.
- Check the brake fluid level.

### SCHEDULED MAINTENANCE SERVICES

Follow Normal Maintenance Schedule if the vehicle is usually operated where none of the following conditions apply.

If any of the following conditions apply, you must follow the Maintenance Under Severe Usage Conditions.

- Repeated driving short distance of less than 8 km (5 miles) in normal temperature or less than 16 km (10 miles) in freezing temperature
- Extensive engine idling or low speed driving for long distances
- Driving on rough, dusty, muddy, unpaved, graveled or salt-spread roads
- Driving in areas using salt or other corrosive materials or in very cold weather
- Driving in the condition of inflowing sand or dust into engine
- Driving in heavy traffic area
- Driving on uphill, downhill, or mountain road repeatedly
- Towing a trailer or using a camper, or roof rack
- Driving as a patrol car, taxi, other commercial use of vehicle towing
- Driving over 170 km/h (106 mile/h)
- Frequently driving in stop-and-go condition

*If your vehicle is operated under the above conditions, you should inspect, replace or refill more frequently than the following Normal Maintenance Schedule. After the periods or distance shown in the chart, continue to follow the prescribed maintenance intervals.*

## NORMAL MAINTENANCE SCHEDULE - PETROL ENGINE

The following maintenance services must be performed to ensure good emission control and performance. Keep receipts for all vehicle emission services to protect your warranty. Where both kilometres and time are shown, the frequency of service is determined by whichever occurs first.

- \*1 : Check the engine oil level and leak every 500 km (350 miles) or before starting a long trip.
- \*2 : Driving in ambient temperature over 40 °C (104 °F) or driving at constant highway speeds must conform the severe driving condition.
- \*3 : The engine oil level should be checked regularly and maintained properly. Operating with an insufficient amount of oil can damage the engine, and such damage is not covered by warranty.
- \*4 : Inspect for excessive valve noise and/or engine vibration and adjust if necessary. We recommend that an authorized HYUNDAI dealer should perform the operation.
- \*5 : When adding coolant, use only deionised water or soft water for your vehicle and never mix hard water in the coolant filled at the factory. An improper coolant mixture can result in serious malfunction or engine damage.
- \*6 : Manual transaxle fluid should be changed anytime the vehicle has been submerged in water.
- \*7 : If good quality petrols that meet Europe Fuel standards (EN228) or equivalents including fuel additives is not available, one bottle of additive is recommended. Additives are available from your authorised HYUNDAI dealer along with information on how to use them. Do not mix other additives.
- \*8 : Maintenance schedule depends on fuel quality. If there are some important matters like fuel flow restriction, surging, loss of power, difficulty in starting problems etc, we recommend replacing the fuel filter immediately regardless of the maintenance schedule and consulting with an authorised HYUNDAI dealer for details.
- \*9 : Inspect drive belt tensioner, idler & alternator pulley, Starter and all chassis electrical items. Correct or replace, if necessary.

**NORMAL MAINTENANCE SCHEDULE - PETROL ENGINE (CONT.)**

MAINTENANCE ITEM	MAINTENANCE INTERVALS	Number of months or driving distance, whichever comes first									
		Kmsx1,000	1.5	10	20	30	40	50	60	70	80
		Months	2	12	24	36	48	60	72	84	96
		Years	-	1	2	3	4	5	6	7	8
<b>ENGINE BAY</b>											
Engine oil and engine oil filter*1 *2 *3		I	R	R	R	R	R	R	R	R	
Drive belts		-	-	I	-	I	-	I	-	I	
Air cleaner filter		Clean at every service; Replace at every 30,000 Kms or 36 months									
Battery condition & specific gravity		I	I	I	I	I	I	I	I	I	
Spark plugs		Replace at every 160,000 Km or 120 months									
Hoses (Vaccum/ EGR / VGT/ WGT)		-	I	I	I	I	I	I	I	I	
Tensioner/idler/damper pulley		Inspect when replacing the drive belt or timing belt/chain									
Brake/Clutch fluid		I	I	I	I	I	I	I	I	I	
Engine coolant (topup & specific gravity) * 5		Inspect at every service ; Replace first at 210,000 Km or 120 months, then at every 120,000 Km or 120 months									
Manual transaxle fluid * 6		-	-	-	-	-	-	I	-	-	
Automatic transaxle fluid		No check, No service required									

I : Inspect and if necessary adjust, top-up, clean or replace  
R : Replace

C: Clean and Replace if necessary

## NORMAL MAINTENANCE SCHEDULE - PETROL ENGINE (CONT.)

MAINTENANCE ITEM	MAINTENANCE INTERVALS	Number of months or driving distance, whichever comes first									
		Kmsx1,000	1.5	10	20	30	40	50	60	70	80
		Months	2	12	24	36	48	60	72	84	96
		Years	-	1	2	3	4	5	6	7	8
<b>VEHICLE ON FLOOR</b>											
Brake/Clutch (Pedal free play/Pipes/loses/Connectors)		I	I	I	I	I	I	I	I	I	
Fuel filler cap		-	I	I	I	I	I	I	I	I	
Climate control air filter		I	R	R	R	R	R	R	R	R	
Check AC system (refrigerant/Compressor)		I	I	I	I	I	I	I	I	I	
Cooling system (water pump,hoses) & leakage		I	I	I	I	I	I	I	I	I	
<b>VEHICLE ON LIFT</b>											
Steering gear rack, linkage and boots		I	I	I	I	I	I	I	I	I	
Exhaust system		I	I	I	I	I	I	I	I	I	
Fuel filter* <sup>8</sup>		-	-	-	I	-	-	R	-	-	
Fuel tank air filter (If equipped)		Inspect at every 20,000 km, Replace at every 60,000 Kms or 48 months									
Front & rear suspension (linkages & ball joints)		I	I	I	I	I	I	I	I	I	

I : Inspect and if necessary adjust, top-up, clean or replace  
R : Replace

A : Add  
C : Clean and replace if necessary



## Maintenance

### NORMAL MAINTENANCE SCHEDULE - PETROL ENGINE (CONT.)

MAINTENANCE ITEM	MAINTENANCE INTERVALS	Number of months or driving distance, whichever comes first									
		Kms×1,000	1.5	10	20	30	40	50	60	70	80
		Months	2	12	24	36	48	60	72	84	96
		Years	-	1	2	3	4	5	6	7	8
Fuel lines, hoses and connections		I	I	I	I	I	I	I	I	I	
Driveshafts & boots		I	I	I	I	I	I	I	I	I	
Fluid leakages		I	I	I	I	I	I	I	I	I	
Front and rear disc/drum brakes & pads		I	I	I	I	I	I	I	I	I	
Parking brake (disc ,shoe & operation)		I	I	I	I	I	I	I	I	I	
Wheel Alignment & Balancing		-	Inspect if required								
Tyre (Pressure & tread wear)		-	I	I	I	I	I	I	I	I	
<b>FINAL CHECKS</b>											
Bolt and nuts on chasis and body		I	I	I	I	I	I	I	I	I	
Lubricate locks & hinges		I	L	L	L	L	L	L	L	L	
Check all electrical systems (Drive belts ,alternator)* <sup>9</sup>		I	I	I	I	I	I	I	I	I	
Warning lights operation & GDS system check		I	I	I	I	I	I	I	I	I	
Ext & int. lights & gauges		I	I	I	I	I	I	I	I	I	

I : Inspect and if necessary adjust, top-up, clean or replace

R : Replace

A : Add

TR : Tyre Rotation

L : Lubricate

## NORMAL MAINTENANCE SCHEDULE - PETROL ENGINE (CONT.)

MAINTENANCE ITEM	MAINTENANCE INTERVALS	Number of months or driving distance, whichever comes first								
	Kmsx1,000	1.5	10	20	30	40	50	60	70	80
	Months	2	12	24	36	48	60	72	84	96
	Years	-	1	2	3	4	5	6	7	8
Power window / Sunroof operation (if equipped)		I	I	I	I	I	I	I	I	I
All seat belt operation		I	I	I	I	I	I	I	I	I
Road test		Inspect if required								

I : Inspect and if necessary adjust, top-up, clean or replace  
 R : Replace

A : Add  
 TR : Tyre Rotation

L : Lubricate

## Maintenance

### MAINTENANCE UNDER SEVERE USAGE CONDITIONS - PETROL ENGINE

The following items must be serviced more frequently on cars mainly used under severe driving conditions.

Refer to the chart below for the appropriate maintenance intervals.

I : Inspect and if necessary, adjust, correct, clean or replace    R : Replace or change

Maintenance item	Maintenance operation	Maintenance intervals	Driving condition
Engine oil and engine oil filter	R	Replace every 5,000 km or 6 months	A, B, C, D, E, F, G, H, I, J
Air cleaner filter	R	Replace more frequently depending on the condition	C, E
Spark plugs	R	Replace more frequently depending on the condition	B, H
Manual transaxle fluid (if equipped)	R	Every 120,000 kms	C, D, E, G, H, I, J
Automatic transaxle fluid (if equipped)	R	Every 100,000 kms	A, C, D, E, F, G, H, I, J
Steering gear rack, linkage and boots	I	Inspect more frequently depending on the condition	C, D, E, F, G

Maintenance item	Maintenance operation	Maintenance intervals	Driving condition
Disc brakes and pads, calipers and rotors	I	Inspect more frequently depending on the condition	C, D, E, G, H
Parking brake	I	Inspect more frequently depending on the condition	C, D, G, H
Driveshaft and boots	I	Inspect more frequently depending on the condition	C, D, E, F, G, H, I, J, K, L
Climate control air filter	R	Replace more frequently depending on the condition	C, E

### Severe driving conditions

A : Repeated short distance driving

B : Extensive idling

C : Driving in dusty, rough roads

D : Driving in areas using salt or other corrosive materials or in very cold weather

E : Driving in the condition of inflowing sand or dust into engine

F : Driving in heavy traffic area

G : Driving in mountainous areas.

H : Towing a trailer

I : Driving for patrol car, taxi, commercial car or vehicle towing

J : Driving in very cold weather

K : Driving over 170 km/h

L : Frequently driving in stop-and-go conditions

### NORMAL MAINTENANCE SCHEDULE - FOR DIESEL ENGINE

The following maintenance services must be performed to ensure good emission control and performance. Keep receipts for all vehicle emission services to protect your warranty. Where both kilometres and time are shown, the frequency of service is determined by whichever occurs first.

- \*1 : Check the engine oil level and leak every 500 km (350 miles) or before starting a long trip.
- \*2 : Driving in ambient temperature over 40 °C (104 °F) or driving at constant highway speeds must conform the severe driving condition.
- \*3 : The engine oil level should be checked regularly and maintained properly. Operating with an insufficient amount of oil can damage the engine, and such damage is not covered by warranty.
- \*4 : Inspect for excessive valve noise and/or engine vibration and adjust if necessary. We recommend that an authorized HYUNDAI dealer should perform the operation.
- \*5 : When adding coolant, use only deionised water or soft water for your vehicle and never mix hard water in the coolant filled at the factory. An improper coolant mixture can result in serious malfunction or engine damage.
- \*6 : Manual transaxle fluid should be changed anytime the vehicle has been submerged in water.
- \*7 : If good quality petrols that meet Europe Fuel standards (EN228) or equivalents including fuel additives is not available, one bottle of additive is recommended. Additives are available from your authorised HYUNDAI dealer along with information on how to use them. Do not mix other additives
- \*8 : Maintenance schedule depends on fuel quality. If there are some important matters like fuel flow restriction, surging, loss of power, difficulty in starting problems etc, we recommend replacing the fuel filter immediately regardless of the maintenance schedule and consulting with an authorised HYUNDAI dealer for details.
- \*9 : Inspect drive belt tensioner, idler & alternator pulley, Starter and all chassis electrical items. Correct or replace, if necessary.

## NORMAL MAINTENANCE SCHEDULE - DIESEL ENGINE

MAINTENANCE ITEM	MAINTENANCE INTERVALS	Number of months or driving distance, whichever comes first									
		Kmsx1,000	1.5	10	20	30	40	50	60	70	80
		Months	2	12	24	36	48	60	72	84	96
		Years	-	1	2	3	4	5	6	7	8
<b>ENGINE BAY</b>											
Engine oil and engine oil filter <sup>1 *2 *3</sup>		I	R	R	R	R	R	R	R	R	
Drive belts		-	-	I	-	I	-	I	-	I	
Air cleaner filter		C	C	R	C	R	C	R	C	R	
Battery condition		I	I	I	I	I	I	I	I	I	
Hoses (Vaccum/ EGR / VGT/ WGT)		-	I	I	I	I	I	I	I	I	
Tensioner/idler/damper pulley		Inspect when replacing the drive belt or timing belt/chain									
Brake/Clutch fluid		I	I	I	I	I	I	I	I	I	
Engine coolant (topup & specific gravity) <sup>* 5</sup>		Inspect at every service ; Replace first at 210,000 Km or 120 months, then at every 120,000 Km or 120 months									
Manual transaxle fluid <sup>* 6</sup>		-	-	-	-	-	-	I	-	-	
Automatic transaxle fluid		No check, No service required									

I : Inspect and if necessary adjust, top-up, clean or replace  
 R : Replace

C : Clean and Replace if necessary

**NORMAL MAINTENANCE SCHEDULE - DIESEL ENGINE (CONT.)**

MAINTENANCE ITEM	MAINTENANCE INTERVALS	Number of months or driving distance, whichever comes first									
		Kms×1,000	1.5	10	20	30	40	50	60	70	80
		Months	2	12	24	36	48	60	72	84	96
		Years	-	1	2	3	4	5	6	7	8
<b>VEHICLE ON FLOOR</b>											
Brake/Clutch (pedal free play/pipes/hoses/connectors)		I	I	I	I	I	I	I	I	I	
Fuel filler cap		-	I	I	I	I	I	I	I	I	
Climate control air filter		I	R	R	R	R	R	R	R	R	
Check AC system (refrigerant/compressor)		I	I	I	I	I	I	I	I	I	
Cooling system (water pump,hoses) & leakage		I	I	I	I	I	I	I	I	I	
<b>VEHICLE ON LIFT</b>											
Steering gear rack, linkage and boots		I	I	I	I	I	I	I	I	I	
Exhaust system		I	I	I	I	I	I	I	I	I	
Fuel filter cartridge* <sup>8</sup>		-	-	R	-	R	-	R	-	R	
Front & rear suspension (linkages & ball joints)		I	I	I	I	I	I	I	I	I	

I : Inspect and if necessary adjust, top-up, clean or replace

R : Replace

A : Add

C : Clean and replace if necessary

## NORMAL MAINTENANCE SCHEDULE - DIESEL ENGINE (CONT.)

MAINTENANCE ITEM	MAINTENANCE INTERVALS	Number of months or driving distance, whichever comes first									
		Kmsx1,000	1.5	10	20	30	40	50	60	70	80
		Months	2	12	24	36	48	60	72	84	96
		Years	-	1	2	3	4	5	6	7	8
Fuel lines, hoses and connections		I	I	I	I	I	I	I	I	I	
Driveshafts & boots		I	I	I	I	I	I	I	I	I	
Fluid leakages		I	I	I	I	I	I	I	I	I	
Front and rear disc/drum brakes & pads		I	I	I	I	I	I	I	I	I	
Parking brake (disc ,shoe & operation)		I	I	I	I	I	I	I	I	I	
Wheel Alignment & Balancing (If required)		-	Inspect if required								
Tyre (Pressure & tread wear)		-	I	I	I	I	I	I	I	I	
<b>FINAL CHECKS</b>											
Bolt and nuts on chasis and body		I	I	I	I	I	I	I	I	I	
Lubricate locks & hinges		I	L	L	L	L	L	L	L	L	
Check all electrical systems (Drive belts ,alternator)* <sup>9</sup>		I	I	I	I	I	I	I	I	I	
Warning lights operation & GDS system check		I	I	I	I	I	I	I	I	I	
Ext & Int. lights & gauges		I	I	I	I	I	I	I	I	I	

I : Inspect and if necessary adjust, top-up, clean or replace  
 R : Replace

A : Add  
 TR : Tyre Rotation

L : Lubricate



**NORMAL MAINTENANCE SCHEDULE - DIESEL ENGINE (CONT.)**

MAINTENANCE INTERVALS  MAINTENANCE ITEM	Number of months or driving distance, whichever comes first									
	Kms×1,000	1.5	10	20	30	40	50	60	70	80
	Months	2	12	24	36	48	60	72	84	96
	Years	-	1	2	3	4	5	6	7	8
Power window / Sunroof operation (if equipped)	I	I	I	I	I	I	I	I	I	I
All seat belt operation	I	I	I	I	I	I	I	I	I	I
Road test	Inspect if required									

I : Inspect and if necessary adjust, top-up, clean or replace  
 R : Replace

A:Add  
 TR : Tyre Rotation

L : Lubricate

## MAINTENANCE UNDER SEVERE USAGE CONDITIONS - DIESEL ENGINE

The following items must be serviced more frequently on cars mainly used under severe driving conditions. Refer to the chart below for the appropriate maintenance intervals.

R : Replace I : Inspect and if necessary, adjust, correct, clean or replace

MAINTENANCE ITEM	Maintenance operation	Maintenance intervals	Driving condition
Engine oil and engine oil filter	R	Every 5,000 kms or 6 months	A, B, C, F, G, H, I, J, K, L
Air cleaner filter	R	Replace more frequently depending on the condition	C, E
Manual transaxle fluid (if equipped)	R	Every 120,000 kms	C, D, E, G, H, I, K
Automatic transaxle fluid (if equipped)	R	Every 100,000 kms	C, D, E, G, H, I, K
Steering gear rack, linkage and boots	I	Inspect more frequently depending on the condition	C, D, E, F, G

## EXPLANATION OF SCHEDULED MAINTENANCE ITEMS

### Engine oil and filter

The engine oil and filter should be changed at the intervals specified in the maintenance schedule. If the car is being driven in severe conditions, more frequent oil and filter changes are required.

### Drive belts

Inspect all drive belts for evidence of cuts, cracks, excessive wear or oil saturation and replace if necessary. Drive belts should be checked periodically for proper tension and adjusted as necessary.

#### CAUTION

When you are inspecting the belt, place the ignition switch to the LOCK/OFF or ACC position.

### Fuel filter (cartridge)

A clogged-up fuel filter may limit the vehicle driving speed, damage the emission system, and cause the hard starting. When a considerable amount of foreign substances are accumulated in the fuel tank, the fuel filter should be replaced.

Upon installing a new fuel filter, operate the diesel engine for several minutes, and check the connections for any leakages. We recommend you to have the fuel filter replaced by an authorized HYUNDAI dealer.

### Fuel lines, fuel hoses and connections

Check the fuel lines, fuel hoses and connections for leakage and damage. We recommend that the fuel lines, fuel hoses and connections be replaced by an authorized HYUNDAI dealer.

#### WARNING

##### Diesel Only

Never manipulate or modify the injection system while running the diesel engine or within 30 seconds after turning OFF the diesel engine. The high-pressure pump, high-pressure pipes, rail, and injectors are still subject to the high pressure right after stopping the diesel engine. When the fuel leakage vents out, it may cause serious body injury. Any people, who are implemented with the artificial cardiac pacemaker, should remain away from the ECU or the wiring harness by at least 30 cm while running the diesel engine. The high currents of the common rail system produce a considerable amount of magnetic fields.

### Vapor hose and fuel filler cap

The vapor hose and fuel filler cap should be inspected at those intervals specified in the maintenance schedule. Make sure that a new vapor hose or fuel filler cap is correctly replaced.

### Vacuum crankcase ventilation hoses (if equipped)

Inspect the surface of hoses for evidence of heat and/or mechanical damage. Hard and brittle rubber, cracking, tears, cuts, abrasions, and excessive swelling indicate deterioration. Particular attention should be paid to examine those hose surfaces nearest to high heat sources, such as the exhaust manifold.

Inspect the hose routing to assure that the hoses do not come in contact with any heat source, sharp edges or moving component which might cause heat damage or mechanical wear. Inspect all hose connections, such as clamps and couplings, to make sure they are secure, and that no leaks are present. Hoses should be replaced immediately if there is any evidence of deterioration or damage.

### Air cleaner filter

We recommend that the air cleaner filter be replaced by an authorized HYUNDAI dealer.

### Spark plugs (for Gasoline Engine)

Make sure to install new spark plugs of the correct heat range.

#### WARNING

**Do not disconnect and inspect spark plugs when the engine is hot. You may burn yourself.**

### Valve clearance (for Gasoline Engine)

Inspect excessive valve noise and/or engine vibration and adjust if necessary. We recommend that the system be serviced by an authorized HYUNDAI dealer.

### Cooling system

Check the cooling system parts, such as radiator, coolant reservoir, hoses and connections for leakage and damage. Replace any damaged parts.

### Coolant

The coolant should be changed at the intervals specified in the maintenance schedule.

### Automatic transaxle fluid (if equipped)

Automatic transaxle fluid should not be checked under normal usage conditions.

We recommend that the automatic transaxle fluid be changed by an authorized HYUNDAI dealer according to the maintenance schedule.

#### **NOTICE**

**Automatic transaxle fluid color is basically red.**

**As the vehicle is driven, the automatic transaxle fluid will begin to look darker.**

**It is normal condition and you should not judge the need to replace the fluid based upon the changed color.**

#### **CAUTION**

**The use of a non-specified fluid could result in transaxle malfunction and failure.**

**Use only specified automatic transaxle fluid. (Refer to "Recommended lubricants and capacities" in section 8.)**

### Manual transaxle fluid (if equipped)

Inspect the manual transaxle fluid according to the maintenance schedule.

### Dual clutch transmission fluid (if equipped)

Inspect the dual clutch transmission fluid according to the maintenance schedule.

### Brake hoses and lines

Visually check for proper installation, chafing, cracks, deterioration and any leakage. Replace any deteriorated or damaged parts immediately.

### Brake/Clutch fluid (if equipped)

Check brake fluid level in the brake fluid reservoir. The level should be between “MIN” and “MAX” marks on the side of the reservoir. Use only hydraulic brake fluid conforming to DOT 3 or DOT 4 specification.

### Parking brake

Inspect the parking brake system including the parking brake lever (or pedal) and cables.

### Brake pads, calipers and rotors

Check the pads for excessive wear, discs for run out and wear, and calipers for fluid leakage.

For more information on checking the pads or lining wear limit, refer to the HYUNDAI web site.

(<http://service.hyundai-motor.com>)

### Suspension mounting bolts

Check the suspension connections for looseness or damage. Retighten to the specified torque.

### Steering gear box, linkage & boots/lower arm ball joint

With the vehicle stopped and engine off, check for excessive free-play in the steering wheel.

Check the linkage for bends or damage. Check the dust boots and ball joints for deterioration, cracks, or damage. Replace any damaged parts.

### Drive shafts and boots

Check the drive shafts, boots and clamps for cracks, deterioration, or damage. Replace any damaged parts and, if necessary, repack the grease.

### Air conditioning refrigerant/compressor

Check the air conditioning lines and connections for leakage and damage.

## ENGINE OIL

### Checking the engine oil level

1. Be sure the vehicle is on level ground.
2. Start the engine and allow it to reach normal operating temperature.

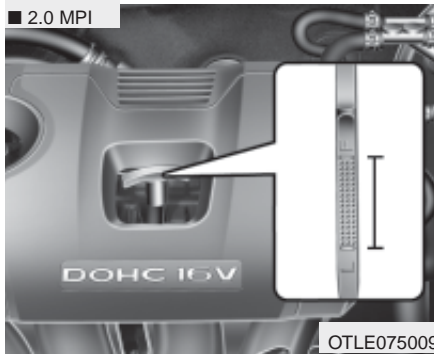

3. Turn the engine off and wait for a few minutes (about 5 minutes) for the oil to return to the oil pan.
4. Pull the dipstick out, wipe it clean, and re-insert it fully.

5. Pull the dipstick out again and check the level. The level should be between F and L.



### ⚠ WARNING

#### Radiator hose

Be very careful not to touch the radiator hose when checking or adding the engine oil as it may be hot enough to burn you.

### ⚠ CAUTION

- Do not overfill the engine oil. It may damage the engine.
- Do not spill engine oil, when adding or changing engine oil. If you drop the engine oil on the engine room, wipe it off immediately.
- When you wipe the oil level gauge, you should wipe it with a clean cloth. When mixed with debris, it can cause engine damage.

### ⚠ CAUTION

#### Diesel Engine

Overfilling the diesel engine oil may cause severe dieseling due to the churning effect. It may damage the diesel engine with the abrupt engine speed incensement, combustion noise, and white smoke emission.

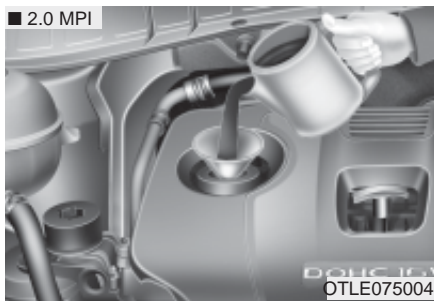

If it is near or at L, add enough oil to bring the level to F. **Do not overfill.**

**Use a funnel to help prevent oil from being spilled on engine components.**

*Use only the specified engine oil. (Refer to "Recommended lubricants and capacities" in section 8.)*

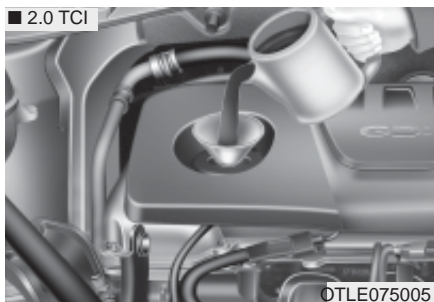

## Checking the engine oil and filter

We recommend that the engine oil and filter be replaced by an authorized HYUNDAI dealer.

### WARNING

Used engine oil may cause irritation or cancer of the skin if left in contact with the skin for prolonged periods of time. Used engine oil contains chemicals that have caused cancer in laboratory animals. Always protect your skin by washing your hands thoroughly with soap and warm water as soon as possible after handling used oil.



## ENGINE COOLANT

The high-pressure cooling system has a reservoir filled with year-round antifreeze coolant. The reservoir is filled at the factory.

Check the antifreeze protection and coolant concentration level at least once a year, at the beginning of the winter season, and before traveling to a colder climate.

### CAUTION

- When the engine overheats from low engine coolant, suddenly adding engine coolant may cause cracks in the engine. To prevent damage, add engine coolant slowly in small quantities.
- Do not drive with no engine coolant. It may cause water pump failure and engine seizure, etc.

### Checking the coolant level



Check the condition and connections of all cooling system hoses and heater hoses. Replace any swollen or deteriorated hoses.

The coolant level should be filled between MAX and MIN marks on the side of the coolant reservoir when the engine is cool.

If the coolant level is low, add enough distilled (deionized) water.

Bring the level to MAX, but do not overfill.

If frequent additions are required, we recommend that the system be inspected by an authorized HYUNDAI dealer.

## ⚠ WARNING



### Removing coolant cap

- Never attempt to remove the coolant cap while the engine is operating or hot. Doing so might lead to cooling system and engine damage and could result in serious personal injury from escaping hot coolant or steam.

(Continued)

(Continued)

- Turn the engine off and wait until it cools down. Use extreme care when removing the coolant cap. Wrap a thick towel around it, and turn it counterclockwise slowly to the first stop. Step back while the pressure is released from the cooling system.

When you are sure all the pressure has been released, press down on the cap, using a thick towel, and continue turning counterclockwise to remove it.

- Even if the engine is not operating, do not remove the coolant cap or the drain plug while the engine and radiator are hot. Hot coolant and steam may still blow out under pressure, causing serious injury.

## ⚠ WARNING



The electric motor (cooling fan) is controlled by engine coolant temperature, refrigerant pressure and vehicle speed. It may sometimes operate even when the engine is not running. Use extreme caution when working near the blades of the cooling fan so that you are not injured by a rotating fan blades. As the engine coolant temperature decreases, the electric motor will automatically shut off. This is a normal condition.

The electric motor (cooling fan) may operate until you disconnect the negative battery cable.

**⚠ WARNING**

Make sure the coolant cap is properly closed after refilling coolant. Otherwise the engine could be overheated while driving

**1. Check if the coolant cap label is**

■ Engine room front view



straight in front.

(Continued)

**(Continued)**

■ Engine room rear view



**2. Make sure that the tiny protrusions inside the coolant cap should be securely interlocked.**

***Recommended engine coolant***

- When adding coolant, use only deionized water or soft water for your vehicle and never mix hard water in the coolant filled at the factory. An improper coolant mixture can result in serious malfunction or engine damage.
- The engine in your vehicle has aluminum engine parts and must be protected by a phosphate-based ethylene glycol coolant to prevent corrosion and freezing.
- DO NOT USE alcohol or methanol coolant or mix them with the specified coolant.
- Do not use a solution that contains more than 60% antifreeze or less than 35% antifreeze, which would reduce the effectiveness of the solution.

For mixture percentage, refer to the following table.

Ambient Temperature	Mixture Percentage (volume)	
	Antifreeze	Water
-15°C (5°F)	35	65
-25°C (-13°F)	40	60
-35°C (-31°F)	50	50
-45°C (-49°F)	60	40

### **i** Information

If in doubt about the mix ratio, a 50% water and 50% antifreeze mix is the easiest to mix together as it will be the same quantity of each. It is suitable to use for most temperature ranges of -35°C (-31°F) and higher.

### Changing the coolant

We recommend that the coolant be replaced by an authorized HYUNDAI dealer.

#### CAUTION

Put a thick cloth or fabric around the coolant cap before refilling the coolant in order to prevent the coolant from overflowing into engine parts such as generator.

#### WARNING

#### Coolant

- Do not use radiator coolant or antifreeze in the washer fluid reservoir.
- Radiator coolant can severely obscure visibility when sprayed on the windshield and may cause loss of vehicle control or damage to paint and body trim.

## BRAKE/CLUTCH FLUID (IF EQUIPPED)

### Checking the brake/clutch fluid level



Check the fluid level in the reservoir periodically. The fluid level should be between MAX and MIN marks on the side of the reservoir.

Before removing the reservoir cap and adding brake/clutch fluid, clean the area around the reservoir cap thoroughly to prevent brake/clutch fluid contamination.

If the level is low, add fluid to the MAX level. The level will fall with accumulated mileage. This is a normal condition associated with the wear of the brake linings.

If the fluid level is excessively low, we recommend that the system be checked by an authorized HYUNDAI dealer.

#### **i** Information

Use only the specified brake/clutch fluid. (Refer to “Recommended lubricants and capacities” in section 8.)

*Never mix different types of fluid.*

#### **⚠** WARNING

**In the event the brake/clutch system requires frequent additions of fluid, we recommend that the system be inspected by an authorized HYUNDAI dealer.**

#### **NOTICE**

Before removing the brake/clutch filler cap, read the warning on the cap.

#### **⚠** WARNING

Clean filler cap before removing. Use only DOT3 or DOT4 brake/clutch fluid from a sealed container.

 **WARNING**

When changing and adding brake/clutch fluid, handle it carefully. Do not let it come in contact with your eyes. If brake/ clutch fluid should come in contact with your eyes, immediately flush them with a large quantity of fresh tap water. Have your eyes examined by a doctor as soon as possible.

 **CAUTION**

Do not allow brake/clutch fluid to contact the vehicle's body paint, as paint damage will result. Brake/clutch fluid, which has been exposed to open air for an extended time should never be used as its quality cannot be guaranteed. It should be disposed of properly. Don't put in the wrong kind of fluid.

A few drops of mineral-based oil, such as engine oil, in your brake/clutch system can damage brake/clutch system parts.

## WASHER FLUID

### Checking the washer fluid level

The reservoir is translucent so that



you can check the level with a quick visual inspection.

Check the fluid level in the washer fluid reservoir and add fluid if necessary.

Plain water may be used if washer fluid is not available.

However, use washer solvent with antifreeze characteristics in cold climates to prevent freezing.

### CAUTION

#### Coolant

- Do not use radiator coolant or antifreeze in the washer fluid reservoir.
- Radiator coolant can severely obscure visibility when sprayed on the windshield and may cause loss of vehicle control or damage to paint and body trim.
- Windshield Washer fluid agents contain some amounts of alcohol and can be flammable under certain circumstances. Do not allow sparks or flame to contact the washer fluid or the washer fluid reservoir. Damage to the vehicle or occupants could occur.
- Windshield washer fluid is poisonous to humans and animals. Do not drink and avoid contacting windshield washer fluid. Serious injury or death could occur.

## PARKING BRAKE

### Checking the parking brake

#### Type A



OTL055012

Check whether the stroke is within specification when the parking brake pedal is depressed with 20 kg (44 lb, 196N) of force. Also, the parking brake alone should securely hold the vehicle on a fairly steep grade. If the stroke is more or less than specified, we recommend that the system be serviced by an authorized HYUNDAI dealer.

**Stroke : 3 notch**

#### Type B

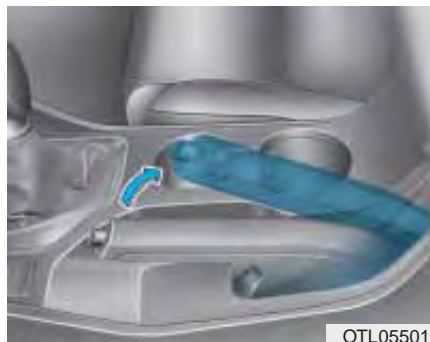

OTL055011

Check the stroke of the parking brake by counting the number of “clicks” heard while fully applying it from the released position. Also, the parking brake alone should securely hold the vehicle on a fairly steep grade. If the stroke is more or less than specified, we recommend that the system be serviced by an authorized HYUNDAI dealer.

**Stroke : 5~6 “clicks” at a force of 20 kg (44 lbs, 196 N).**



## FUEL FILTER (FOR DIESEL)

### Draining water from fuel filter

The fuel filter in the diesel engine operates the critical function of separating water from the fuels and accumulating the water in its bottom.

When enough water is accumulated inside the fuel filter, the warning light illuminates with the ignition switch in the ON position.

In this case, we recommend you to have the system checked by an authorized HYUNDAI dealer.

 **CAUTION**

When the accumulated water is not drained at a proper timing, water may permeate in the fuel filter, damaging the major vehicle components, such as the fuel system.

### Fuel filter cartridge replacement

 **Information**

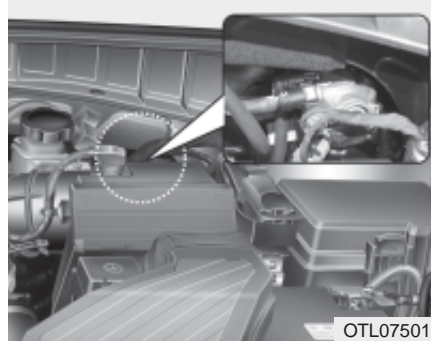

When replacing the fuel filter cartridge, we recommend that you use parts for replacement from an authorized HYUNDAI dealer.

## AIR CLEANER

### Filter replacement

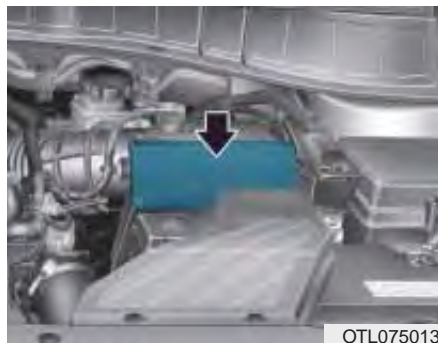

The air cleaner filter can be cleaned for inspection using compressed air. Do not attempt to wash or to rinse it, as water will damage the filter. If soiled, the air cleaner filter must be replaced.



1. Pull down the air cleaner filter cover.
2. Wipe the inside of the air cleaner



3. Pull down the lever to the UNLOCK position.



4. Replace the air cleaner filter.



5. Pull up the lever(1) to the LOCK position.
6. Rise up the cover (2) until the hooks on the cover are securely fastened into the latches (3).
7. Check if the cover is firmly installed.

### **i** Information

If the vehicle is operated in extremely dusty or sandy areas, replace the element more often than the usual recommended intervals (refer to “Maintenance Under Severe Usage Conditions” in this chapter).

### **NOTICE**

- Do not drive with the air cleaner filter removed. This will result in excessive engine wear.
- When removing the air cleaner filter, be careful that dust or dirt does not enter the air intake, or damage may result.
- Use HYUNDAI genuine parts, use of non-genuine parts could damage the air flow sensor.

## CLIMATE CONTROL AIR FILTER

### Filter inspection

If the vehicle is operated in the severely air-polluted cities or on dusty rough roads for a long period, it should be inspected more frequently and replaced earlier. When you, the owner, replace the climate control air filter, replace it performing the following procedure, and be careful to avoid damaging other components.

Replace the filter according to the Maintenance Schedule.

### NOTICE

Install a new climate control air filter in the correct direction with the arrow symbol(↓) facing downwards.

Otherwise, the climate control effects may decrease, possibly with a noise.

### Filter replacement

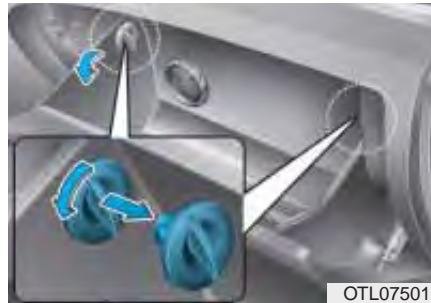

1. With the glove box open, remove the stoppers on both sides.
2. Open the glove box and remove the support strap (1).

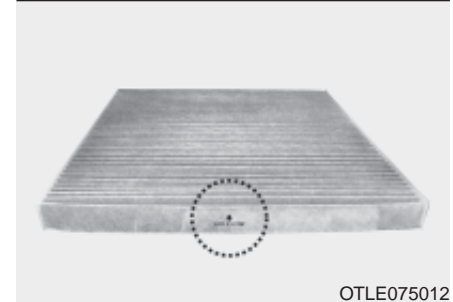

3. Remove the climate control air filter case while pressing the lock on the left side of the cover.
4. Replace the climate control air filter.
5. Reassemble in the reverse order of disassembly.

## WIPER BLADES

### Blade inspection

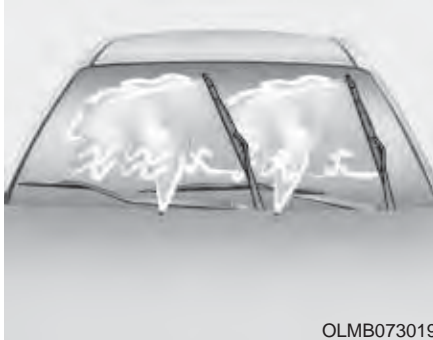

#### **i** Information

Commercial hot waxes applied by automatic car washes have been known to make the windshield difficult to clean.

Contamination of either the windshield or the wiper blades with foreign matter can reduce the effectiveness of the windshield wipers.

Common sources of contamination are insects, tree sap, and hot wax treatments used by some commercial car washes. If the blades are not wiping properly, clean both the window and the blades with a good cleaner or mild detergent, and rinse thoroughly with clean water.

#### **NOTICE**

To prevent damage to the wiper blades, do not use gasoline, kerosene, paint thinner, or other solvents on or near them.

### Blade replacement

When the wipers no longer clean adequately, the blades may be worn or cracked, and require replacement.

#### **NOTICE**

To prevent damage to the wiper arms or other components, do not attempt to move the wipers manually.

#### **NOTICE**

The use of a non-specified wiper blade could result in wiper malfunction and failure.

#### CAUTION

Do not allow the wiper arm to fall against the windshield, since it may chip or crack the windshield.

## Front windshield wiper blade



### Type A

1. Raise the wiper arm and turn the wiper blade assembly to expose the plastic locking clip.

#### CAUTION

Do not allow the wiper arm to fall against the windshield, since it may chip or crack the windshield.

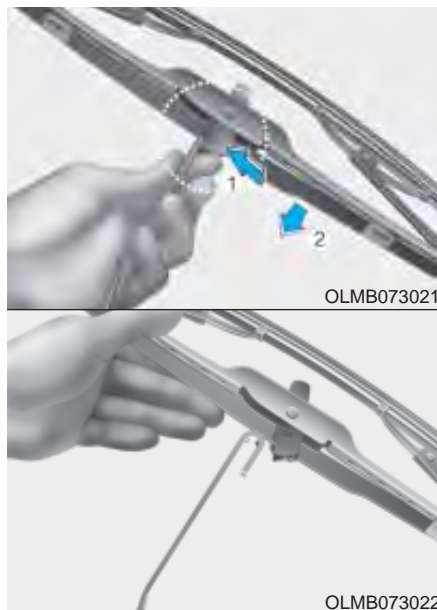

2. Compress the clip and slide the blade assembly downward.
3. Lift it off the arm.
4. Install the blade assembly in the reverse order of removal.



### Type B

1. Raise the wiper arm.

#### CAUTION

Do not allow the wiper arm to fall against the windshield, since it may chip or crack the windshield.

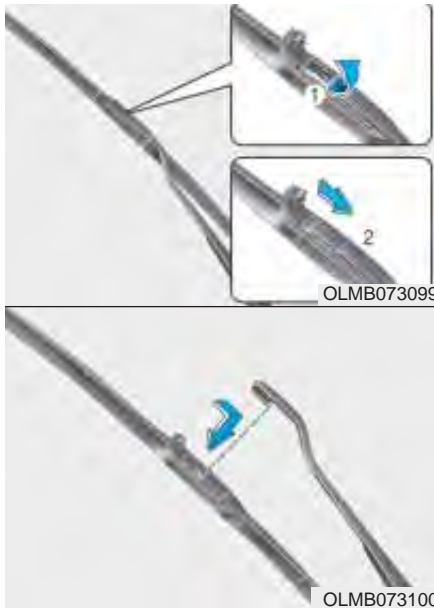

2. Lift up the wiper blade clip. Then pull down the blade assembly and remove it.
3. Install the new blade assembly in the reverse order of removal.

### Rear window wiper blade



1. Raise the wiper arm and pull out the wiper blade assembly.



2. Install the new blade assembly by inserting the center part into the slot in the wiper arm until it clicks into place.
3. Make sure the blade assembly is installed firmly by trying to pull it slightly.

To prevent damage to the wiper arms or other components, we recommend that the wiper blade be replaced by an authorized HYUNDAI dealer.

## BATTERY

### For best battery service



OTL075022

- Keep the battery securely mounted.
- Keep the battery top clean and dry.
- Keep the terminals and connections clean, tight, and coated with petroleum jelly or terminal grease.
- Rinse any spilled electrolyte from the battery immediately with a solution of water and baking soda.
- If the vehicle is not going to be used for an extended time, disconnect the battery cables.

### **i** Information

Basically equipped battery is maintenance free type. If your vehicle is equipped with the battery marked with LOWER and UPPER on the side, you can check the electrolyte level. The electrolyte level should be between LOWER and UPPER. If the electrolyte level is low, it needs to add distilled (demineralized) water (Never add sulfuric acid or other electrolyte). When refill, be careful not to splash the battery and adjacent components. And do not overfill the battery cells. It can cause corrosion on other parts. After then ensure that tighten the cell caps. We recommend that you contact an authorized HYUNDAI dealer.

### **⚠** WARNING

#### Battery dangers



Always read the following instructions carefully when handling a battery.



Keep lighted cigarettes and all other flames or sparks away from the battery.



Hydrogen, a highly combustible gas, is always present in battery cells and may explode if ignited.



Keep batteries out of the reach of children because batteries contain highly corrosive SULFURIC ACID. Do not allow battery acid to contact your skin, eyes, clothing or paint finish.

(Continued)



(Continued)



If any electrolyte gets into your eyes, flush your eyes with clean water for at least 15 minutes and get immediate medical attention. If electrolyte gets on your skin, thoroughly wash the contacted area. If you feel a pain or a burning sensation, get medical attention immediately.



Wear eye protection when charging or working near a battery. Always provide ventilation when working in an enclosed space.



An inappropriately disposed battery can be harmful to the environment and human health. Dispose the battery according to your local law(s) or regulation.

(Continued)

(Continued)

- When lifting a plastic-cased bat-

tery, excessive pressure on the case may cause battery acid to leak, resulting in personal injury. Lift with a battery carrier or with your hands on opposite corners.

- Never attempt to recharge the battery when the battery cables are connected.
- The electrical ignition system works with high voltage. Never touch these components with the engine running or the ignition switch is in the on position.

Failure to follow the above warnings can result in serious bodily injury or death.

 **CAUTION**

If you connect unauthorized electronic devices to the battery, the battery may be discharged. Never use unauthorized devices.

## Battery capacity label

■ Example



OLMB073072

\* The actual battery label in the vehicle may differ from the illustration.

1. CMF60L-BCI : The HYUNDAI model name of battery
2. 12V : The nominal voltage
3. 60Ah(20HR) : The nominal capacity (in Ampere hours)
4. 92RC : The nominal reserve capacity (in min.)
5. 550CCA : The cold-test current in amperes by SAE
6. 440A : The cold-test current in amperes by EN

## Battery recharging

Your vehicle has a maintenance-free, calcium-based battery.

- If the battery becomes discharged in a short time (because, for example, the headlights or interior lights were left on while the vehicle was not in use), recharge it by slow charging (trickle) for 10 hours.
- If the battery gradually discharges because of high electric load while the vehicle is being used, recharge it at 20-30A for two hours.

### WARNING

**When recharging the battery, observe the following precautions:**

- The battery must be removed from the vehicle and placed in an area with good ventilation.
- Do not allow cigarettes, sparks, or flame near the battery.
- Watch the battery during charging, and stop or reduce the charging rate if the battery cells begin gassing (boiling) violently or if the temperature of the electrolyte of any cell exceeds 49°C (120°F).
- Wear eye protection when checking the battery during charging.

(Continued)

(Continued)

- **Disconnect the battery charger in the following order.**
  1. **Turn off the battery charger main switch.**
  2. **Unhook the negative clamp from the negative battery terminal.**
  3. **Unhook the positive clamp from the positive battery terminal.**
- **Before performing maintenance or recharging the battery, turn off all accessories and stop the engine.**
- **The negative battery cable must be removed first and installed last when the battery is disconnected.**

### Reset items

Items should be reset after the battery has been discharged or the battery has been disconnected.

- Auto up/down window (See chapter 3)
- Sunroof (See chapter 3)
- Trip computer (See chapter 3)
- Climate control system (See chapter 3)

## TIRES AND WHEELS

### Tire care

For proper maintenance, safety, and maximum fuel economy, you must always maintain recommended tire inflation pressures and stay within the load limits and weight distribution recommended for your vehicle.

### Recommended cold tire inflation pressures

All tire pressures (including the spare) should be checked when the tires are cold. "Cold Tires" means the vehicle has not been driven for at least three hours or driven less than 1.6 km (1 mile).

Recommended pressures must be maintained for the best ride, top vehicle handling, and minimum tire wear.

For recommended inflation pressure refer to "Tire and wheels" in section 8.



All specifications (sizes and pressures) can be found on a label attached to the vehicle.

### WARNING

#### Tire underinflation

Severe underinflation (70 kPa (10 psi) or more) can lead to severe heat build-up, causing blowouts, tread separation and other tire failures that can result in the loss of vehicle control leading to severe injury or death. This risk is much higher on hot days and when driving for long periods at high speeds.

 CAUTION

- Underinflation also results in excessive wear, poor handling and reduced fuel economy. Wheel deformation also is possible. Keep your tire pressures at the proper levels. If a tire frequently needs refilling, we recommend that the tire be checked by an authorized HYUNDAI dealer.
- Overinflation produces a harsh ride, excessive wear at the center of the tire tread, and a greater possibility of damage from road hazards.

 CAUTION

- Warm tires normally exceed recommended cold tire pressures by 28 to 41 kPa (4 to 6 psi). Do not release air from warm tires to adjust the pressure or the tires will be underinflated.
- Be sure to reinstall the tire inflation valve caps. Without the valve cap, dirt or moisture could get into the valve core and cause air leakage. If a valve cap is missing, install a new one as soon as possible.

 WARNING

Tire inflation

Overinflation or underinflation can reduce tire life, adversely affect vehicle handling, and lead to sudden tire failure. This could result in loss of vehicle control and potential injury.

 CAUTION

Tire pressure

Always observe the following:

- Check tire pressure when the tires are cold. (After vehicle has been parked for at least three hours or hasn't been driven more than 1.6 km (1 mile) since start-up.)
- Check the pressure of your spare tire each time you check the pressure of other tires.
- Never overload your vehicle. Be careful not to overload a vehicle luggage rack if your vehicle is equipped with one.
- Worn, old tires can cause accidents. If your tread is badly worn, or if your tires have been damaged, replace them.

## Checking tire inflation pressure

Check your tires once a month or more.

Also, check the tire pressure of the spare tire.

### *How to check*

Use a good quality gage to check tire pressure. You can not tell if your tires are properly inflated simply by looking at them. Radial tires may look properly inflated even when they're underinflated.

Check the tire's inflation pressure when the tires are cold. - "Cold" means your vehicle has been sitting for at least three hours or driven no more than 1.6 km (1 mile).

Remove the valve cap from the tire valve stem. Press the tire gage firmly onto the valve to get a pressure measurement. If the cold tire inflation pressure matches the recommended pressure on the tire and loading information label, no further adjustment is necessary. If the pressure is low, add air until you reach the recommended amount.

If you overfill the tire, release air by pushing on the metal stem in the center of the tire valve. Recheck the tire pressure with the tire gage. Be sure to put the valve caps back on the valve stems. They help prevent leaks by keeping out dirt and moisture.

## WARNING

- **Inspect your tires frequently for proper inflation as well as wear and damage. Always use a tire pressure gauge.**
- **Tires with too much or too little pressure wear unevenly causing poor handling, loss of vehicle control, and sudden tire failure leading to accidents, injuries, and even death. The recommended cold tire pressure for your vehicle can be found in this manual and on the tire label located on the driver's side center pillar.**
- **Worn tires can cause accidents. Replace tires that are worn, show uneven wear, or are damaged.**
- **Remember to check the pressure of your spare tire. HYUNDAI recommends that you check the spare every time you check the pressure of the other tires on your vehicle.**

### Tire rotation

To equalize tread wear, it is recommended that the tires be rotated every 12,000 km (7,500 miles) or sooner if irregular wear develops.

During rotation, check the tires for correct balance.

When rotating tires, check for uneven wear and damage. Abnormal wear is usually caused by incorrect tire pressure, improper wheel alignment, out-of-balance wheels, severe braking or severe cornering. Look for bumps or bulges in the tread or side of tire. Replace the tire if you find either of these conditions. Replace the tire if fabric or cord is visible. After rotation, be sure to bring the front and rear tire pressures to specification and check lug nut tightness.

Refer to "Tire and wheels" in section 8.

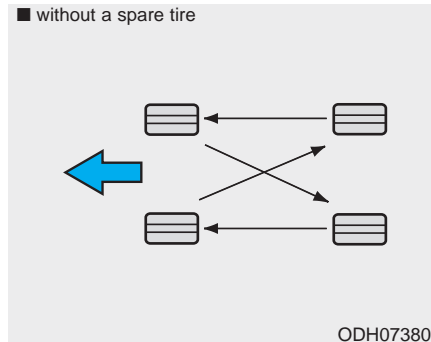

*Disc brake pads should be inspected for wear whenever tires are rotated.*

### **i** Information

The outside and inside of the unsymmetrical tire is distinguishable. When installing an unsymmetrical tire, be sure to install the side marked "outside" face the outside. If the side marked "inside" is installed on the outside, it will have a bad effect on vehicle performance.

### **⚠** WARNING

- Do not use the compact spare tire for tire rotation.
- Do not mix bias ply and radial ply tires under any circumstances. This may cause unusual handling characteristics that could result in death, severe injury, or property damage.

#### **4. *Tire ply composition and material***

The number of layers or plies of rubber-coated fabric are in the tire. Tire manufacturers also must indicate the materials in the tire, which include steel, nylon, polyester, and others. The letter "R" means radial ply construction; the letter "D" means diagonal or bias ply construction; and the letter "B" means belted-bias ply construction.

#### **5. *Maximum permissible inflation pressure***

This number is the greatest amount of air pressure that should be put in the tire. Do not exceed the maximum permissible inflation pressure. Refer to the Tire and Loading Information label for recommended inflation pressure.

#### **6. *Maximum load rating***

This number indicates the maximum load in kilograms and pounds that can be carried by the tire. When replacing the tires on the vehicle, always use a tire that has the same load rating as the factory installed tire.

#### **7. *Uniform tire quality grading***

Quality grades can be found where applicable on the tire sidewall between tread shoulder and maximum section width.

For example:

TREADWEAR 200  
TRACTION AA  
TEMPERATURE A

#### **Tread wear**

The tread wear grade is a comparative rating based on the wear rate of the tire when tested under controlled conditions on a specified government test course. For example, a tire graded 150 would wear one-and-a-half times (1½) as well on the government course as a tire graded 100.

The relative performance of tires depends upon the actual conditions of their use, however, and may depart significantly from the norm because of variations in driving habits, service practices and differences in road characteristics and climate.

These grades are molded on the side-walls of passenger vehicle tires. The tires available as standard or optional equipment on your vehicles may vary with respect to grade.



### Traction - AA, A, B & C

The traction grades, from highest to lowest, are AA, A, B and C. Those grades represent the tires ability to stop on wet pavement as measured under controlled conditions on specified government test surfaces of asphalt and concrete. A tire marked C may have poor traction performance.

#### WARNING

**The traction grade assigned to this tire is based on straight-ahead braking traction tests, and does not include acceleration, cornering, hydroplaning, or peak traction characteristics.**

### Temperature -A, B & C

The temperature grades are A (the highest), B and C representing the tire's resistance to the generation of heat and its ability to dissipate heat when tested under controlled conditions on a specified indoor laboratory test wheel.

Sustained high temperature can cause the material of the tire to degenerate and reduce tire life, and excessive temperature can lead to sudden tire failure. Grades B and A represent higher levels of performance on the laboratory test wheel than the minimum required by the law.

#### WARNING

##### Tire temperature

**The temperature grade for this tire is established for a tire that is properly inflated and not overloaded. Excessive speed, under-inflation, or excessive loading, either separately or in combination, can cause heat build-up and possible sudden tire failure. This can cause loss of vehicle control and serious injury or death.**

### Low aspect ratio tire (if equipped)

Low aspect ratio tires, whose aspect ratio is lower than 50, are provided for sporty looks.

Because the low aspect ratio tires are optimized for handling and braking, it may be more uncomfortable to ride in and there is more noise compare with normal tires.

#### CAUTION

**Because the sidewall of the low aspect ratio tire is shorter than the normal, the wheel and tire of the low aspect ratio tire is easier to be damaged. So, follow the instructions below.**

- When driving on a rough road or off road, drive cautiously because tires and wheels may be damaged. And after driving, inspect tires and wheels.
- When passing over a pothole, speed bump, manhole, or curb stone, drive slowly so that the tires and wheels are not damaged.
- If the tire is impacted, we recommend that you inspect the tire condition or contact an authorized HYUNDAI dealer.
- To prevent damage to the tire, inspect the tire condition and pressure every 3,000km.

#### CAUTION

- It is not easy to recognize the tire damage with your own eyes. But if there is the slightest hint of tire damage, even though you cannot see the tire damage with your own eyes, have the tire checked or replaced because the tire damage may cause air leakage from the tire.
- If the tire is damaged by driving on a rough road, off road, pothole, manhole, or curb stone, it will not be covered by the warranty.
- You can find out the tire information on the tire sidewall.

## FUSES

### ■ Blade type



Normal



Blown

### ■ Cartridge type



Normal



Blown

### ■ Multi fuse



Normal



Blown

### ■ Battery fuse terminal



Normal



Blown

OLF074075

A vehicle's electrical system is protected from electrical overload damage by fuses.

This vehicle has 2 (or 3) fuse panels, one located in the driver's side panel bolster, the other in the engine compartment near the battery.

If any of your vehicle's lights, accessories, or controls do not work, check the appropriate circuit fuse. If a fuse has blown, the element inside the fuse will be melted.

If the electrical system does not work, first check the driver's side fuse panel. Before replacing a blown fuse, turn the engine and all switches off, and then disconnect the negative battery cable. Always replace a blown fuse with one of the same rating.

If the replacement fuse blows, this indicates an electrical problem. Avoid using the system involved and immediately consult an authorized HYUNDAI dealer.

### **i** Information

**Three kinds of fuses are used: blade type for lower amperage rating, cartridge type and Multi fuse and Battery fuse terminal for higher amperage ratings.**

 **WARNING**

**Fuse replacement**

- Never replace a fuse with anything but another fuse of the same rating.
- A higher capacity fuse could cause damage and possibly a fire.
- Never install a wire or aluminum foil instead of the proper fuse - even as a temporary repair. It may cause extensive wiring damage and a possible fire.

 **CAUTION**

Do not use a screwdriver or any other metal object to remove fuses because it may cause a short circuit and damage the system.

**NOTICE**

The actual fuse/relay panel label may differ from equipped items.

 **CAUTION**

- When replacing a blown fuse or relay with a new one, make sure the new fuse or relay fits tightly into the clips. The incomplete fastening fuse or relay may cause the vehicle wiring and electric systems damage and a possible fire.
- Do not remove fuses, relays and terminals fastened with bolts or nuts. The fuses, relays and terminals may be fastened incompletely, and it may cause a possible fire. If fuses, relays and terminals fastened with bolts or nuts are blown, we recommend that you consult an authorized HYUNDAI dealer.
- Do not input any other objects except fuses or relays into fuse/relay terminals such as a driver or wiring. It may cause contact failure and system malfunction.

## Inner panel fuse replacement



1. Turn the engine and all other switches off.
2. Open the fuse panel cover.



3. Pull the suspected fuse straight out. Use the removal tool provided in the engine compartment fuse panel.
4. Check the removed fuse; replace it if it is blown.
5. Push in a new fuse of the same rating, and make sure it fits tightly in the clips.

If it fits loosely, we recommend that you consult an authorized HYUNDAI dealer.

## **i** Information

If you do not have a spare, use a fuse of the same rating from a circuit you may not need for operating the vehicle, such as the cigar lighter fuse.

If the headlights or other electrical components do not work and the fuses are OK, check the fuse block in the engine compartment. If a fuse is blown, it must be replaced with the same rating.

### Fuse switch



OTL075025

Always, place the fuse switch to the ON position.

If you move the switch to the OFF position, some items such as the audio system and digital clock must be reset and the smart key may not work properly.

### Information



OTLE045199

**If the fuse switch is OFF, the above message will appear.**

### CAUTION

- Always place the fuse switch in the ON position while driving the vehicle.
- Place the fuse switch in the OFF position when the vehicle is parked more than a month to prevent battery discharge.
- Do not move the transportation fuse switch repeatedly. The fuse switch may be damaged.

## Engine compartment panel fuse replacement



1. Turn the engine off and all other switches off.
2. Turn all the switches off.
3. Remove the fuse box cover by pressing the tab and pulling up.

4. Check the removed fuse; replace it if it is blown. To remove or insert the fuse, use the fuse puller in the engine compartment fuse panel.
5. Push in a new fuse of the same rating, and make sure it fits tightly in the clips. If it fits loosely, we recommend that you consult an authorized HYUNDAI dealer.

### CAUTION

**After checking the fuse box in the engine compartment, securely close the fuse box cover inside the engine compartment, until it clicks. If not, water may leak inside, possibly causing a malfunction with electric system.**

## Main fuse



If the main fuse is blown, it must be removed as follows:

1. Turn off the engine.
2. Disconnect the negative battery cable.
3. Remove the nuts shown in the picture above.
4. Replace the fuse with a new one of the same rating.
5. Reinstall in the reverse order of removal.

### **i** Information

If the main fuse is blown, even though the engine compartment panel fuse and inner fuse are not blown, if the electrical system is not operated, the main fuse may be blown. The main fuse is connected with other parts and system. We recommend that you contact an authorized HYUNDAI dealer.

### *Multi fuse*



If the multi fuse is blown, it must be removed as follows:

1. Disconnect the negative battery cable.
2. Remove the nuts shown in the picture above.
3. Replace the fuse with a new one of the same rating.
4. Reinstall in the reverse order of removal.











### **i** Information

If the multi fuse is blown, we recommend that you consult an authorized HYUNDAI dealer.

















Driver's side fuse panel

Fuse Name	Symbol	Fuse Rating	Circuit Protected
A/CON 1		7.5A	A/C Control Module, Cluste Ionizer, E/R Junction Block (RLY. 4/5/13 - PTC HEATER 3/PTC HEATER 2/Blower Relay)
RR WIPER		15A	Rear Wiper Motor, ICM Relay Box (Rear Wiper Relay)
MODULE 6		10A	BCM, Smart Key Control Module
WASHER		15A	Multifunction Switch (Wiper Low & Washer Switch)
MODULE 5		7.5A	BCM, Rear Parking Assist Sensor, ATM Shift Lever, 4WD ECM, Crash Pad Switch, Console Switch, Blind Spot Detection Radar LH/RH
A/BAG		15A	SRS Control Module
MODULE 1		10A	BCM, Smart Key Control Module, A/V & Navigation Head Unit, Audio, Monitor, Keyboard, AMP, Power Outside Mirror Switch
START		10A	[W/O Smart Key & IMMO.] ICM Relay Box (Burglar Alarm Relay) [With Smart Key / IMMO.] Transaxle Range Switch, ECM, Ignition Lock & Clutch Switch, Smart Key Control Module, E/R Junction Block (RLY. 11 - Start Relay)
MODULE 7		7.5A	Rear Seat Warmer, Front Air Ventilation Seat Control Module, Front Seat Warmer Control Module
HTD STRG		15A	BCM
MODULE 8		7.5A	Key Solenoid, Driver/Passenger Smart Key Outside Handle, Center Facia Switch, Driver/Passenger Power Outside Mirror

Fuse Name	Symbol	Fuse Rating	Circuit Protected
MODULE 4	<sup>4</sup> MODULE	7.5A	A/C Control Module, Crash Pad Switch, Electro Chromic Mirror, A/V & Navigation Head Unit, Data Link Connector, Rear Seat Warmer, Front Air Ventilation Seat Control Module, Front Seat Warmer Control Module, Auto Head Lamp Leveling Device Module, Head Lamp Leveling Device Actuator LH/RH
A/BAG IND	IND 	7.5A	Instrument Cluster
MODULE 3	<sup>3</sup> MODULE	10A	BCM, ATM Shift Lever, Stop Lamp Switch (GSL)
SMART KEY 1	<sup>1</sup> SMART KEY	15A	Smart Key Control Module
4WD		20A	4WD ECM
T/GATE OPEN		10A	[W/O Power Tail Gate] Tail Gate Latch [With Power Tail Gate] Power Tail Gate Latch
S/HEATER RR	RR 	15A	Rear Seat Warmer
MDPS	 1	7.5A	MDPS Unit
SMART KEY 3	<sup>3</sup> SMART KEY	7.5A	Immobilizer Module, Smart Key Control Module
CLUSTER	CLUSTER	7.5A	Instrument Cluster, ATM Shift Lever ILL.
C/LIGHTER		15A	Front Power Outlet & Cigarette Lighter
SMART KEY 2	<sup>2</sup> SMART KEY	10A	Immobilizer Module, Smart Key Control Module, Start/Stop Button Switch

Fuse Name	Symbol	Fuse Rating	Circuit Protected
MULTI MEDIA	<b>MULTI MEDIA</b>	15A	Audio, A/V & Navigation Head Unit, Monitor, Keyboard
INTERIOR LAMP		10A	Glove Box Lamp, Ignition Key Ill. & Door Warning Switch, Luggage Lamp, Front Vanity Lamp Switch LH/RH, Room Lamp, Overhead Console Lamp, Rear Personal Lamp LH/RH
DOOR LOCK		20A	Door Lock Relay, Door Unlock Relay
SUN ROOF 2	<sup>2</sup> 	20A	Panorama Sunroof
POWER OUTLET	<b>POWER OUTLET</b>	20A	Front Power Outlet & Cigarette Lighter
BRAKE SWITCH	<b>BRAKE SWITCH</b>	7.5A	Stop Lamp Switch, Smart Key Control Module
MEMORY 2	<sup>2</sup> <b>MEMORY</b>	10A	Auto Light & Photo Sensor, Data Link Connector, UIP Sensor A/C Control Module, Instrument Cluster, Electro Chromic Mirror, BCM, ICM Relay Box (Outside Mirror Folding/Unfolding Relay)
P/SEAT PASS	<sup>PASS</sup> 	30A	Passenger Seat Manual Switch
S/HEATER FRT	<sup>FRT</sup> 	20A	Front Air Ventilation Seat Control Module, Front Seat Warmer Control Module
SUN ROOF 1	<sup>1</sup> 	20A	Panorama Sunroof
MODULE 2	<sup>2</sup> <b>MODULE</b>	20A	PCB Block (Fuse - F45/F49/F50/F52/F53)
RR FOG LAMP	<sup>RR</sup> 	10A	ICM Relay Box (Rear Fog Lamp Relay)
A/CON 2	<sup>2</sup> 	7.5A	A/C Control Module

Fuse Name	Symbol	Fuse Rating	Circuit Protected
HTD MIRROR		10A	ECM (G4FJ), A/C Control Module, Driver/Passenger Power Outside Mirror
P/SEAT DRV	DRV 	30A	Driver Seat Manual Switch
SAFETY P/ WINDOW	SAFETY 	25A	Driver Safety Power Window Module
P/ WINDOW RH	RH 	25A	Power Window Main Switch, Passenger Power Window Switch
P/ WINDOW LH	LH 	25A	Power Window Main Switch
AMP	<b>AMP</b>	25A	AMP

### \* Traffic Change (For Europe)

The low beam light distribution is asymmetric. If you go abroad to a country with opposite traffic direction, this asymmetric part will dazzle oncoming car driver. To prevent dazzle, ECE regulation demand several technical solutions (ex. automatic change system, adhesive sheet, down aiming). These headlamps are designed not to dazzle opposite drivers. So, you need not change your headlamps in a country with opposite traffic direction.

### Headlamp, Static bending lamp, position lamp, turn signal lamp and fog lamp light bulb replacement

#### Type A



- (1) Headlamp (Low)
- (2) Headlamp (High)
- (3) Turn signal lamp
- (4) Position lamp
- (5) Daytime running lamp
- (6) Fog lamp

#### Type B



- (1) Headlamp (Low)
- (2) Headlamp (High)
- (3) Turn signal lamp
- (4) Position lamp
- (5) Daytime running lamp
- (6) Fog lamp
- (7) Static bending lamp  
(if equipped)



OLMB073042L

### Headlamp and Static bending lamp (Type B)

#### WARNING

- Handle halogen bulbs with care. Halogen bulbs contain pressurized gas that will produce flying pieces of glass that could cause injuries if broken.
- Wear eye protection when changing a bulb. Allow the bulb to cool down before handling it.

- Always handle them carefully, and avoid scratches and abrasions. If the bulbs are lit, avoid contact with liquids.
- Never touch the glass with bare hands. Residual oil may cause the bulb to overheat and burst when lit.
- A bulb should be operated only when installed in a headlamp.
- If a bulb becomes damaged or cracked, replace it immediately and carefully dispose of it.

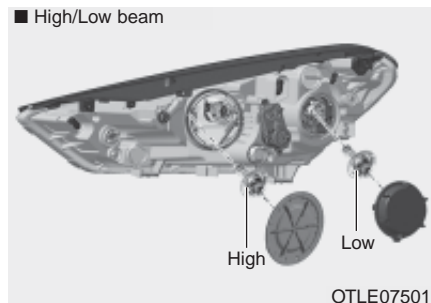

OTLE075013

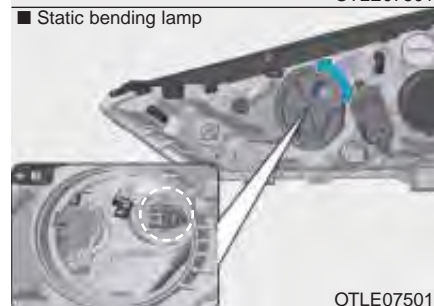

OTLE075015

1. Open the hood.
2. Disconnect the negative battery cable.
3. Remove the bulb cover by turning it counterclockwise.
4. Disconnect the bulb socket-connector.

5. Unsnap the bulb retaining wire by pressing the end and pushing it upward.
6. Remove the bulb from the headlamp assembly.
7. Install a new bulb and snap the bulb retaining wire into position by aligning the wire with the groove on the bulb.
8. Connect the bulb socket-connector.
9. Install the bulb cover by turning it clockwise.

### **i** Information

The headlamp aiming should be adjusted after an accident or after the headlamp assembly is reinstalled at an authorized HYUNDAI dealer.

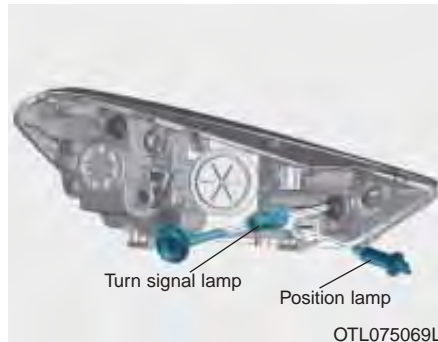

### **Turn signal lamp/Position lamp (Type A)**

1. Open the hood.
2. Disconnect the negative battery cable.
3. Remove the socket from the assembly by turning the socket counterclockwise until the tabs on the socket align with the slots on the assembly.
4. Remove the bulb from the socket by pressing it in and rotating it counterclockwise until the tabs on the bulb align with the slots in the socket. Pull the bulb out of the socket.

5. Insert a new bulb by inserting it into the socket and rotating it until it locks into place.
6. Install the socket in the assembly by aligning the tabs on the socket with the slots in the assembly.
7. Push the socket into the assembly and turn the socket clockwise.



### Front fog lamp



1. Remove the front bumper under cover.
2. Reach your hand into the back of the front bumper.
3. Disconnect the power connector from the socket.
4. Remove the bulb-socket from the housing by turning the socket counter clockwise until the tabs on the socket align with the slots on the housing.

### Position lamp(Type B)/Daytime running lamp

If the LED lamp does not operate, have the vehicle checked by an authorized HYUNDAI dealer.

### Type C



- (1) Headlamp (Low)
- (2) Headlamp (High)
- (3) Turn signal lamp
- (4) Position lamp
- (5) Daytime running lamp
- (6) Fog lamp
- (7) Static bending lamp



Headlamp (High, Halogen bulb)

### ⚠ WARNING

- Handle halogen bulbs with care. Halogen bulbs contain pressurized gas that will produce flying pieces of glass that could cause injuries if broken.
- Wear eye protection when changing a bulb. Allow the bulb to cool down before handling it.

- Always handle them carefully, and avoid scratches and abrasions. If the bulbs are lit, avoid contact with liquids.
- Never touch the glass with bare hands. Residual oil may cause the bulb to overheat and burst when lit.
- A bulb should be operated only when installed in a headlamp.
- If a bulb becomes damaged or cracked, replace it immediately and carefully dispose of it.

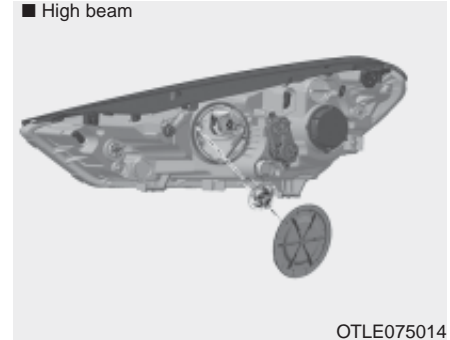

1. Open the hood.
2. Disconnect the negative battery cable.
3. Remove the bulb cover by turning it counterclockwise.
4. Disconnect the bulb socket-connector.
5. Unsnap the bulb retaining wire by pressing the end and pushing it upward.
6. Remove the bulb from the headlamp assembly.
7. Install a new bulb and snap the bulb retaining wire into position by aligning the wire with the groove on the bulb.

8. Connect the bulb socket-connector.
9. Install the bulb cover by turning it clockwise.

### Headlamp (Low, LED type)

If the LED lamp does not operate, have the vehicle checked by an authorized HYUNDAI dealer.

#### **i** Information

**The headlamp aiming should be adjusted after an accident or after the headlamp assembly is reinstalled at an authorized HYUNDAI dealer.**



### Turn signal lamp

1. Open the hood.
2. Disconnect the negative battery cable.
3. Remove the socket from the assembly by turning the socket counterclockwise until the tabs on the socket align with the slots on the assembly.
4. Remove the bulb from the socket by pressing it in and rotating it counterclockwise until the tabs on the bulb align with the slots in the socket. Pull the bulb out of the socket.

5. Insert a new bulb by inserting it into the socket and rotating it until it locks into place.
6. Install the socket in the assembly by aligning the tabs on the socket with the slots in the assembly.
7. Push the socket into the assembly and turn the socket clockwise.

### *Front fog lamp*



1. Remove the front bumper under cover.
2. Reach your hand into the back of the front bumper.
3. Disconnect the power connector from the socket.
4. Remove the bulb-socket from the housing by turning the socket counter clockwise until the tabs on the socket align with the slots on the housing.

### **Position lamp/Daytime running lamp/static bending lamp**

If the LED lamp does not operate, have the vehicle checked by an authorized HYUNDAI dealer.

## Side repeater lamp replacement

### Type A

If the light bulb does not operate,



have the vehicle checked by an authorized HYUNDAI dealer.

### Type B



1. Remove the lamp assembly from the vehicle by prying the lens and pulling the assembly out.
2. Disconnect the bulb electrical connector.
3. Separate the socket and the lens parts by turning the socket counterclockwise until the tabs on the socket align with the slots on the lens part.
4. Remove the bulb by pulling it straight out.
5. Insert a new bulb in the socket.

6. Reassemble the socket and the lens part.
7. Connect the bulb electrical connector.
8. Reinstall the lamp assembly to the body of the vehicle.

## Headlamp and front fog lamp aiming (For Europe)

### Headlamp aiming



1. Inflate the tires to the specified pressure and remove any loads from the vehicle except the driver, spare tire, and tools.
2. The vehicle should be placed on a flat floor.
3. Draw vertical lines (Vertical lines passing through respective head lamp centers) and a horizontal line (Horizontal line passing through center of head lamps) on the screen.

4. With the headlamp and battery in normal condition, aim the headlamps so the brightest portion falls on the horizontal and vertical lines.

5. To aim the low beam left or right, turn the driver clockwise or counterclockwise. To aim the low beam up or down, turn the driver clockwise or counterclockwise.

To aim the high beam up or down, turn the driver clockwise or counterclockwise.

### Front fog lamp aiming



The front fog lamp can be aimed as the same manner of the headlamps aiming.

With the front fog lamps and battery in normal condition, aim the front fog lamps.

To aim the front fog lamp up or down, turn the driver clockwise or counterclockwise.

## Aiming point

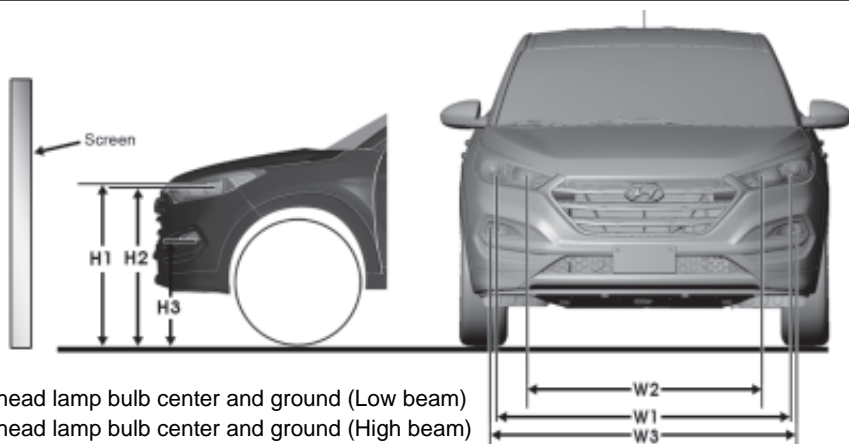

- H1 : Height between the head lamp bulb center and ground (Low beam)
- H2 : Height between the head lamp bulb center and ground (High beam)
- H3 : Height between the fog lamp bulb center and ground
- W1 : Distance between the two head lamp bulbs centers (Low beam)
- W2 : Distance between the two head lamp bulbs centers (High beam)
- W3 : Distance between the two fog lamp bulbs centers

OTLE075022

Unit: mm (in)

Vehicle condition	Lamp type	H1	H2	H3	W1	W2	W3
Without driver	Halogen/HID	886 (34.89)	862 (33.94)	578 (22.76)	1502 (59.13)	1208 (47.56)	1474 (58.03)
	LED	884 (34.80)			1494 (58.82)		
With driver	Halogen/HID	879 (34.60)	855 (33.66)	571 (22.48)	1502 (59.13)	1208 (47.56)	1474 (58.03)
	LED	877 (34.53)			1494 (58.82)		

### Headlamp low beam (LHD side)

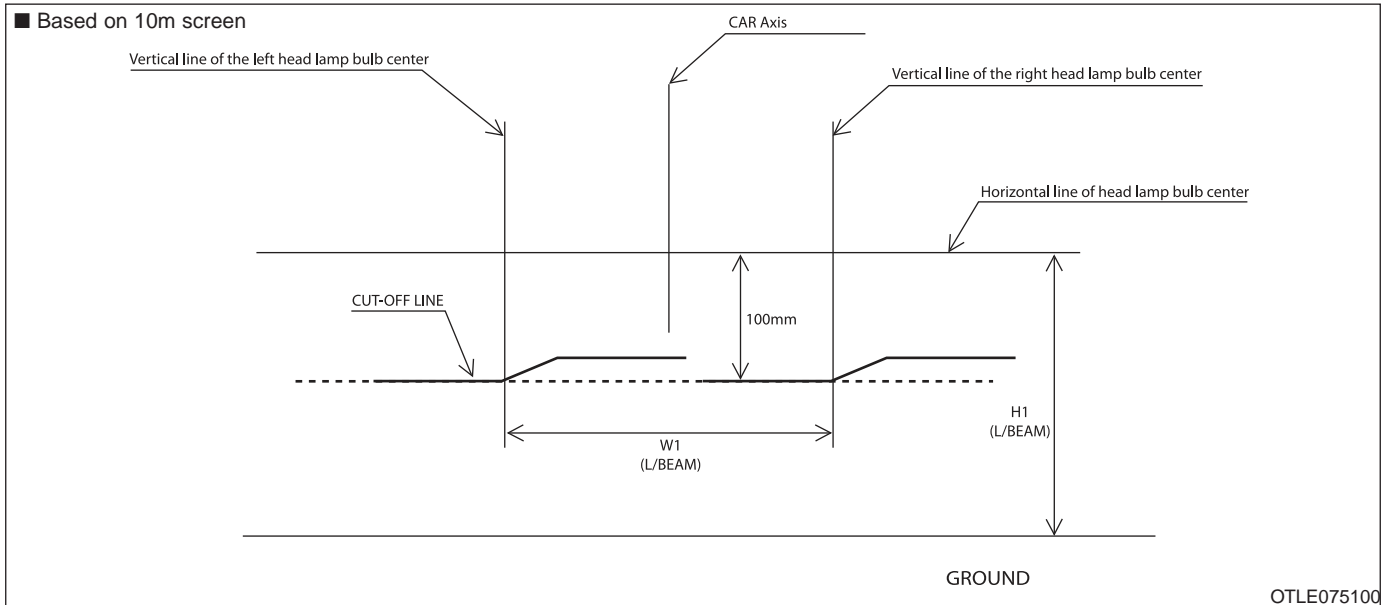

1. Turn the low beam on without driver aboard.
2. The cut-off line should be projected in the cut-off line shown in the picture.
3. When aiming the low beam, vertical aiming should be adjusted after adjusting the horizontal aiming.
4. If headlamp leveling device is equipped, adjust the head lamp leveling device switch with 0 positions.



## Headlamp low beam (RHD side)

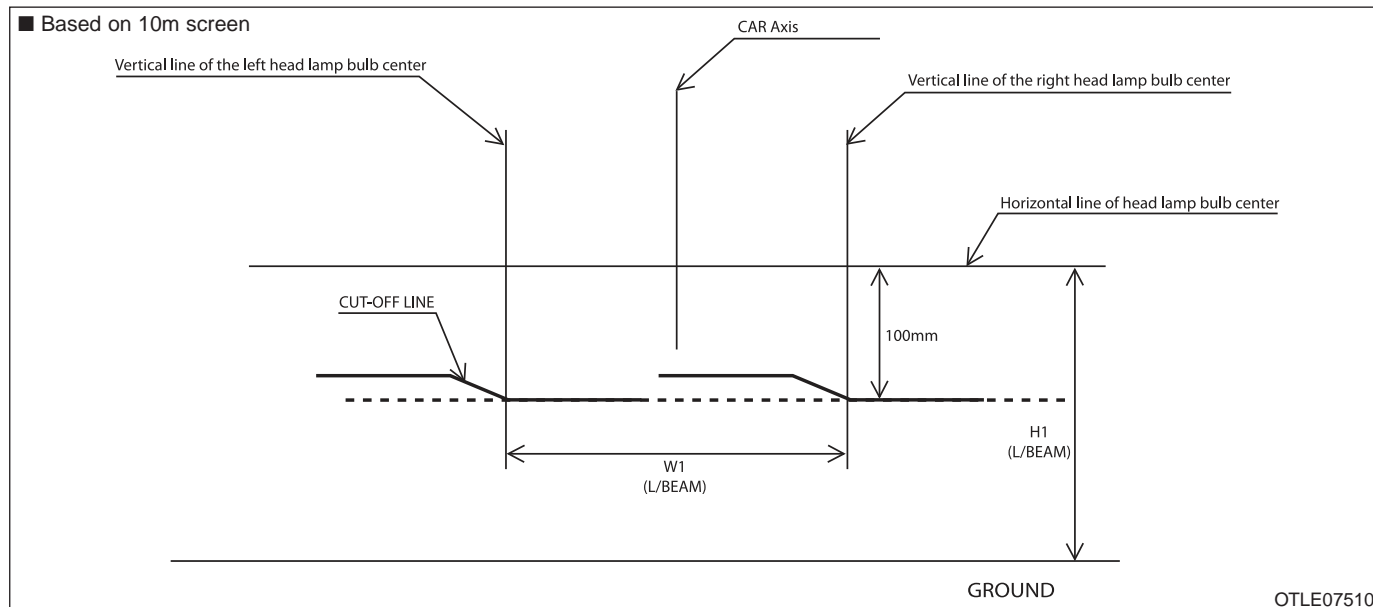

1. Turn the low beam on without driver aboard.
2. The cut-off line should be projected in the cut-off line shown in the picture.
3. When aiming the low beam, vertical aiming should be adjusted after adjusting the horizontal aiming.
4. If headlamp leveling device is equipped, adjust the head lamp leveling device switch with 0 positions.

### Front fog lamp

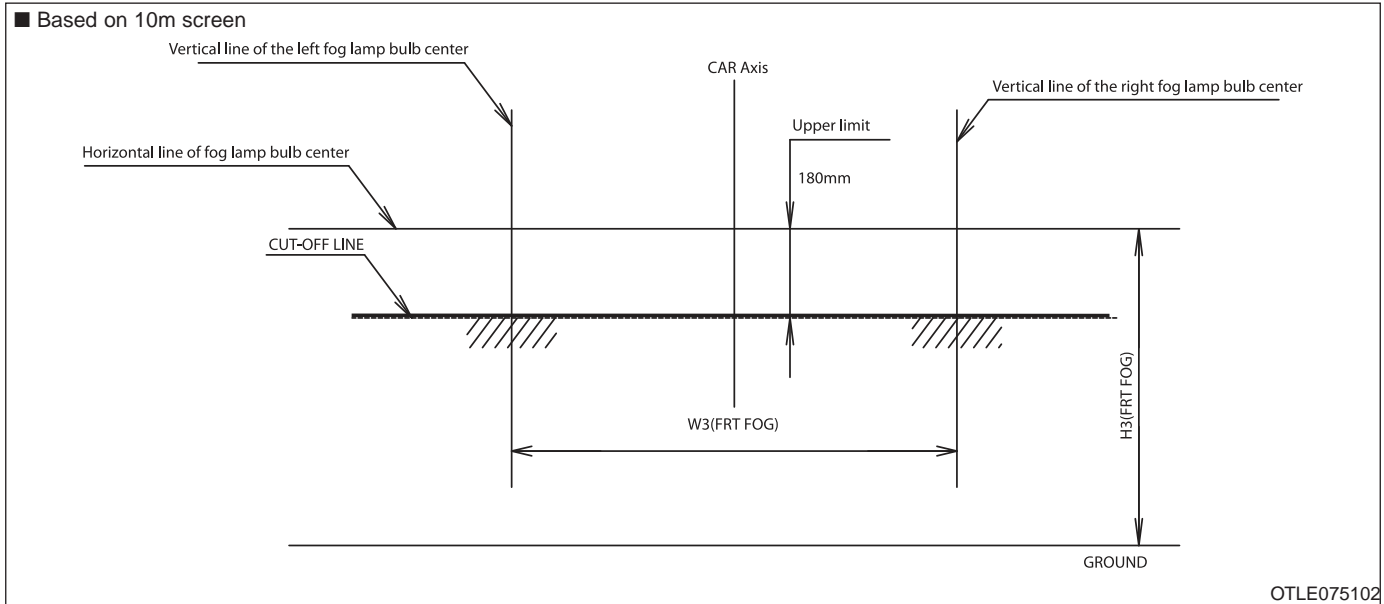

1. Turn the front fog lamp on without the driver aboard.
2. The cut-off line should be projected in the allowable range (shaded region).

## Rear combination light bulb replacement

■ Type A

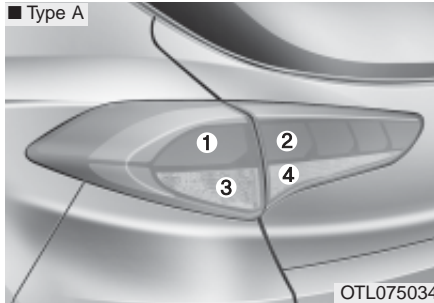

■ Type B

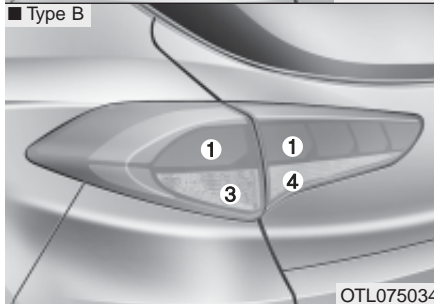

- (1) Stop/tail lamp
- (2) Tail lamp
- (3) Rear turn signal lamp
- (4) Back-up lamp

## Outside lamp

### Stop/tail Lamp and Turn signal lamp

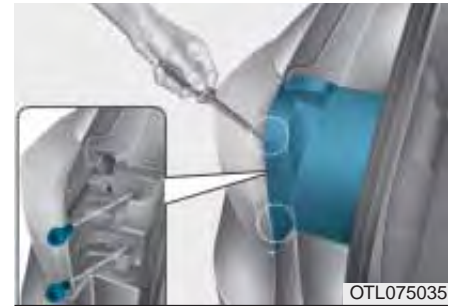

1. Turn off the engine.
2. Open the tailgate.

- Loosen the lamp assembly retaining screws with a cross-tip screwdriver.
- Remove the rear combination lamp assembly from the body of the vehicle.

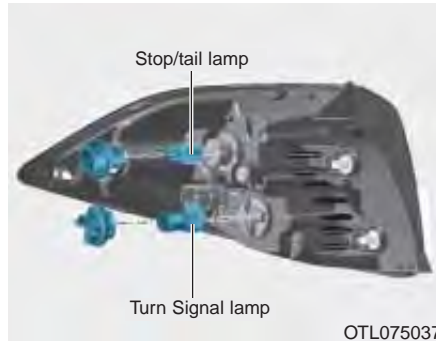

- Remove the socket from the assembly by turning the socket counterclockwise until the tabs on the socket align with the slots on the assembly.
- Remove the bulb from the socket by pressing it in and rotating it counterclockwise until the tabs on the bulb align with the slots in the socket. Pull the bulb out of the socket.
- Insert a new bulb by inserting it into the socket and rotating it until it locks into place.

- Install the socket in the assembly by aligning the tabs on the socket with the slots in the assembly.

Push the socket into the assembly and turn the socket clockwise.

- Reinstall the lamp assembly to the body of the vehicle.

### Stop/tail lamp (LED type)

If the LED stop and tail lamp does not operate, have the vehicle checked by an authorized HYUNDAI dealer.

## Inside lamp

### Tail lamp/Back-up lamp



1. Turn off the engine.
2. Open the tailgate.
3. Remove the service cover using a flat-blade screwdriver.



4. Remove the socket from the assembly by turning the socket counterclockwise until the tabs on the socket align with the slots on the assembly.
5. Pull the bulb out of the socket.
6. Insert a new bulb into the socket.
7. Install the socket into the assembly by aligning the tabs on the socket with the slots on the assembly and turning the socket clockwise.
8. Reinstall the lamp assembly to the body of the vehicle

### Stop and tail lamp (LED type)

If the LED stop and tail lamp does not operate, have the vehicle checked by an authorized HYUNDAI dealer.

### ***Rear fog lamp (if equipped)***

1. Remove the socket from the assembly by turning the socket counterclockwise until the tabs on the socket align with the slots on the assembly.
2. Remove the bulb from the socket by pressing it in and rotating it counterclockwise until the tabs on the bulb align with the slots in the socket. Pull the bulb out of the socket.
3. Insert a new bulb in the socket.
4. Reinstall the light assembly to the body of the vehicle.

### **High mounted stop lamp replacement**

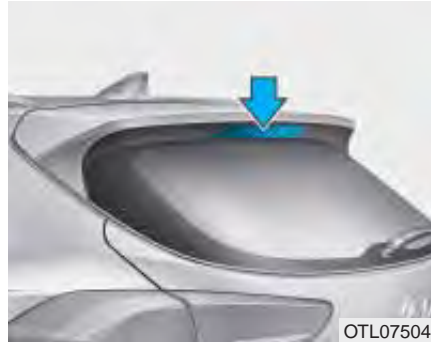

If the high mounted stop lamp does not operate, we recommend that you contact an authorized HYUNDAI dealer.

### **License plate light bulb replacement**



1. Loosen the lens retaining screws with a screwdriver.
2. Remove the lens.
3. Remove the bulb by pulling it straight out.
4. Install a new bulb.
5. Reinstall the lens securely with the lens retaining screws.

## Interior light bulb replacement Map lamp and Room lamp

■ Map lamp - with sunroof



■ Room lamp - with sunroof



## Map lamp, Room lamp, Vanity mirror lamp, Tailgate room lamp and glove box lamp

■ Map lamp - without sunroof



■ Room lamp - without sunroof



■ Vanity mirror lamp



■ Tailgate room lamp



If the LED lamp does not operate, have the vehicle checked by an authorized HYUNDAI dealer.

### ■ Glove box lamp



1. Using a flat-head screwdriver, gently pry the lens from the interior light housing.
2. Remove the bulb by pulling it straight out.
3. Install a new bulb in the socket.
4. Align the lens tabs with the interior light housing notches and snap the lens into place.

If the lamps do not operating, have the vehicle checked by an authorized HYUNDAI dealer.

### **NOTICE**

Use care not to dirty or damage lenses, lens tabs, and plastic housings.



## APPEARANCE CARE

### Exterior care

#### *Exterior general caution*

It is very important to follow the label directions when using any chemical cleaner or polish. Read all warning and caution statements that appear on the label.

#### *High-pressure washing*

- When using high-pressure washers, make sure to maintain sufficient distance from the vehicle.  
Insufficient clearance or excessive pressure can lead to component damage or water penetration.
- Do not spray the camera, sensors or its surrounding area directly with a high pressure washer. Shock applied from high pressure water may cause the device to not operate normally.
- Do not bring the nozzle tip close to boots (rubber or plastic covers) or connectors as they may be damaged if they come into contact with high pressure water.

#### *Finish maintenance*

##### *Washing*

To help protect your vehicle's finish from rust and deterioration, wash it thoroughly and frequently at least once a month with lukewarm or cold water.

If you use your vehicle for off-road driving, you should wash it after each off-road trip. Pay special attention to the removal of any accumulation of salt, dirt, mud, and other foreign materials. Make sure the drain holes in the lower edges of the doors and rocker panels are kept clear and clean.

Insects, tar, tree sap, bird droppings, industrial pollution and similar deposits can damage your vehicle's finish if not removed immediately.

Even prompt washing with plain water may not completely remove all these deposits.

A mild soap, safe for use on painted surfaces, may be used.

After washing, rinse the vehicle thoroughly with lukewarm or cold water. Do not allow soap to dry on the finish.

### CAUTION

- **Do not use strong soap, chemical detergents or hot water, and do not wash the vehicle in direct sunlight or when the body of the vehicle is warm.**
- **Be careful when washing the side windows of your vehicle. Especially, with high-pressure water, water may leak through the windows and wet the interior.**
- **To prevent damage to the plastic parts and lamps, do not clean with chemical solvents or strong detergents.**

**⚠ WARNING**

**Wet brakes**

After washing the vehicle, test the brakes while driving slowly to see if they have been affected by water. If braking performance is impaired, dry the brakes by applying them lightly while maintaining a slow forward speed.



**⚠ CAUTION**

- Water washing in the engine compartment including high pressure water washing may cause the failure of electrical circuits located in the engine compartment.
- Never allow water or other liquids to come in contact with electrical/electronic components inside the vehicle as this may damage them.

**Waxing**

Wax the vehicle when water will no longer bead on the paint. Always wash and dry the vehicle before waxing. Use a good quality liquid or paste wax, and follow the manufacturer's instructions. Wax all metal trim to protect it and to maintain its luster. Removing oil, tar, and similar materials with a spot remover will usually strip the wax from the finish. Be sure to re-wax these areas even if the rest of the vehicle does not yet need waxing.

**⚠ CAUTION**

- Wiping dust or dirt off the body with a dry cloth will scratch the finish.
- Do not use steel wool, abrasive cleaners, or strong detergents containing highly alkaline or caustic agents on chrome-plated or anodized aluminum parts. This may result in damage to the protective coating and cause discoloration or paint deterioration.

### ***Finish damage repair***

Deep scratches or stone chips in the painted surface must be repaired promptly. Exposed metal will quickly rust and may develop into a major repair expense.

#### **NOTICE**

**If your vehicle is damaged and requires any metal repair or replacement, be sure the body shop applies anti-corrosion materials to the parts repaired or replaced.**

### ***Bright-metal maintenance***

- To remove road tar and insects, use a tar remover, not a scraper or other sharp object.
- To protect the surfaces of bright-metal parts from corrosion, apply a coating of wax or chrome preservative and rub to a high luster.
- During winter weather or in coastal areas, cover the bright metal parts with a heavier coating of wax or preservative. If necessary, coat the parts with non-corrosive petroleum jelly or other protective compound.

### ***Underbody maintenance***

Corrosive materials used for ice and snow removal and dust control may collect on the underbody. If these materials are not removed, accelerated rusting can occur on underbody parts such as the fuel lines, frame, floor pan and exhaust system, even though they have been treated with rust protection.

Thoroughly flush the vehicle underbody and wheel openings with lukewarm or cold water once a month, after off-road driving and at the end of each winter. Pay special attention to these areas because it is difficult to see all the mud and dirt. It will do more harm than good to wet down the road grime without removing it. The lower edges of doors, rocker panels, and frame members have drain holes that should not be allowed to clog with dirt; trapped water in these areas can cause rusting.

### **WARNING**

After washing the vehicle, test the brakes while driving slowly to see if they have been affected by water. If braking performance is impaired, dry the brakes by applying them lightly while maintaining a slow forward speed.

### *Aluminum wheel maintenance*

The aluminum wheels are coated with a clear protective finish.

### **CAUTION**

- Do not use any abrasive cleaner, polishing compound, solvent, or wire brushes on aluminum wheels.
- Clean the wheel when it has cooled.
- Use only a mild soap or neutral detergent, and rinse thoroughly with water. Also, be sure to clean the wheels after driving on salted roads.
- Do not wash the wheels with high-speed car wash brushes.
- Do not use any cleanser containing acid or alkaline detergents.

### *Corrosion protection*

#### **Protecting your vehicle from corrosion**

By using the most advanced design and construction practices to combat corrosion, we produce cars of the highest quality. However, this is only part of the job. To achieve the long-term corrosion resistance your vehicle can deliver, the owner's cooperation and assistance is also required.

#### **Common causes of corrosion**

The most common causes of corrosion on your car are:

- Road salt, dirt and moisture that is allowed to accumulate underneath the car.
- Removal of paint or protective coatings by stones, gravel, abrasion or minor scrapes and dents which leave unprotected metal exposed to corrosion.

### High-corrosion areas

If you live in an area where your car is regularly exposed to corrosive materials, corrosion protection is particularly important. Some of the common causes of accelerated corrosion are road salts, dust control chemicals, ocean air and industrial pollution.

### Moisture breeds corrosion

Moisture creates the conditions in which corrosion is most likely to occur. For example, corrosion is accelerated by high humidity, particularly when temperatures are just above freezing. In such conditions, the corrosive material is kept in contact with the car surfaces by moisture that is slow to evaporate.

Mud is particularly corrosive because it is slow to dry and holds moisture in contact with the vehicle. Although the mud appears to be dry, it can still retain the moisture and promote corrosion.

High temperatures can also accelerate corrosion of parts that are not properly ventilated so the moisture can be dispersed. For all these reasons, it is particularly important to keep your car clean and free of mud or accumulations of other materials. This applies not only to the visible surfaces but particularly to the underside of the car.

### To help prevent corrosion

You can help prevent corrosion from getting started by observing the following:

### Keep your car clean

The best way to prevent corrosion is to keep your car clean and free of corrosive materials. Attention to the underside of the car is particularly important.

- If you live in a high-corrosion area — where road salts are used, near the ocean, areas with industrial pollution, acid rain, etc.—, you should take extra care to prevent corrosion. In winter, hose off the underside of your car at least once a month and be sure to clean the underside thoroughly when winter is over.
- When cleaning underneath the car, give particular attention to the components under the fenders and other areas that are hidden from view. Do a thorough job; just dampening the accumulated mud rather than washing it away will accelerate corrosion rather than prevent it. Water under high pressure and steam are particularly effective in removing accumulated mud and corrosive materials.

- When cleaning lower door panels, rocker panels and frame members, be sure that drain holes are kept open so that moisture can escape and not be trapped inside to accelerate corrosion.

### **Keep your garage dry**

Don't park your car in a damp, poorly ventilated garage. This creates a favorable environment for corrosion. This is particularly true if you wash your car in the garage or drive it into the garage when it is still wet or covered with snow, ice or mud. Even a heated garage can contribute to corrosion unless it is well ventilated so moisture is dispersed.

### **Keep paint and trim in good condition**

Scratches or chips in the finish should be covered with "touch-up" paint as soon as possible to reduce the possibility of corrosion. If bare metal is showing through, the attention of a qualified body and paint shop is recommended.

**Bird droppings :** Bird droppings are highly corrosive and may damage painted surfaces in just a few hours. Always remove bird droppings as soon as possible.

### **Don't neglect the interior**

Moisture can collect under the floor mats and carpeting to cause corrosion. Check under the mats periodically to be sure the carpeting is dry. Use particular care if you carry fertilizers, cleaning materials or chemicals in the car.

These should be carried only in proper containers and any spills or leaks should be cleaned up, flushed with clean water and thoroughly dried.

## Interior care

### *Interior general precautions*

Prevent chemicals such as perfume, cosmetic oil, sun cream, hand cleaner and air freshener from contacting the interior parts because they may cause damage or discoloration. If they do contact the interior parts, wipe them off immediately.

See the instructions that follow for the proper way to clean vinyl.

#### CAUTION

**Never allow water or other liquids to come in contact with electrical/electronic components inside the vehicle as this may damage them.**

#### CAUTION

**When cleaning leather products (steering wheel, seats etc.), use neutral detergents or low alcohol content solutions. If you use high alcohol content solutions or acid/alkaline detergents, the color of the leather may fade or the surface may get stripped off.**

### *Cleaning the upholstery and interior trim*

#### **Vinyl**

Remove dust and loose dirt from vinyl with a whisk broom or vacuum cleaner. Clean vinyl surfaces with a vinyl cleaner.

#### **Fabric**

Remove dust and loose dirt from fabric with a whisk broom or vacuum cleaner. Clean with a mild soap solution recommended for upholstery or carpets. Remove fresh spots immediately with a fabric spot cleaner. If fresh spots do not receive immediate attention, the fabric can be stained and its color can be affected. Also, its fire-resistant properties can be reduced if the material is not properly maintained.

#### CAUTION

**Using anything but recommended cleaners and procedures may affect the fabric's appearance and fire-resistant properties.**

### ***Cleaning the lap/shoulder belt webbing***

Clean the belt webbing with any mild soap solution recommended for cleaning upholstery or carpet. Follow the instructions provided with the soap. Do not bleach or re-dye the webbing because this may weaken it.

### ***Cleaning the interior window glass***

If the interior glass surfaces of the vehicle become fogged (that is, covered with an oily, greasy or waxy film), they should be cleaned with glass cleaner. Follow the directions on the glass cleaner container.



#### **CAUTION**

**Do not scrape or scratch the inside of the rear window. This may result in damage to the rear window defroster grid.**



## EMISSION CONTROL SYSTEM

The emission control system of your vehicle is covered by a written limited warranty. Please see the warranty information contained in the Service Passport in your vehicle.

Your vehicle is equipped with an emission control system to meet all emission regulations.

There are three emission control systems which are as follows.

- (1) Crankcase emission control system
- (2) Evaporative emission control system
- (3) Exhaust emission control system

In order to assure the proper function of the emission control systems, it is recommended that you have your car inspected and maintained by an authorized HYUNDAI dealer in accordance with the maintenance schedule in this manual.

### CAUTION

#### **For the Inspection and Maintenance Test (With Electronic Stability Control (ESC) system)**

- **To prevent the vehicle from mis-firing during dynamometer testing, turn the Electronic Stability Control (ESC) system off by pressing the ESC switch.**
- **After dynamometer testing is completed, turn the ESC system back on by pressing the ESC switch again.**

### 1. Crankcase emission control system

The positive crankcase ventilation system is employed to prevent air pollution caused by blow-by gases being emitted from the crankcase. This system supplies fresh filtered air to the crankcase through the air intake hose. Inside the crankcase, the fresh air mixes with blow-by gases, which then pass through the PCV valve into the induction system.

### 2. Evaporative emission control system

The Evaporative Emission Control System is designed to prevent fuel vapors from escaping into the atmosphere.

### **Canister**

Fuel vapors generated inside the fuel tank are absorbed and stored in the onboard canister. When the engine is running, the fuel vapors absorbed in the canister are drawn into the surge tank through the purge control solenoid valve.

### **Purge Control Solenoid Valve (PCSV)**

The purge control solenoid valve is controlled by the Engine Control Module (ECM); when the engine coolant temperature is low during idling, the PCSV closes so that evaporated fuel is not taken into the engine. After the engine warms-up during ordinary driving, the PCSV opens to introduce evaporated fuel to the engine.

### **3. Exhaust emission control system**

The Exhaust Emission Control System is a highly effective system which controls exhaust emissions while maintaining good vehicle performance.

#### **Vehicle modifications**

This vehicle should not be modified. Modification of your vehicle could affect its performance, safety or durability and may even violate governmental safety and emissions regulations.

In addition, damage or performance problems resulting from any modification may not be covered under warranty.

- If you use unauthorized electronic devices, it may cause the vehicle to operate abnormally, wire damage, battery discharge and fire. For your safety, do not use unauthorized electronic devices.

#### **Engine exhaust gas precautions (carbon monoxide)**

- Carbon monoxide can be present with other exhaust fumes. Therefore, if you smell exhaust fumes of any kind inside your vehicle, have it inspected and repaired immediately. If you ever suspect exhaust fumes are coming into your vehicle, drive it only with all the windows fully open. Have your vehicle checked and repaired immediately.

**⚠ WARNING**

**Exhaust**

Engine exhaust gases contain carbon monoxide (CO). Though colorless and odorless, it is dangerous and could be lethal if inhaled. Follow the instructions following to avoid CO poisoning.

- Do not operate the engine in confined or closed areas (such as garages) any more than what is necessary to move the vehicle in or out of the area.
- When the vehicle is stopped in an open area for more than a short time with the engine running, adjust the ventilation system (as needed) to draw outside air into the vehicle.
- Never sit in a parked or stopped vehicle for any extended time with the engine running.
- When the engine stalls or fails to start, excessive attempts to restart the engine may cause damage to the emission control system.

***Operating precautions for catalytic converters (if equipped)***

**⚠ WARNING**

**Fire**

- A hot exhaust system can ignite flammable items under your vehicle. Do not park, idle, or drive the vehicle over or near flammable objects, such as dry grass, paper, leaves, etc.
- The exhaust system and catalytic system are very hot while the engine is running or immediately after the engine is turned off. Keep away from the exhaust system and catalytic, you may get burned.

Also, do not remove the heat sink around the exhaust system, do not seal the bottom of the vehicle or do not coat the vehicle for corrosion control. It may present a fire risk under certain conditions.

Your vehicle is equipped with a catalytic converter emission control device.

Therefore, the following precautions must be observed:



### CAUTION

- Use only UNLEADED FUEL for gasoline engine.
- Do not operate the vehicle when there are signs of engine malfunction, such as misfire or a noticeable loss of performance.
- Do not misuse or abuse the engine. Examples of misuse are coasting with the ignition off and descending steep grades in gear with the ignition off.

(Continued)

### (Continued)

- Do not operate the engine at high idle speed for extended periods (5 minutes or more).
- Do not modify or tamper with any part of the engine or emission control system. All inspections and adjustments must be made by an authorized HYUNDAI dealer.
- Avoid driving with a very low fuel level. If you run out of gasoline, it could cause the engine to misfire and result in excessive loading of the catalytic converter.

Failure to observe these precautions could result in damage to the catalytic converter and to your vehicle. Additionally, such actions could void your warranties.

### ***Diesel particulate filter (DPF) (if equipped)***

The Diesel Particulate Filter (DPF) system removes the soot in the exhaust gas.

The DPF system automatically burns (or oxidizes) the accumulated soot in accordance with the driving situations, unlike a disposable air filter.

In other words, the accumulated soot is automatically purged out by the engine control system and by the high exhaust-gas temperature at normal/high driving speeds.

However, when the vehicle is continually driven at repeated short distance or driven at low speed for a long time, the accumulated soot may not be automatically removed because of low exhaust gas temperature. In this case, the accumulated soot is out of the detection range, the soot oxidization process does not occur, and the Malfunction Indicator Lamp () illuminates.

The Malfunction Indicator Lamp (MIL) stops illuminating, when the driving speed exceeds 60 km/h (37mph), or when the engine rpm is between 1,500 and 2,500 with the gear in the 2nd position or above for approximately 25 minutes.

When the MIL continuously blinks or the warning message "Check exhaust system" illuminates in the above cases, we recommend you to have the DPF system checked by an authorized HYUNDAI dealer.

When the vehicle is continuously driven with the MIL flashing for an extended period of time, it may damage the DPF system and lower the fuel economy.

### **CAUTION**

#### **Diesel Fuel (if equipped with DPF)**

**We recommend you to use only the regulated diesel fuels, when your vehicle is equipped with the DPF system.**

**When you use other diesel fuels, which is high in sulfurs (above 50 ppm) or contains unspecified additives, it may damage the DPF system and cause the white smoke emission.**

### ***Lean NOx Trap (if equipped)***

The Lean NOx Trap (LNT) system removes the nitrogen oxide in the exhaust gas. The smell can occur in the exhaust gas depending on the quality of the fuel and it can degrade NOx reduction performance, please use the regulated automotive diesel fuel.

## Specifications & Consumer information

Dimensions .....	10-2
Engine .....	10-2
Bulb wattage .....	10-3
Tires and wheels .....	10-5
Load and speed capacity tires (For Europe) ..	10-6
Gross vehicle weight .....	10-7
Luggage volume .....	10-7
Recommended lubricants and capacities .....	10-8
Recommended engine oil (For Europe) .....	10-10
Recommended sae viscosity number .....	10-11
Vehicle identification number (VIN) .....	10-12
Vehicle certification label .....	10-12
Tire specification and pressure label .....	10-13
Engine number .....	10-13
Air conditioner compressor label .....	10-14
Refrigerant label .....	10-14
Declaration of conformity .....	10-14

## DIMENSIONS

item	mm (in)	
Overall length	4,475 (176.18)	
Overall width	1,850 (72.83)	
Overall height	1655 (65.16) / 1660 (65.35)* <sup>1</sup>	
Front tread	225/60 R17	1608 (63.31)
	225/55 R18	
Rear tread	225/60 R17	1,620 (63.78)
	225/55 R18	
Wheelbase	2,670 (105.12)	

\*<sup>1</sup> with roof rack

## ENGINE

Item		Nu 2.0 MPI	R 2.0 TCI
Displacement	cc (cu. in)	1,999 (121.98)	1,995 (121.74)
Bore x Stroke	mm (in.)	81x97 (3.18x3.82)	84X90 (3.30X3.54)
Firing order		1-3-4-2	1-3-4-2
No. of cylinders		4, in-line	4, In-line



## BULB WATTAGE

Light Bulb			Bulb type	Wattage	
Front	Headlamp	Low	Type A, B	H7L	55
			Type C	LED	LED
		High	H7L	55	
	Turn signal lamp		PY21W	21	
	Position lamp	Type A	W5W	5	
		Type B, C	LED	LED	
	Static bending lamp (SBL)*	Type B	H7L	55	
		Type C	LED	LED	
	Fog lamp*		H8L	35	
	Daytime running lamp (DRL)*		LED	LED	
Side Repeater lamp (Outside mirror)	Type A	LED	LED		
	Type B	WY5W	5		
Rear	Rear combination lamp	Type A	Stop/Tail	21/5W	21/5
			Tail	21/5W	21/5
			Turn signal	PY21W	21
			Back up	W16W	16
		Type B	Stop/Tail	LED	LED
			Turn signal	PY21W	21
			Back up	W16W	W16W
	High mounted stop lamp		LED	LED	
	License plate lamp		W5W	5	
	Fog lamp*		P21W	21	

\* If equipped





(Continued)

(Continued)

Light Bulb		Bulb type	Wattage
Interior	Map lamp	with sunroof*	LED
		without sunroof	WEDGE
	Room lamp	with sunroof*	LED
		without sunroof	FESTOON
	Sunvisor lamp	FESTOON	5
	Tailgate room lamp	FESTOON	10
Glove box lamp	W5W	5	
ETC	Puddle lamp	LED	LED

\* If equipped

## TIRES AND WHEELS

Item	Tire size	Wheel size	Inflation pressure bar (psi, kPa)				Wheel lug nut torque kgf·m (lbf·ft, N·m)
			Normal load (  +  )		Maximum load (  +  )		
			Front	Rear	Front	Rear	
Full size tire	225/60 R17	7.0J X 17	2.4	2.4	2.4	2.4	11~13 (88~107)
	225/55 R18	7.0J X 18	(240, 35)	(240, 35)	(240, 35)	(240, 35)	
Compact spare tire (if equipped)	T155/90 D16	4.0T X 16	4.2	4.2	4.2	4.2	
			(420, 60)	(420, 60)	(420, 60)	(420, 60)	

### CAUTION

When replacing tires, use the same size originally supplied with the vehicle.  
Using tires of a different size can damage the related parts or make it work irregularly.

### NOTICE

- It is permissible to add 20 kPa (3 psi) to the standard tire pressure specification if colder temperatures are expected soon. Tires typically lose 7 kPa (1 psi) for every 7°C (12°F) temperature drop. If extreme temperature variations are expected, recheck your tire pressure as necessary to keep them properly inflated.
- An air pressure generally decreases, as you drive up to a high-altitude area above sea level. Thus, if you plan to drive a high-altitude area, check the tire pressures in advance. If necessary, inflate them to a proper level (Air inflation per altitude: +10 kPa/1 km (+2.4 psi/1 mile)).

## GROSS VEHICLE WEIGHT

Kg

Items	Nu 2.0 MPI (Petrol)		R 2.0 TCI (Diesel)	
	M/T	A/T	M/T	A/T
Gross vehicle weight      kg	2,010	2,020	2,140	2,170

## LUGGAGE VOLUME

Item		5 Seater	
		Full size tire	Compact spare tire (if equipped)
VDA	MIN	488 l (17.23 cu ft)	513 l (18.12 cu ft)
	MAX	1478 l (52.20 cu ft)	1503 l (53.08 cu ft)

Min : Behind rear seat to upper edge of the seat back.

Max : Behind front seat to roof.

## RECOMMENDED LUBRICANTS AND CAPACITIES

To help achieve proper engine and powertrain performance and durability, use only lubricants of the proper quality. The correct lubricants also help promote engine efficiency that results in improved fuel economy.

These lubricants and fluids are recommended for use in your vehicle.

Lubricant		Volume	Classification	
Engine oil *1 *2 *6 (drain and refill)	Petrol Engine	4.0 l	API SM*4 & ILSAC GF-4 (or above) ACEA A5*3 (or above)	
	Diesel Engine	7.6 l	with DPF	ACEA C2 or C3*5
			without DPF	ACEA B4*5
Manual transaxle fluid	Petrol Engine	2WD : 1.7~1.8 l 4WD* : 1.6~1.7 l	API GL-4 SAE 75W-85	
	Diesel Engine	1.8~1.9 l		
Automatic transaxle fluid	Petrol Engine	2WD	SK ATF SP-IV, NOCA ATF SP-IV, HYUNDAI genuine ATF SP-IV	
		4WD*		
	Diesel Engine	7.8 l		
Engine Coolant	Petrol Engine M/T	7.0 l	Mixture of antifreeze and water (Phosphate-based Ethylene glycol coolant for aluminum radiator)	
	Petrol Engine A/T	6.8 l		
	Diesel Engine	8.5~8.8 l		

## Specifications & Consumer information

Brake/Clutch fluid		0.7~0.8 l	DOT-3 or DOT-4 (Do not mix DOT3 & DOT4 brake/clutch fluids)
Rear differential oil (4WD)		0.53~0.63 l	HYPOID GEAR OIL API GL-5, SAE75W/90 (SHELL HD AXLE OIL 75W90 or equivalent)
Transfer case oil (4WD)*	Petrol Engine M/T	0.48~0.52 l	
	Petrol Engine A/T	0.34~0.36 l	
	Diesel Engine		
Fuel		62 l (65.51 US qt.)	Refer to "Fuel requirements" in foreword section

M/T : Manual transaxle

A/T : Automatic transaxle

\*If available in petrol engine

\*1 : Refer to the recommended SAE viscosity numbers on the next page.

\*2 : Engine oils labeled Energy Conserving Oil are now available. Along with other additional benefits, they contribute to fuel economy by reducing the amount of fuel necessary to overcome engine friction. Often, these improvements are difficult to measure in everyday driving, but in a year's time, they can offer significant cost and energy savings.

\*3 : If the ACEA A5 engine oil is not available in your country, you are able to use ILSAC GF-3 (or above) or ACEA A3 (or above).

\*4 : If the API service SM engine oil is not available in your country, you are able to use API service SL.

\*5 : If the ACEA C2 or C3, B4 engine oil is not available in your country, you are able to use API CH-4 (or above).

\*6 : We recommend that you use the engine oils approved by HYUNDAI Motor India Ltd. We recommend that you consult an authorized HYUNDAI dealer for details

## Recommended SAE viscosity number

### ⚠ CAUTION

Always be sure to clean the area around any filler plug, drain plug, or dipstick before checking or draining any lubricant. This is especially important in dusty or sandy areas and when the vehicle is used on unpaved roads. Cleaning the plug and dipstick areas will prevent dirt and grit from entering the engine and other mechanisms that could be damaged.

Engine oil viscosity (thickness) has an effect on fuel economy and cold weather operating (engine start and engine oil flowability). Lower viscosity engine oils can provide better fuel economy and cold weather performance, however, higher viscosity engine oils are required for satisfactory lubrication in hot weather. Using oils of any viscosity other than those recommended could result in engine damage.

When choosing an oil, consider the range of temperature your vehicle will be operated in before the next oil change. Proceed to select the recommended oil viscosity from the chart.

		Temperature Range for SAE Viscosity Numbers									
Temperature	°C (°F)	-30	-20	-10	0	10	20	30	40	50	
		-10	0	20	40	60	80	100	120		
Gasoline Engine Oil	2.0 MPI (Except Middle East & Europe)	20W-50									
		15W-40									
		10W-30									
	5W-20 <sup>*1</sup> , 5W-30										
	1.6 T-GDI, 2.0 MPI (For Middle East <sup>*3</sup> )	20W-50									
		15W-40									
10W-30											
5W-30 <sup>*2</sup> , 5W-40											
2.0 MPI (For Europe)	0W-40, 5W-20, 5W-30, 5W-40										
Diesel Engine Oil	2.0 TCI	15W-40									
		10W-30/40									
		5W-30/40									
		0W-30/40									

<sup>\*1</sup> : For better fuel economy, it is recommended to use the engine oil of a viscosity grade SAE 5W-20.

<sup>\*2</sup> : For better fuel economy, it is recommended to use the engine oil of a viscosity grade SAE 5W-30. However, if the engine oil is not available in your country, select the proper engine oil using the engine oil viscosity chart.

<sup>\*3</sup> : Middle East includes Libya, Morocco, Sudan and Iran.

## VEHICLE IDENTIFICATION NUMBER (VIN)

■ Frame number



The vehicle identification number (VIN) is the number used in registering your vehicle and in all legal matters pertaining to its ownership, etc. The number is punched on the floor under the passenger seat. To check the number, open the cover.

■ VIN label (if equipped)



The VIN is also on a plate attached to the top of the dashboard. The number on the plate can easily be seen through the windshield from outside.

## VEHICLE CERTIFICATION LABEL



The vehicle certification label attached on the driver's (or front passenger's) side center pillar gives the vehicle identification number (VIN).



## TIRE SPECIFICATION AND PRESSURE LABEL

■ Left-hand drive

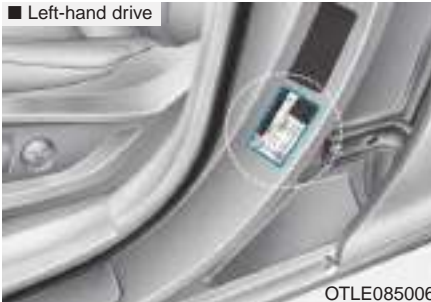

OTLE085006

■ Right-hand drive



OTLE085006R

The tires supplied on your new vehicle are chosen to provide the best performance for normal driving.

The tire label located on the driver's side center pillar gives the tire pressures recommended for your vehicle.

## ENGINE NUMBER

■ 2.0 MPI

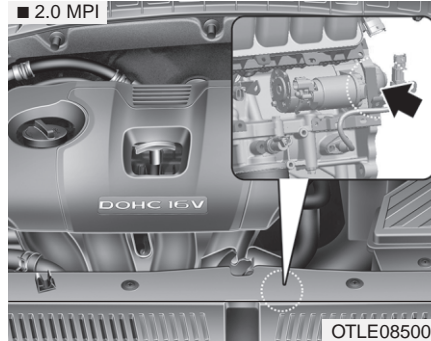

OTLE085007

■ 2.0 TCI

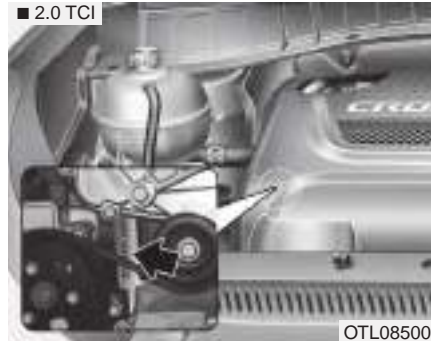

OTL085003

The engine number is stamped on the engine block as shown in the drawing.