

Rear seats

The modular seats allow you to make space from the boot to transport items.

» 85

Tailgate

The split tailgate enables the loading of items depending on their size and the available space in the rear of the vehicle.

» 74



Rear parking assistance signal

This function warns you if an obstacle is detected behind the vehicle whilst reversing.

» 72

Lower tailgate covered storage

This storage area enables you to keep emergency equipment within easy reach...

» 94

OPENING

Remote control key

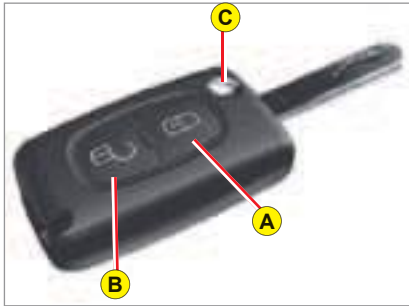

- A. Locking of the vehicle.
- B. Unlocking of the vehicle.
- C. Key release/storage.

Manual central locking



- A. Locking/unlocking of the vehicle from the interior.

Fuel tank

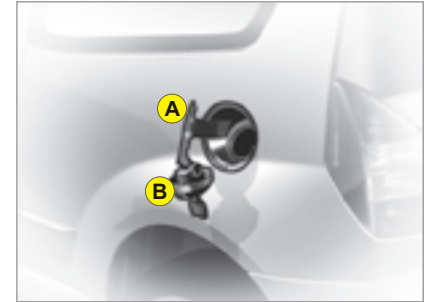

- A. Opening of the fuel flap.
- B. Opening of the fuel cap.

Tank capacity: approximately 41 litres.

OPENING

Upper tailgate



Opening

- ☞ After unlocking the vehicle with the remote control or the key, press on handle **A** and pull up the upper tailgate **1**.

Lower tailgate



Opening

- ☞ After opening the upper tailgate, use handle **B** to open the lower tailgate **2**.

Spare wheel and tools



Access to the spare wheel

- ☞ Remove the plastic cover **C** to access the spare wheel fixing system.

Access to the tools

The tools are stored behind the front right-hand seat.



The maximum allowed weight on the open lower tailgate is **100 kg**.

Stop & Start system

This system, linked to a SensoDrive gearbox, allows the engine to switch off when the vehicle is stopped and avoid excessive fuel consumption.

» 60

Automatic air conditioning

The automatic air conditioning system ensures your comfort and optimum circulation of air in the passenger compartment.

» 68

Cruise control

This system allows you to automatically maintain the speed of the vehicle at the value programmed by the driver, without the need to press on the accelerator.

» 79

SensoDrive gearbox

The automated 5-speed manual gearbox gives you the choice of the comfort of automatic mode or the driving pleasure of a manual gearbox.

» 55



DASHBOARD

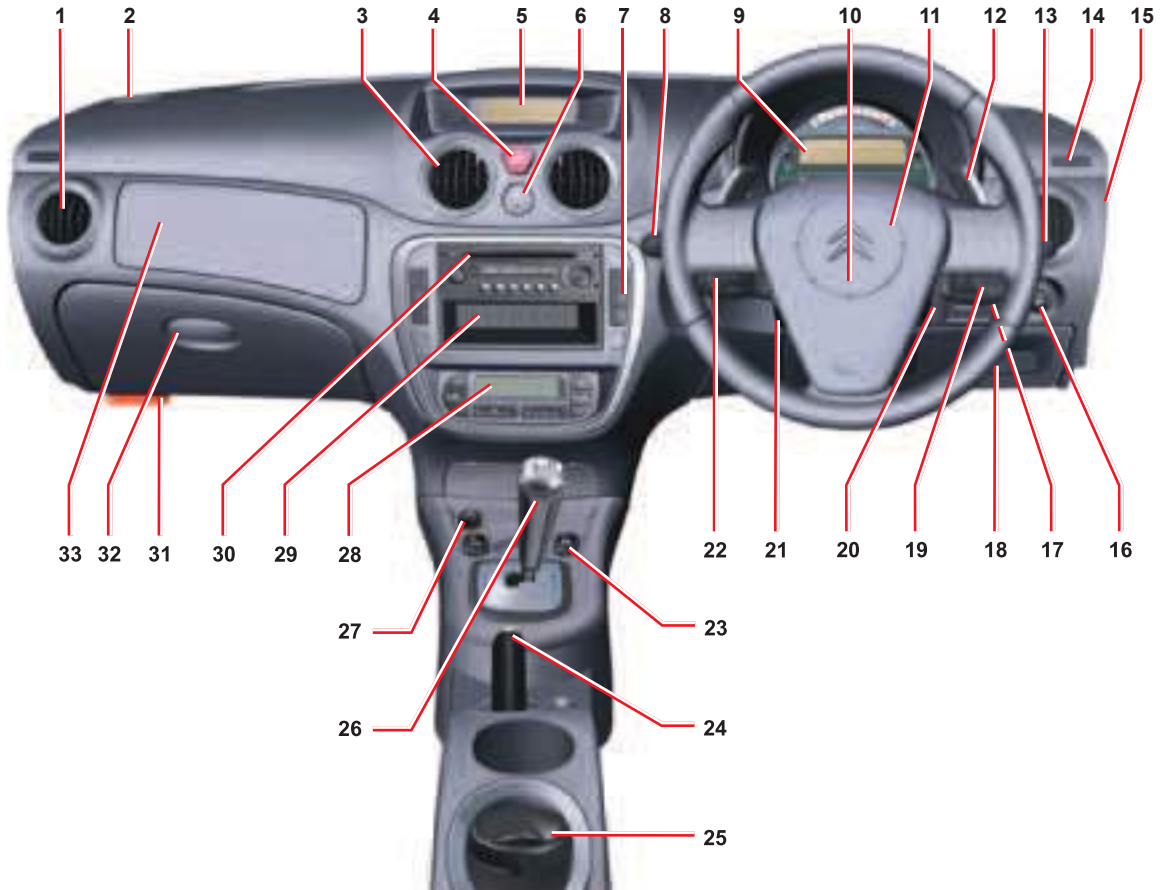

DASHBOARD

- 1 Lateral air vent.
- 2 Loudspeaker (Tweeter).
- 3 Central air vents.
- 4 Hazard warning lamps.
- 5 Display.
- 6 Doors and boot central locking control.
- 7 Controls :
 - Stop & Start.
 - Parking assistance.
 - Anti-intrusion alarm.
 - Overspeed alert.
 - ESP.
- 8 Controls :
 - Lighting.
 - Direction indicators.
 - Foglamps.
 - Rear foglamp.
- 9 Instrument panel.
- 10 Driver's airbag.
- 11 Horn.
- 12 Steering wheel gear controls (SensoDrive gearbox).
- 13 Controls :
 - Windscreen wipe.
 - Screen wash.
 - Rear screen wipe.
 - Trip computer.
- 14 Window deicing and demisting vent.
- 15 Key switch :
 - Activation/Deactivation of passenger's airbag.
- 16 Electric door mirrors adjustment.
- 17 Headlamps adjustment.
- 18 Access to fusebox.
- 19 Radio control under steering wheel.
- 20 Steering lock - Ignition.
- 21 Steering column adjustment control.
- 22 Controls :
 - Cruise control.
 - Speed limiter.
- 23 Front electric window controls.
- 24 Parking brake.
- 25 Moveable ashtray.
- 26 Rear electric window controls.
- 27 Gear lever.
- 28 Cigar lighter / 12 V accessories socket (functions with ignition switched on) (Maximum power 120 W).
- 29 Air conditioning or heating/ventilation.
- 30 Storage/CD changer.
- 31 Radio.
- 32 Bonnet release.
- 33 Lower glovebox :
 - Vehicle document storage.
- 34 Passenger's airbag.

GETTING STARTED

Front seats



1. Head restraint adjustment.
2. Backrest angle adjustment.
3. Longitudinal adjustment.
4. Seat height and angle.
5. Access to rear seats.
6. Heated seats.

Manual adjustment of steering wheel height

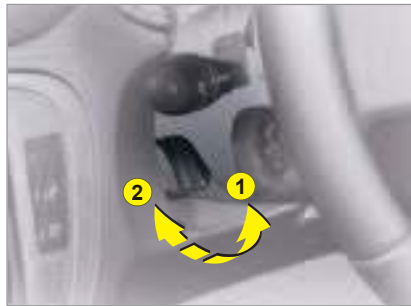

1. Releasing by pulling lever.
2. Locking by pushing lever.

» 51

Adjustment of exterior rear view mirrors



1. Selection of driver's side mirror.
2. Selection of passenger's side mirror.
3. Foldback / Deployment.

» 52

Adjustment of interior rear view mirror



1. « Day / Night » mirror position control.

» 52

GETTING STARTED

Front seat belt



1. Height adjustment.

Ignition switch



- S.** Steering lock position.
- M.** Drive position.
- D.** Starting position.

Electric window controls



1. Driver's electric window control.
2. Passenger's electric window control.

Lighting



Ring A



Headlamps off.



Automatic lighting of headlamps.



Sidelamps.



Dipped or main beams.

Ring B



Front and rear foglamps.

» 47

Screen wipe



Front screen wipe

2 : Fast wipe.

1 : Normal wipe.

I : Intermittent wipe.

0 : Off.

Pressing downwards :

- **AUTO** : Automatic wipe.

- Single wipe.

To deactivate automatic wipe, put the control to position **I**, then return it to position **0**.

» 49



Rear screen wipe



Off.



Intermittent rear screen wipe.





Timed rear screen wash and wipe.

» 50

VENTILATION

Manual air conditioning

Action... To have...	Air distribution control	Temperature adjustment control	Air flow adjustment control	Air conditioning control	Entry of air from outside / Interior air recirculation control
Cold		Maximum cold to start with, then personal adjustments	Maximum to start with, then personal adjustments	ON	Recirculation to start with
Hot		Maximum hot to start with, then personal adjustments	Maximum to start with, then personal adjustments	-	Recirculation to start with
Deicing Demisting		Maximum hot	Maximum	ON	Entry of air from outside

Automatic air conditioning : you are advised to use the fully automatic setting, by pressing on the AUTO button.

Instrument panel

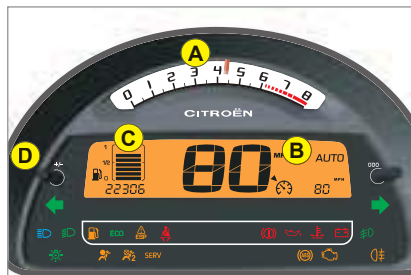

- A. Rev counter.
- B. Instrument panel screen.
- C. Fuel gauge.
- D. Dashboard lighting rheostat.

» 27

Warning lamps



When the ignition is switched on, the orange and red warning lamps light up.
 With the engine running, these warning lamps should go out.
 If the warning lamps remain lit, refer to the appropriate page.

» 30

Controls panel

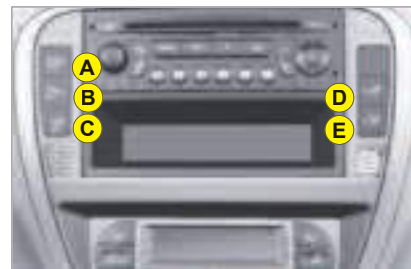

The lighting of the warning lamp indicates the status of the corresponding function.

- A. Deactivation of Stop & Start system. » 60
- B. Deactivation of parking assistance. » 72
- C. Activation of alarm. » 23
- D. Activation of over-speed alert. » 67
- E. Deactivation of ESP. » 65

Driver's seat belt fastening detection



The warning lamp lights up if the driver's seat belt has not been fastened when the ignition is switched on and between 0 and 20 km/h.

Over 20 km/h, the warning lamp flashes accompanied by a sound signal for approximately 2 minutes. After this it remains lit up.

Deactivation of front passenger's airbag



1. With the ignition off, insert the key in switch **A**.
2. Turn the key to the «OFF» position, the passenger's airbag is deactivated.
3. The front passenger's airbag deactivation warning lamp, on the instrument panel, lights up when the ignition is switched on.

Isofix fastening system

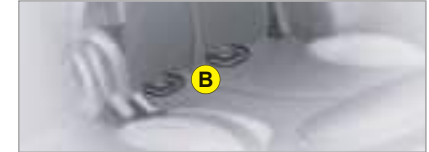

Two rings **B**, located between the backrest and the seat cushion, allow a child seat to be fitted.

SensoDrive gearbox



This automated 5-speed manual gearbox gives you the choice of the comfort of automatic mode or the driving pleasure of a manual gearbox

A. Gear lever.

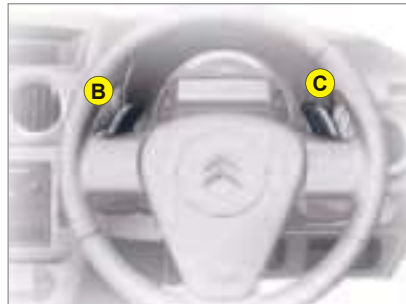

- B.** Control under steering wheel «-».
- C.** Control under steering wheel «+».

Stop & Start system



Your vehicle may be fitted with a «Stop & Start» system, linked to a SensoDrive gearbox, which switches the engine off when the vehicle is stopped (red lights, giving way, congestion...).

Whilst the vehicle is stopped, the engine consumes no fuel, emits no harmful gases and is completely silent.

The engine restarts instantly, the moment that you press the accelerator pedal.

Cruise control



1. Activation / Deactivation of cruise control mode.
2. Reduction of the programmed speed.
3. Increase in the programmed speed.
4. Start / Stop cruise control.

To programme or activate, the vehicle speed must be over 40 km/h (25mph).

To stop cruise control, you can either :

- press on the brake pedal,
- press on control 4,
- use control 1,
- as a last resort, switch off the engine.

Speed limiter



1. Activation / Deactivation of speed limiter mode.
2. Reduction of the programmed speed.
3. Increase in the programmed speed.
4. Start / Stop speed limiter.

Instrument panel display



Cruise control or speed limiter mode appears in the instrument panel when selected.



Cruise control



Speed limiter

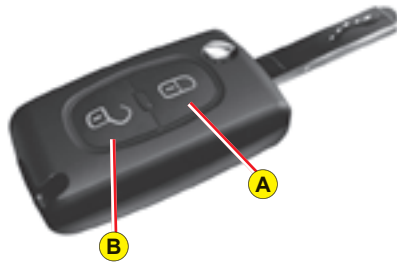

Note: The simultaneous use of other high frequency equipment (mobile telephones, domestic alarms, etc.) may momentarily hinder the operation of the remote control.

If there is a permanent fault, the remote control has to be reinitialised. See “Changing remote control batteries”.

Central unlocking

A short press on control **B** unlocks your vehicle.

This operation is confirmed by the rapid flashing of the direction indicators and the lighting of the interior lamp (if the function is activated). It can also deploy the exterior rear view mirrors.

Central locking – Deadlocking

A **short press** on button **A** locks your vehicle.

This is confirmed by the lighting for around 2 seconds of the direction indicators and by the interior lamp going out. It may cause the exterior rear view mirrors to fold back.

If any of the doors, or the boot, is open or not properly closed, the central locking does not operate.

For vehicles equipped with deadlocking, two successive presses on control **A** will operate deadlocking. It is then impossible to open the doors, either from the inside or from the outside.



It is dangerous to operate the deadlocking when a person is in the vehicle as unlocking is impossible from the inside (without the remote control).

REMOTE CONTROL

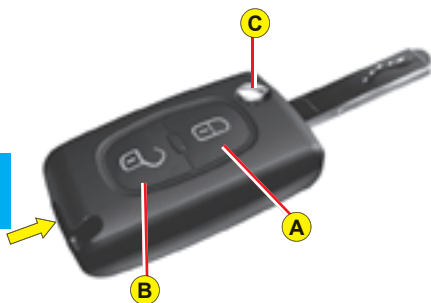

Locating of the vehicle

To locate the vehicle on a carpark, press button **A**, the interior lamps come on and the direction indicators flash for a few seconds. The vehicle remains locked.

Folding and ejecting the key

Button **C** is for folding and ejecting the key from its housing in the remote control.

If you do not press on button **C**, you could damage the key mechanism.

Changing the remote control battery

First, retract the key-carrier if necessary.

Unclip the housing by lifting at the rear (see diagram).

Battery: CR 0523 of 3 V.

Re-initialisation of the remote control

After a change of battery, it may be necessary to re-initialise the remote control. To do that, switch on the ignition and immediately action button **A** on your remote control to trigger the action desired. This may take some ten seconds.

Note: Make a careful note of the numbers for the keys and for the remote control on the ASSISTANCE card. Keep this in a safe place.

Do not throw away the old batteries. They should be returned to a **CITROËN** dealer or deposited at a recognised collection point (a camera shop, for example).

Except when reinitialising, the remote control cannot function while the key is in the ignition, even when switched off.

Warning: by inadvertently actioning the remote control, when for example it is in your pocket, you can unlock the vehicle without your realising it.



However, if none of the doors is opened within thirty seconds following an unlocking, the doors will automatically relock.

Warning: there is a risk of damage if the replacement battery is not the correct one.

Only use batteries that are identical or equivalent to those approved by CITROËN.



Electronic immobiliser key

The key operates all the vehicle's locks as well as the ignition.

Note: For safety reasons, a buzzer will sound if you have switched off the ignition and opened the driver's door without having removed the ignition key.

The key can be used to deactivate the front passenger's airbag. See "Airbags".

Central locking using the key

A brief action with the key locks the vehicle.

Deadlocking: Central locking using the key

A second action straightaway with the key deadlocks the vehicle. It is then impossible to open the doors from either inside or outside the vehicle.

Note:

- With the vehicle stationary and the engine switched off, locking is signalled by the flashing of the interior locking control warning lamp.
- If any of the doors, or the boot, is open or not properly closed, the central locking does not operate.

Electronic immobiliser

The ELECTRONIC IMMOBILISER device locks the engine supply system.

The system activates automatically as the key is removed from the ignition.

All the vehicle's keys contain an electronic immobiliser device.

After you switch on the ignition, a dialogue starts between the key and the electronic immobiliser device.

If the key is not recognised, you cannot start the vehicle.

If this occurs, leave your vehicle immobilised and contact a CITROËN dealer.



It is dangerous to operate the deadlocking when a person is in the vehicle as unlocking is impossible from the inside (without the remote control).

The key number is on the label attached to the key.

Should you lose your key or remote control, a CITROËN dealer can supply replacements.



In the event of a change of vehicle ownership, it is **essential** for the new owner to possess the CODE card.

Keep it in a safe place.

Never leave it in the vehicle.

Advice

Keep the code card bearing your personal electronic immobiliser number in a safe place (never in the vehicle).

If any key modifications become necessary (addition, cancellation or replacement of the key), It is **essential** to take the **confidential card together with all the keys** to a CITROËN dealer.

A confidential card is given to the new owner when he takes delivery of his new vehicle.

This card bears a hidden access code for the use of the CITROËN dealer when servicing the electronic immobiliser device.

Do not scratch the protective strip, the security of the immobiliser system depends on the information below remaining covered.

Should the card be lost, your immobiliser system can no longer be considered secure.



The key number is on the label attached to the key.

Should you lose your key or remote control, a CITROËN dealer can supply replacements.

Should the confidential card become lost, a CITROËN dealer would have to undertake a major repair

ANTI-INTRUSION ALARM



Your vehicle may be equipped with an ANTI-INTRUSION ALARM. This provides:

- Exterior perimeter protection by means of detectors on the vehicle access points (doors, boot, bonnet) as well as on the electrical supply.
- Interior volumetric protection by means of ultrasonic sensors (detecting movement inside the passenger compartment). This can be deactivated using the control **1**.

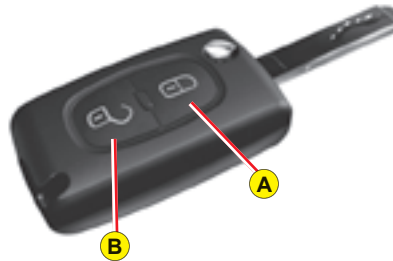

The installation also has a siren, and a warning lamp on the control **1** which is visible from outside the vehicle, indicating the three possible statuses of the alarm:

- Alarm not active (disarmed), warning lamp off.
- Alarm active (armed), the warning lamp flashes slowly.
- Alarm triggered (signalling an intrusion), the warning lamp flashes rapidly if the alarm is deactivated by a press on the control **B**. It stops as soon as you switch on the ignition.

Note: If there is a malfunction, the warning lamp remains permanently on.

Deactivation of the alarm using the remote control

The alarm is disarmed when you unlock the vehicle (with a press on button **B** on the remote control).

Deactivation of the alarm with the key

Unlock the doors with the key. The siren triggers. Enter the vehicle, insert the key in the ignition and turn it to the drive position to stop the siren. Otherwise the siren will continue for approximately 30 seconds.

II

Operating the alarm

First make sure all the doors are closed.

The alarm is armed by pressing button **A** on the remote control.

With the alarm armed, the protections are active after 5 seconds (perimeter) and 45 seconds (volumetric).

When the alarm is armed (on standby), any intrusion will trigger the siren for 30 seconds, accompanied by the direction indicators lighting up.

The alarm then goes back on standby, but the triggering remains memorised and is signalled by the rapid flashing of the warning lamp on control **1** after you have deactivated the alarm with a press on the unlocking button **B**. The flashing stops when you switch on the ignition.

The siren is also triggered if there is a cutting of the electrical supply. To stop it, restore the electrical supply then press on the unlocking button **B**.

Note:

- *If you want to lock your vehicle without arming the alarm, just lock with the key only.*
- *If you lock your vehicle and a door, or the boot, is still open, the central locking does not operate but the alarm will arm itself after approx. 45 seconds.*

Note: *The siren is automatically deactivated (for example for disconnecting the battery) as soon as the vehicle is unlocked using the remote control.*

Deactivating the volumetric detection

You can operate the alarm with perimeter protection only, by deactivating the volumetric protection (if for example you wish to leave an animal in the vehicle).

For this, switch off the ignition then immediately press button **1** for at least one second.

The warning lamp on button **1** should come permanently on. It will start to flash when the alarm is armed.

Arm the alarm by locking your vehicle with the remote control.

Automatic activation (according to destination)

The alarm is armed automatically, 2 minutes after the last door, or the boot, has been closed.

In order to prevent the alarm from triggering when you open one of the doors or the boot, it is essential to press the unlocking button **B** again on the remote control.

STEERING LOCK - IGNITION - STARTER



S: Steering lock

To unlock the steering, gently move the steering wheel while turning the key, without exerting undue force.

When you remove the key, turn your steering wheel to lock the steering. The key can only be removed when in position **S**.

M: Drive position

The steering is unlocked (by turning the key in position **M**, if necessary move the steering wheel).

Depending on your vehicle version, the following warning lamps are tested:

- Briefly:



- Up to starting:



- Flashes until the engine starts:



If one of these warning lamps does not light up, this indicates a malfunction.

D: Starting

Release the key as soon as the engine starts. Never turn it while the engine is running.

Starting and stopping the engine:

See "Driving".

Economy mode

In order not to discharge the battery while the engine is stopped, **your vehicle goes automatically into economy mode after a maximum of 30 minutes**. Economy mode is indicated by a message on the screen.

The electrical components relating to comfort and also the headlamps (not sidelamps or hazard warning lamps) cut out automatically. To reactivate them, it is necessary to start the engine.



NEVER REMOVE THE IGNITION KEY BEFORE THE ENGINE HAS COME TO A COMPLETE STOP.

IT IS ESSENTIAL ALWAYS TO DRIVE WITH THE ENGINE RUNNING, SO AS TO RETAIN STEERING AND BRAKING ASSISTANCE (risk of the steering lock engaging and loss of safety features).

When stationary, having removed the key, carefully turn the steering wheel if you wish to lock the steering.

Manual gearbox

- **Ensure that the gear lever is in the neutral position.**
- Do not touch the accelerator.
- For Diesel engines: Turn the key to the drive position. Wait for the preheater warning lamp to go off, if this has come on.
- Turn the key to action the starter (not for more than ten seconds), until the engine starts.
- In ambient temperatures lower than 0°C, depress the clutch while actioning the starter to facilitate starting. Then release the clutch pedal slowly.

Electronic Gearbox System

- **Check that you are in position N.**
- **Apply the brake pedal.**
- Do not touch the accelerator.
- For Diesel engines: Turn the key to the drive position. Wait for the preheater warning lamp to go off, if this has come on.
- Turn the key to action the starter (not for more than ten seconds), until the engine starts.



ADVICE

Vehicles equipped with a Turbo

Never stop the engine without first having allowed it to idle for a few seconds, this being the time required for the turbochargers to return to a normal speed.

Do not “flick” the accelerator at the moment you switch off the ignition as this could seriously damage the turbochargers.

Note: *If it does not work at first, switch off the ignition. Wait for ten seconds, then operate the starter again as described above.*

WARNING

DO NOT RUN THE ENGINE IN A CLOSED SPACE OR IN ONE THAT IS INSUFFICIENTLY VENTILATED.

INSTRUMENT PANEL

PETROL AND SPORT VERSIONS

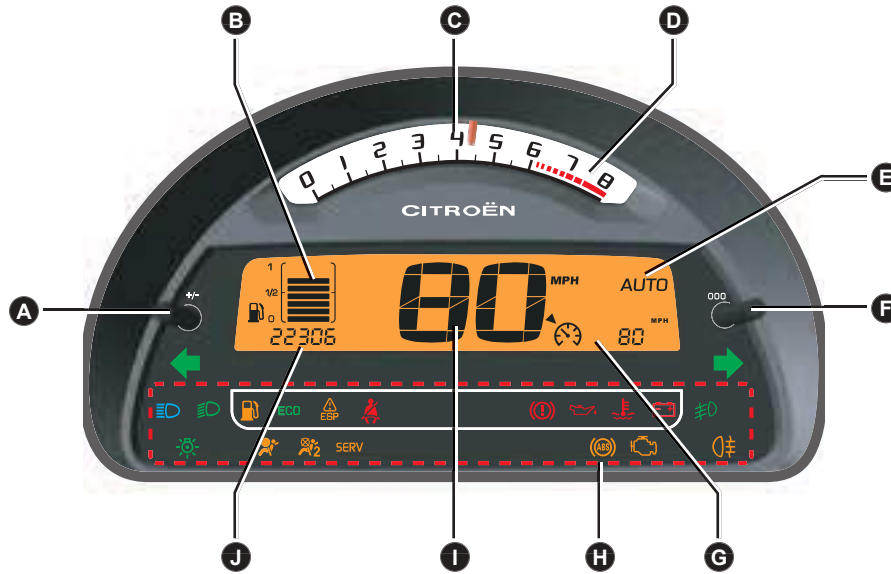

Sport version

INSTRUMENT PANEL



Display

As soon as you open the driver's door, the instrument panel displays the total mileage and trip mileage.

When you switch on the ignition, it scrolls through the following information:

- Maintenance indicator.
- The engine oil level indicator.
- Total mileage.

It also displays the trip mileage or trip computer information (depending on the memory status since the vehicle was last stopped).

Trip mileage recorder reset

This can operate when the ignition is switched on.

Press **B** to show the trip mileage, then give a long press on **B** to reset the counter to zero.

Engine oil level indicator

When the ignition is switched on, the maintenance indicator is displayed for several seconds followed by the engine oil level for approximately 10 seconds. See "Maintenance indicator".

An incorrect engine oil level can seriously damage your engine.

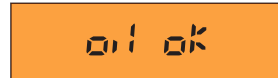

Display of "OIL OK" indicates normal functioning.



Flashing of "OIL" indicates an oil level that is below the minimum.

Check using the manual dipstick. See "Levels". Check the engine oil level on horizontal ground with the engine having been switched off for at least 15 minutes.

Contact a CITROËN dealer.



A flashing of "OIL --" indicates a malfunctioning of the indicator.

Contact a CITROËN dealer.



Fuel low/Fuel gauge

When the tank is full, all 8 bars are lit up. They go out one by one.

If the fuel low warning lamp comes on accompanied by a beep, there remain around 4 to 6 litres of fuel in the tank.

If "black panel" mode is active and there are only around 4 to 6 litres of fuel in the tank, that will make the fuel low warning lamp come on.

INSTRUMENT PANEL

DIESEL VERSION

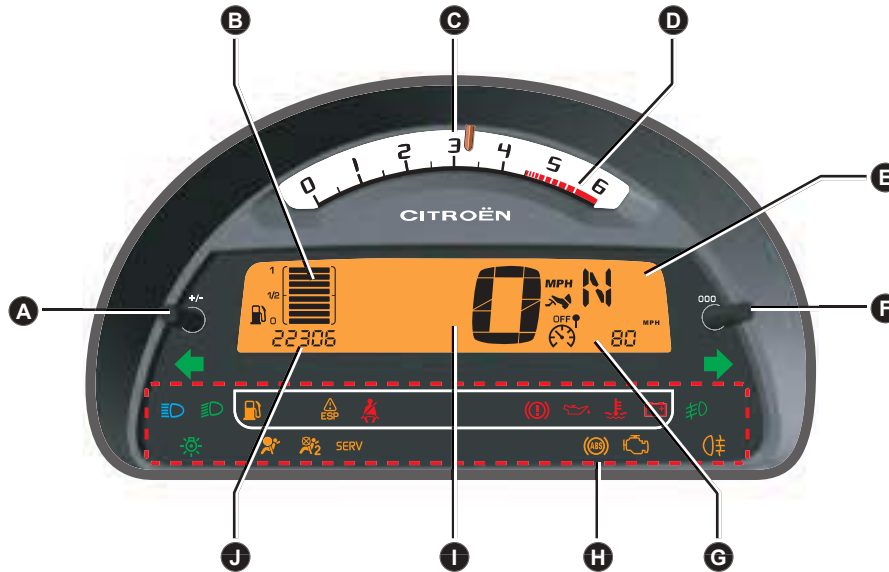

A. Control:

- Lighting rheostat
- Night driving (Black panel)

B. Fuel gauge

C. Rev counter

During the running-in period, see "Running-in".

D. Red zone of rev counter telling you of the need to change to a higher gear.

Sport version: The warning lamp lights up in orange, then in red.

E. Electronic Gearbox System display

F. Control:

- Trip mileage recorder reset

G. Display:

- Cruise control / speed limiter
- Trip mileage recorder
- Trip computer

H. Display of warning lamps

I. Speed indicator

J. Display:

- Maintenance indicator
- Engine oil level indicator
- Total mileage recorder



Display

As soon as you open the driver's door, the instrument panel displays the total mileage and trip mileage.

When you switch on the ignition, it scrolls through the following information:

- Maintenance indicator.
- The engine oil level indicator.
- Total mileage.

It also displays the trip mileage or trip computer information (depending on the memory status since the vehicle was last stopped).

Trip mileage recorder reset

This can operate when the ignition is switched on.

Press **B** to show the trip mileage, then give a long press on **B** to reset the counter to zero.

Engine oil level indicator

When the ignition is switched on, the maintenance indicator is displayed for several seconds followed by the engine oil level for approximately 10 seconds. See "Maintenance indicator".

An incorrect engine oil level can seriously damage your engine.



Display of "OIL OK" indicates normal functioning.



Flashing of "OIL" indicates an oil level that is below the minimum.

Check using the manual dipstick. See "Levels". Check the engine oil level on horizontal ground with the engine having been switched off for at least 15 minutes.

Contact a CITROËN dealer.



A flashing of "OIL --" indicates a malfunctioning of the indicator.

Contact a CITROËN dealer.



Fuel low/Fuel gauge

When the tank is full, all 8 bars are lit up. They go out one by one.

If the fuel low warning lamp comes on accompanied by a beep, there remain around 4 to 6 litres of fuel in the tank.

If "black panel" mode is active and there are only around 4 to 6 litres of fuel in the tank, that will make the fuel low warning lamp come on.



Display

As soon as you open the driver's door, the instrument panel displays the total mileage and trip mileage.

When you switch on the ignition, it scrolls through the following information:

- Maintenance indicator.
- The engine oil level indicator.
- Total mileage.

It also displays the trip mileage or trip computer information (depending on the memory status since the vehicle was last stopped).

Trip mileage recorder reset

This can operate when the ignition is switched on.

Press **B** to show the trip mileage, then give a long press on **B** to reset the counter to zero.

Engine oil level indicator

When the ignition is switched on, the maintenance indicator is displayed for several seconds followed by the engine oil level for approximately 10 seconds. See "Maintenance indicator".

An incorrect engine oil level can seriously damage your engine.

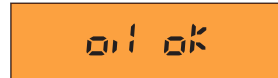

Display of "OIL OK" indicates normal functioning.



Flashing of "OIL" indicates an oil level that is below the minimum.

Check using the manual dipstick. See "Levels". Check the engine oil level on horizontal ground with the engine having been switched off for at least 15 minutes.

Contact a CITROËN dealer.



A flashing of "OIL --" indicates a malfunctioning of the indicator.

Contact a CITROËN dealer.



Fuel low/Fuel gauge

When the tank is full, all 8 bars are lit up. They go out one by one.

If the fuel low warning lamp comes on accompanied by a beep, there remain around 4 to 6 litres of fuel in the tank.

If "black panel" mode is active and there are only around 4 to 6 litres of fuel in the tank, that will make the fuel low warning lamp come on.

WARNING LAMPS

These warning lamps may be accompanied by a message and/or a sound signal



Engine oil pressure

It comes on for a few seconds each time you switch on the ignition.

If this warning lamp comes on, engine running, it tells you that the oil pressure is low.

It is essential to stop the vehicle.

Contact a CITROËN dealer.



Coolant temperature warning lamp

It comes on for a few seconds each time you switch on the ignition.

If this warning lamp comes on, engine running, it tells you that the coolant temperature is rising abnormally.

It is essential to stop the vehicle.

Check the coolant level.

See "Levels".

If the level is satisfactory, consult a CITROËN dealer.



Battery charge

This warning lamp should go out when the engine is running.

If it remains permanently on, contact a CITROËN dealer.



Warning lamp for parking brake, brake fluid level and braking distribution malfunction

With the engine running, the lighting of this warning lamp indicates that the parking brake is on or not properly released, that the brake fluid level is low or that the braking system is malfunctioning.

If the warning lamp remains on even after you have released the parking brake, stop immediately and contact a CITROËN dealer.



Driver's seat belt not fastened

This lamp comes on if the LH seat belt is not fastened when the ignition is switched on and while the vehicle is moving at up to approx. 20 km/h (12 mph). Above this speed, the warning lamp flashes, accompanied by a sound signal for around 120 seconds. Then it remains on.



SERVICE

This warning lamp remains on for a serious fault. Consult a CITROËN dealer as soon as possible.

This warning lamp remains on only for a short time for faults that are minor. Contact a CITROËN dealer if necessary.

To learn the origin of the corresponding alert, refer to the log of alerts (See chapter "Displays **A** and **C**" to chapter "Multifunction displays" or your NaviDrive handbook).



Fuel low

It comes on for a few seconds each time you switch on the ignition.

If the fuel low warning lamp comes on, there remain approx. 4 to 6 litres of fuel in the tank.



Depollution system

It remains on until you start the engine.

If this warning lamp flashes or lights up while you are driving, this indicates a problem with the depollution system.

Consult a CITROËN dealer as soon as possible.

WARNING LAMPS



ESP Operating

It comes on for a few seconds each time you switch on the ignition.

While the ESP system is active, the warning lamp flashes.

For a malfunction

When the vehicle is moving, the lighting of this warning lamp indicates a system malfunction.

Contact a CITROËN dealer.

Function deactivated

The warning lamp remains continuously on.



ABS system

The **ABS** warning lamp lights up when you switch on the ignition: it should go out after a few seconds.

If it does not go out, there could be a system malfunction.

See "Brakes".



Airbag fault

See "Airbags".

It is tested briefly on starting.



Front passenger's airbag deactivation

See "Airbags".

It is tested briefly on starting.



Diesel engine preheating

See method for starting the engine.

See "Driving".



Left hand direction indicator

See "Signalling".



Foot on brake (Electronic Gearbox System)

The flashing of this warning lamp in the instrument panel indicates the need to apply the brake pedal in order to start the engine or engage reverse gear.



Stop & Start

The lighting of this warning lamp indicates that the engine is in shutdown mode.



Right hand direction indicator

See "Signalling".

If the hazard lamps are activated, this means that the direction indicators flash on both sides at the same time.



Sidelamps

See "Signalling".



Front foglamps

See "Signalling".



Dipped beams

See "Signalling".



Fog lamps (rear)

See "Signalling".



Main beams

See "Signalling".

MAINTENANCE INDICATOR

It informs you when the next routine service is due in accordance with the vehicle servicing schedule in the Maintenance Guide. This information is dependent on two parameters: the mileage covered, and the time elapsed since the last visit.

Operation

On switching on the ignition, the maintenance indicator spanner appears in the display for several seconds. The mileage recorder display indicates how many miles remain to be travelled before the next service is due (in thousands and hundreds of miles).

Example: there remain up to the next service:



A few seconds after this, the engine oil level indicator is displayed, then the total mileage recorder resumes its normal role.



Operation if the distance to the next service is less than 1 000 km (600 miles)

Each time you switch on the ignition and for 5 seconds, the spanner and the distance flash.

Example: there remain up to the next service: 500 km (300 miles). On switching on the ignition and for 5 seconds, the instrument panel indicates:



A few seconds after this, the engine oil level indicator is displayed, then the total mileage recorder resumes its normal role and the maintenance symbol remains lit up. This is a warning to you that a service must be carried out at the earliest opportunity.



Operation if the service interval has been passed

Each time you switch on the ignition, the maintenance symbol and the distance covered (preceded by a minus) beyond the recommended interval flash.

Example: You have exceeded the service interval by 300 km (300 miles).

The routine service on your vehicle needs to be carried as soon as possible.



A few seconds after this, the engine oil level indicator is displayed, then the total mileage recorder resumes its normal role and the maintenance symbol remains lit up.



INSTRUMENT PANEL LIGHTING – BLACK PANEL

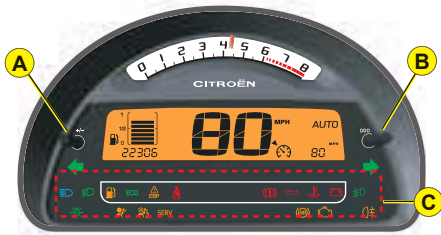

Lighting rheostat

The dimmer is active when the lamps are on and affects:

- The instrument panel: Rev counter, fuel level display.
- The display screen.
- The air conditioning control panel.

Selection of mode and brightness is done by pressing the dimmer button **A** on the instrument panel.

Night driving (headlamps on)

4 levels of brightness + 1 level for Black panel.

Adjustment is by successive presses on button **A** in the following cycle:

level 4 → level 3 → level 2 → level 1
→ Black panel.

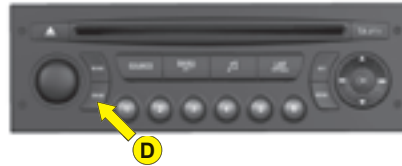

This function is to give you the best possible visual conditions for driving at night.

In black panel mode, the following information only will be displayed temporarily, should you request it or in the event of an alert:

- The warning lamps in zone **C** (bottom area of the instrument panel) will come on in the event of an alert: e.g. fuel low, coolant temperature.
- The direction indicator warning lamps.
- The speed indicator.
- The gear engaged.
- The mileage recorder each time you press button **B**.
- The automatic air conditioning display each time you press one of the buttons.
- The trip computer information.

Night driving

- The first press on button **D** “DARK” places the display on standby. Only the time and the temperature remain visible at the top of the screen.

- A second press on **D** switches the screen and the instrument panel off (black panel) with the exception of information concerning for example:

- The speed indicator.
- The gearbox.
- Cruise control / Speed limiter if this has been activated.

Note: *Timed lighting of functions if you:*

- Press any of the display controls.
- Select Radio-CD.
- Operate any of the air conditioning controls.

Note: *All the displays come on if there is an alert.*

- A third press on **D** returns you to normal lighting.

DISPLAYS

II

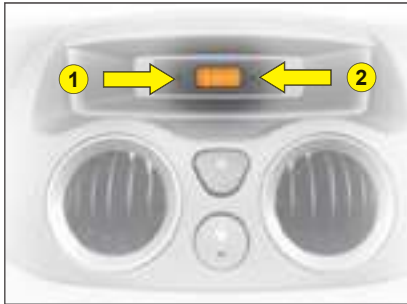

Digital clock

To adjust the display, press on button 1 to alter the hours and on button 2 to alter the minutes.



Display A



Display C



NaviDrive colour display

MULTIFUNCTION DISPLAY

DISPLAY A

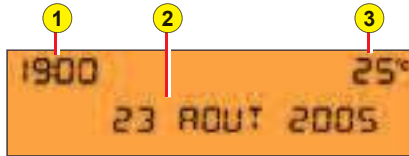

The driver is recommended not to concern himself with the display controls while driving.

1. Time.
2. Date - Display zone.
3. Outside temperature.

When the outside temperature is between +3 °C and -3 °C, the temperature display flashes (risk of ice).

Note: The outside temperature displayed may be higher than the actual temperature if the vehicle is stationary in bright sunlight.

Remark: The display of certain types of information is sometimes scrolled and sometimes alternated.



Controls

- A.** Access to the “Main menu” of the display.
- B.** Scroll through display menus.
- C.** Validation and Selection in the menus, of the function chosen or value modified.
- D.** Cancellation of the operation or return to the previous display.
- E.** Selection of the type of information displayed in zone 2 (date, radio/CD and trip computer).
In the Menu, choice of activation/deactivation of your functions and choice of your adjustments.

Main Menu

By pressing control **A** then **B**, you have access to the following functions:

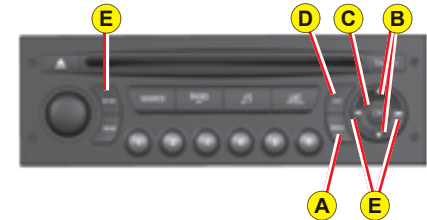

- **Radio-CD** (See radio-CD handbook).
- **Vehicle configuration**, to activate/deactivate:
 - Triggering of rear screen wipe.
 - The automatic guide-me-home lighting.
 - Automatic lighting of headlamps.
- **Options**, to display the alerts.
- **Display adjustments**, to adjust the date and time on the display.
- **Languages**, to select the display language.
- **Units**, to access the choices of units of Temperature and Fuel Consumption.

MULTIFUNCTION DISPLAY

DISPLAY A

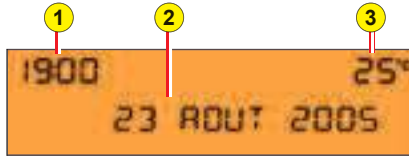

II

Personalisation/Configuration

To activate/deactivate rear screen wipe on engaging reverse gear:

- Press button **A**.
- Select, using **B**, the sub-menu to personalise-configure your vehicle, then confirm your choice with a press on **C**.
- Select rear screen wipe, using **B**.
- The system tells you the status (active or inactive) of the function. Modify this status with a press on **E**.
- Then please wait for the display to disappear.

Note: The activation/deactivation registers immediately.



To activate/deactivate the automatic guide-me-home lighting:

- Press button **A**.
- Select, using **B**, the sub-menu to personalise-configure your vehicle, then confirm your choice with a press on **C**.
- Select guide-me-home lighting, using **B**.
- The system tells you the status (active or inactive) of the function. Modify this status with a press on **E**.
- Then please wait for the display to disappear.

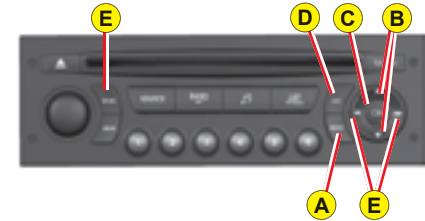

To activate/deactivate the automatic lighting of headlamps:

- Press button **A**.
- Select, using **B**, the sub-menu to personalise-configure your vehicle, then confirm your choice with a press on **C**.
- Select automatic lighting of headlamps using **B**.
- The system tells you the status (active or inactive) of the function. Modify this status with a press on **E**.
- Then please wait for the display to disappear.

Note: Activation of this function is immediate while deactivation requires the ignition to be switched off.

MULTIFUNCTION DISPLAY

DISPLAY A



To display the Log of Alerts:

- Press button **A**.
- Using **B**, select the sub-menu for options. Confirm your choice with a press on **C**.

Note: You can cancel the start of the display by selecting **E** to abandon, validate with a press on **C**.

The alerts that have previously been signalled to you but not resolved, are recalled to you in a scroll.

To delete the display of an alert, press **D**.

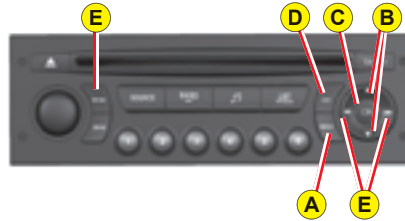

To adjust the date and the time:

- Press button **A**.
- Using **B**, select the sub-menu for Display Adjustments, then confirm with a press on **C**.
- Using **B**, select what you wish to modify: Day, month, year, hour, minutes and display mode.
- Make your adjustment by presses on **E**. You can continue your adjustments, selecting further parameters by pressing **B**.
- When you have finished your adjustments, simply wait for the display to disappear.

To choose the language:

- Press button **A**.
- Using **B**, select the sub-menu for Languages. Confirm your choice with a press on **C**.
- By presses on **E**, select the language of your choice.
- Then please wait for the display to disappear.

To choose units:

- Press button **A**.
- Using **B**, select the sub-menu for Units. Confirm your choice with a press on **C**.
- Using **B**, select the unit you wish to modify (Temperature or Consumption).
- Via presses on **E**, select the unit of your choice.
- Then please wait for the display to disappear.

Note: This choice concerns all the types of information (fuel consumption, speed, etc.) that appear on the displays.

MULTIFUNCTION DISPLAY

DISPLAY C

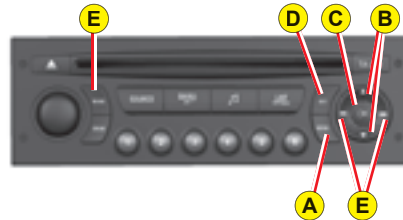
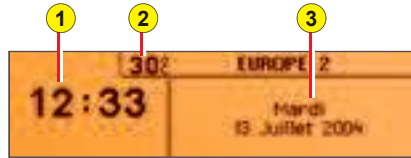

II

The driver is recommended not to concern himself with the display controls while driving.

1. Time.
2. Outside temperature.
3. Date - Display zone.

When the outside temperature is between +3 °C and -3 °C, the temperature display flashes (risk of ice).

Controls

- A. Access to the "Main menu" of the display.
- B. Scroll through display menus.
- C. Validation and Selection in the menus, of the function chosen or value modified.
- D. Cancellation of the operation or return to the previous display.
- E. Selection of the type of information you wish to see permanently displayed (date, radio-CD, trip computer) on the right of the screen.

Main Menu

Press on button **A** to bring up the "Main menu" of the multifunction display. This menu gives you access to the following functions:



Personalisation - Configuration, allowing you to activate or deactivate:

- Triggering of rear screen wipe.
- The automatic guide-me-home lighting.
- Automatic lighting of headlamps.

And choosing:

- The brightness, the time, the date and the display units.
- The display language.



Radio-CD

(See radio-CD handbook).



Trip computer, giving you:

- Entering the distance to the destination.
- Access to the log of alerts (recall of the alerts signalled previously).
- Access to status of functions, for example activation/deactivation of automatic lighting of headlamps, ESP, windscreen wipers.



Bluetooth® hands-free kit

(See radio-CD handbook).

Note: The outside temperature displayed may be higher than the actual temperature if the vehicle is stationary in bright sunlight.

Trip computer

To enter the distance to be travelled on the trip computer:

- Press button **A**.
- Use **B** to select the icon “Trip computer”, then confirm with a press on **C**.
- Select entry of distance using **B**. Confirm your choice with a press on **C**.
- To choose the distance, select the figure you wish to modify by using **B**, then confirm with a press on **C**.
- Use **B** to adjust the value, then validate by pressing **C**.
- Validate “**OK**” on the screen.

To access the trip computer's log of alerts:

- Press button **A**.
- Use **B** to select the icon “Trip computer”, then confirm with a press on **C**.
- Select the log of alerts.
- When the list displays, use **B** to scroll through it.
- Press **D** to return to the permanent display.

To access the status of functions: proceed in a similar manner.

Personalisation/Configuration

To activate/deactivate rear screen wipe on engaging reverse gear:

- Press button **A**.
- Use **B** to select the icon “Personalisation-Configuration” then confirm your choice by pressing **C**.
- Then select the sub-menu for the vehicle parameters. Confirm your choice with a press on **C**.
- Use **B** to select parking assistance. Confirm your choice with a press on **C**.
- Then with a press on **C**, select/deselect rear screen wipe to activate or deactivate it.
- Validate “**OK**” on the screen.

Note: The activation/deactivation registers immediately.

To activate/deactivate the automatic guide-me-home lighting:

- Press button **A**.
- Use **B** to select the icon “Personalisation-Configuration” then confirm your choice by pressing **C**.
- Then select the sub-menu for the vehicle parameters. Confirm your choice with a press on **C**.

- Using **B**, select lighting and signalling. Confirm your choice with a press on **C**.
- Then press **C** to select/deselect the guide-me-home lighting, to activate/deactivate it. After activation, choose the duration: press **C** then use **B** to select the duration, then press **C**.
- Validate “**OK**” on the screen.

To activate/deactivate the automatic lighting of headlamps:

- Press button **A**.
- Use **B** to select the icon “Personalisation-Configuration” then confirm your choice by pressing **C**.
- Then select the sub-menu for the vehicle parameters. Confirm your choice with a press on **C**.
- Using **B**, select lighting and signalling. Confirm your choice with a press on **C**.
- Next press on **C** to activate/deactivate automatic lighting of headlamps.
- Press button **C**.

Note: Activation of this function is immediate while deactivation requires the ignition to be switched off.

MULTIFUNCTION DISPLAY

DISPLAY C

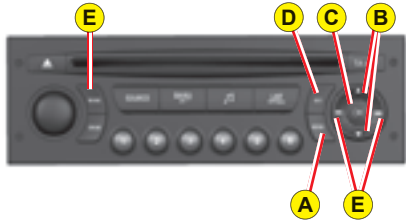

To adjust the date and the time:

- Press button **A**.
- Use **B** to select the icon “Personalisation-Configuration” then confirm your choice by pressing **C**.
- Select the display configuration with a press on **B**. Confirm your choice with a press on **C**.
- Select the adjustment for the date and the time, by pressing **B**, then confirm with a press on **C**.
- Press **B** to select the values you wish to modify. Confirm your choice with a press on **C**.
- Do your adjustments with **B**, then validate each adjustment choice with a press on **C**.
- Validate “**OK**” on the screen.

To choose the language:

- Press button **A**.
- Use **B** to select the icon “Personalisation-Configuration” then confirm your choice by pressing **C**.
- Use **B** to select the desired language and validate your choice by pressing **C**.
- Validate “**OK**” on the screen.

To choose units:

- Press button **A**.
- Use **B** to select the icon “Personalisation-Configuration” then confirm your choice by pressing **C**.
- Select the display configuration with a press on **B**. Confirm your choice with a press on **C**.
- Then select the sub-menu for Units. Confirm your choice with a press on **C**.
- Using **B**, select the unit to be modified (Temperature or Consumption) then validate with a press on **C**.
- Validate “**OK**” on the screen.

Note: This choice concerns all the types of information (fuel consumption, speed, etc.) that appear on the displays.

To adjust the display brightness:

- Press button **A**.
- Use **B** to select the icon “Personalisation-Configuration” then confirm your choice by pressing **C**.
- Select the display configuration with a press on **B**. Confirm your choice with a press on **C**.
- Select the brightness adjustment. Confirm your choice with a press on **C**.
- Select with a press on **B**, then validate by pressing **C**, the normal or alternative display mode. To adjust the brightness, select the symbols “+” or “-” and confirm your adjustment by pressing **C**.
- Validate “**OK**” on the screen.

MULTIFUNCTION DISPLAY

NAVIDRIVE COLOUR DISPLAY



The driver is recommended not to concern himself with the display controls while driving.

1. Outside temperature.
2. Folder.
3. Date.
4. Telephone.
5. Time.

When the outside temperature is between +3 °C and -3 °C, the temperature display flashes (risk of ice).

Note: The outside temperature displayed may be higher than the actual temperature if the vehicle is stationary in bright sunlight.

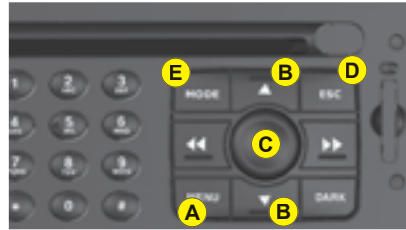

Controls

- A. Access to the “Main menu” of the display.
- B. Scroll through display menus.
- C. Validation and Selection in the menus, of the function chosen or value modified.
- D. Cancellation of the operation or return to the previous display.
- E. Selection of the type of information you wish to see permanently displayed (date, radio-CD, trip computer) on the right of the screen.

Main Menu

Press on button **A** to bring up the “Main menu” of the multifunction display. This menu gives you access to the following functions:



Navigation/guidance

(See NaviDrive instructions)



Audio

(See NaviDrive instructions)



Trip computer

(See NaviDrive instructions)



Folder

(See NaviDrive instructions)



Telematics

(See NaviDrive instructions)



Configuration

This allows adjustment of the various parameters (activation/deactivation of automatic lighting of headlamps, date, time, units, etc.).

(See NaviDrive instructions)



Map

(See NaviDrive instructions)

TRIP COMPUTER

II

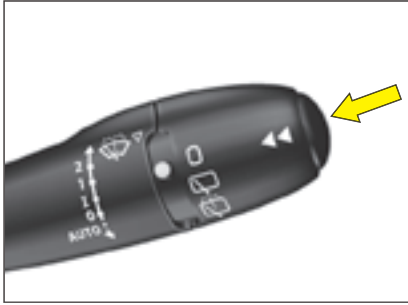

For selection and display of the various types of information, give short presses on the end of the windscreen wiper stalk.



For C-type screens and NaviDrive, one press on the "Mode" button gives you permanent display of the trip computer information.

To reset the trip computer information to zero, keep the end of the control stalk pressed for a few seconds when you see the relevant information displayed.



Instrument panel (For a version with digital clock)

The trip computer provides 4 types of information on the instrument panel, following the display of trip mileage:

- Range.
- Instantaneous consumption.
- Average consumption.
- Average speed.

Remark: If the cruise control / speed limiter is in operation, the display of trip computer information disappears after a few seconds.



Display A

The trip computer provides 5 types of information:

- Range.
- Average consumption.
- Instantaneous consumption.
- Distance travelled.
- Average speed.

To cancel the display of the trip computer information, press a sixth time.

TRIP COMPUTER



Display C



NaviDrive colour display

Remark:

After a re-initialisation of the trip computer, the indication of range only becomes significant after a certain period of use.

II

The trip computer gives access to 3 types of instantaneous information:

- Range.
- Instantaneous consumption.
- Distance remaining to be travelled.

The trip computer also gives access to 3 types of information for 2 Journeys 1 and 2:

- The distance travelled.
- Average consumption.
- Average speed.

The Journeys

Journeys 1 and 2 are independent of each other but identical in use. For example you can allocate Journey 1 to daily calculations and Journey 2 to monthly calculations.

Resetting a Journey to zero

When the desired Journey is displayed, give a **long press** on the end of the wiper control stalk.

TRIP COMPUTER

Instrument panel



Display version A



Range

This is the distance that can still be travelled on the amount of fuel remaining in the tank.

When the distance remaining to be travelled is less than approx. 25 km (15 miles), only three dashes will be displayed.

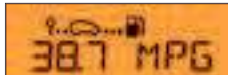

Average consumption

This is the relationship between the fuel consumed and the distance travelled since the last reset to zero of the trip computer.



Instantaneous consumption

This is the result from the consumption recorded within the last 2 seconds. This function is only available when travelling at over 30 km/h (approx. 20 mph).



Average speed

This is obtained, from the last reset to zero of the trip computer, by dividing the distance travelled by the time taken (with ignition switched on).



Distance travelled

This is the distance that has been travelled since the last reset to zero of the Journey selected.

Distance to be travelled

To enter it, see “Multifunction display”.

Display version C



NaviDrive colour display



■ Range

This is the distance that can still be travelled on the amount of fuel remaining in the tank.

When the distance remaining to be travelled is less than approx. 25 km (15 miles), only three dashes will be displayed.

■ Instantaneous consumption

This is the result from the consumption recorded within the last 2 seconds. This function is only available when travelling at over 30 km/h (approx. 20 mph).

■ Distance to be travelled

It indicates the distance remaining to be travelled to the destination. To enter this, see NaviDrive instructions.



■ Distance travelled

This is the distance that has been travelled since the last reset to zero of the Journey selected.

■ Average consumption

This is the relationship between the fuel consumed and the distance travelled since the last reset to zero of the trip computer.

■ Average speed

This is obtained, from the last reset to zero of the trip computer, by dividing the distance travelled by the time taken (with ignition switched on).

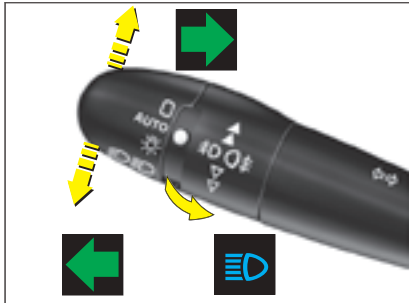

Direction indicators

Left, downwards.

Right, upwards.

For a change of direction, move the control stalk beyond the tight spot. Stops automatically with the return of the steering wheel.

Visible alert / headlamp flash

Pull the control towards you.

The headlamp flash can be made even with the ignition switched off.

Horn

Press at the centre of the steering wheel.



Hazard warning lamps

This operates all the direction indicators simultaneously.

Only use them to indicate danger, for an emergency stop or for driving in abnormal conditions.

The hazard lamps can also be used with the ignition switched off.

Sound signal for headlamps left on

This operates when the driver's door is opened, ignition off, to indicate that the vehicle lamps are still on.

It stops when you close the door, switch off the lamps or switch on the ignition.

This signal does not operate if the automatic lighting of headlamps or the guide-me-home lighting are active.

Emergency operation of hazard warning lamps

A sudden deceleration of the vehicle causes the hazard lamps to come on automatically.

They will cease to operate automatically, or manually if you press the hazard lamps button on the dashboard.

The direction indicators cannot operate if the hazard warning lamps are on.

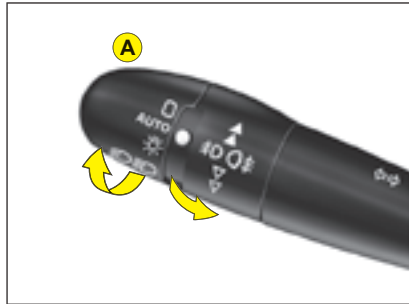

Lighting control stalk



All vehicle lamps off

Rotate the ring **A** forwards.



Automatic lighting of headlamps

Sidelamps and dipped beams come on automatically in poor ambient light, or if the wipers are in continuous operation. They go out as soon as the ambient light again become sufficient or when the wipers cease to operate.

Rotate the ring **A** forwards.

Take care not to cover the brightness sensor, which is visible from outside the windscreen, behind the interior rear view mirror.



Sidelamps on

The instrument panel lights up.

Rotate the ring **A** forwards.



Dipped beams/main beams on

Rotate the ring **A** forwards.

Pull the control stalk **towards you** to change between dipped beam and main beam.

Guide-me-home lighting

This function switches on your headlamps, to light your way when you wish to walk from a carpark, for example.

This function is activated:

- Manually by pulling the lighting stalk towards you, ignition off.
 - Automatically, provided:
 - The automatic lighting of headlamps is activated.
 - To activate the guide-me-home lighting function, select in the "Main menu", then in "Personalisation/Configuration", the sub-menu for lighting and signalling, then activate the function.
- See "Multifunction display".

Note:

- *It is possible to modify the duration of the guide-me-home lighting (approx. 60, 30 or 15 seconds) in the menu "Personalisation/Configuration".*
- *On screen A, the length is fixed.*

Note: On vehicles equipped with daytime running lamps, automatic headlamp lighting and guide-me-home lighting are not available.

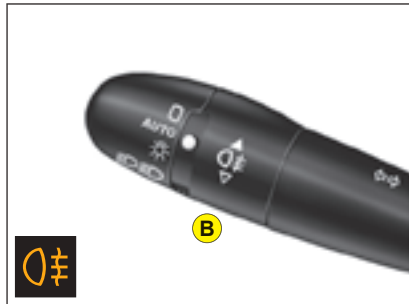

Rear FOGLAMPS (Ring B)

Switch on your dipped/main beams.
Rotate the ring **B** forwards.



Rear foglamps on

The warning lamp lights up.
The foglamps operate only with either headlamp dipped beam or headlamp main beam switched on.

Front and rear foglamps (ring C)

Switch on your dipped/main beams.

Rotate the ring **C** forwards.



Front foglamps on

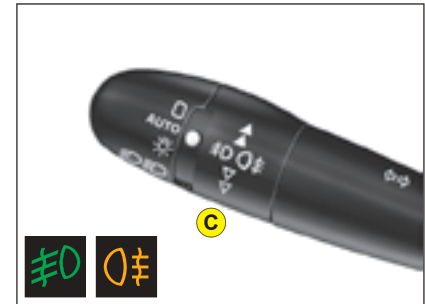

Rotate the ring **C** forwards.



Front foglamps and rear foglamps on

Switching off

First action rearwards, rear foglamps off.

Second action rearwards, front and rear foglamps off.

Note: the foglamps should be used only in fog or in other conditions of poor visibility.

In foggy conditions, if the ambient light is not such that the headlamps come on automatically, it is up to the driver to switch on dipped beams, and/or foglamps, manually

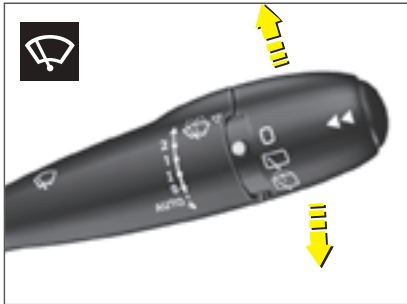

Windscreen wiper

Control positions

2: Rapid wipe.

1: Normal wipe.

I: Intermittent wipe.

0: Off.

One press downwards:

- **AUTO**: Automatic wipe activated.
- Single wipe.

Position I: The wipe speed adjusts automatically to the speed of the vehicle.

Positions 1 and 2: When the vehicle is stationary, the speed of the wipers will reduce automatically.

For safety, the wiper system is deactivated when the ignition is switched off.

When you switch the ignition on again, to reactivate the function:

- Return to **position 0**.
- Or go to the **desired position**.

Activation of the function is confirmed by one sweep of the wipers.

Vehicle with rain sensor

Activation of automatic wipe:

One touch downwards: "AUTO". The wipe speed will adjust according to the intensity of the rain.

Note: *If automatic wipe is active, a touch downwards triggers a single wipe, without deactivating automatic wipe.*

Deactivation of automatic wipe:

- Go to position I, then return to position 0.
- Or **stop** the engine.

WARNING

Do not cover the rain detector which is located behind the interior rear view mirror and visible from outside the windscreen.

For washing the vehicle, switch off the ignition or deactivate the automatic wipe.

For safety, the wiper system is deactivated when the ignition is switched off.

B. Rear screen wipe

First notch

Off.

Second notch

Intermittent rear wipe.

Third notch

Timed rear wash/wipe.

Automatic wipe

When the windscreen wipers are operational and reverse gear is engaged.

Activation/deactivation of this function is possible in the menu "Personalisation/Configuration" in the "Main menu".

Deactivation may be necessary when a bicycle-carrier is installed on the tailgate.

Changing the wiper blades

If you have to replace them, the wiper blades have to be parked in the **maintenance position**. For this, switch off the ignition and then within one minute move the wiper control stalk. The wipers stand up in a vertical position.

After replacement, **switch on the ignition** and **move the wiper control stalk** so that the wipers resume their normal position.

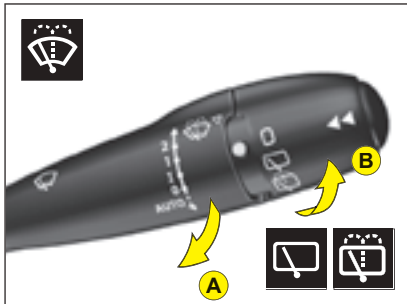

A. Windscreen wash

To operate the windscreen wash, pull the wiper stalk towards you.

The screen wash is accompanied by a timed wipe of the windscreen, the headlamp wash also activates if the dipped beams are on.

**Check that the windscreen and rear wipers can operate freely when for example a bicycle-carrier is fitted, or in freezing conditions.
Remove any accumulation of snow at the base of the windscreen.**

DASHBOARD ADJUSTMENTS



Steering column adjustment

The steering can be adjusted for both height and reach.

With the vehicle stationary, first adjust your seat to the most suitable position, then adjust the position of the steering wheel. See "Driving position".

Unlock the steering wheel by pulling the control upwards.

Adjust the position of the steering wheel then lock by pushing the control fully downwards.

Make sure that you have a good view of the instrument panel displays.

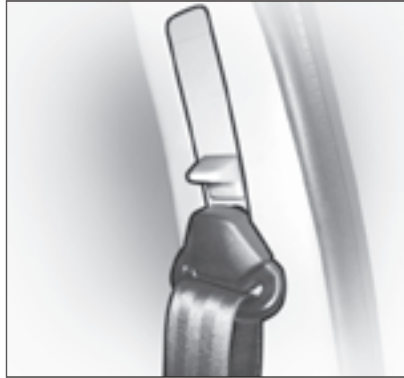

Seat belt height adjustment

The correct positioning of the seat belt is across the middle of the shoulder. See USER PRECAUTIONS.

Adjust the height of the seat belt anchorage by holding down the button and the lever.



Headlamps adjustment

You are advised to adjust the aim of the headlamps in accordance with vehicle load.

In the dashboard on the right hand side of the steering column.

0: Unladen weight.

1: Lightly laden.

2: Half laden.

3: Fully laden.

As a matter of safety, these manoeuvres should not be performed while the vehicle is moving.



Interior rear view mirror

The lever on the lower edge enables you to place the rear view mirror in either of two positions:

Day position: the lever is not visible.

Night position (anti-dazzle): the lever is visible.



Electric exterior rear view mirrors

Your vehicle is equipped with electric door mirrors.

Set the position of the selected door mirror:

1. Left hand door mirror.
2. Right hand door mirror.

Move the control in the four directions to set the position.

The defrosting of the exterior rear view mirrors is linked to the electrical demisting of the rear window.



Fold-back of door mirrors

When the vehicle is parked, the door mirrors can be folded back either manually or electrically.

Turn the control to position **3** for electric foldback of the rear view mirrors.

Quit position **3** to deploy the rear view mirrors.

The end of the glass in the exterior rear view mirrors is aspherical, so as to enlarge the lateral field of vision.

Objects observed in the aspherical part of the rear view mirrors are in reality closer than they appear.

You must take this into account in order to be properly aware of the distances involved.



Electric operation

The switches on the console allow the vehicle's electric windows to be controlled from the driver's position.

Sequential control on driver's side

An action on the control to the first notch causes a window movement which stops as soon as the control is released.

An action on the control to the second notch causes the window to close or open completely, a further press on the control stops the movement.

Note: *The window controls also operate for a limited time after you have switched off the ignition.*

Anti-pinch on driver's window

An anti-pinch device stops the window from rising. If it meets an obstacle, it goes back down.

After a battery disconnection or if there has been a malfunction, you have to **re-initialise** the anti-pinch function:

- Use the control to fully open the window, then reclose. It will rise only a few centimetres.
- Press again on the control until the window closes fully.

During this operation, the anti-pinch protection does not work.

Manual operation

Turn the handle to raise or lower the window.

ALWAYS PAY ATTENTION TO WHERE CHILDREN ARE WHEN OPENING OR CLOSING THE WINDOWS

Always remove the ignition key when leaving the vehicle, even if for a short time.

If there is an obstruction when operating a window, you must immediately reverse the window movement. To do that, reverse the position of the control concerned.

If the driver is operating the electric window controls for passengers, he or she should ensure that no passenger is obstructing the window from closing.

The driver must ensure that the electric windows are used properly by passengers.

MANUAL GEARBOX

Reverse gear

Do not select reverse gear until the vehicle is completely stationary.

Depress the clutch pedal and wait a few moments before gently engaging reverse gear.

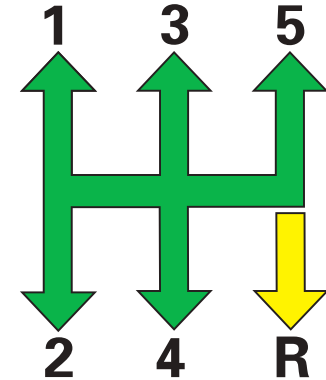

Manual gearbox gear lever.

ELECTRONIC GEARBOX SYSTEM

GENERAL



The Electronic Gearbox System gives you the choice of two driving modes:

- **Automatic mode.**
- Manual mode with two control possibilities: The controls under the steering wheel **1** and the selection lever **2** on the central console.

Selection lever for Electronic gearbox operating mode:

- Automatic operation with the gear lever **2** in position **A**.

Remark: Instant manual mode activates whenever you action one of the controls under the steering wheel **1**.

- Manual operation with the gear lever **2** in position **M**.

Dashboard display

- The gear engaged and the mode “**AUTO**” are displayed on the instrument panel, even if the ignition is switched off, when for example a door is opened.
- The foot-on-brake warning lamp flashes to indicate the necessity to press the brake pedal, in order to start the engine or to engage reverse gear.



With the ignition switched on, simultaneous flashing of the warning lamps “” and “**AUTO**” indicates a fault, contact a CITROËN dealer as soon as possible.

Using the Electronic Gearbox System



Starting the vehicle

- Apply the brake pedal. The lever should be in position **N**. Switching on the ignition will in any case return you to position **N** (neutral).
- Check the gear engaged on the instrument panel.
- As required, select **1** gear or reverse gear (the engine must be at idle).
- Release the handbrake.
- Lift your foot from the brake pedal and accelerate.

N Neutral

While the vehicle is moving, do not select this position, even momentarily.

R Reverse gear Engaging reverse gear **R**:

Only the lever permits you to engage reverse gear.

Only place the lever in position **R** if the vehicle is stationary, foot on the brake.

A Automatic mode

M Manual forward drive

Selector position for manual gear changing:

- Push the lever to change up a gear.
- Pull the lever to change down a gear.



The engine can only be started, and reverse gear can only be engaged, if the brake pedal is pressed.

The foot-on-brake warning lamp flashes on the display for approx. 5 seconds to indicate the necessity to press the brake pedal in order to start the vehicle or engage reverse gear.

Vehicle stationary, engine running

If the vehicle is stationary for a long time with the engine running, then the gearbox changes automatically to neutral.

Stopping the engine

Before switching the engine off, you must choose:

- To leave the vehicle in neutral ; for that, place the lever in position **N**.
- To leave the vehicle with a gear engaged (**1st** or **2nd** or **Rse**); for that, place the gear lever in the respective position. In this case, the vehicle cannot be moved.

In all cases it is essential to apply the parking brake.

It is possible within a limited time to re-engage a gear, even if the engine is switched off.

Before any operation in the engine compartment, check that the gearbox is in neutral and that the parking brake is applied.

Acceleration

The accelerator pedal may have an end-of-travel switch. If so, to obtain extra acceleration you can action this switch by pressing the pedal hard down.

Starting on a gradient

If starting on a gradient, accelerate gradually while releasing the handbrake.

If you have had to stop on a gradient, you are recommended not to use the accelerator to maintain the vehicle's position.



In the event of prolonged slipping of the clutch, the driver is alerted by the vehicle vibrating. It is necessary to use the brakes to hold the vehicle.



To select automatic mode

Place the selection lever in position **A**.

“AUTO” displays on the instrument panel to confirm the selection.

The gearbox then operates in auto-active mode, without intervention on your part.

It constantly selects the gear best adapted to the following parameters:

- Style of driving.
- Road profile.
- Vehicle load.

Instant manual mode

Even in automatic mode, if you touch the controls under the steering wheel “+” or “-” you immediately change gear.

The symbol “**AUTO**” remains lit on the instrument panel.

In the absence of any further action, automatic mode reactivates to cope with the prevailing driving conditions.

Cancellation of automatic mode

Move the gear lever from position **A** to select a different position.

The symbol “**AUTO**” disappears from the instrument panel.



Gear controls under the steering wheel

Place the gear lever in position **M**, and then the controls under the steering wheel will give you access to the five gears in forward drive.

To change gear:

- Pull the control “+” towards you to engage a higher gear.
- Pull the control “-” towards you to change down.

These controls do not permit you to select neutral or reverse gear, nor do they enable you to quit reverse gear.



Commands using the gear lever

Place the gear lever in position **M**, then:

- Push the lever to change to a higher gear.
- Pull the lever to change down.

Remarks:

- When the vehicle reduces speed, for example approaching a stop sign or traffic lights, the gearbox changes down automatically to 1st gear.
- In manual mode, it is not necessary to release the accelerator during changes of gear.

- A command to change gear is accepted only if the engine speed permits this.
- As the engine reaches maximum revs and conditions permit, the system will automatically engage a higher gear.

Re-initialisation

The Electronic Gearbox System requires a re-initialisation after one of the following events:

- Change of battery or disconnection of battery.
- Starting the engine with an assisting battery.
- A system malfunction.

To re-initialise the system:

- Switch on the ignition. A dash and “**AUTO**” will display in the instrument panel.
- Apply the brake pedal.
- Wait until you see **N**, or a gear engaged, in the instrument panel (about 30 seconds).
- Release the brake.

Starting is again possible.

STOP & START

Your vehicle may be equipped with a “Stop & Start” system, in association with an Electronic Gearbox System; this shuts down the engine during stopping phases (red lights, traffic jams, temporary halts, etc.).

During these phases, your vehicle uses no fuel, emits no pollutants and is completely silent.

The engine restarts instantly when you want to move forward again.

Functioning of the “Stop & Start” system:

If you brake to stop your vehicle, the engine shuts down just before the vehicle comes to a complete halt; the green “ECO” warning lamp lights up in the instrument panel. The engine remains shut down for as long as you keep your foot, even lightly, on the brake pedal.

As you release the brake pedal, the engine restarts automatically and instantly. The green “ECO” warning lamp goes out. You can then accelerate to move forward again.

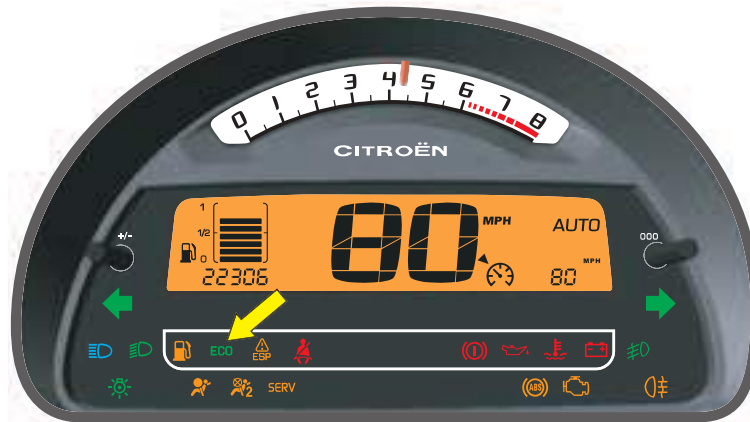

Situations where the engine does not shut down:

Before shutting down the engine, the system automatically and instantly checks that a certain number of conditions touching on safety, cabin comfort or engine protection are met.

For example, the engine will not shut down, or it will restart by itself:

- Within the few minutes following first starting (engine cold).
- If the temperature in the passenger compartment is insufficient:
 - In conditions of extreme outside temperatures (lower than -10°C , higher than $+30^{\circ}\text{C}$), provided the air conditioning is operating.
 - More generally, if the ambient conditions and the temperature programmed for the air conditioning make it necessary for the engine to be running in order to produce either warm or cold air.
- If you have activated windscreen demisting/deicing.
- In the event of a prolonged stop on a steep incline, in order to maintain the vehicle's braking capability.

After you have engaged reverse gear, engine shutdown is suspended for approx. fifteen seconds.

STOP & START

Deactivation of the “Stop & Start” system:

You can if you wish deactivate the “Stop & Start” system, by pressing the “ECO OFF” button located on the left hand side on the central panel.

The warning lamp on the button then comes on, and your vehicle functions like an ordinary vehicle.

You can reactivate the system with another press on the “ECO OFF” button: The warning lamp on the button goes out.

Note: *The “Stop & Start” system reactivates automatically each time you restart the vehicle.*



Batteries

To operate correctly, the system requires a specific battery and also a small additional battery which is situated under one of the front seats.

For a change of battery, consult a CITROËN dealer.

Remark:

If there is a malfunction of the “Stop & Start” system, the “ECO” warning lamp flashes briefly, accompanied by an audible alert. The “ECO OFF” warning lamp lights up.

Contact a CITROËN dealer.

**If the engine is in shutdown mode, it can restart at any moment.
Before taking any action under the bonnet, it is imperative to switch off the ignition.
Before leaving the vehicle, it is also essential to switch off the ignition.**

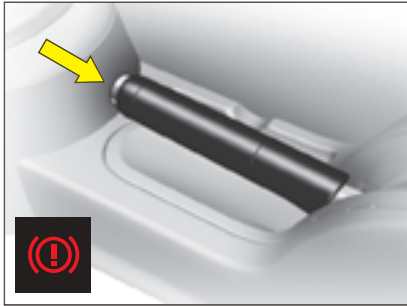

Parking brake

The parking brake is actioned by pulling on the lever with a force appropriate to any slope.

To facilitate the action on the lever, you are recommended to press the brake pedal at the same time.

In all circumstances, as a precautionary measure, engage first gear.

On steep gradients, turn the steering towards the pavement.

To release the brake, pull the lever lightly up, press the button on the end of the lever and return the lever to the fully down position.

Note: The warning lamp comes on if the parking brake is on or not fully released when you switch the ignition on.

Note: The lighting of this warning lamp indicates that the parking brake is on or not fully released while the engine is running (at a speed above approximately 5 km/h).



Parking brake released

The lighting of this warning lamp indicates that the brake fluid level is insufficient or that the braking distributor is malfunctioning.

It is essential to stop the vehicle.

Consult a CITROËN dealer as soon as possible.



ABS system

The ABS system enhances your safety by preventing the wheels from locking in the event of sudden braking or in conditions of poor road adherence. It enables you to retain control of the steering.

The functioning capability of all the electrical components essential to the ABS is monitored electronically before and during your journey. The ABS warning lamp lights up when you switch on the ignition: it should go out after a few seconds.

If the monitoring warning lamp does not go out, that means that the ABS has disconnected because there is a fault. Also, the fact that the monitoring warning lamp comes on during the journey shows that the ABS system is inactive. In both cases, the normal braking system remains efficient, exactly as on a vehicle without ABS. However, in order for the security associated with the correct functioning of the ABS to be restored, the vehicle should be examined as soon as possible by a CITROËN dealer.

On roads with poor adherence (chippings, snow, ice etc.), it is always imperative to drive with prudence.

System of emergency braking assistance

(For vehicles with the ABS system)

The emergency braking assistance system helps you to attain the required braking pressure more rapidly, thus to reduce the stopping distance. It operates as a function of the speed of action on the brake pedal, decreasing the resistance to this action. To prolong this action of the emergency braking assistance system, simply keep your foot on the brake pedal.

Emergency braking or sudden deceleration automatically operates the hazard warning lamps. They will cease to operate automatically, or manually if you press the hazard lamps button on the dashboard.

ELECTRONIC STABILITY PROGRAMME (ESP)



This system is associated with the ABS and in addition to the ABS. In the event of a loss of control of the vehicle by the driver, the ESP system acts automatically on one or more wheels and also on the engine to bring the vehicle back on trajectory.

Operation

The ESP warning lamp flashes in the instrument panel if the ESP system is correcting the vehicle's trajectory.

Deactivation

In exceptional conditions (vehicle stuck in snow, soft ground, etc.) it may prove useful to deactivate the ESP systems to allow the wheels to spin and thus regain traction.

- Press button **A**.
- The warning lamp associated with control **A** (**ESP Off**) lights up, as does the **ESP** warning lamp on the instrument panel.

The ESP system is no longer active.

The ESP system reactivates:

- **Automatically** after the ignition has been switched off.
- **Automatically** when you drive at above approx. **50 km/h** (approx. 30 mph) (According to version).
- **Manually** with another press on button **A**.

Operational anomaly

If the system is malfunctioning, the warning lamp ESP lights up in the instrument panel.

Contact a CITROËN dealer to have the system checked.



The ESP system offers increased driving safety but is not in place to encourage the driver to take additional risks or to drive at excessive speeds.

The functioning of this system is subject to compliance with the manufacturer's recommendations on wheels (tyres and rims), brake parts and electronic components, as well as with the assembly and repair procedures approved by CITROËN.

After any collision, have this system checked by a CITROËN dealer.

In addition to the catalytic converter, this filter contributes actively to the preserving of air quality, by collecting the polluting particles that have not been burnt off. Black exhaust fumes are thus eliminated.

Clogging of the particle filter

This alert is caused by the particle filter starting to be saturated (in exceptionally prolonged urban driving, for example: reduced speed, traffic jams, etc.).

To regenerate the filter, it is advised to drive, as soon as possible when traffic conditions permit, at a speed of 60 km/h or more for at least 5 minutes, until the alert message disappears. If this alert persists, contact a CITROËN dealer.

Note: *If the vehicle has been running for long periods at very low speeds or at idle, vapour emissions may be seen coming from the exhaust under acceleration. These have no consequences for the running of the vehicle or for the environment.*

DIESEL additive level

If the additive level is low, it is necessary to top up the additive level.

Contact a CITROËN dealer as soon as possible.

OVERSPEED ALERT

Overspeed alert

Function for keeping to a desired maximum speed.

A short press on control **E** activates this function (the warning lamp lights up).

To pre-set or modify the desired alert speed, when you have reached this speed, give a long press on control **E** (located on the dashboard central panel) until you hear a confirmation gong.

An audible signal indicates that the programmed speed is being exceeded.

To cancel

Give another short press on control **E** to deactivate this function (the warning lamp goes out).

Note: The overspeed alert only functions for speeds above around 30 km/h (around 18 mph).



II

CRUISE CONTROL

This driving assistance function allows you to drive at the speed of your choice **without the need to action the accelerator**.

This device is active at speeds above approx. 40 km/h (25 mph), in the higher gears only.

The button **A** for cruise control is located on the lighting control stalk.

Remark: The information relating to the cruise control is displayed in the instrument panel screen at **B**. This display causes the trip computer information to disappear (if it is shown on the instrument panel).

To select the function

Turn the control **1** to the “**CRUISE**” position.

To select a cruise speed



When you select the function via control **1**, no speed has yet been memorised.

Accelerate to the desired speed, then give a short press on button **2** or button **4**.

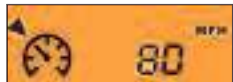

The cruise speed is then memorised. It is shown in the display on instrument panel **B**.

You can then release the accelerator pedal. The vehicle will automatically keep to that chosen speed.

Remark: The vehicle speed may vary slightly from that memorised.



Cruise control must only be used where the traffic conditions permit driving at a constant speed. Do not use it on congested roads or when the weather or the road conditions are poor.

Temporary override of the cruise speed

While cruise control is in operation, it is always possible to go above the cruise speed simply by pressing the accelerator pedal (for example to overtake another vehicle). The speed displayed flashes. You have only to release the accelerator pedal to return to your cruise speed.

Remark: If during cruise control the system cannot keep to the cruise speed (e.g. on a steep descent), then the speed flashes. If necessary, brake to curb your speed.

Adjustment of the memorised speed while cruise control is in operation

To adjust the memorised speed, displayed in zone **B**, press:

- Button **4** to increase the speed.
- Button **2** to decrease the speed.

Remark: Successive presses will modify the cruise speed in steps of 1 km/h and a continuous press in steps of 5 km/h (3 mph).

Disengagement of the memorised cruise speed.

- Either by pressing the brake pedal or the clutch pedal.
- Or by the ESP system being active.
- Or by pressing button **3**.

Note: Cruise control is deactivated if the gear lever is in neutral (position N)



These actions bring up the information "OFF" in the instrument panel display.

These actions do not cancel the cruise speed which remains displayed.

Reactivation of cruise control

• By recalling the memorised speed:

Following a disengagement, press on control **3**.

Your vehicle automatically resumes the memorised cruise speed, which then displays on the screen in instrument panel **B**.

• By selecting the current speed:

Give a short press on button **2** or **4**, once the desired speed is reached.

The information "OFF" then disappears from the display.

If the memorised cruise speed is higher than the current speed, the vehicle will accelerate to match it.

To cancel the function

- By moving the control from the "CRUISE" position to the **0** position.
- Or stop the engine.

The speed that was chosen is no longer memorised.

Remark:

While cruise control is in operation, the displayed speed flashes if the memorised speed is exceeded.

If there is a malfunction, either the memorised speed or the dashes "- -" will flash and the warning lamp "OFF" will come on permanently in the display.

Contact a CITROËN dealer.



The driver still has to remain attentive and in complete control of his vehicle.

You are recommended to keep your feet within range of the pedals.

SPEED LIMITER

This driving assistance function enables you to select a maximum speed that you wish not to exceed. **This must be greater than 30 km/h (approx. 20 mph).**

Control **A** for the speed limiter is situated below the lighting/signalling control stalk.

Remark: The information relating to the speed limiter is displayed in the instrument panel screen at **B**. This display causes the trip computer information to disappear (if it is shown on the instrument panel).

To select the function

Turn control **1** to position "LIMIT".



On selection of the function via control **1**, the last speed memorised is displayed.

To adjust the maximum speed

When the engine is running, you can adjust the memorised speed by either short presses or long presses on:

- Button **4** to increase the memorised speed.
- Button **2** to decrease the memorised speed.

Remark: Successive presses will modify the cruise speed in steps of 1 km/h and a continuous press in steps of 5 km/h (3 mph).

Activation of the maximum speed

As the desired maximum speed is displayed, press control **3** to activate the speed limitation.



The information "OFF" then disappears from the display.

While the function is active, actioning the accelerator pedal will not permit the programmed speed to be exceeded, unless you press the pedal hard down past the tight spot. See "Temporary override of the maximum speed".

Remark: The vehicle speed may vary slightly from that memorised.



Disengagement of the maximum speed

Press button **3** located on the end of control **A**.



This action causes the information “**OFF**” to appear in the instrument panel screen. The memorised speed remains displayed and is not cancelled.

Temporary override of the maximum speed

At any time, it is possible to go above the memorised maximum speed by pressing the accelerator pedal hard down past the tight spot.

While the memorised speed is being exceeded, the displayed speed flashes.

You have only to release the accelerator pedal to return below the maximum speed, to restore the function.

Remark: If during speed limitation the system cannot keep to the maximum speed (especially on a steep descent or if you accelerate too hard), the speed flashes. Adapt your speed as necessary.

The function will re-engage when your speed has returned below the desired maximum.

To cancel the function

- By moving the control from position “**LIMIT**” to position **0**.
- Or stop the engine.

The speed that you chose is memorised.

If there is a malfunction, the memorised speed will flash and the warning lamp “**OFF**” will come on permanently in the display. Contact a CITROËN dealer.



A floor covering that is not recommended by CITROËN may slide underneath the accelerator pedal and thus prevent the tight spot from being crossed.

It will then be impossible to exceed the chosen speed, except by an action on the controls under the steering wheel.

The driver still has to remain attentive and in complete control of his vehicle.

PARKING ASSISTANCE

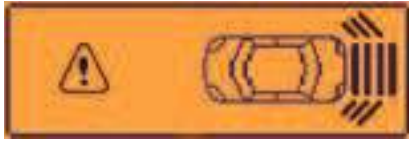

Proximity sensors are located in the rear bumper of your vehicle.

When you are manoeuvring in reverse gear at a speed of less than around 10 km/h (approx. 6 mph), they inform you of the presence of any obstacle located within their detection zone, by means of:

- An audible signal emitted by the rear loudspeakers on the LH and/or RH side.
- Display of the outline of your vehicle with shading corresponding to the area where an obstacle is detected.

As the vehicle approaches the obstacle, the sound signal becomes more and more urgent and the shaded areas are displayed closer and closer to the vehicle.

When the obstacle is less than around 25 centimetres from the vehicle, the sound signal becomes continuous with display of a **“WARNING”** panel on the screen.



Activation/Deactivation

You can activate/deactivate the parking assistance by pressing button **1**. When the parking assistance is inactive, the warning lamp on button **1** is lit up.

Activation/deactivation of the parking assistance is memorised when you stop the vehicle.

Remark: The system is deactivated automatically if a trailer is attached to the vehicle.

The fitting of the towbar should be carried out by the CITROËN network.

Operation

When you engage reverse gear, a sound signal confirms to you that the system is active. The outline of your vehicle appears on the screen. Any obstacles situated to the rear of your vehicle can be detected.

Remarks:

- The proximity sensors cannot detect objects that are immediately under or over the bumpers.
- A thin object such as a spike, a bollard or similar, can only be detected at the start of the manoeuvre but not when the vehicle arrives close up to it.
- In poor weather or in winter, you need to ensure that the sensors are not covered with mud or with ice or snow.



Locking from the inside

A press on the control **A** operates the electric central locking and unlocking, provided all the doors are closed.

It is still possible to open the doors from the inside.

If one of the doors or the tailgate is open or not properly closed, the central locking does not operate.

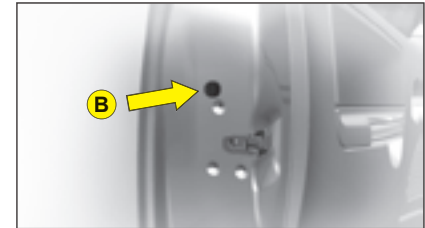

Manual operation (Emergency mode)

It is possible to lock the vehicle's doors, in the event of an electrical malfunction, by actioning control **B** on each door.

With the door open, insert for example the end of a key into the cavity and turn.

Then close the door.

After a repair, normal functioning resumes by means of the unlocking control **A**, the remote control or the key used in the driver's door.

The warning lamp associated with the control **A** signals 3 statuses:

- It flashes when the ignition key is in the stop position or when the key is not detected and the doors are locked.
- It lights up when the ignition key is in the “accessories” position or “ignition + engine running” or starter position and if the doors are locked.
- It goes out when the doors are not locked.

Note: Control **A** is inactive if the vehicle has been locked using the remote control or the key.

Anti-theft

In all cases, as soon as the vehicle is moving above a speed of 10 km/h (approx. 6 mph), the tailgate locks automatically. The tailgate unlocks when a door is opened or when the interior locking/unlocking control is actioned.

Anti-theft protection

On starting the vehicle, the system automatically locks the doors as soon as you reach approximately 10 km/h (approx. 6 mph).

Note: If a door has been opened, this will lock again automatically when the vehicle reaches approx. 10 km/h (approx. 6 mph).

Activation / Deactivation of the function

After switching on the ignition, give a long press on the central unlocking button until a message is displayed.

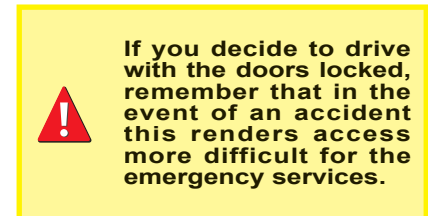

ACCESS



The boot can be accessed in two ways:

Open the upper tailgate **1** by pressing control **A** (The luggage-cover folds automatically against the upper tailgate to permit rapid access to the boot contents).

Open the upper tailgate **1** by pressing control **A**, then the lower tailgate **2** by moving control **B**.

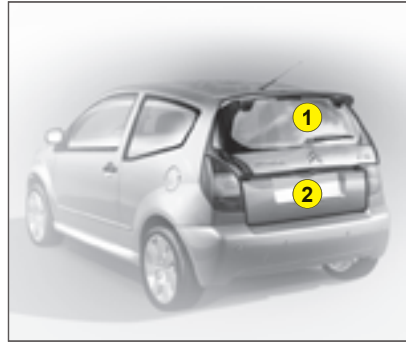

Closing the upper and lower rear tailgates

Close tailgate **2**, then tailgate **1**.

Note: As soon as the vehicle is moving at around 10 km/h (approx. 6 mph), the tailgates lock automatically.

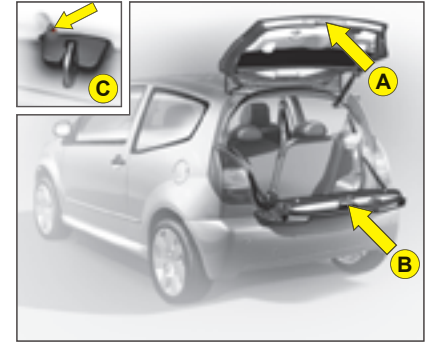

Unlocking in emergency

In the event of a malfunction in unlocking of the upper tailgate, it can be unlocked from the boot interior:

- Insert a screwdriver into the aperture **C** in the lock.
- Move it until the upper tailgate unlocks.



It is necessary to open the upper tailgate in order to access the opening control for the lower tailgate.

Always close the lower tailgate before reclosing the upper tailgate.

The lower tailgate can support spread loads of up to 100 kg.

VENTILATION - HEATING



Warning: The automatic air conditioning system uses a temperature sensor located on the dashboard (see reference A), this sensor should not be obstructed.

VENTILATION - HEATING - MANUAL AIR CONDITIONING

1. Air distribution



Air flow to the face level vents
(Air vents open)



Air flow to the front and rear footwells
(Air vents closed)



Air flow to the footwells and windscreen and side windows



Air flow to the windscreen and side windows
Demisting - Defrosting

Distribution from the air blower can be altered at will by placing the distributor **1** in an intermediate position.

2. Cabin air



Air recirculation

This position is useful for excluding undesirable odours or fumes coming from outside. It should be cancelled as soon as possible in order to permit renewal of air in the cabin and to prevent misting.

3. Heater blower control

The air blower operates only when the engine is running. For optimum comfort in the passenger compartment, the control should not remain in position **0** (position **1** minimum).

4. Temperature control

5. Air conditioning

6. Demisting - deicing of the rear screen.

MANUAL AIR CONDITIONING

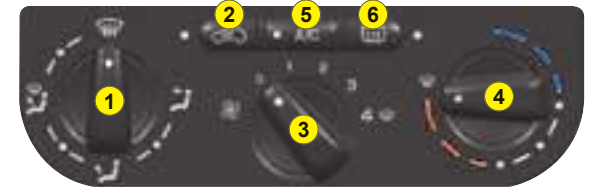
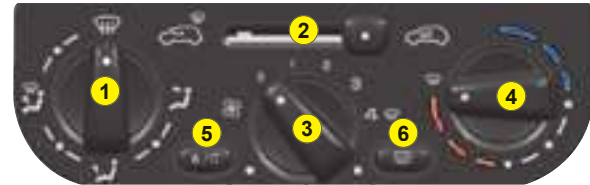

VENTILATION - HEATING

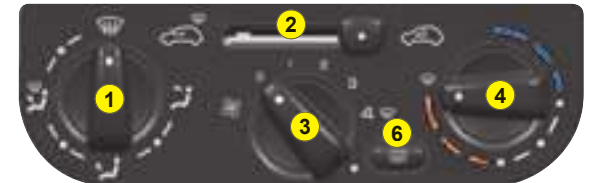

Air inlet

Check that the exterior grille for the air inlet, at the bottom of the windscreen, is clean and free of dead leaves, snow, etc.

If washing the vehicle with a high pressure jet, avoid targeting the air inlet zone.

Air vents

The air vents to the face (except the central air vent) have grilles for orienting the flow of air (up-down, right-left).

Air circulation

For your comfort we advise you to maintain a proper distribution of air within the cabin, both at the front and at the rear.

Air outlets are also located on the central console close to the gear lever, to enhance comfort for the rear passengers.

Pollen filter – Odour filter

Your installation has a filter for keeping out dust.

This filter has to be changed according to the vehicle maintenance schedule. See “Maintenance Guide”.

Air conditioning

Whatever the time of year, even in cool weather the air conditioning is useful in removing humidity and misting.

To keep the air conditioning compressor well sealed, it is essential to operate the air conditioning at least once in every month.

To be effective, the air conditioning should only be used with the windows closed.

If you are towing a heavy trailer and outside temperatures are high, the air conditioning may be temporarily paused if the engine cooling requires this.

Water arising from condensation in the air conditioning system is evacuated through a hole provided for this purpose ; a pool of water may thus form underneath the vehicle when stationary.

You are advised to have the air conditioning system checked on a regular basis. See “Maintenance Guide”.

The air conditioning operates by using power from the engine. This results in a slight increase in fuel consumption.



Demisting - deicing of the windscreen and front side windows

- Place the controls for temperature and air flow on maximum.
- Close the central air vents.
- Operate the air conditioning.

Note: You should not be in air recirculation.

VENTILATION - HEATING - MANUAL AIR CONDITIONING

1. Air distribution



Air flow to the face level vents
(Air vents open)



Air flow to the front and rear footwells
(Air vents closed)



Air flow to the footwells and windscreen and side windows



Air flow to the windscreen and side windows
Demisting - Defrosting

Distribution from the air blower can be altered at will by placing the distributor **1** in an intermediate position.

2. Cabin air



Air recirculation

This position is useful for excluding undesirable odours or fumes coming from outside. It should be cancelled as soon as possible in order to permit renewal of air in the cabin and to prevent misting.

3. Heater blower control

The air blower operates only when the engine is running. For optimum comfort in the passenger compartment, the control should not remain in position **0** (position **1** minimum).

4. Temperature control

5. Air conditioning

6. Demisting - deicing of the rear screen.

MANUAL AIR CONDITIONING

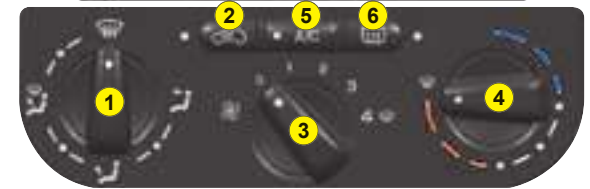
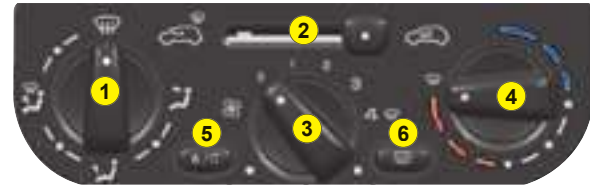

VENTILATION - HEATING

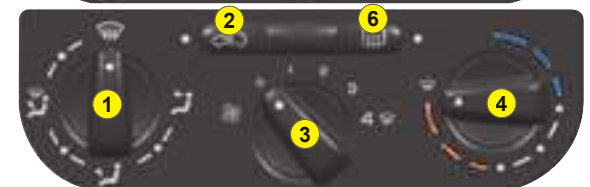
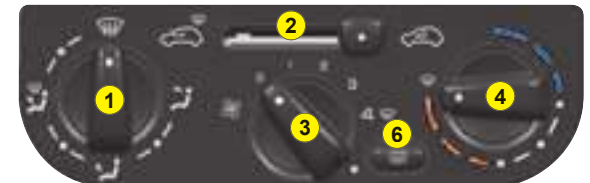

MANUAL AIR CONDITIONING



Air conditioning

The air conditioning only operates when the engine is running.

Press the control located on the control panel.

Warning lamp on = in operation

Air conditioning is obtained by the mixing of hot air and cold air. Control **4** allows you to adjust the air conditioning while control **5** is in operation.

To obtain refrigerated air, you should check that the air blower control **3** is not on position "0".

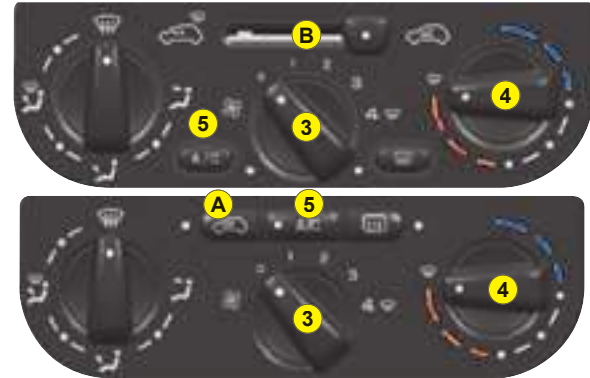

Air recirculation

This function isolates the passenger compartment from disagreeable odours or smoke coming from outside and increases the efficiency and rapidity of the air conditioning.

According to version, press on control **A** (warning lamp comes on), or move control **B**.

The entry of air from outside is blocked.

This function should be cancelled when no longer needed in order to permit a renewal of cabin air and to prevent misting.

Note: To obtain a rapid rise in cabin temperature, place control **A** or **B** in the air recirculation position and control **4** on maximum in the red zone.

If after a prolonged stop in bright sunlight, the cabin temperature is very high:

- Open the windows for a few moments to let in air, then close the windows again.
- Adjust the temperature on control **4** to the maximum cold position.
- Open the air vents.
- Use the recycled cabin air position.
- Place the air blower control **3** to the position close to maximum.
- With comfort restored, action the air blower **3** and the temperature control **4** to adjust comfort.

AUTOMATIC AIR CONDITIONING

Control panel

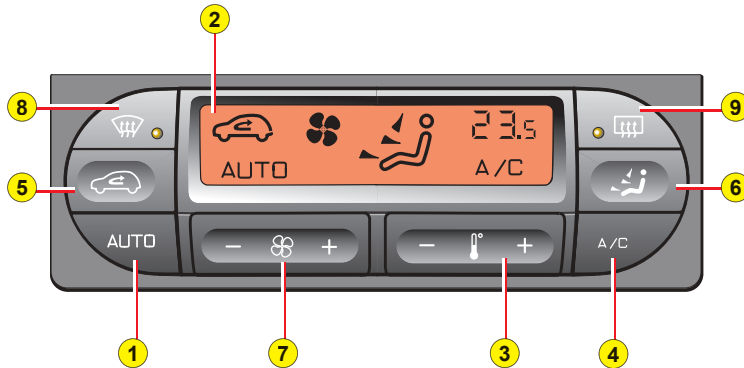

1. Automatic air conditioning
2. Display
3. Temperature adjustment
4. Air conditioning
5. Air recirculation
6. Air distribution
7. Air flow
8. Demisting - deicing of the windscreen and front side windows
9. Demisting - deicing of the rear screen

The temperature inside the cabin cannot be lower than the temperature outside if the air conditioning is not operating.

The air conditioning maintains optimum comfort whatever the climatic conditions, through permanent automatic operation (you have pressed the "AUTO" button).

Note: The automatic mode only calls for conditioned air in order to attain the desired cabin temperature or to remove air humidity. Therefore the air conditioning warning lamp may come on only intermittently.

2. Display

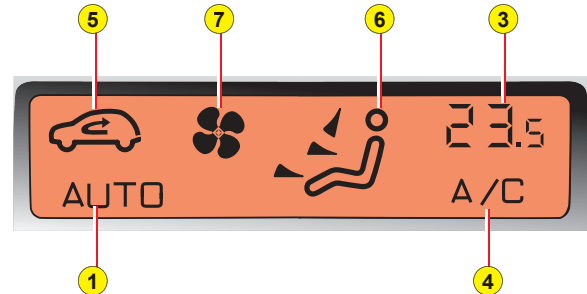

AUTOMATIC AIR CONDITIONING

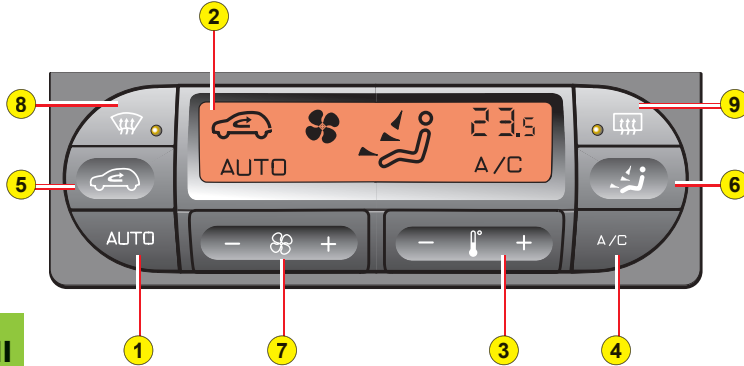

1. Automatic operation

This is the normal operating mode for the system.

A press on this button, confirmed by "AUTO" on the display, assures auto-

matic control of:

- The air flow.
- The cabin temperature.
- The air distribution.
- Air recirculation.
- Air conditioning.

To revert to manual mode, press again on the button.

2. Display



3. Temperature adjustment



To obtain the desired temperature, press the appropriate key:

- To lower the temperature.
- + To raise the temperature.

An adjustment around 22°C will give you a temperature that is comfortable.

You may wish to vary this between 20°C and 24°C according to your preference.

HI (high): Demand for maximum heat.

LO (low): Demand for maximum cold.

Note:

- When starting from cold, in order to prevent unwanted cold air, the air flow will increase only gradually to its optimum level.
- On entering the vehicle after a prolonged stop, when the interior temperature has again become too cold (or too hot) for comfort, do not alter the temperature setting to try and restore the desired comfort level. The system automatically uses all of its power to compensate the temperature gap as quickly as possible.

Manual recalling of one or more functions

One or more functions can be adjusted manually, while still retaining the other functions in automatic mode. The function display “**AUTO**” then goes out.



4. Air conditioning

Press the control located on the control panel.

A symbol appears on the display (system active).
To prevent misting inside the vehicle in cold or humid weather, you are advised to use the **AUTO** mode.
Press on the control on the dashboard to activate or deactivate the production of cold air.
Air conditioning is then obtained from the mixing of hot air with cold air, using the air blower temperature adjustment **3**.



5. Air recirculation

By pressing the control, the entry of air from outside is closed off and the symbol appears on the display.

This position is useful for excluding undesirable odours or fumes coming from outside. It should be cancelled as soon as possible in order to permit renewal of air in the cabin and to prevent misting.
For this, press the “**AUTO**” button or press again on the air recycling button.



6. Air distribution

Press on the button to scroll through the displays of air flow to:



Windscreen.



Central and lateral air vents. Windscreen and passenger footwells.



Windscreen and passenger footwells.



Passenger footwells.
(Air vents closed).



Central and lateral air vents and passenger footwells.



Central and lateral air vents.

Note: In **AUTO** position the air distribution displayed is that chosen by the system.

AUTOMATIC AIR CONDITIONING



7. Air flow

Heater blower control. Press button:



To increase it.



To decrease it.



The level of air flow is indicated on the display by the progressive filling of the fan blades (seven possible adjustment positions).

Note: If you place the air blower on position **0**, the system is deactivated (the display disappears).

Note: In **AUTO** position the air flow displayed is that chosen by the system.



8. Demisting - Defrosting

While it is operating, the warning lamp lights and the symbol appears on the display.

This control is for rapid deicing or demisting of the windscreen and side windows. It automatically triggers the air conditioning, optimising air flow and air distribution for the continued comfort of the vehicle occupants.

To stop it, press again either on the button **8** or on the button **"AUTO"**.



9. Demisting - deicing of the rear screen



Press AUTO to return the system to its automatic function.

FRONT SEATS



FRONT SEATS

Manual adjustments



Head restraint

To raise or lower the head restraint, pull it forwards at the same time as sliding it.

The adjustment is correct when the top edge of the head restraint is at the same height as the top of the head.

To remove it, bring it to the high position. Lift the tab with the aid of a coin and pull.



Backrest angle

Action the control rearwards and adjust the angle of the backrest.

It is possible to recline the backrest to an angle of 45° by tilting it until it locks. Press the control to unlock.



Reach

Lift the control bar and adjust to the desired position.



Seat height and rake adjustment

Lift the control and use the weight of your body to move the seat to the desired position.



Access to the rear seat positions

To access the rear seat positions, action the control forwards to fold the backrest and slide the front seat.

Afterwards the front seat will revert to its initial position.

Make sure that the seat is secured in place (particularly if the rear seats are folded).



Heated seats

The front seats can be heated individually. Use the controls located at the side of the seats, and select one of the three heating levels:

0: Off.

1: Slight heat.

2: Medium heat.

3: Maximum heat.

The seat temperature adjusts automatically.

Note: The heated seats only operate when the engine is running.

REAR SEATS

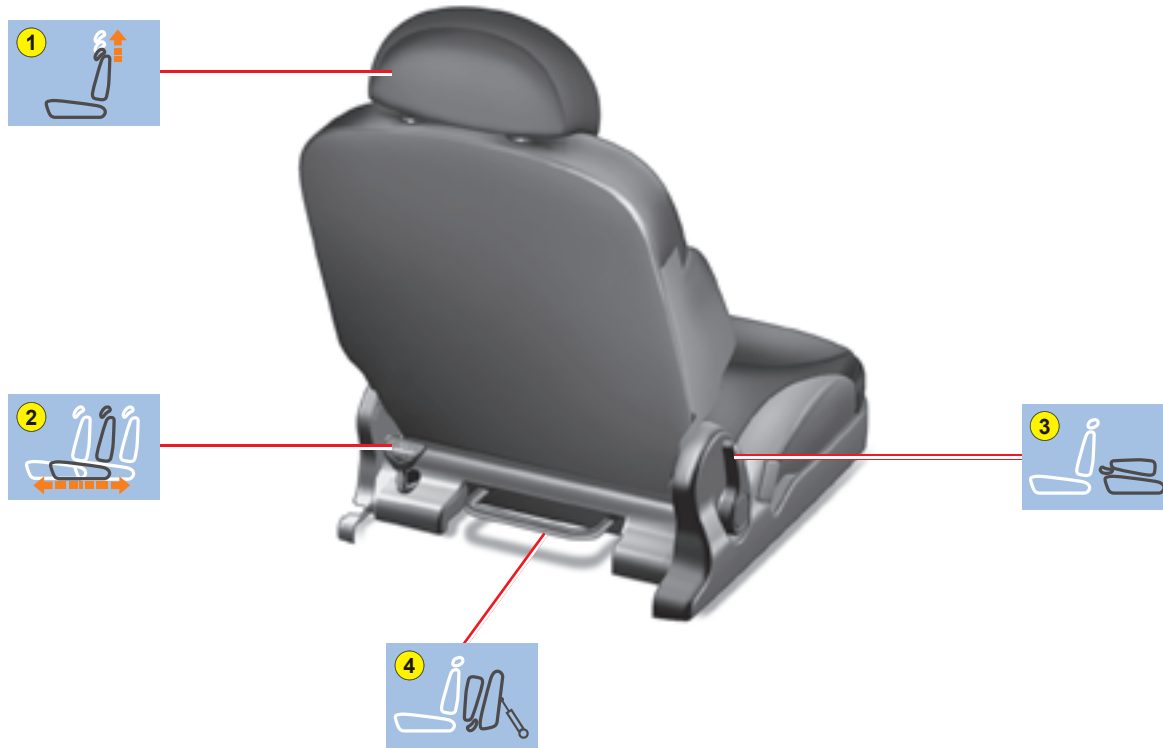

For ease of handling from the boot, it is advised to close the lower tailgate.



REAR SEATS

The function **3** is available on all models. The other functions are available depending on the version of your vehicle.



Rear head restraints

The rear head restraints have two positions:

- A stowed position for when the seat is not occupied.
- A deployed position to provide passenger safety, by raising them to their locking point.

To raise them, pull them upwards to their maximum height, pressing the unlocking button.



Fore and aft adjustment

From the boot, it is possible to modify the loadspace by sliding the seats.

Push down control **2** and adjust to the desired position.

At the front of the seat, it is also possible to adjust knee room.

Raise the bar located under the seat and adjust to the desired position (several positions).



Foldable backrest

It can be folded either totally or partially.

Lower the head restraint against the backrest, then pivot control **3** towards the rear of the vehicle.

The backrest also has a vertical position to optimise the bootspace.

When you reposition the backrest, make sure that it locks in place.



Folded (fully-folded position)

To facilitate this manoeuvre, slide the front seat as far forward as possible, using the fore/aft slide control.

Move the rear seat as far forward as possible using control **2**, fold the backrest using control **3**, then lift control **4**.

The seat goes automatically to the fully-folded position.

Reposition the front seat. The rear seat in the fully-folded position will adapt automatically to the position of the front seat.

When restoring the seat to its original position, check that there is nothing obstructing the anchoring points to ensure that it latches properly.

SEAT CONFIGURATION

TRANSPORTING LONG OBJECTS

REAR SEATS

By configuring the rear seats, you can create space for a variety of objects. As a safety measure, use the anchoring rings positioned on the boot floor.



4-seater versions



Versions with folding backrests



Versions with fully-folding seats



AIRBAGS



Front passenger's airbag deactivation

In order to be able to use a rear-facing child seat in the front passenger's seat position, it is imperative to deactivate the passenger's airbag.

For that:

- With the ignition switched off, insert the key into the switch **A**.
- Turn the key to the “**OFF**” position, the passenger's airbag is deactivated.
- The front passenger's airbag deactivation warning lamp, in the instrument panel, lights up when you switch on the ignition.

Reactivating the front passenger's airbag

Do not forget to reactivate the function.

For that:

- With the ignition switched off, insert the key into the switch **A**.
- Turn the key to the “**ON**” position, the airbag is activated.
- The warning lamp in the instrument panel lights up for a few seconds when you switch on the ignition.

In the front passenger's seat position, it is imperative to deactivate the front passenger's airbag if you are installing a “rear-facing” child seat there. Otherwise the child risks being killed or seriously injured should the airbag deploy.

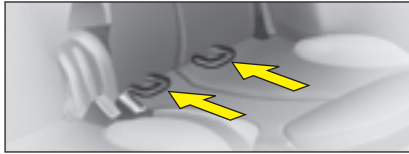

ISOFIX anchoring points and the ISOFIX fastening system

The rear seats of your vehicle are equipped with ISOFIX anchoring points. These consist of 2 rings located between the backrest and the vehicle seat, approx. 28 cm apart.

ISOFIX child seats are equipped with 2 latches which are easy to attach to these rings. This fixing system is intended for children weighing **up to 18 kg**.

Incorrect installation of a child seat in a vehicle compromises protection of the child in the event of a collision. The ISOFIX system enables you to minimise the risks posed by incorrect fitting. The ISOFIX fastening system gives you a convenient, strong and reliable fitting for a child seat in your vehicle.

The ISOFIX child seats approved (1) for your vehicle are:

The KIDDY ISOFIX (1):

This is marketed in the CITROËN network. It can be installed “rear-facing” from birth to 13 kg and “forward-facing” from 9 to 18 kg.

Advice on installing your KIDDY ISOFIX child seat:

- When this seat is installed “forward-facing”, the vehicle front seat should be adjusted to an intermediate fore/aft position, backrest upright.
- If “rear-facing”, the shell of the child seat should be in contact with the backrest of the vehicle front seat.
- The “rear-facing” position for the Isofix KIDDY is not authorised on seats that are individually adjustable.

The RÖMER Duo ISOFIX (1):

This child seat is approved for children from 9 to 18 kg. It must be installed only in the “forward-facing” position. The vehicle's corresponding front seat should be adjusted so that the child's feet are not touching its backrest (slide the rear seat as far rearwards as possible). The use of the top belt, called Top Tether, is not necessary.

These child seats can also be installed in seat positions that are not equipped with ISOFIX anchorages. In this case, they must be secured to the vehicle seat by means of the vehicle seat belt.

(1): On ISOFIX anchorages, you may fix only the ISOFIX child seats that are approved for your vehicle.

CHILD RESTRAINTS

Child seats secured by means of the vehicle seat belt

In conformity with Directive 2000/3, the table tells you to what extent each of the seat positions in your vehicle may take a child seat that is secured by means of the vehicle seat belt and approved as “Universal” as a function of the weight of the child.

Consult “User Precautions”, chapter on “Child Safety” at the end of this handbook, in order to ensure that you are installing your child in conditions of maximum safety.

Seat position(s)		Weight of child			
		Up to 10 kg and up to 13 kg (groups 0 and 0+)	9 - 18 kg (group 1)	15 - 25 kg (group 2)	22 - 36 kg (group 3)
Front passenger's (a)	Fixed seat	U	U	U	U
	Height-adjustable seat	U(R)	U(R)	U(R)	U(R)
Rear passenger's seat		U	U	U	U

KEY TO THE TABLE

U: Seat position suitable for the installation of a universal rear-facing child seat and a universal forward-facing child seat position.

U(R): Seat position suitable for installation of a universal rear-facing child seat and of a forward-facing seat. The vehicle seat should be adjusted to the highest position.

(a): In the front passenger's seat position, it is imperative to deactivate the front passenger's airbag if you are installing a “rear-facing” child seat there. Otherwise the child risks being killed or seriously injured should the airbag deploy. Before placing your child in the front passenger's seat position, consult the legislation currently in force in your country on the carrying of children in this position.



Take care to comply with the fitting instructions given in the child seat manufacturer's installation guide.

INTERIOR LIGHTING

1. Interior lamps

Move the control **1** to the 3 following positions.



In this position, the interior lamp comes on when you open a door or the boot.



In this position, it is deactivated and remains permanently off. The spotlamps are deactivated.



In this position, lighting is permanent.

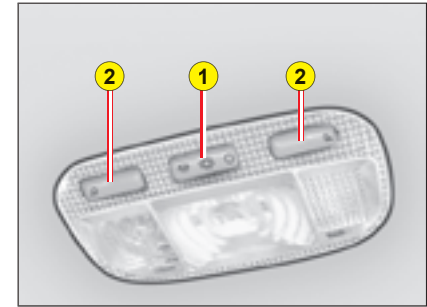

Automatic lighting of the interior lamps

- On entering the vehicle:
 - They come on as soon as the vehicle is unlocked or a door is opened.
 - They go out 30 seconds after the doors are closed or when ignition is switched on.
- On vacating the vehicle:
 - They come on as soon as the ignition key is removed (timed for 30 seconds), or when a door is opened.
 - They go out 30 seconds after all the doors have been closed or immediately after the vehicle has been locked.

2. Spotlamps

A press on one of the buttons **2** switches the corresponding spotlamp on or off.

These do not work if the ignition is off or in economy mode.

INTERIOR COMFORT



Lower glovebox

To open, pull the handle and lower the lid.

It comprises a storage area for vehicle documents.



Storage/CD changer



Oddments tray on front central console

WARNING

WARNING: As a safety measure, the glovebox must remain shut when the vehicle is in motion.



Storage pockets in the front doors



Cigar-lighter

Functions when the ignition is switched on.

Push in and wait a few moments. The cigar lighter will release automatically.



Ashtray

A movable ashtray can be placed in the cupholder locations on the central console and in the storage pockets of the rear panels.

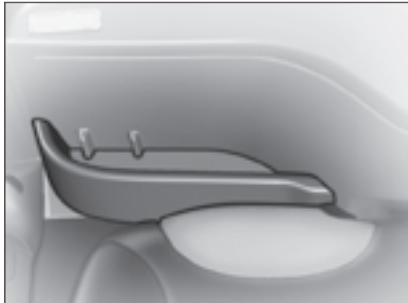

Storage pockets in the rear panels



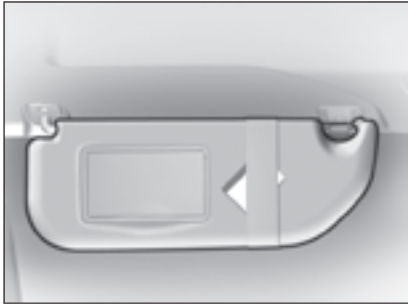

Sun visor

To prevent dazzle from ahead, fold the visor downwards. They can be disengaged from their central fixing and pivoted over to the side windows if required.

The passenger's and driver's sun visors each have a mirror that can be covered.

Sun visor with illuminated mirror

Illuminates automatically on opening the mirror cover flap (ignition on).

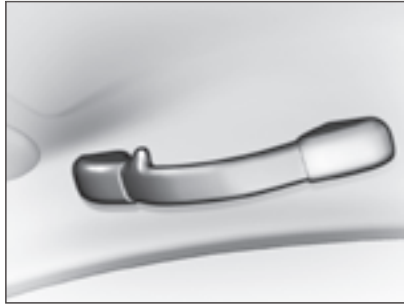

Grab handles/Coat hanger hook



Storage areas

Straps fixed to the bottom of the boot enable you to secure objects stowed there.

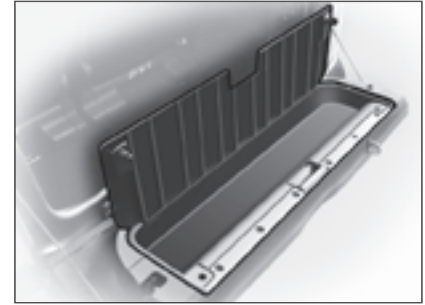

Lower tailgate storage

Lift up the two levers located on the lower tailgate to open the cover and access the storage area.

Storage capacity : 5 litres.



The lower tailgate can support spread loads of up to 100 kg.

REAR PARCEL SHELF

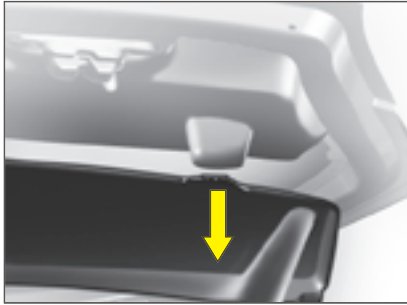

Removal

- Open the upper tailgate.
- Detach the parcel shelf cords.
- Pull firmly downwards to disengage the hinge pivots.

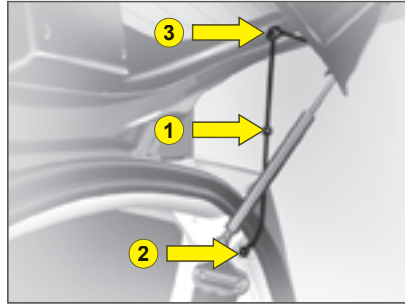

Refitting

- Open the upper tailgate.
- orient the underside of the shelf towards you.
- introduce the two hinge pivots into the apertures located on the upper tailgate trim.
- attach the cords (on the right hand side: take care to pass the cord to the outside of the upper tailgate strut, positioning the ball **1** of the cord between the boot attachment **2** and the tailgate hinge **3**).

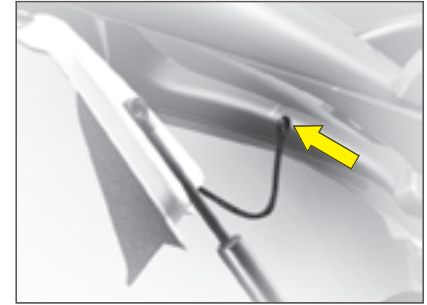

**Do not place any hard or heavy item on the shelf.
These could be dangerous if thrown around during harsh braking or, if they touch the rear screen, could damage the heating elements.**

BONNET RELEASE



Bonnet

This operation should only be performed while the vehicle is stationary.

To release the bonnet, pull the control located under the dashboard towards you.

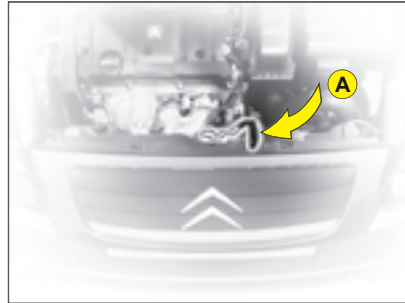

Operate the lever **A**, located above the grille, to the right of the chevrons, then lift.

Note: *The panel may be hot after the vehicle has been in use.*

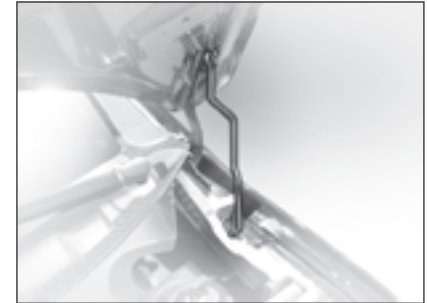

Bonnet stay: Unclip the stay and pivot to lodge it in the notch.

To close

Return the bonnet stay to its initial position.

Check that nothing has been left on top of the engine and that any component that was moved has been correctly repositioned.

Lower the bonnet carefully, then let it drop shut.

IV

**Check that the bonnet is properly secured.
Avoid opening the bonnet in high winds.**

A Air filter

Follow the requirements set out in the Maintenance Guide.



Windscreen/rear screen wash and headlamp wash fluid

Use CITROËN-approved products wherever possible.

Capacity: See “Capacities”.



Engine coolant

The fluid level should be between the marks **MIN.** and **MAX.** on the header tank.

Engine hot, wait at least 15 minutes.

Quality: See “Maintenance Guide”.

Never do anything relating to the cooling system of an engine that is hot.



12V battery

See “Starting with a slave battery”.



Engine oil

Check the engine oil level on horizontal ground with the engine having been switched off for at least 10 minutes.

Quality: See “Maintenance Guide”.



Pull out the manual dipstick.

The level should be between the marks **MIN.** and **MAX.** on the gauge.

It must never exceed the maximum.

MAX.

MIN.



Brake fluid

The level of fluid should be between the marks **MIN.** and **MAX.** on the reservoir.

Quality: See “Maintenance Guide”.

If the warning lamp comes on while you are driving, stop immediately and contact a CITROËN dealer.

B

Cabin particle filter/ Odour filter

See “Maintenance Guide”.



If opening the bonnet when the engine is hot, even if it is stopped and the ignition is switched off, remember that the cooling fan may operate at any moment.

Consult “User Precautions ” at the end of this handbook.

LEVELS

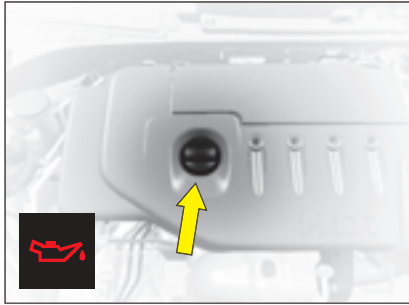

Engine oil

Check the engine oil level on horizontal ground with the engine having been switched off for at least 10 minutes.

Pull out the manual dipstick.

The level should be between the marks **MIN.** and **MAX.** on the gauge.

Topping up engine oil

Before filling, pull out the dipstick. Check the dipstick after filling.

It must never exceed the maximum.

Screw the cap back on and close the bonnet.

Quality: See the Maintenance Guide.

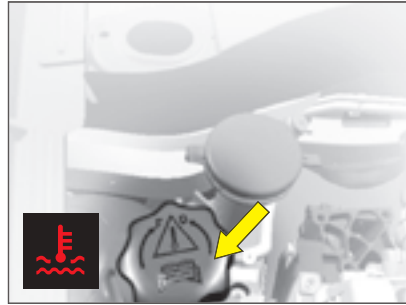

Radiator – coolant fluid

Checking the level and topping up with fluid must always be done with the engine cold.

Engine hot

Release the protection cover.

Wait 15 minutes or for the temperature to be lower than 100°C and then carefully unscrew the cap so as to allow the pressure to drop, protecting yourself with, say, a cloth.

Topping up the coolant

The fluid level should be between the marks **MIN.** and **MAX.** on the header tank.

Top up the level. If you have to put in more than 1 litre, have the cooling system checked by a CITROËN dealer.



Make sure that the cap is back on properly.

Note: If you need to top up the fluid frequently, this indicates a malfunction which you should get checked at the earliest opportunity.

Quality: See the Maintenance Guide.

Remark: The cooling fan may operate for around 10 minutes after the engine has stopped.



If opening the bonnet when the engine is hot, even if it is stopped and the ignition is switched off, remember that the cooling fan may operate at any moment.

1.1i ENGINE
1.4i ENGINE

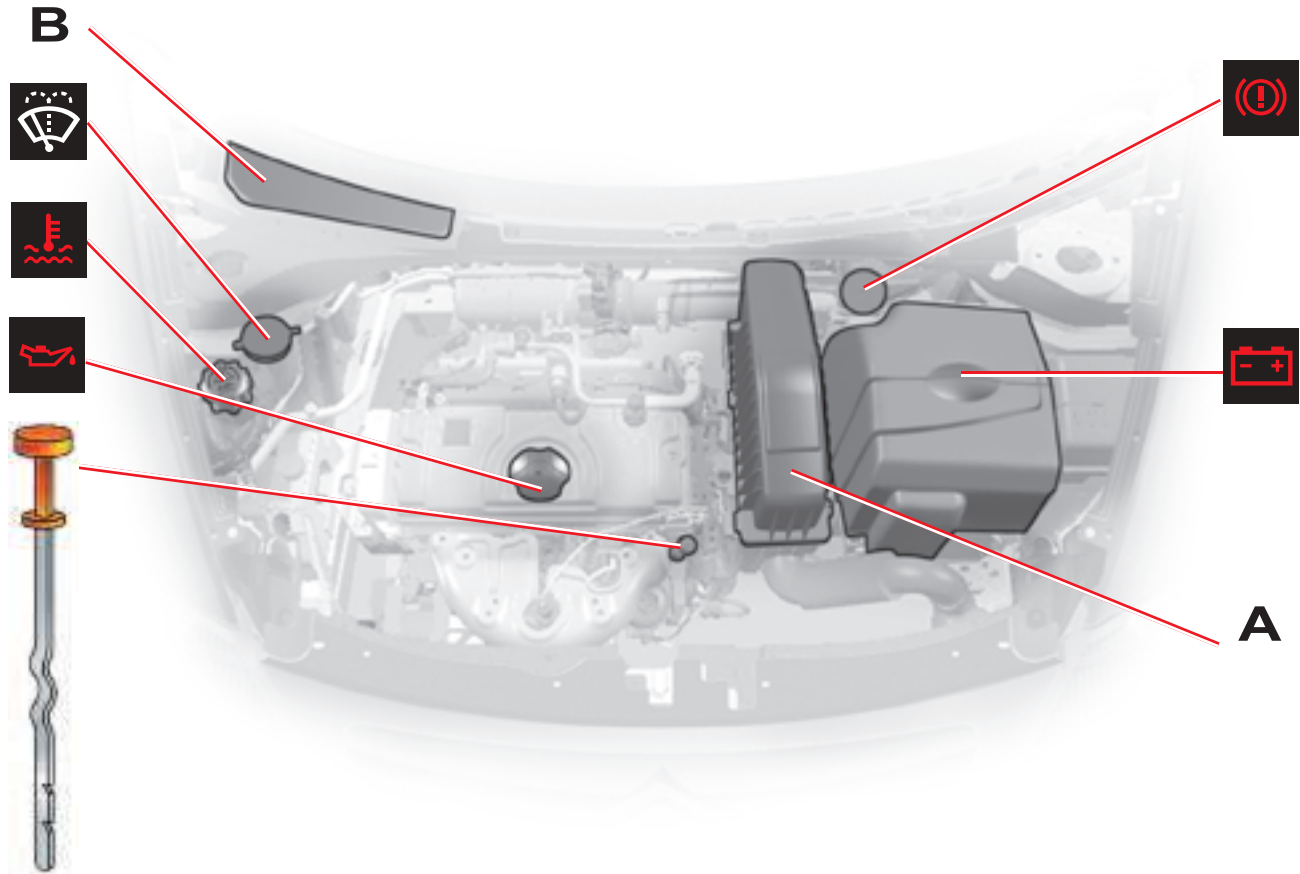

1.6i 16V 110 hp ENGINE

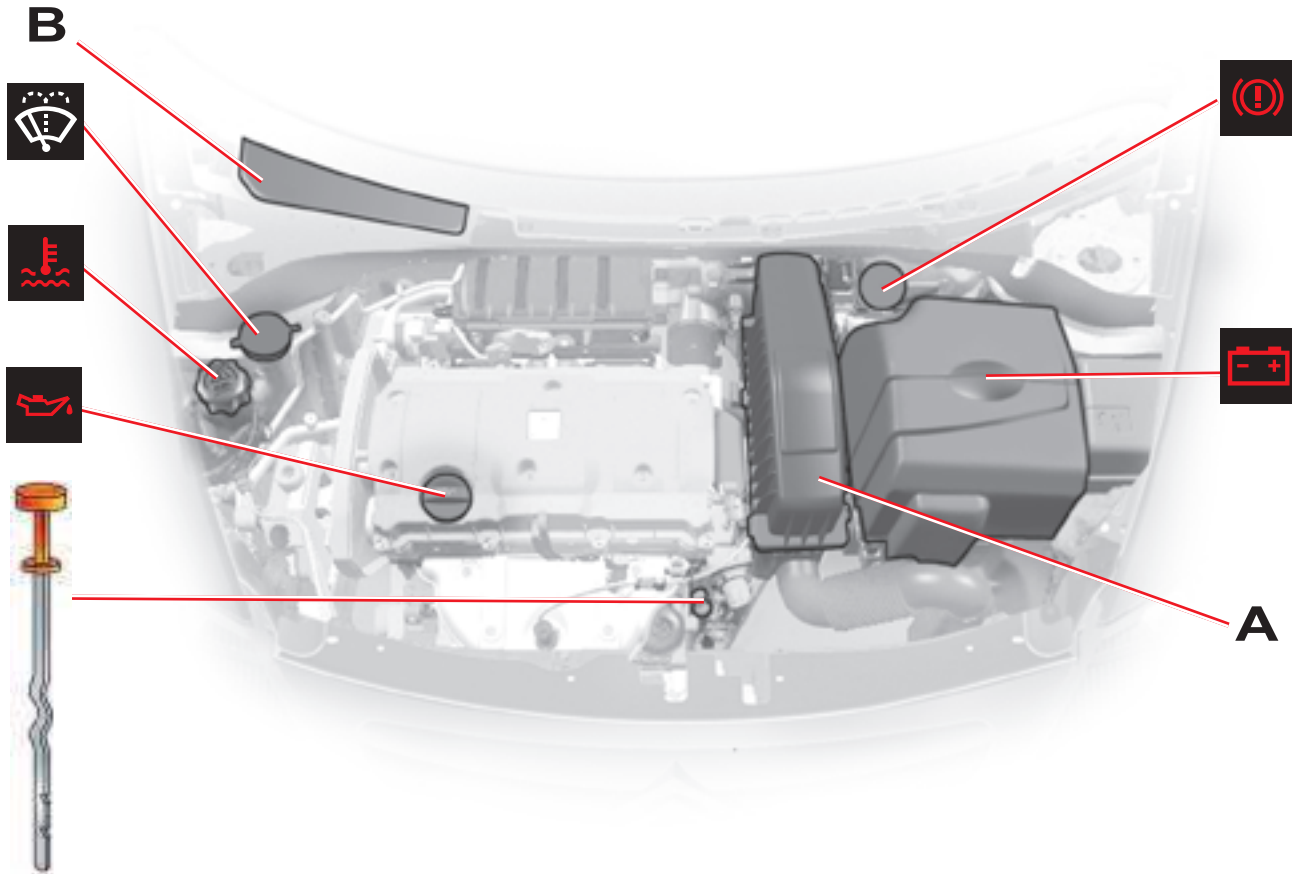

1.6i 16V 125 hp ENGINE

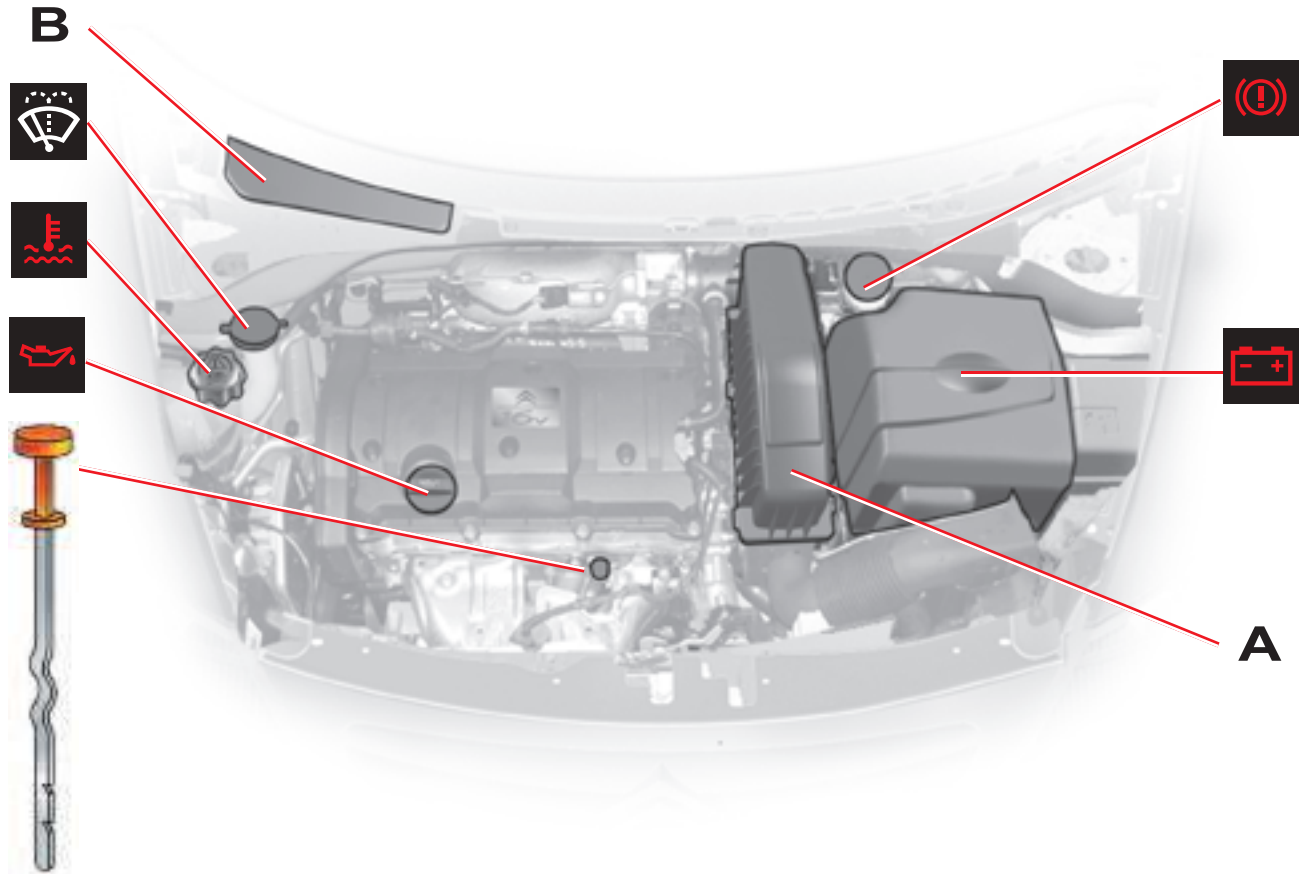

HDi 70 ENGINE

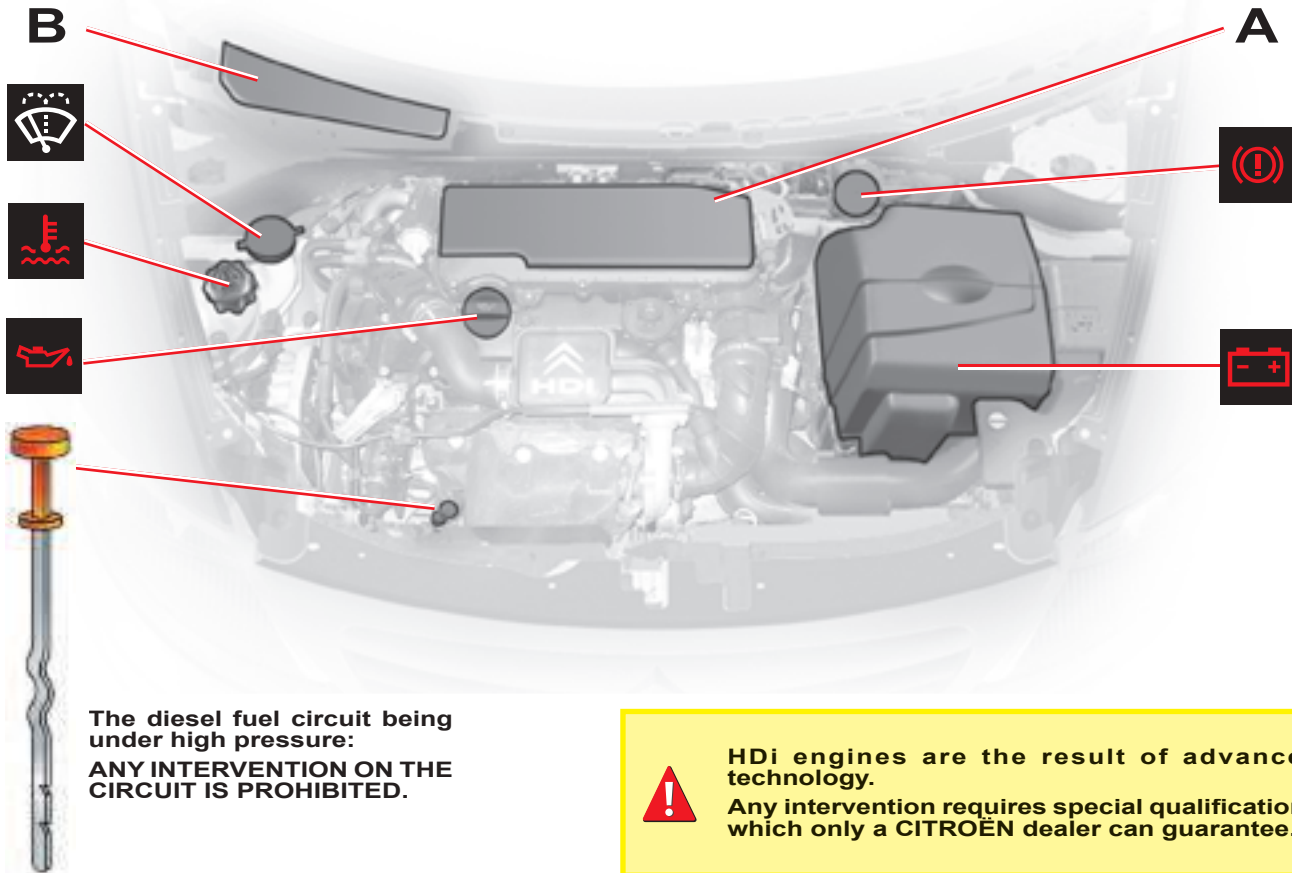

The diesel fuel circuit being under high pressure:
ANY INTERVENTION ON THE CIRCUIT IS PROHIBITED.



Hdi engines are the result of advanced technology.
Any intervention requires special qualifications which only a CITROËN dealer can guarantee.

1.6 HDi 110 hp ENGINE

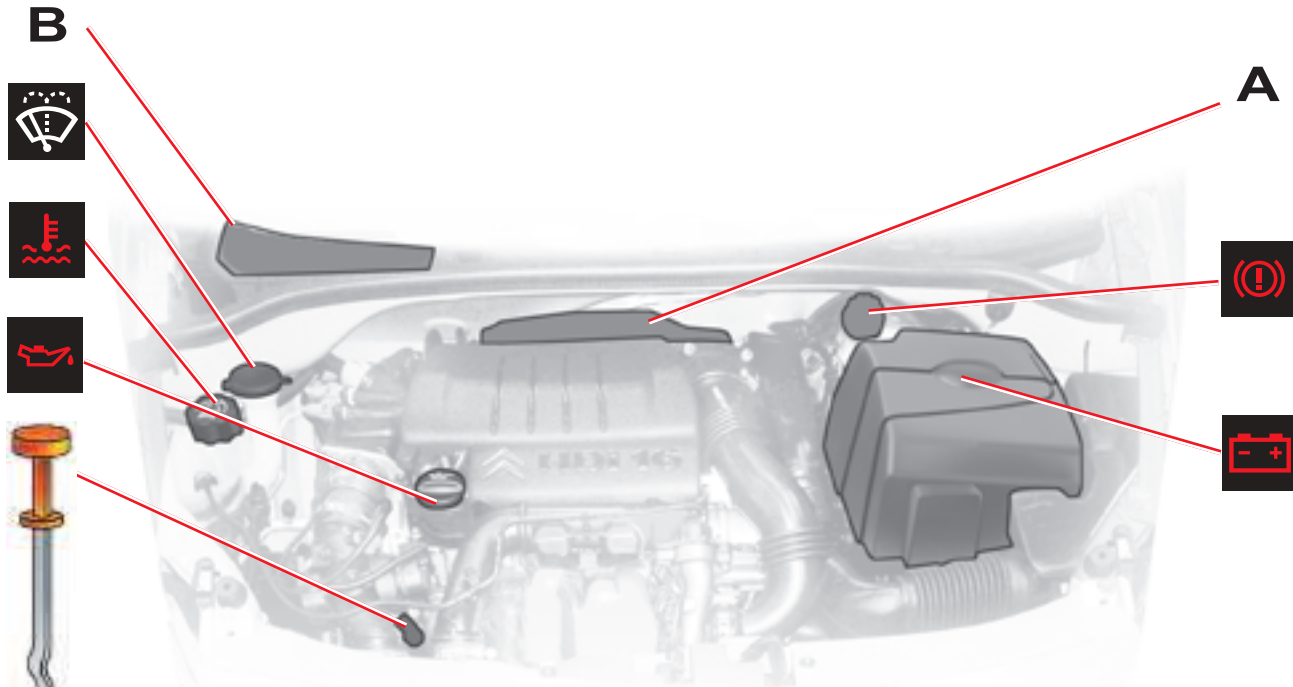

IV

The diesel fuel circuit being under high pressure:
ANY INTERVENTION ON THE CIRCUIT IS PROHIBITED.



**Hdi engines are the result of advanced technology.
Any intervention requires special qualifications which only a CITROËN dealer can guarantee.**

DIESEL INJECTION EQUIPMENT

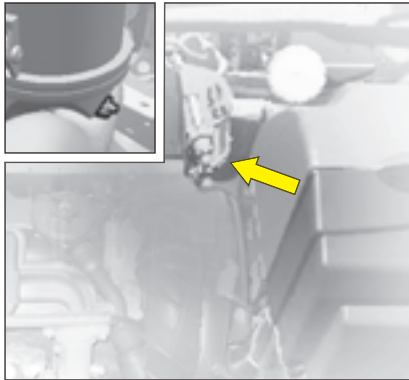

HDi 70 engine

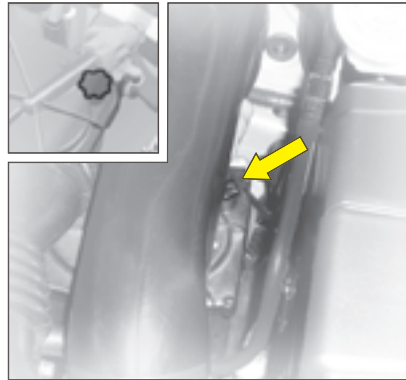

1.6 HDi engine

Draining water from the fuel filter

Purge regularly (at each oil change).

To drain the water, slacken the bleed screw or the water-in-diesel-fuel sensor located at the base of the filter.

Operate until the water has completely drained away.

Then retighten the bleed screw or the water in diesel fuel sensor.



**HDi engines are the result of advanced technology.
Any intervention requires special qualifications which only a
CITROËN dealer can guarantee.**



HDi 70 engine



1.6 HDi engine

Detach the protection cover to access the priming pump.

Priming the fuel system

In the event of running out of fuel:

- After filling (5 litres minimum), operate the manual priming pump until some resistance is felt.
- Operate the starter motor while depressing the accelerator pedal slightly until the engine starts.

If the engine fails to start at the first attempt, wait 15 seconds before trying again.

If the engine fails to start after several attempts, repeat the procedure from the beginning.

When the engine is idling, accelerate slightly to complete the bleeding of the circuit.



HDi engines are the result of advanced technology.

Any intervention requires special qualifications which only a CITROËN dealer can guarantee.

CAPACITIES

Screen wash fluid (in litres)	3.5
Screen and headlamp wash fluid (in litres)	6

Engine type	Engine oil capacities (in litres) ⁽¹⁾
1.1i engine	3.2
1.4i engine	3.2
1.6i 16V 110 ch engine	3.2
1.6i 16V 125 ch engine	3.2
HDi 70 engine	3.8
1.6 HDi 110 ch engine	3.85

⁽¹⁾ Drain, refill and replace oil filter.

12V BATTERY

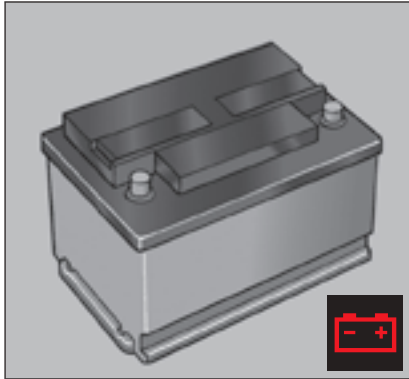

Starting the engine after disconnecting and reconnecting the battery

- Turn the ignition key.
- Wait approximately 1 minute before operating the starter in order to allow the electronic systems to re-initialise. It may be necessary to enter the radio code.

After the battery has been disconnected for a lengthy period of time, it may be necessary to re-initialise the following functions:

- Anti-pinch and sequential operation on the electric windows.
- The multifunction display parameters (date, time, language, units of distance and of temperature).
- The Radio stations.
- The NaviDrive (See NaviDrive instructions).
- Electronic Gearbox System: See Electronic Gearbox System (REINITIALISATION).

12V BATTERY

Starting the engine with an assisting battery

If the battery is discharged, it is possible to use either a separate emergency battery or a battery on another vehicle.

A. Discharged battery (Under the bonnet).

B. Assisting battery.

C. Earth point on broken down vehicle.

Check that the assisting battery has sufficient voltage (12 V).

If you use the battery on another vehicle, stop the engine on the latter. The two vehicles must not come into direct contact with each other.

Connect the cables according to the **order** indicated in the diagram. Check that the leads are well secured (risk of sparks).

Start the engine of the assisting vehicle. Let the engine run for around 1 minute at a slightly accelerated idle.

Operate the starter on the vehicle being assisted.

It is essential to follow the indicated sequence correctly.

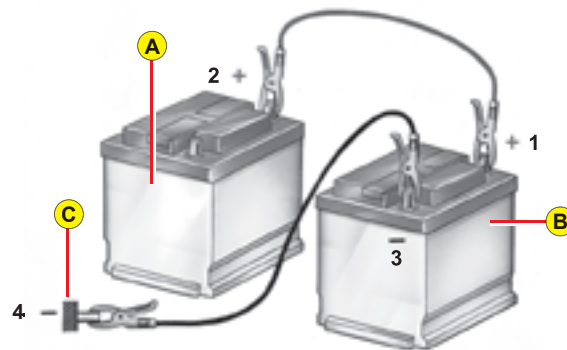

IV

Advice

Do not touch the leads during the operation.

Do not lean over the batteries.

Disconnect the cables in reverse order, making sure they do not touch together.



Never approach with a flame or create sparks in the vicinity of the battery (explosive gas).

The battery contains dilute sulphuric acid which is highly corrosive.

When handling batteries, always protect your face and especially your eyes.

In the event of any contact with the skin, rinse immediately with copious amounts of fresh water.

FUSES

Fuseboxes

There are two fuse boxes, one below the dashboard and one under the bonnet.

Dashboard fuses

The fuse box is located in the lower glovebox compartment.

To access the fuses, open the glove box, pull the handle on the fuse box cover.



Replacing a fuse

Before replacing a fuse, you should ascertain the cause of the fault and have it remedied. The numbers of the fuses are indicated on the fusebox.

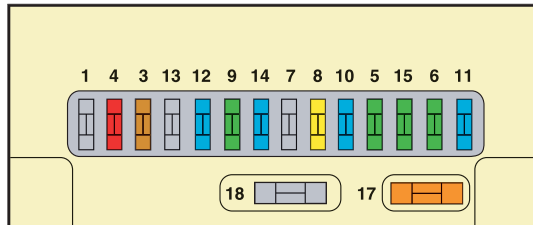

Replace the fuse that has blown with one of the same rating (same colour).

Use the special pliers **A** stowed on the cover close to the fuseboxes, this includes a compartment for replacement fuses.

Good



Bad



IV

Pliers A



TABLE OF FUSES

DASHBOARD FUSES

Ref.	Rating	Function
3	5 A	Airbags
4	10 A	Diagnostic socket – Particle filter additive – Clutch switch – Steering angle sensor
5	30 A	–
6	30 A	Screen wash
8	20 A	Digital clock – Controls at the steering wheel – Radio – Display
9	30 A	Cigar-lighter – Digital clock – Interior lamps – Vanity mirror
10	15 A	Alarm
11	15 A	Ignition switch – Diagnostic socket
12	15 A	Airbag ECU – Rain and brightness sensor
14	15 A	Parking assistance – Instrument panel – Air conditioning – Bluetooth® telephone
15	30 A	Central locking – Deadlocking
17	40 A	Demisting - deicing of the rear screen
18	SHUNT	CUSTOMER PARK SHUNT

IV

FUSES

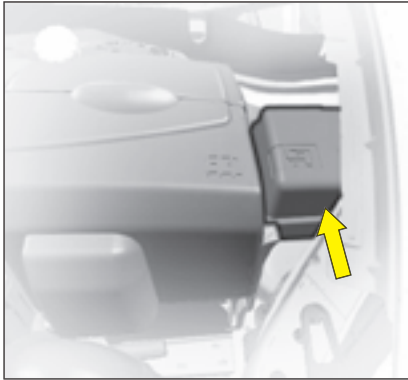

Fuses under the bonnet

Fusebox

To access the fusebox located in the engine compartment, remove the battery cover and detach the lid.

After a repair, take care to reclose the cover.

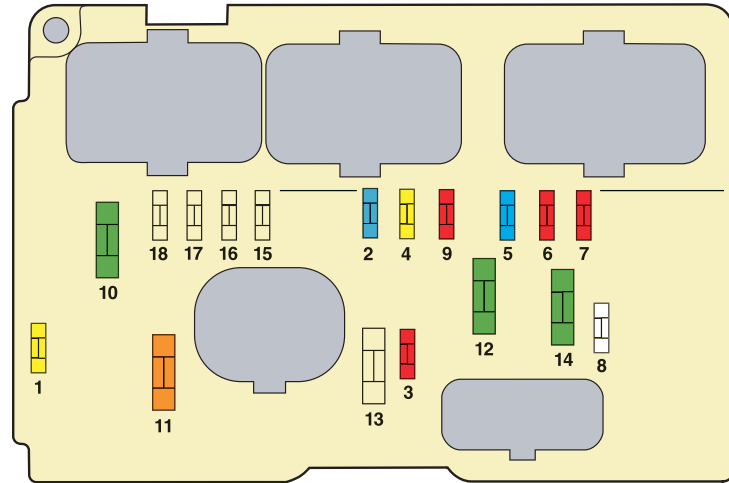

Any action on the MAXI fuses (that give extra protection) (in grey in the diagrams), located in the fuseboxes, should be left to a CITROËN dealer.

IV

TABLE OF FUSES

FUSES UNDER THE BONNET

Ref.	Rating	Function
1	20 A	Water-in-diesel-fuel sensor
2	15 A	Horn
3	10 A	Screen wash
4	20 A	Headlamp wash
5	15 A	Fuel pump
6	10 A	Power steering
7	10 A	Coolant level sensor
8	25 A	Starter
9	10 A	ECUs (ABS, ESP)
10	30 A	Engine control actuators (Ignition coil, Electrovalve, Oxygen sensor, Injection) – Canister purge
11	40 A	Air blower
12	30 A	Windscreen wiper
14	30 A	Air pump (petrol version) – Diesel fuel heater

IV

REFUELLING



To open the flap, pull at the edge.

Locking filler cap

Turn the key a quarter turn to lock and unlock the filler cap.

When refuelling, place the cap in the support provided on the inside of the filler flap.

For a petrol engine with a catalytic converter, unleaded fuel is compulsory.

The filler neck is narrower to ensure that only unleaded petrol can be put in.

When you are seeking to fill your tank, do not persist after the third cut-off ; that could cause your vehicle to malfunction.

Fuel tank capacity (in litres): Approx. 41.

FUEL QUALITY

A label inside the filler flap tells you which type of fuel to use.



UNLEADED PETROL



DIESEL FUEL

The petrol engines are designed to run on RON 95.

However, for better performance (petrol engine), we recommend RON 98.



If you should put in fuel that is not suitable for your vehicle's engine type, it is imperative to have the tank drained before you start the engine again.

CHANGING BULBS

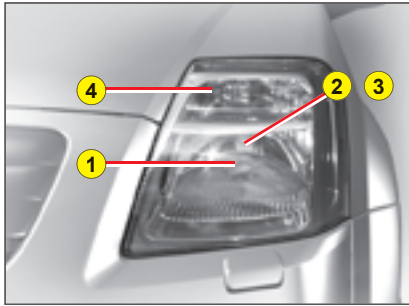

HEADLAMP UNIT

- 1 Sidelamp
- 2 Dipped beam
- 3 Main beam
- 4 Direction indicator

Note: A light misting may appear on the headlamp surface in certain conditions of use.

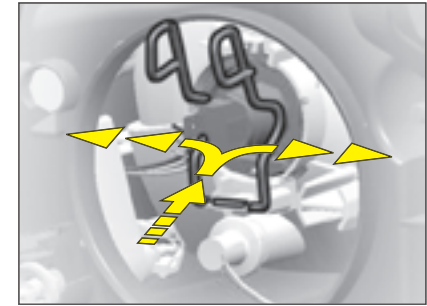
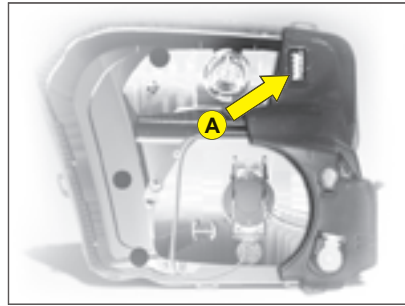

Dipped beam

Main beam

Tilt the metallic spring holding the flap giving access to the lamp bulbs.

Open the access flap.

Disconnect the connector.

Disengage the retaining spring by an forward movement, then an outward movement to disengage the two grips.

Take out the bulb.

Bulb: H4

V



Before touching, disconnect the supply connector A.

CHANGING BULBS

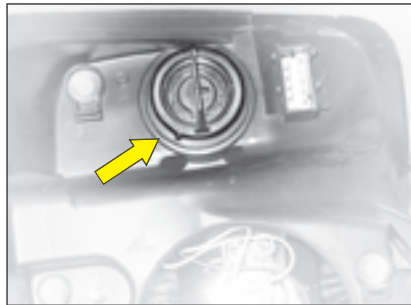

Front direction indicator

Rotate the bulb- holder a quarter turn and pull.

Take out the bulb.

Bulb: PY 21 W (yellow)

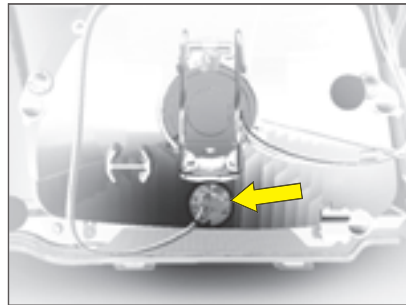

Sidelamp

Open the access flap.

Pull on the bulb- holder to disengage the bulb.

Bulb: W5



Side repeater direction indicator

To change the direction indicator side repeater, push it forwards or rearwards to detach it, then pull it towards you.

Hold the cable and disconnect it.

Contact a CITROËN dealer.

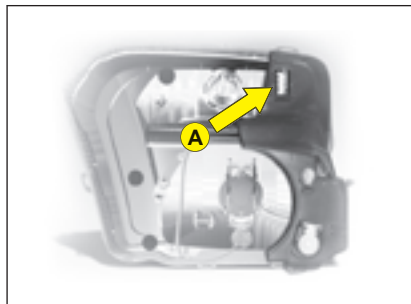

Before touching, disconnect the supply connector A.

CHANGING BULBS



Front foglamps

Contact a CITROËN dealer.

Bulb: H1



Interior lamp

Unclip the transparent cover of the interior lamp to reach the bulb.

Bulb: W 5 W

Spotlamps

Unclip the transparent cover of the interior lamp to reach the bulb.

Bulb: W 5 W

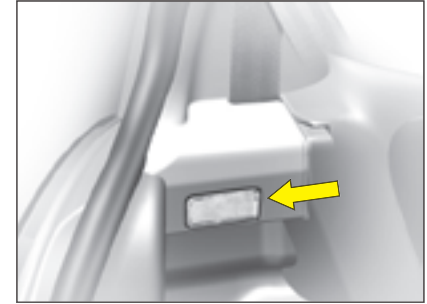

Boot lamp

Unclip the lens unit to access the bulb.

Bulb: W 5 W

CHANGING BULBS



Front foglamps

Contact a CITROËN dealer.

Bulb: H1



Interior lamp

Unclip the transparent cover of the interior lamp to reach the bulb.

Bulb: W 5 W

Spotlamps

Unclip the transparent cover of the interior lamp to reach the bulb.

Bulb: W 5 W

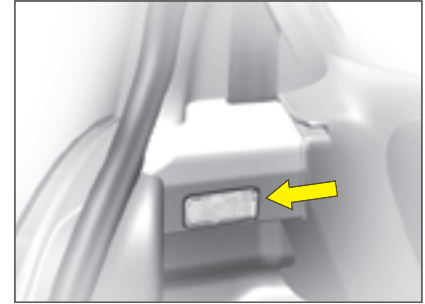

Boot lamp

Unclip the lens unit to access the bulb.

Bulb: W 5 W

CHANGING BULBS



Rear lamp unit

Identify the failed bulb.

Bulbs:

- 1 Stop-lamps and sidelamps:
P 21 W / 5 W
- 2 Direction indicator: PY 21 W
- 3 Reversing lamp: P 21 W
- 4 Foglamp: P 21 W

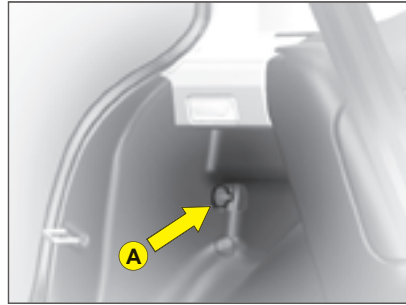

Removal

From the inside, undo the nut **A**.
Disengage the lamp unit.
Disconnect the supply connector.
Unclip the bulb- holder.

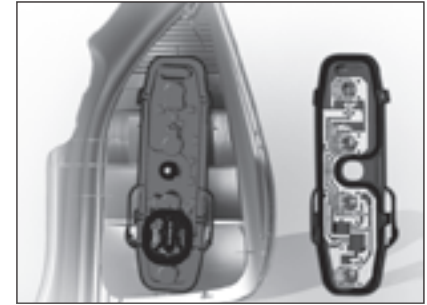

CHANGING BULBS

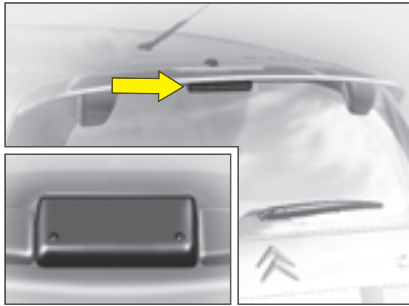

Third stoplamp

To access the bulb, open the upper tailgate, remove the parcel shelf and undo the lamp unit.

Disconnect the supply connector. Remove the lens and disengage the bulb.

Bulb: W 16 W

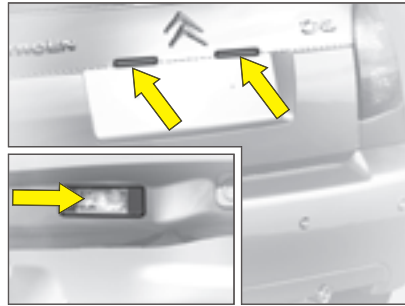

Number plate

Unclip the lens then pull the bulb-holder.

Bulb: W 5 W

After each operation, check that the lamps work.

Towbar

We recommend you to have this device fitted by a CITROËN Dealer, who will be acquainted with your vehicle's towing capability and with the procedures necessary for installing a safety item of this kind.

Dimensions (in metres)

A: 0.71



Roof bars

For your safety and to avoid damage to the roof, you should use roof bars that are tested and approved by AUTOMOBILES CITROËN for the design of your particular vehicle.

Recommendations:

- Spread the load evenly, avoiding overloading on one side.
- Position the heaviest weight as low down as possible.
- Tie the load down securely and add warning signs if it is protruding.
- Drive conservatively, as the vehicle will be more vulnerable to side winds. The stability of your vehicle may be altered.
- Remove the roof rack or roof bars when you are not using them.
- When you are using a towbar, remove the jack from its stowage in the spare wheel. Keep the jack to hand in the passenger compartment.



**Do not exceed the maximum permitted load.
For the maximum distributed load on the roof bars: see the chapter "General".**

CHANGING A WHEEL

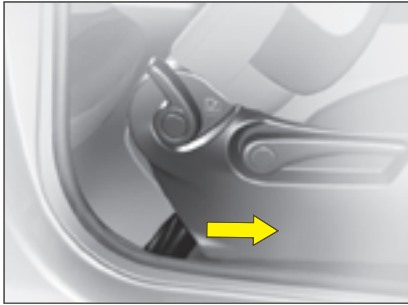

Access to the tools

To access the toolkit:

- Tilt the RH seat as if to enter the rear of the vehicle.
- Locate the kit under the seat and pull it towards the rear of the vehicle.

The jack is stowed in a protection box inside the spare wheel underneath the boot.

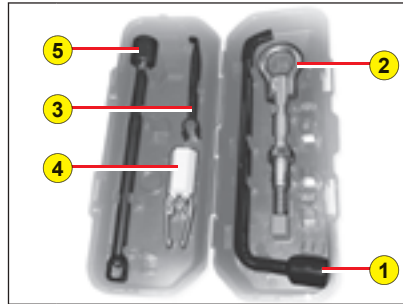

Tools

1. Wheelbrace.
2. Movable towing eye.
3. Central embellisher removing tool for accessing the wheel bolts (For vehicles with aluminium wheel rims).
4. Tool for removing wheel bolt protectors (For vehicles with aluminium wheel rims).
5. Extension.

The alloy wheel anti-theft sockets are to be found in the glovebox.

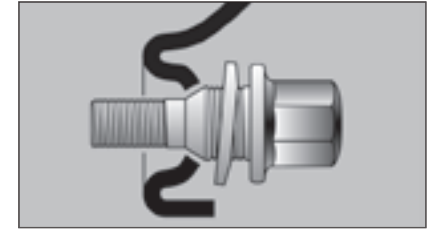

Light alloy wheels

If your vehicle has light alloy wheel rims but a steel spare wheel, if you fit the latter it is normal to notice that the wheel bolts do not appear to contact on the rim.

The spare wheel is secured by the conical tapering of the wheel bolt's shaft (See illustration).

when refitting the light alloy wheel, make sure that the tapering contact faces of the wheel bolts are clean and in good condition.



Never get underneath the vehicle if it is supported only by the jack.

When changing a wheel, it is essential to park the vehicle safely on level and stable ground.

CHANGING A WHEEL



Access to the spare wheel

Open the lower tailgate.

Remove the blank **A** with the aid of the ignition key, to insert the extension for the wheelbrace.

Slacken the spare wheel carrier screw.

Lift the carrier to release the retaining hook, then disengage it.



To reposition the spare wheel

Having repositioned the jack and its handle in its protection box in the wheel, slide the wheel into the carrier.

Lift the carrier to secure it in the safety hook.

Retighten the screw from inside the boot compartment.

Stow the wheelbrace and extension.

Reposition the blank **A**.

Tyre pressures

This is indicated on the label on the front door pillar. See "Vehicle identification" and "User Precautions".



ADVICE

The wheel bolts are specific to the type of wheel.

If the type of wheel is changed, check with your CITROËN dealer that the wheel bolts are compatible with the new wheels.



The jack is specific to your vehicle, do not use it for any other purposes.

With a spare wheel, drive cautiously.

CHANGING A WHEEL

Removal

1. Park the vehicle on stable, firm ground that is not slippery. Apply the parking brake.
Switch off the ignition and engage first gear or reverse gear, depending on any slope.
2. Position the jack at one of the four jacking-points provided on the sub-frame close to the wheels. Using the handle, unwind the jack until it reaches the ground.
3. To unclip the wheel embellisher, pull using the end of the wheelbrace as a lever in one of the apertures.
For vehicles with aluminium wheel rims:
 - With a central embellisher, remove the embellisher, using the tool, to access the bolts.
 - With visible wheel bolts, remove the chromed bolt protectors, using the tool, before slackening the bolts.
4. Continue to extend the jack until the wheel is a few centimetres off the ground.
5. Undo the other bolts, remove the wheel.



Refitting

1. Fit the wheel on the hub, using the centring guide.
2. Screw in the bolts but do not fully tighten them, remove the wheel centring guide in order to screw in the last bolt.
3. Lower the jack and remove it.
4. Tighten the wheel bolts, using the wheelbrace.
5. Refit the embellisher, taking care to accommodate the tyre valve. Then pressing all round its circumference.
6. Have the original wheel repaired and refitted as soon as possible.
7. Make sure that the tyre is at the correct pressure (see “Vehicle Identification” and “User Precautions”) and have the wheel balancing checked.

Dimension of the spare wheel

If your spare wheel has dimensions different from those of the normal vehicle wheels (identified by a label), it is imperative to use the spare wheel only temporarily, to drive with caution, not to exceed 80 km/h (50 mph) and to have the tyre repaired and the normal wheel refitted as soon as possible.

PUNCTURE

If your vehicle has no spare wheel, a repair aerosol is to be found in the boot.

Using the repair aerosol

See also the user instructions on the aerosol.

- Remove, if possible, the object which has caused the puncture.
- Orient the wheel so that the valve is at ten o'clock or two o'clock.
- Shake the aerosol vigorously (in cold weather warm it in your hands for a few minutes).
- With one hand hold the valve connector clear of the rim hole, with the other hand press the end of the aerosol nozzle firmly onto the connector, keeping it in the line of the valve.
- Firmly maintain the pressure for one minute.
- Rapidly remove the aerosol and immediately drive for around six miles.
- Reinflate the tyre and check its condition after some ten hours.

After using the repair aerosol, you should have the condition of the tyre, as well as its inflation pressure, inspected.

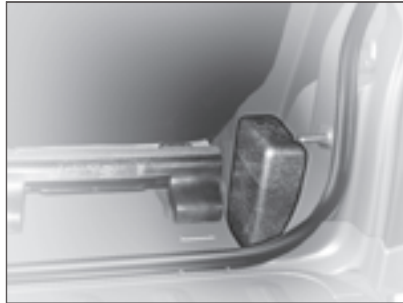

Advice - Recommendations

A punctured tyre should always be removed from the rim and thoroughly examined for damage before attempting any repair. When a repair is possible, it should be carried out as soon as possible to prevent further damage to the tyre.

Tyre repair should be carried out by a tyre specialist who will assume responsibility for the repair.

Note:

- *The towing eye is stowed either in the repair aerosol box or in the tool kit.*
- *If there are two repair aerosols, this means that you need to use both of them for the temporary repair of the tyre.*



Because the aerosol is pressurised, do not expose it to temperatures higher than 50°C.

After provisionally repairing a tyre using the repair aerosol, you are advised not to drive at over 80km/h.

TOWING – LIFTING

Movable towing eye

The towing ring is detachable and can be fitted either at the front or at the rear of the vehicle. It is stowed in the toolkit which is to be found either under one of the front seats or in the repair aerosol kit located in the boot.

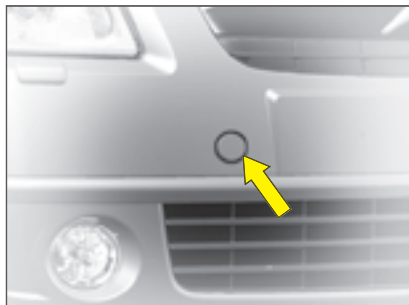

Towing with wheels on the ground

Towing eye fixings are located at the front and at the rear of the vehicle.

To access them:

- Carefully lift the access cover.
- Release it by pressing on the lower part.

A lug keeps the cover attached to the bumper, so that it does not become lost.

The ignition key must be in position M to retain steering.

Use a bar with attachments to the towing eyes as above.



ADVICE

Towing at low speed over a very short distance is authorised in exceptional cases depending on the regulations in force.

Otherwise, it is necessary to have your vehicle transported on a recovery truck.

V

TOWING REQUIREMENTS

Place the selector on position N (neutral).



When the engine is not running, the steering and the braking are no longer assisted.

If you are towing another vehicle, the latter must be free-wheeling (gearbox in neutral).

FUEL CONSUMPTION

(IN LITRES/100 KM (MILES PER GALLON))

Engine type	1.1i 61 hp	1.4i 75 hp	1.4i 75 hp	1.4i 16V 90 hp	1.6i 16V 110 hp	1.6i 16V 125 hp	HDi 70	HDi 70	1.6 HDi 110 hp FAP
Saloon Entreprise	BVM	BVM	BVMP	BVMP Stop & Start	BVMP	BVM	BVM	BVMP	BVM
Urban CO ₂ emissions (g/km)	7.5 (37.7) 178	7.9 (35.8) 190	7.5 (37.7) 181	6.8 (41.5) 162	8.3 (34.0) 199	9.3 (30.4) 223	5.3 (53.3) 141	4.9 (57.6) 130	5.7 (49.6) 151
Extra urban CO ₂ emissions (g/km)	4.8 (58.9) 114	4.9 (57.6) 117	4.8 (58.9) 116	4.8 (58.9) 116	5.2 (54.3) 124	5.4 (52.3) 129	3.7 (76.3) 96	3.8 (74.3) 99	3.7 (76.3) 98
Combined CO ₂ emissions (g/km)	5.8 (48.7) 138	6.0 (47.1) 143	5.8 (48.7) 138	5.6 (50.4) 133	6.3 (44.8) 151	6.9 (40.9) 163	4.3 (65.7) 113	4.2 (67.3) 111	4.4 (64.2) 119

These consumption figures are established according to Directive 80/1268/CEE. Fuel consumption can vary depending on style of driving, traffic conditions, weather conditions, vehicle load, how the vehicle has been maintained and on use of accessories.

BVM: Manual gearbox.

BVMP: Electronic Gearbox System.

FAP: Diesel particulate filter system.



The fuel consumption figures quoted are correct at time of going to press.

GENERAL

	Saloon					
Engine type	1.1i BVM	1.4i BVM	1.4i BVMP	1.4i 16V 90 hp BVMP	1.6i 16V 110 hp BVMP	1.6i 16V 125 hp BVM
Fuel tank capacity	Approximately 41 litres					
Fuels to be used	Unleaded petrol RON 95 - RON 98					
Turning circle between walls (in metres)	9.6	9.6→10.7	9.6→10.7	10.7	10.7	10.7
French fiscal rating	4	5	5	5	6	7
Calculated maximum speed in km/h (mph) (In the highest gear)	158 (98)	169 (105)	169 (105)	181 (112)	195 (121)	202 (125)
Weights (kg)						
Unladen weight (MAV)	956	990	995	1 013	1 071	1 084
Gross vehicle weight (MTAC)	1 336	1 362	1 391	1 410	1 425	1 415
Maximum weight on rear axle (CMAE AR)	710					
Gross train weight (MTRA)	1 786	1 812	1 841	1 860	1 875	1 865
Gross trailer weight (with brakes) (Within the Gross Train Weight limit)	520	530	530	540	560	620
Gross trailer weight (without brakes)	450					
Trailer nose weight	25					
Maximum roof rack load	60					
Dimensions of chainable tyres	175/65 R14 - 185/55 R15 - 195/45 R16					

GENERAL

Saloon			Entreprise	
HDi 70 BVM	HDi 70 BVMP	1.6 HDi 110 hp BVM FAP	HDi 70 BVM	1.1i BVM
Approximately 41 litres				
Diesel fuel				Unleaded petrol RON 95 - RON 98
9.6→10.7	9.6→10.7	10.7	9.6→10.7	9.6
4	4	6	4	4
166 (103)	167 (104)	193 (120)	166 (103)	158 (98)
710				
1 003	1 041	1130	978	939
1 391	1 421	1475	1 374	1 340
710				
1 841	1 871	1925	1 824	1 790
540	540	625	540	520
450				
25				
60				
175/65 R14 - 185/55 R15 - 195/45 R16				

MAV: Unladen weight.

MTAC: Gross vehicle weight.

CMAE AR: Maximum weight on rear axle.

MTRA: Gross train weight.

Weights: Refer to the manufacturer's plate.

BVM: Manual gearbox.

BVMP: Electronic Gearbox System.

FAP: Diesel particulate filter systeme.

Observe your vehicle's towing limits.

It is essential to comply with the max. Gross Trailer Weights and speed limits as specified by legislation in each country.

For further information about the towing capacity of your vehicle and its max. authorised Gross Train Weight, contact a CITROËN dealer.

DIMENSIONS (IN METRES)

A	2.315
B	3.666
C	0.760
D	0.591
E	1.439
F	1.439
G	1.659
H	1.461
I	1.898

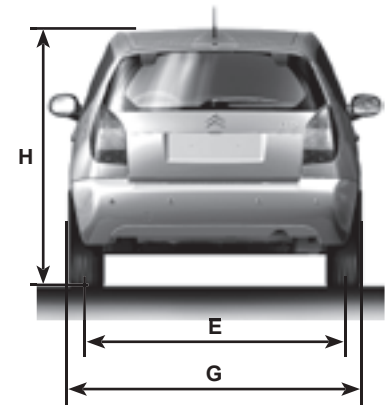
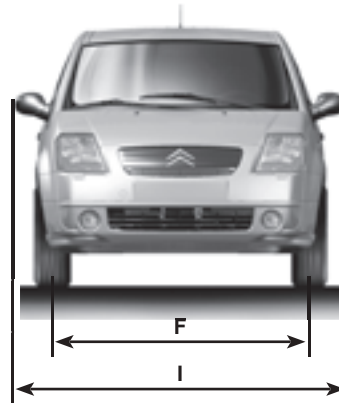
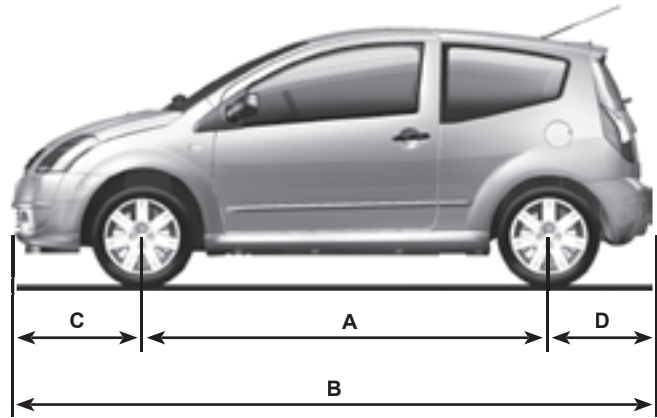

DIMENSIONS (IN METRES)

A	0.892
B	0.606
C	0.334 MIN. 0.434 MAX.
D	1.033
E	0.990
F	0.993
G	0.530
H	0.678

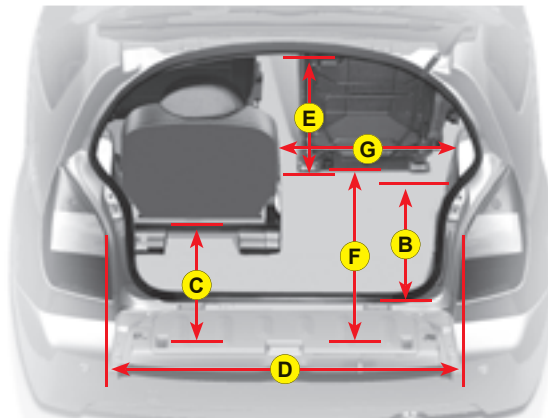
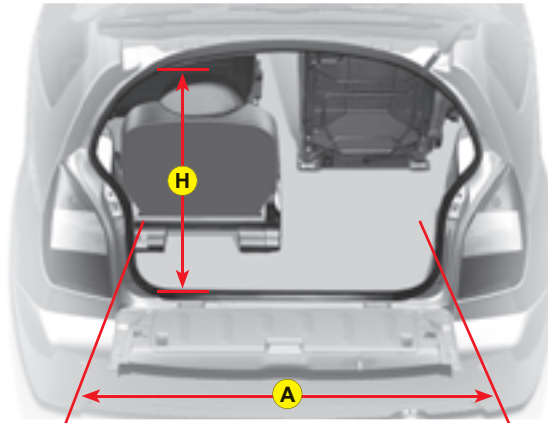

VEHICLE IDENTIFICATION

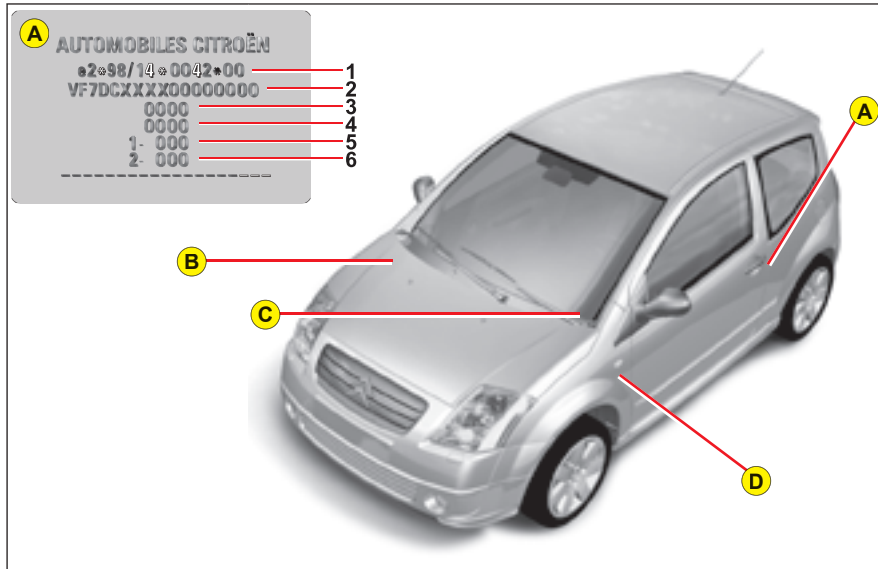

Self-adhesive manufacturer's plate

- A.** On the LH door aperture, above the striker plate.
1. EU type approval number.
 2. Vehicle identification No. (VIN).
 3. Gross vehicle weight.
 4. Gross train weight.
 5. Maximum weight on front axle.
 6. Maximum weight on rear axle.
- B.** Body serial number
- C.** Factory serial no. under the windscreen
- D.** Paint colour code
Tyre reference
Tyre pressures

All CITROËN original replacement parts are available exclusively within the dealer network. For your safety and in order to remain within the terms of the guarantee, you are advised to use only CITROËN replacement parts.

Fitting parts or units not supplied by CITROËN may even result in violation of the law, if it involves non-compliance with regulations concerning safety, pollution control, interference suppression and the noise level of the vehicle.





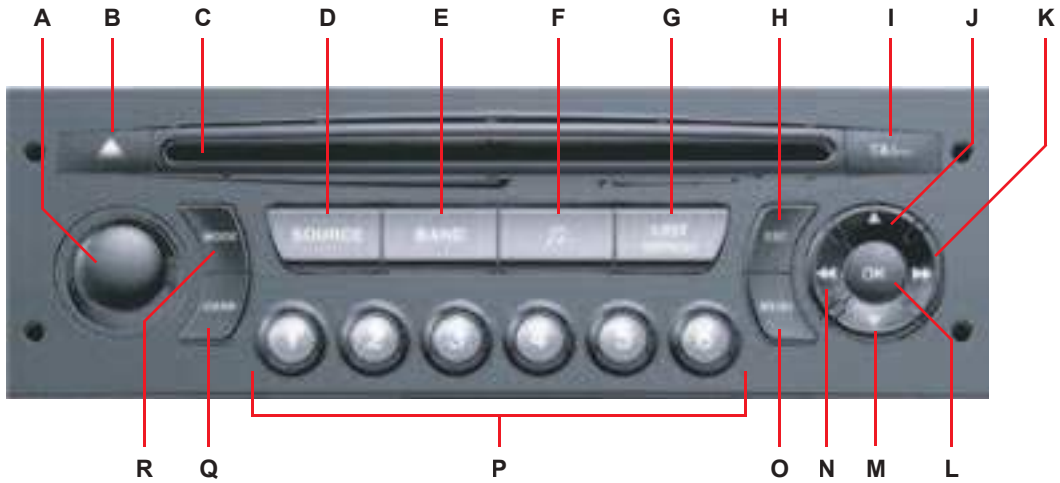

VI Fitting such parts or units could also deprive the user of any recourse against the maker.

This applies in particular to: parts of the braking equipment, lighting and signalling equipment, engine equipment, the exhaust system, steering system, structural and suspension parts.

RDS AUDIO COMPACT DISC SYSTEM WITH CD CHANGER



BUTTON CONTROLS

A		On / Off. Volume adjust.	L	OK	Button for validation and activation/deactivation of certain functions. If your vehicle has the Bluetooth system : Answer call, end call.
B		CD eject.	M		Radio source : Manual search of lower frequencies. CD changer source : Selection of next CD. Other sources : Scrolling in the Main Menu.
C		CD aperture.	N		Radio source : Automatic search of lower frequencies. CD and CD changer source : Long press : Rapid reverse with accelerated sound. Other sources : In the menus, choice of your adjustments. If your vehicle has the Bluetooth system : Selection of characters.
D	SOURCE	Selection of sound source (Radio, CD, CD changer).	O	MENU	Display of the Main Menu. In certain countries, this control is deactivated while the vehicle is moving.
E	BAND/ AST	Short press : Selection of frequency bands and memory banks. Long press : Automatic pre-set function (Autostore).	P	1-6 1-5	Radio source : Short press : Recall of pre-set stations. Long press : Memorisation. CD changer source : Selecting a CD.
F		Call-up of audio adjustments : Sound ambiances, bass, treble, loudness, fade, balance, speed-sensitive volume.	Q	DARK	Short successive presses : • One press : Display of radio, time and temperature only. • Two presses : Display off (blank display). • Three presses : Return to the standard display.
G	LIST	Radio source : • Short press : Display of the list of radio stations available (30 maximum). • Long press : Update of list of stations. CD source : Display of list of tracks of the CD.	R	MODE	Selection of the type of information displayed.
H	ESC	Short press : Cancel the current operation or delete a superimposed display. Long press : Return to the permanent display.	S		CD changer.
I	TA/PTY	Short press : TA function (road information). Long press : PTY function (élection of programme type).			
J		Radio source : Manual search of higher frequencies. CD changer source : Selection of previous CD. Other sources : Scrolling in the Main Menu.			
K		Radio source : Automatic search of higher frequencies. CD and CD changer source : Short press : Forward search for tracks. Long press : Fast forward with accelerated sound. Other sources : In the menus, choice of your adjustments. If your vehicle has the Bluetooth system : Selection of characters.			

RDS AUDIO COMPACT DISC SYSTEM WITH CD CHANGER

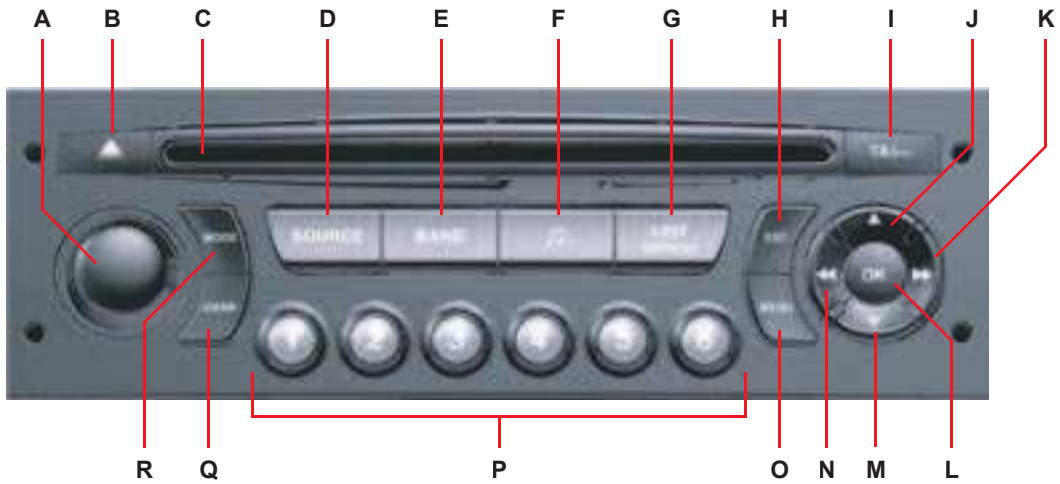

The controls at the steering wheel give you access to certain functions, without you needing to use the radio-CD control panel.

1	MEMO ▲ ▼	<p>Radio source :</p> <ul style="list-style-type: none"> • Scrolling of pre-set stations. <p>Within a menu, selection of a choice.</p> <p>CD changer source :</p> <ul style="list-style-type: none"> • Selection of CD.
2	▶▶	<p>Radio source :</p> <ul style="list-style-type: none"> • Search of higher frequencies. <p>CD and CD changer source :</p> <ul style="list-style-type: none"> • Forward search for tracks. • Fast forward with accelerated sound. <p>If your vehicle has the Bluetooth system : Selection of characters.</p>
3	◀◀	<p>Radio source :</p> <ul style="list-style-type: none"> • Search of lower frequencies. <p>CD and CD changer source :</p> <ul style="list-style-type: none"> • Reverse search for tracks. • Rapid reverse with accelerated sound. <p>If your vehicle has the Bluetooth system : Selection of characters.</p>
4		Volume increase.
5	SRC	<p>To change from one source to another : Radio, CD, CD changer.</p> <p>Within a menu, validation of your choice.</p>
6		Volume decrease.
4+6		Simultaneous press on both buttons : Mute (temporary sound pause).

7		<p>If your vehicle has the Bluetooth system :</p> <p>Short press on the end : Activation/deactivation of the Voice Commands function if your vehicle has the Bluetooth system.</p>
---	--	--

DISPLAY A

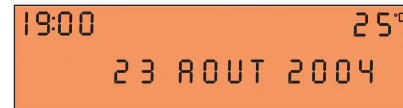

DISPLAY C



TECHNICAL SPECIFICATIONS

Your Bluetooth compatible radio possesses :

- 3 wavebands (MW/LW/FM).
- Dual tuner with RDS EON PTY, display of the PS name, RDS programme search, TA traffic information, 24 pre-selections (18 FM - 6 MW/LW), automatic memorisation of the AST strongest stations.
- A CD player.
- Audio power of 4x35 W.

GENERAL FUNCTIONS - AUDIO ADJUSTMENTS

ON / OFF

With the key in Drive position **M**, press on control **A** to switch the radio on or off.

Note :

- If the radio was on the last time you switched off the ignition, it will resume automatically when you switch on the ignition again. You will not have to press on control **A**.
- After switching off the ignition, you can still operate the audio system even without the ignition key being present. Simply press on button **A**. The system will turn itself off **after approx. 30 minutes**.

ANTI-THEFT SYSTEM

This radio is coded in such a way as to function only on your particular vehicle. It would be unusable if installed on any other vehicle.

Note :

The anti-theft system is automatic and requires no action on your part.

SELECTION OF SOURCE

To select either Radio, CD (CD already inserted and Radio source activated), or CD changer source, press on control **D**.

When you insert a CD it automatically starts being read.

Note :

When the radio is switched off, the source selected is memorised.

VOLUME ADJUSTMENT

Rotate control **A** to increase or decrease the sound volume.

You can also increase or decrease the volume using buttons **4** and **6** at the steering wheel.

Note :

- The sound volume when you switch off the radio will be the same when you switch it on again.
- The radio sound volume automatically adjusts to the vehicle speed, provided the "**volume adjustment**" function is activated.

TEMPORARY SOUND PAUSE

Press simultaneously on buttons **4** and **6** at the steering wheel to activate this function.

The sound will be paused, regardless of the source selected.

To restore the audio output, press one of the controls at the steering wheel.

SOUND ADJUSTMENTS

Each press on button **F** brings up the parameter to be adjusted : choice of predefined sound ambiances, bass, treble, loudness, fade (front/rear sound distribution), balance (left/right sound distribution) and volume adjusted to vehicle speed.

Press buttons **K** or **N** to modify the values for the function displayed.

Note :

- The selection of a sound ambiance automatically adjusts bass and treble. These can be modified.
To restore the original adjustments for the musical ambiances, reset bass and treble to zero.
- Adjustment of loudness, as well as bass and treble when they are available, are specific to each sound source and to each musical ambiance.
- If you leave the audio system un-actioned for a few seconds, it will revert to the normal display.

NOTES ON RADIO RECEPTION

Your radio will be subject to certain phenomena that are not encountered by domestic systems.

The reception of AM and FM signals may suffer from interference, which is caused by the nature and propagation of the signals and does not reflect on the quality of your radio installation.

In AM, the reception may be affected when passing under power lines or bridges, or when travelling through tunnels.

In FM mode, the reception may be affected by the distance from the station transmitter, the reflecting of signals off obstacles (mountains, hills, tower blocks) and radio blackspots (no coverage from the station transmitter).

SELECTION OF RADIO SOURCE

Press button **D** to select the source.

You can also do this by means of control **5** at the steering wheel.

SELECTION OF FREQUENCIES AND MEMORY BANKS

Press button **E** successively to go through the memory banks FM1, FM2 and FM3, for the FM waveband, and the memory banks MW/LW, for the AM waveband.

MANUAL SEARCH

Manual search is via buttons **J** or **M**.

By keeping button **J** or **M** pressed, you will be able to scroll through the waveband. Scrolling will stop as soon as you release the button. The radio will remain tuned to the frequency that is displayed.

TUNING SENSITIVITY

Automatic searches can be carried out according to two levels of sensitivity :

- To capture the most powerful transmitters, choose the local search mode "**LO**" (default option).
- To capture the weakest or most distant transmitters, choose the sensitive search mode "**DX**".

Search for a station is done first in "**LO**" (local) sensitivity, then in "**DX**" (distant) sensitivity.

To commence a search in sensitivity "**DX**" (distant) immediately, press twice in succession on one of the buttons **K** or **N**.

AUTOMATIC SEARCH

A short press on one of the buttons **K** or **N** will tune into higher or lower radio stations respectively, within the chosen waveband.

By keeping button **K** or **N** pressed, you will be able to scroll through the waveband. The scrolling will stop at the first station it finds once the button is released.

You can also do this by means of the controls **2** and **3** at the steering wheel.

If the automatic search is unable to tune into a known frequency (perhaps owing to very weak reception), it is possible to search manually to find this station.

DISPLAY AND SELECTION OF A STATION AVAILABLE IN THE AREA IN WHICH YOU ARE TRAVELLING

Briefly press on button **G** to bring up a list of stations, this is updated every 10 minutes.

You can also update this list at any time by giving a long press on button **G**.

To listen to one of these stations, select by pressing buttons **J** or **M** and validate using button **L**.

MANUAL PRE-SETTING

Select the waveband and memory bank required using button **E**.

Select a station using either automatic or manual search.

Keep pressing for more than two seconds on one of the pre-selection buttons **1** to **6** on the keypad **P**.

The sound momentarily cuts off, then returns to its previous level to confirm that it has memorised the station.

AUTOMATIC MEMORISATION OF TRANSMITTERS (AUTOSTORE FUNCTION)

In FM, if you hold down button **E** for more than two seconds, your radio will automatically memorise the 6 strongest stations on the FM3 memory bank.

The display shows "**FM AST**".

The radio memorises the 6 strongest transmitters, deleting the 6 previously memorised.

After the memorisation, the radio goes directly to memory 1 of memory bank FM3.

Note :

- If the traffic information function has been activated (see RDS SYSTEM), the stations offering this facility will be memorised as priority.

If it is unable to memorise any new stations, the system will retain the previously memorised stations.

- If the system is unable to find 6 stations, the unfilled memory slots will remain free.

RECALL OF PRE-SET STATIONS

Press button **E** briefly to select the required waveband and memory bank.

A short press on one the pre-selection buttons **1** to **6** on the keypad **P** recalls the corresponding memorised station. You can also do this using the control **1** at the steering wheel.

If it is a RDS station, the frequency appears some seconds before the name appears.

For RDS stations, recall of a station may prompt a search for a frequency corresponding to the region where you happen to be (see RDS system).

USING THE RDS (RADIO DATA SYSTEM) FUNCTION ON FM

The majority of FM radio stations use the RDS system. The radio in your vehicle has this system.

The RDS system enables these stations to transmit non-audible data in addition to the broadcasting of their programmes. The data provides access to various functions described in this chapter, such as: display of the station name, intermittent traffic information flashes or automatic scanning of stations. This enables you to continue listening to your chosen radio station, regardless of the different frequencies it uses in the regions through which you are travelling.

SCANNING OF RDS STATIONS

Your radio keeps the best possible reception by continuously looking for any other frequencies on which the selected radio station is broadcast, automatically choosing the frequency offering the best reception (if the station broadcasts on more than one transmitter or frequency).

ACTIVATION/DEACTIVATION OF THE RDS FUNCTIONS

The RDS functions can be accessed via the following two menus :

- **Main menu** (press button **O**).
- **AUDIO menu** (press button **L**).

To activate/deactivate the RDS functions on the display **C** :

1. Press button **O**.
2. Select the AUDIO icon using buttons **J** or **M**.
3. Confirm your choice with a press on button **L**.
4. Select the sub-menu for the FM waveband, via buttons **J** or **M**. Confirm your choice with a press on button **L**.
5. Select scanning for RDS stations, via buttons **J** or **M**.
6. Validate your choice with a press on button **L**.
7. Using control **L**, select/deselect to activate/deactivate the function.
8. Validate your choice by selecting "**OK**" on the display.

To activate/deactivate the RDS functions on the display **A** :

1. Press button **O**.
2. Select the AUDIO-CD icon via buttons **J** or **M**.
3. Select scanning for RDS stations, via buttons **J** or **M**. The system tells you the status (active or inactive) of the function.
4. Modify this status via buttons **K** or **N**.
5. Then please wait for the display to disappear.

Note :

If the RDS function is active :

- The "**RDS**" on the display will light up provided the station being received uses the RDS system with scanning of frequencies.
- The "**RDS**" on the display is barred if the station received uses the RDS system without frequency search.

If your RDS function is deactivated, the "**RDS**" on the display will be absent in all cases.

The display will indicate the "**NAME**" for the stations that use the RDS system and the frequency for stations that do not use it.

REGIONAL SEARCH MODE

Some stations, when they are organised in networks, broadcast regional programmes at certain times of day, and national programmes at other times.

It is possible to search :

- Either for a regional station only.
- Or across the whole network in order to find a different programme.

To activate/deactivate this function, proceed as for Scanning of RDS stations.

Note :

When this mode is activated, the system will remain tuned to one specific regional station.

TA TRAFFIC INFORMATION (TRAFFIC ANNOUNCEMENTS)

Some stations allow broadcasting, only in FM, of these messages thanks to the "TA" function.

You can activate the "TA" function by pressing on button **I**. This allows you, even though you are listening to another audio source or to a radio programme not itself providing traffic messages, to receive traffic information flashes from an FM station which broadcasts them.

While the messages are being broadcast the original source is paused and when the messages have ended your radio will automatically revert to the music programme you were listening to.

Note :

- You have to be in FM wave band.
- The station being listened to should indicate via the RDS system that it broadcasts traffic information.
- Stations organised in a network (EON) have regional transmitters that send their own programmes: while you are listening to one of these stations the system will switch automatically to a station on the network that is broadcasting traffic information.
- You can stop listening to a message by pressing button **I**.

SOUND VOLUME ADJUSTMENT FOR TRAFFIC INFORMATION

The sound volume for traffic information operates separately from that for the rest of the system, and can be adjusted independently.

Rotate button **A** while a traffic information message is being broadcast.

This volume adjustment is memorised.

SELECTING A PROGRAMME TYPE

Certain stations offer the possibility of listening to a particular programme type, selected from a list (PTY).

press for more than two seconds on button **I**.

Press on buttons **J** or **M** to scroll through and select the programme type you prefer, then press on button **L** to validate your choice.

SEARCHING FOR A STATION BROADCASTING THIS PROGRAMME TYPE

When you have chosen a programme type, the list of corresponding stations appears on the display, press on buttons **J** or **M** to scroll down and select the station you want, then press on button **L** to validate your choice.

QUITTING PTY MODE

To quit "PTY" mode, select the function to deactivate "PTY" in the list of the different programme types.

RADIO TEXT VIA CONTEXTUAL MENU

This function allows to view the information broadcast by the station, concerning the programme you are currently listening to.

To activate/deactivate this function, proceed as for Scanning of RDS stations.

SELECTING CD SOURCE

After inserting a CD, with the printed side facing upwards, the player will start playing the CD automatically.

To change manually to CD source (CD already inserted), press button **D** until you obtain the source you require.

You can also do this by means of control **5** at the steering wheel.

EJECTING A CD

Press button **B** to eject the CD, the audio system will automatically switch to radio source.

If the CD is not removed within 10 to 15 seconds of being ejected, it will automatically be taken back into the CD player, although it will not be played.

SELECTING A TRACK

Press button **K** once to play the next track. Press button **N** once to return to the beginning of the track currently being played, press a second time to go back to the start of the previous track.

Press the buttons successively to skip several tracks at a time.

This can also be done via the control **G**. As the list of tracks is displayed on the screen, select the desired track using buttons **J** or **M**, then validate using button **L**.

You can also do this via the controls **2** and **3** at the steering wheel.

FAST FORWARD AND RAPID REVERSE WITH ACCELERATED SOUND

To move swiftly through the CD, press and keep pressed button **K** or **N**, respectively for fast forward or rapid reverse with accelerated sound.

Play resumes as normal when the button is released.

MENU

This menu allows activation/deactivation of two options :

- Playback of the first 7 seconds (approx.) of each track of the CD.
- Random playback of the CD tracks.

This can be accessed in two ways :

- Either by pressing button **O** and proceeding as for Search of Stations RDS – for screen C, the sub-menu corresponds to the Audio Preferences.
- Or, provided you are in CD source, by pressing on button **L**. You can then access the Audio menu (for screen C only).

Note :

If one of these options is active, it remains active for CD changer source.

SAFETY PRECAUTIONS

For safety, do not use a CD player if the cabin temperature is higher than +60 °C or lower than -10° C.

If the temperature becomes too high, an automatic safety device will prevent the CD player from working until an acceptable temperature is restored.

HANDLING COMPACT DISCS

Do not drop them. Store the CDs so that they are kept of dust. Avoid touching the disc surface as any scratches may adversely affect the sound quality. Do not attach any stickers to the discs. Do not use damaged or deformed discs. Do not expose them to heat or direct sunlight.

If the surface of the compact disc is dirty, it can be wiped with a soft, clean cloth. Always wipe from the centre of the disc outwards.

CD CHANGER

This equipment **S** (if present) is located in the central console and can accommodate 5 discs.

INSERTING CDs INTO THE MAGAZINE

Insert the CDs with the printed side upwards.

Note :

- Each compartment takes one disc only.
- The CD changer will not operate if discs are inserted the wrong way up.

REMOVING DISCS

To remove a CD, give a long press on the corresponding button.

SELECTING CD CHANGER SOURCE

Press on button **D** until you reach CD changer.

After the magazine engages, playback of the first track of the first CD will begin.

You can also do this by means of control **5** at the steering wheel.

SELECTING A CD

To select a CD, either press one of the pre-selection buttons **1** to **5** on the keypad **P**, or scroll using buttons **J** or **M**.

The CD will start to play automatically.

You can also do this by means of control **1** at the steering wheel.

After each change of source, on return to CD changer source, playback will resume at the same point where it had been interrupted.

SELECTING A TRACK

Press button **K** once to play the next track.

Press button **N** once to return to the beginning of the track currently being played, press a second time to go back to the start of the previous track.

Press the buttons successively to skip several tracks at a time.

You can also do this by means of the controls **2** and **3** at the steering wheel.

FAST FORWARD AND RAPID REVERSE WITH ACCELERATED SOUND

Press and keep pressed one of the buttons **K** or **N** respectively for fast forward or rapid reverse with accelerated sound. Play resumes as normal when the button is released.

MENU

This menu is for activation/deactivation of three options :

- Playback of the first 7 seconds (approx.) of each track of the CD.
- Repetition of the current CD.
- Random playback of tracks, CD by CD.

This can be accessed in two ways :

- Either by pressing button **O** and proceeding as for Search of Stations RDS – for screen C, the sub-menu corresponds to the Audio Preferences.
- Or if you are in CD changer source by pressing button **L**. You then have access to the AUDIO menu (for screen C only).

Note :

If one of these options is active, it remains active for CD source.

Your audio system may be BLUETOOTH compatible. It allows you to connect a **mobile telephone** for use “**hands free**” and even to use its directory.

It permits you to twin up to four telephones, to be able then to connect whichever one you choose.

The Bluetooth functions available and the content of the display are dependent on the type of mobile telephone, its settings and the type of contract you have. For this reason it is advisable to make enquiries with your telephone provider.

Prior to any operation :

- Your display should be lit up (key in position **M**).
- Your telephone's Bluetooth system must be activated.

TWINNING A TELEPHONE

Twinning a telephone consists of having it recognised by the BLUETOOTH system on your vehicle. This then permits an instantaneous connection.

Twinning can only be performed with **ignition switched on, display illuminated, engine stopped**. No other telephone should be connected.

- The twinning must be performed with the telephone and its Bluetooth system activated.

Note :

Refer to the user instructions to familiarise yourself with the features of twinning.

- The telephone detects the Bluetooth system on your vehicle. “**CITROËN**” displays on your telephone.

You should then select “**CITROËN**” on your telephone controls. Next you have to decide whether or not to accept this twinning, then select on display **C**, using **J** or **M**, one of the **4** memories. Validate with a press on button **L**.

Note :

You can select a memory already attributed, although the telephone twinned to this location will no longer be.

- Next the telephone asks you to enter an identification code : **1234**.
- Validate.

Note :

This entry may be demanded earlier in the twinning sequence.

The telephone is now twinned to your Bluetooth system. For immediate access to the Bluetooth functions, it may be necessary to make a connection (see following page **Configuration : Connecting a twinned mobile telephone**).

Once the twinning is finished, you will be able to connect your telephone via the “**Main menu**”.

CONNECTING A TWINNED TELEPHONE

Each time you enter the vehicle, after switching on the audio system, your telephone is detected automatically. If more than one telephone is present, the last telephone to have been connected is the first to be recognised.

Note :

Disconnections may occur. You may have to make a new connection (see following page, **Configuration : Connecting a twinned mobile telephone**).

Remarks :

- In the event of a problem, it is recommended to switch your telephone off and then on again.
- If you switch off your telephone within the field of reception of the Bluetooth system on your vehicle, the next connection will not be automatic. To restore automatic connection, you will have to connect your telephone manually (see following page, **Configuration : Connecting a twinned mobile telephone**).
- If you are already in telephone communication when the audio system is turned on, the latter detects the telephone.
- To avoid interference, you are advised not to place your mobile telephone close to your radio.

TO ACCEPT AN INCOMING CALL

Use button **L**.

MAIN MENU

Press on the Menu button **O** to access to Main menu, then select the “**Telephone**” icon using buttons **J** ou **M**), then validate the selection via button **L**.

You have access :

- To the Directory.
- To Configuration.
- To Communication Management.

You access your choices via (**J** ou **M**), then you validate them with a press on **L**.

This main menu can also be accessed by pressing button **E** then button **L**.

DIRECTORY

This menu lets you open :

- The telephone Directory of the telephone that is connected.
- The Calls List.

Telephone directory

The starting of a telephone call can be done independently of the telephone or of the audio system, thanks to the directory.

The directory is displayed. Select the number via **J** or **M**, then validate with a press on **L**.

Remarks :

- The directory displayed updates itself automatically.
- If the person to be called does not figure in the directory, the call can only be made starting from the telephone.
- If you have information recorded in the Vcard format, you must select the person you wish to call, then validate. A list of 4 numbers maximum can be displayed with the following labels : “**Home**”, “**Office**”, “**Mobile**” and “**Car**”.

Calls list

After selecting this component and then validating, the calls list is displayed with a maximum of : **10** calls made (arrow pointing upward), **10** calls received (arrow pointing downward) and **10** calls not connected.

It is possible to make a call starting from this list : Select the number via **J** or **M**, then validate with a press on **L**.

CONFIGURATION

This menu allows you to :

- **Deleting a twinning.** Using **J** or **M**, select this choice, then validate on **L**. Select in the list the telephone that you no longer wish to have twinned. Validate.
- **Consulting the list of twinings.** The list of telephones twinned is displayed.
- **Connecting a mobile telephone that is twinned.** Select the telephone that you wish to connect. This access allows you to make a connection manually.

CALL MANAGEMENT

This menu is accessible during your calls, permitting you to :

- Swap a call if there is another call incoming.
- End a call.
- Be in Secret mode.

Remark :

If you are in telephone conversation, you have access to this menu “**Configuration**” by pressing **L**.

Swapping a call

During a telephone conversation, the system is able to tell you of a second call incoming. To accept it, validate. To change from one call to the other, select this choice.

End a call

This choice enables you to end a telephone conversation, for example if there is another call incoming.

Secret mode

Select this choice. This allows you not to be heard by the other person. To restore sound to the other person, select deactivation of Secret mode in the menu "**Call Management**".

Note :

If you wish to transfer a call from the audio system to the mobile telephone (for example when leaving your vehicle), refer to the user instructions for the latter.

VOICE RECOGNITION

A short press on the end of the control stalk 7 starts telephone voice recognition.

Voice recognition allows you to make a call to a number for which you have recorded a label on the mobile telephone that is twinned and connected.

Remark :

It is possible to stop the call, provided the dialling has not yet commenced, with a short press on the end of the lighting control stalk 7.

Remarks :

- While you are on a call, the audio source currently being listened to is paused.
- Some ring tones on your mobile telephone may not be recognised by the Bluetooth system on your vehicle. A different ring tone will be chosen by the system.

DISPLAYS

A press on the "TEL" button displays the telephone information on the right on your screen.

A "**Telephone**" symbol appears on your display when you connect a mobile telephone.

A "**Battery**" symbol appears at the bottom of the display to indicate the range of the mobile telephone connected.







An "**Envelope**" symbol appears at the bottom of the display to indicate the presence of an unread SMS on the mobile telephone connected.

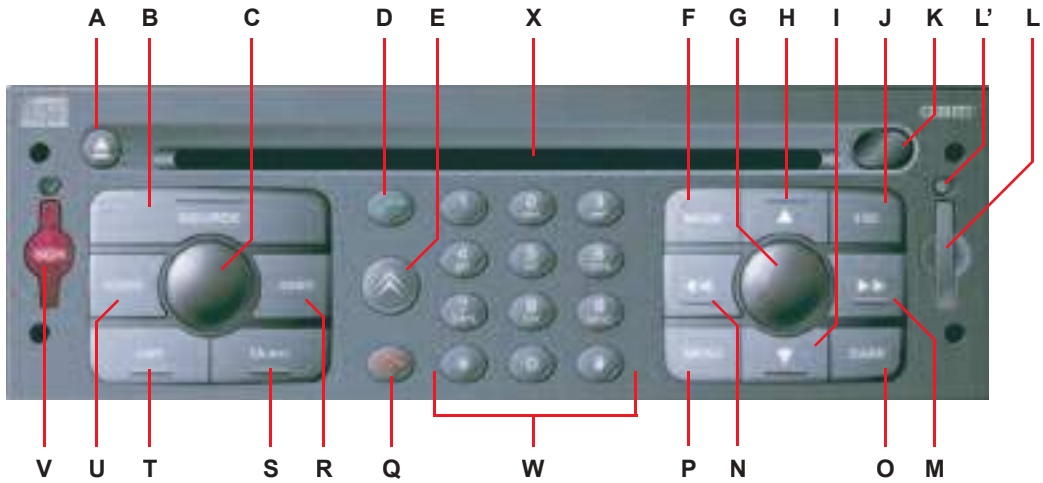

A "**Sound track**" symbol appears at the bottom of the display to indicate the presence of a message on the mobile telephone connected.



NAVIDRIVE WITH CD CHANGER





A		CD eject.			
B	SOURCE	Selection of audio source (Radio, CD, CD changer and MP3).	H		Radio source : Manual search of higher frequencies. CD/MP3 changer source : Selection of previous CD / previous CD-cover. Other sources : To move in the menus.
C		Press : On / Off. Rotate : Volume adjust.			
D		Short press : Answer call. Display of telephone menu.	I		Radio source : Manual search of lower frequencies. CD/MP3 changer source : Selection of the next CD / next CD-cover. Other sources : To move in the menus.
E		Short press : Access to the CITROËN services menu. Long press : Direct call to the CITROËN assistance service.	J	ESC	Short press : Cancel the current operation or delete a superimposed display.
F	MODE	Selection of the type of information displayed on the right of the screen (Radio, Navigation, Trip computer, etc.).	K		Infrared port.
			L		SIM card slot.
G		<ul style="list-style-type: none"> • If you rotate it, the control allows you : <ul style="list-style-type: none"> - To move in the display in order to choose a function, a parameter or a value. - To decrease or to increase an adjustment value. - To scroll down the list of elements to be selected. - To modify the scale of the map on the display. • If you press it, the control allows you : <ul style="list-style-type: none"> - To access the contextual menu (short-cut to certain choices for the function displayed on the right). - To validate the function chosen or the value modified. - To select a parameter such as “adjust” or “list”, to be able to modify it. - To activate/deactivate a function. 	L'		SIM card eject button.
			M		Radio source : <ul style="list-style-type: none"> • Short press : Automatic search of higher frequencies. CD or CD changer source : <ul style="list-style-type: none"> • Short press : Search of the next track. • Long press : Fast forward with accelerated sound. MP3 source : <ul style="list-style-type: none"> • Short press : Search of the next track. • Long press : Rapid scrolling of previous tracks. Other sources : Moving in the menus.

N		<p>Radio source :</p> <ul style="list-style-type: none"> • Short press : Automatic search of lower frequencies. <p>CD and CD changer source :</p> <ul style="list-style-type: none"> • Short press : Search of previous track. • Long press : Rapid reverse with accelerated sound. <p>MP3 source :</p> <ul style="list-style-type: none"> • Short press : Search of previous track. • Long press : Rapid scrolling of previous tracks. <p>Other sources : Moving in the menus.</p>
O	DARK	<p>Short successive presses :</p> <ul style="list-style-type: none"> • One press : Only the top part of the display remains lit. • Two presses : Display off (blank display). • Three presses : Return to the standard display. <p>Long press (more than 10 seconds) : Re-initialisation of the system.</p>
P	MENU	<p>Short press : Access to the Main Menu.</p> <p>Long press : Access to the Help Menu for voice commands, to the description of your equipment, to the demonstration of Navigation and to the status of services.</p> <p>In certain countries, this control is deactivated while the vehicle is moving.</p>
Q		<p>Call in progress :</p> <ul style="list-style-type: none"> • Short press : End a call.
R	BAND	<p>Short press : Selection of frequency bands and memory banks.</p> <p>Long press : Automatic memorisation of FM stations (Autostore).</p>

S	TA/PTY	<p>Short press : Traffic information on/off.</p> <p>Long press : PTY On/Off.</p>
T	LIST	<p>Short press : Display of the list of available radio stations (30 maximum) or of the list of CD tracks.</p> <p>Long press : Update of list of stations.</p>
U	AUDIO	<p>Call-up of the audio adjustment functions :</p> <p>Sound ambiances, bass, treble, loudness, fade, balance, speed-sensitive volume.</p>
V	SOS	<p>Long press (between 2 and 8 seconds) : Emergency call.</p>
W	123456	<p>Radio source :</p> <ul style="list-style-type: none"> • Short press : Recall of pre-set stations. • Long press : Pre-setting of stations.
	12345	<p>CD changer source : Selecting a CD.</p>
	012345 6789*#	<p>Other sources :</p> <ul style="list-style-type: none"> • Any alphanumeric entry (telephone, address, adjustment of date/time, etc.). • Rapid selection of a name commencing with the letter chosen, in the directory and in the SIM card.
X		<p>CD aperture.</p>
Z		<p>CD changer.</p>

Buttons H, I, M and N allow you, in "Select - Move on Map", to move respectively up or down, right or left on the map.

1		<p>Radio source :</p> <ul style="list-style-type: none"> • Scrolling of pre-set stations. <p>CD changer source :</p> <ul style="list-style-type: none"> • Selection of next or previous CD. <p>MP3 source :</p> <ul style="list-style-type: none"> • Selection of the next or previous CD-cover. <p>Other sources :</p> <ul style="list-style-type: none"> • Selection of the next or previous elements of a menu in a screen, a list, an alphabet. 	4		Volume increase.
2		<p>Radio source :</p> <ul style="list-style-type: none"> • Short press : Automatic search of higher frequencies. <p>CD and CD changer source :</p> <ul style="list-style-type: none"> • Short press : Search of the next track. • Long press : Fast forward with accelerated sound. <p>MP3 source :</p> <ul style="list-style-type: none"> • Short press : Search of the next track. • Long press : Rapid scrolling of following tracks. 	5	SRC	<p>Short press : Change of audio source (RADIO, CD, CD CHANGER, MP3) and audio/video auxiliary input.</p> <p>Long press : Display of the telephone contextual menu (excluding numbers).</p> <p>Incoming call, telephone communication :</p> <ul style="list-style-type: none"> • Short press : Answer call, end call. <p>Other cases :</p> <p>In a menu, a list, an alphabet :</p> <ul style="list-style-type: none"> • Short press : Validation of the function, the element or the value chosen.
3		<p>Radio source :</p> <ul style="list-style-type: none"> • Short press : Automatic search of lower frequencies. <p>CD and CD changer source :</p> <ul style="list-style-type: none"> • Short press : Search of previous track. • Long press : Rapid reverse with accelerated sound. <p>MP3 source :</p> <ul style="list-style-type: none"> • Short press : Search of previous track. • Long press : Rapid scrolling of previous tracks. 	6		Volume decrease.
			4+6		<p>Simultaneous press on both buttons :</p> <p>Mute (temporary sound pause).</p>
			7		<p>Lighting control stalk</p> <ul style="list-style-type: none"> • Short press on the end : Activation/Deactivation of the Voice Commands function.



NAVIDRIVE WITH CD CHANGER

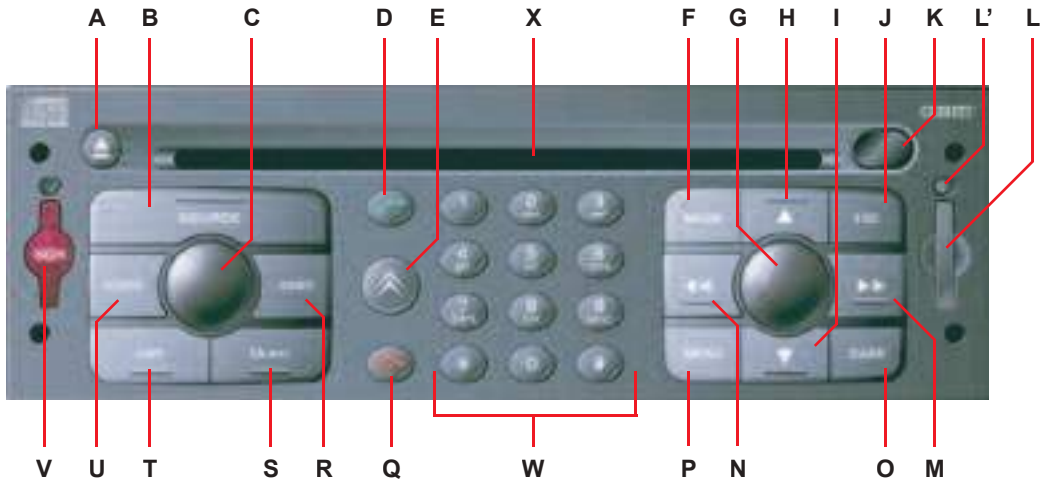

ON / OFF

With the ignition key in Drive position M, press on the control **C** to turn the audio part on or off.

Note :

- If the audio part of NaviDrive was on before you last switched off the ignition, it will automatically resume when you switch on the ignition again.
- The source selected when you switch off NaviDrive is memorised and will resume when you switch on again.
- After the ignition is switched off, with or without the key being present, NaviDrive can continue to operate for a maximum of 30 minutes if you press one of the buttons **S**, **V**, **D**, or **E**, or if you insert a CD in the CD reader.

DESCRIPTION

A long press on **P** brings up a technical description of your equipment.

SIM CARD

- Open the slot **L** by pressing with the point of a pencil, or similar, on the opening just above it **L**. Next, insert your SIM card in the slot, then reclose it.
- The **SIM** card should only be removed from its slot **L** after NaviDrive has been switched off (key in position **S** (Steering lock) and display turned off).
- Its presence is indispensable for certain functions to operate correctly.

RE-INITIALISATION

If NaviDrive should malfunction, you can re-initialise it with a long press (more than 10 seconds) on control **O**.

ANTI-THEFT SYSTEM

Your NaviDrive is coded so as to function only on your particular vehicle. It cannot be used on any other vehicle.

Note :

The anti-theft system is automatic and requires no action on your part.

TECHNICAL SPECIFICATIONS

Your NaviDrive possesses :

- 3 wavebands (MW/LW/FM).
- A dual tuner (if a colour screen) with RDS EON PTY, display of PS name, Radio TEXT, RDS programme search, TA traffic info., TMC Traffic Information, 24 pre-selections (18 FM - 6 MW/LW), automatic memorisation of the strongest AST stations.
- An MP3- compatible CD reader.
- A GSM telephone dual-band phase 2 (900MHz/1800MHz), of 2 Watts with voice commands and memorisation of the PIN code.
- A voice synthesiser for navigation instructions, for reading text messages (SMS) and for RDS - TMC information.
- Audio power of 4x35 W.



MULTIFUNCTION DISPLAY

According to your choices, it displays the information on the following functions: Navigation – Traffic information, Audio, Directory, Telephone and Telematic Services, Configuration and Map.

It is possible to modify the information that is displayed on the right of your screen by pressing **F** or using voice commands.

The type of information on the left and at the top of the screen depends on the choices made on the right.

Certain actions and types of information (alerts, adjustments, contextual menu) are signalled by the temporary opening of a window on the screen.

The display also gives you your vehicle configuration.

MOVING IN THE MENU

Buttons **G**, **H**, **I**, **M**, **N** and control **1** at the steering wheel enable you to move in the menus and a press on button **G** allows you to validate your choices.

It is recommended that you do not use the NaviDrive controls while your vehicle is moving. In some countries, certain commands may be deactivated to comply with national regulations.

MAINTENANCE

For maintenance of the display screen, it is recommended to use a non-abrasive cloth and a cleaning product for IT screens.



MAIN MENU

A press on button **P** gives you access to all the functions available on your NaviDrive :

- Navigation – Traffic information.
- Audio.
- Directory.
- Telephone and telematic services.
- Configuration of your vehicle.
- Map (if colour screen).

The description of these is set out in the following pages. Certain choices will appear only if you have subscribed to a specific contract.

CONTEXTUAL MENU

A press on button **G** gives you access to certain of the choices that are available for the function displayed on the right of your screen.

MENU STRUCTURE FOR NAVIGATION – 7

TRAFFIC INFORMATION

 NAV	CHOOSE A DESTINATION PAGE 19 NAV 1	Enter an address 19 NAV 1. a NaviDrive services 19 NAV 1. b Choice of a centre of interest 20 NAV 1. c Directory 20 NAV 1. d Choice of one of the last twenty destinations 20 NAV 1. a			
STAGES AND ROUTES PAGE 21 NAV 2	Adding a stage 21 NAV 2. a Sort/delete stages 21 NAV 2. b Varying the route 21 NAV 2. c Destination chosen (to change it) 21 NAV 2. d				
MODIFY THE GUIDANCE OPTIONS PAGE 21 NAV 3	Defining the route calculation criteria 21 NAV 3. a Adjusting the voice synthesiser 21 NAV 3. b Activate/Deactivate pronunciation of the street name 21 NAV 3. c Viewing information on the navigation CD-ROM 21 NAV 3. d Deleting the last destinations 21 NAV 3. e				
TMC TRAFFIC INFORMATION PAGE 21 NAV 4	Consulting of messages 23 NAV 4. a Filtering TMC information NAV 4. b <table border="0" data-bbox="1053 742 1484 862"> <tr> <td>Activate/Deactivate filter on route 23</td> </tr> <tr> <td>Filtering by incident 23</td> </tr> <tr> <td>Geographical filter 23</td> </tr> <tr> <td>Choice of TMC station 23</td> </tr> </table> Adjusting the voice synthesiser 21 NAV 4. c Activate/Deactivate showing of messages 21 NAV 4. d	Activate/Deactivate filter on route 23	Filtering by incident 23	Geographical filter 23	Choice of TMC station 23
Activate/Deactivate filter on route 23					
Filtering by incident 23					
Geographical filter 23					
Choice of TMC station 23					
STOP/RESUME GUIDANCE 17 NAV 5					
CONTEXTUAL MENU FOR NAVIGATION – TRAFFIC INFORMATION 18					

8 MENU STRUCTURES FOR AUDIO - TRIP COMPUTER



AUD

Activate/deactivate the RDS function in FM	25
AUD 1. a	
Activate/deactivate regional search mode in FM	25
AUD 1. b	
Activate/deactivate display of Radio Text	25
AUD 1. c	
Activate/deactivate display of CD MP3 detail	25
AUD 1. d	

CONTEXTUAL MENU FOR RADIO SOURCE	25
---	-----------

CONTEXTUAL MENU FOR CD SOURCE	31
--	-----------

CONTEXTUAL MENU FOR MP3	31
--------------------------------------	-----------

CONTEXTUAL MENU FOR CD-CHANGER SOURCE	32
--	-----------



ODB

Enter a distance to destination	33
Modify the units	33
Display the log of alerts	33
ODB 2. a	
Display the level of charge of the reserve battery	33
ODB 2. b	
Display the status of GPS coverage	33
ODB 1. c	

TRIP COMPUTER CONFIGURATION
PAGE 33
ODB 1

DIAGNOSIS
PAGE 33
ODB 2

STATUS OF FUNCTIONS
ODB



CONTEXTUAL MENU FOR TRIP COMPUTER	33
--	-----------

 REP	MANAGING DIRECTORY FILES PAGE 34 REP 1	Consult or modify a file..... 34 REP 1. a Add a file 34 REP 1. b Delete a file 34 REP 1. c Delete all files 34 REP 1. d														
	CONFIGURATION PAGE 34 REP 2	Select directory..... 34 REP 2. a Name directory 34 REP 2. b Choose the start directory..... 34 REP 2. c														
	TRANSFER OF FILES PAGE 35 REP 3	Exchange by infrared ———— REP 3. a <table border="0" style="margin-left: 20px;"> <tr> <td>Send all files..... 35</td> <td>REP 3. a.I</td> </tr> <tr> <td>Send a file 35</td> <td>REP 3. a.II</td> </tr> <tr> <td>Receive by infrared..... 35</td> <td>REP 3. a.III</td> </tr> </table> Exchange with the SIM card ———— REP 3. b <table border="0" style="margin-left: 20px;"> <tr> <td>Send all files to SIM..... 35</td> <td>REP 3. b.I</td> </tr> <tr> <td>Send a file to SIM..... 35</td> <td>REP 3. b.II</td> </tr> <tr> <td>Receive all files from the SIM..... 35</td> <td>REP 3. b.III</td> </tr> <tr> <td>Receive a file from the SIM 35</td> <td>REP 3. b.IV</td> </tr> </table>	Send all files..... 35	REP 3. a.I	Send a file 35	REP 3. a.II	Receive by infrared..... 35	REP 3. a.III	Send all files to SIM..... 35	REP 3. b.I	Send a file to SIM..... 35	REP 3. b.II	Receive all files from the SIM..... 35	REP 3. b.III	Receive a file from the SIM 35	REP 3. b.IV
Send all files..... 35	REP 3. a.I															
Send a file 35	REP 3. a.II															
Receive by infrared..... 35	REP 3. a.III															
Send all files to SIM..... 35	REP 3. b.I															
Send a file to SIM..... 35	REP 3. b.II															
Receive all files from the SIM..... 35	REP 3. b.III															
Receive a file from the SIM 35	REP 3. b.IV															

MENU STRUCTURE FOR TELEPHONE AND TELEMATIC SERVICES

			
	CALL		38
	TEL 1		
	SERVICES		
	PAGE 40		
	TEL 2		
		CITROËN on Line.....	39
		TEL 2.a	
		CITROËN Assistance.....	39
		TEL 2.b	
		NaviDrive services.....	39
		TEL 2.c	
		Messages received.....	39
		TEL 2.d	
		Network.....	40
		TEL 3.a	
		Duration of calls.....	40
		TEL 3.b	
		Managing the PIN code.....	40
		TEL 3.c	
		Call options.....	
		TEL 3.d	
		Configure calls.....	40
		Ringtone options for voice calls.....	40
		Voice callback no. for SMS messages.....	40
		Delete the list of calls and SMS messages.....	40
	TELEPHONE FUNCTIONS		
	PAGE 40		
	TEL 3		
	TEXT MESSAGING (SMS)		
	PAGE 40		
	TEL 4		
		Reading of SMS messages.....	40
		TEL 4.a	
		Sending of SMS messages.....	40
		TEL 4.b	
		Composing an SMS message.....	40
		TEL 4.c	
		Delete the list of SMS messages.....	40
		TEL 4.d	
	CONTEXTUAL MENU FOR TELEPHONE AND TELEMATIC SERVICES		38

MENU STRUCTURE FOR CONFIGURATION – MAP – VIDEO

 CFG	<p>DEFINE THE VEHICLE PARAMETERS PAGE 42 CFG 1</p>	<p>Operation of rear screen wipe..... 42 Lighting configuration..... 42</p>
<p>DISPLAY CONFIGURATION PAGE 42 CFG 2</p>		<p>Choice of colours..... 42 Adjusting brightness and contrast 42 Sound..... 42 International parameters (time, date, etc.)..... 42 Choice of language..... 42</p>
 CAR	<p>MOVE THE MAP CAR 1</p>	<p>Map oriented to North..... 44</p>
<p>ORIENTATION OF THE MAP PAGE 44 CAR 2</p>	<p>CENTRE AROUND THE VEHICLE CAR 3</p>	<p>Map oriented to the vehicle 44</p>
<p>MAP DETAILS CAR 4</p>	<p>MEMORISE THE CURRENT POSITION CAR 5</p>	<p>..... 44</p>
<p>CONTEXTUAL MENU FOR MAP CAR 5</p>		<p>..... 44</p>

GENERAL

Voice commands can control a certain number of functions :

- Using a voice label recorded by the user, for example : “Office” or “Home”. To enhance the recognition of these labels, you are recommended to record them using different intonations.
- Using pre-recorded words and expressions, for example : “Radio”, “Help”.

The voice commands function in a logical sequence. A word voiced at one level must be recognised before another word at the next level can be recognised.



ACTIVATION/DEACTIVATION OF VOICE RECOGNITION

Give a short press on the end of the lighting control stalk **7** to activate this function.

Activation of the function is confirmed by a beep and by the opening of a window on the display. The system is then listening. If the word pronounced is understood by the system, then it is displayed in the window and a beep is heard. Otherwise the system says “**Sorry**”. You then have to say the word again.

Voice commands are deactivated automatically and the system emits a double beep, when an action has been completed using voice commands.

If no voice commands are given, this function is deactivated after a few seconds and the system says “**End of recognition**”.

A press on the end of the lighting control stalk **7** or on **J**, deactivates the function.

Example :

To obtain memorised radio station no. **3** : Pronounce the word “**Radio**”, wait for the system to reply with a beep, then pronounce the word “**Memory**”, wait for the system to reply with a beep, then finish with the word **3**.

After the double beep, the desired action is performed.

If you say the word “**Help**” and “**What can I say**”, you will see displayed all the commands that are available at the moment of this request.

Say the key words that correspond to the action that you wish carried out.

If you should lose your way in the different levels of the voice command structure, say the word “**Cancel**” to bring you back to the voice commands at the previous level of the structure.

However careful the user may be, the pre-recorded words or expressions will always be more easily recognised than words recorded by the user.

LIST AND STRUCTURE OF VOICE COMMANDS

Display	Audio	Displays the information on the current audio source in the right hand part of the screen	
	Guidance	Displays the information on navigation/guidance in the right hand part of the screen	
	Navigation	Displays the information on navigation/guidance in the right hand part of the screen	
	Trip computer	Displays the information on the trip computer in the right hand part of the screen	
	Telephone	Displays the telephone information in the right hand part of the screen	
	Cancel	Returns to the first level of the voice commands structure	
	Help	Displays the voice commands possible at this level	
	What can I say	Displays the voice commands possible at this level	
Call	"Pre-recorded label"	Starts a telephone call to the first number on the record associated with the voice label pronounced	
Stop		Stops voice commands	
Changer		Changes to CD changer audio source	
Changer	Disc number	1-6	Changes to CD changer playback for the number given
		Cancel	Returns to the first level of the voice commands structure
		Help	Displays the voice commands possible at this level
		What can I say	Displays the voice commands possible at this level
	Previous disc	Changes to playback of the previous CD in the changer	
	Next disc	Changes to playback of the next CD in the changer	
	Random playback	Activates, or deactivates, random playback of the current CD	
	List	Displays the list of the tracks on the CD currently being played	
	Track number	1-20	Changes to playback of the track, of the current CD, for the number given
		Cancel	Returns to the first level of the voice commands structure
		Help	Displays the voice commands possible at this level
		What can I say	Displays the voice commands possible at this level
	Previous track	Changes to the previous track of the current CD	
	Next track	Changes to the next track of the current CD	
	Repeat	Activates, or deactivates, repetition of playback of the current CD	
	Scan	Activates, or deactivates, playback of the start of tracks of the current CD	
	Cancel	Returns to the first level of the voice commands structure	
Help	Displays the voice commands possible at this level		
What can I say	Displays the voice commands possible at this level		

LIST AND STRUCTURE OF VOICE COMMANDS

Guidance	Stop		Stops the current guidance	
	Directory	"Pre-recorded label"	Starts guidance towards the address contained in the record associated with the voice label pronounced	
	Restart		Resumes guidance towards the last destination selected	
	See	Destination		Centres the map on the current or previous destination
		Vehicle		Centres the map around the vehicle
		Cancel		Returns to the first level of the voice commands structure
		Help		Displays the voice commands possible at this level
		What can I say		Displays the voice commands possible at this level
	Zoom in		Enlarges the zone represented on the map	
	Zoom out		Reduces the zone represented on the map	
	Cancel		Returns to the first level of the voice commands structure	
	Help		Displays the voice commands possible at this level	
What can I say		Displays the voice commands possible at this level		
Guide to	"Pre-recorded label"		Starts guidance towards the address contained in the record associated with the voice label pronounced	
Traffic info	Display		Displays the list of TMC traffic information messages	
	Read		Reads the message in the list of TMC messages or reads the last message selected	
	Cancel		Returns to the first level of the voice commands structure	
	Help		Displays the voice commands possible at this level	
	What can I say		Displays the voice commands possible at this level	
CD player			Change to CD audio source	
CD player	Random playback		Activates, or deactivates, random playback of the CD	
	List		Displays the list of the tracks on the CD currently being played	
	Track number	1-20		Changes to playback of the track for the number given
		Cancel		Returns to the first level of the voice commands structure
		Help		Displays the voice commands possible at this level
		What can I say		Displays the voice commands possible at this level
	Previous track		Changes to the previous track of the CD	
	Next track		Changes to the next track of the CD	
	Scan		Activates, or deactivates, playback of the start of tracks of the CD	
	Cancel		Returns to the first level of the voice commands structure	
	Help		Displays the voice commands possible at this level	
	What can I say		Displays the voice commands possible at this level	
	Directory	Repeat		Activates or deactivates repetition of playback of the current CD-cover
		Next		Changes to the next CD-cover
		Previous		Changes to the previous CD-cover
		Cancel		Returns to the first level of the voice commands structure
Help			Displays the voice commands possible at this level	
What can I say			Displays the voice commands possible at this level	

LIST AND STRUCTURE OF VOICE COMMANDS

Message	Display		Displays the list of SMS messages	
	Read		Reads the last SMS message received or the SMS selected in the list of messages	
	Cancel		Returns to the first level of the voice commands structure	
	Help		Displays the voice commands possible at this level	
	What can I say		Displays the voice commands possible at this level	
Navigation	Stop		Stops the current guidance	
	Directory	"Pre-recorded label"	Starts guidance towards the address contained in the record associated with the voice label pronounced	
	Restart		Resumes guidance towards the last destination selected	
	See	Destination		Centres the map on the current or previous destination
		Vehicle		Centres the map around the vehicle
		Cancel		Returns to the first level of the voice commands structure
		Help		Displays the voice commands possible at this level
		What can I say		Displays the voice commands possible at this level
	Zoom in		Enlarges the zone represented on the map	
	Zoom out		Reduces the zone represented on the map	
	Cancel		Returns to the first level of the voice commands structure	
Help		Displays the voice commands possible at this level		
What can I say		Displays the voice commands possible at this level		
No		Cancels a request to delete an SMS message		
Yes		Confirms a request to delete an SMS message		
Previous	Changes to the previous radio station, or previous CD/CDC track. If an SMS is being read, reads the previous SMS message			
Radio	Changes to Radio audio source			
	Autostore		Memorises the 6 strongest FM stations that can be received where the vehicle is	
	List		Displays a list of the stations that can be received where the vehicle is	
	Memory	1-6		Selects the station corresponding to the memory bank number given
		Cancel		Returns to the first level of the voice commands structure
		Help		Displays the voice commands possible at this level
		What can I say		Displays the voice commands possible at this level
	Previous		Starts an automatic search for the previous radio station	
	Next		Starts an automatic search for the next radio station	
	Cancel		Returns to the first level of the voice commands structure	
	Help		Displays the voice commands possible at this level	
What can I say		Displays the voice commands possible at this level		

LIST AND STRUCTURE OF VOICE COMMANDS

SMS	Display		Displays the list of SMS messages
	Read		Reads the last SMS message received or the SMS selected in the list of messages
	Cancel		Returns to the first level of the voice commands structure
	Help		Displays the voice commands possible at this level
	What can I say		Displays the voice commands possible at this level
Stop			Stops the reading of SMS messages. Stops voice commands
Next		Changes to the next radio station, or next CD/CDC track. If an SMS is being read, reads the next SMS message	
Delete			Requests deletion of the SMS message currently being read
Telephone	Mail box		Starts a telephone call to the user's mail box
	Last number		Starts a telephone call to the most recent number figuring in the user's calls list
	Voice messaging		Starts a telephone call to the user's mail box
	Directory	"Pre-recorded label"	Starts a telephone call to the first number on the record associated with the voice label pronounced
	Cancel		Returns to the first level of the voice commands structure
	Help		Displays the voice commands possible at this level
What can I say		Displays the voice commands possible at this level	
Help			Displays the voice commands possible at the first level
What can I say			Displays the voice commands possible at the first level

When navigation is to be used for the first time, or when the battery has been disconnected for any reason, the navigation system has to be initialised. For this operation the vehicle must be parked outdoors so that it can pick up satellite signals. Turn the ignition to position M (see vehicle Handbook) and leave for at least fifteen minutes.

INTRODUCTION

The on-board navigation system uses audible and visual instructions to guide you towards the destination of your choice.

The system uses a cartographic database stored on a CD-ROM, and a GPS system.

The GPS system enables your position to be plotted via contact with a number of satellites.

The navigation system is composed of the following elements :

- A CD-ROM reader.
- A button for recall of the last voice message - during navigation, a long press on the end of the lighting control stalk **7** repeats the latest voice information.
- Cartographic data in the form of a CDROM that has to be inserted, printed side up, in the aperture **X**.
- A synthesised voice for enunciating the guidance instructions during navigation.
- A display screen.
- A GPS aerial.
- Control on the dashboard and controls at the steering wheel.

Specific functions or services may vary depending on the CD-ROM version or the country where the system is used.

GPS satellite reception or guidance calculation may be affected temporarily (for example under bridges or in underground car parks, etc.) by where the vehicle is located.

TMC TRAFFIC INFORMATION

In some countries, traffic information messages are transmitted by FM radio stations. Such information, broadcast by the RDS system, can be received and decoded by NaviDrive. See the description of this function from page 21.

VOLUME FOR VOICE INSTRUCTIONS

When receiving voice instructions, you can adjust the volume using button **C**, or controls **4** and **6** at the steering wheel.

You can deactivate voice instructions via the menu "Configuration" - "Display" - "Sound".



MAIN MENU FOR NAVIGATION – TRAFFIC INFORMATION

Press on **P** then use the control **G** to select the icon Navigation - Traffic information to access the following choices :

- **Selecting a destination.**
- **Stages and routes.**
- **Guidance options.**
- **TMC traffic information.**
- **Stop/resume guidance.**

After the start of a guidance, a display cautions you concerning the use of navigation. If you accept its content, press on **G**.

Respect the road regulations that are in force.



During navigation, provided the navigation CD-ROM is present, the display indicates the manoeuvres to be made :

- 1 In navigation : manoeuvre to be made or, momentarily, direction to follow.
Except during guidance : Display of a compass.
- 2 Next manoeuvre to be made.
- 3 Next road to be taken and name of town.
- 4 Symbol concerning Traffic Information or services in proximity (colour display).
- 5 Road currently being taken and name of town.
- 6 Estimated time of arrival at destination (based on flowing traffic).
- 7 Distance to final destination.
- 8 Distance to the next manoeuvre.

Remark :

Depending on the situation of the vehicle and the reception of the GPS information, this information may temporarily be absent from the screen.

Tip :

When Navigation is being displayed, a long press on the “Menu” button activates a demonstration of the Navigation function of your NaviDrive.

Next select a destination by using the Navigation Menu. After entering this, start Navigation and see a simulation of the movements of your vehicle. The point of departure will be either the place where the vehicle is now, or the last known location. It is possible to enter a different point of departure via the demonstration menu. This demonstration can let you see a route that you wish to take in the future.



CONTEXTUAL MENU FOR NAVIGATION – TRAFFIC INFORMATION

A press on **W** during navigation brings up a display on the right of the screen, permitting you to :

- **Modify the display of the map.** Display full screen or on the right hand side (colour screen only).
- **Alter the route.** During guidance this function lets you modify your original route. Enter the distance of the desired diversion then select the “OK” function and validate.
- **Memorise the position of the vehicle.** The vehicle position will be saved in the current directory, under a label for name of town and street (if available on the Navigation CDROM). Otherwise the label corresponds to GPS coordinates for the location.
- **Modify the guidance criteria for your itinerary.**
- **Stop/resume guidance.**



CHOOSE A DESTINATION

This menu allows you to :

- **Enter an address.**
- Access **NaviDrive Services** if you have subscribed to a specific contract (assistance and entry of a destination).
- **Choose a centre of interest** that is available in a town (restaurant, airport, hotel, cinema, theatre, etc).
- **Choose a destination stored in a directory.**
- **Choose one of the last twenty destinations.**



ENTER AN ADDRESS

The last guidance address is displayed.

1 Enter a town name

- To enter the name of a town, select "**Town**" then validate. Next, select then validate letter by letter or enter them using the alphanumeric keypad.

If you make an error, press "**Correct**" to delete the last letter entered.

Remark :

After the first letter has been validated, only those letters that can complete an existing name in the database will be displayed.

- "**List**" tells you, as you begin to enter the name of the town, how many towns start with or include the same letters. Select "**List**" to choose one of them.

- If the list contains less than 6 names, these last will display automatically. Select a town, then validate. When the complete name of the town is displayed, select it then validate "**OK**".

2 Enter the name of the street

Enter the street name in the same way as you entered the town name.

Note : Do not enter the type of road (street, avenue ,etc.).

3 Validation

When the complete name of the street is displayed, select it then validate "**OK**".

Tips :

- If you enter only the name of the town and then validate immediately "**OK**", you will go directly to the town centre.
- The function "**Store**" memorises the address displayed into a file of the current directory.
- The selection "**Present location**" displays the current address.
- The selection "**GPS**" brings up the GPS coordinates.



4 Enter a street no. or the name of an intersecting street

You can enter the number of the street you require, using either control **G** or the alpha-numeric keypad.

Select then validate “**OK**”.

Remark :

The first and last street numbers are displayed.

You can also select a street from the list of “Intersections”, which means you do not have to enter the street no.

Remark :

If the street selected has no numbers, the list of street intersections is automatically displayed.

The complete destination is then displayed.

Select then validate “**OK**”, to start the guidance.

Follow the action instructions.



CHOICE OF A CENTRE OF INTEREST

If you desire to be directed to a centre of interest, select the type of centre of interest and validate.

The list of centres of interest of the type selected then appears. Select then validate the centre of interest desired, in order to access the menu “**Choice of location**”.

The last-entered address is displayed.

There are 3 possibilities for defining the location close to which you desire to find a centre of interest :

- Take the last address entered by validating the “**OK**” function.
- Enter the name of a different town then enter the street name (optional).
- Bring up the name of the place you are currently at, via the function “**Present location**”.

Remark :

If the centre of interest selected is not available at the programmed location, a message informs you of this.

After validation of the location, the centre of interest closest to your location appears. The distance indicated is the distance in a straight line from this location.

A message in the strip (X/n) tells you if there is more than one establishment (n = maximum) offering a similar centre of interest within a radius of 50 km in a straight line from the location selected.

Use “<<”, “>>” or “<”, “>” to study the list on offer.

When the establishment of your choice appears, you can choose :

- “**OK**” to activate guidance to this centre of interest.
- “*1” to add it to your directory.
- “**Contact**” to make a call to this centre of interest.

SELECTION FROM THE DIRECTORY

The function “**Select in the directory**” lets you start a guidance towards a location that is stored on a file, with the Navigation CD-ROM present.

SELECTING FROM YOUR MOST RECENT DESTINATIONS

The function “**Select from your most recent destinations**” lets you start guidance towards one of the last twenty destinations that have been automatically stored by your installation.



STAGES AND ROUTES

This menu allows you :

- **To add a stage to your route** after guidance has started.
- **To sort or delete stages.**
- **To change your route.** You have to indicate the number of kilometres you wish to leave out in order to permit calculation of a new route.
- **To select the destination chosen initially in order to modify it.**

Remark : If a stage is programmed, the navigation system will still try to go that way unless it has already been passed or deleted.



GUIDANCE OPTIONS

This menu allows you :

- **To define the calculation criteria for your itinerary** so that it will be the quickest or the shortest, taking account of traffic information etc.. The last criteria selected are displayed.
- **To adjust the volume of the voice synthesiser for guidance purposes.**
- **To activate/deactivate naming of the street in the voice instructions.**
- **To display the information from the Navigation CD-ROM.**
- **To delete the last destinations.**



TMC TRAFFIC INFORMATION

This menu allows you :

- **To consult the Traffic Information messages.**
- **To filter the traffic information.**
- **To adjust the volume of the voice synthesiser for the reading of the information.**
- **To activate/deactivate the showing of messages.** The symbols remain displayed on the map.

As opposed to the road information flashes broadcast by an FM station during its normal programming (see the TA function in RDS), the TMC (Traffic Message Channel) messages are coded and not audible. TMC filters the information that is of interest to you and broadcasts it in the language selected in your NaviDrive, even in a foreign country where the language of the local radio is not your own.

The availability of such information depends on the country and on the region where you are travelling.

This information is displayed in a superimposed window and by symbols on the map (colour display). It be read out by the voice synthesiser.

Remark :

The volume of the voice synthesiser can be adjusted in the menu "TMC Traffic Information" and by moving control **C** while the TMC traffic information is being heard.

The messages contain for example : A date and time of transmission, the nature of the traffic incident, its location, plus the name and direction of the traffic artery concerned.

The messages are classed according to the distance of the incident from your vehicle. This list is updated approximately every 15 minutes.

- To receive and view this traffic information, it is necessary to insert the navigation CD-ROM , to activate TMC traffic information, to select a type of incident and a type of geographical filtering.
- Selection of an FM radio station broadcasting RDS-TMC traffic information is automatic. If you want to select a different station, you must use the menu "**Filtering of TMC** information" then "**Choice of TMC** station".

Remarks :

- The multifunction screen displays the "TMC" symbol as soon as a station broadcasting TMC information is being received.
- When the FM station selected cannot broadcast the TMC information, the "TMC" symbol will be barred on a monochrome screen and shaded on a colour screen.
- Depending on the station selected, the traffic information may be more or less complete and precise, or cover a larger or smaller area. Each radio station is individually responsible for the quality of the information that it broadcasts.

LIST OF TMC SYMBOLS ON THE COLOUR DISPLAY



Traffic bottlenecks and queues



Road closures and restrictions



Vehicle size restrictions



Road conditions and dangers



Weather and visibility



Parking restrictions



Restrictions on public transport



Demonstrations

These symbols may be accompanied by an arrow indicating in which traffic direction they are situated.

CONSULTING OF MESSAGES

This menu gives you access to the **list of messages**.

Note :

- Certain of these messages may offer you a diversion from your route, depending on the TMC information received (it is necessary for you to have selected the “**traffic info**” guidance option). If you accept one of these messages, then the NaviDrive offers you a diversion and recalculates your itinerary. You can then choose whether or not to accept the offer.
- A message is sent to you when the decision is imminent. You are informed again as you approach the junction.

Tip :

It is possible to consult a message by selecting a symbol present on the map. For this, in the “**Map**” menu select “Move the map” then the symbol.

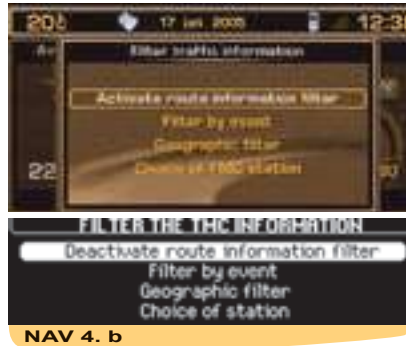

FILTERING TMC INFORMATION

This menu gives you access to :

- **Activation/deactivation of the itinerary filter.** In navigation, it lets you select only those incidents that are located on the guidance itinerary and in the relevant traffic direction.
- **Filtering by incident.** This allows you to select only certain types of incident (all selected by default).
- **Geographical filter.** This lets you select only the incidents that have occurred around the vehicle and/or around a given location.

Remark :

The different filters can be cumulative.

- **Choice of TMC station.** This allows you to select another station that broadcasts RDS-TMC information.

FILTERING BY INCIDENT

This choice lets you select the nature of the incidents of which you wish to be informed :

- Those to do with roads, such as traffic conditions, roads closed or vehicle size restrictions, and/or.
- Those concerning the town where you are, such as parking, public transport or demonstrations.

Whether you are able to access this information depends on its availability.

Remark :

If you do not select an incident, you will not receive any TMC traffic information.

GEOGRAPHICAL FILTER

This choice lets you select an area for incidents (radius of 3 to 20000 km) of which you wish to be informed :

- Those happening around your vehicle and/or.
- Those at a location to be selected.

The two filters can be cumulative. The radius value is then common to both.

SELECTION OF SOURCE

Press on button **B** or **5** to select the audio source : Radio, CD, CD changer or MP3.

VOLUME ADJUSTMENT

Rotate the control **C** to increase or decrease the sound volume.

You can also increase or decrease the volume using controls **4** and **6** at the steering wheel.

Note :

- The sound volume when you switch off NaviDrive will be the same when you switch it on again.
- The sound volume is automatically corrected according to vehicle speed if the "speed-sensitive volume" function is active.
- The sound volume adjustment operates independently for each audio source. Thus volume can be varied according to the sound source.

TEMPORARY SOUND PAUSE

Press simultaneously on buttons **4** and **6** at the steering wheel to activate this function.

The sound will be paused, regardless of the source selected. The permanent audio sources (radio, CD, CD changer, MP3) remain cut off, but not the others (guidance instructions for example).

To restore sound, press any of the buttons on the control panel.

SOUND ADJUSTMENTS

Each press on button **U** brings up the parameter to be adjusted : choice of predefined sound ambiances, bass, treble, loudness, fade (front/rear sound distribution), balance (left/right sound distribution) and volume adjusted to vehicle speed.

Control **G** allows you to modify the value of the parameter displayed.

Note :

- The value chosen is automatically accepted, without any need for validation.
- The selection of a particular sound ambience automatically adjusts the bass and treble.
- Adjustment of bass and treble is available only if you have selected the sound ambience "None".
- Adjustments of bass, treble and loudness, when available, are specific to each sound source.



PRINCIPAL AUDIO MENU

Press on **P** then use the control **G** to select the Audio icon in order to access the following choices. :

- **Activate/deactivate the RDS** search function in **FM**.
- **Activate/deactivate the regional search mode** in **FM**.
- **Activate/deactivate the display of Radio Text**, broadcast by the radio station if available ("RT" displays at the bottom of the screen).
- **Activate/deactivate the display of CD MP3 detail**.

You change from one source to another by pressing button **B** or control **5** at the steering wheel.



CONTEXTUAL MENU FOR RADIO SOURCE

A press on **G** while listening to the radio permits you to :

- **Enter the desired frequency.**
- **Activate/deactivate the RDS** search function in **FM**.
- **Activate/deactivate the regional search mode** in **FM**.
- **Activate/deactivate the display of Radio Text**, broadcast by the radio station if available ("**RT**" displays at the bottom of the screen).

NOTES ON RADIO RECEPTION

Your Navidrive system will be subject to phenomena not encountered by your equipment you have at home. The reception of AM and FM signals may suffer from interference, which is caused by the nature and propagation of the signals and does not reflect on the quality of your radio installation.

In AM, the reception may be affected when passing under power lines or bridges, or when travelling through tunnels.

In FM mode, the reception may be affected by the distance from the station transmitter, the reflecting of signals off obstacles (mountains, hills, tower blocks) and radio blackspots (no coverage from the station transmitter).

SELECTION OF FREQUENCIES AND MEMORY BANKS

By repeated presses on button **R**, the NaviDrive changes successively between the memory banks FM1, FM2 and FMast, corresponding to FM frequencies, and to the memory bank MW/LW, corresponding to AM frequencies.

MANUAL SEARCH

A short press on one of the buttons **H** or **I**, will respectively increase or decrease the displayed frequency.

By keeping button **H** or **I** pressed, you will be able to scroll through the waveband. Scrolling stops as soon as a station is found. NaviDrive remains tuned to the frequency displayed.

MANUAL PRE-SETTING

Select the waveband and memory bank required using button **R**.

Select a station using either automatic or manual search.

Keep pressing for more than two seconds on one of the pre-selection buttons **1** to **6** on the keypad **W**.

A window opens on the screen, the station is memorised as it is displayed on the memory number you have given it.



SEARCHING FOR A STATION IN A SORTED LIST

To search for a station in a sorted list, your installation periodically updates the list of the stations received around your vehicle. It shows you what stations are available, first in alphabetical order, then by frequency in ascending order if the names are not known.

To access this list, give a short press on button **T**.

This list is updated automatically every 10 minutes.

You can update this list at any time, by giving a long press on button **T** when the list is displayed on the multifunction screen.

AUTOMATIC SEARCH

A short press on one of the buttons **M** or **N** will tune into higher or lower radio stations respectively, within the chosen waveband. By keeping one of the buttons **M** or **N** pressed, you can scroll continuously through the waveband. The scrolling will stop at the first station it finds once the button is released.

You can also do this by means of controls **2** and **3** at the steering wheel.

If NaviDrive did not manage to capture a station on a frequency known to you (reception very weak), you can perform a manual search for this station.

TUNING SENSITIVITY

Automatic searches can be carried out according to two levels of sensitivity :

- To capture the most powerful transmitters, choose the local search mode "**LO**" (default option).
- To capture the weakest or most distant transmitters, choose the sensitive search mode "**DX**".

Search for a station is done first in "**LO**" (local) sensitivity, then in "**DX**" (distant) sensitivity.

To commence a search in sensitivity "**DX**" (distant) immediately, press twice in succession on one of the buttons **M** or **N**.

AUTOMATIC MEMORISATION OF TRANSMITTERS (AUTOSTORE FUNCTION)

In FM, if you keep pressing for more than two seconds on button **R**, your Navi-Drive will automatically memorise the 6 strongest transmitters on the FMast memory bank.

NaviDrive memorises the 6 strongest transmitters by deleting the 6 previously memorised.

After the memorisation, NaviDrive goes immediately to memory 1 of the FMast memory bank.

Note :

- If the traffic information function has been activated (see RDS SYSTEM), the stations offering this facility will be memorised as priority.
- If it is unable to memorise any new stations, the system will retain the previously memorised stations.

If the system is unable to find 6 stations, the unfilled memory slots will remain unchanged.

RECALL OF PRE-SET STATIONS

A short press on one of the pre-selection buttons **1** to **6** on the keypad **W** recalls the corresponding memorised station.

If it is a RDS station, the frequency appears some seconds before the name appears.

For RDS stations, recall of a station may prompt a search of the frequency corresponding to the region where you are located.

This operation can also be performed using the control **1** at the steering wheel.

USING THE RDS (RADIO DATA SYSTEM) FUNCTION ON FM

The majority of FM stations use the RDS system.

This system enables such stations to transmit non-audible data in addition to the broadcasting of their programmes.

The data provides access to various functions described in this chapter, such as: intermittent traffic information flashes, display of the station name and automatic station scanning.

RDS enables you to continue listening to your chosen radio station, regardless of the different frequencies it uses in the regions through which you are travelling.

SCANNING OF RDS STATIONS

NaviDrive keeps the best possible reception.

It continuously looks for any other frequencies on which the selected radio station is broadcast, automatically choosing the frequency offering the best reception (if the station broadcasts on more than one transmitter or frequency).

Activation or deactivation of the function can be accessed via the "**AUDIO**" main menu or via the "**RADIO**" contextual menu.

The display will indicate :

- **RDS**, if the function is active and available for the station chosen.
- **RDS** barred on the monochrome display or **RDS** shaded on the colour display, when the function is activated but not available on the station.

If the station you have selected does not broadcast on different frequencies in the areas in which you are travelling, it is possible to deactivate the automatic RDS transmission scanning function.

REGIONAL SEARCH MODE

Some stations when they are organised in a network in the different regions that they serve, transmit programmes that are different at certain times and the same at other times.

It is possible to search :

- Either for a regional station only.
- Or across the whole network in order to find a different programme.

Activation or deactivation of the function can be accessed via the "**AUDIO**" main menu or via the "**RADIO**" contextual menu.

Note :

- If the function is active, NaviDrive will not change from one regional station to another.
- If the function is non-active, NaviDrive will choose the strongest frequency from among different stations.

TA TRAFFIC INFORMATION (TRAFFIC ANNOUNCEMENTS)

Some stations allow broadcasting of these messages thanks to the “**TA**” function.

You can activate this function by pressing button **S**. Your system allows you to receive traffic information flashes from an FM station which broadcasts them, even though you are listening to another radio programme not itself providing traffic information, or to another audio source.

The display will indicate “**TA**” provided the function is activated and the station is compatible with these messages ; “**TA**” will be barred on the monochrome display and shaded on the colour display, when the station is not compatible.

While traffic announcements are being broadcast, the original radio programme, or audio source being played, is paused. When the messages are finished, your NaviDrive will revert automatically to the musical programme originally being listened to.

Note :

- You have to be in FM wave band.
- During station search phases or automatic memorisation phases, if the “**TA**” function is active, the transmitters that are compatible with the broadcasting of these messages will be captured or memorised first.
- The station being listened to should indicate via the RDS system that it broadcasts traffic information.
- Stations organised in a network (EON) have regional transmitters sending their own programmes. While listening to one of these stations you can switch to any station on the network that is broadcasting traffic information messages.
- During the broadcast of a message you can stop listening to it by pressing button **S**, the “**TA**” function remains active.

SOUND VOLUME ADJUSTMENT FOR TRAFFIC INFORMATION

The sound volume for traffic information operates separately from that for the rest of the system, and can be adjusted independently.

Rotate control **C** while a traffic information message is being broadcast.

This volume adjustment is memorised.

RADIO TEXT VIA CONTEXTUAL MENU

If you are in radio source, a press on the control **G** lets you call up the Radio contextual menu to select “Radio Text Read” (for a brief display of information broadcast by the station about the programme being listened to) (for example : name of singer, title of song, etc.).

SELECTING A PROGRAMME TYPE

Certain stations allow you to choose to listen to a particular type of programme selected from the available list, for example as below :

News	Sciences
Current affairs	Various
Services	Pop music
Sport	Rock music
Education	Folk music
Fiction	Light music
Culture	Other music
Weather	Leisure
Economy	Jazz
Children	Country
Social affairs	National
Religion	Old favourites
Discussion	Traditional
Travel	Documentary

Press for more than two seconds on the **S** button.

Rotate control **G** to select the desired programme type.

SEARCHING FOR A STATION BROADCASTING THIS PROGRAMME TYPE

Once you have selected the programme type, validate to start a search.

NaviDrive will settle on the first transmitter broadcasting this type of programme. If none can be found, the system will return to the station it was originally tuned to and then quit the PTY function.

PRE-SETTING A STATION BROADCASTING THIS PROGRAMME TYPE

Search to select a station.

While it is broadcasting, keep one of the pre-selection buttons **1** to **6** on the keypad **W** pressed for more than two seconds.

To recall the pre-set programme type, press the corresponding button.

QUITTING PTY MODE

To quit this function, press on button **S** for more than two seconds, then NaviDrive will revert to normal mode.

SAFETY PRECAUTIONS

For safety, do not use a CD player if the cabin temperature is higher than +60 °C or lower than -10° C.

If the temperature becomes too high, an automatic safety device will prevent the CD player from working until an acceptable temperature is restored.

HANDLING COMPACT DISCS

Do not drop them. Store the CDs so that they are kept of dust. Avoid touching the disc surface as any scratches may adversely affect the sound quality. Do not attach any stickers to the discs. Do not write on them. Do not use damaged or deformed discs. Do not expose them to heat or direct sunlight.

Note :

Some cut CDs cannot be read by your equipment (quality, speed of recording, etc.).

If the surface of the compact disc is dirty, it can be wiped with a soft, clean cloth. Always wipe from the centre of the disc outwards.

SELECTING CD SOURCE

After inserting a CD, with the printed side facing upwards, the player will start playing the CD automatically.

If there is a CD already inserted, press on button **B** until you have the source you require. You can also do this by means of control **5** at the steering wheel.

Remarks :

- Before inserting a CD, always check that no CD is already there by pressing on **A**.
- If the navigation CD-ROM is inserted, it is not possible to listen to a CD **in CD source**.

EJECTING A CD

Press button **A** to eject the CD, the NaviDrive changes automatically to radio source.

If the CD is not removed within 10 to 15 seconds of being ejected, it will automatically be taken back into the CD player, although it will not be played.

SELECTING A TRACK

Press button **M** once to play the next track.

Press button **N** once to return to the beginning of the track currently being played, press a second time to go back to the start of the previous track.

Press the buttons successively to skip several tracks at a time.

This can also be done using control **T**. If the list of tracks is displayed on the screen, select the desired track using buttons **H** or **I** or control **G**, validating with the latter.

You can also do this by means of the controls **2** and **3** at the steering wheel.

FAST FORWARD AND RAPID REVERSE WITH ACCELERATED SOUND

To move swiftly through the CD, press and keep pressed button **M** or **N**, respectively for fast forward or rapid reverse with accelerated sound.

Play resumes as normal when the button is released.



CONTEXTUAL MENU FOR CD SOURCE

If you are in CD source, a press on control **G** allows you to call up the contextual menu, for activating or deactivating the following functions :

- **Playback of the start of each track of the CD.**
- **Random playback.**
- **Programming of a sequence for playback of tracks.**

PLAYBACK OF CD MP3

After inserting a CD MP3, the playback of the first song of the first CD-cover commences. You can select the track you wish to listen to via **M** or **N** or the CD-cover via **H** or **I**.

If a CD MP3 is already inserted, press on button **B** until you reach the source required.

Remark :

If the navigation CD is present, it is not possible to listen to a CD MP3.

TO SELECT A TRACK

To display the list of CD-covers, press on button **T**.

Use buttons **H** or **I** to select the CD-cover you wish to listen to.

To open a CD-cover, press **G**.

Use buttons **M** or **N** to select the track you wish to listen to.

Validate with a press on **G**.



CONTEXTUAL MENU FOR MP3

When you are in MP3 source, a press on the control **G** allows you to activate or deactivate the following functions :

- **Playback of the start of each track of the CD.**
- **Random playback of all the tracks of the CD.**
- **Repetition of the tracks of the current CD-cover.**

Your audio equipment enables you to listen to music which is usually rights-protected according to national and international conventions. Please consult these and respect them.

Your CD player is MP3-compatible in accordance with iso 9660 and formats MP3, MPEG - , MPEG 2 and MPEG 2.5 layer 3. It can handle transmission speeds of 32 to 320 kbits/s and playback of 8 to 48 kHz.

CD CHANGER SOURCE

This equipment, if present, comprises a CD changer **Z** located in the central console, able to accommodate 5 discs.

INSERTING CDs INTO THE MAGAZINE

Insert the CDs with the printed side upwards.

Note :

- Each compartment takes one disc only.
- The CD changer will not operate if discs are inserted the wrong way up.

REMOVING DISCS

To remove a CD, give a long press on the corresponding button.

For handling of CDs and user precautions, proceed as for CD Source (page 30).

SELECTING CD CHANGER SOURCE

Press successively on button **B**, until the desired source is obtained.

You can also do this by means of control **5** at the steering wheel.

SELECTING A CD

Press on one of the pre-selection buttons **1** to **5** on the keypad **W** to choose the CD that you wish to listen to.

Press button **H** to play the previous CD, or button **I** to play the next CD.

The CD will start to play automatically. This operation can also be performed using the control **1** at the steering wheel.

After each change of source, on return to CD changer source, playback will resume at the same point where it had been interrupted.

FAST FORWARD AND RAPID REVERSE WITH ACCELERATED SOUND

To move swiftly through the CD, press and keep pressed button **M** or **N**, respectively for fast forward or rapid reverse with accelerated sound. Play resumes as normal when the button is released.

SELECTING A TRACK

Press button **M** once to play the next track.

Press button **N** once to return to the beginning of the track currently being played, press a second time to go back to the start of the previous track.

Press the buttons successively to skip several tracks at a time.

This can also be done using control **T**. If the list of tracks is displayed on the screen, select the desired track using buttons **M** or **N** or control **G**, validating with the latter.

You can also do this by means of the controls **2** and **3** at the steering wheel.

CONTEXTUAL MENU

If you are in CD source, a press on control **G** allows you to call up the contextual menu, for activating or deactivating the following functions :

- **Random playback.**
- **Playback of the start of each track of the CD.**
- **Repetition of the current CD.**
- **Display of the list of tracks on the CD.**

Remark : The CD changer (if there is one) is not MP3 compatible.



TRIP COMPUTER MAIN MENU

press on **P**, then on the control **G** select the Trip Computer icon and validate to have access to the following choices :

- **Trip computer configuration.**
- **Diagnosis.**
- **Status of functions.**

CONTEXTUAL MENU

When you see one of the types of trip computer information displayed on the multifunction screen, press on the control **G** so as to be able to access the functions :

- **Log of alerts.**
- **Distance to destination.**
- **Status of functions.**



TRIP COMPUTER CONFIGURATION

This menu allows you to :

- **Enter a distance to destination**, if no guidance is active (otherwise this information is given by the navigation system).
- **Modify the units**, °C or °F, km and litres or miles and gallons.



DIAGNOSIS

This menu allows you to :

- **Display the log of alerts.** This gives you a list of the most recent alerts which have been signalled to you by a message on the multifunction screen, whether or not accompanied by the lighting of one of the alert warning lamps.
- **Display the level of charge of the system back-up battery.** The latter enables you to make an emergency call should there be a disconnection of the vehicle's main battery.
- **Display the status of the GPS coverage.** This enables you to see how many satellites are available, as well as the status of the location of your vehicle.

Remark :

The back-up battery has a life of 4 years. It must be disposed of by a specialist operator, never thrown into the public refuse. National regulations should be consulted and complied with.

DIRECTORY



The directory can contain up to 396 files spread over 4 independent sub-directories (“User 1”, “User 2”, “User 3” and “User 4”).

On delivery of the system, the current directory is by default the directory “User 4”.

One file can contain :

- An address.
- Five telephone nos..
- Five e-mails.
- A note.
- A voice label for use in voice commands.

The address is entered by inputting the town and the street.

Note :

If you enter the address in the absence of the navigation CD-ROM, you will not be able to use this address for navigation.



MAIN DIRECTORY MENU

Press on **P** then, using control **G**, select the **DIRECTORY** icon and validate to have access to the following choices :

- **Directory file management**, to consult, modify, add a file, or to delete one file or all files.
- **Directory configuration** to select a directory, define the start directory (current directory) and to name the directories.
- **File transfer**, this allows you to :
 - To move, by infrared, files in Navidrive Vcard format to and from nomad equipment.
 - To exchange information with a SIM card inserted in the Navidrive.



MANAGING DIRECTORY FILES

This menu allows you to :

- **Consult or modify a file**, to select the file you wish to consult or edit.
- **Add a file**, to enter the name for the new file, select on the file the short version you wish to use, then validate and enter the information.
- **Delete a file**, to select the file you wish to delete.
- **Delete all the files in a directory**.

Tip :

To be able to use the content of a file in navigation, create this file by entering the address, or the stored information, via the Navigation function.

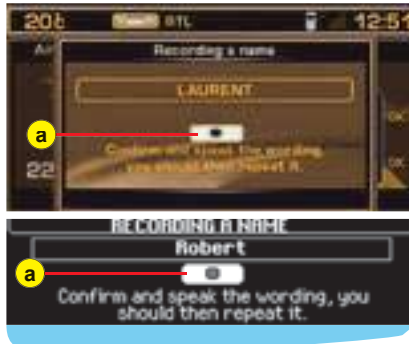

When they are created, the files are stored in the current directory, notably for use in voice commands.

VOICE LABEL

You can record a voice label linked to a file by selecting and validating the icon **a**, then pronouncing the voice label twice.

Next, the voice label can be used in voice commands for the telephone (say “**call**” then the voice label) or for navigation (say “**guide to**” then the voice label), provided that the address entered in the file has been entered in conjunction with the navigation CD-ROM and is in the current directory.



REP 3. a

TRANSFER FILES

This menu allows you :

- **Exchange by infrared** between the NaviDrive and nomad equipment by means of an infrared port, of all or some of the files in the current directory.
- **Exchange between the SIM card** (inserted in the NaviDrive) and the NaviDrive, of all or only one of the files it contains.

EXCHANGE OF A FILE BY INFRARED

After selection of the menu “**File transfer**” and of the direction of this transfer, you must initiate the exchange by showing simultaneously in front of the infrared port the nomad equipment on which you have started the transfer (refer to the instructions for this equipment). A message confirms to you that the exchange can go through correctly.

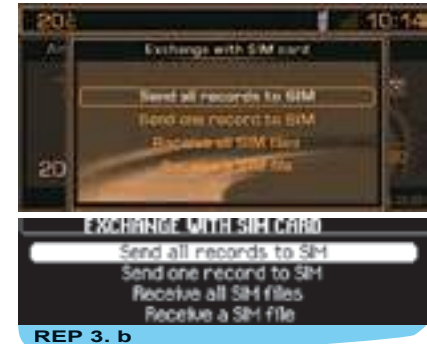

REP 3. b

EXCHANGE WITH THE SIM CARD

This menu allows you :

- **To send all the files** to the SIM card, from the current directory of your NaviDrive.
- **To send a file** to the SIM card, from the current directory of your NaviDrive.
- **To receive all the files** from the SIM card into the current directory of your NaviDrive.
- **To receive one file** from the SIM card into the current directory of your NaviDrive.

Reminder :

When you transfer a file from the NaviDrive to the SIM card, only the first number on the file is recorded.

Remark :

The SIM card represents an independent source of information: the telephone nos. can be consulted in the current directory.

WHAT IS THE TELEPHONE FUNCTION

The telephone function consists of a GSM telephone incorporated in NaviDrive.

The GSM telephone has a “hands free” function, provided by a microphone located in the front interior lamp, and controls at the steering wheel giving you access to most of the functions.

Remark :

As with any mobile telephone, your vehicle telephone operates on the existing cellular and terrestrial networks, and so a connection cannot be guaranteed on every occasion.

Priority on safety :

Do not allow yourself to be distracted while you are driving. Observe the national legislation currently in force. We recommend the driver to stop the vehicle to continue a telephone conversation or to perform certain actions (selecting a number manually, for example).

INSERTING AND REMOVING THE SIM CARD

Open the slot **L** by pressing with the point of a pencil, or similar, on the opening just above it **L'**. Next, insert your SIM card into the aperture (as indicated on the card) then reclose the flap.

Remarks :

- You should only remove the SIM card after NaviDrive has stopped (key in position **S** (Steering lock) and the display switched off.

- If you have a twin card it is necessary, on first installation or when updating your directory, to insert the SIM card from your mobile telephone, then to transfer the information on it into the NaviDrive directory. See the Main Menu for the Directory.

ENTER THE PIN CODE

NaviDrive can definitively memorise the **PIN** code of a SIM card. This memorisation having been accepted, your **PIN** code will be required only once, at the first entry.

Enter your **PIN** code using the buttons on the keypad **W**, then validate by pressing the control **G** or alternatively button **#** on the keypad **W**.

Remark :

After three errors in trying to enter the code, your telephone will be blocked. You will then have to enter your deblocking code (PUK code).

The PUK code is supplied with your SIM card by your service provider. The PUK code tolerates 10 successive errors. After this the SIM card will be un-usable.

Remark :

All the essential types of information associated with a “mobile telephone” can be viewed on the multifunction screen..



MULTIFUNCTION SCREEN DISPLAY

When you are not engaged on a telephone call, the display tells you if you have voice messages or text messages (SMS) incoming, the length of connection since the last reset to zero and the status of your telephone.

During a telephone call, it tells you the time that has elapsed since the start of the call, as well as the number (if this option and service is available) or the name (if recorded in the directory) of the person you are speaking with, and the status of your telephone.

USING THE KEYPAD

Each press on one of the buttons of the keypad **W** lets you :

- Select a name commencing with the letter chosen, either in the directory or in the SIM card.
- Scroll down the characters, until you reach the one you need.

- [1] 1 or space with a short press in text entry (SMS)
- [2] 2 or A B C 2 or a b c 2
- [3] 3 or D E F 3 or d e f 3
- [4] 4 or G H I 4 or g h i 4
- [5] 5 or J K L or j k l 5
- [6] 6 or M N O 6 or m n o 6
- [7] 7 or P Q R S 7 or p q r s 7
- [8] 8 or T U V 8 or t u v 8
- [9] 9 or W X Y Z 9 or w x y z 9
- [0] In text entry (SMS)
 Short press : Space then 0
 Long press : Space
- In dialling
 Short press : 0
 Long press : +
- [#] In dialling
 Short press : #
- [*] In text entry (SMS)
 Short press : Deletion of the last character
 Long press : Progressive deletion of the complete line
- In dialling
 Short press : *
 Long press : Deletion of the last character



MAIN MENU FOR TELEPHONE AND TELEMATIC SERVICES

Press on **P** then use the control **G** to select the TELEPHONE AND TELEMATIC SERVICES icon and validate to have access to the following choices :

- **Call.**
- **Services**, for access to NaviDrive and CITROËN services.
- **Telephone functions**, to adjust all your telephone functions.
- **Text messages (SMS)**, to enable you to manage all the text messaging functions (SMS).



CONTEXTUAL MENU

Making a call

Press on button **D** to display the telephone contextual menu.

This menu allows you to :

- **Access the calls list.**
- **Enter a number.**
- **Access the directory.**
- **Access your voicemail** (messaging from your GSM operator).

Remark :

A long press on control **5** at the steering wheel brings up a contextual menu with the calls list, the current directory and the voicemail.



CALL A NUMBER

To call a number, carry out one of the following actions :

- Select **“Call”** in the menu Telephone and telematic services, then compose the number using the keyboard **W**.
- Press on button **D** to start the dialing, or select the function **“OK”**.
- Say **“Call”** then the voice label from a file that includes a telephone number.
- Use the current directory.

A long press on control **5** at the steering wheel brings up a contextual menu with the calls list, the current directory and the voicemail.

- With Telephone and Telematic Services displayed, press on button **G** to have access to the calls list.



MAKING A CALL TO A STORED NUMBER

Select the function giving you access to your directory or to the calls list (the 20 most recent incoming or outgoing calls). These only figure in the calls list if the person calling does not withhold the number.

After selecting the number you wish to call, press on either button **D** or control **G** to connect the call.

Reminder :

In the directory there are two groups of memorised numbers accessible, one from the current directory of NaviDrive and one from the SIM card. The numbers contained in the latter are preceded by a **“SIM card”** symbol.



RECEIVING A CALL

When receiving a call, announced by a ringing tone, you can choose :

- To accept it by pressing button **D** or control **5** at the steering wheel or by validating the **“YES”** function in the **“Respond”** menu.
- To refuse the call by pressing button **Q** or by selecting and validating the **“NO”** function in the **“Respond”** menu.

If you have accepted the call, when you finish the call press button **Q** or control **5** at the steering wheel, to end the call.



THE SERVICES

This menu, depending on the contracts subscribed to, allows you to choose one of the following services :

- **CITROËN on line**, giving you direct contact with the CITROËN Customer Contact Centre and access to the services on offer (such a call will be overridden if an emergency or breakdown call is made).
- **CITROËN Assistance**, giving you direct contact with the Call Centre handling the CITROËN breakdown service, for the fastest possible recovery.

You have a few seconds to cancel this call once it has been made. This call can also be made by giving a long press on button **E**. While making an assistance call, it is impossible to make other calls apart from an emergency call. If you have subscribed to a specific Services contract, your GPS position is relayed to the assistance centre.

- **NaviDrive Services**, for access to the list of telematic services from CITROËN (e.g. Customer Service, choice of a destination, fuel consumption monitoring, sport, current affairs, finance, weather, horoscope, travel, games, etc.) depending on availability.
- **Messages received**, messages relating to the benefits of your specific Service Contract.

EMERGENCY CALL

In the absence of a subscription to the CITROËN Emergency service, the **V** button is configured for making calls to the number **112**, this being a standard number reserved by the European GSM network for emergency calls.

For this call, a valid SIM card must be present, permitting the sending and receiving of telephone calls and SMS messages. **You also need to be in an area that has GSM coverage.**

TWIN SIM CARD

For better peace of mind, offers of twin SIM cards (available in some countries from certain service operators) give you two SIM cards for a standard price, a single number and single messaging. Calls arrive as priority on your principal line. In the absence of a reply, calls are transferred automatically to the equipment that is using the second SIM card.

Note :

- This transfer necessitates a callback (consult your telephone service operator).
- For optimum operation of services, it is recommended to insert the principal SIM card into the NaviDrive.

If you have a special Service Contract, refer to the general conditions described in the contract.

A green diode flashes on the NaviDrive control panel as soon as you commence the emergency call procedure, then it comes on permanently when the call is picked up by the rescue services.

The same warning lamp flashes or illuminates permanently in orange should it detect a malfunction in the telephone's emergency calls function.

Remarks :

- If you have a specific Service contract, the services can then be localised by means of GPS. You can check the activation of this localisation with a long press on **P** followed by selection of "**Configuration of services**". If the emergency services appear activated, you can then be localised. Otherwise, you are not localised.
- If the emergency services appear activated but you have not subscribed to a Service contract and do not wish to be localised, make contact with your usual CITROËN dealer.

40 TELEPHONE AND TELEMATIC SERVICES



TELEPHONE FUNCTIONS

This menu gives you access to the following functions :

- **Network**, to select the network search mode and to view the networks available.
- **Length of calls**, to consult the call length counters and the reset to zero.
- **Managing the SIM** card, for modifying the PIN code and deleting the list of calls and text messages (SMS).
- **Call options**, for configuring calls by whether or not you withhold your number, for hanging up automatically after X rings, for defining ring tones and callback for SMS and for deleting the calls log.



TEXT MESSAGING (SMS)

This menu allows you to read, send, and edit SMS messages and to delete the list of them.

Normally, your server centre number is configured automatically depending on your network operator.

To modify it, select the menu "**Telephone and Telematic Services**", then "**Text messages (SMS)**" and "**Number of server centre**" for entering and recording the latter.

Any text message composed prior to the recording of this number, will be deleted and not sent.



SENDING A TEXT MESSAGE (SMS)

In the menu "**Text messages (SMS)**", validate the function "**Production of an SMS**", and enter your SMS via the keypad.

You can then :

- Either record the message for later use by validating in the "**OK**" function.
- Or send it by validating in the "**Send**" function.

Then compose the destination number or select it either in the directory or in the calls list. Then send it.



RECEIVING AN SMS

A sound signal (if the ringing option for SMS messages is active) and a superimposed window tell you of the arrival of an SMS.

You can then :

- Either read the SMS by selecting and validating **"YES"**.
- Or defer reading it by selecting and validating **"NO"** or by pressing button **J** or by waiting for the superimposed window to disappear.

Note :

- SMS messages that have been stored or deferred can be consulted at any time. To access them, press on button **P**, select **"Telephone and Telematic Services"** then the function **"SMS text-messages"** and validate the function **"Reading of SMS messages received"**. Then move in the list to be able to select and validate the message you wish to read. The number of SMS messages unread is indicated.
- If the voice synthesiser function is active, as soon as the message is displayed, it will be read out by the voice synthesiser.

REPLYING TO AN SMS

After reading a text message, you can :

- Reply directly to the sender by selecting **"Respond"**. A screen appears automatically to return your message.
- Record the number of the SMS sender into your current directory, by selecting **"Record"**.



CONFIGURATION MAIN MENU

Press on **P** then on the control **G**. Select the Configuration icon and validate to gain access to the following choices :

- **Define the vehicle parameters.**
- **Display configuration.**



DEFINE THE VEHICLE PARAMETERS

This menu which depends on the level of equipment on your vehicle enables you to activate/deactivate or to adjust the following functions :

- **Screen wipe**, to activate/deactivate (with a press on **G**) the automatic triggering of rear screen wipe when engaging reverse gear.
- **Lighting configuration**, to activate/deactivate (with a press on **G**) the automatic lighting of headlamps and/or the guide-me-home lighting.



DISPLAY CONFIGURATION

This menu enables you to access the following functions (insert the navigation CD-ROM if necessary) :

- **Choice of colours** (colour screen), for choosing one of the colours available for the display.
- **Adjust brightness**, to adjust brightness and contrast and video display.
- **Sound**, for adjusting the voice synthesiser (for the female/male voice parameter), activation/deactivation of voice commands.
- **International parameters**, for adjusting the **date** and the **time** (12 or 24 hour format, adjustment of minutes on GPS) and the units of measurement (metric or imperial).
- **Choose language**, to choose the language for the voice synthesiser and displays.

GENERAL

When the map is displayed, you can use either of two functioning modes :

The mode “**Follow vehicle on map**”, which shows you the movement of the vehicle on the map, and the mode “**Select - Move on map**”, which allows you to define a particular spot by moving a pointer.

The map can be displayed either on the right of the screen as in the other applications, or full screen enlarged.

Remarks :

- By default, the map displays in mode “**Follow vehicle on map**”.
- The change of the mode “**Follow vehicle on map**” to the mode “**Move on map**” is made via the Map main menu or using the Navigation contextual menu with a press on the control **G**.
- The change the other way is made using the Contextual Menu for the mode “**Move on map**”.



MODE “FOLLOW VEHICLE ON MAP”

This mode enables you to view the vehicle centred on the map, whether or not guidance is active.

The map has a zoom function which can alter the scale of the map. To vary the scale from 50 m/cm to 200 km/cm, rotate the control **G**.

Remarks :

- In this mode, a validation on control **G** brings up the Navigation contextual menu.
- The more precise scale allows you to see one-way systems.



MODE “SELECTION – MOVE ON MAP”

This mode enables you :

- To move on the map in all four directions : North, South, East and West, using buttons **H**, **I**, **M** and **N**. The movement can be speeded up by keeping the appropriate button pressed down.
- To select a point on the map by moving the latter in order, after a press on **G**, to be guided towards this point, to have information on it, or to memorise it.

Remarks :

- In this mode, the zoom is also available and the map is always full screen, oriented to North.
- In this mode, a validation on the control **G** displays the Map contextual menu.
- In this mode, the symbol for the nearest Centre of Interest is displayed.

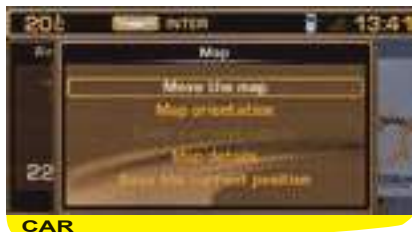

MAP MAIN MENU

Press on **P** then use control **G** to select the Map icon and validate to have access to the following choices :

- **Move the map**, to change to the mode "Select - Move on map".
- **Orient the map**, to orient the map either to North or to the direction in which the vehicle is moving.
- **Centre around the vehicle**, to recentre the map on the vehicle if it no longer appears on the map.
- **Details of the map**, for selecting the points of interest to be displayed using symbols on the map (see next page).
- **Memorise the current position**, to display the panel for entering a label for recording the vehicle's current position in a file in the current directory.

Tip :

Among the details of the map, you can select (depending on the country where the vehicle was marketed and on the availability of the service) the display of radar zones or high-accident zones.



CONTEXTUAL MENU

This contextual menu displays in mode "Select - Move on map" :

- **Information on this location**, to view the information on the point of the map selected by the cursor.
- **Choose as destination/stage**, lets you select the location which is pinpointed as a destination or stage provided a guidance is already in progress.
- **Memorise this location**, to memorise the point selected by the cursor in a file in the current directory.
- **Exit map mode**, changes the map back to the mode "Follow vehicle on map".

PUBLIC AUTHORITIES AND SECURITY



City hall, City centre



Universities, Colleges, Schools



Hospital

HOTELS, RESTAURANTS, BUSINESS AND RETAIL PARKS



Hotels



Restaurants



Vineyards



Supermarkets, Shopping malls



Business centre

CULTURE, TOURISM, ENTERTAINMENT



Culture, museums and theatres



Tourism, historic monuments



Casinos and night life



Cinemas



Shows, exhibitions

SPORTS AND OPEN AIR CENTRES



Sports centres and complexes



Golf courses



Skating, Bowling



Winter sports



Parks, gardens



Public attractions

TRANSPORT AND MOTORING



Airports, flying clubs



Rail stations, bus stations



Car hire



Car parks, rest areas



Ferry terminals, port areas



Service stations, garages



Radar zones/High-accident zones (depending on the country of marketing and availability of the service)



CITROËN Dealer or Repairer