

Thanks for choosing GAC Motor manufactured by GAC Motor Co., Ltd. (hereinafter referred to as “GAC Motor”). For better enjoyment of driving pleasure of this car, please read the *Owner's Manual* carefully. Through this manual, you can fully understand the operation methods and precautions of the car. Proper operation of the car can improve driving safety and prolong the service life of the car.

The *Warranty Manual* supplied with the car clarifies the warranty service provided by GAC Motor and the regular maintenance of the car. Please read this manual carefully to know your rights and responsibilities.

After reading this manual, please store it with the car for future reference.

If you are not sure about any points in this manual, please contact the GAC Motor authorized shop for detailed explanation.

In case of any suggestions or comments, please call the customer service hotline of GAC Motor: +86-400-158-9999 or contact GAC service Email: gacservice@gacmotor.com.

We are grateful for your support and love for GAC Motor. Have a nice drive!

GAC Motor Co., Ltd.



Safety Instructions

The safety of you and the passenger is crucial, so driving the car safely is an important responsibility of the driver.

In order to make clear the safety precautions, we indicate the operation steps and precautions through the various signs on the car and this manual, reminding you to pay attention to the potential dangers that will hurt you or the passengers.

It is impossible to list all the precautions for danger related to operation and maintenance of the car in the manual, so it is up to you to make the correct judgment in time.

Safety instructions are available in many forms, including:

- Safety signs pasted on the car.
- Safety notes: the texts marked with the symbol ,  or  and one of the three words "WARNING", "CAUTION", or "NOTE" in front.

 **WARNING** Very important instructions of which the nonobservance can cause casualties.

 **NOTE** Important instructions of which the nonobservance can cause damage to the car.

 **NOTE** General instructions of which the nonobservance could not cause injuries.

- Some paragraphs of this manual do not apply to all car models. For the description of options, the title text is followed by the symbol "*".
- Unless otherwise specified, the directions of the car (front, rear, left and right) in this manual are based on the traveling direction of the car.

1. Important Safety Precautions.....	1	3.6 Safety label	33
2. Picture Index.....	3	4. Operation of Systems and Equipment.....	34
2.1 Exterior.....	3	4.1 Cab	34
2.2 Interior	6	4.1.1 Steering wheel.....	34
3. Instructions for Safe Operation.....	10	4.1.2 Instrument cluster.....	36
3.1 Safe driving.....	10	4.1.3 Indicator lamp	42
3.1.1 General instructions	10	4.2 Car locking and unlocking	46
3.1.2 2 Correct sitting posture of the driver and passengers	11	4.2.1 Remote key	46
3.2 Seat belt	12	4.2.2 Emergency mechanical key.....	50
3.2.1 Why must you fasten the seat belt	12	4.2.3 Door lock system	50
3.2.2 Seat belt.....	13	4.2.4 Door.....	56
3.3 Supplemental restraint system (SRS).....	17	4.2.5 Trunk lid	57
3.3.1 Cases where the airbags may deploy	22	4.2.6 Engine hood	59
3.3.2 Cases where the airbags might not deploy.....	23	4.2.7 Power window	60
3.4 Safe ride of children.....	24	4.2.8 Electric sunroof.....	62
3.4.1 General instructions	24	4.2.9 Basic operation of body anti-theft system.....	66
3.4.2 Child safety seat	25	4.3 Lamps and vision	67
3.4.3 Information about child safety seat.....	26	4.3.1 Exterior lamp	67
3.4.4 Correct installation of child safety seat	28	4.3.2 Interior amp	73
3.5 Exhaust gas hazard	32	4.3.3 Wiper combination switch	76
		4.3.4 Windshield.....	78
		4.3.5 Rear-view mirror	79

Contents

4.3.6	Sun visor	83
4.4	Seats and storage facilities.....	83
4.4.1	Head restraints	83
4.4.2	Front seats	85
4.4.3	Rear seats	88
4.4.4	Storage facilities.....	89
4.4.5	Power outlet.....	94
4.4.6	Trunk.....	96
4.4.7	Accessories and modification	97
4.5	A/C system.....	99
4.5.1	General instructions	99
4.5.2	A/C system	100
4.5.3	A/C air outlet	106
4.6	AV system.....	107
4.6.1	1 Control panel (applicable to cars with AV main unit).....	107
4.6.2	Control buttons on steering wheel.....	109
4.6.3	Basic operation	111
4.6.4	Radio.....	115
4.6.5	USB playback.....	117
4.6.6	Bluetooth function	119
4.6.7	System setting (applicable to cars with AV main unit).....	121
4.6.8	Car setting (applicable to cars with AV main unit)	123

5.	Driving Guide	125
5.1	Starting and driving.....	125
5.1.1	Engine start/stop button	126
5.1.2	Engine start	127
5.1.3	Engine shutdown.....	127
5.1.4	Gear description	128
5.2	Brake system	132
5.2.1	Service brake.....	132
5.2.2	Electric park brake (EPB).....	135
5.3	Electronic service brake system	140
5.3.1	Anti-lock braking system (ABS).....	140
5.3.2	Electronic Stability Program (ESP).....	151
5.3.3	Hill Hold Control (HHC)	142
5.3.4	Hydraulic Boost Failure Compensation (HBC).....	143
5.4	Driver assistance systems	144
5.4.1	Adaptive cruise control (ACC)*	144
5.4.2	Forward collision warning system *	154
5.4.3	Lane departure warning system *	157
5.4.4	Tire pressure monitoring system	163
5.5	Parking assist system.....	164
5.5.1	Parking sensor system	164
5.5.2	Reverse image system *	170
5.6	Electric power steering (EPS)	170

5.7 Driving skills.....	171	7. Technical Data	207
5.7.1 Driving safety inspection.....	171	7.1 VIN.....	207
5.7.2 Driving during running-in period.....	171	7.2 Vehicle dimension parameters	209
5.7.3 Driving essentials.....	173	7.3 Vehicle mass, engine and fluid parameters	210
5.7.4 Efficient use of car	175	7.4 Transmission and chassis parameters.....	213
5.7.5 Fire prevention.....	175		
6. In-service Maintenance	177	8. Accident Handling	217
6.1 Maintenance instructions.....	177	8.1 Driver's tools and spare tire.....	217
6.2 Interior maintenance.....	177	8.2 Use of warning triangle.....	218
6.3 Exterior maintenance	179	8.3 Use of reflective vest.....	218
6.4 Checking and adding fluids.....	183	8.4 Replacing leaky tires.....	219
6.4.1 Fuel	183	8.5 Microwave window	222
6.4.2 Engine oil	185	8.6 Fuse	223
6.4.3 Coolant	188	8.6.1 Fuses in instrument panel PDU	225
6.4.4 Windshield washer fluid and wiper blade.....	191	8.6.2 Fuses in engine compartment PDU.....	228
6.4.5 Brake fluid	192	8.6.3 Fuses in battery PDU.....	231
6.4.6 Battery	194	8.7 Emergency start	232
6.5 A/C filter	196	8.8 Towing	234
6.6 Replacing bulb	198	8.9 Getting out of a trap	236
6.7 Wheels.....	200		
6.8 Tire chain	205		

Contents

9. Environmental Protection Information	237
9.1 Environmental protection information code.....	237
9.2 Environmental protection information	238

◆ **Be sure to fasten the seat belt correctly**

In a collision accident, the seat belt is the best protection device. Airbags are only used as auxiliaries, rather than replacements, of the seat belts, so even if the car is equipped with airbags, make sure that you and the passengers always fasten the seat belts correctly.

◆ **Do not leave children in an unattended car**

Do not leave children in an unattended car, because accidental triggering of one or more car controls by the children may result in injury or death. Children may also accidentally move the car and cause a collision, resulting in injury or death. In addition, depending on changes in ambient temperature, extreme temperatures may be reached inside the car, causing injury or death.

◆ **Protect all children**

Children aged 12 or under should be properly restrained in the rear seats rather than the front seats. Infants and toddlers should use child safety seats; and older children should use child safety seats and three-point seat belts.

◆ **Beware of danger of airbag**

Airbags can save lives, but they can also cause serious or fatal injuries to occupants who are too close to the airbags or improperly restrained.

Airbags pose the greatest risk to infants, toddlers and short adults, so please follow all instructions and warnings in this manual.

◆ **Never drink and drive**

Drinking alcohol, even a little, will reduce your response capability, and your reaction time after drinking will become longer, so drinking and driving is strictly prohibited.

◆ **During driving, please abide by the road traffic safety laws and yield to pedestrians.**

◆ **Be sure to pay attention to driving safety**

Traffic accident will occur if you are busy answering the phone or handling other things so that you can not pay attention to road conditions, other cars and pedestrians during driving. Please avoid distraction during driving.

◆ **Control speed**

Excessive speed is one of the main causes of traffic accidents. The faster the speed is, the greater the risk will be. Therefore, please choose the appropriate speed for safe driving according to the actual road conditions.

◆ **Regular maintenance**

Tire burst or mechanical failure can be dangerous. In order to reduce the possibility of such problems, please check the tire pressure and status frequently, and carry out regular maintenance as specified in the *Warranty Manual*.

1. Important Safety Precautions

Event data recorder

The car is equipped with related equipment of event data recorder which records the data of the car in a certain collision (such as airbag deployment or collision with obstacles) in real time, which are conducive for better understanding of the condition of collision and injury.

These data are owned by the car owner. When necessary, GAC Motor Co., Ltd. or an authorized representative has the right to obtain the data stored in the event data recorder, for the purpose of technical diagnosis and R&D of the car only.

Service diagnostic recorder

The car is equipped with related equipment of service diagnosis recorder which records the information about powertrain performance and driving conditions. These data can assist technicians in diagnosing, repairing and maintaining the car.

These data are owned by the car owner. When necessary, GAC Motor Co., Ltd. or an authorized representative has the right to obtain the data stored in the car service diagnostic recorder, for the purpose of technical diagnosis and R&D of the car only.

2.1 Exterior

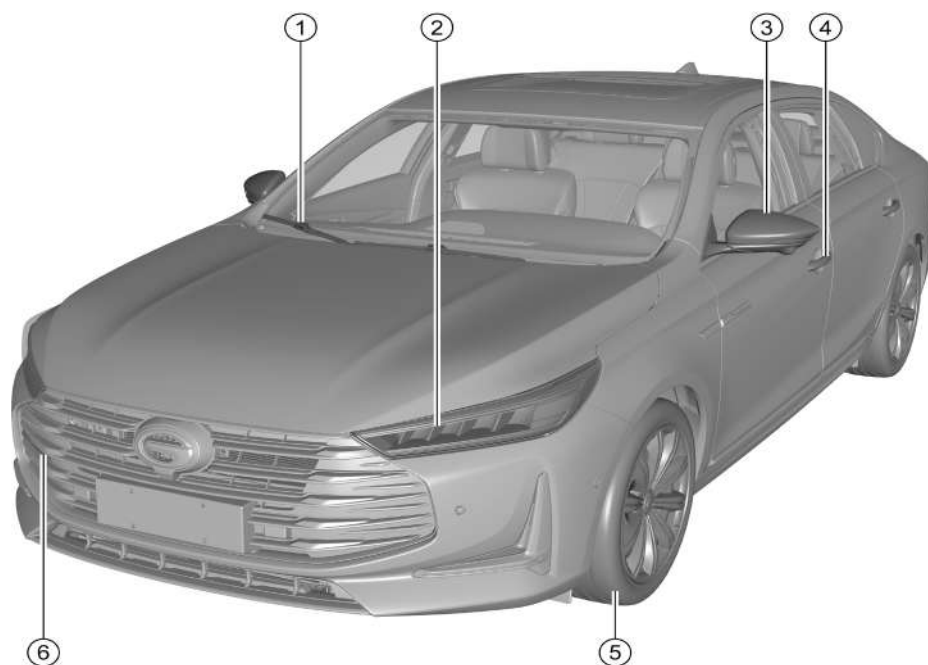

- ① Wiper
 - Replacing front windshield wiper blade=> [See Page 235](#)
- ② Front combination lamp
 - Turning on lamps=> [See Page 73](#)
 - Replacing bulb=> [See Page 242](#)
 - Specifications of front combination lamp bulb=> [See Page 259](#)
- ③ Exterior rear-view mirror=> [See Page 86](#)
 - Side turn signal lamp=> [See Page 73](#)
 - Specifications of side turn signal lamp=> [See Page 259](#)
- ④ PEPS system=> [See Page 60](#)
 - Door lock hole=> [See Page 56](#)
- ⑤ Wheel=> [See Page 227](#)
- ⑥ Towing from front=> [See Page 278](#)

2. Picture Index

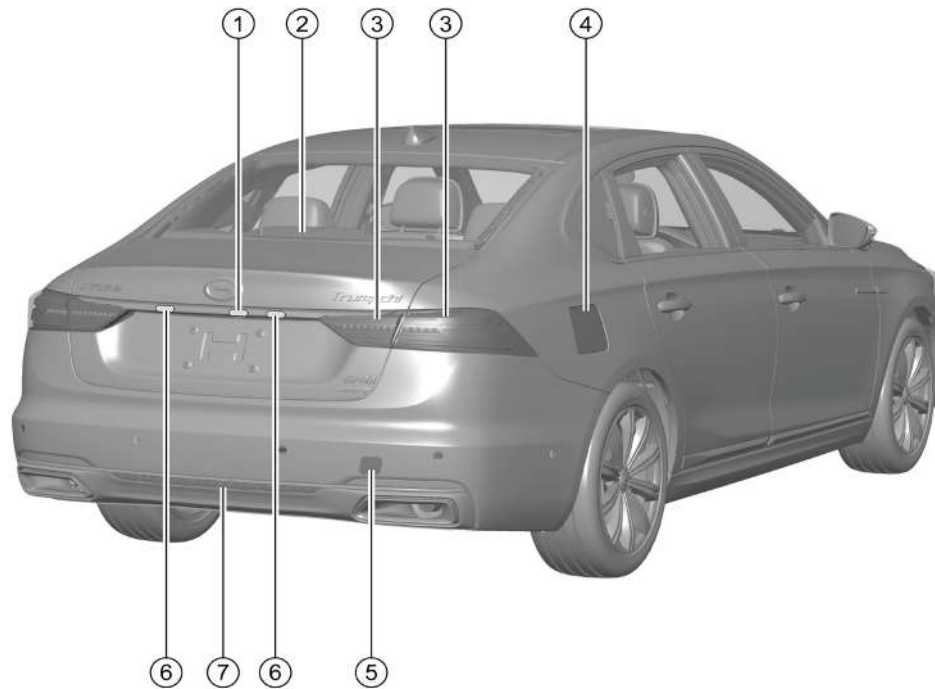

- ① Trunk lid unlocking button=> [See Page 62](#)
- ② High-mounted stop lamp
 - Specifications of high-mounted stop lamp=> [See Page 259](#)
- ③ Rear combination lamp
 - Specifications of rear combination lamp bulb=> [See Page 259](#)
- ④ Fuel tank cap=> [See Page 227](#)
- ⑤ Towing from rear=> [See Page 278](#)
- ⑥ License plate lamp
 - Specifications of license plate lamp=> [See Page 259](#)
- ⑦ Rear fog lamp=> [See Page 77](#)
 - Specifications of rear fog lamp=> [See Page 259](#)

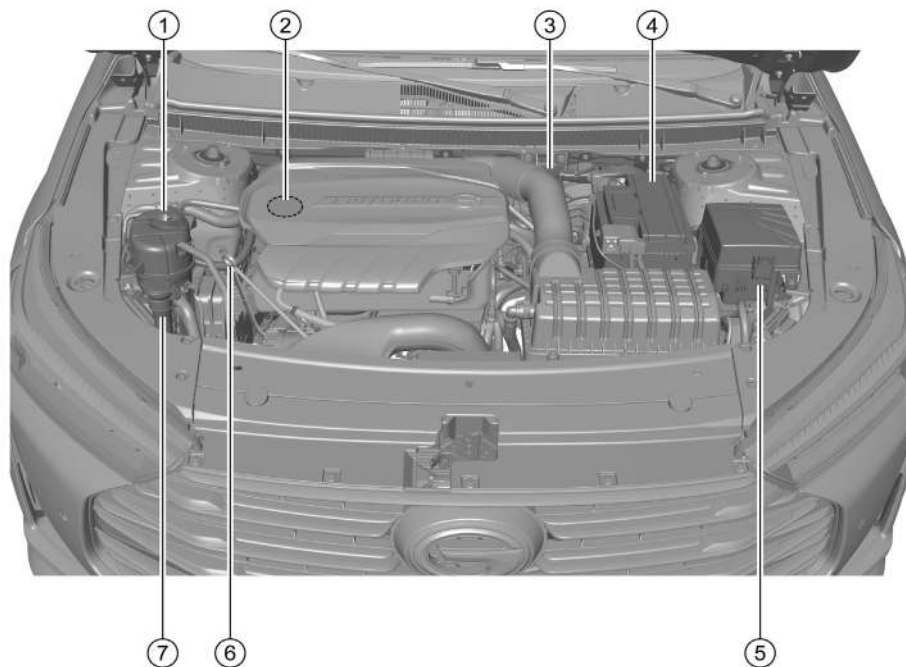

Engine compartment

- ① Expansion tank=> [See Page 233](#)
- ② Oil filler cap=> [See Page 231](#)
- ③ Brake fluid reservoir=> [See Page 237](#)
- ④ Battery=> [See Page 238](#)
- ⑤ Engine compartment PDU=> [See Page 267](#)
- ⑥ Oil dipstick=> [See Page 230](#)
- ⑦ Windshield washer fluid reservoir=> [See Page 235](#)

2. Picture Index

2.2 Interior

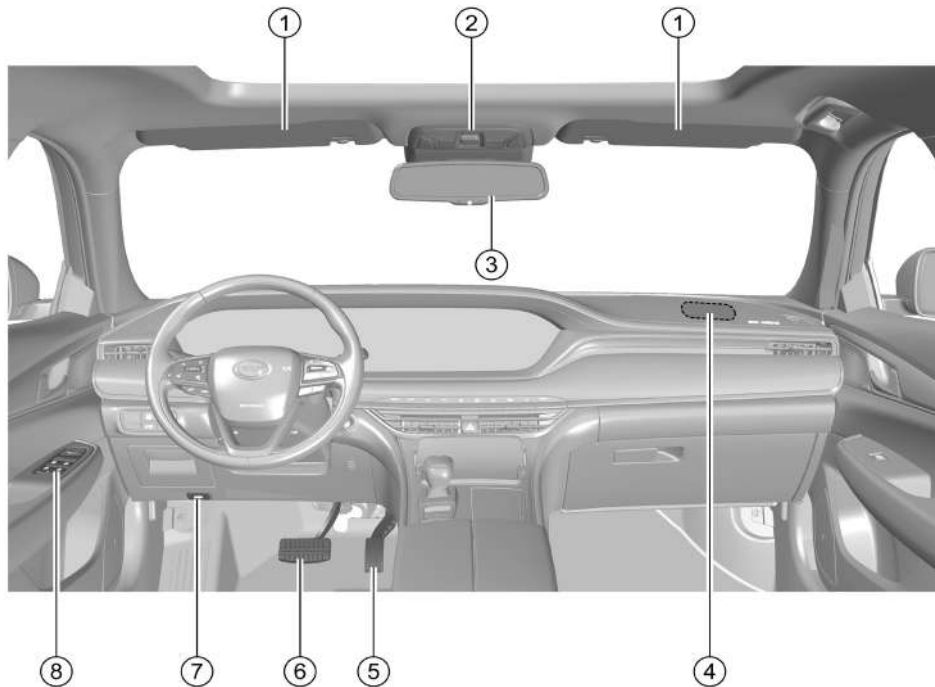

- ① Sun visor=> [See Page 89](#)
- ② Front roof lamp=> [See Page 79](#)
 - Electric sunroof control button=> [See Page 68](#)
 - Spectacle case=> [See Page 100](#)
- ③ Interior rear-view mirror=> [See Page 85](#)
- ④ Front passenger's frontal airbag=> [See Page 19](#)
- ⑤ Accelerator pedal
- ⑥ Brake pedal
- ⑦ Engine hood release handle=> [See Page 64](#)
- ⑧ Driver's power window control button=> [See Page 65](#)
 - Central locking control button=> [See Page 55](#)
 - Exterior rear-view mirror adjusting button=> [See Page 86](#)

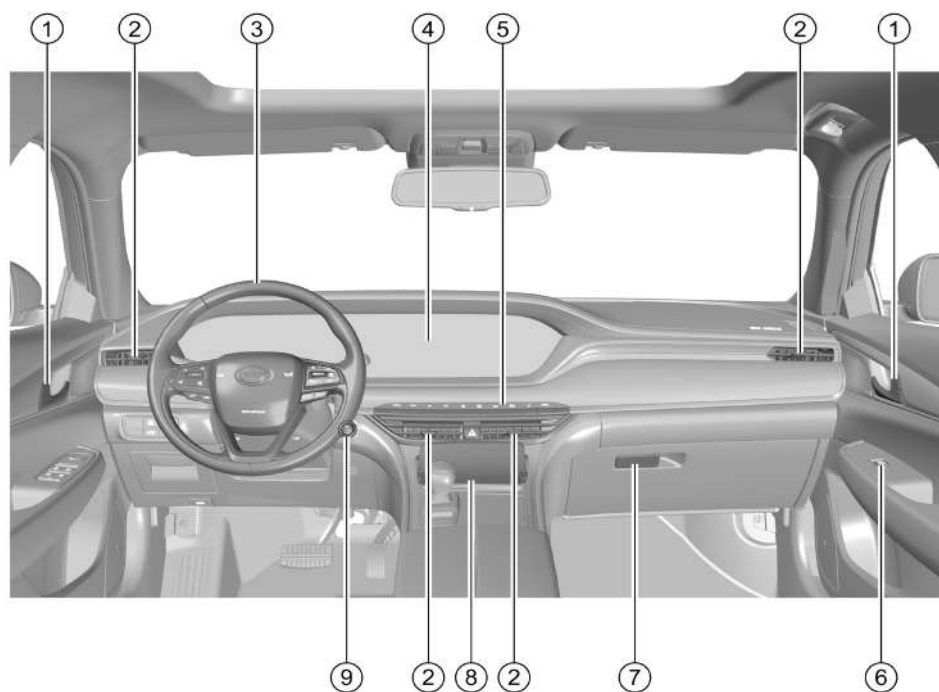

- ① Door latch and inside handle=> [See Page 56](#)
- ② A/C air outlet=> [See Page 116](#)
- ③ Steering wheel=> [See Page 34](#)
 - Buttons on steering wheel=> [See Page 35](#)
 - Driver's frontal airbag=> [See Page 18](#)
- ④ AV system=> [See Page 117](#)
- ⑤ A/C system control panel=> [See Page 110](#)
- ⑥ Passenger's power window control button=> [See Page 66](#)
- ⑦ Handle for opening the glove box=> [See Page 100](#)
- ⑧ Instrument panel front storage box=> [See Page 97](#)
 - USB interface=> [See Page 102](#)
- ⑨ Engine start/stop button=> [See Page 137](#)

2. Picture Index

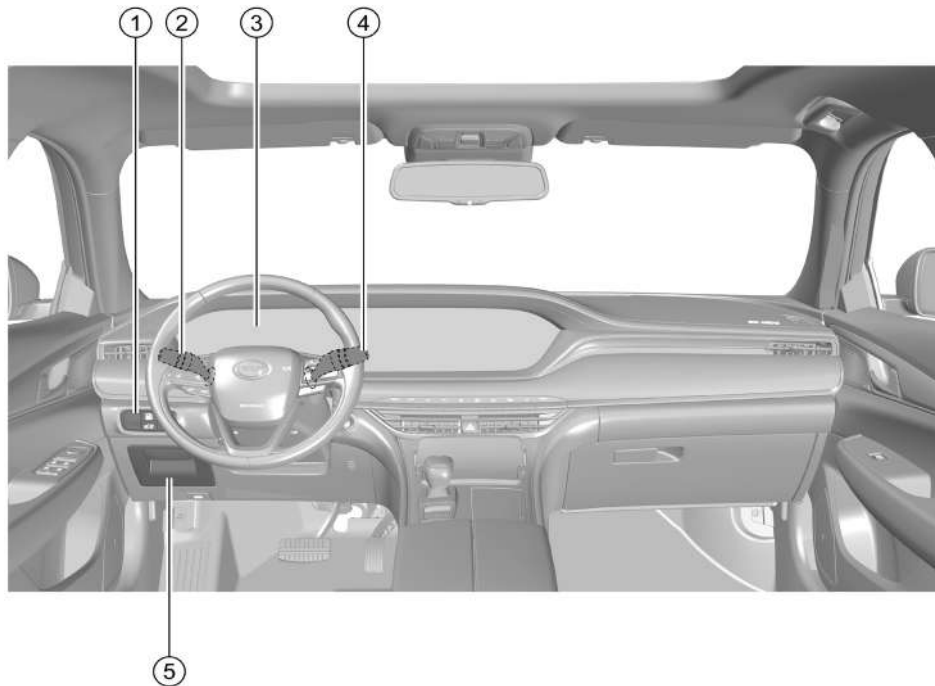

- ① Instrument left switch group
 - Manual headlamp leveling knob *=> [See Page 77](#)
 - Trunk lid unlocking button=> [See Page 62](#)
 - Fuel tank cap unlocking button=> [See Page 227](#)
- ② Lamplight combination switch=> [See Page 73](#)
- ③ Instrument cluster=> [See Page 36](#)
 - Indicator lamp=> [See Page 47](#)
- ④ Wiper combination switch=> [See Page 82](#)
- ⑤ Cab lower protective plate storage box=> [See Page 97](#)
 - Instrument panel PDU=> [See Page 267](#)

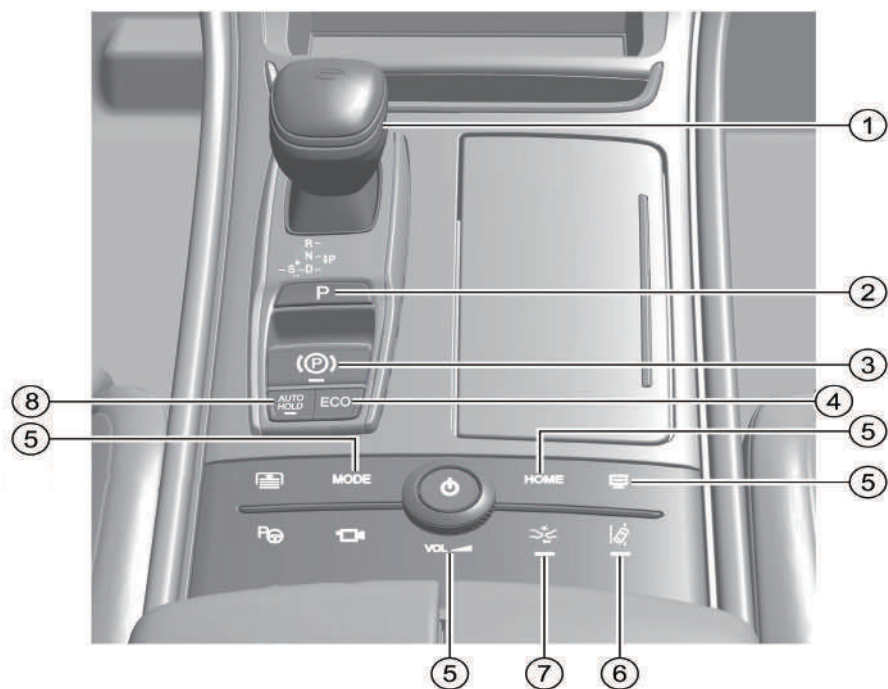

- ① Transmission gearshift lever=> [See Page 140](#)
- ② "P" gear button=> [See Page 140](#)
- ③ EPB button=> [See Page 147](#)
- ④ Economy mode button=> [See Page 143](#)
- ⑤ AV system button=> [See Page 117](#)
- ⑥ LDWS button *=> [See Page 180](#)
- ⑦ FCWS button *=> [See Page 172](#)
- ⑧ AUTO HOLD button=>[See Page 150](#)

3. Instructions for Safe Operation

3.1 Safe driving

3.1.1 General instructions

This section introduces important information, operating essentials, recommendations and safety precautions for safe driving. For the safety of you and the passengers, please read carefully and follow the relevant regulations.

NOTE

Please always bring the *Owner's Manual* with the car. If you lend or resell the car to someone else, be sure to hand the complete set of accompanying documents over to the new owner.

The following inspection must be carried out before driving:

- Check that all lamps are working properly.
- Check that the fuel level is normal.
- Check that the coolant level is normal.
- Check that the brake fluid level is normal.
- Check that the windshield washer fluid level is normal.
- Check that the tire pressure is normal.
- Check that all windows are clear and have a good view.
- Check that no objects obstruct the movement of the driver's foot pedal.
- Adjust the seat, head restraint and rear-view mirror according to body height and shape.
- Use appropriate child safety seats to protect children and help them fasten the seat belts correctly.
- Fasten the seat belt correctly and remind all passengers in the car to fasten the seat belts correctly.
- Check that the surrounding environment is safe.

WARNING

When installing the driver's floor mat, please observe the following precautions:

- **Do not overlap two or more floor mats.**
- **Do not make the bottom surface of the floor mat upward or back-to-front.**
- **Do not use floor mats that is incompatible with this car model.**

NOTE

- Do not distract yourself from external factors during driving.
- Do not drive the car when your response capability reduces, such as due to medicines, alcohol, or drugs.
- Strictly abide by traffic regulations.

3.1.2 Correct sitting posture of the driver and passengers

Correct sitting posture of the driver

Whether the driver's sitting posture is correct directly affects the driver's fatigue level and driving safety. Before driving, the driver should do the following:

- Sit up straight and adjust the seat back to a suitable position so that the back fits completely the seat back.
- Adjust the seat position so that all pedals can be operated effectively with slightly bent legs.
- Correctly adjust the head restraint of the seat.=> See Page 89
- Fasten the seat belt correctly.=> See Page 15
- Adjust the steering wheel position.=> See Page 34

WARNING

During driving, the driver must not adjust the seat, head restraint or steering wheel; otherwise the car may be out of control, leading to an accident.

Correct sitting posture of the passengers

To guarantee the safety of the passengers and reduce the risk of casualties, the passengers should do the following:

- Sit up straight and adjust the head restraint of the seat correctly.=>See Page 89
- The front passenger should adjust the distance between the seat and the instrument panel according to his or her own needs.
- The front passenger should adjust the seat back to a suitable position so that the back fits completely the seat back.
- Fasten the seat belt correctly.=> See Page 15
- The passenger should place both feet on the floor.
- The child passenger, if any, must use appropriate child safety seat for protection in accordance with applicable regulations.=> SeePage 25

WARNING

- **It is forbidden to install a child safety seat in the front passenger's seat.**
- **If the front passenger is too close to the instrument panel, the SRS will not provide effective protection.**
- **During driving, correct sitting posture must be maintained and seat belts must be fastened correctly to avoid injuries caused by emergency braking or accidents.**

3. Instructions for Safe Operation

3.2 Seat belt

3.2.1 Why must you fasten the seat belt

Protection of the driver and passengers by seat belts



In the event of a car collision, fastening seat belts correctly can restrain the driver and passengers in a proper position and slow down the inertia of their forward movement, thus preventing them from being thrown forward, and at the same time enable them to get the best protection from the airbag, thus reducing their impact injury as much as possible.

In a car collision, the seat belts assist other safety systems in simultaneously absorbing the energy generated by the collision, further reducing the injuries suffered by the driver and passengers.

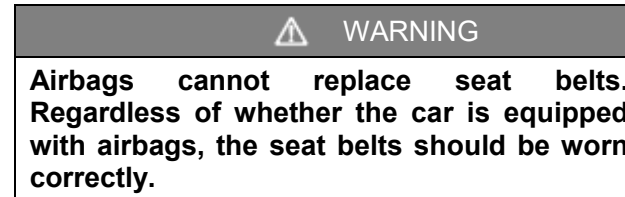

Consequences of not fastening the seat belt

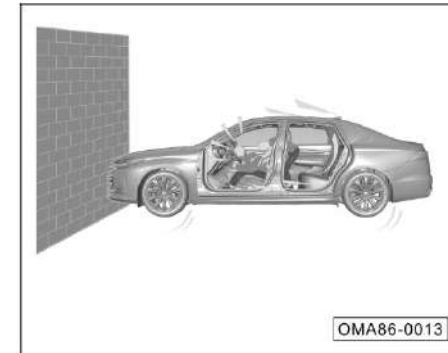

In the event of a car collision, the driver or passenger who does not fasten the seat belt will be thrown forward due to inertia and injured.



Even if the car speed is very low, the force acting on the human body in the event of a collision is so great that the driver or passenger cannot control his or her body with hands at all. In that case, the driver or passenger who does not fasten the seat belt will be thrown forward, and be injured in case of collision against any interior objects.



Rear passengers must also fasten the seat belts correctly, otherwise they will be thrown forward when an accident occurs. The occupant who does not fasten the seat belt will not only hurt himself or herself, but also endanger other occupants in the car.

3.2.2 Seat belt

Seat belt indicator lamp

: Driver's seat belt indicator lamp

: Front passenger's seat belt indicator lamp

When the engine start/stop button is set to "ON" position, the alarm message appears as follows:

- When the car speed is lower than 20 km/h, if the driver or front passenger does not fasten the seat belt, the corresponding indicator lamp in the instrument cluster will flash for about 6 s and stay on, accompanied by an alarm message.
- When the car speed is higher than or equal to 20 km/h, if the driver or front passenger does not fasten the seat belt, the corresponding indicator lamp in the instrument cluster will flash for about 20 s and stay on, accompanied by an alarm message and a continuous audible alarm.

3. Instructions for Safe Operation

NOTE

- Before driving, please check whether there are any heavy objects on the front passenger's seat to avoid the system mistakenly determining that the seat is occupied and issuing a false alarm.
- If the above-mentioned alarm still appears after the seat belt is fastened correctly, it means that the seat belt device is invalid. In that case, please go to the GAC Motor authorized shop for inspection in time.

Seat belt pretensioner and load limiter



The seat belt pretensioner and load limiter can reduce the pressure of the seat belt on the chest of the driver or passenger and improve the protection performance.

- Before the collision, the seat belt pretensioner and load limiter can restrain the driver or passenger and enable him or her to maintain a correct sitting posture to prevent the body from leaning forward.
- In the event of a severe collision where the triggering condition is reached, the seat belt pretensioner and load limiter will be triggered, driving the seat belt webbing to be quickly retracted and tensioned.

- When a collision occurs, the human body will move forward, and the seat belt pretensioner and load limiter will be activated at this time, so that the restraint force of the seat belt on the human body will be within a certain range, preventing the driver or passenger from being further injured due to excessive force. And at the same time, the seat belt pretensioner and load limiter will coordinate with the airbag to achieve a better safety protection performance.

NOTE

- When the seat belt pretensioner and load limiter is activated, a little harmless smoke will be released, accompanied by a sound, which is normal.
- The activated seat belt pretensioner and load limiter will no longer operate, and the supplemental restraint system (SRS) indicator lamp  will stay on. In that case, please contact the GAC Motor authorized shop for replacement.

Adjusting the shoulder belt height

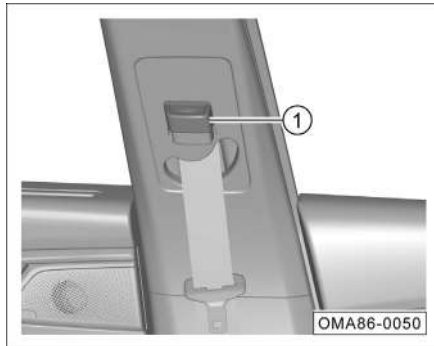

- Moving up: Grasp the guide and move it up to adjust the shoulder belt to the appropriate height.
- Moving down: Press the guide to unlock the switch ① and move it down to adjust the shoulder belt to the appropriate height.
- After the adjustment, check whether the guide is firmly locked.

Fastening the front seat belt



- Keep a correct sitting posture.=> See Page 11
- Slowly and evenly pull out the seat belt, insert the tongue into the corresponding buckle until a click sound is heard.
- Pull the seat belt and confirm that the tongue is properly locked.

Unbuckling the seat belt



- Press the red button of the buckle. Then the tongue will pop out automatically.
- Grasp the seat belt and allow it to retract slowly.

i NOTE

All seat belts are fastened in the same way, and the driver is responsible for reminding other passengers to fasten the seat belts correctly.

3. Instructions for Safe Operation

Pregnant women must fasten the seat belts correctly



How does a pregnant woman correctly fasten the seat belt?

- Adjust the seat and head restraint to the proper position.
- Grasp the tongue, slowly pull the seat belt over the shoulder, and ensure that the lap belt is as low as possible and not pressed against the abdomen.
- Insert the tongue into the corresponding buckle until a click sound is heard.
- Pull the shoulder belt upward parallel to the upper body, tension the lap belt, and make sure that the tongue is properly locked.

WARNING

To reduce the risk of injury during emergency braking or accidents, please observe the following precautions:

- Before driving, make sure that all occupants have properly fastened the seat belts.
- Each seat belt is for one person only. Do not share a seat belt with other persons (including children).
- Do not recline the front seat back excessively for comfort.
- Do not put the shoulder belt under or behind your arm.
- The seat belt tongue must be inserted into the buckle on the corresponding side, and may not be inserted into the buckle on the other side.
- It is forbidden to unbuckle the seat belt before the car is completely stationary.

3.3 Supplemental restraint system (SRS)

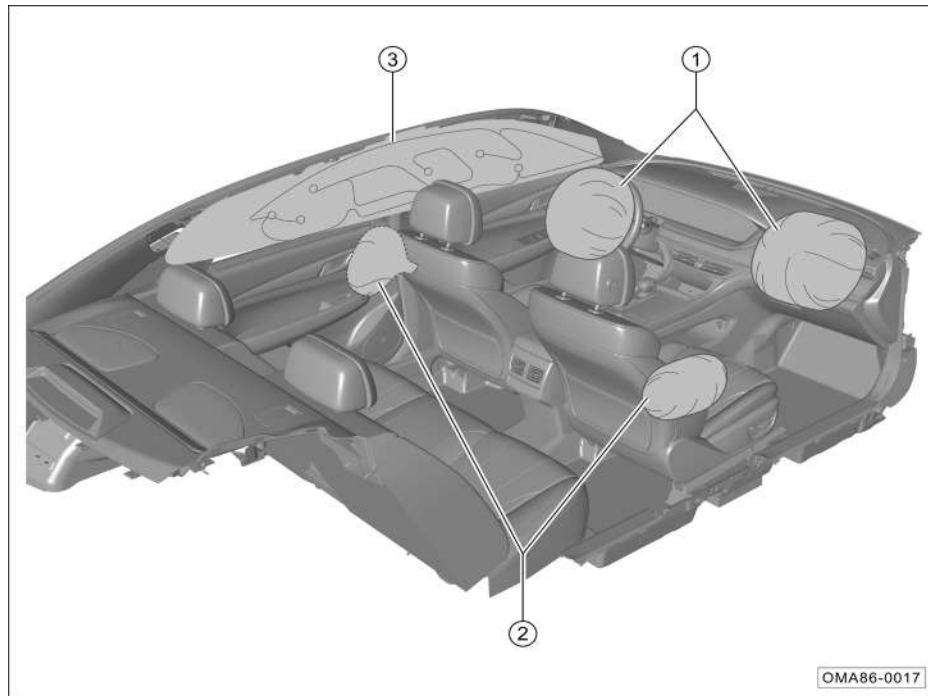

Depending on car configurations, the deployment positions of the SRS are as shown below:

- ① Front seat frontal airbag.
- ② Front seat side airbag.
- ③ Side curtain airbag*.

i NOTE

It is normal that the airbag generates a little harmless smoke when deployed.

3. Instructions for Safe Operation

SRS indicator lamp

After the engine start/stop button is set to "ON" position, the indicator lamp  will be on for a few seconds and go out after the system completes self-test.

 A system fault is indicated when the indicator lamp is in the following conditions:

1. After the engine start/stop button is set to "ON" position, the indicator lamp does not come on.
2. After the engine start/stop button is set to "ON" position, the indicator lamp does not go out after the system completes self-test.
3. After the engine start/stop button is set to "ON" position, the indicator lamp goes out after the self-test, but then comes on again.
4. The indicator lamp comes on or flashes while the car is running.

WARNING

- **Never attempt to repair, adjust or modify the airbag.**
- **The airbag can only be activated once. If it is triggered by an accident, you must contact the GAC Motor authorized shop for replacement.**
- **When the SRS is faulty, please contact the GAC Motor authorized shop for inspection; otherwise the system will not trigger or abnormally trigger the airbag in the event of a car collision.**

Front seat frontal airbag



The driver's frontal airbag is installed inside the steering wheel (see the dotted dash area), where "SRS AIRBAG" is the airbag sign.

3. Instructions for Safe Operation



The front passenger's frontal airbag is installed inside the instrument panel (see the dotted dash area), where "SRS AIRBAG" is the airbag sign.

In the event of a severe frontal collision where the triggering condition is met, the frontal airbags will be triggered by the system and deploy rapidly to assist the seat belts in protecting the driver and front passenger.

In certain collision accidents, the system may simultaneously trigger other airbags.

WARNING

Do not attach or place any decorative objects on the surface area of the instrument panel, because once the car is running or the airbag deploys, these objects will fall, knock over and roll around in the car, affecting the driver and hurting the passengers in the car.

The front seat frontal airbags might not be triggered in the following cases:

- The engine start/stop button is at "ACC" or "OFF" position.
- Minor frontal collision.
- Side collision.
- Rear collision.
- Rollover.
- Other special circumstances.

NOTE

The word "minor" refers to the extent with respect to the car SRS controller and has nothing to do with the damage of the car.

3. Instructions for Safe Operation

Front seat side airbag



The front seat side airbags are installed in the outboard sides of the driver's seat back and the front passenger seat back respectively (see the dotted dash area), where "SRS AIRBAG" is the airbag sign.

In the event of a severe side collision where the triggering condition is met, the side airbags on the side where the car collides will be triggered by the system and deploy rapidly to assist the seat belts in protecting the driver and front passenger.

In certain collision accidents, the system may simultaneously trigger other airbags.

The front seat side airbags might not be triggered in the following cases:

- The engine start/stop button is at "ACC" or "OFF" position.
- 100% frontal collision.
- Minor side collision.
- Rear collision.
- Other special circumstances.

i NOTE

The word "minor" refers to the extent with respect to the car SRS controller and has nothing to do with the damage of the car.



WARNING

- **Observe the instructions on the warning label pasted on the side of the door. Do not lean your body against the door side equipped with side airbags during driving.**
- **Do not cover the side airbags with seat covers or other objects; otherwise, the side airbags will not be triggered to protect the occupants when an accident occurs.**

Side curtain airbag *

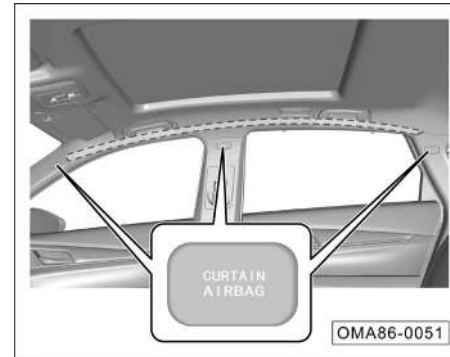

Side curtain airbags are installed in the left and right sides of the roof respectively (see the dotted dash area), where "CURTAIN AIRBAG" is the airbag sign.

In the event of a severe side collision, the side curtain airbags on the side where the car collides will be triggered by the system and deploy rapidly to assist the seat belts in protecting the driver and passengers.

In certain collision accidents, the system may simultaneously trigger other airbags.

The side curtain airbags might not be triggered in the following cases:

- The engine start/stop button is at "ACC" or "OFF" position.
- 100% frontal collision.
- Minor side collision.
- Rear collision.
- Other special circumstances.

NOTE

The word "minor" refers to the extent with respect to the car SRS controller and has nothing to do with the damage of the car.

3. Instructions for Safe Operation

3.3.1 Cases where the airbags may deploy

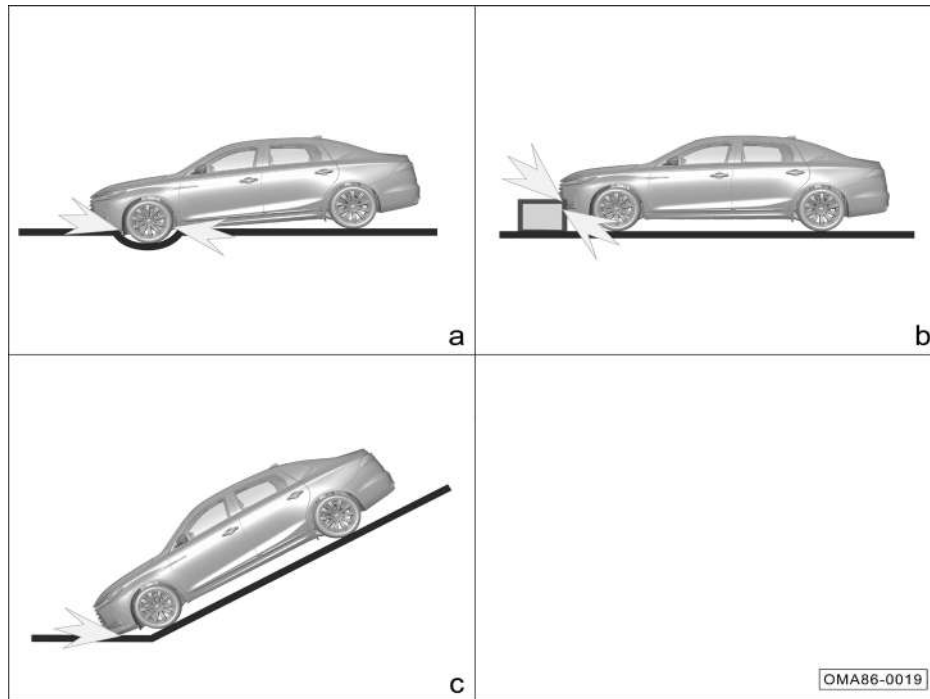

- a. The nose of the car hits the ground when crossing a deep groove.
- b. Collision with roadside protrusions, curbs, etc.
- c. The nose of the car hits the ground when going down a steep slope.

3. Instructions for Safe Operation

3.3.2 Cases where the airbags might not deploy

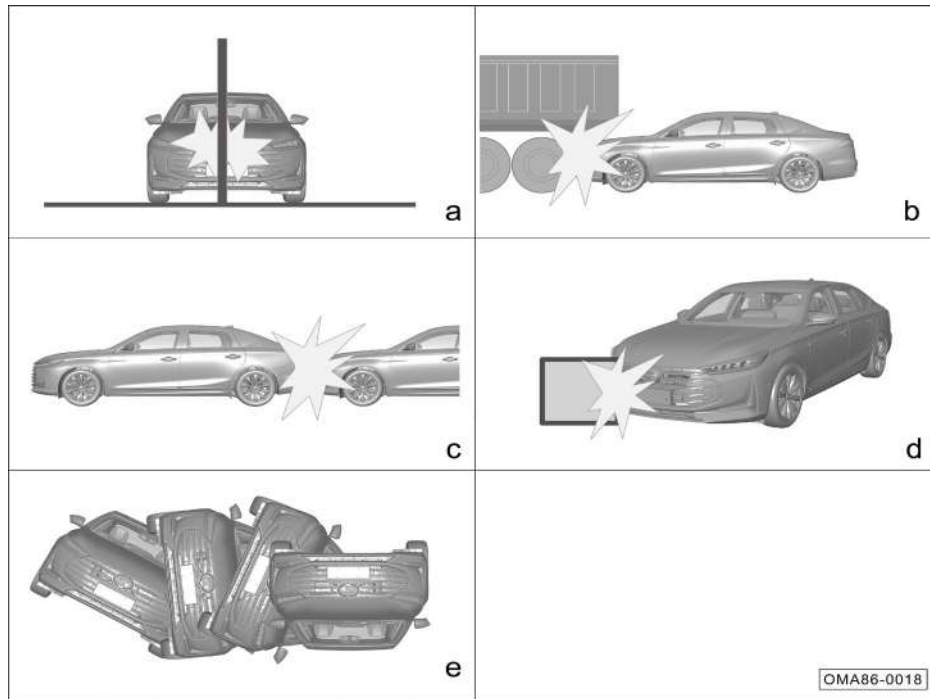

- Collision with concrete pillars, trees or other elongated objects.
- Rear-end collision that the car underruns the rear of a large truck.
- Rear-end collision that the car rear end is underrun by another vehicle.
- Collision with a wall or another vehicle, other than frontal collision.
- Rollover or tilting.

3. Instructions for Safe Operation

3.4 Safe ride of children

3.4.1 General instructions

The child must sit in a rear seat, and a suitable child safety seat should be selected for protection according to the size of the child.



Warning labels are pasted on the front and back of the right visor to remind the front passenger of the danger of frontal airbag. Be sure to read and follow the instructions on the labels.

⚠ WARNING

- **Do not install any rear-facing child safety seats on seats with frontal airbags!**
- **Even if the child has been put in a child safety seat, do not let it rest any part of the head or body on the door area (the deployment area of the front seat side airbag or side curtain airbag *); otherwise the impact force of the deployed front seat side airbag and side curtain airbag * can cause serious injury or even death of the child.**
- **Do not let children stand or kneel on the seat.**
- **Do not allow children to operate devices that may trap themselves (such as power window, sunroof, etc.).**

⚠ WARNING

- **Never leave children alone in the car!**
- **Never hold infants or toddlers on your knees!**
- **Seat belts are not suitable for infants and toddlers as they can cause injuries in the event of an accident.**
- **Ensure that in the event of a collision or emergency braking, children are less likely to be injured by hitting any hard objects in the car.**
- **The door near the child's seating position should have the child safety lock activated.**

3.4.2 Child safety seat



a. Group 0/0+ child safety seat



b. Group I child safety seat



c. Group II child safety seat



d. Group III child safety seat

OMA86-0022

Classification of child safety seats (for reference only):

a. Group 0/0+ child safety seats:

- Suitable for infants weighing less than 13 kg.

b. Group I child safety seats:

- Suitable for toddlers weighing between 9 kg and 18 kg.

c. Group II child safety seats:

- Suitable for children weighing between 15 kg and 25 kg.

d. Group III child safety seats:

- Suitable for children weighing between 22kg and 36kg.

3. Instructions for Safe Operation

3.4.3 Information about child safety seat

Information about the applicability of different seating positions for child restraint systems:

Weight group	Mounting position		
	Front passenger seat	Outboard rear seats	Rear middle seat
Group 0: <10 kg	X	U	X
Group 0+: <13 kg	X	U	X
Group I: 9~18 kg	X	U/UF	X
Group II: 15~25 kg	X	UF	X
Group III: 22~36 kg	X	UF	X

Note: **The meanings of uppercase letters in the table are as follows:**

U = Suitable for all "general" child safety seats for this weight group.

UF = Suitable for all front-facing "general" child safety seats for this weight group.

X = Not suitable for the child safety seats for this weight group.

For some child safety seats, a size class is specified. Be sure to check the size class according to the manufacturer's instructions, packaging, and child safety seat label. For guidance on proper installation, please refer to the instruction of the child safety seat.

ISOFIX mounting positions for ISOFIX child safety seats

Weight group	Size class	Fixture module	Mounting position		
			Front passenger seat	Outboard rear seats	Rear middle seat
Carry-cot	F	ISO/L1	X	X	X
Group 0: <10 kg	G	ISO/L2	X	X	X
	E	ISO/R1	X	IL	X
Group 0+: <13 kg	E	ISO/R1	X	IL	X
	D	ISO/R2	X	IL	X
	C	ISO/R3	X	IL	X
Group I: 9~18 kg	D	ISO/R2	X	IL	X
	C	ISO/R3	X	IL	X
	B	ISO/F2	X	IUF	X
	B1	ISO/F2X	X	IL	X
	A	ISO/F3	X	IUF	X
Group II: 15~25 kg	—	—	X	—	X
Group III: 22~36 kg	—	—	X	—	X

Note: The meanings of uppercase letters in the table are as follows:

IUF—Suitable for “front-facing” general ISOFIX child safety seats for this weight group that are fixed with top tether.

IL—Suitable for the special ISOFIX child restraint systems listed in the table which may be special, restricted or semi-general.

X—Not suitable for the child safety seats for this weight group.

For some child safety seats, a size class is specified. Be sure to check the size class according to the manufacturer's instructions, packaging, and child safety seat label. For guidance on proper installation, please refer to the instruction of the child safety seat.

3. Instructions for Safe Operation

3.4.4 Correct installation of child safety seat

The child safety seat is installed by following three means: three-point seat belt, ISOFIX system, and LATCH system.

i NOTE

During the actual installation of the child safety seat, be sure to refer to the instruction of the child safety seat for correct installation.

Installation of child safety seat by three-point seat belt



1. Place the child safety seat on the rear seat.
2. Pass the seat belt through the child safety seat and fully insert the tongue into the buckle until a click sound is heard.

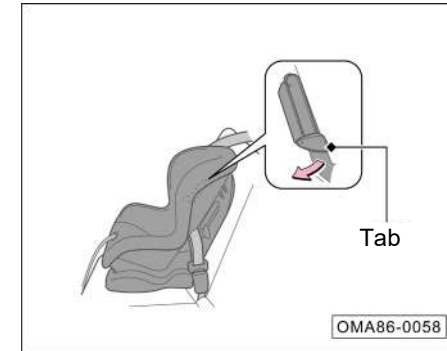

3. Push the tongue down and pass the shoulder belt through the slit on the side of the child safety seat.

3. Instructions for Safe Operation

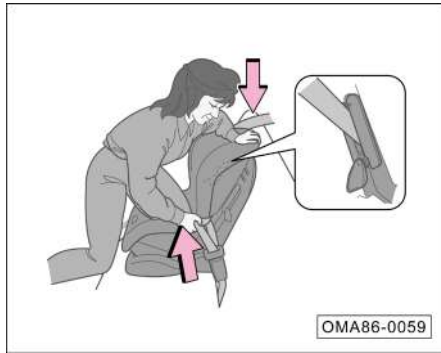

4. Grasp the shoulder belt near the buckle and pull it up to tension the lap belt. At this time, press the child safety seat with your own weight and push it into the car seat.

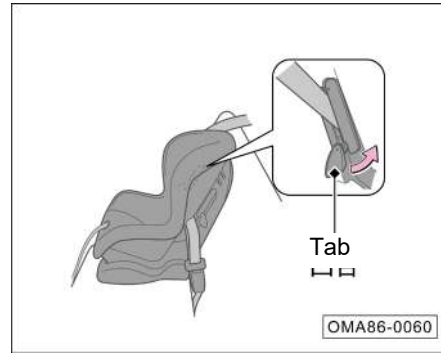

5. Place the seat belt correctly and push the tab up. Make sure the seat belt is not twisted. When pushing the tab up, pull upward the upper part of the shoulder belt to tension the belt.



6. Shake the child safety seat back and forth, left and right to make sure it is firmly fixed.
7. Make sure that all unused seat belts in the reach of the children are locked.

3. Instructions for Safe Operation

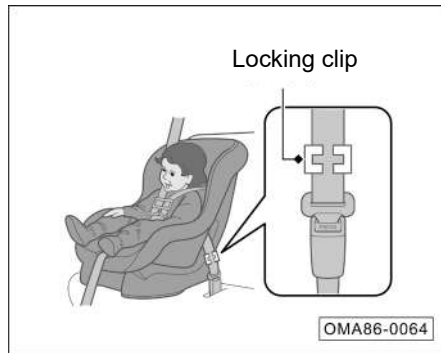

If no means are provided on the child safety seat for securing the seat belt, please install a locking clip on the seat belt.

- After the above steps 1 and 2, pull up the shoulder belt and make sure the lap belt is tensioned.
- Firmly grasp the seat belt near the locking tab. Pinch the two parts of the seat belt together so that they do not slip out of the locking tab. Unbuckle the seat belt.

Install the locking clip as shown. Place the buckle as close as possible to the locking tab and insert the locking tab into the locking clip. Go to steps 6 and 7.

Installing LATCH or ISOFIX system

The rear seats of this car are equipped with the LATCH system, and thus suitable for the LATCH or ISOFIX system child safety seats. Below are mainly the installation instructions of the LATCH system child safety seat.

 **WARNING**

- **The child safety seat anchorages installed in this car can be used to fix the child safety seats only.**
- **Do not connect straps, hard and sharp objects or any other objects other than child safety seats to the anchorages; otherwise children may be endangered in the event of an accident.**

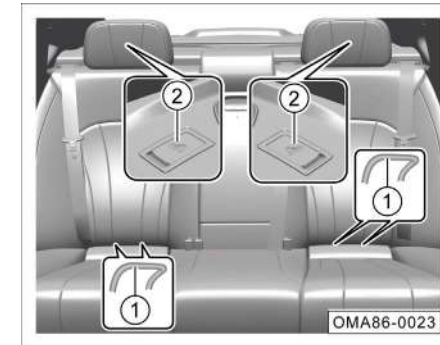

The lower anchorage ① of the rear seat is hidden in the gap between the seat back and the seat cushion; the upper anchorage ② is directly behind the rear seat head restraint and can be seen by opening the trim cover.

Below are mainly the installation instructions of the LATCH system child safety seat.

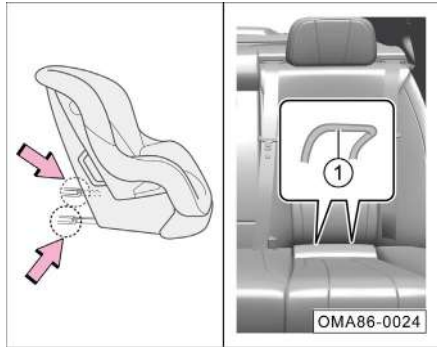

1. Put the child safety seat on the seat, find the lower anchorage ①, and insert the lower guide grooves of the child safety seat (as arrowed) into the lower anchorage ① until a click sound is heard.

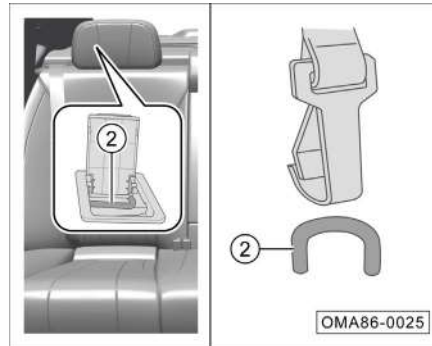

2. Lift the head restraint to the highest position, then pass the strap through the head restraint pillar, open the protective cover of the upper anchorage ②, and catch the upper anchorage ② with the strap hook to ensure that the strap is not twisted.
3. Tension the strap and shake the child safety seat to ensure it is firmly fixed.

3. Instructions for Safe Operation

3.5 Exhaust gas hazard

Carbon monoxide gas

The exhaust gas emitted by the engine contains the toxic carbon monoxide gas. Please use the car correctly to prevent the carbon monoxide gas from entering the car.

Please contact the GAC Motor authorized shop to check whether the exhaust system is normal in the following cases:

- The exhaust system makes abnormal noises.
- The exhaust color is abnormal.

When the car is driven with the trunk lid open, the exhaust gas will enter the car, which is dangerous. If you must drive the car with the trunk lid open, please open all windows and turn on the A/C system:

1. Select the fresh air mode.
2. Select  mode.
3. Set the fan speed to the highest.

If the engine is idling during parking, adjust the A/C system in the same way.

WARNING

- **Carbon monoxide gas is toxic, and inhaling a great quantity of it will cause loss of consciousness and even death.**
- **When the engine is started for a long time in a confined space (such as a garage, etc.), carbon monoxide will quickly accumulate, resulting in excessive carbon monoxide in the car. After starting the engine, drive the car away from the confined space immediately.**

3.6 Safety label

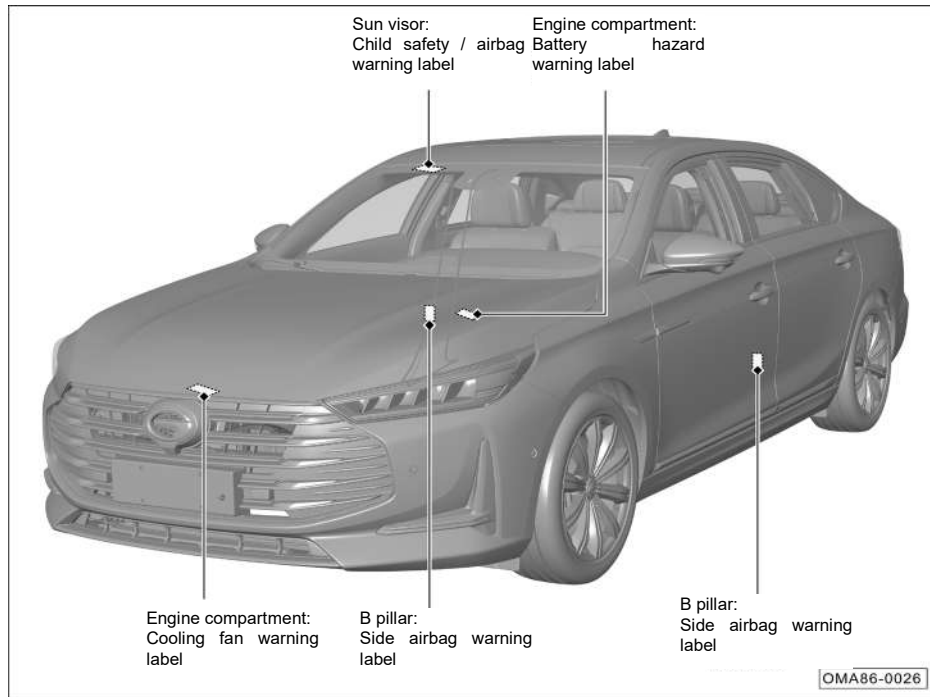

The labels are located as shown to remind you of the potential danger that can cause serious injury or death. Please read these labels carefully.

If the label comes off or is difficult to read, please go to the GAC Motor authorized shop in time for replacement.

i NOTE

In case of any discrepancy in the illustrated location or quantity of the labels, the actual car shall prevail.

4. Operation of Systems and Equipment

4.1 Cab

4.1.1 Steering wheel

Adjusting steering wheel position



- Adjust the driver's seat to a suitable position, so that the distance between the steering wheel and your chest is not less than 25 cm.

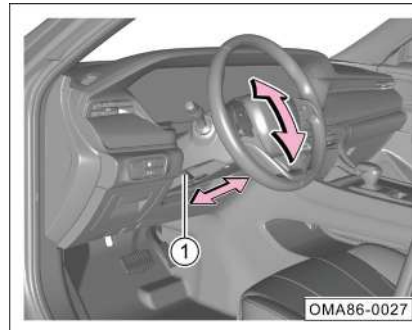

- Push down the locking handle ① to unlock the steering wheel.
- Adjust the steering wheel to the appropriate position up, down, front, and back as required, so that you can see the instrument panel and all indicator lamps.
- Pull up the locking handle ① to lock the steering wheel and make sure it is firmly locked.

NOTE

If a great locking force is applied for locking the locking handle, you can release the locking handle again and then shake it up and down for locking again.

WARNING

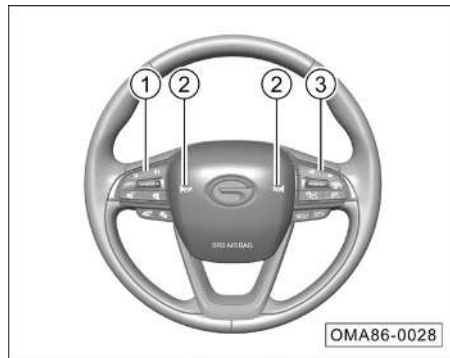

- During driving, the driver's hands should always grasp the outer ring of the steering wheel (9 o'clock and 3 o'clock positions).
- After adjustment, the steering wheel must be locked to prevent shifting while the car is running.
- Only when the car is stopped can the steering wheel be adjusted to avoid traffic accidents.
- To ensure safety, the steering wheel should face your chest, otherwise the airbag cannot provide effective protection in the event of an accident.

Buttons on steering wheel



① AV system control button=> [See Page 119](#)

② Horn button: Press  button to sound the horn; release the button to stop sounding the horn.

 WARNING
Do not press and hold  button for a long time; otherwise the horn is highly prone to be damaged.

③ The right buttons include the control buttons of the instrument cluster display and the cruise control buttons:

- Control buttons of the instrument cluster display:
 - Driving information=> [See Page 40](#)
 - Menu setting=> [See Page 42](#)
 - Alarm message=> [See Page 44](#)
- Cruise control buttons:
 - ACC button*=> [See Page 157](#)

4. Operation of Systems and Equipment

4.1.2 Instrument cluster

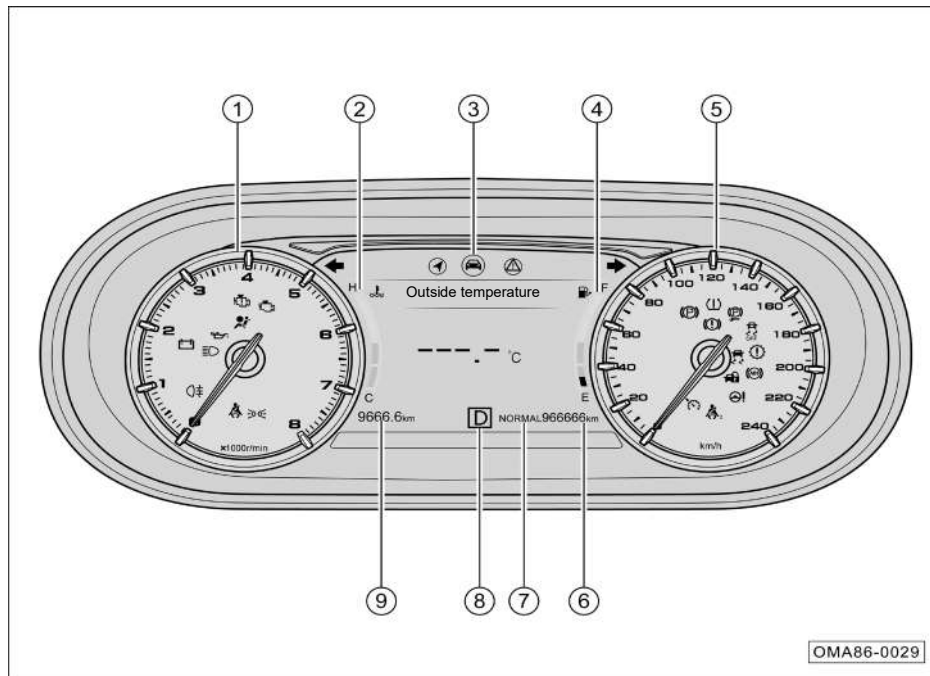

7-inch instrument cluster*

- ① Tachometer
- ② Engine coolant temperature gauge
- ③ Instrument cluster display
- ④ Fuel gauge
- ⑤ Speedometer
- ⑥ Odometer
- ⑦ Driving mode
- ⑧ Gear display
- ⑨ Trip meter

Tachometer

The tachometer is used to indicate the current engine speed in x1000 r/min.

NOTE

6000~8000 r/min is the high load area of the engine, which shall never be reached for fear of engine damage.

Instrument cluster display

The displayed information includes: driving information=> See Page 40, menu setting=> See Page 42, navigation information*=> See Page 45, AV and entertainment information*=> See Page 46, alarm message=> See Page 44, ADAS*=> See Page 46.

NOTE

If the instrument cluster display is abnormal, stop the car immediately for the sake of safety, and contact the GAC Motor authorized shop for inspection.

Engine coolant temperature gauge

The engine coolant temperature gauge (water temperature gauge) is used to indicate the current temperature of the engine coolant.

- The range of the gauge is C~H, where "C" indicates low temperature and "H" indicates high temperature.
- After the engine is started, the corresponding number of divisions on the dial of the water temperature gauge lights up according to the specific temperatures, and normally the divisions ranging up to the center of the dial light up; when the whole dial of the water temperature gauges lights up, it means that the current engine coolant temperature is too high.

Fuel gauge

The fuel gauge is used to indicate the current amount of fuel remaining in the fuel tank.

- The range of the gauge is E~F, where "E" indicates that the fuel tank is empty and "F" indicates that the fuel tank is full.
- The corresponding number of divisions on the dial of the gauge lights up according to the amount of remaining fuel in the fuel tank. When no division or only the first division lights up, it means that there is insufficient fuel in the fuel tank. In that case, the fuel level indicator lamp  will also light up, accompanied by the text "Low fuel level", reminding the driver that there is not enough fuel and fuel should be added as soon as possible.

Gear display

- The current gear information of the car such as "P", "R", "N" or "D" is displayed according to the received signal.

Driving mode

- The current driving mode of the car is displayed according to the received signal.

Trip meter *

- The indication range is 0 km ~ 9999.9 km. When the indication of the trip meter is greater than 9999.9 km, the trip meter will be reset, and then its indication will be continued to accumulate.
- The trip meter can be reset through the trip meter option in the menu setting of the instrument cluster.

Odometer

- The indication range is 0 km ~ 999999km.

Speedometer

The speedometer is used to indicate the current speed of the car in km/h.

NOTE

For driving safety, please strictly abide by the traffic rules, and do not speed the car at will.

4. Operation of Systems and Equipment

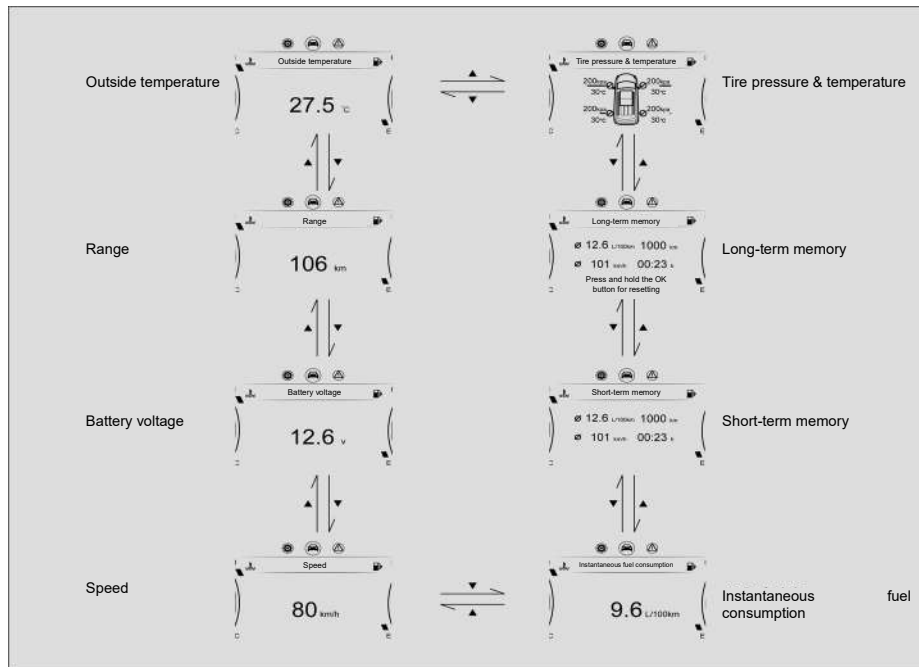

Driving information (7-inch instrument cluster)

When the engine start/stop button is at “ON” position, press ◀ or ▶ button on the right of the steering wheel to switch to the driving information screen, and then turn the OK button upwards or downwards to switch the display information screens.

i NOTE

- When no valid information is received, the driving information screen will not display valid data.
- The data on the long-term memory screen can be reset by pressing and holding the OK button.
- In case of any discrepancy in the driving information screen, the actual car configuration shall prevail.

Menu setting (7-inch instrument cluster)

When the car speed is zero with the engine start/stop button set to "ON" position, press the ◀ or ▶ button on the right of the steering wheel to switch to the menu setting screen, where you can turn the OK button upward or downward to move the cursor for selection, press the OK button to enter the sub-menu, and then press the OK button for selection, confirmation or cancellation.

i NOTE

- If menu setting is carried out when the car speed is not zero, the warning message "Safe driving tip: setting needs to be performed when the car stops" will be displayed; if the warning message appears for more than 5 s, the instrument cluster will automatically switch to the driving information screen.
- In case of any discrepancy in the menu setting, the actual car configuration shall prevail.

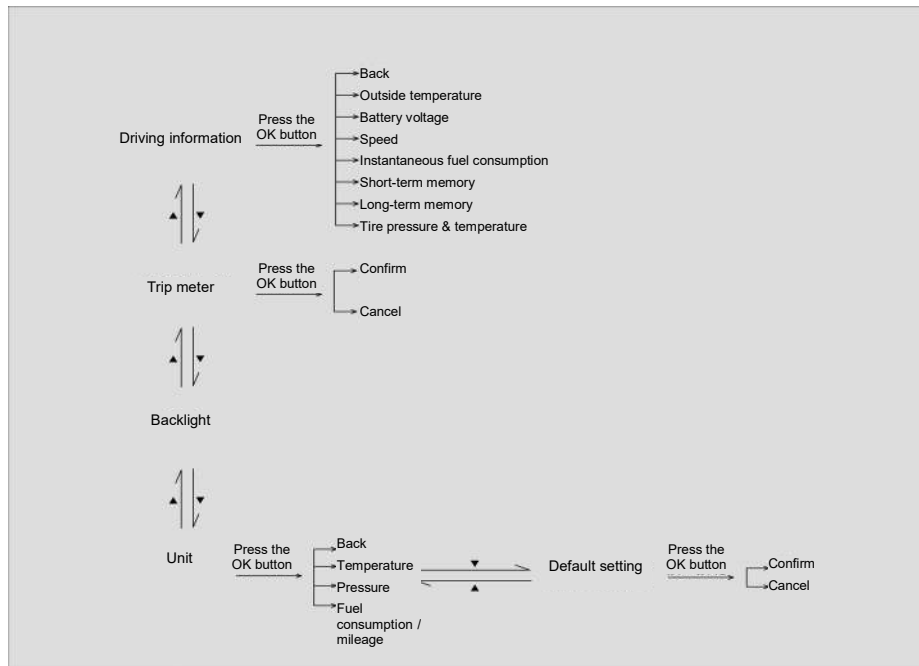

4. Operation of Systems and Equipment

Alarm message

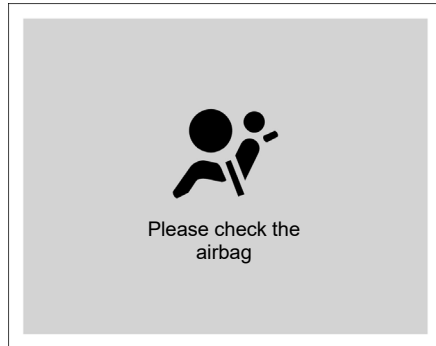

On the alarm message screen, the current state of the car is displayed in the form of texts or pictures. The driver should always pay attention to checking for alarm message.

- When the car is abnormal with the engine start/stop button set to "ON" position, the instrument cluster will give priority to the display of the alarm message, where you can press the OK button to confirm the alarm message, after which the system will go back to the previous screen. If the system has been idle for 5 s, the alarm message is displayed again.

- If the car is in good condition and there is no alarm message, the alarm message screen will display "No message".

i NOTE

When multiple alarm messages exist, be sure to read and confirm them one by one before the system returns to the previous screen.

AV and entertainment information *

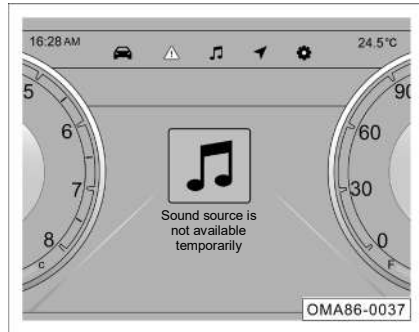

- When the engine start/stop button is at "ON" position, press the ◀ or ▶ button on the right of the steering wheel to switch to the AV and entertainment information screen. When the AV system is not turned on, the words "Sound source is not available temporarily" are displayed on the AV and entertainment information screen.

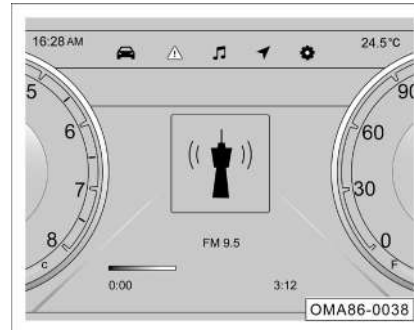

- When the AV system is not turned on, the current playback information is displayed on the AV and entertainment information screen.

ADAS *

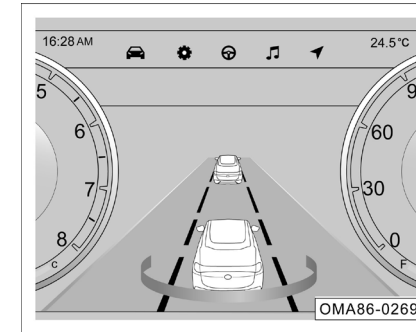









- This screen is not displayed except when the car activates ADAS.

i NOTE







The ACC, FCWS, LDWS, and ICA information are displayed on this screen.

4. Operation of Systems and Equipment













4.1.3 Indicator lamp

Number	Indicator	Designation	Color	Function
1		Charging system alarm lamp	Red	This warning lamp comes on when the engine is not started with the engine start/stop button set to "ON" position; after the engine is started, this warning lamp goes out.
				If this warning lamp comes on after the engine is started, it indicates that the charging system is faulty.
2		Low oil pressure alarm lamp	Red	This warning lamp comes on when the engine is not started with the engine start/stop button set to "ON" position; after the engine is started, this warning lamp goes out.
				If this warning lamp comes on after the engine is started, it indicates that the engine oil pressure is insufficient.
3		MIL	Yellow	When the engine is not started with the engine start/stop button set to "ON" position, if there is no fault, this indicator lamp comes on for a few seconds, and goes out after the system self-test.
				If this indicator lamp comes on after the engine is started, it indicates that the engine system is faulty.
4		Emission fault indicator lamp	Yellow	This indicator lamp comes on when the engine is not started with the engine start/stop button set to "ON" position; after the engine is started, this indicator lamp goes out.
				If this indicator lamp comes on after the engine is started, it indicates that the exhaust system is faulty.
5		High engine coolant temperature indicator lamp	Red	If the red indicator lamp comes on, it indicates that the engine coolant temperature is too high.
6		IMMO indicator lamp	Red	If the red indicator lamp comes on, it indicates that the engine immobilizer system or the body anti-theft system is working.
7		Supplemental restraint system (SRS) indicator lamp	Red	If the red indicator lamp comes on, it indicates that the SRS system is faulty.
8		Low fuel level indicator lamp	Yellow	If the yellow indicator lamp flashes, it indicates that the fuel level of the fuel tank is low.
				If the yellow indicator lamp comes on, it indicates that the fuel pump may be faulty.





4. Operation of Systems and Equipment

Number	Indicator	Designation	Color	Function
9		LDWS status indicator lamp *	White	If the white indicator lamp comes on, it indicates that the lane departure warning system is activated.
			Red	If the red indicator lamp comes on, it indicates that the lane departure warning system is faulty. In that case, please go to the GAC Motor authorized shop for inspection in time.
			Green	If the green indicator lamp comes on, it indicates that the lane departure warning system is working normally or that the lane departure warning system intervenes with the steering wheel for deviation correction.
10		FCWS status indicator lamp *	Green	If the green indicator lamp comes on, it indicates that the forward collision warning system is activated.
			Red	If the red indicator lamp comes on, it indicates that the forward collision warning system is faulty. In that case, please go to the GAC Motor authorized shop for inspection in time. If the red indicator lamp flashes, it indicates that the forward collision warning system is being triggered and activated.
11		ACC indicator lamp (no vehicle ahead) *	White	If the white indicator lamp comes on, it indicates that the ACC is in the ready state, and there is no target vehicle ahead.
			Green	If the green indicator lamp comes on, it indicates that the ACC is working, and there is no target vehicle ahead.
12		ACC indicator lamp (a vehicle ahead) *	White	If the white indicator lamp comes on, it indicates that the ACC is in the ready state, and there is a target vehicle ahead.
			Green	If the green indicator lamp comes on, it indicates that the ACC is working, and there is a target vehicle ahead.
13		ACC fault indicator lamp *	Yellow	If the yellow indicator lamp comes on, it indicates that the ACC is faulty.
14		Right turn signal and hazard warning indicator lamp	Green	If the right turn signal indicator lamp flashes alone, it indicates that the right turn signal lamp of the car is on. When the hazard warning lamp switch is pressed, the left / right turn signal indicator lamps and all turn signal lamps outside the car will flash simultaneously.

4. Operation of Systems and Equipment

Number	Indicator	Designation	Color	Function
15		Left turn signal and hazard warning indicator lamp	Green	When the left turn signal indicator lamp flashes alone, it indicates that the left turn signal lamp of the car is on. When the hazard warning lamp switch is pressed, the left / right turn signal indicator lamps and all turn signal lamps outside the car will flash simultaneously.
16		Electric park brake (EPB) status indicator lamp	Red	If the red indicator lamp comes on, it indicates that the EPB is applied. If the red indicator lamp flashes, it indicates that the EPB is engaged partially or faulty.
			Green	If the green indicator lamp comes on, it indicates that the EPB is activated.
17		Electric park brake (EPB) fault indicator lamp	Yellow	If the yellow indicator lamp comes on, it indicates that the EPB system is faulty.
				If the yellow indicator lamp flashes, it indicates that the EPB is in the service mode.
18		Parking brake and brake system indicator lamp	Red	If the red indicator lamp comes on, it indicates that the brake fluid is too low or the electronic brake force distribution (EBD) system is faulty.
19		Electronic stability program (ESP) indicator lamp	Yellow	If the yellow indicator lamp comes on, it indicates that the ESP is faulty.
				If the yellow indicator lamp flashes, it indicates that the ESP is working.
20		ESPOFF indicator lamp	Yellow	If the yellow indicator lamp comes on, it indicates that the ESP is off.
21		Anti-lock braking system (ABS) indicator lamp	Yellow	If the yellow indicator lamp comes on, it indicates that the ABS or HHC system is faulty.
22		Transmission fault indicator lamp	Yellow	If the yellow indicator lamp comes on, it indicates that the transmission system is faulty.
				If the yellow indicator lamp flashes, it indicates that the transmission fluid temperature is high.
23		Tire pressure monitoring system (TPMS) indicator lamp	Yellow	If the yellow indicator lamp comes on, it indicates that the TPMS is faulty.
24		Electric power steering (EPS) indicator lamp	Yellow	If the yellow indicator lamp comes on, it indicates that the EPS system is faulty.
25		Front passenger seat belt indicator lamp	Red	If the red indicator lamp comes on, it indicates that the front passenger's seat belt is not fastened or the system is faulty.
26		Driver's seat belt indicator lamp	Red	If the red indicator lamp comes on, it indicates that the driver's seat belt is not fastened or the seat belt system is faulty.

4. Operation of Systems and Equipment

Number	Indicator	Designation	Color	Function
27		High beam indicator lamp	Blue	If the blue indicator lamp comes on, it indicates that the high beam is on.
28		Position lamp indicator lamp	Green	If the green indicator lamp comes on, it indicates that the position lamp, instrument panel lamp, license plate lamp, ambient lamp, etc. are on.
29		Rear fog lamp indicator lamp	Yellow	If the yellow indicator lamp comes on, it indicates that the rear fog lamp is on.
30		Intelligent high beam indicator lamp *	White	If the white indicator lamp comes on, it indicates that the intelligent high beam is activated.
			Yellow	If the yellow indicator lamp comes on, it indicates that the intelligent high beam is faulty.

Note: If any indicator or warning lamp appears in the instrument cluster after the car is started or during driving, it indicates that the related system or function is in a certain working state or faulty. You should read carefully and understand the meaning of each indicator or warning lamp. In case of a fault, please go to or contact the GAC Motor authorized shop for inspection in time.

4. Operation of Systems and Equipment

4.2 Car locking and unlocking

4.2.1 Remote key

This model is accompanied with the intelligent remote control key (including emergency mechanical key) and the corresponding key barcode. If the key needs to be re-customized or the key barcode is missing, please contact GAC Motor authorized shop.

Poor signal strength of remote control key

The operation of the remote control key button may be interfered or unstable in the following cases:

- Nearby equipment is emitting strong radio waves.
- The remote control key is carried together with telecommunication equipment, laptop, mobile phone, access control card or wireless signal transmitter.
- The remote control key is put together with magnetic cards (such as bank card and bus card).
- Metal objects contact or cover the remote control key.

NOTE

The remote control key contains an electronic circuit that can trigger the engine immobilizer system. If the circuit is damaged, the engine may not be started. Therefore,

- Avoid placing the remote control key in direct sunlight or in a high-temperature or humid place.
- Avoid dropping the remote control key from a high place or crushing it by heavy objects.
- Avoid exposing the remote control key to any liquid. If the key gets wet accidentally, dry it immediately.

NOTE

- The buttons of the remote control key cannot be operated when the engine start/stop button is in the "ACC" or "ON" position.
- If the unlocking or locking function of the remote control key is deactivated, you can try to press the buttons on the remote control key 3 times continuously to activate the function.

Button operations

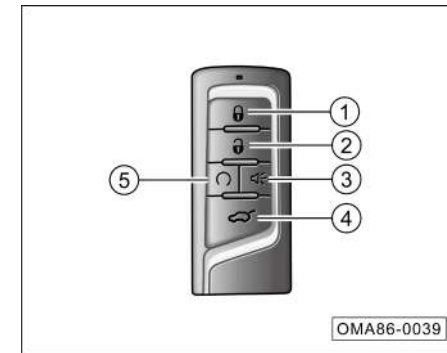

- ①: Locking button
- ②: Unlocking button
- ③: Anti-theft alarm button
- ④: Trunk lid unlocking button
- ⑤: Engine start/stop button

① Locking button

- If this button is pressed once within the effective range, all doors will be locked; if this button is pressed and held for 2 s, the windows * will be automatically closed, and if pressed and held for 3 s, the sunroof will be automatically closed; if the button is released when the windows or the sunroof is being closed automatically, the windows or the sunroof will stop moving.
- If this button is pressed continuously within 0.5 s, the car locating function will be realized and the turn signal lamps will flash 3 times quickly.

NOTE

Before closing the windows or the sunroof by the remote control key, make sure that there are no body parts (such as head and hands) in the movement path of the windows or the sunroof so as to prevent a risk of pinch injury.

NOTE

- If this button is pressed and held for 2 s, either the driver's door window or all the four door windows will be automatically closed for different car models, which subject to the actual car configurations.
- The remote control function can be activated or deactivated by setting the AV system "System Settings → Body Accessories → Other Accessories → Remote Control Windows & Sunroof (Car Settings → Intelligent Body → Remote Control Windows & Sunroof)".
- When the doors are locked, the turn signal lamps will flash once and the horn will sound once. The horn prompt can be activated or deactivated by setting the AV system "System Settings → Sound Settings → System Sounds → Unlock/Lock Horn Prompt (System Settings → Sounds → Unlock/Lock Horn Prompt)".

② Unlocking button

- If this button is pressed once within the effective range, all doors will be unlocked; if this button is pressed and held for 2 s, the windows * will be automatically opened, and if pressed and held for 3 s, the sunroof will be automatically opened; if the button is released when the windows or the sunroof is being opened automatically, the windows or the sunroof will stop moving.

NOTE

- The remote control key cannot control the tilting of the sunroof.
- If this button is pressed and held for 2 s, either the driver's door window or all the four door windows will be automatically opened for different car models, which subject to the actual car configurations.
- When the doors are unlocked, the turn signal lamps will flash twice and the horn will sound twice. The horn prompt can be activated or deactivated by setting the AV system "System Settings → Sounds → Unlock/Lock Horn Prompt".

4. Operation of Systems and Equipment



NOTE

- The remote control function can be activated or deactivated by setting the AV system "System Settings → Body Accessories → Other Accessories → Remote Control Windows & Sunroof (Car Settings → Intelligent Body → Remote Control Windows & Sunroof)".
- The driver's door or all the four doors can be unlocked by setting the  button through "System Settings → Body Accessories → Lock/Unlock → Remote Unlock (Car Settings → Intelligent Body → Remote Unlock)".

NOTE

After the  button is pressed to unlock the door, if the door is not opened within 30 s, the system will re-lock the door.



③ Anti-theft alarm button

- If the  button is pressed and held for 3 s, the anti-theft alarm will be triggered, then the horn will sound and the turn signal lamps will flash for 30 s; if the  or  button is pressed, the anti-theft alarm will be stopped.



④ Trunk lid unlocking button

- If this button is pressed and held for 2 s within the effective range, the trunk lid will be unlocked.

⑤ Engine start/stop button



- Within the effective range, if the  button is pressed and then the  button is pressed and held within 5 s, the turn signal lamps will flash and the engine can be remotely started.
- Then if the  button is pressed and held for 3.5 s, the engine can be remotely stopped.

NOTE

- Before remotely stopping the engine, make sure that the car is in the locked state, and if you are not sure about it, press the  button once, and then press and hold the  button to remotely stop the engine.
- To remotely stop the engine, keep the key within the effective range, otherwise the unlocking function may be triggered and then the engine cannot be started.
- The maximum default start hold duration is 5 min. If you need to change the duration, please go to GAC Motor authorized shop to change it; if your car is equipped with GAC Motor application, you can log in the application to change this duration.

Switching between audible-visual alarm and visual alarm

The visual alarm is to remind the owner of the car only through the flashing of the turn signal lamps; the audible-visual alarm is to remind the owner of the car through both the flashing of the turn signal lamps and the sounding of the horn.

When the engine start/stop button is in the "OFF" position, if the  and  buttons on the remote control key are pressed and held for 2 s at the same time, the audible-visual alarm and the visual alarm can be switched between each other. If the switching is successful, the turn signal lamps will flash 3 times (only for electronic anti-theft alarm).

NOTE

The switching function is only applicable to the anti-theft alarm. For details, please refer to the basic operations of body anti-theft=> [See Page 72.](#)

Battery replacement

Each time you press the buttons on the remote control key, the indicator lamp of the key will flash once. If the indicator lamp fails to flash, or you need to press the buttons several times to lock or unlock the doors, the battery may be exhausted or about to run out. It is recommended to go to GAC Motor authorized shop for the battery replacement.

NOTE

- Be sure to replace the battery with a new one of the same rated voltage and size.
- An inappropriate battery may damage the remote control key.
- Always comply with relevant environmental regulations to dispose the exhausted battery.

Battery replacement steps

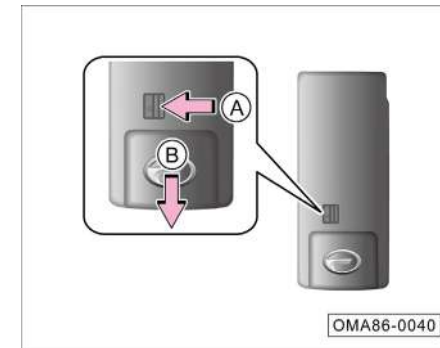

- Pull the switch in the direction of arrow A and pull out the emergency mechanical key in the direction of arrow B.

4. Operation of Systems and Equipment

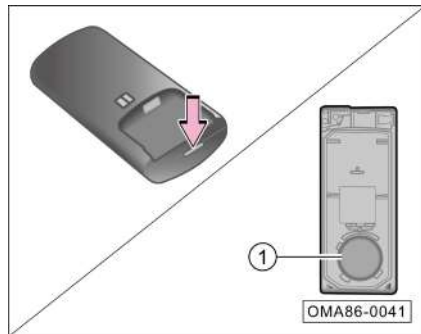

- Use the emergency mechanical key to pry open the remote control key housing at the arrow position.
- Take out the battery ①.
- Assemble the remote control key in the reverse steps mentioned above.

4.2.2 Emergency mechanical key

Emergency mechanical key

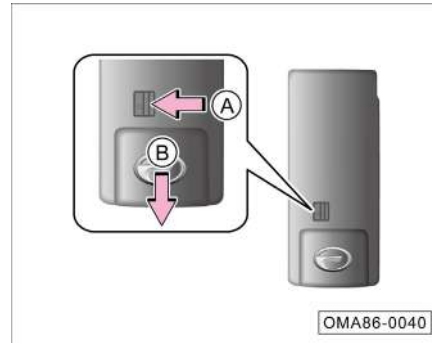



- Pull the switch in the direction of arrow A and pull out the emergency mechanical key in the direction of arrow B.
- The emergency mechanical key can be used to lock all doors or unlock the driver's door, but cannot be used to start the car.

4.2.3 Door lock system

Central locking control button



- The central locking control button ① can be used to lock and unlock the doors in the car:
- Lock all the doors: Press the  button of ①.
 - Unlock all the doors: Press the  button of ①.

Door latch and inside handle

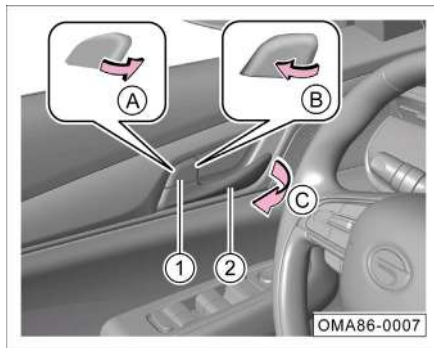

- If the door latch ① is pushed in the direction of arrow A, the corresponding door can be locked.
- If the door latch ① is pulled out in the direction of arrow B, the corresponding door can be unlocked; then if the inside handle ② is pulled in the direction of arrow C, the door can be opened.

NOTE

When the child safety lock is activated (=> see [Page 57](#)), even if the rear door latch is unlocked, the inside handle cannot open the rear door. In this case, the rear door shall be opened from outside. And do not pull the inside handle with force to avoid damages.

NOTE

After the door latch is locked, please do not forcibly pull the inside handle.

Door lock hole

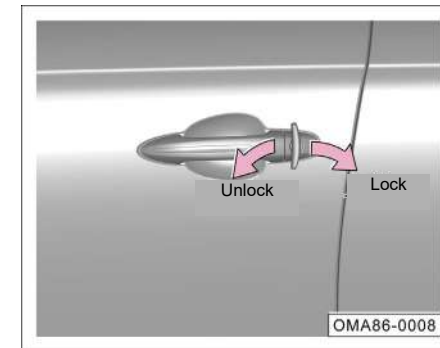



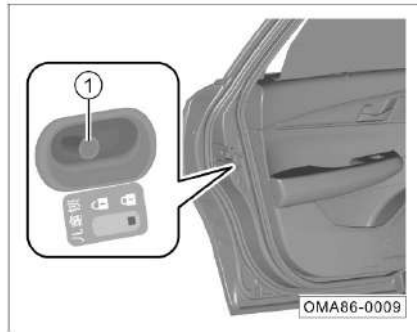

- Take out the emergency mechanical key.=> [See Page 55](#)
- Insert the emergency mechanical key into the driver's door lock hole.
- Turn the key clockwise to lock all the doors.
- Turn the key counterclockwise to unlock the driver's door only.

4. Operation of Systems and Equipment

Child safety lock



– Activation: Turn the child safety lock switch ① from  to  position to activate the child safety lock.

– Deactivation: Turn the child safety lock switch ① from  to  position to deactivate the child safety lock.

NOTE

- The child safety lock can prevent children in the car from unintentionally opening the rear door and thus reduce the risk of accidents.
- When the child safety lock is activated, the inside handle cannot open the rear door. In this case, the rear door shall be opened from outside. And do not pull the inside handle with force to avoid damages.

WARNING

Never leave children or handicapped persons in the car alone. Once the doors are locked, it is difficult for children or handicapped persons to leave the car in an emergency; the locked doors in an accident will make it more difficult to rescue persons inside the car.

Automatic unlock function

If the traveling car stops with the doors locked and the engine start/stop button is switched to the "OFF" position, the four doors will be automatically unlocked.

NOTE

This function can be activated or deactivated by setting the AV system "System Settings → Body Accessories → Lock/Unlock → Auto Unlock (Car Settings → Intelligent Body → Auto Unlock)".

Collision unlock function

If the car encounters a collision while the engine start/stop button is in the "ON" position and the required conditions are met, the four doors will be simultaneously unlocked, and after 3 s will be simultaneously unlocked again.

Intelligent active unlock

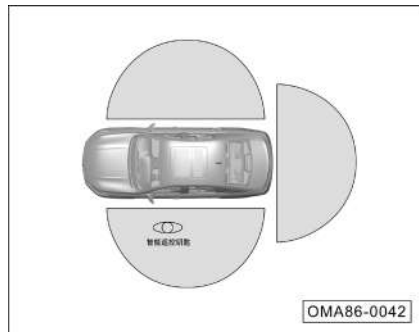

- When the intelligent active unlock function is activated and the intelligent remote control key is brought close to the left and right doors, the car will be automatically unlocked and the exterior rearview mirrors* will be automatically unfolded.

i NOTE

- This function can be activated or deactivated by setting the AV system “System Settings → Body Accessories → Lock/Unlock → Intelligent Active Unlock (Car Settings → Intelligent Body → Intelligent Active Unlock)”.
- If the intelligent active unlock is successful, the turn signal lamps will flash twice and the horn will sound twice.

Intelligent active lock

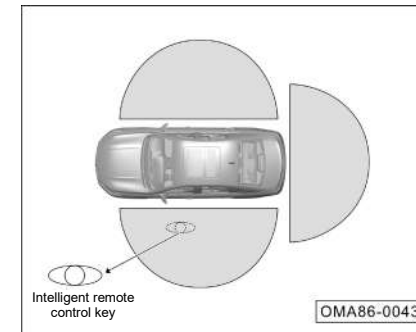

- When the intelligent active lock function is activated, the engine start/stop button is in the “OFF” position and all doors are closed, if the intelligent remote control key is taken away from the car within 2 m for more than 2 minutes or more than 2 m, the car will be automatically locked and the exterior rearview mirrors* will be automatically folded.
- If the key is taken away from the car within 2 m for more than 2 minutes, the system will temporarily deactivate the intelligent active lock function for the purpose of power saving; the user needs to open and then close one of the doors to re-activate the intelligent active lock function.

4. Operation of Systems and Equipment

- If the intelligent active lock function is activated and the key is taken away from the car within 2 m, the indicator lamp of the intelligent remote control key will flash continuously until the doors are locked.

NOTE

- This function can be activated or deactivated by setting the AV system "System Settings → Body Accessories → Lock/Unlock → Intelligent Active Lock (Car Settings → Intelligent Body → Intelligent Active Lock)".
- If the intelligent active lock is successful, the turn signal lamps will flash once and the horn will sound once.
- If one of the doors is ajar, there will be a corresponding indication on the instrument cluster.

NOTE

- If the user approaches the car within 3 s after the intelligent active lock is activated, the system will not activate the intelligent active unlock but will consider that the user wants to confirm whether the car is locked. The user can confirm whether the doors are locked by pulling the rear door handles.

It should be noted that the intelligent active lock function will not be activated in case of the followings:

- The power mode is in any mode other than "OFF".
- The battery voltage is low.
- The intelligent remote control key is in the car.
- No intelligent remote control key is detected within 2 m of the car.

- One of the doors is ajar.
- The intelligent remote control key is thrown into the car from the door window.
- The intelligent remote control key is in the trunk.
- The intelligent remote control key is too close to the car.

NOTE

- The intelligent active lock function cannot automatically close the door windows and the sunroof, so before leaving the car, make sure that all door windows and the sunroof are closed.
- Do not leave children or handicapped persons in the car alone when using the intelligent active lock function.

PEPS system*

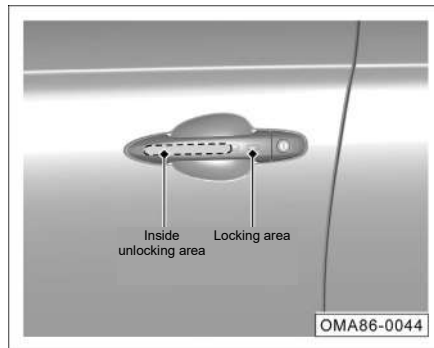

- When the engine start/stop button is in the "OFF" position, if you bring the intelligent remote control key to approach the car doors and put your hand into the unlocking area inside the front door handle, all the doors will be unlocked after effective induction.
- When the engine start/stop button is in the "OFF" position, if you take the intelligent remote control key from the car, close all the doors and touch the locking area, all the doors will be locked after effective induction.

NOTE

- After using the PEPS function to lock the doors, please wait for 5 s before using it again to unlock the doors.
- If you touch the unlocking and locking areas at the same time, priority will be given to the unlocking function, so please do not touch them at the same time.
- If there is snow or ice on the front door handle, the PEPS function will be affected, so please clear the snow or ice as soon as possible.
- If the front door handle gets wet and the intelligent remote control key is within the effective range during heavy rain or car washing, the doors may be unlocked.

NOTE

- If you touch the front door handle while wearing gloves, the door sensor may slowly respond to or may not respond to unlock the doors.
- If you grab the front door handle and pull it immediately, the doors may not be opened. Please grab the handle again and confirm that the doors are unlocked, and then pull the handle.
- Even within 1 m, if the intelligent remote control key is higher or lower than the front door handle, the PEPS system may fail to lock/unlock the doors.
- If the intelligent remote control key is too close to the doors and the door windows, the PEPS system may not work properly; if the working distance of the remote control transmitter changes, the battery power may be low.

4. Operation of Systems and Equipment

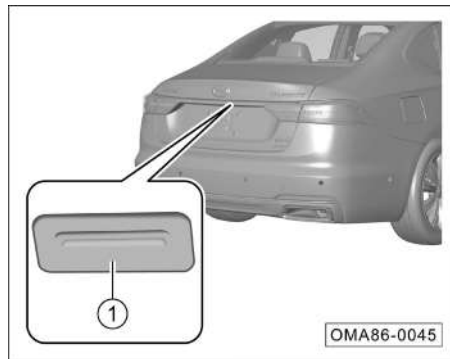

- When the engine start/stop button is in the "OFF" position, if you bring the intelligent remote control key to approach the trunk lid and then press the trunk lid unlocking button ①, the trunk lid will be opened.
- When the car is in unlocked and stationary state, if you press the trunk lid unlocking button ① directly without carrying the intelligent remote control key, the trunk lid will also be opened.

4.2.4 Door



- To close the door in the car, grab the door armrest and pull it inward.
- To close the door outside, directly push the door toward the car.

NOTE

Before opening the door, always pay attention to other vehicles or pedestrians outside the car to avoid accidents caused by collision.

WARNING

- Make sure that all doors are closed before driving, otherwise the doors ajar will be opened unintentionally during driving, causing accidents or personal injuries.
- Open or close the doors only when the car is stationary.
- Do not put your hands on the edge of the door when closing the door, otherwise there will be a risk of pinching.

NOTE

- If the door is not closed properly, please re-open the door and close it again.
- If the door is ajar, there will be a corresponding indication on the instrument cluster; then when the car speed exceeds 5 km/h, there will be a buzzer sound.

4.2.5 Trunk lid

Unlocking of trunk lid

1. Use the remote control key: When the engine start/stop button is in the "OFF" position, if you press the  button on the remote control key for about 2 s within the effective range, the trunk lid will be unlocked.
2. Use the PEPS function: If you carry the intelligent remote control key within about 1 m away from the trunk and then press the trunk lid unlocking button, the trunk lid will be unlocked. => [See Page 61](#)

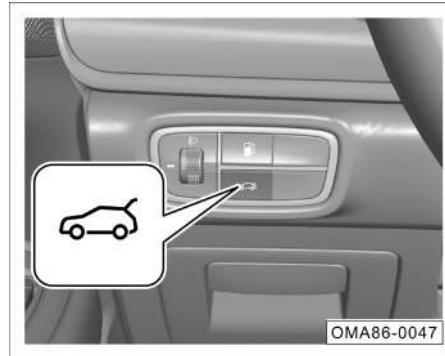



3. Use the instrument panel button: If you press and hold the trunk lid unlocking button , the trunk lid will be unlocked.

Easy Open function of trunk lid*

When the engine start/stop button is in the "OFF" position and the four doors are closed, if the user carries the intelligent remote control key to enter the trunk Easy Open area, about 0.5 m away from the trunk, the horn will sound once (with the horn prompt function activated by setting the AV system), and the high-mounted stop lamp will flash at the same time. In this case, if the user stays or steps backward, the trunk lid will be unlocked. If the user leaves the trunk area while the high-mounted stop lamp is flashing, the trunk lid will not be unlocked.

4. Operation of Systems and Equipment

i NOTE

- This function can be activated or deactivated by setting the AV system "System Settings → Body Accessories → Lock/Unlock → Trunk Easy Open".
- If you carry the intelligent remote control key to approach the trunk within about 0.5 m, the high-mounted stop lamp will flash 4 times, and after 3.2 s, the trunk will be unlocked. If you don't want to open the trunk, just leave the trunk area within 3.2 s or press the  button on the intelligent remote control key to temporarily deactivate this function.
- If you want to re-activate the trunk Easy Open function after deactivating it by the  button on the intelligent remote control key, you need to open and then close one of the front doors.

Emergency unlocking of trunk lid

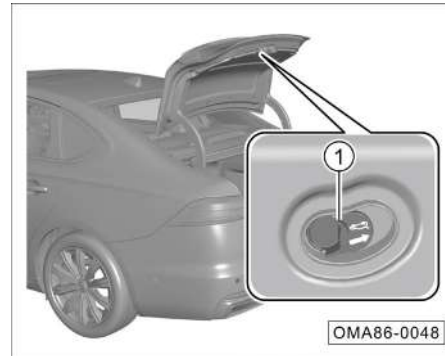

Any person trapped in the trunk can try to open the trunk lid in the car in case of an emergency:

- Push the emergency unlocking button ① to unlock the trunk lid.

Locking of trunk lid



- Lower the trunk lid close to the rear bumper cover, and then press the trunk lid firmly to lock it.

i NOTE

If the trunk lid is ajar, there will be a corresponding alarm indication on the instrument cluster; then when the car speed exceeds 5 km/h, there will be a buzzer sound.

👁 NOTE

- Be careful when closing the trunk lid to ensure that no person is within the movement range of the trunk lid.
- Always ensure that the closed trunk lid is locked to prevent suddenly opening during driving, which may cause an accident.

4.2.6 Engine hood

Unlocking of engine hood

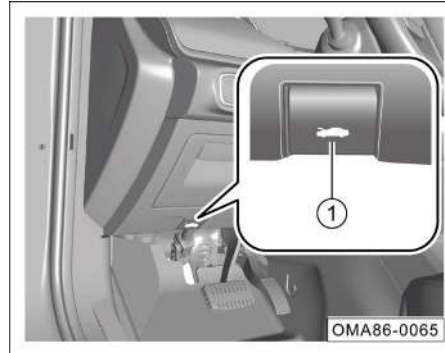

- If the engine hood release handle ① is pulled, the engine hood will be unlocked and pop up slightly.

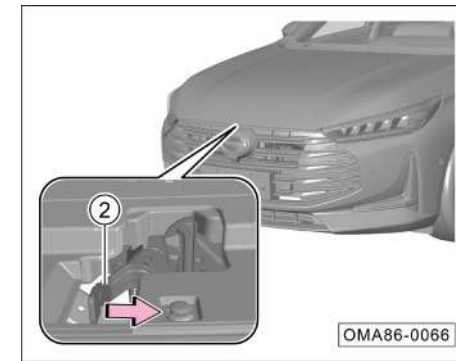

- If the locking mechanism ② is pushed as arrowed, the engine hood will be fully unlocked.
- If the engine hood is opened upward, the stay bar will automatically support the engine hood at the limit position.

4. Operation of Systems and Equipment

Locking of engine hood

- Lower the engine hood to a height close to the fenders, and then slightly press down the front end of the engine hood for firm locking.

i NOTE

Proper lubrication of the locking mechanism moving parts of the engine hood is helpful for opening or closing the engine hood.

If the engine hood is ajar, there will be a corresponding alarm indication on the instrument cluster; then when the car speed exceeds 5 km/h, there will be a buzzer sound.

4.2.7 Power window

The power window can be operated when the engine start/stop button is in the "ON" position, and within 40 s after the engine start/stop button is switched from the "ON" position to the "ACC" or "OFF" position, but cannot be operated if one of the doors is opened within the 40 s.

i NOTE

- Please close all windows before leaving the car.
- Do not put your hands on the edges of the windows when closing the windows, otherwise there will be a risk of pinching.

Driver's side power window control button

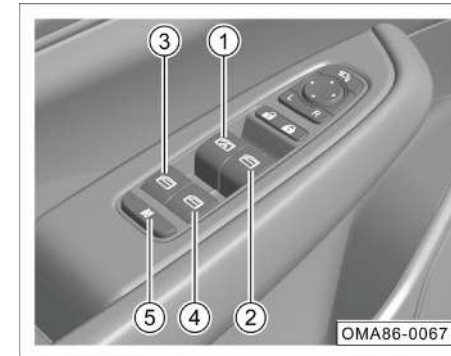

- ① Left front power window button
- ② Right front power window button
- ③ Left rear power window button
- ④ Right rear power window button
- ⑤ Passenger's power window control button

- If the button ① is pulled up to the first stop position, the power window will be lifted for closing until the button is released or the window reaches the highest position.
- If the button ① is pulled up to the limit position, the power window will be lifted automatically for closing until the window reaches the highest position.
- If the button ① is pressed down to the first stop position, the power window will be lowered for opening until the button is released or the window reaches the lowest position.
- If the button ① is pressed down to the limit position, the power window will be lowered automatically for opening until the window reaches the lowest position.

i NOTE

If you want to stop the window during the automatic lifting or lowering, just press down/pull up the button ①.

- The operation methods of the buttons ②, ③ and ④ are the same as that of the button ①, only corresponding to the respective windows.

i NOTE

The four-door windows have the express-up and down feature (with anti-pinch function) or only the driver's window has the express-up and down feature (with anti-pinch function), which subject to the actual car configurations.

- If you press the passenger's power window control button ⑤, the button indicator lamp will come on and the passenger's power windows cannot be operated anymore. If you press this button again, this function will be deactivated and the button indicator lamp will go out.

Passenger's power window control button

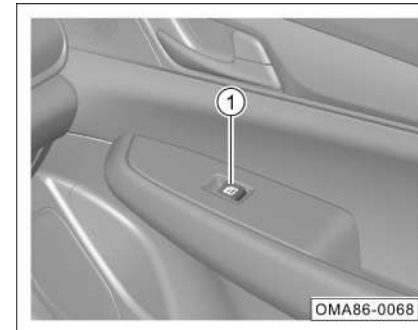

- For the operation methods of the passenger's power window control button ①, please refer to the driver's power window control button.

4. Operation of Systems and Equipment

Initialization of anti-pinch function

The power window shall be re-initialized if the power window regulator is not equipped and the anti-pinch function is invalid, or if the initialization is automatically invalid because the anti-pinch function is triggered multiple times in a short period of time.

1. Pull up the power window button, and then the window is lifted in steps until it is completely closed.
2. After the window is completely closed, continue to pull up the power window button and hold it for 2~3 s to complete the initialization.

WARNING

- **If the window has no anti-pinch function during the initialization learning process, please do not use any part of your body or other objects to hinder the closing of the window, otherwise it will cause personal injury and affect the result of the initialization learning.**
- **If the power window system fails, please go to the GAC Motor authorized shop for inspection in time.**

4.2.8 Electric sunroof

The electric sunroof can be operated when the engine start/stop button is in the "ON" position, and within 40 s after the engine start/stop button is switched from the "ON" position to the "ACC" or "OFF" position, but cannot be operated if one of the doors is opened within the 40 s.

NOTE

When the engine start/stop button is in the "OFF" position with the electric sunroof not closed and the driver's door opened, the instrument cluster will display the message "Sunroof Open" and send a buzzer sound; in this case, be sure to check whether the sunroof is closed.

NOTE

Please close the sunroof, otherwise there will be a risk of water ingress.

Sun visor*



- Automatic opening: The sun visor will be automatically opened as the sunroof is opened.
- Manual opening: Just push the sun visor backward.
- Manual closing: Just push the sun visor forward after the electric sunroof is closed.

Electric sunshade*



- If you press the switch ①, the electric sunshade will move a short distance for slight opening and then stop.
- If you press the switch ②, the electric sunshade will move a short distance for slight closing and then stop.
- If you press and hold the switch ① for several seconds, the electric sunshade will be fully opened automatically.
- If you press and hold the switch ② for several seconds, the electric sunshade will be fully closed automatically.

i NOTE

- The electric sunshade will be automatically opened as the sunroof is opened.
- The electric sunshade will be automatically closed as the sunroof is closed.
- If the switch ① or ② is pressed during the automatic opening or closing of the electric sunshade, the electric sunshade will stop at the current position.

Opening or closing of sunroof



- If you push the sunroof switch ① backward, the sunroof will move a short distance for slight opening and then stop.
- If you push the sunroof switch ① forward, the sunroof will move a short distance for slight closing and then stop.

4. Operation of Systems and Equipment

- If you push the sunroof switch ① backward and hold it for several seconds, the sunroof will be fully opened automatically (for ordinary sunroof*).
- If you push the sunroof switch ① backward and hold it for several seconds, the sunroof will automatically move to a comfortable position; if you push the sunroof switch ① backward again, the sunroof will be fully opened (for panoramic sunroof*).
- If you push the sunroof switch ① forward and hold it for several seconds, the sunroof will be fully closed automatically.

i NOTE

- If the sunroof switch ① is pushed during the automatic opening or closing of the sunroof, the sunroof will stop at the current position.
- The designed comfortable position can balance the wind noise generated by the sunroof of the traveling car (for panoramic sunroof*).

Tilting of sunroof



- When the sunroof is fully closed, if you manually open the sun visor (for ordinary sunroof*) and press the  button on the sunroof switch ①, the sunroof will be tilted outward. Just push the sunroof switch ① forward to deactivate the tilting function.

Anti-pinch function of sunroof

The anti-pinch function is available for the closing of the sunroof:

- When the sunroof is closed by sliding, if the anti-pinch function is activated, the sunroof will move in the opening direction for a certain distance and then stop.
- When the sunroof is closed by tilting, if the anti-pinch function is activated, the sunroof will move in the tilting direction until it reaches the maximum tilting position.

NOTE

Do not operate the sunroof when the ambient temperature is below -20°C , at which the anti-pinch function of the sunroof may not be activated, resulting in accidents. In addition, the low temperature will also damage the motor to a certain extent.



WARNING

- **The anti-pinch function of the sunroof cannot prevent pinching of light or thin objects.**
- **When closing the sunroof, make sure that no one is within the movement range of the sunroof to avoid any pinching.**
- **The sunroof will stop detecting obstacles at a position where the sunroof is about to be closed fully, so the anti-pinch function will be deactivated at this time.**
- **Do not try to activate the anti-pinch function by your hand or any part of your body, otherwise there will be a risk of pinching.**

Manual initialization and self-learning of sunroof

Ordinary sunroof*



- When the sunroof is tilted, if you press the  button on the sunroof switch ① upward and hold it for more than 10 s, the sunroof will start to be initialized.
- If you press the  button on the sunroof switch ① upward and hold it (or push the sunroof switch ① forward and hold it), the sunroof will be “closed by tilting → opened by sliding → closed fully” and then will stop, thus completing the self-learning.

4. Operation of Systems and Equipment

4.2.9 Basic operation of body anti-theft system

Body anti-theft function - unlock

When the engine start/stop button is in the "OFF" position and the car is in the anti-theft state, if you bring the intelligent remote control key to approach the car doors and put your hand into the unlocking area inside the front door handle for effective induction or if you unlock the car by remote control, all the doors will be unlocked to release the car from the anti-theft state, and the turn signal lamps will flash twice.

Body anti-theft function - lock

When the engine start/stop button is in the "OFF" position and the four doors, engine hood and trunk lid are closed, if you take the intelligent remote control key away from the car and put your hand into the locking area on the front door handle for effective induction or if you lock the car by remote control, all the doors will be locked to enable the car to enter the anti-theft state, and the turn signal lamps will flash once.

Activation of body anti-theft function

When the engine start/stop button is in the "OFF" position and the car is in the anti-theft state, if the door is unlocked by an illegal key or is forcibly unlocked, the anti-theft system will be activated, the anti-theft horn will sound and the turn signal lamps will flash twice.

When the car is locked by remote control to enter the anti-theft state, if the emergency mechanical key is used to unlock the driver's door, the anti-theft system will trigger the horn sound and the turn signal lamps will flash twice.

Engine immobilizer

When the engine start/stop button is switched from the "OFF" position to the "ON" position with the body anti-theft state released and the legal key in the car, if the engine immobilizer system passes the verification, it will be deactivated.

If the engine immobilizer system does not pass the verification, the engine cannot be started and an immobilizer alarm will be triggered.

Body anti-theft maintenance instructions

No maintenance is required during normal use. If you have any doubt, please contact the GAC Motor authorized shop.

4.3 Lamps and vision

4.3.1 Exterior lamp

Lamp/light combination switch

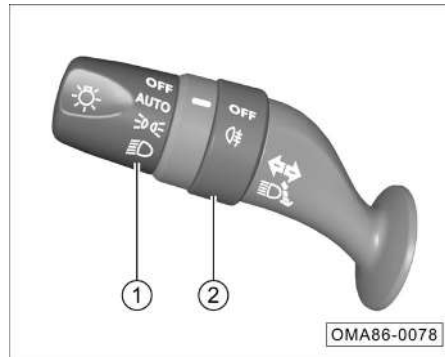

① Light switch

② Fog lamp switch

i NOTE

- Water vapors or even water drops may appear on the inner surfaces of the lamps under certain conditions (such as high air humidity and car washing conditions), similar to the fogging phenomenon on the windows when the car is traveling in the rain, but this is not a malfunction .
- This fogging phenomenon can be eliminated by parking the car in a dry environment, turning on the lamps or driving the car, but may recur.
- If there are a lot of water drops or water ingress in the lamps, please contact the GAC Motor authorized shop for inspection.

4. Operation of Systems and Equipment

Turn signal lamp

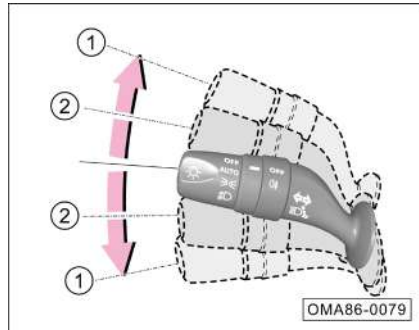

- When the engine start/stop button is in the "ON" position, if you turn the lamplight combination switch up or down to the limit position ① and turn on the right or left turn signal lamp, the corresponding indicator lamp ➡ or ⬅ on the instrument cluster will flash.

Lamp flashing for lane changing

- In case of lane changing or overtaking, if you turn the lamplight combination switch up or down to the position ② and then release it to the original position, the corresponding turn signal lamp and the indicator lamp ➡ or ⬅ on the instrument cluster will flash 3 times.

- If you turn the lamplight combination switch up or down and hold it at the position ②, the corresponding turn signal lamp and the indicator lamp ➡ or ⬅ on the instrument cluster will flash continuously. Releasing the switch to the original position can stop the flashing.

NOTE

If the corresponding indicator lamp ➡ or ⬅ on the instrument cluster flashes faster, one of the turn signal lamps may be faulty, please go to the GAC Motor authorized shop for inspection in time.

Light switch

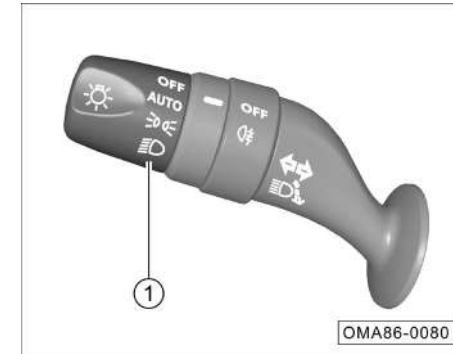

When the engine start/stop button is in the "ON" position, turn the light switch ① to activate or deactivate AUTO (automatic headlamp on/off function)*, (position lamp), and (low beam).

If the light switch is turned to the "OFF" position, all lamps will be turned off.

AUTO (automatic headlamp on/off function)*

- Turn the light switch to the AUTO position to activate the automatic headlamp on/off function.

NOTE

- If the automatic headlamp on/off function is activated, the car will automatically turn on or off the headlamp according to the ambient light. When the ambient light gradually becomes dark, the position lamps and the low beam will be turned on simultaneously; when the ambient light gradually becomes bright, the position lamps and the low beam will be turned off simultaneously.
- This function can be adjusted by setting the AV system "System Settings → Body Accessories → Exterior Light → Automatic Headlamp On/Off Sensitivity".

NOTE

- If the instrument cluster displays "Sensor Failure, Please Manually Control Light", the system will keep the low beam on for the sake of safety. At this time, you should manually control the light and go to the GAC Motor authorized shop for inspection in time.
- The automatic headlamp on/off function may be affected in the haze environment, so please manually control the light in this case.



Daytime running lamp*

- When the engine is started and the position lamps are off, the daytime running lamps can be automatically turned on; when the position lamps are turned on or the engine is shut down, the daytime running lamps can be automatically turned off.

NOTE

This function can be activated or deactivated by setting the AV system "System Settings → Body Accessories → Exterior Light → Daytime Running Lamp (Car Settings → Light Control → Daytime Running Lamp)".

Position lamp

- If you turn the light switch to the  position, the position lamps, instrument panel lamps, license plate lamps and other lamps will be turned on, and the corresponding indicator lamp  on the instrument cluster will come on.

4. Operation of Systems and Equipment

NOTE

If you forget to turn off the position lamps when the engine start/stop button is switched to the "OFF" position and the car is not locked, the position lamps will stay on for 15 min and then go out automatically in order to save the battery power; when the engine start/stop button is switched to the "OFF" position and the car is locked, the position lamps will go out immediately.

WARNING

- **When driving the car at night or on a road with poor visibility, please do not only turn on the position lamps, otherwise, accidents may easily occur.**
- **When temporarily parking the car at night or on a road with poor visibility with the need of indicating the position of the car, do not use the position lamps as the parking lamps but be sure to turn on the hazard warning lamp due to the battery power saving function of the position lamps.**

Low beam

- Turn the light switch to the  position to turn on the low beam.

High beam

- After turning on the low beam, if you push the lamplight combination switch forward to the limit position, the high beam will be turned on and the corresponding indicator lamp  on the instrument cluster will come on.
- If you pull the lamplight combination switch backward to the original position, the high beam will be turned off.

High beam flashing

- If you pull the lamplight combination switch backward to the limit position, the high beam will be turned on.
- If you release the switch, the lamplight combination switch will automatically return to its original position and the high beam will be turned off.

NOTE

- The high beam may cause dazzling to drivers of oncoming vehicles at close range, which may easily cause accidents. Therefore, please use the high beam reasonably.
- When all the lamps are turned off, if you pull and hold the lamplight combination switch backward, the high beam will stay on, and the corresponding indicator lamp  on the instrument cluster will come on.

Headlamp leveling knob*



Rotate the knob ① to manually level the headlamp (low beam) at 0, 1, 2 and 3 positions. The level of the headlamp will decrease as the adjustment value increases.

Position lamp warning

When the engine start/stop button is switched to the "OFF" position with the position lamps turned on, if you open the driver's door, the system will send a buzzer sound and the instrument cluster will display the message "Lamp On".

Headlamp delay off (follow me home) function

Within 10 minutes after switching the engine start/stop button to the "OFF" position, if you turn the light switch from the OFF position to other positions and then back to the OFF position within 2 s, the headlamp delay off function will be activated. In this case, the low beam will stay on for 30 s, within which if one of the doors (including four doors, engine hood and trunk lid) is opened, this function will be re-timed, and then the low beam will stay on for 80 s, within which if all the doors are closed, this function will be re-timed again, and then the low beam will stay on for 30 s repeatedly.

i NOTE

This function can be activated or deactivated by setting the AV system "System Settings → Body Accessories → Exterior Light → Follow Me Home (Car Settings → Light Control → Follow Me Home)".

Fog lamp switch

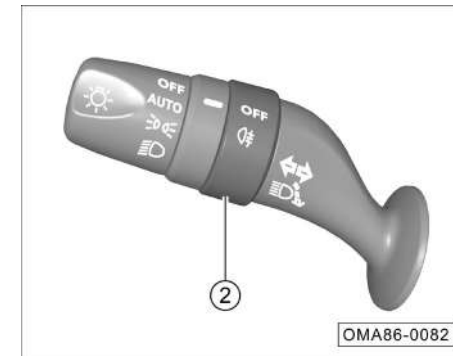



When the engine start/stop button is in the "ON" position with the position lamp or low beam turned on, turn the fog lamp switch ② to turn on or off the  (rear fog lamp).

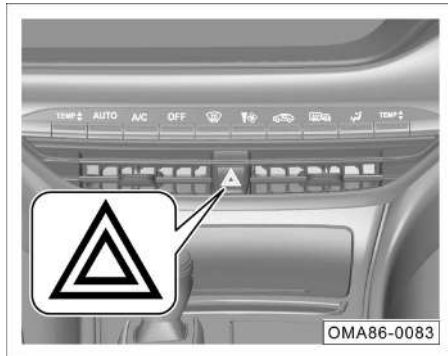

- After the fog lamp switch ② is turned to the  position and then released to the OFF position, the rear fog lamp will come on. Turn the fog lamp switch ② again to turn off the rear fog lamp.

4. Operation of Systems and Equipment

Hazard warning lamp



When the engine start/stop button is in any position, if you press the switch , the switch red indicator lamp will flash and the hazard warning lamp will be turned on. Press this switch again to turn off the hazard warning lamp.

If the hazard warning lamp is turned on, all turn signal lamps and the indicator lamps  and  on the instrument cluster will flash simultaneously.

The hazard warning lamp shall be turned on in the following cases so as to attract the attention of persons on the road and reduce the risk of traffic accidents:

- The car is involved in any failure.
- The car is at the tail end of a traffic jam.
- The car tows another car or is towed.
- The car is temporarily parked due to poor visibility.



NOTE

- The use of the hazard warning lamp will consume the battery power, so please turn it off when not in use.
- Be sure to strictly abide by the relevant regulations when using the hazard warning lamp.
- In the event of an emergency, if the hazard warning lamp is faulty, other methods that comply with the relevant traffic rules and regulations must be taken to attract the attention of persons on the road.

Emergency brake warning lamp

- When the car is traveling at a high speed and the emergency brake is applied, the brake lamps will come on and the turn signal lamps will flash.

Car assisted lighting

- If you press the unlock button  on the remote control key within the effective range, the position lamps will stay on for 25 s for the purpose of helping you to approach your car. If you press the unlock button  on the remote control key again, the position lamps can stay on for another 25 s. When the engine start/stop button is switched to the "ON" position, the position lamps will go out.

Car locating lighting

- If you press the lock button  on the remote control key twice within 0.5 s, the position lamps will stay on for 8 s and the turn signal lamps will flash 3 times for the purpose of helping you to locate your car.

Intelligent courtesy lamp*

- When the engine start/stop button is in the "OFF" position with all doors closed and locked, if you bring the intelligent remote control key to approach the car, the courtesy lamp* and the position lamps will come on automatically, and then if you don't open the door or take away the intelligent remote control key within 25 s, the lamps will go out automatically.

i NOTE

This function can be activated or deactivated by setting the AV system "System Settings → Body Accessories → Exterior Light → Intelligent Courtesy Lamp".

4.3.2 Interior amp

Automatic light-on function of roof lamps



- Press the switch ① (depressed) to activate the automatic light-on function of the roof lamps; press the switch ① (popping up) again to deactivate this function.

Delay off function of interior lamps

When the roof lamps are off and the automatic light-on function of the roof lamps is activated:

- If the engine start/stop button is in the "OFF" position and one of the doors is opened, the roof lamps will come on automatically; the roof lamps will go out about 30 s after the doors are closed.
- If the engine start/stop button is in the "OFF" position and the doors are unlocked remotely, the roof lamps will come on automatically and then go out after about 30 s.
- If the engine start/stop button is switched from the "ON" position to the "OFF" position, the roof lamps will come on automatically and then go out after about 30 s.

i NOTE

When all the doors are closed and the roof lamps are on as mentioned above, if the car is locked remotely or the engine start/stop button is switched to the "ON" position, the roof lamps will go out automatically.

4. Operation of Systems and Equipment

Roof lamp



- When the roof lamps are off, press the switch ① (depressed) to turn on all the roof lamps; press the switch ① (popping up) again to turn off all the roof lamps.

i NOTE

The switch ① will be invalid if it is not used to turn on the roof lamps.

For ordinary sunroof



- When the front roof lamps are off, press the switch ② (depressed) to turn on the front roof lamp on the corresponding side; press the switch ② (popping up) again to turn it off.

i NOTE

The switch ② will be invalid if it is not used to turn on the front roof lamps.

Rear roof lamp

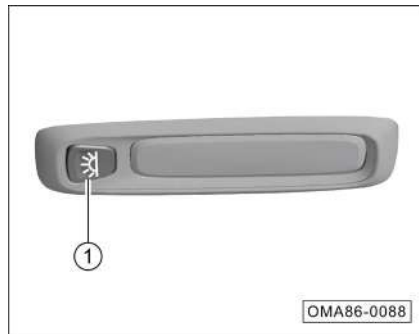

- When the rear roof lamps are off, press the switch ① to turn on the roof lamp on the corresponding side; press the switch ① again to turn it off.

i NOTE

The switch ① will be invalid if it is not used to turn on the rear roof lamps.

Glove box lamp

- If the glove box is opened, the glove box lamp will come on automatically.
- If the glove box is closed, the glove box lamp will go out automatically.

Trunk lamp

- If the trunk lid is opened, the trunk lamp will come on automatically.
- If the trunk lid is closed, the trunk lamp will go out automatically.

Courtesy lamp

- If the door is opened, the courtesy lamp will come on automatically.
- If the door is closed, the courtesy lamp will go out automatically.

Vanity mirror lamp

- If the vanity mirror cover is opened, the vanity mirror lamp will come on automatically.
- If the vanity mirror cover is closed, the vanity mirror lamp will go out automatically.

Ambient light*

- If the position lamp is turned on, the ambient light will come on automatically.
- If the position lamp is turned off, the ambient light will go out automatically.

4. Operation of Systems and Equipment

4.3.3 Wiper combination switch

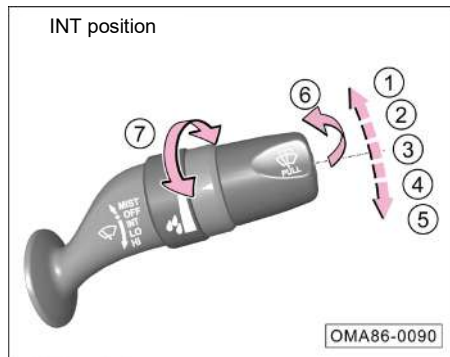
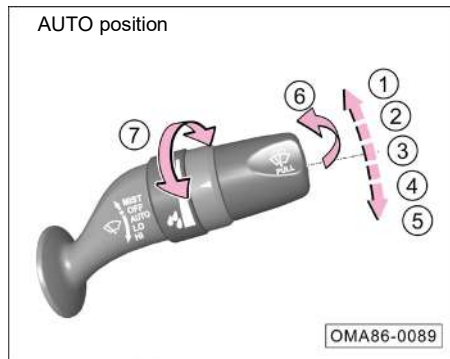

When the engine start/stop button is in the "ON" position, the wiper combination switch can be operated as follows:

- ① MIST: continuous wiping
- ② OFF: wiper off
- ③ AUTO: automatic wiping*
- INT: intermittent wiping*
- ④ LO: slow speed wiping
- ⑤ HI: high speed wiping
- ⑥ Front windshield washer system on
- ⑦ Adjusting knob:
 - Adjust the sensitivity of automatic wiping (AUTO)*
 - Adjust the intermittent wiping (INT) *

MIST: continuous wiping

- If the wiper combination switch is turned to the ① MIST position, the front wiper will start wiping continuously.
- If the wiper combination switch is released to automatically return to the ② OFF position, the front wiper will stop wiping.

OFF: wiper off

- If the wiper combination switch is turned to the ② OFF position, the front wiper will stop wiping.

AUTO: automatic wiping*

- If the wiper combination switch is turned to the ③ AUTO position, the automatic wiping function will be activated, and the wiper system will adjust the wiper speed according to the current rainfall and the real-time car speed.
- This function can be activated or deactivated by setting the AV system "System Settings → Body Accessories → Other Accessories → Auto Wiping". When this function is deactivated, the function of the wiper in the AUTO position is equivalent to that in the INT position.

- Turn the knob ⑦ up/down to adjust the wiper sensitivity, that is, turning up can increase the sensitivity, and turning down can decrease it.

NOTE

- If the instrument cluster displays "Sensor Failure, Please Manually Control Wiper", for the sake of safety, you should manually control the wiper and go to the GAC Motor authorized shop for inspection in time.
- Before activating the automatic wiping function in winter, please check whether the wiper blade is frozen.
- It is recommended to deactivate the automatic wiping function when cleaning the car, in dusty weather and in rainless weather to avoid unintentional wiping of the wipers which may cause damage or personal injury.
- The automatic wiping function is an assist, so the driver should manually operate the wipers when necessary according to the driving situation to ensure driving safety.

INT: intermittent wiping*

- If the wiper combination switch is turned to the ③ INT position, the front wiper will start wiping intermittently.
- For the models equipped with the automatic wiping function, this function can be activated by setting the AV system "System Settings → Body Accessories → Other Accessories → Auto Wiping".
- Turn the knob ⑦ up/down to adjust the intermittent wiping speed, that is, turning up can increase the speed, and turning down can decrease it.

LO: slow speed wiping

- If the wiper combination switch is turned to the ④ LO position, the front wiper will wipe at a slow speed.

HI: high speed wiping

- If the wiper combination switch is turned to the ⑤ HI position, the front wiper will wipe at a high speed.

Front windshield washer system on

- If the wiper combination switch is turned toward the rear of the car to the ⑥ position, the front washer will start spraying water and then the front wiper will start wiping.
- If the wiper combination switch is released to return to its original position, the front windshield washer system will be stopped and the front wiper will wipe twice.
- After the front wiper stops wiping for 6 s, it will wipe once again so as to clear the residual water stains from the glass.

Wiper maintenance

- Within 10 s after switching the engine start/stop button to the "OFF" position, if you turn the control lever of the wiper combination switch to the MIST position and then quickly release it to return it to the original position, the front wiper will move to the highest position and then stop.

NOTE

This function can be activated or deactivated by setting the AV system "System Settings → Body Accessories → Other Accessories → Wiper Maintenance".

4. Operation of Systems and Equipment

4.3.4 Windshield



Windshield glass

The green heat-insulation and laminated anti-scattering glass is used for the front windshield, which can effectively reduce the personal injury in an accident.

WARNING

- Always keep the glass surface clean.
- Please affix the necessary identification marks according to local traffic laws, rules and regulations. Do not stick paper or hang objects on the surface of the front windshield glass, otherwise the front view will be obstructed, which may easily cause traffic accidents.

4.3.5 Rear-view mirror

Interior rearview mirror

Automatic anti-glare interior rearview mirror*

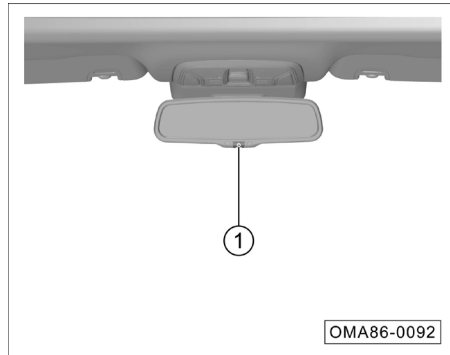

The automatic anti-glare interior rearview mirror monitors the light in front and rear of the car according to the light sensor, reduces the glare reflected from the rear to the mirror surface, and realizes the optimal rear view.

- When the engine start/stop button is in the "ON" position, the automatic anti-glare function will be automatically activated and the switch indicator lamp will come on. Press the switch ① to manually activate or deactivate this function. When this function is deactivated, the switch indicator lamp will go out.

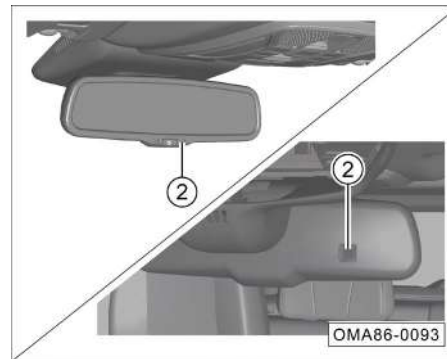

NOTE

Do not cover the light sensor ② in order to ensure its normal function.

i NOTE

If the temperature inside the car is low, the anti-glare rearview mirror may take a longer time to weaken the glare reaction.

Manual anti-glare interior rearview mirror*

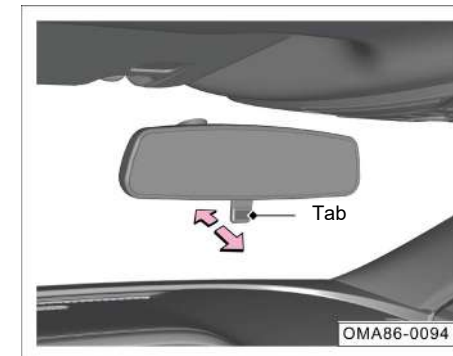

The manual anti-glare interior rearview mirror can be manually adjusted, reduces the reflection from the rear, and realizes the optimal rear view.

- As shown in the figure, the tab is at a normal rearview angle, which can be pulled forward to offset the reflective light coming from the rear to achieve the anti-glare function.
- Push the tab backward to return to the normal rearview angle.

4. Operation of Systems and Equipment

Exterior rearview mirror

WARNING

Although the curved (convex and spherical) rearview mirror can expand the field of view, the reflected object image is smaller and farther than the real object. Therefore, when changing the lanes, do not judge the distance between your car and the following vehicle by the reflected image, otherwise accidents may occur due to wrong judgment.

NOTE

If the function of the exterior rearview mirror fails, please go to the GAC Motor authorized shop for inspection in time.

Electric adjustment

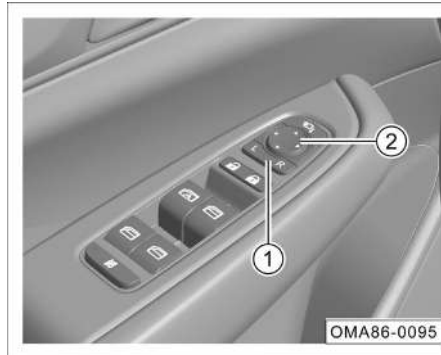

- Press "L" or "R" button on the selection button ① to select the left or right exterior rearview mirror.
- Press the adjusting buttons on ② to adjust the selected exterior rearview mirror to the appropriate rearview angle.
- After adjusting the exterior rearview mirror, restore the selection button ① to its original state.

Electric folding

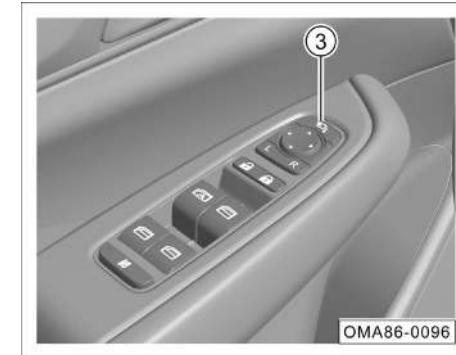

- Press the button ③ to fold the exterior rearview mirror electrically.
- Press the button ③ again to unfold the exterior rearview mirror electrically.

Automatic folding*

- If the car is locked from outside, the exterior rearview mirror will be folded automatically.
- If the car is unlocked from outside, the exterior rearview mirror will be unfolded automatically.

NOTE

This function can be activated or deactivated by setting the AV system "System Settings → Body Accessories → Other Accessories → Auto Folding of Exterior rearview Mirror".

NOTE

- If the exterior rearview mirror is not equipped with the electric folding function or the electric folding function fails, the mirror can be manually folded which then shall be manually unfolded. A click sound can be heard when the mirror is manually unfolded.
- Be careful when operating the electric folding function of the exterior rearview mirror to prevent your fingers from being pinched by the rearview mirror and its base.

Turning down of exterior rearview mirror when reversing*

This function is to automatically turn down the exterior rearview mirror at a certain angle when reversing, so that the driver can observe the rear situation.

Memory of turning down position of exterior rearview mirror when reversing:

1. Manual turning down of exterior rearview mirror when reversing:
 - Switch the engine start/stop button to the "ON" position, enter the AV system "System Settings → Body Accessories → Other Accessories → Manual Angle Adjustment of Exterior rearview Mirror", and activate the "Manual Turning Down of Exterior rearview Mirror When Reversing" function.
 - Depress the brake pedal and shift the gear to "R" position.
 - Adjust the corresponding exterior rearview mirror to a suitable reversing position. After the adjustment, release the brake pedal, and then this position is memorized as the turning down position of exterior rearview mirror when reversing.

2. Automatic turning down of exterior rearview mirror when reversing:

- Switch the engine start/stop button to the "ON" position, enter the AV system "System Settings → Body Accessories → Other Accessories → Automatic Angle Adjustment of Exterior rearview Mirror", and activate the "Automatic Turning Down of Exterior rearview Mirror When Reversing" function.
- Click the "Setting" soft key for automatic turning down of exterior rearview mirror when reversing, and adjust the exterior rearview mirrors on both sides to suitable reversing positions. After the adjustment, click the "OK" soft key, and then this position is memorized as the turning down position of exterior rearview mirror when reversing.

Activation of manual turning down of exterior rearview mirror when reversing

- Enter the AV system to activate the "Manual Turning Down of Exterior rearview Mirror When Reversing" function.
- Switch the engine start/stop button to the "ON" position, depress the brake pedal and shift the gear to "R" position.
- Select the "L" or "R" side exterior rearview mirror.
- The exterior rearview mirror is turned down to the memory position.

4. Operation of Systems and Equipment

Activation of automatic turning down of exterior rearview mirror when reversing

- Enter the AV system to activate the "Automatic Angle Adjustment of Exterior rearview Mirror" function.
- Switch the engine start/stop button to the "ON" position, depress the brake pedal and shift the gear to "R" position.
- The exterior rearview mirrors on both sides are automatically turned down to the memory positions.

NOTE

- If the gear is shifted from the "R" position to other positions for more than 10 s, or the car speed exceeds 10 km/h, or the selection button is restored to its original state, the mirror will automatically return to the previous position.
- The manual turning down of exterior rearview mirror when reversing is affected by the selection of "L" or "R", but the automatic turning down of exterior rearview mirror when reversing is not affected by it.

Defrosting and defogging function*

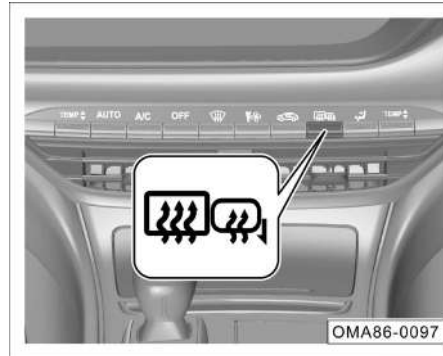

- If the button  is pressed, the button indicator lamp will come on, and the defrosting and defogging function will be activated to clear the fog or frost on the exterior rearview mirrors and the rear windshield glass.
- This function will be deactivated automatically after about 15 minutes or pressing the button again can manually deactivate this function; when this function is deactivated, the button indicator lamp will go out.

NOTE

- If there is residual fog or frost after the defrosting and defogging function is deactivated automatically, just press the button  again.
- Do not use the defrosting and defogging function for a long time, otherwise the heater may be damaged due to overheating.
- If the defrosting and defogging function is out of use, please deactivate it to avoid wasting battery power.

4.3.6 Sun visor

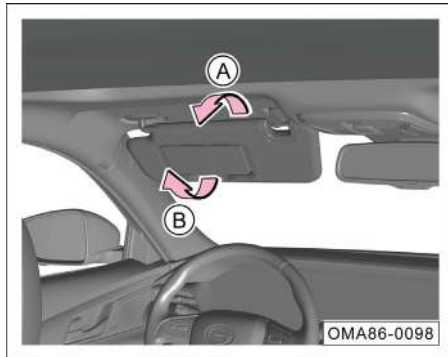

- Turn down the sun visor on the driver's side or front passenger's side in the direction of arrow A to shelter from the incoming sunlight from the front windshield.
- To use the vanity mirror, just turn down the sun visor and pull open the vanity mirror cover in the direction of arrow B, and then the vanity mirror lamp comes on automatically.

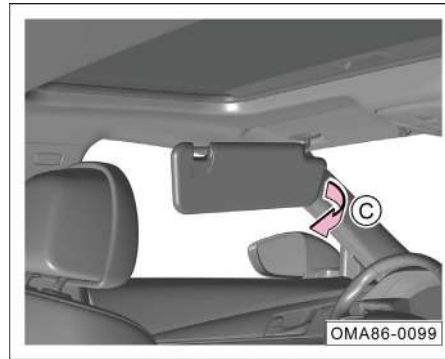

- After turning down the sun visor on the driver's side or front passenger's side, pull it out from the movable bracket in the direction of arrow C to shelter from the incoming sunlight from the side window.

i NOTE

When the engine start/stop button is in the "OFF" position or the car is locked for a few minutes, the vanity mirror lamp will go out automatically.

4.4 Seats and storage facilities

4.4.1 Head restraints

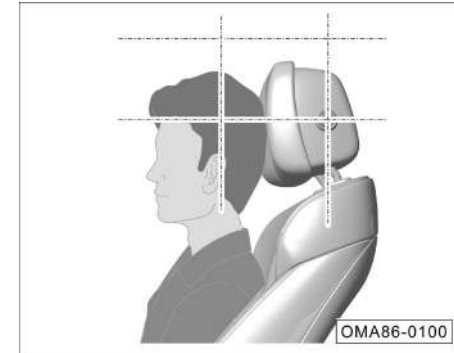

Correct adjustment of the head restraint is essential to protect the occupants and reduce the personal injuries in accidents.

All occupants must adjust the head restraints to the correct position (as shown in the figure) according to their body shape.

4. Operation of Systems and Equipment

WARNING

In order to reduce the risk of accidental casualties, please strictly observe the followings:

- Do not adjust the head restraint while driving.
- Always keep the head restraint in its mounting position. If the head restraint is removed or installed improperly, the driver may be seriously injured in an accident.

Height adjustment of front passenger's head restraint (for manual adjustment of four-way head restraint)*

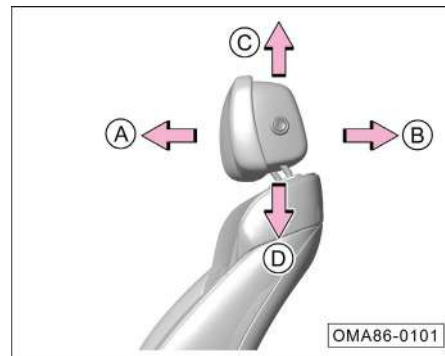

Forward and backward adjustment of head restraint

- Press and hold the lock button and push the head restraint in the direction of arrow A or B to adjust the head restraint to slide forward or backward.

Upward and downward adjustment of head restraint

- Upward adjustment: Lift up the head restraint directly to the desired position in the direction of arrow C.
- Downward adjustment: Press and hold the lock button, and press down the head restraint to the desired position in the direction of arrow D.

Height adjustment of front passenger's head restraint (for manual adjustment of two-way head restraint)*

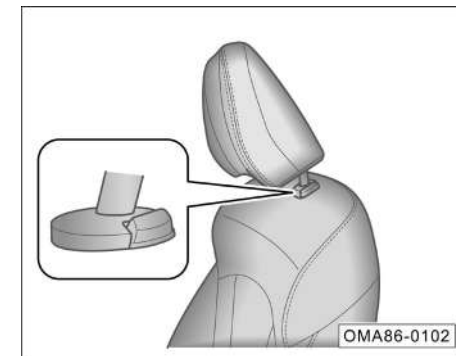

- Downward adjustment: Press and hold the lock button ①, and press down the head restraint to the desired position.
- Upward adjustment: Lift up the head restraint directly to the desired position.

NOTE

The adjustment method of rear passenger's head restraint is the same as the manual adjustment of front passenger's two-way head restraint.

4.4.2 Front seats

i NOTE

When measuring the depth of the seat cushion, be sure to adjust the front and rear positions of the seat to the middle of the slide rail and the seat back to the normal operating state (25°).

⚠ WARNING

- **Do not place objects under the front seats, for these objects may be caught between the seat and the slide rail, hindering the seat from being locked.**
- **Please adjust the front seat only when the car is in a stationary state, because incorrect sitting posture during the seat adjustment may easily cause casualties.**
- **Never leave children alone in the car to prevent them from accidentally operating the power seat and causing accidents, because the power seat adjustment mechanism still works after switching the engine start/stop button to the "OFF" position.**

Seat ventilation*



- Switch the engine start/stop button to the "ON" position.
- Switch the AV system to the A/C control interface, click **OFF** or **OFF** soft key ①, and enter the next page to select the seat ventilation positions or deactivate the seat ventilation function.

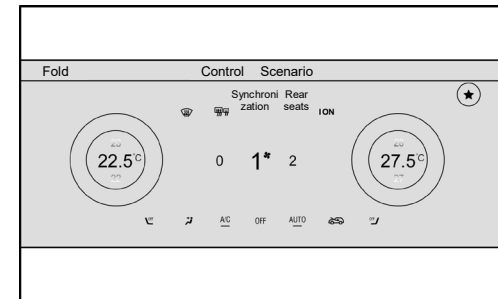

- Click the **1/2/3** soft key to activate the seat ventilation function.
- Click the **OFF** soft key to deactivate the seat ventilation function.

The seat ventilation has three positions, that is, **1**, **2** and **3**, corresponding to three different ventilation speeds, among which the 3rd position has the highest ventilation speed followed by the 2nd position, and the 1st position has the lowest ventilation speed.

If you click the **1/2/3** soft key during the automatic ventilation process, the automatic ventilation function will be deactivated and the current ventilation position will be changed by one position.

4. Operation of Systems and Equipment

i NOTE

The seat ventilation switch has no physical button and also no display on the main interface of the AV system. You need to click on the A/C status display area in the lower left/right corner of the AV system interface to enter the A/C control interface for adjustment.

The automatic ventilation function can be activated or deactivated by setting the AV system "System Settings → A/C & Seat → Seat → Driver's Seat Automatic Ventilation & Heating/Front Passenger's Seat Automatic Ventilation & Heating".

Memory system of seat/external rearview mirror*

Seat memory switch

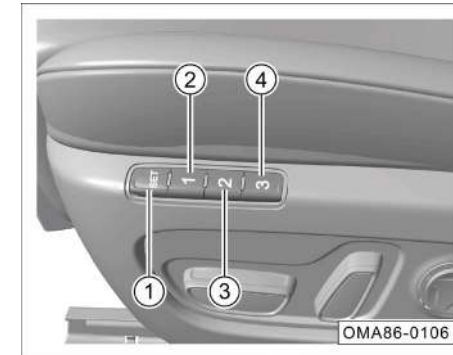

- ① SET button
- ② Position 1 button
- ③ Position 2 button
- ④ Position 3 button

i NOTE

The seat herein refers to the driver's seat, because other seats have no memory function.

Position memorizing

1. Adjust the positions of the seat and exterior rearview mirror.
2. Press the SET button.
3. Release the SET button and press the Position 1/2/3 button within 3 s. Then the instrument cluster sends a "Ding" prompt sound, and the current positions of the seat and the exterior rearview mirror are memorized successfully.

Retrieval of memory position

1. Fast retrieval
 - When the engine start/stop button is in the "OFF", "ACC" or "ON" position and the transmission gear is in the "P" position, press any one of the position 1/2/3 buttons to retrieve the corresponding position information.

2. Normal retrieval

- When the engine start/stop button is in the "ON" position and the transmission gear is in the position other than "P", press and hold any one of the position 1/2/3 buttons to retrieve the corresponding position information. If the position button is released during the retrieval process, the retrieval will be interrupted immediately.

Seat welcome

This function can be activated or deactivated by setting the AV system "System Settings → A/C & Seat → Seat → Seat Welcome", and when this function is activated:

- If you switch the engine start/stop button to the "OFF" position and open the driver's door, the seat will automatically move back to the welcome position.
- If you switch the engine start/stop button to the "ON" position, the seat will automatically return to its original position.

NOTE

If the seat position is manually changed after the seat moves to the welcome position, next time the seat will not move after the engine start/stop button is switched to the "ON" position.

Associated memory/retrieval function of GAC Motor application account

The car control function in the GAC Motor account system associates the car settings with the GAC Motor application account. Different drivers can automatically obtain the associated driver positions (such as seat position and mirror angle) and car configuration information (such as welcome function and turning down of exterior rearview mirror when reversing) by logging in to their accounts.

4. Operation of Systems and Equipment

1. Account associated memory

- After logging in to the account, the user can manually adjust the seat/exterior rearview mirror, the AV main unit interface will pop up a box to prompt the user whether to save the current driver position, and the user can click Save to memorize the current position in the corresponding account.

2. Account associated retrieval

- When the user logs in to the account, the seat/exterior rearview mirror will be automatically adjusted to the position memorized in this account.
- When the user clicks the retrieval button in the pop-up box, the seat/exterior rearview mirror will be automatically adjusted to the position memorized in this account.

i NOTE

The welcome function and the turning down of exterior rearview mirror when reversing are both bound to the account.

Automatic recognition of intelligent remote control key*

This function can be activated or deactivated by setting the AV system "System Settings → A/C & Seat → Intelligent Remote Control Key Recognition", and when this function is activated:

- If you take away the intelligent remote control key and leave and lock the car, the positions of the seat and the exterior rearview mirrors used before you leave the car will be memorized and associated with the used intelligent remote control key.
- If you use this intelligent remote control key to unlock the car, the seat and the exterior rearview mirrors will be automatically adjusted to the positions memorized by the key.

i NOTE

The position memorized by the key is independent of that memorized by the memory switch.

4.4.3 Rear seats

Rear center console armrest



- Press the switch ① and turn down the center console armrest.

i NOTE

The center console armrest shall not be seated by anyone, and shall return to the seat back if the rear middle seat needs to be occupied.

4.4.4 Storage facilities

Door interior trim panel storage compartment



- Place beverage bottles, map manuals and other articles here.

Cab lower protective plate storage box



- Open the cab lower protective plate storage box as arrowed to place small articles.
- Push back to close the storage box until you hear a “click” sound.

Instrument panel front storage box



- Press to open the storage box cover automatically and place small articles.

i NOTE

For models equipped with mobile phone wireless charging function*, this area is used as the mobile phone wireless charging area, so be sure to deactivate the mobile phone wireless charging function before placing articles in it. => [See Page 104](#)

4. Operation of Systems and Equipment

Front mobile phone slot



- Place mobile phone here.

Rear mobile phone slot

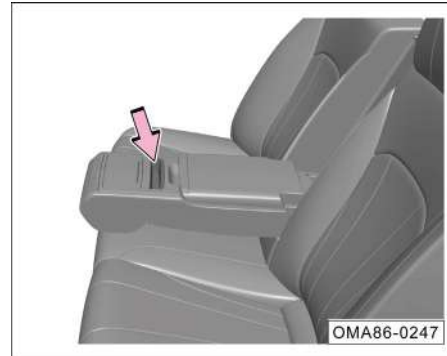

- Press the center console armrest switch and turn down the center console armrest to place the mobile phone.

Instrument panel lower storage compartment

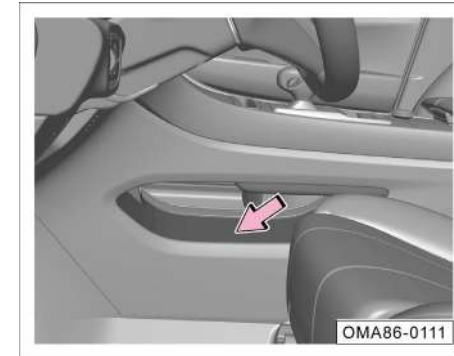

- Place books, ipad, etc. here.

Storage compartment on the back of front center console armrest box

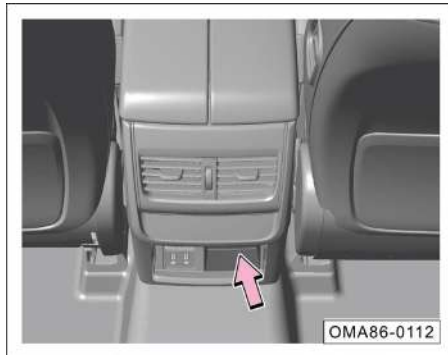

- Press to open the storage compartment on the back of the front center console armrest box to place small articles.

Rear center console armrest box

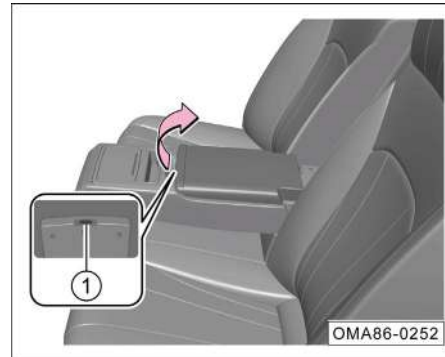

- Press the center console armrest switch and turn down the center console armrest.
- Press the switch ① and lift up to open the cover of the rear center console armrest box to place small articles.

Cup holder



- Front cup holder: Press to open the front cup holder cover automatically and place beverage bottles.

4. Operation of Systems and Equipment



- Rear cup holder: Press the center console armrest switch and turn down the center console armrest, and then press to open the rear cup holder cover automatically and place beverage bottles

 WARNING

Do not place hot beverages on the cup holder, or hot beverages may spill out while driving, scalding the driver.

Spectacle case



- Press to slowly open the spectacle case and place small articles such as sunglasses.
- Push back to close the spectacle case until you hear a “click” sound.

Front passenger's side glove box

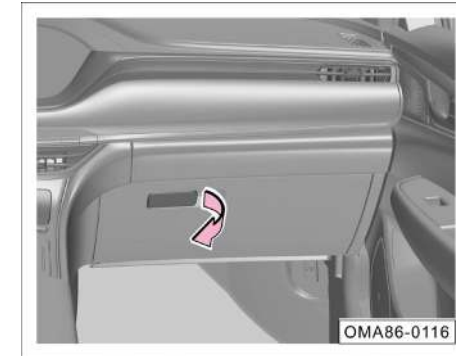

- Pull the handle to open the glove box and place articles such as file bags.
- Push back to close the glove box until you hear a “click” sound.

 WARNING

The glove box must be closed when the car is traveling, otherwise the articles in the glove box may fly out and cause personal injury to the occupants in case of an emergency braking or an accident.

Front center console armrest box

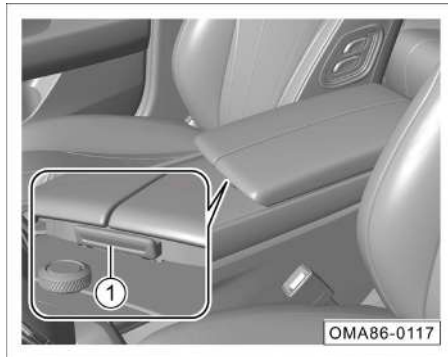

- Press the switch ① to open the front center console armrest box cover and place wallets and other articles.

Storage bag on the back of front seat

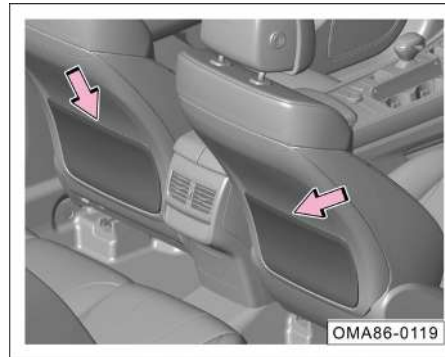

- Pull open the storage bag to place books, foldable umbrellas and other articles.

Armrest box cold storage function

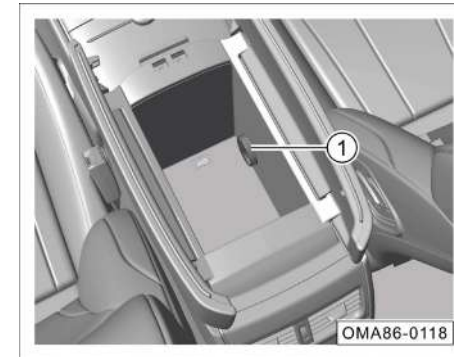

- Turn the cold storage switch ① clockwise to activate the cold storage function.
- Turn the cold storage switch ① counterclockwise to deactivate the cold storage function.

4. Operation of Systems and Equipment

i NOTE

The armrest box cold storage function is realized through air cooling by the A/C air duct and thus shall be activated only after the A/C is turned on.

The cold storage temperature of the armrest box is as set in the rear seats.

4.4.5 Power outlet

Front power outlet



- When the engine start/stop button is in the "ACC" or "ON" position, open the front power outlet cover and connect a device to be charged.

i NOTE

Maximum support a 12V/120W device to be charged.

Front USB interface

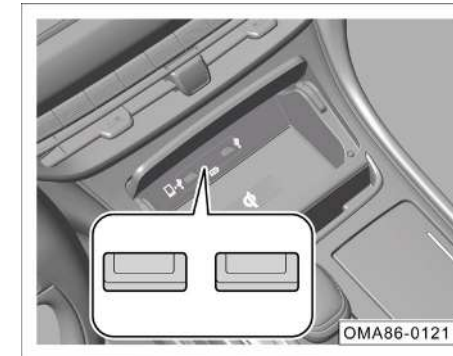

- When the engine start/stop button is in the "ACC" or "ON" position, open the instrument panel front storage box cover and connect a device to be charged.

i NOTE

The front USB interface is used for either charging or data transmission.

Rear USB interface

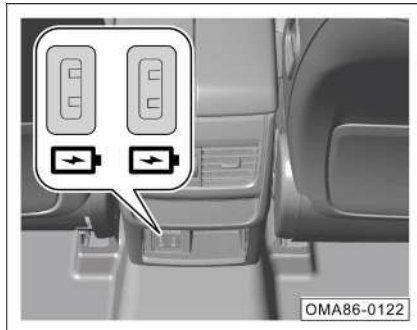

- When the engine start/stop button is in the "ACC" or "ON" position, just connect a device to be charged.

i NOTE

The rear USB interface is only used for charging.

👁 NOTE

- To avoid damage to the electrical system of the car, never connect power generation equipment to a power outlet.
- Only use electrical equipment that complies with national electromagnetic compatibility regulations.
- Before turning on or off the engine start/stop button, always disconnect the device connected to the power outlet to avoid damage to the electrical equipment due to voltage fluctuations.

⚠ WARNING

- **Never use the power outlet when no one is in the car. Improper use may easily cause a fire.**
- **Do not let children use the power outlet.**
- **Never use the high-power electrical equipment.**

4. Operation of Systems and Equipment

4.4.6 Trunk

In order to ensure the maneuvering stability of the whole car, the luggage shall be placed as evenly as possible, and the heavy objects shall be placed at the front of the trunk.

 WARNING
<ul style="list-style-type: none">• The center of gravity of the car carrying heavy objects may change. If the heavy objects in the trunk suddenly slip, the maneuvering stability of the car will change.• The articles in the trunk must be fixed, otherwise they may fly forward and cause personal injury to the occupants in case of an emergency braking or an accident.• Never place fragile, flammable and explosive articles in the trunk!

Driver's tools in trunk

Warning triangle



- There is a warning triangle in the trunk.

Driver's tools/spare tire

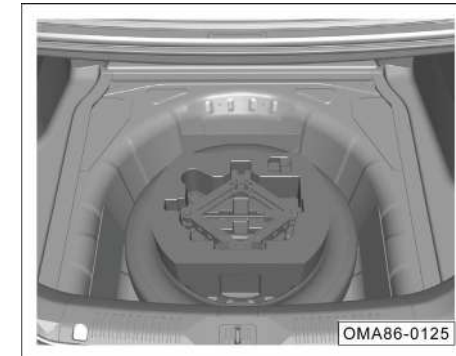

- The driver's tools and spare tire are under the trunk carpet.

4.4.7 Accessories and modification

Data labels and signs are affixed to fuel tank cap, engine hood latch and other components of the delivered car, which indicating important data and information about the use of the car. Do not remove or damage these labels and signs, and always keep the data and information on them legible.

The car is designed with the latest safety technologies by GAC to ensure excellent active safety and passive safety. Therefore, in order to maintain the excellent characteristics of this car, please be sure to consult the GAC Motor authorized shop before installing accessories or replacing parts.

The accessories and parts approved by GAC are recommended for you. The parts other than GAC ones will not be covered by the warranty.

WARNING

The installation of inappropriate accessories or the modification of the car may affect the maneuvering stability and other performances of the car, and even may cause serious casualties.

To install a car phone, alarm device, transceiver, low-power AV system, etc., ensure that they will not interfere with the electronic control unit such as anti-lock braking system (ABS) on the car.

Before installing the accessories, please ensure that:

1. The accessories neither dim the lamps, nor affect the normal operation or performance of the car.
2. For the car equipped with side curtain airbags, the accessories must not installed on the B-pillar or across the rear door window. Because the installation in these areas will interfere with the normal function of the side curtain airbags.

NOTE

When additions (such as head restraint, seat cover, floor mat, sun protection mat, etc.) are required, inferior additions may contain VOCs that do not meet national standards, and may emit unusual odors, causing hidden dangers that affect the air quality in the car; therefore, the genuine high-quality additions are recommended to ensure a comfortable driving environment.

4. Operation of Systems and Equipment

Modification of car

Dismantling the parts from the car or replacing the genuine parts with non-GAC Motor parts will seriously damage the maneuvering stability and reliability of the car. For example:

- The installation of larger or smaller wheel and tire will interfere with the normal operation of the anti-lock braking system (ABS) and other systems.
- The modification of the steering wheel and other safety devices may cause the system failure.

WARNING

- **Improper modification of the car or installation of inappropriate accessories may easily cause failures and accidents. The accessories and parts approved by GAC are always recommended, because the adaptability, reliability and safety of these accessories and parts have been strictly verified by GAC.**

WARNING

- **Improper modification or maintenance of the car may weaken the protective effect of the airbag, resulting in the system failures and fatal accidents. The accessories such as beverage cup holder and mobile phone holder must not be installed or connected to the cover of the airbag assembly or within the working range of the airbag.**
- **Improper operation or modification of the car (such as the modification of the engine, brake system, or components that affect the performance of the wheels and tires) will affect the SRS function, causing serious casualties.**
- **Do not install wheels and tires that are not approved by GAC.**
- **The modifications of the front and the engine compartment of the car may weaken the function of the pedestrian detection system and violate road traffic regulations.**

4.5 A/C system

4.5.1 General instructions

The A/C filter can filter pollen and dust entering the air inlet of A/C system.

The A/C filter must be regularly cleaned and replaced according to “Regular Maintenance Schedule” in “Warranty Manual”.

If the car is often driven in areas with poor air quality, the replacement interval of the A/C filter should be shortened. If the airflow from the A/C air outlet is not as smooth as usual, it may be due to the dirty and clogged A/C filter. In this case, clean or replace the A/C filter as soon as possible.

WARNING

If the air in the car is foul, it will make the driver easily fatigued, lack of energy, and distracted, which is easy to cause an accident, resulting in personal injury or even death. Therefore, use the air circulation mode according to the actual situation.

NOTE

If the A/C system has failure (such as no cooling, odor in outlet air, etc.), please go to the GAC Motor authorized shop for inspection.

NOTE

- When the engine start/stop button is in “ON” position, the A/C system can be operated.
- When the A/C is turned on, there will be dripping water at the bottom of the car. Prolonged parking with the A/C on will cause water to accumulate, which is normal.
- Regularly clean the front windshield wiper cover of snow, ice, and leaves to avoid clogging the A/C air inlet and ensure normal air intake.
- The A/C system can achieve its maximum effect with the windows and sunroof closed. However, when the indoor temperature is high under hot sun, open the windows briefly to allow the indoor heat to dissipate, and then use the A/C for cooling.

4. Operation of Systems and Equipment

4.5.2 A/C system

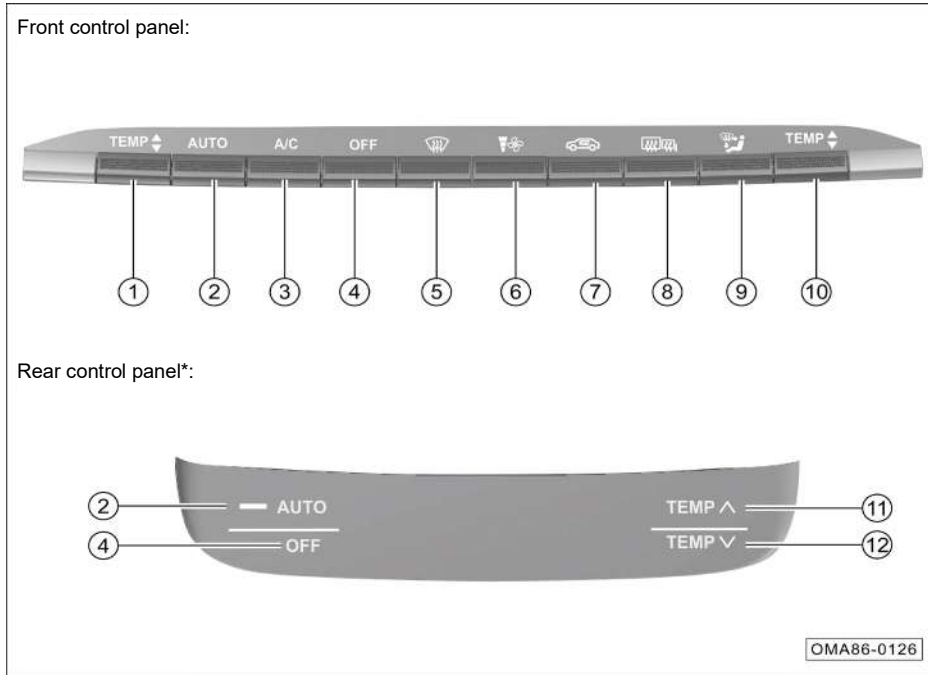

- ① TEMP \blacktriangle Temperature control button (left)
- ② AUTO mode button
- ③ A/C button
- ④ OFF button
- ⑤ Front windshield defrost/defog button
- ⑥ Fan speed control button
- ⑦ Recirculation/fresh air mode button*
- Recirculation mode button*
- ⑧ Rear windshield and exterior rearview mirror defrost/defog button*
- Rear windshield defrost/defog button*
- ⑨ Air supply mode button
- ⑩ TEMP \blacktriangledown Temperature control button (right)

- ⑪ TEMP▲ Temperature up button (rear)*
- ⑫ TEMP▼ Temperature down button (rear)*

i NOTE

- The A/C system can also be controlled by pressing any button on the A/C control panel and switching the AV system display interface to the A/C system control interface.
- Some functions specific to the A/C system can be set in “System Settings → AC & Seat → A/C (Car Settings → A/C Settings)” of AV system.

Temperature setting

Pull up or press TEMP▲ button (or press TEMP▲*/TEMP▼ button) to increase/decrease the temperature at increments of 0.5°C.

- The set temperature can be adjusted within 18.5-31.5°C. When the set temperature is lower than 18.5°C, LO is displayed, and above 31.5°C, HI.

In auto mode, when LO/HI is displayed, the system will keep high air volume.

In auto mode, in order to obtain the most satisfactory indoor temperature, it is recommended to set the temperature to 25.0°C, and adjust the temperature if necessary.

A/C cooling button



Press the A/C button. The button indicator lamp will come on, and the A/C system will start cooling.

Press the A/C button again. The button indicator lamp will go out, and the A/C system will stop cooling.

Auto mode

Press the AUTO button. The button indicator lamp will come on, and the A/C system will enter the auto mode. The following functions will be automatically controlled according to the set temperature:

- Outlet air temperature.
- Air volume at the air outlet.
- Air supply mode.
- Air circulation mode.
- The working state of the A/C cooling function.
- The working state of the negative ion air purifier.

Press  button or  button to exit the auto mode of the A/C system.









4. Operation of Systems and Equipment

Air speed setting

Pull up or press  button to increase/decrease the air speed by one level. The AV system display shows the corresponding air speed level.

In auto mode, in order to make the indoor temperature reach the target value, the A/C system will automatically control the air speed. Press  button, and the A/C system will exit the auto mode.

Turn off the A/C

Press the OFF button to turn off the A/C system. After the A/C system is turned off, the  button,  button, and  button can be effectively operated without turning on the A/C system; operating , *, and * buttons has no effect; operating the AUTO button, A/C button,  button, or  button can turn on the A/C system.

Air circulation (for cars with automatic recirculation/fresh air mode)

Automatic recirculation/fresh air mode

Press  button. When the left button indicator lamp is on, the air circulation enters the automatic recirculation/fresh air mode.

This mode automatically controls the air intake mode according to the quality of outside air. When the quality of outside air is poor, the recirculation mode is set; when the quality of outside air is good, the fresh air mode is set.

Recirculation mode

Press  button. When the right button indicator lamp is on, the air circulation enters the recirculation mode.

When the quality of outside air is poor, use this mode to prevent the outside air from entering the car and recirculate the inside air.

Fresh air mode

Press  button. When all button indicator lamps are off, the air circulation enters the fresh air mode.

When the quality of outside air is good, use this mode to bring the fresh outside air into the car.

Air circulation (for cars with manual recirculation/fresh air mode)

Recirculation mode

Press  button. When the button indicator lamp is on, the air circulation enters the recirculation mode.

Fresh air mode

Press  button. When the button indicator lamp is off, the air circulation enters the fresh air mode.

 NOTE

- Long-term use of recirculation mode will cause accumulation of carbon dioxide in the car, which is not conducive to keeping the driver awake.
- Using recirculation mode in cold or rainy weather can easily cause the windows to mist up, affecting the driver's visibility, which may cause serious accidents.

Front windshield defrost/defog function

Press  button. The button indicator lamp will come on, and the front windshield defrost/defog function will be turned on.

Press  button again: the button indicator lamp will go out, front windshield defrost/defog function will be turned off and the state before defrosting/defogging will be restored; or press the AUTO button to enter the auto mode to turn off the front windshield defrost/defog function.

 NOTE

- When the temperature is set to the lowest, using the defrost/defog function will cause the outside of windshield to mist up, affecting the driver's visibility, which may cause serious accidents. When using the defrost/defog function, set the temperature close to the ambient temperature outside the car.
- When using the defrost/defog function, if you manually turn off the A/C cooling function, it will cause the windshield to mist up, affecting the driver's visibility, which may cause serious accidents.

Rear windshield defrost/defog function

Press  button. The button indicator lamp will come on, the rear windshield defrost/defog function will be turned on, and the rear windshield and exterior rearview mirrors electrically heated*.

When rear windshield defrost/defog function is working, press  button again. The button indicator lamp will go out, and the rear windshield defrost/defog function will be turned off. If you do not manually turn off the rear windshield defrost/defog function, the function will be automatically turned off after 15 minutes.

 NOTE

With the engine not started, using the rear windshield defrost/defog function for a long time will cause too low battery voltage, making it impossible to start the engine.



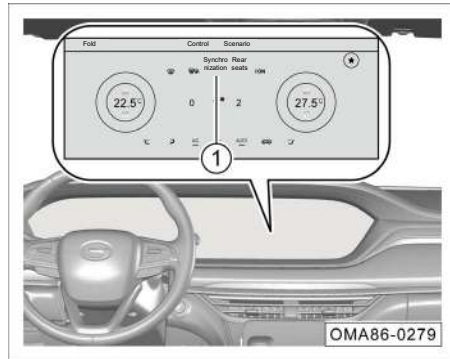

4. Operation of Systems and Equipment

Dual zone mode



- Click the “Sync” soft key ①. The soft key indicator lamp will come on, indicating that the A/C system enters the dual zone control mode. The temperature in the left and right areas is controlled independently.
- Click the “Sync” soft key ①. the soft key indicator lamp will go out, indicating that the A/C system exits the dual zone control mode and enters the single zone control mode, and the indoor temperature is controlled as a whole.

Air supply mode

Pressing  button, you can manually switch between 4 air supply modes as follows:  panel mode →  panel/floor mode →  floor mode →  floor/defrost mode.

In auto mode, the A/C system will automatically control the air supply mode. When the outlet air temperature is high, most of the air will be directed through the floor outlets; when the outlet air temperature is low, most of the air will be directed through the panel outlets. When  button is operated, the A/C system will exit the auto mode.

NOTE

- In order to ensure that the A/C system can effectively control all the air supply modes automatically, please keep all air outlets open.
- During cold start in winter, in the auto mode, A/C system will start from the defrost mode and enable a gradual transition to other modes.

Negative ion air purifier*

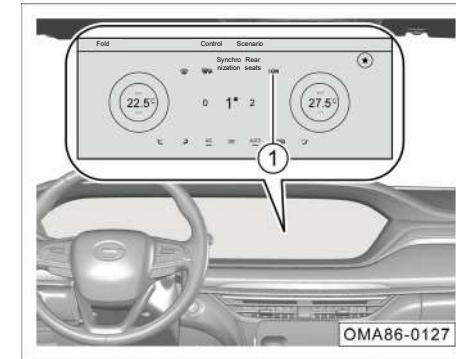

Switch the AV system to the A/C system control interface, and click ION soft key ①. The soft key indicator lamp will come on, and the A/C system will turn on the negative ion air purifier. It can produce negative ions, effectively decompose harmful gases such as formaldehyde and benzene in the car, and purify the inside air.

Click ION soft button ① again. The soft key indicator lamp will go out, and the A/C system will turn off the negative ion air purifier.

Operating ION soft key and AUTO button can turn on the negative ion air purifier.

Rear A/C control*

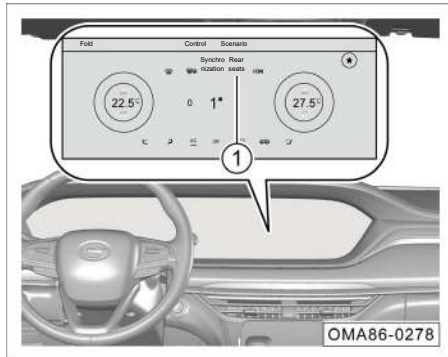

Switch the AV system to the A/C system control interface. Click “Rear” soft key ① to switch the A/C interface to the rear A/C interface. The A/C system will enable the rear control function.

- Adjust the rear temperature via the main unit.

Clicking “Exit Rear A/C Control” soft key in the rear A/C interface or no operation within a certain time will turn off the rear A/C control function.

A/C scene*

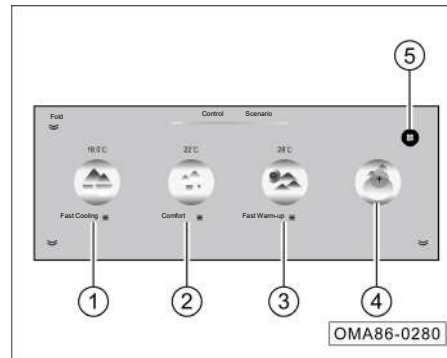

Switch the AV system to the A/C system control interface, and click “Scene” soft key to enter the A/C scene interface.

1. Preset scene 1
 - Fast Cooling: 18°C, AUTO: On, the A/C curve is “Fast”, and the temperature is rapidly decreased until the target temperature is reached.
2. Preset scene 2
 - Comfort: 22°C, AUTO: On, the A/C curve is “Normal” until the target temperature is reached.

3. Preset scene 3
 - Fast Warm-up: 28°C, AUTO: On, the A/C curve is “Fast”, the temperature is rapidly increased, and the maximum power is maintained until the target temperature is reached.
4. Add custom items
 - Click the button to add up to 9 custom scenes.
5. Edit scene
 - Click the button to adjust the sequence of scenes, delete a scene, and edit scene name.

4. Operation of Systems and Equipment

4.5.3 A/C air outlet

Panel side air outlet

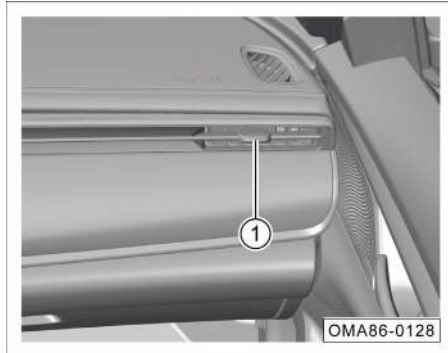

- Toggle the paddle ① up and down to adjust the air flow longitudinally.
- Toggle the paddle ① left and right to adjust the air flow laterally and the air volume, or close the air outlet.

Panel center air outlet

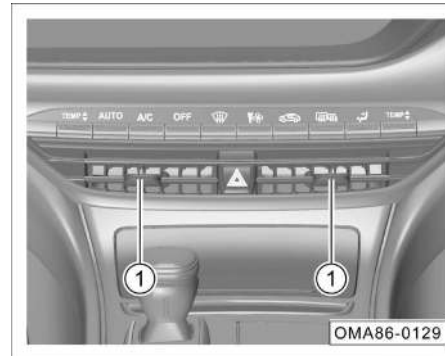

- Toggle the paddle ① up, down, left and right to adjust the air direction.

Rear air outlet

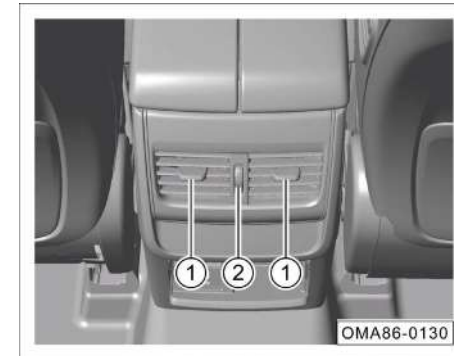

- Toggle the paddle ① up, down, left and right to adjust the air direction.
- Turn the knob ② to adjust the air volume or close the air outlet.

4.6 AV system

4.6.1 Control panel (applicable to cars with AV main unit)

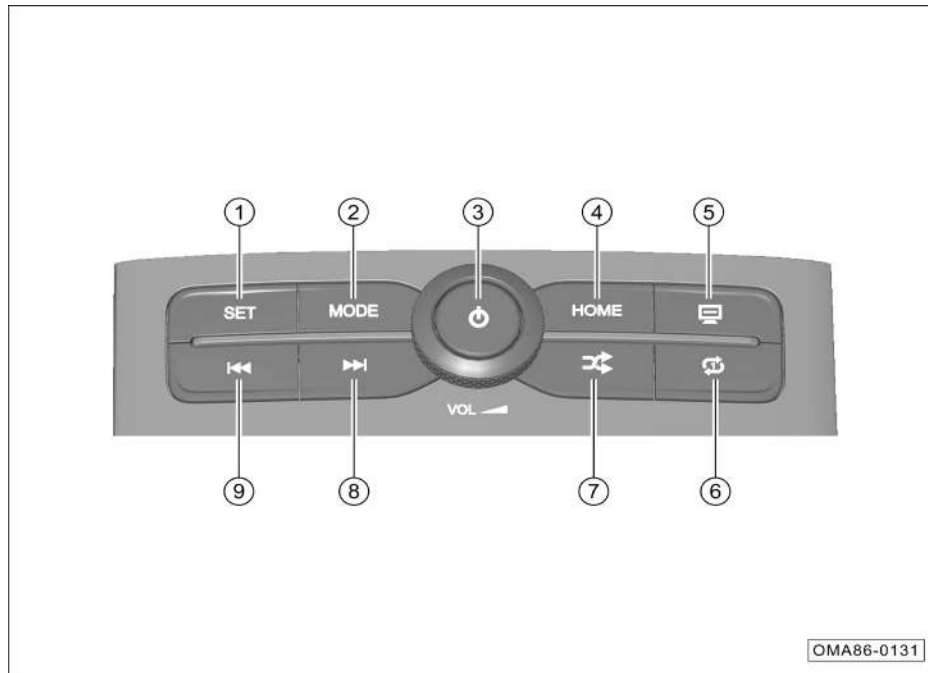

① Setting button

- Shortly press this button to enter the System Settings interface; shortly press this button continuously to switch between the interfaces as follows: System Settings → Car Settings * → Exit.

② Audio source switching button

- Shortly press this button continuously to switch between the interfaces as follows: FM → AM → USB → Bluetooth Music → FM.

③ Power button/Sound volume adjusting knob

- Turn the sound volume adjusting knob to adjust the sound volume.
- With power on, a short press on this button will show “Standby” on the audio display, and the audio source does not work; another short press on this button will activate the audio source.

4. Operation of Systems and Equipment

④ Main interface button

- In other media interface, shortly press this button to return to the main menu interface.

⑤ Screen off button

- With power on, a short press on this button will turn off the display and the audio source still works; another short press on this button will turn on the display again.

⑥ Single cycle button

- In USB/Bluetooth music playback interface, a short press on this button will set Single cycle as the current playback mode.

⑦ Shuffle play button

- In USB/Bluetooth music playback interface, a short press on this button will set Shuffle play as the current playback mode.

⑧ Radio frequency adjusting/Next track button

- In radio mode, shortly press this button to automatically search for a valid station to high frequency.
- When the media source is playing, shortly press this button to skip to the next track.

⑨ Radio frequency adjusting/Previous track button

- In radio mode, shortly press this button to automatically search for a valid station to low frequency.
- When the media source is playing, shortly press this button to skip to the previous track.

i NOTE

The interfaces or functions of the AV system introduced in the “Owner’s Manual” may vary depending on the car configuration, which are for reference only.

4.6.2 Control buttons on steering wheel

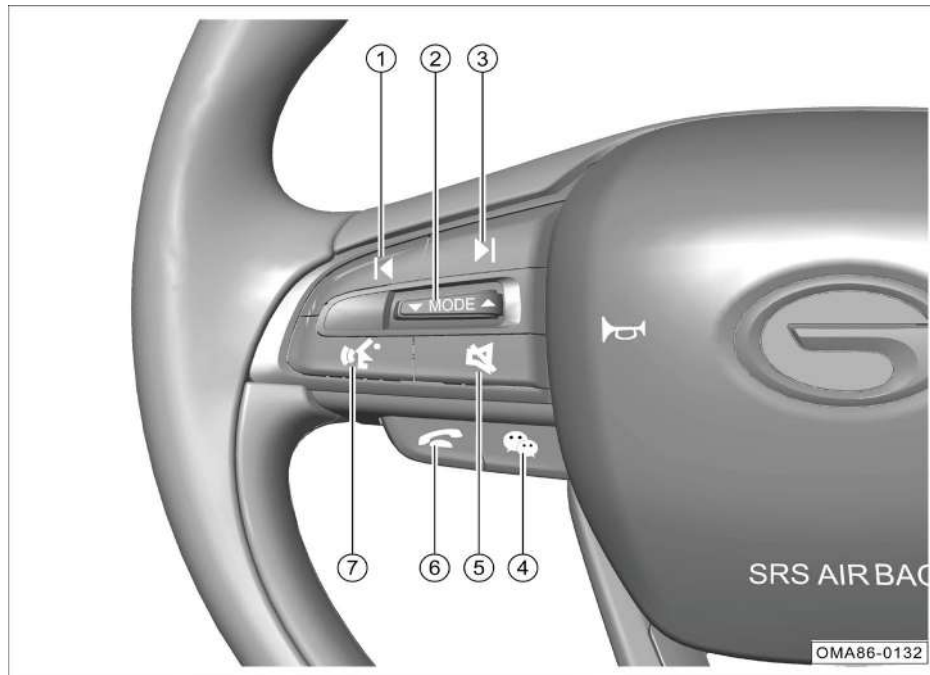

- ① ◀ button
 - In radio mode, shortly press this button to automatically search for a valid station to low frequency. If a valid station is found, the automatic search will be stopped and the station will start playing.
 - When the media source is playing, shortly press this button to skip to the previous track.
- ② Audio source switching/Sound volume adjusting button
 - Shortly press this button continuously to switch between the interfaces as follows: FM → AM → Online Radio * → USB → Bluetooth Music → Online Music * → FM.
 - Pressing this button will not actively switch to CarPlay/CarLife music; if CarPlay/CarLife music is currently playing, pressing this button will switch to radio mode.
 - This button will interrupt the local voice process and switch to the audio source currently playing.
 - Toggle up/down this button to adjust the sound volume.

4. Operation of Systems and Equipment

③ button

- In radio mode, shortly press this button to automatically search for a valid station to high frequency. If a valid station is found, the automatic search will be stopped and the station will start playing.
- When the media source is playing, shortly press this button to skip to the next track.

④ WeChat button (for cars with In-car WeChat)

- A short press on this button will pop up the WeChat interface or send a message, if there is a new message, it will play back the message.
- A long press on this button will turn off the WeChat interface or cancel the message playback.

End call button (for cars without In-car WeChat)

- When there is an incoming call via the Bluetooth, you can press this button to reject the call.
- During a call, you can press this button to end the current call.

⑤ Mute button

- A short press on this button will mute the media source.
- Another press on this button will unmute the media source.

⑥ Answer/Disconnect call button (for cars with In-car WeChat)

- When there is an incoming call via the Bluetooth, you can give a short press on this button to answer the call.
- When there is an incoming call via the Bluetooth, you can give a long press on this button to reject the call.
- During a call, you can give a long press on this button to end the current call.
- When there is no call via the Bluetooth, you can press this button to enter the Bluetooth dialing interface.
- When there is no incoming call via the Bluetooth and no Bluetooth connection, you can press this button to enter the Bluetooth Settings interface.

Answer call button (for cars without In-car WeChat)

- When there is an incoming call via the Bluetooth, you can press this button to answer the call.
- When there is no call via the Bluetooth, you can press this button to enter the Bluetooth dialing interface.
- When there is no incoming call via the Bluetooth and no Bluetooth connection, you can press this button to enter the Bluetooth Settings interface.

⑦ Voice button*

- Shortly press this button to activate or end the local voice.
- With the mobile phone connected to the main unit, after the CarPlay function is activated, shortly press this button to activate or end CarPlay voice.

4.6.3 Basic operation

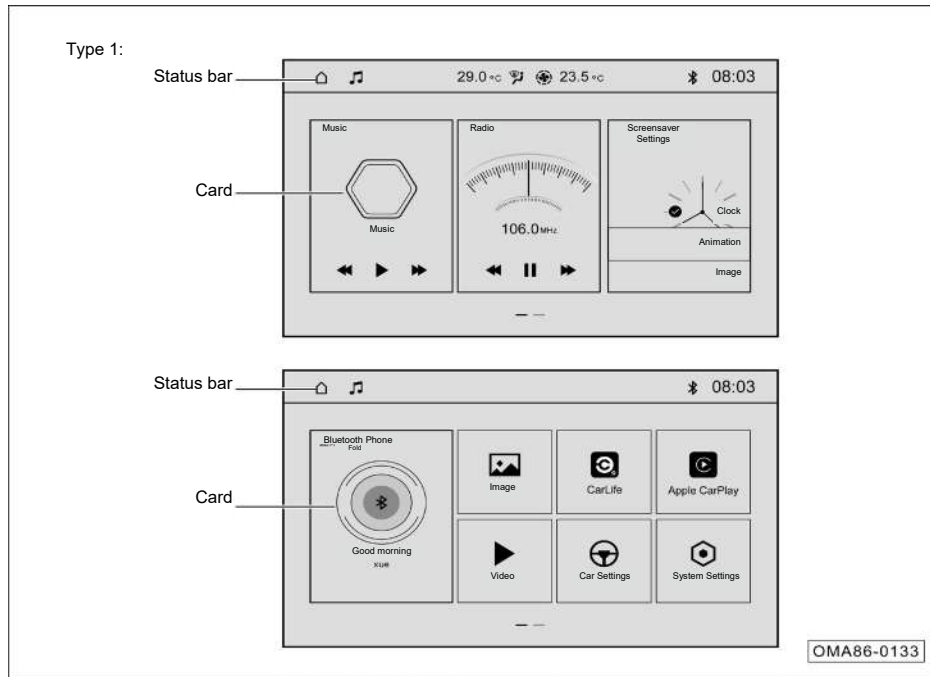

- Swipe left and right to switch between interfaces.
- Click on the cards to enter the corresponding functions.

Status bar

- The status bar displays the system information, and some icons support clicking to enter the corresponding function interfaces.

i NOTE

The main interface is only shown as an example, which acts as a guide for cars with AV main unit. The specific functions and interfaces depend on the actual car configuration.

4. Operation of Systems and Equipment

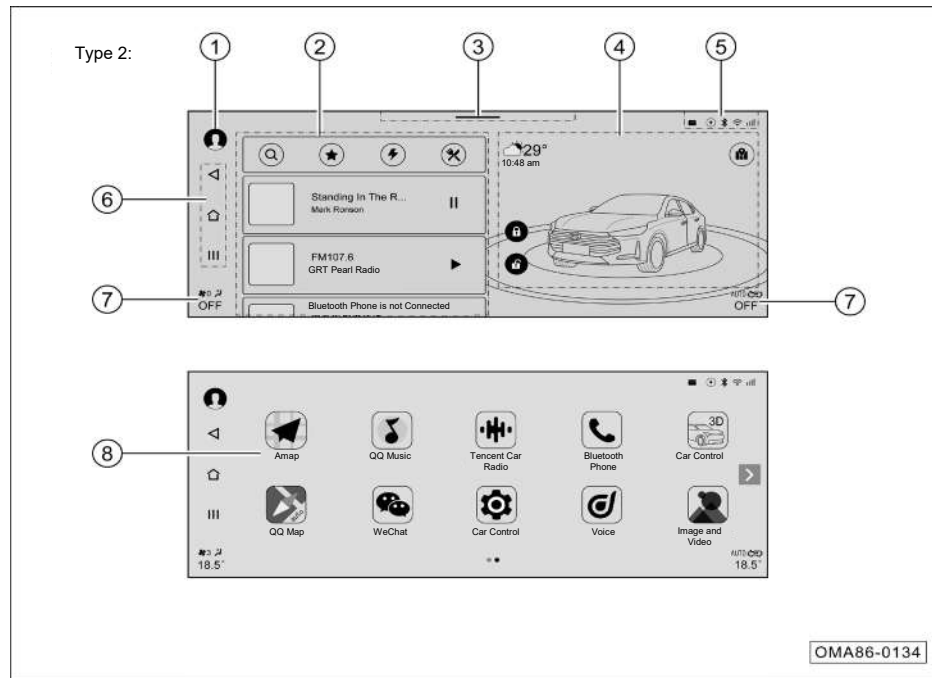

Description of function areas in main interface:

- ① Entrance to Personal center
 - Click to enter the Personal Center Settings interface.
- ② Smart card area
 - Click the cards to quickly enter the corresponding function interfaces.
 - Additional cards can be added and sorted on your own.
- ③ Drop-down menu schematic area
 - Swipe down to enter the drop-down menu bar control interface.
- ④ Smart scene area
 - Click the Scene switching button to switch between the scene Body and scene Cruise.
 - In the scene Body interface, swipe left and right to drag the car model to rotate it left and right; click the car model to enter "My Car" application interface.
 - In the scene Cruise interface, you can perform simple operations in the Map interface.

⑤ System status bar

- Display system status such as “Wireless Charging” and “Bluetooth Connection”. Click the icons to enter the corresponding function interfaces.

⑥ System navigation bar area

- System control soft keys.

⑦ A/C information display/control bar area

- Display the current A/C information, click to enter the A/C control interface.

⑧ Application menu interface

- Click the menu button **III** in the system navigation bar on the left side of the desktop to enter the application menu interface.

i NOTE

The main interface is only shown as an example, which acts as a guide for cars with AVNT main unit. The specific functions and interfaces depend on the actual car configuration.

The AVNT main unit will automatically synchronously refresh the GPS time, without need to set it by yourself.

Drop-down menu bar*

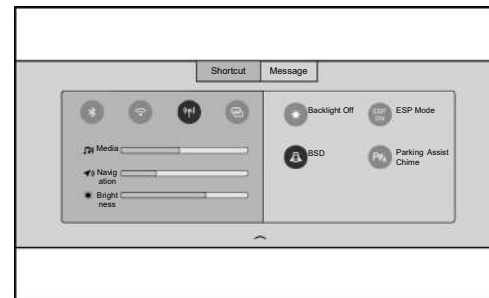

Except for the voice and A/C interfaces, swipe down from the top of the screen (drop-down menu bar area) in any other interface to display the drop-down menu. Click **^** or swipe up to hide the drop-down menu bar. In the drop-down menu bar interface, if there is no operation, the drop-down menu will be automatically hid after 20s.

Click “Shortcut” or “Message” button to switch to the Shortcut drop-down interface or the Message drop-down interface.

Click the function buttons in the drop-down menu bar to turn on/off the corresponding functions, or enter the corresponding function interfaces.

My Car*

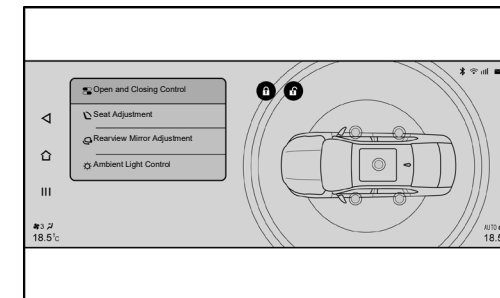

After the AV system starts to work normally, click “3D Car Model in Smart Scene Area” in the main interface or “My Car” soft key in the application menu interface to enter My Car function interface.

- “Open and Closing Control”, “Seat Adjustment”, “Rearview Mirror Adjustment” and “Ambient Light Control” can be adjusted.

- Click **⊙** soft key to enter the corresponding system for adjustment.

4. Operation of Systems and Equipment

Voice*

After the AV system is turned on and working normally, first wake up the voice engine and then issue the non-wake-free voice command. The voice function can be activated in the following ways:

- Press the button on the left side of the steering wheel to start the voice engine.
- Click the voice image in “Voice card” in the main interface and “Voice” icon in the application menu interface to start the voice engine.
- Say the voice wake-up word: the default wake-up word is “Hello, baby”, and another wake-up word can be defined by yourself.

Define the another wake-up word as follows:

1. Use “Hello, baby” to wake up the voice assistant and say “Give you a name XXX” to set another voice wake-up word.
2. The user can set the voice function through System Settings → Voice Assistant.

After the voice system is awake, the voice assistant responds “Please speak” and you can only perform voice control operations after “Listening...” appears in the system.

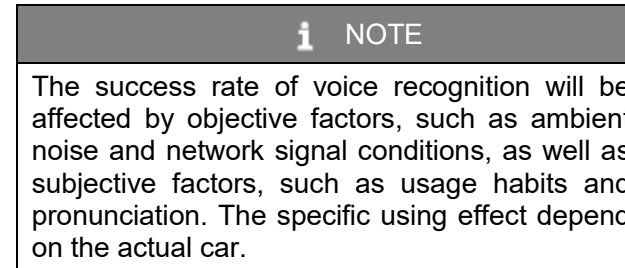

Voice Settings

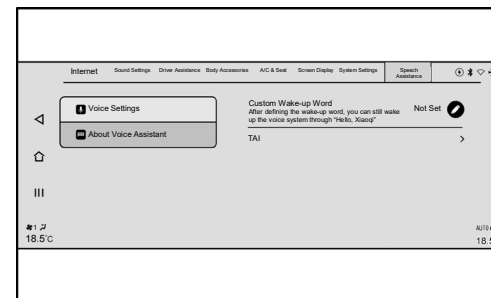

Enter “Voice Vssistant” interface, and then enter Voice Settings or About Voice Assistant.

1. Wake-up word setting
 - You can set a wake-up word consisting of 3 to 5 characters.
2. TAI
 - Log into your “TAI” account by scanning the QR code using WeChat APP.
 - Display the current version and prompt version update when there is a new version.
3. About Voice Assistant
 - Display Tencent Jingle software version information, software license and service agreement, and Tencent privacy policy.

4.6.4 Radio

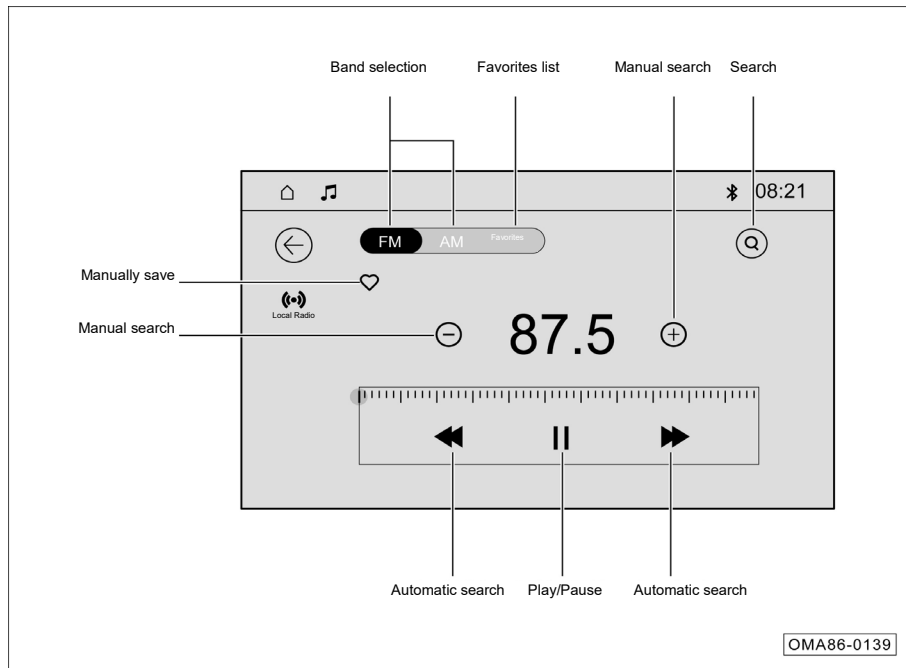

The AV main unit enters the radio playback interface in the following ways:

- Click the "Local FM" card in the main interface of the main unit to enter the radio mode.
- Shortly press the "MODE" button on the control panel continuously to switch to radio playback.
- Shortly press the "MODE" button on the left side of the steering wheel continuously to switch to radio playback.

4. Operation of Systems and Equipment

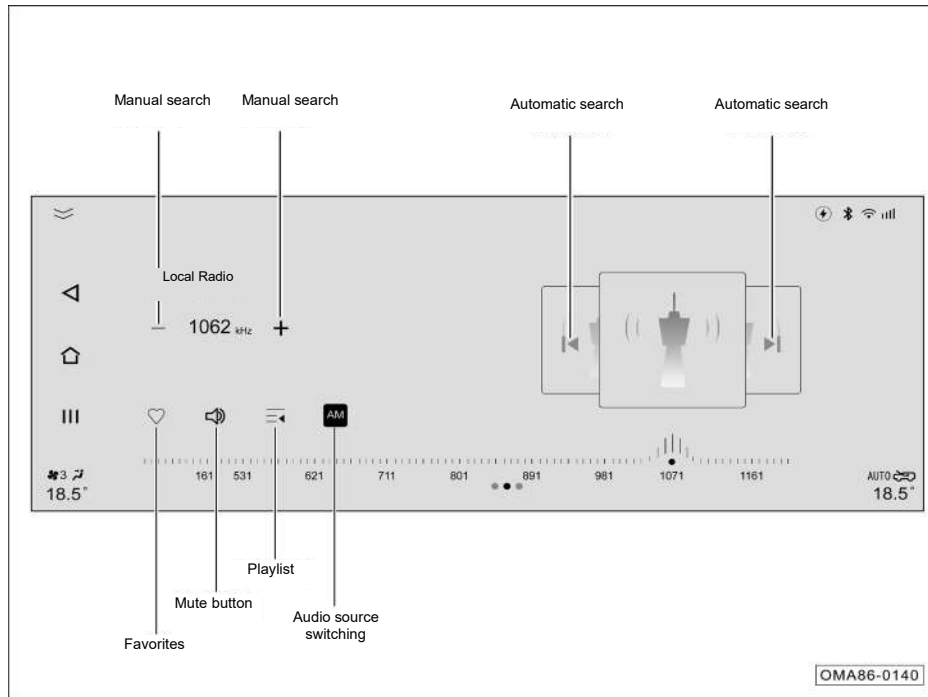

The AVNT main unit enters the radio playback interface in the following ways:

- Click “Radio card” in the main interface to enter the radio mode.
- Shortly press the “MODE” button on the control panel continuously to switch to radio playback.
- Shortly press the “MODE” button on the left side of the steering wheel continuously to switch to radio playback.

i NOTE

The radio station is divided into two modes: local radio and online radio, and only local radio is introduced here.

4.6.5 USB playback

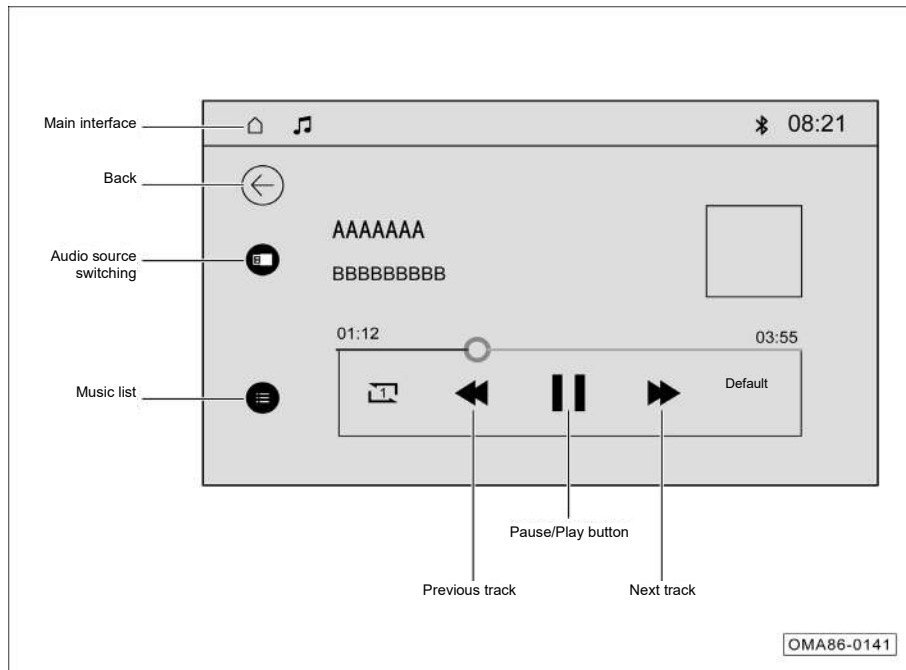

The AV main unit enters the USB music playback mode in the following ways:

- Click “Local Music” card in the main menu interface to enter the front media source selection interface and click “USB” to switch to the USB music playback mode.
- Shortly press the “MODE” button on the control panel continuously to switch to USB music playback mode.
- Shortly press the “MODE” button on the left side of the steering wheel continuously to switch to USB music playback mode.

i NOTE

If there is iPod function, refer to the operation methods for USB.

4. Operation of Systems and Equipment

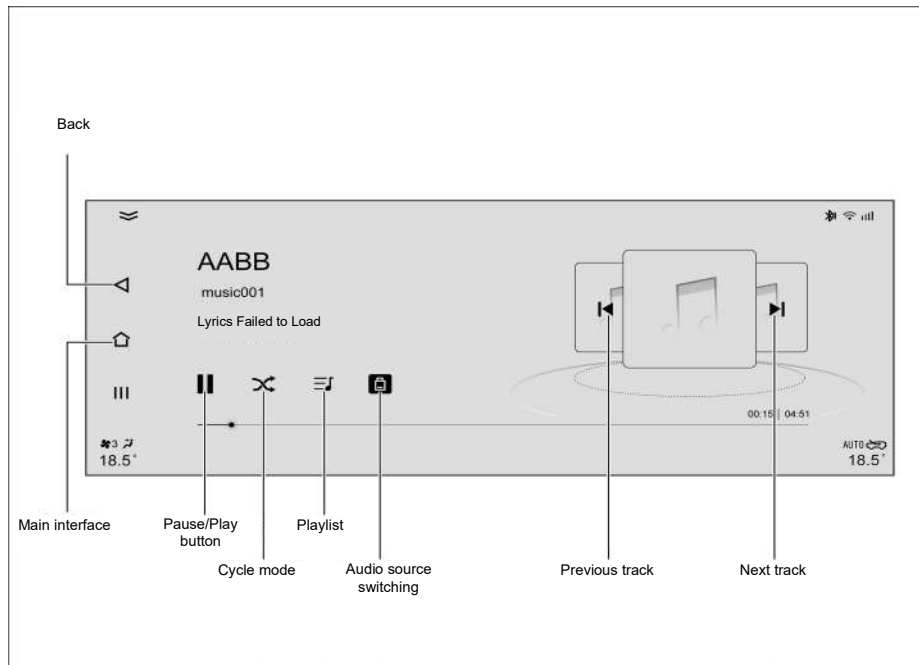

The AVNT main unit enters the USB music playback mode in the following ways:

- Click “QQ Music” soft key in the application menu interface to enter the music application interface, click “Local Music” and then click “USB”.
- Shortly press the “MODE” button on the control panel continuously to switch to USB music playback mode.
- Shortly press the “MODE” button on the left side of the steering wheel continuously to switch to USB music playback mode.

i NOTE

The music application interface has three functions: Music hall (Online music), Local Music, My Music, and only Local Music is introduced here. The AV system supports USB flash drives with capacity up to 32GBFAT, FAT32 and ExFAT.

4.6.6 Bluetooth function

Bluetooth mode of AV main unit

Enter the Bluetooth mode in the following ways:

- Click “Bluetooth Phone” card in the More menu interface to enter the Bluetooth mode.
- In non-call mode, shortly press  button on the left side of the steering wheel to enter the Bluetooth mode.

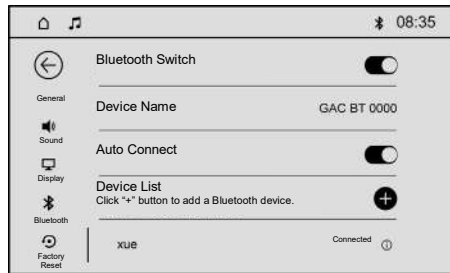



- If there is no Bluetooth device connected, use the above method to enter the Bluetooth Settings interface.
- Click “+” soft key on the right side of the device list to turn on Bluetooth visibility.

- Connect the mobile phone to the device according to the prompted device name and MAC address, and enter the PIN code in the prompt box to add it to the device list.

Bluetooth mode of AVNT main unit

Enter the Bluetooth mode in the following ways:

- Click “Bluetooth Phone” soft key in the application menu interface to enter the Bluetooth mode.
- In non-call mode, shortly press  button on the left side of the steering wheel to enter the Bluetooth mode.
- Click  button in the drop-down menu to enter the Bluetooth mode.

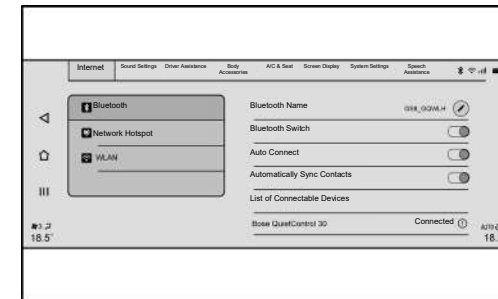

- If there is no Bluetooth device connected, use the above method to enter the Bluetooth Settings interface.
- After turning on the Bluetooth function, the OBU will automatically search for nearby connectable devices and display them in the list.
- Follow the prompts to connect the mobile phone successfully.
- Click “Connected” in the list of connectable devices to disconnect the Bluetooth device.

4. Operation of Systems and Equipment

Bluetooth connection failure

Possible cause	Solution
The device Bluetooth is set incorrectly	Set the device Bluetooth so as to be "Visible to Everyone" or can be searched for or open for detection
The current device is not compatible with the in-car Bluetooth system	Confirm the compatibility of the device with the Bluetooth version, upgrade the mobile phone system to the latest version and try again
The mobile phone Bluetooth was connected to other devices	It is recommended to delete the Bluetooth devices that was connected

4. Operation of Systems and Equipment

4.6.7 System setting (applicable to cars with AV main unit)

In the More menu interface, click “System Settings” card or shortly press “SET” button on the control panel to enter the System Settings interface. In the Settings interface, click an option to select it, click the slider  to turn on or off the function, and drag the progress bar to make adjustment.

Settings group	Function	Description	Optional settings
General	Language	Change display language	Chinese/English
	Time	Set time and date	24-hour system/setting
	Connect iPhone first	Set the system to connect to Pod first when connecting to a mobile phone	CarPlay/iPod
	Version	View information on main unit software version	/
	Vehicle Information	View main unit information	/
Sound	Multimedia volume	Adjust radio, USB music, Bluetooth music and app store music volume	0~30
	Call volume	Adjust voice recognition/Bluetooth call volume	0~10
	3D sound effect	Choose the sweet spot	Off/Driver/All passengers
	Preset sound effect	If you turn off the 3D sound effect and choose to customize the preset sound effect, you can adjust the Treble, Alto and Bass manually	Classic/Pop/Jazz/Rock/Default/Custom
	Speed-sensitive volume control	Adjust the volume change as the car speed increases or decreases	Not sensitive/Weakly sensitive/Generally sensitive/Strongly sensitive
	Sound field	Adjust the sound field position by touch	Reset
	Power on volume	Set the volume at power on	Unchangeable/Adaptive
	Touch tone	Adjust the touch tone of the touch screen	Off/Modern/Retro
	Assist chime and media sound	Select the volume of the AV system when driving assist warning (such as reversing)	Unchangeable/Mute
	Locking/unlocking chime	Set the car to chime while locking/unlocking	On/Off

4. Operation of Systems and Equipment

Settings group	Function	Description	Optional settings
Display	Screen brightness	Adjust the screen brightness	/
	A/C interface hold time	Set the time for keeping the A/C interface after no operation	5s/10s/15s/30s
Bluetooth	Bluetooth Switch	Turn the Bluetooth on or off	On/Off
	Device Name	Show the Bluetooth device name	/
	Auto Connect	Set whether to connect Bluetooth device automatically	On/Off
	Device List	Add a device to the device list	/
Factory reset	/	Restore the above settings group to the factory defaults	Restore

4. Operation of Systems and Equipment

4.6.8 Car setting (applicable to cars with AV main unit)

In the More menu interface, click “Car Settings” card or continuously shortly press “SET” button on the control panel to enter the Car Settings interface. In the Settings interface, click an option to select it, click the slider  to turn on or off the function, and drag the progress bar to make adjustment.

Settings group	Function	Description	Optional settings
Driver Assistance	Safe speed warning (km/h)	Set the safe speed warning	Range: Off~200
	Steering mode	Set the steering force of the steering wheel	Comfort/Standard/Sport
	Parking assist chime	Set the parking assist chime	On/Off
	ESPOFF button	Turn ESP on or off	ESP On/TCS Off/ESP Off
Intelligent body	Intelligent active lock*	/	On/Off
	Intelligent active unlock*	/	On/Off
	Remote unlock	Set remote unlock of doors	All doors/Driver door only
	Automatic unlock	/	On/Off
	Remote control windows & sunroof	/	On/Off
Light control	Follow me home	Select Follow me home light mode	Off/Low beam/Low beam and rear foglamp
	Daytime running light	/	On/Off
A/C settings	Intelligent air quality control*	/	On/Off
	A/C comfort	Select A/C comfort curve mode	Soft/Normal/Fast
	Sensitivity adjustment of intelligent air quality control*	Select the sensitivity mode of intelligent air quality control	Low/Medium/High
	Maximum air volume in auto mode	Select the air volume in auto mode	Low/Medium/High

4. Operation of Systems and Equipment

Category	Service name	Service introduction	Service usage			Notification method		
			Website	APP	button	Website	APP	SMS
Car care service	Query about car conditions ^{*1}	You can query about the car conditions in real time through the mobile terminal GAC Motor app, including the door lock status, tire pressure, etc.	○	○		○	○	
	Self-service diagnosis ^{*1}	You can query about the car conditions in real time through the mobile terminal GAC Motor app which will prompt you when an abnormality occurs.	○	○		○	○	
	Car abnormality alarm	The in-car intellisense terminal of the mobile terminal GAC Motor app monitors the car conditions in real time, and actively uploads the information when an abnormality occurs. According to the abnormality information, the specialists in GAC Motor Service Center will contact you and remind you to go to the GAC Motor authorized shop for inspection as soon as possible.	Automatic			○		○
Safety and security service	Car anti-theft and abnormal event alarm	When the engine is shutdown, if illegal movement of the car (such as towing) occurs, the GAC Motor Service Center will send a text message to notify you.	Automatic					○
		Break-in alarm: When the doors are locked and the engine is shutdown, in case of a break-in, the GAC Motor Service Center will send a text message to notify you.						

*1: It can be performed only when the car is armed.

5.1 Starting and driving

5.1.1 Engine start/stop button



When the intelligent remote control key is detected in the car, the engine start/stop button can be operated to switch the power state.

When the “P” position is engaged and the brake pedal depressed, the engine start/stop button indicator lamp turns green. At this time, press the engine start/stop button to start the engine.

When the brake pedal is not depressed, press the engine start/stop button to switch the positions in the following order: “OFF → ACC → ON → OFF”.

- OFF: The engine start/stop button indicator lamp goes out.
- ACC: The engine start/stop button indicator lamp turns orange, and the circuits of 12V power supply and other accessories are connected.
- ON: the engine start/stop button indicator lamp turns orange and the circuits of all electric equipment are connected.

i NOTE

- When the engine start/stop button is switched from “OFF” to “ACC” and remains in “ACC” position for one hour, it will enter the battery saver mode and automatically return to “OFF” position.

Limphone mode

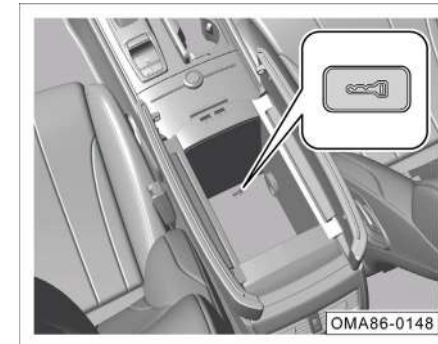

When “No key detected” appears on the instrument cluster display due to low battery of the intelligent remote control key, you can try to place the key horizontally at the mark on the bottom of the armrest box, and then press the engine start/stop button to switch it to “ACC” or “ON” position or depress the brake pedal, and after the engine start/stop button indicator lamp turns green, press the engine start/stop button to start the engine.

This is an emergency start method. Please replace the intelligent remote control key battery as soon as possible.

5. Driving Guide

5.1.2 Engine start

- Enter the car with the intelligent remote control key.
- Make sure the “P” or “N” position is engaged.
- Depress the brake pedal and ensure that the engine start/stop button indicator lamp turns green.
- Press the engine start/stop button to start the engine.

NOTE

- In case of a cold start, run the engine at idle speed to allow it to warm up before driving. At the same time, because the valve tappet takes a few seconds to reach the normal working pressure, operating noise will be heard, which is normal.
- If the engine cannot be started normally due to the brake signal, you can try to switch the engine start/stop button to “ACC” position. Ensure that the transmission is in the “P” or “N” position, and press and hold the engine start/stop button for 15 seconds to force the engine to start.

NOTE

- The engine start time cannot exceed 15s. If the engine is not started successfully, you must wait about 30s before next attempt.
- Do not depress the accelerator pedal hard after starting to make the engine run at high speed or overload, otherwise the engine will easily be damaged.
- If the battery level is low and the engine cannot be started, try to start it by a jumper cable. => [See Page 276](#)
- Never start the engine by pushing or pulling.

WARNING

- **Do not start the engine for a long time in a poorly ventilated place or an enclosed room. The engine exhaust contains harmful gases, which can make people comatose and even suffocate.**
- **Never let the engine idle at unattended condition.**
- **Never install start aids to start the engine. Otherwise, the engine may run at high speed or explode.**

5.1.3 Engine shutdown

- Park the car steady and apply the park brake.
- Engage the “P” position.
- Press the engine start/stop button to shut down the engine.

NOTE

After the engine is shut down, the radiator fan may still run for a while.

Emergency shutdown

When the car is running, give a long press on the engine start/stop button or shortly press the engine start/stop button three times in succession to switch it from “ON” to “ACC” position for emergency engine shutdown.

The engine can only be restarted in a few seconds after emergency shutdown. Restart the engine as follows:

- Engage the “P” or “N” position and press the engine start/stop button to start the engine.

WARNING

Emergency shutdown is forbidden during normal driving, which can easily lead to car damage, safety protection, power steering failure and traffic accidents.

Precautions for parking

When parking, engage the “P” or “N” position and pay attention to the following:

- Pay attention to the direction in which the car is parked, for fear of damage to the green belt with the exhaust gas spraying on the plants.
- Try to park on a flat and straight road instead of a steep slope.
- When parking on a slope, regardless of whether the car is facing the top or bottom of the slope, the front wheels should be turned towards the curb.
- Apply the park brake, shut down the engine, and turn off all lights and other electrical consumers.
- When leaving the car, be sure to carry valuables and the key with you, and check that the sunroof, windows, doors, and trunk lid are closed.

WARNING

- **When leaving the car, be sure to shut down the engine, apply the park brake and carry the key with you.**
- **Do not leave any person in the car, otherwise suffocation, coma and even death can easily occur in the closed space.**
- **Do not park the car near flammable and explosive materials.**

5. Driving Guide

5.1.4 Gear description

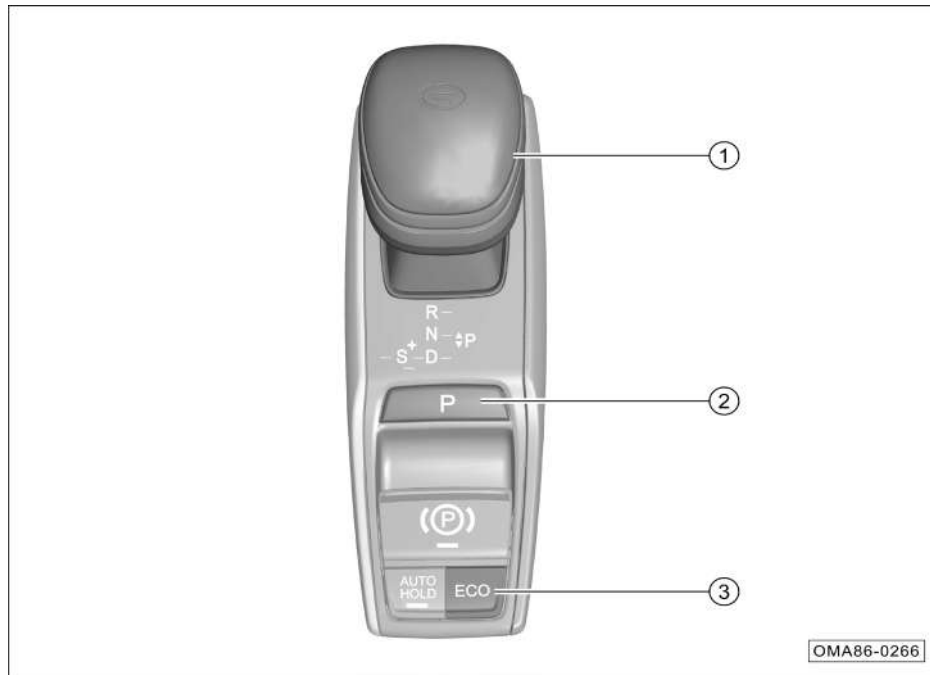

- ① Gearshift lever
- ② “P” position button
- ③ “ECO” mode button

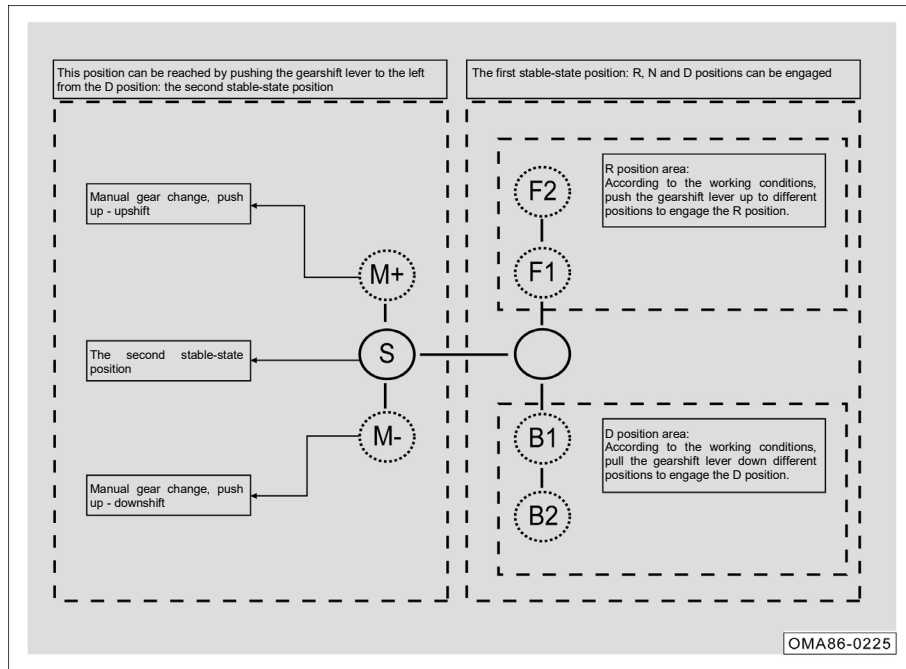

The Shift by Wire and in-line bistable gear arrangement are used in the transmission system. In the first stable state, the “R”, “N” and “D” positions can be engaged, and in the second stable state, the “S” and “M+/M-” positions. “P” position and “ECO” mode are engaged using buttons. When the engine start/stop button is in “ON” position, after a gear change, the instrument cluster displays the information on corresponding gear.

WARNING

The “R” or “P” position can be engaged only when the car is completely stationary, otherwise the transmission will be damaged.

5. Driving Guide

P: Parking position

- When the car is completely stationary and a position other than “P” position is engaged, press the “P” position button to engage the “P” position.

In the following two working conditions, the Shift by Wire will automatically engage the “P” position.

- When a position other than “P” position is engaged, the engine start/stop button is switched from “ON” to “OFF” or from “OFF” to “ON”, and the car speed is less than or equal to 3km/h, the “P” position will be engaged automatically.
- When the driver seat belt is not fastened + the driver door is open + the brake is not applied, and the car speed is less than or equal to 3km/h, the “P” position will be engaged automatically.

NOTE

When the shift system fails and the “P” position can not be disengaged, please contact the GAC Motor authorized shop for repair.

R: Reverse position

- With the car completely stationary and the “P”, “D”, or “S” position (in the “S” position, you need to set the gearshift lever to the first stable state to perform the following operations) engaged, depress the brake pedal and push the gearshift lever up to the F2 position to engage the “R” position.
- When the car is completely stationary and the “N” position is engaged, depress the brake pedal and push the gearshift lever up to the F1 or F2 position to engage the “R” position.

N: Neutral position

- When the “P” position is engaged, depress the brake pedal and push the gearshift lever up to the F1 position to engage the “N” position.
- When the “D” or “S” position (in the “S” position, you need to set the gearshift lever to the first stable state to perform the following operation) is engaged, push the gearshift lever up to the F1 position to engage the “N” position.
- When the “R” position is engaged, pull the gearshift lever down to the B1 position to engage the “N” position.

WARNING

- Do not allow the car to coast in neutral, otherwise it will easily cause an accident.
- In the first stable-state position, it is not allowed to engage any position when the car is not parked steady, which is easily to cause damage to the car or accidents.

D: Forward position

When the car is moving forward, this position is normally engaged. At this time, the system will automatically upshift or downshift according to the engine load and car speed.

- When the “P” position is engaged, depress the brake pedal and pull the gearshift lever down to the B1 or B2 position to engage the “D” position.
- When the “R” position is engaged, depress the brake pedal and pull the gearshift lever down to the B2 position to engage the “D” position.
- When the “N” position is engaged, depress the brake pedal (only required when the car speed is less than or equal to 3km/h) and pull the gearshift lever down to the B1 or B2 position to engage the “D” position.
- When the “S” position is engaged, move the gearshift lever to the right to the first stable-state position to engage the “D” position.

S: Forward position

The “S” position is for sport mode. When this position is engaged, the transmission will shift into a lower gear according to the changes in resistance (such as traction, climbing a long slope, etc.), and the engine will run at a higher speed to give more power. The “S” position is mainly used for driving in pursuit of power, and also for hill driving, which can avoid frequent gear changes.

- When the “D” position is engaged (if the gearshift lever is in other position, turn it to the “D” position), move the gearshift lever to the left to the “S” position to engage this position.

When the car enters this mode, move the gearshift lever up or down to upshift/downshift. At this time, the transmission enters manual mode.

Economy mode

When the car enters this mode, both the transmission control unit and the A/C system will adopt the economic strategy.

- When the engine start/stop button is in “ON” position and a position other than “P” position is engaged, press the “ECO” mode button to enter the economy mode.

5. Driving Guide

NOTE

- When the car enters the economy mode, the “ECO” indicator lamp on the instrument cluster lights up.
- The economy mode has a memory function. When the engine is shut down and restarted, the transmission is still in the economy mode.

5.2 Brake system

5.2.1 Service brake

Under certain driving and weather conditions, squeaks, screams, or other noises may be heard at the brake when the brake pedal is depressed or lightly stepped on for the first time, or braking noise accidentally heard during light or moderate intensity braking, especially for new cars (their brakes have not undergone running-in). This is normal and does not mean that the brake system is malfunctioning or brake safety and performance is impacted.

NOTE

- If there is metal friction rasp, the brake pad may be worn to the limit. Please go to the GAC Motor authorized shop for inspection as soon as possible.
- If the steering wheel vibrates or twitches continuously during braking, go to the GAC Motor authorized shop for inspection as soon as possible.

NOTE

- Do not rest your foot on the brake pedal during driving, otherwise the temperature of brake will rise to an abnormally high level, and the brake pad and brake disc will wear excessively, increasing the braking distance.
- When driving down a long slope or a steep slope, downshift to a lower gear (manual mode) to avoid continuous use of the brake. This can make full use of engine braking and reduce brake load.
- Continuous use of the brake will cause the brake to overheat and result in a temporary loss of braking performance.

i NOTE

- Under normal driving conditions, the brake pad will wear, and brake pad dust will accumulate on the wheel. The wheel dust are inevitable and will not affect the braking performance.
- If the brake pad and brake disc are not used or used at a low frequency resulting in corrosion, noise may heard at the brake during the first use. This is normal. It is recommended to choose a safe area and road conditions and brake several times to clean the brake pad and brake disc.

Brake booster

The brake booster is used to increase the pressure applied by the driver on the brake pedal, and it only works when the engine is running.

If the brake booster does not work properly due to a fault, or when the car is towed, the pedal effort must be increased to compensate for the boosting effect of the brake booster.

⚠ WARNING

- **Do not allow the car to coast with the engine shut down, otherwise it will easily cause an accident! Since the brake booster does not work at this time, the braking distance will be greatly increased.**
- **If the brake booster does not work (for example, when the car is being towed), the brake pedal must be depressed with much greater force than normal when braking.**

Braking effect and braking distance

The braking effect and braking distance are mainly affected by the driving environment, road conditions and driving style.

With the worn brake pad, the car cannot be braked effectively. The wear rate of the brake pad depends mainly on the use conditions and driving style. If the car is often used for city driving, short-distance driving, or as a racing car, it is recommended to check the brake pad thickness more frequently based on the maintenance interval specified in the Warranty Manual.

After wading, heavy rain or car washing, the brake pad may be wet or icy (in winter), resulting in a reduction in braking effect. In this case, the brake pedal must be lightly depressed to heat the brake by friction and evaporate the water to restore the braking effect.

5. Driving Guide

WARNING

A new tire and brake pad having not undergone running-in do not have the best adhesion and friction characteristics.

- **The new tire does not yet have the best adhesion, so you must drive carefully within the first 500km to avoid accidents!**
- **The new brake pad within the first 200 to 300km driving distance does not have the best friction characteristics, and the braking effect is slightly reduced, so it must undergo running-in. The braking effect can be compensated by increasing the force applied on the brake pedal. The new brake pad must also undergo running-in.**
- **When driving, do not get too close to other cars or bring the car to a situation where emergency braking is necessary. Being especially careful when driving with a new tire and new brake pad having not undergone running-in for fear of accidents.**

WARNING

When the brake is wet or icy or when the car is running on a salted road, the brake may lag, resulting in a longer braking distance. Therefore, be careful to prevent accidents.

- **A longer braking distance or a fault in the braking system will increase the accident rate.**
- **Lightly depress the brake pedal to check the brake.**
- **Lightly depress the brake pedal to dry the brake or remove ice or anti-skid salt from the brake.**

WARNING

Overheating the brake will reduce the braking effect and increase the braking distance!

- **Take care to avoid overheating the brake.**
- **When driving downhill, the brake load increases and the brake is easily overheated.**
- **It is recommended to engage a low gear (manual mode) before driving down along a long and steep slope to reduce the car speed, make full use of the engine braking effect, and reduce the brake load.**
- **Do not continuously depress the brake pedal. This will make the brake overheat and increase the braking distance. Brake intermittently according to road and traffic conditions.**

⚠ WARNING

- **The brake fluid must be changed every two years. If the brake fluid stays in the system for a long period, air resistance may occur in the pipeline during braking, reducing the braking effect and impairing driving safety; it may even cause failure of the brake system, resulting in accidents.**
- **If a non-standard front spoiler is installed or the spoiler is damaged, it will block the cooling airflow to the brake, causing the brake to overheat and deteriorate the braking effect.**

5.2.2 Electric park brake (EPB)

The driver can apply or release EPB by operating the EPB button. On slopes, HSA can be used. If the accelerator pedal is depressed when the car is parked, the EPB will be automatically released to provide driving assistance for the driver.

👁 NOTE

The EPB uses a fixed force to brake the car according to the gradient.

- If the car parked on a slope rolls down, the EPB will automatically increase the brake force.
- If the car continues to roll down after the brake force is automatically increased, please depress the brake pedal to apply brake and drive the car to a flat road and stop it. Contact the GAC Motor authorized shop for inspection in time.

Apply static park brake



- When the car is stationary, pull up the EPB button. The button indicator lamp and the indicator lamp (P) in the instrument cluster will light up, indicating that the EPB has been applied.
- When the “P” position is engaged, the EPB will be applied automatically.

5. Driving Guide

i NOTE

- The EPB can also be applied when the engine start/stop button is in the “OFF” position.
- After the car is parked steady, the EPB should be applied first.
- When applying the EPB, operating noise can be heard, which is normal.
- If there is a trailer or during parking on a steep slope, after the first application of EPB, the EPB button can be pulled up again to ensure the maximum braking effect.
- On a slope with a gradient of 17% to 30%, in 5 minutes after the EPB is applied for the first time, it will be applied again. At this time, operating noise can be heard, which is normal.

⚠ WARNING

- **The EPB must be applied when parking.**
- **When the car is running, the EPB can not be used to reduce the car speed if it is not necessary. The EPB only applies brake force to the rear wheels, which is likely to cause traffic accidents.**

Release static park brake



- When the engine start/stop button is in the “ON” position, depress the brake pedal.
- Press the EPB button. The button indicator lamp and the indicator lamp in the instrument cluster will go out, indicating that the EPB has been released.

i NOTE

- If the brake pedal is not depressed, pressing the EPB button can not release the EPB, and the instrument cluster display will show an alarm message, with a beep alarm.
- When releasing the EPB, operating noise can be heard, which is normal.
- When the car battery is low, the system cannot release the EPB. If conditions permit, you can connect a jumper cable for emergency start=>see page 276, and then release the EPB. Contact the GAC Motor authorized shop for inspection.
- If the EPB has not been used for a long time, the system will automatically test it, and the operating noise can be heard.

Apply dynamic emergency brake

- If the service brake fails while the car is running, you can try to continuously raise the EPB button for emergency braking. Release the EPB button or depress the accelerator pedal, the system will exit emergency braking.

👁 NOTE

In the following cases, operate the EPB again. If the fault has not been eliminated, please contact the GAC Motor authorized shop for inspection.

- If the indicator lamp flashes red continuously, it indicates that the EPB is partially engaged/disengaged or the system is malfunctioning.
- If the indicator lamp lights red when EPB is not applied, it indicates that the system is abnormal.
- If the indicator lamp lights yellow, it indicates that a fault has been detected in the electronic system and the EPB has been degraded.

5. Driving Guide

NOTE

- Do not use dynamic emergency braking when it is not necessary. It is easy to cause traffic accidents, increases the braking distance in comparison to depressing the brake pedal to brake, and shorten the service life of the park brake system.
- When the car is running, if you pull up the EPB button, the instrument cluster display will show an alarm message, with a beep alarm.
- During application of dynamic emergency brake, release the EPB or depress the accelerator pedal, and the EPB will be released. If you pull up the EPB button continuously until the car stops, the EPB will remain engaged.

AUTO HOLD

AUTO HOLD can keep the car still automatically based on the driver's braking needs; when the system detects the driver's intention of starting off (such as depressing the accelerator pedal), it will automatically release the brake; AUTO HOLD can ensure the ease of starting off when the brake is released automatically according to the information on the slope; AUTO HOLD can make the car still by active pressurization when the brake force is insufficient.

On and off



- When the engine is started, the driver door closed and the driver seat belt fastened, press the AUTO HOLD button. The button indicator lamp will light up, and the AUTO HOLD function will be turned on. Press the button again, the button indicator lamp will go out, and the AUTO HOLD function will be turned off.

Activation

When this function is turned on, it supports automatic holding and releasing of brake under start & stop conditions. When the driver brakes the car, the car will be automatically parked to avoid rolling down when starting off.

Deactivation

The AUTO HOLD will be deactivated under the following conditions, and the park brake will not be locked:

1. Depress the accelerator pedal when starting off.
2. The engine stops while the car is running.
3. Manually release the EPB.
4. When depressing the brake pedal, press the AUTO HOLD button.

To ensure safety, the AUTO HOLD function that is activated under the following conditions will be turned off and the park brake will be locked:

1. Shut down the engine.
2. Open the driver door or unfasten the seat belt when the car is stopped.
3. Press the AUTO HOLD button to turn off AUTO HOLD.

NOTE

When driving into a mechanism such as a car washing device that transports the car through a conveyor belt, the AUTO HOLD function must be turned off, otherwise the car cannot move or deviates from the driving trajectory.

EPB self-learning

In some cases (for example, when the battery suddenly loses power or the car has not been used for a long time), the indicator lamp  will flash red, and EPB does not work when you pull up the EPB button. At this time, the driver is required to depress the brake pedal, press and then pull up the EPB button, so that EPB button indicator lamp does not flash and EPB can complete self-learning and work normally.

5. Driving Guide

5.3 Electronic service brake system

5.3.1 Anti-lock braking system (ABS)

When the driver brakes, ABS automatically monitors the slip rate of the front and rear wheels. Before the wheels are locked, the wheel cylinder hydraulic pressure is adjusted through the stages such as pressure holding, depressurisation, and pressurisation to keep the wheel slip rate within the specified range, preventing the wheels from being locked.







With the brake pedal depressed in an emergency, when the ABS enters the working state, the driver will feel the brake pedal shuddering, accompanied by the “click” sounds when the master cylinder is running. When the brake pedal is depressed in the following situations, ABS works and shuddering can be felt which is normal:

- During gear changes.
- During emergency braking.
- During sharp turns at high speed.
- When driving on slippery roads.
- When passing over bumps or ditches.
- When driving off immediately after starting.

Anti-lock braking system (ABS) indicator lamp

After the engine start/stop button is switched to “ON” position, the indicator lamp  will be on for a few seconds and go out after the system completes self-test.

The following conditions indicate that the system is faulty:

- After the engine start/stop button is switched to “ON” position, the indicator lamp  does not come on.
- After the engine start/stop button is switched to “ON” position, the indicator lamp  will not go out after it is on for a few seconds.
- When the car is running, the indicator lamp  lights up.
- When there is a fault in the ABS, the indicator lamps ,  and  light up.

Electronic Brake Force Distribution (EBD)

As a part of ABS, EBD balances the distribution of brake force on the front and rear wheels according to the car load during normal braking.

Hydraulic Brake Assist (HBA)

HBA makes use of the pressure quickly built up in the brake system to assist you to shorten the braking distance in case of emergency. It fully utilizes the characteristics of ABS. After the brake pedal is released, HBA will be turned off automatically, and the brake system will restore to its normal working state.

WARNING



HBA can improve your driving safety, but it is impossible to exceed the laws of kinematics. Please adjust the driving speed according to the road conditions and traffic regulations.

5.3.2 Electronic Stability Program (ESP)

ESP can effectively reduce the risk of sideslip.

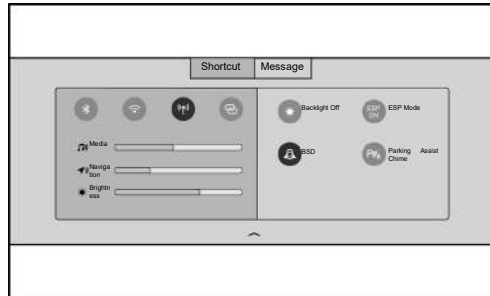
On and off









ESP is on by default when the car is running. Click the button  in "Drop-down Menu" interface of the AV system to turn off ESP. At this time, the indicator lamp  on the instrument cluster lights up and an alarm message is displayed.

NOTE

- For cars with AV main unit, turn on or off ESP by "Car Settings → Drive Assist → ESPOFF Button" of the main unit.
- When the car speed is above 80km/h, ESP will be automatically turned on.
- When the car speed is less than 80km/h, if ESP is turned off, press the button  to turn it on again.

ESP indicator lamp

- After the engine start/stop button is switched to "ON" position, the indicator lamp  and  will be on for a few seconds and go out after the system completes self-test.
- If ESP works during driving, the indicator lamp  will flash.
- After ESP is turned off, the indicator lamp  will light up.
- When ESP is faulty, the indicator lamp  will light up.

After the engine is started, if the indicator lamp  lights up, it indicates that ESP has been turned off, and the instrument cluster display shows an alarm message. You can try to turn off and then on the engine start/stop button to activate the system again. When the indicator lamp  goes out, it indicates that the system has fully entered the working state.

If the battery connector is disconnected from and then connected to the cable, the indicator lamp  may come on when the engine start/stop button is turned on, and then goes out after a short driving distance.

For driving safety, ESP should be turned on. The ESP function can be disabled in the following special cases:

- When the car travels with tire chains.
- When the car travels on roads covered with deep snow or on soft grounds.
- When the car is trapped on muddy roads, etc., and you need to move it back and forth.

5. Driving Guide

Traction Control System (TCS)

TCS is a subsystem of ESP. TCS determines if the driving wheel slips based on the speed of the driving wheel and the driven wheel. If the former exceeds the latter, TCS will limit the speed of the driving wheel to prevent the car from slipping.

Turn on or off TCS in the following ways: for cars with AV main:

- When ESP is turned on, TCS is also turned on.
- Turn off TCS by “Car Settings → Drive Assist → ESPOFF On” of the main unit.

Cars with AVNT main unit:

- When ESP is turned off or on, TCS is turned off or on accordingly.

5.3.3 Hill Hold Control (HHC)

HHC allows the driver to easily move his foot from the brake pedal to the accelerator pedal when driving off on a slope without application of the parking brake, so as to prevent accidents resulted from rolling down.

Activation conditions of HHC

- On a slope with a gradient of greater than 4%, when “P” or “N” position is not engaged, the EPB is not applied, and the driver depresses the brake pedal to stop the car and keep it still, if at this time, the driver releases the brake pedal, the HHC function will be activated to apply brake pressure and keep the pressure for 1 s.
- When the HHC function is working, if the engine torque exceeds the drag torque of the car, the brake pressure will be released and you will drive off successfully.
- During driving downhill with “R” position engaged, the HHC function will also work.

NOTE

- During driving off on a steep slope or driving downhill with “R” position engaged, HHC will automatically apply brake to prevent rolling down.
- HHC is integrated in the ESP system. If HHC fails, the ESP indicator lamp will light up, and a graphic prompt message will be displayed on the instrument cluster display.

5.3.4 Hydraulic Boost Failure Compensation (HBC)

When the vacuum booster fails, the HBC function can compensate for the temporary vacuum shortage caused by the vacuum failure and increase the brake pressure. Meanwhile the instrument cluster will indicate "Please Check HBC". In this case, please contact the GAC Motor authorized shop for inspection as soon as possible.

5. Driving Guide

5.4 Driver assistance systems

5.4.1 Adaptive cruise control (ACC)*

The adaptive cruise control, referred to as ACC, can automatically adjust the distance from the vehicle in front in the cruise control status at the cruising speed of 0~120 km/h.

Based on the millimeter wave radar installed on the front of the car and the intelligent forward camera on the windshield, ACC detects the relative distance and speed between the vehicle in front and the car on the same path:

- If a vehicle in front is stopped, ACC controls the car to follow the vehicle in front for automatic stop; if the vehicle in front is started, ACC controls the car to start again under certain conditions. After stop for a specific time, the car can be started by simply operating the RES/+ button or accelerator pedal as the vehicle in front is started.
- When a vehicle is in front and its speed is lower than the target speed set by the driver, ACC controls the car to maintain a safe distance from the vehicle in front.
- When no vehicle is in front, ACC controls the car to travel at the target speed set by the driver.

i NOTE

Precautions for use of radar and camera sensor. => See Page 195

⚠ WARNING

- **ACC is not a safety system, collision alarm or anti-collision system, but a comfort system, so the driver must always maintain control of the car and take full responsibility for the car.**
- **ACC must be used with caution according to the visibility, weather conditions, road and traffic conditions at the time. The driver must always keep control of the car and take full responsibility for the speed of the car and the distance from other vehicles.**
- **ACC cannot substitute for driver's attention and judgment. The driver should always be responsible for ensuring that the car travels safely at an appropriate speed and maintains an appropriate distance from other vehicles.**

Operational button

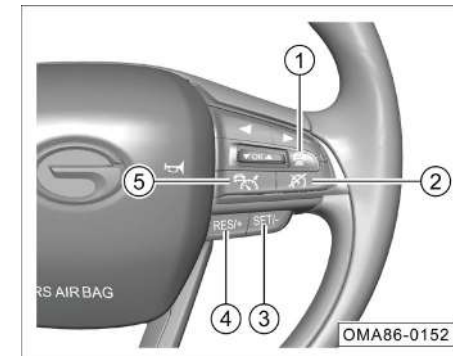

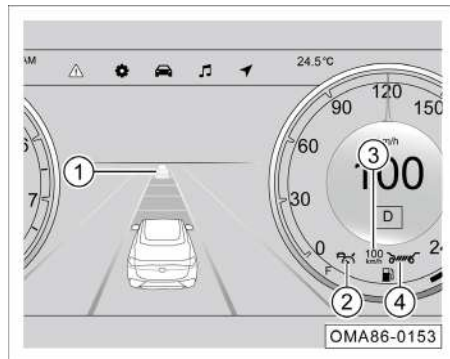

- ① : adjusting the distance from the vehicle in front when ACC is started
- ② : deactivating ACC
- ③ SET/-: setting ACC/deceleration
- ④ RES/+: resetting ACC/acceleration
- ⑤ : enabling/disabling ACC

Interface description



① indicates the detected vehicle in front.

② ACC indicator lamp:

- If the  indicator lamp comes on in white, it indicates that ACC is in the ready state and a target vehicle is in front; if the indicator lamp comes on in green, it indicates that ACC is working and a target vehicle is in front.
- If the  indicator lamp comes on in white, it indicates that ACC is in the ready state and no target vehicle is in front; if the indicator lamp comes on in green, it indicates that ACC is working and no target vehicle is in front.

- If the  indicator lamp comes on in yellow, it indicates that ACC is faulty. In that case, go to the GAC Motor authorized shop for inspection in time.

③ indicates the set cruising speed.



④ indicates the set cruising distance from the vehicle in front.

When the braking capacity of ACC is not enough to maintain a proper distance between the car and the vehicle in front, ACC will send a "driver takeover request", and the instrument cluster will display an alarm message and emit a sound simultaneously. In this case, the driver shall depress the brake pedal to reduce the car speed according to the system requirements.

ACC start

- If the  button is pressed, the corresponding indicator lamp in the instrument cluster will come on in white.
- If the SET/- button is pressed, the corresponding white indicator lamp in the instrument cluster will turn green, and the car will enter the ACC control status.



i NOTE

- The minimum setable cruising speed is 30 km/h.
- When the transmission is not in D gear, ACC cannot be enabled.
- When ACC is activated, the  indicator lamp in the instrument cluster comes on (when the  indicator lamp comes on, it indicates that a vehicle is in front), and meanwhile the instrument cluster shows the stored ACC speed and status.

5. Driving Guide

Exiting of ACC

ACC can be exited as follows:

- opening the driver's door.
- unfastening the driver's seat belt.
- depressing the brake pedal.
- setting the transmission to a gear other than D.
- pressing the  button (after that, the corresponding indicator lamp in the instrument cluster will turn white, ACC will be exited temporarily, but the set speed will be kept).
- pressing the  button (after that, the corresponding indicator lamp in the instrument cluster will go out, ACC will be exited, and the set speed will be cleared).
- pressing the EPB system button.
- when the ESP system is turned off.
- when the HDC system is turned on.

ACC can be reset by pressing the RES/+ button if exited as follows:

- depressing the brake pedal.
- pressing the  button.
- setting the transmission to a gear other than D (the gear should be shifted to D).
- pressing the EPB system button (the EPB system should be released).
- when the ESP system is turned off (the ESP system should be turned on again).

Resetting of ACC

When the corresponding indicator lamp in the instrument cluster is white, the ACC function can be reset by the following operations:

- pressing the RES/+ button, after which the corresponding indicator lamp in the instrument cluster will come on in green, the car speed will return to the value set during the last cruise, and the cruise control status will be entered. If the cruising speed has not been stored, ACC will set the current car speed as the cruising speed (if the current car speed is less than 30 km/h, it will set the cruising speed to 30 km/h).

ACC cannot be reset by pressing the RES/+ button if exited as follows:

- pressing the  button.
- setting the transmission to a gear other than D.

Increase of cruising speed

To increase the car speed, please perform the following operations:

- Depress the accelerator pedal to increase the car speed to a desired value, and press the SET/- button to cruise at a higher set speed.
- Press the RES/+ button once, after which the car speed will be increased by 1km/h.
- Press and hold the RES/+ button, after which the cruising speed will continue increasing at 5 km/h until the button is released.

i NOTE

- The maximum setable cruising speed is 120 km/h.
- When the accelerator pedal is depressed for acceleration, the car will temporarily exit the cruise control and run at the accelerated speed; after the accelerator pedal is released, the car will reset the cruise control.



Reduction of cruising speed

To reduce the car speed, please perform the following operations:

- If the SET/- button is pressed once, the car speed will be decreased by 1km/h.
- Press and hold the SET/- button, after which the cruising speed will continue decreasing at 5 km/h until the button is released or the cruising speed is 30 km/h. If the button is released, the car will remain at a lower speed.



Adjustment of the distance from the vehicle in front when ACC is started

After the engine start/stop button is placed at "ON" position, when ACC is turned on, the default distance from the vehicle in front is of fourth gear (the following distance of fourth gear is farthest).

By pressing the  button, the gear of the distance from the vehicle in front can be shifted recurrently in the order of "fourth gear → third gear → second gear → first gear → fourth gear...". At the same time, the cruising distance indicator lamp  in the instrument cluster will display the same number of cross bars as the ordinal number of the gear.

Activation of ACC after following stop

In the process of following a vehicle in front, the car will also be stopped if the vehicle in front is stopped. During a period of following stop, ACC will keep the car stationary by active pressurization of ESP; after a period of time, ACC will keep the car stationary by starting EPB. When the vehicle in front leaves, ACC of the car can be activated in three situations:

1. If the indicator lamp  is green, after the vehicle in front leaves, ACC can be reset actively and re-drive the car;
2. If the indicator lamp  turns white and EPB is not activated, ACC can be reset actively and re-drive the car by pressing the RES/+ button or depressing the accelerator pedal;
3. If the indicator lamp  turns white and EPB is activated, ACC can be reset and re-drive the car by depressing the accelerator pedal first, waiting for EPB to be automatically released, and then pressing the RES/+ button.

5. Driving Guide

Special driving environment

As limited by physical laws, ACC has a certain system limitation. In some driving environments, the driver may control the car after sensing the reaction of ACC or may fail to control the car as expected, so he must always be ready to control the car.

The following conditions affect functions of the radar system sensor and camera sensor, so the driver must be particularly alert under these conditions:

1. Decelerating to stop. If the vehicle in front is stopped by using the brake, ACC will also decelerate the car until the alarm exits, and the driver can actively intervene in the brake as needed to stop the car completely.

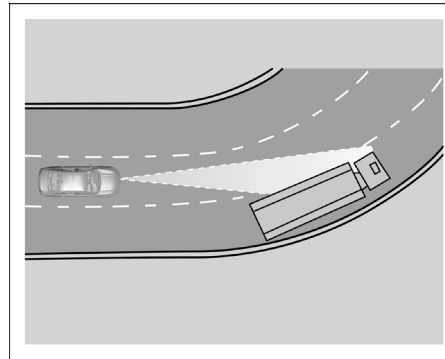

2. Driving through a curve. During driving through a curve, the radar sensor or camera sensor may fail to capture the vehicle in front in this lane, or may react to vehicles in adjacent lanes. In this case, ACC may not respond to the vehicle in front, or may brake the car to reduce the car speed. ACC can be exited by depressing the brake pedal or manually deactivating ACC.

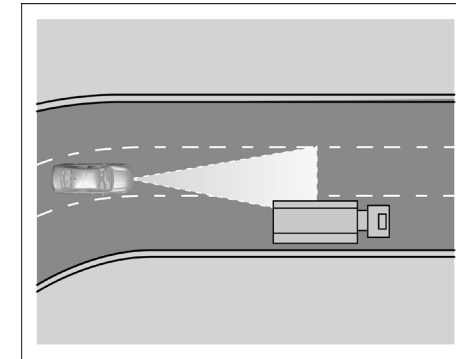

3. Driving out of a curve. During driving out of a long curve, because ACC will calculate the lane in advance, the radar sensor may react to vehicles in adjacent lanes and brake the car. This braking process can be interrupted by depressing the accelerator pedal.

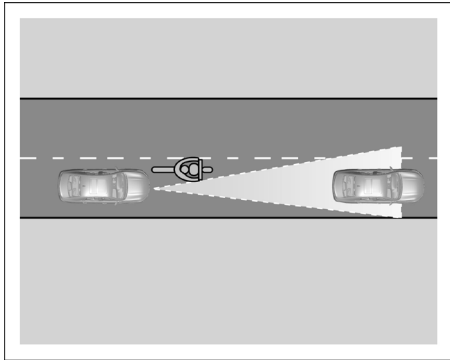

4. Narrow vehicles and Z-shaped traffic in front. When narrow vehicles and Z-shaped traffic in front enter the detection range of the radar sensor and the forward camera sensor, the sensors can be identified, but ACC cannot identify vehicles out of the detection range of the sensors. ACC do not readily identify narrow vehicles such as motorcycles and electric bicycles, and has a risk of failing to accurately identify the distance from modified vehicles and vehicles involving non-standard transportation in front, so it is not recommended to take such vehicles as the target vehicle in front.

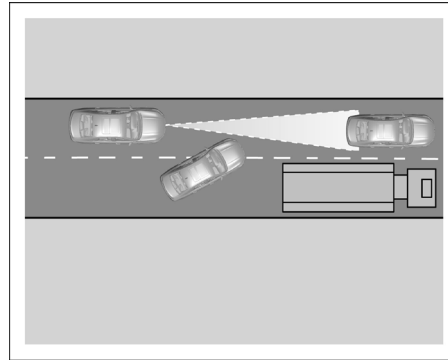

5. (a) When other vehicles change the lane. When a vehicle in the adjacent lane goes into this lane, if the vehicle does not enter the detection range in front of the car, the radar sensor may not detect the vehicle, thus resulting in a reaction lag of ACC.

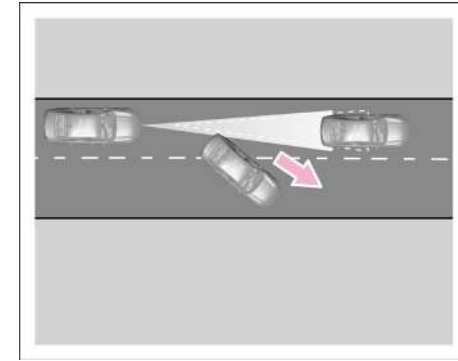

(b) If the target vehicle in front is driven out suddenly and a stationary or slow-moving vehicle appears at close range, the radar sensor and brake actuator will incur a reaction lag, causing delayed braking response.

5. Driving Guide

6. Influencing factors that may deteriorate the sensor function.

(a) Heavy rain, water mist, ice, snow or sludge may deteriorate the function of the radar sensor. As a result, ACC is turned off temporarily, and meanwhile the instrument cluster displays the following text messages: "ACC is currently unserviceable", "Please check the forward collision warning system" or "Please check the autonomous emergency brake (AEB)". At this time, a malfunction occurs to the forward collision warning system, ACC and autonomous emergency brake (AEB).

(b) Due to temperature difference or frost in low-temperature and alpine areas, the front windshield is frosted and fogged. As a result, the camera sensor is obstructed, and the instrument cluster displays the following text messages: "ACC is currently unserviceable", "Please check the forward collision warning system" or "Please check the autonomous emergency brake (AEB)". At this time, a malfunction occurs to the forward collision warning system, ACC and autonomous emergency brake (AEB).

7. Brake overheating. If the brake is overheated due to emergency braking or during traveling down a steep slope, ACC will be turned off automatically and temporarily, and meanwhile the instrument cluster will display the following text message: "ACC is currently unserviceable". After that,

ACC can no longer be activated. ACC can only be reactivated when the brake temperature drops to a reasonable degree.

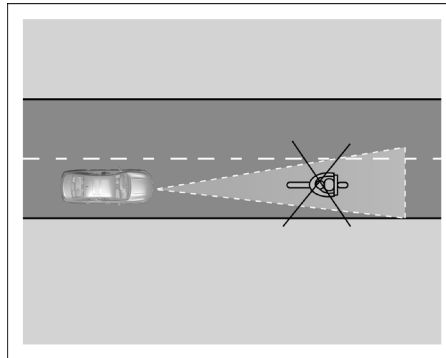

8. ACC should not be used in cities with traffic jams and poor visibility (night/backlighting/rain/snow/dense fog, etc.). ACC does not take braking measures to people, animals or narrow vehicles such as bicycles, motorcycles or electromobles, so the driver should be particularly alert. ACC may not take braking measures to drop frame trailers, approaching or stationary vehicles, and low-speed or stationary trucks, so the driver should be particularly alert and always be ready to take over the car.

WARNING

- **The driver must always be ready to control the car by himself.**
- **The adaptive cruise control (ACC) function cannot cover all driving scenarios and traffic, weather and road conditions.**
- **The function of ACC is only to supplement the driving assistance function. Even when used, the function cannot replace your attention and judgment. It is your responsibility to maintain a safe distance and speed, and you must intervene if the adaptive cruise control (ACC) fails to maintain a proper speed or distance from the vehicle ahead.**
- **For the sake of safety, it is not allowed to use ACC under conditions such as urban driving, traffic jams, multi-curve roads and poor road conditions (e.g. icing, fog, gravel, heavy rain, and phenomena prone to water skiing), because there is a danger of accident.**
- **Do not enable ACC during driving in roadless areas or on earth roads. ACC can only be enabled on hard roads.**

 WARNING

- **The takeover indication alarm of ACC only warns the driver of vehicles detected by its radar and camera sensors, so ACC may not send an alarm, or may send an alarm with a certain delay. Never wait for an alarm, but apply the brake as needed.**
- **The adaptive cruise control (ACC) is not a collision avoidance system. If the car is getting closer and closer to the vehicle in front and the car speed is higher than that of the vehicle in front, the braking effect of ACC cannot ensure safety, so the driver must depress the brake pedal to reduce the car speed when the car is possible to collide with the vehicle in front.**

 WARNING

ACC does not respond to or only makes a limited response to the followings:

- **large speed difference between the car and the vehicle in front.**
- **driving in different lanes, lane changes or driving on curves with small radius.**
- **pedestrians, animals, bicycles, tricycles, stationary vehicles or unexpected obstacles.**
- **complex traffic conditions.**
- **oncoming traffic or cross traffic.**
- **low trailers or trucks, high frame/high body trucks, and vehicles with irregular/non-standard towing or characteristics.**

Therefore, be sure to notice traffic conditions and respond accordingly. Do not wait for the system to identify the target or apply the brake, but apply the brake as needed.

 NOTE

- ACC may not respond under certain circumstances. For example, when the car approaches a stationary obstacle such as a broken-down vehicle or a vehicle stuck in traffic jams, or when a vehicle traveling in the same lane approaches the car, ACC may not respond.
- ACC does not respond to people, animals and vehicles crossing or approaching the car in the same lane.
- During driving through crossroads, speed bumps, steep roads and zebra crossings, or at changing lanes, highway access, ramps or construction sections, it is required to exit ACC and adopt fully manual driving, lest the car should be automatically accelerated to the set speed, causing traffic accidents.

5. Driving Guide

NOTE

- ACC can automatically drive the car out after a short stop or confirmation from the driver (control of buttons or accelerator pedal). During this period, the driver must ensure that there are no obstacles or other traffic participants such as pedestrians/bicycles/motorcycles /tricycles directly in front of the car.
- Do not bump the radar sensor and camera sensor. If the sensor is misaligned due to bumps, even after correction, it will still deteriorate the system performance and even cause the system shutdown.
- If the brand label or radar surface is dirty or covered by heavy rain, ice, snow, mud, etc., ACC may not function, and the instrument cluster will display the message "Please check ACC". After dirt is cleaned off the sensor surface, the function will be reset and return to normal.

NOTE

- Do not spray the front bumper with car paint at will. After spraying, the performance of the forward radar may be degraded.
- Do not spray or decorate the car logo at will. After spraying or decoration, the performance of the forward radar may be degraded.

NOTE

- ACC can only achieve limited braking force, not emergency braking.
- Please be careful not to place a foot on the accelerator pedal unintentionally; otherwise, ACC will no longer brake the car. This is because if the driver depresses the accelerator pedal, the car speed and distance may be controlled excessively.
- If ACC fails to function as described in this chapter, do not continue using it, and go to the GAC Motor authorized shop for inspection in time.
- When the car is traveling in heavy rain or snow, and ACC is difficult or unable to identify the vehicle in front, ACC shall be turned off.
- If the car is getting closer and closer to the vehicle in front and the car speed is higher than that of the vehicle in front, the braking effect of ACC cannot ensure safety, so the driver must depress the brake pedal to reduce the car speed.

i NOTE

- ACC is unlikely to accurately identify all driving environments.
- When ACC is turned on, its status displayed on the instrument cluster display may be overwritten by other functions (for example, during a telephone call).
- When ACC brakes the car automatically after activation, there will be a sound different from manual braking sounds or the brake pedal will be depressed automatically, which is normal. This sound and pedal action are caused by the operation of the brake system, so there is no need to worry.
- For the sake of safety, the stored cruising speed will be deleted after the engine start/stop button is turned off.

i NOTE

- The accelerator pedal can be depressed at any time to increase the car speed. After the accelerator pedal is depressed, ACC will readjust the car speed to the previously stored value.
- If the car enters a tunnel, the radar and camera may enter the blind mode, and ACC may be turned off temporarily.

5. Driving Guide

5.4.2 Forward collision warning system *

The forward collision warning system assesses the danger level of pre-collision by detecting the relative distance and speed between the vehicle in front and the car according to the millimeter wave radar installed on the front of the car and the intelligent forward camera on the windshield and synthesizing driver's other operations (such as depressing the brake pedal or accelerator pedal), warns the driver as necessary, and timely reminds the driver to take measures to avoid or mitigate the collision in case of a collision risk.

i NOTE

Precautions for use of radar and camera sensor. => [See Page 195](#)

On and off



Working conditions of the forward collision warning system are met when the engine start/stop button is set to "ON" position and the car speed is greater than 30 km/h.

The forward collision warning system has a memory function in on/off state, and is on by default at delivery. To turn it on/off, perform the following operations:

- Press the  button to quickly enter the "System Settings → Driving Assistance → Longitudinal Driving Assistance" interface of AV system.

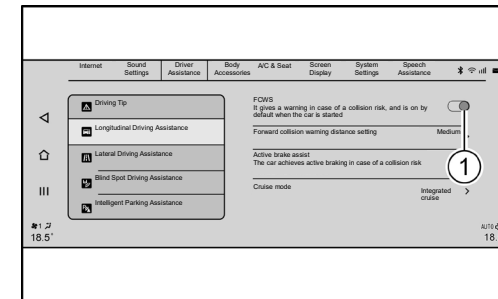

- Click the switch ① to turn on or off the forward collision warning system.

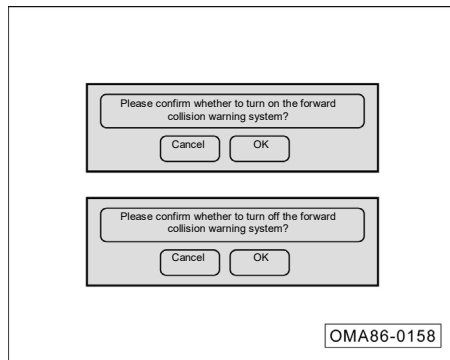

- When the forward collision warning system is turned on or off, a double confirmation window will pop up on the display of AV system. In this case, click “OK” or “Cancel” to confirm the switch operation.

i NOTE

After being turned off, the forward collision warning system will no longer warn of vehicle and pedestrian targets.

Alarm

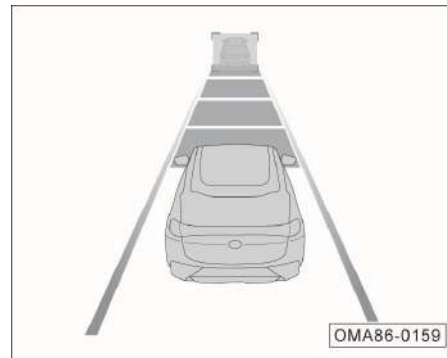

When the forward collision warning system gives a warning, there are three types of prompts:

1. Distance warning.

When the warning of forward collision warning system is triggered, an icon will flash on the instrument cluster.

2. Proximity warning.

When the warning of forward collision warning system is triggered, an icon will flash on the instrument cluster and an audible alarm will be given at the same time.

3. Short braking.

- When the car has a high risk of colliding with the moving target vehicle, short braking is triggered to better remind the driver that the brake shall be applied immediately.

i NOTE

- "Far, medium and near" can be set through the "System Settings → Driving Assistance → Longitudinal Driving Assistance → Forward Collision Warning Distance Warning" interface of AV system. There is a memory function for the forward collision warning distance to remember the last set warning distance.
- Depressing the accelerator pedal or turning the steering wheel will terminate the warning of forward collision warning system.

 **WARNING**

It is impossible for the forward collision warning system to violate the laws of physics. Never use the convenient functions provided by the forward collision warning system to make risky travel.

- **The forward collision warning system is unlikely to remind the driver to avoid collisions under any circumstances.**
- **In a complex driving environment (e.g., during traveling on a circuitous road), the forward collision warning system may give an unnecessary warning.**
- **If the forward collision warning system gives an warning, the driver must apply the brake to reduce the car speed or avoid obstacles according to traffic conditions.**
- **The forward collision warning system is only a warning system to remind the driver to avoid collisions. Since the system does not replace the driver in providing the corresponding active brake assistance when the warning is triggered, the driver must always keep control of the car and take full responsibility for the speed of the car and the distance from other vehicles.**

5.4.3 Lane departure warning system *





The lane departure warning system is designed to reduce accidents caused by unconscious lane departure.

The lane departure warning system detects the lane markings on the road and curbs through the camera installed on the windshield, and detects the road guardrails through the millimeter wave radar installed in the front of the car. In addition, it analyzes the driver's driving behavior and car movement status. When the driver unconsciously departs from the lane due to fatigue, distraction, or a phone call, the AEB issues a warning or intervenes in turning of steering wheel to assist in corrective steering adjustment. Generally, a warning will be issued or turning of steering wheel will be intervened in when the front wheels cross a lane marking or get beyond/crash a curb.

When the driver selects "Steering" or "Steering and Warning" as the LKA mode and the operating conditions of the lane departure warning system have met, the system monitors the torque applied to the steering wheel. When the driver keeps his hands off the steering wheel for a long time, the system will alert the driver.

On and off



When the engine start/stop button is set to "ON" position, press the button , the indicator lamp  on the instrument cluster lights up, indicating the system is activated; press the button  again, the indicator lamp  goes out, indicating the system is deactivated.

NOTE

The system has the button state memory function that keep the button at the same state with the one before last shutdown when the car has started.

5. Driving Guide

Select LKA mode

When the engine start/stop button is set to the "ON" position and the lane departure warning system is activated, go to "System Settings → Driving Assistance → Lateral Driving Assistance → LKA Mode" on the AV system display to select an LKA mode.

1. Steering assist

- When "Steering Assist" is selected, the system only intervenes in turning of steering wheel for corrective steering adjustment.

2. Warning

- When "Warning" is selected, the system only issues a warning.

3. Steering and warning

- When "Steering and Warning" is selected, the system will not only issue a warning but also intervene in turning of the steering wheel for corrective steering adjustment.

i NOTE

The system has the LKA mode memory function that keeps the LKA mode the same with the one before last shutdown when the car has started.

Alarm

The lane departure warning is only activated when "Warning" or "Steering and Warning" has been selected as the LKA mode.

- When the instrument shows a speed greater than 60km/h and the system detects at least one valid lane marking on one side, the indicator lamp  on the instrument cluster lights up green. It indicates that the system may issue a lane departure warning in this case. In case of only one lane marking, the system only alerts the driver to the side with the lane marking.

When the indicator lamp  lights up green, the system will not issue an alarm if the car departs from the lane under one of the following conditions.

- The accelerator pedal is depressed quickly.
- The brake pedal is depressed forcibly.
- Corresponding turn signal lamp has been activated.
- The hazard warning lamp has been activated.
- The steering wheel is turned quickly.
- The interval between two lane departure warnings is short.
- The car is running while rolling on or crossing over a lane marking constantly.

When the indicator lamp  lights up green, no condition mentioned above happens and the car accidentally departs from the lane, the system alerts the driver by displaying the lane marking reminder on the instrument cluster and beeping.

Steering assist

The corrective steering adjustment indication is activated only when "Warning" or "Steering and Warning" has been selected as assist mode. The steering assist is primarily the corrective steering adjustment.

When the instrument shows a speed greater than 60km/h and the system detects at least one valid lane marking on one side, the indicator lamp  on the instrument cluster turns on in green. This indicates that the system may intervene in turning of steering wheel for corrective steering adjustment. In case of only one lane marking detected, the system only implements corrective steering adjustment for the side with the lane marking.

When the indicator lamp  lights up green, the system will not implement corrective steering adjustment under one of the following conditions.

- The accelerator pedal is depressed quickly.
- The brake pedal is depressed forcibly.
- Corresponding turn signal lamp has been activated.
- The hazard warning lamp has been activated.
- The steering wheel is turned quickly.
- The interval between two lane departure warnings is short.
- The car is running while rolling on or crossing over a lane marking constantly.
- The system alerts the driver to take over the steering wheel because the steering wheel is out of the driver's hands.

When the system intervenes in turning of steering wheel for corrective steering adjustment, the driver can feel the torque applied to the steering wheel by the system and the instrument cluster shows the lane marking indication.

Takeover indication



When the lane departure warning system detects that the steering wheel is out of the driver's hands for a long time, the system issues a takeover indication while the instrument cluster displays an alarm message and beeps.

The driver shall immediately hold the steering wheel when the takeover indication has been received. When the system identifies that the driver is holding the steering wheel, it cancels the takeover indication. Meanwhile, the lane departure warning system is automatically reactivated.

NOTE

When the driver's hands are lightly holding on the steering wheel, the system may misinterpret it as the steering wheel out-of-hand. In this case, just hold the steering wheel a little tightly or shake the steering wheel slightly.

5. Driving Guide

Other indications

When the system detects that the camera is inoperative, the message "The lane departure warning system is temporarily unavailable" pops up on the instrument cluster.

Usually, it is caused by dirty windshield glass or the camera directly exposed sunlight. The lane departure warning system will not be damaged on that and it does not need to be overhauled.

The driver may try to clean the windshield glass by spraying water on it and activating the windscreen wiper.

When the system detects a fault, the message "Please check the lane departure warning system" pops up on the instrument cluster and the indicator lamp  lights up red.

NOTE

If the message "Please check the lane departure warning system" pops up on the instrument cluster, which indicates that the system is faulty, please go to the GAC Motor authorized shop for inspection in time.

Functional limitation

The lane departure warning system may wrongly detect a lane marking or not detect any lane marking at all due to inevitable environmental factors and conditions even if the lane departure warning system is activated and working. The system may be affected or inoperative under the following conditions:

- poor line of sight, such as snow, rain, fog or water spots.
- dirty or foggy windshield, or obstruction in front of the windshield camera.
- overtemperature around the camera due to direct sunlight.
- glare due to direct sunlight, oncoming traffic, reflected light from road water-logging, etc.
- sudden changes in outdoor brightness, such as entering/exiting tunnels.
- headlamp not turned on at night or when the light is low in tunnels.
- No lane marking, or difficulty in distinguishing the lane marking color from the road surface color.
- unobvious, too thin, worn, blurred or dirt/snow-covered lane markings.
- too wide or narrow lanes.
- increase or decrease in the number of lanes, or complicated routing of lane markings.
- More than two lane markings on the left and right sides of the car.
- marks or objects similar to lane markings on roads.
- isolation strips or other objects casting shadows on lane markings.
- short-term change of marking, such as ramp or highway exit.
- driving on steep slopes or curved roads.
- close distance from the vehicle in front or lane markings blocked by the vehicle in front.
- severe shaking of the car.

Under the following conditions, the performance of the system may be affected while it intervening in turning of steering wheel for corrective steering adjustment:

- car overload.
- Abnormal tire pressure.
- uneven road.
- strong crosswinds.
- Any part involved in car control is modified or replaced with a non-genuine part.
- improper assembly of car control-related parts.

i NOTE

When the lane departure warning system intervenes in turning of the steering wheel for corrective steering adjustment, the driver may still turn the steering wheel to control the car. When the driver feels an implausible torque applied to the steering wheel by the system, the driver may take over control of the car at any time to drive it at will.

👁 NOTE

- When the lane departure warning system detects an unintentional lane departure, it issues a warning or intervenes in turning of the steering wheel to assist in corrective steering adjustment. Don't panic or turn the steering wheel fiercely.
- When the lane departure warning system detects that the steering wheel is out of the driver's hands for a long time, it issues a warning. In this case, don't panic or turn the steering wheel fiercely. Just hold the steering wheel and drive the car as usual.
- When "Warning" is selected as the LKA mode, the system will not intervene in turning of the steering wheel. When "Steering" is selected as the LKA mode, the system will not issue any visual and audible alarm.

⚠ WARNING

- **The lane departure warning system is just an assist system and cannot actively control the car to change lane or keep it in the lane. It is the full responsibility of the driver for always observing the road conditions and actively controlling the car. The driver shall always hold the steering wheel tightly and actively control the car.**
- **Improper use of the lane departure warning system or negligence may cause an accident. Do not rely on the lane departure warning system completely or drive the car at risk with the aid of the LKA system.**
- **Do not color or coat the windshield with any material not meeting the corresponding specifications. Any additional objects that negatively affecting the sight of the system camera may lead to improper operation of the system.**
- **If the system camera cannot detect a lane or the speed is less than 60km/h, the system does not issue a warning even if the car departs from or leaves the lane.**

5. Driving Guide

WARNING

- When the lane departure warning system issues an alarm, please do not panic or turn the steering wheel suddenly to prevent losing control of the car.
- Do not place reflective objects on the instrument panel, which are not only easy to dazzle the driver but also may reflect the light to the system camera, causing abnormal operation.
- Protect the system camera against strong impact, moisture or heat; and it is forbidden to remove and refit any part without authorization.
- Improper use of the lane departure warning system or negligence may cause accidents. Thus the driver shall concentrate on observing road and traffic conditions and drive carefully.

WARNING

- Lane keeping aid system with curb recognition uses signals from millimeter-wave radar sensor. Avoid impact or modification of the bumper or car body; otherwise the LKA system may operate abnormally.
- Do not color or coat the windshield with any material not meeting the corresponding specifications. Any additional objects that negatively affecting the sight of the system camera may lead to improper operation of the system.
- The system can only adjust limited steering angle, so it can't promise that the car will be driven back into the lane under any circumstances.

WARNING

- The sound inside or the noise outside may prevent you from hearing the warning beep, so it can't promise that you will notice the alarm from the lane departure warning system under any circumstances.
- Lane departure warning systems are not always able to identify a lane marking and a lane edge. The system may wrongly identify or even don't identify a lane marking or a lane edge due to bad weather, poor night lighting, water or snow on road, damaged or blurry lane markings. This may cause missing and false activation of the function, so drivers shall concentrate on observing road and traffic conditions and drive carefully.

5.4.4 Tire pressure monitoring system

The tire pressure monitoring (TPM) system monitors pressure and temperature of the tire, and displays the current pressure and temperature of the tire on the instrument cluster. In case of tire anomalies such as low/high pressure, rapid air leakage and high temperature, the instrument cluster will display various alarm messages.

When the engine start/stop button has been set to the "ON" position, the tire pressure and temperature displayed on the instrument cluster are both "---" if the car is stationary or the car speed does not exceed 25km/h. If the car speed has been above 25km/h for several minutes, the current tire pressure and temperature are displayed on the instrument cluster.

The TPM system alarms includes the fault indicator lamp alarm and the message alarms. The alarms consist of the low/high pressure alarm, rapid air leakage alarm and high temperature alarm.

- If the tire pressure is higher than 330Kpa, the indicator lamp of the TPM system lights up, and the alarm message on the instrument display indicates that the tire pressure is high.
- If the tire pressure is lower than 75% of the normal setting value, the indicator lamp of the TPM system lights up and the alarm message on the instrument display indicates that the tire pressure is low.
- If the decreasing rate of the tire pressure is higher than a specified level, the indicator lamp of the TPM system lights up and the alarm message on the instrument display indicates that the tire has air leakage.
- If the tire temperature is higher than 85°C, the indicator lamp of the TPM system lights up and the alarm message on the instrument display indicates that the tire temperature is high.

NOTE

If the tire pressure sensors in the tires or the tires are required to be replaced or rotated, it is necessary to learn about how to match the tire pressure sensors in the four tires. In this case, please go to the GAC Motor authorized shop for replacement.

NOTE

- When a high temperature alarm is activated, it is recommended to have a rest stop and wait for the tire temperature to decrease before continuing to drive.
- If the low tire pressure alarm does not disappear while you continue to drive as the tire pressure sensor is missing after a spare tire or a new tire has been replaced in another place. Please do not interpret that as abnormal tire pressure.

5. Driving Guide

5.5 Parking assist system

5.5.1 Parking sensor system

The parking sensor system measures the distance between the car and an obstacle via the radar sensors sending and receiving ultrasonic waves reflected from the obstacles.

On and off

- When the forward speed is less than 10km/h, the front ultrasonic sensor starts to operate; when the forward speed is greater than 12km/h, the front ultrasonic sensor stop operating; when the forward speed decreases from 12km/h above to 10km/h below, the front ultrasonic sensor starts to operate again. (Applicable to the model with front radars)
- When the engine start/stop button has been set to the "ON" position, release the electric park brake and the move the gearshift lever to "R" position. In this way, the rear and front ultrasonic sensors start to operate at the same time if the car is reversing at 10km/h below.
- When the reversing speed is greater than 12km/h, the rear and front ultrasonic sensors stop operating; in this case, move the gearshift lever to "P" position to

apply the electric park brake and set the engine start/stop button to a position other than "ON" position so that the parking sensor system stop operating.

Dynamic view



The dynamic view on the display indicates the distance between the car and front & rear obstacle. In the view, the outermost sector of the car is yellow, the middle one is orange and the innermost one is red. When the car is getting closer and closer to an obstacle detected, the activated sector comes nearer and nearer to the car icon in the dynamic view.

Change of dynamic view is synchronized with that of the audible alarm with reference to distance.

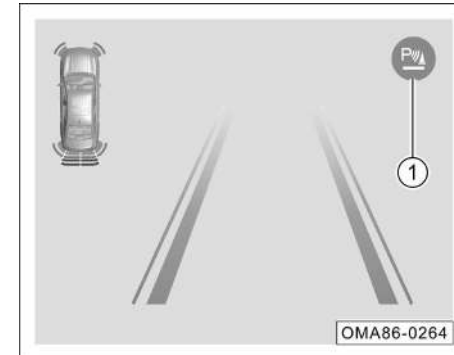

When the parking sensor system is switched on during reversing, pressing button **P**  ① on the panoramic view manually deactivates the system, and pressing it again reactivates it. When the car has been restarted, the parking sensor system will be automatically switched on.

Distance to detected obstacle						Audible alarm level message
Front left sensor	Front right sensor	Rear left sensor	Rear right sensor	Rear left middle sensor	Rear right middle sensor	
No display & alarm	No display & alarm	No display & alarm	No display & alarm	150-90 cm	150-90 cm	Regular slow audible alarm
No display & alarm	No display & alarm	No display & alarm	No display & alarm	90~60cm	90~60cm	Regular slow audible alarm
60~30cm	60~30cm	60~30cm	60~30cm	60~30cm	60~30cm	Regular rapid audible alarm
< 30cm	< 30cm	< 30cm	< 30cm	< 30cm	< 30cm	Constant audible alarm

Audible alarm with reference to distance

The audible alarm changes with reference to the distance between a detected obstacle and the front/rear bumper. In addition, the color of activated sector shown on the AV system display changes accordingly.

5. Driving Guide

Distribution of radar sensors

Applicable to the model without automated parking:

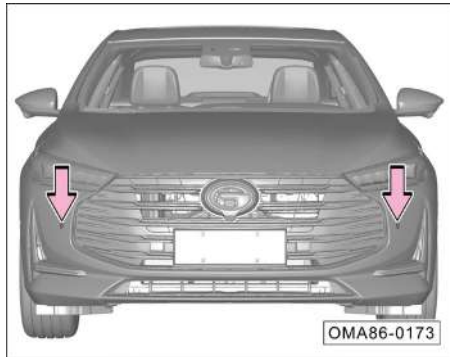

The front ultrasonic radar sensors are installed on the front bumper cover. (Applicable to the model with front radars)

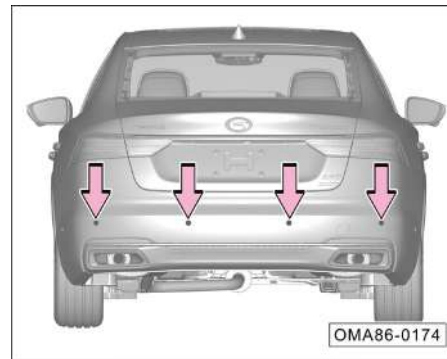

The rear ultrasonic radar sensors are installed on the rear bumper cover.

Applicable to the model with automated parking:

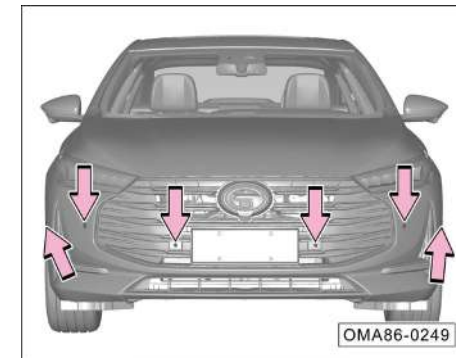

The front ultrasonic radar sensors are installed on the front bumper cover.

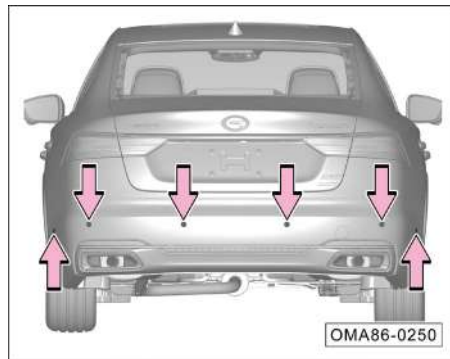

The rear ultrasonic radar sensors are installed on the rear bumper cover.

NOTE

- Always keep the surface of the radar sensors clean and never cover a radar sensor.
- Keep the radar sensors clean and protect them from freezing to ensure the radar sensors operate properly.
- Clean the radar sensor surface with a piece of soft damp cloth to avoid scratching it.

WARNING

- **The parking sensor system cannot be substituted for the driver to observing the surrounding environment. The driver shall focus on safely reversing according to the practical conditions.**
- **The radar sensors have blind spots while they detecting obstacles. During reversing, the driver shall observe the surrounding environment carefully to avoid an accident.**
- **When the car is reversing at a narrow place or on an uphill slope, the radar sensors may not detect railings, trees or slope surfaces, which is normal.**
- **When the reversing speed is high, the accuracy of the radar sensor detection reduces. Thus the reversing speed had better not to exceed 10km/h. When the parking sensor system constantly issues audible alarms, it indicates that the car is extremely close to the detected obstacle, and reversing shall be stopped immediately to prevent an accident.**

5. Driving Guide

WARNING

- **During cleaning a radar sensor with a high-pressure cleaner, clean it gently in snatches and the nozzle shall be at least 30 cm away from the sensor.**
- **If water drops are attached to the surface of a radar sensor, the sensitivity of the sensor will reduce. Wiping off them can restore the sensitivity of the radar.**
- **The surface of some materials cannot reflect the signal from the radar sensor, so that the radar sensor cannot detect such materials or people wearing the clothing made of such materials.**
- **Noise sources outside the car may interfere with the radar sensor, making it impossible to detect any target.**
- **The radar sensor is a precision component, which shall not be removed & refitted and repaired without authorization. The company does not assume any responsibility for the damage caused by unauthorized removal & refitting and repair.**

5.5.2 Reverse image system *

The reverse image system can film at an wide angle up to 130° and display a wide-range image behind the car on the AV system display so as to help the driver to observe complex road conditions behind the car and improve the safety of reversing.

On and off

In case of the engine start/stop button set to the "ON" position, the reverse image system automatically starts to operate if the gearshift lever is moved to the "R" position. In this case, the AV system display begins to show the image behind the car and displays the dynamic trajectory in the reverse image.

If the gearshift lever is move out of the "R" position, the reverse image system automatically stops operating and the AV system exits from the reverse image.

WARNING

The reverse image system cannot be substituted for the driver to observing the surrounding environment. The driver shall focus on safely reversing according to the practical conditions.

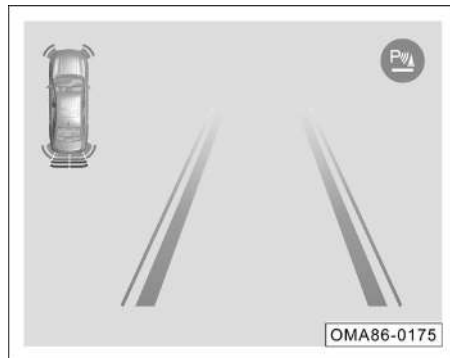
Dynamic trajectory

Dynamic trajectory: It is the motion trajectory of the rear plotted on the reverse image according to the current steering wheel angle.

Starting position: $\leq 25\text{cm}$ from the rear of the car.

Range of trajectory: The trajectory includes tire and car trajectories.

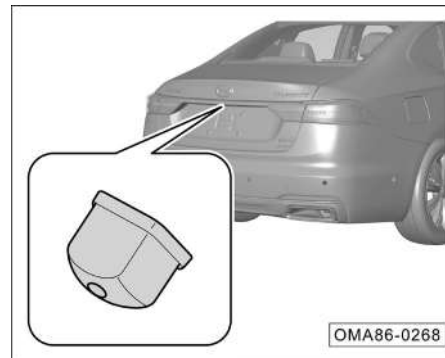
Rearview camera

It is installed next to the license plate lamp.

⚠ WARNING

- **The rearview camera have blind spots because the camera may not detect young children or small pets. It is important to pay special attention to the young children or small pets around the car during reversing.**
- **The rearview camera may not be able to recognize the vertical objects at high position.**

👁 NOTE

- Always keep the rearview camera surface clean. Clean the surface of the rearview camera with a piece of soft damp cloth to avoid scratching it.
- Do not use a high-pressure cleaner to clean the rearview camera for a long time. The cleaner nozzle shall be at least 30 cm away from the rearview camera during cleaning.
- Do not cover the rearview camera.

5. Driving Guide

5.6 Electric power steering (EPS)

The electric power steering (EPS) is a power steering system which directly uses the motor for providing torque. It is mainly composed of a torque sensor, a motor, a retarding mechanism and an electric power steering control unit (ECU).

The electric power steering control unit (ECU) controls the torque provided by the EPS motor in real time by detecting the torque applied by the driver, the car speed, the engine speed and other status signals of the car to augment the steering effort in the best way so as to ensure the convenience of steering at a low speed and the stability of steering at a high speed, and to improve the driving comfort and car safety.

EPS indicator lamp

In case of the engine start/stop button set to the "ON" position, the indicator lamp  lights up. The system performs the self-check a few seconds after the engine is started and the indicator lamp goes out, which indicates that the EPS works properly.

If the indicator lamp lights up when the engine has been started or while driving,  it indicates that the EPS is faulty. In addition, the instrument cluster displays an alarm message. In this case, the car shall be parked in a safe place. Try to shut down and restart the engine. If the indicator does not go off or light up again while driving, do not continue to drive. Please contact the GAC Motor authorized shop for inspection.

Steering mode

There are three steering modes: standard, sport and comfort modes, where the hand force of the driver turning the steering wheel in sport mode will be a little greater than that in the standard mode, and the system is set to the Standard mode by default. It can be set by going to "System Settings → Driving Assistance → Lateral Driving Assistance → Steering Mode (Vehicle Settings → Driving Assistance → Steering Mode)" on the AV system display.

NOTE

In order to prevent an accident, it is forbidden to set the steering mode during driving.

5.7 Driving skills

5.7.1 Driving safety inspection

Routine inspection

- Check the tire pressure; check the tires for cuts, bulges, damage or excessive wear.
- Check whether the wheel studs are missing or loose.
- Check whether the front & rear combination lamps and other lamps work properly; check the lighting direction of the front combination lamp.
- Check that the seat belt is not worn or damaged; check that the seat belt is fastened securely after fastening the seat belt.
- Check that the free travel of the pedal is sufficient.
- Check whether the levels of coolant, engine oil, brake fluid and windshield washer fluid are normal.
- Check the battery terminals for corrosion or looseness, and check the battery shell for cracks or deformation caused by expansion.
- Check for leakage of fuel, engine oil, water or other liquids under the car. Any water found after A/C operation is normal.

After starting/during driving

- Observe whether the instrument cluster works properly; check whether any indicator lamp lights up or any alarm message is shown, etc.
- Check whether all controls (such as the lamplight combination switch, wiper combination switch and defrosting switch) work properly.
- The car shall not be biased to one side while checking and confirming braking condition on a safe road.
- For other anomalies, check for loose parts, leakage, and abnormal noise.

5.7.2 Driving during running-in period

In order to prolong the service life of the car, the car shall have a running-in for the initial stage of its operation before it is brought into use. Please comply with the following rules for your car in the running-in period:

- The running-in period shall be 1500km.
- Choose a road in good condition and drive it at reduced load and limited speed during the running-in period.
- Do not start the engine with full throttle or drive with harsh acceleration.
- Avoid emergency braking in first 300 km.
- Strictly follow the operating procedures and make sure that the engine has reached normal operating temperature. Do not change the oil before regular maintenance.
- Carry out daily maintenance of the car carefully; check and tighten the external bolts and nuts frequently; check the sound and temperature changes of the assemblies generated by operation and adjust them timely.

5. Driving Guide

Engine running-in

The running-in period of new engine shall be 1500km. In case of the distance driven < 1000km:

- The car speed shall not exceed 3/4 of the maximum allowable speed.
- Do not drive the car with full throttle.
- Avoid running the engine at high speed.
- Do not tow any trailer.

In case of the car's driven distance between 1000km-1500km, The engine & car speeds can be gradually increased to the those not higher than maximum allowable engine & car speeds.

The internal frictional resistance of the engine at the initial stage of running-in is much greater than that after running-in, and all the moving parts of the engine can have the best fitting after running-in.

After fully running in, both the service life and the fuel consumption of the engine can be improved.

Running-in of tire and brake pad

If the driven distance of a new car is not greater than 500km, the car shall be driven at a moderate speed and the new tires shall be run in fully.

If the driven distance of the new car is between 200km-300km, the pads have not had optimal friction, so the car shall run at a low speed and emergency braking shall be avoided as much as possible.

WARNING

- **New tires and brake pads without running-in do not have the best adhesion and friction. Therefore, drive the car cautiously within the first 500km, and fully run in the tires to prevent accidents.**
- **Replaced new brake pad shall be run in according to the above requirements as well.**
- **During driving, keep an appropriate distance from other vehicles to prevent emergency braking. Because new tires and brake pads have not been fully run in at this time. In case of an emergency braking, an traffic accident is likely to occur.**

WARNING

- **If a brake is wet or icy or the car travels on a salted road, the braking effect will be reduced.**
- **When the car is driving downhill, the brake works under a high load so the brake is very easy to overheat. It is recommended to downshift (in manual mode) and reduce the car speed before driving downhill so as to make full use of the braking effect of the engine to reduce the load on the brake.**
- **Brake shall be applied according to road and traffic conditions; do not depress the brake pedal when it is unnecessary, otherwise the brake will overheat due to friction, resulting in a too long braking distance and excessive brake wear.**
- **Do not shut down the engine for coasting. Otherwise the brake booster does not work and the braking distance greatly increases, which is very easy to cause an accident.**

5.7.3 Driving essentials

Precautions under various road conditions

- When the car is driving on a road with crosswinds and gusts, the driver shall decelerate in advance and control the speed and steering wheel.
- The car shall avoid rolling on sharp-edged objects or other road obstacles, otherwise it may cause serious damage such as tires burst.
- Reduce the speed and drive at a low speed while driving on a bumpy or uneven road; otherwise the chassis may be scratched, which result in car damage.
- When the car is driving downhill, decelerate and downshift in advance (in manual mode); avoid emergency braking, otherwise the brake system will overheat or be worn out too quickly.
- When the car is driving on a smooth road, be careful during accelerating, upshifting/downshifting (in manual mode) or braking; avoid sudden acceleration or emergency braking, otherwise it is likely to cause wheel slip.
- The car shall be driven at a low and constant speed on an icy and snowy road; avoid sudden acceleration or emergency braking; and install tire chains for the wheels as needed.

Precautions while driving over a water-logged road section:

1. Before driving over a water-logged road section, determine the depth of water, and the water level shall not be high than the lower edge of the car body.
2. To drive through water, switch off the A/C before the car starts, decelerate slowly and then gently depress and hold the accelerator pedal to drive over the water-logged road section at a stable and low speed.
3. Stopping the car, reversing or shutting down the engine in water are all prohibited.
4. After successfully driving over the water-logged road section, it is important to gently depress the brake pedal for several times to evaporate the moisture on the brake discs so as to restore the usual braking performance as soon as possible.

i NOTE

The brake pads and brake discs are soaked in water while the car is washed or driving over a deep water road, and the braking effect will be greatly reduced when the brake is applied; the braking distance will be longer than usual and the car may be biased to one side, thus applying the park brake may not brake the car. In this case, drive the car at a low speed and constantly depress the brake pedal slightly to remove residual moisture in the brake. When the braking effect has returned to normal level, drive the car as usual.

5. Driving Guide

Driving essentials in winter

1. Proceed as below to check if the coolant is in good condition and if it is well protected from freezing:
 - Fill the cooling system with the same type of coolant as the one used in this car according to the ambient temperature.
 - Filling unsuitable coolant may cause damage to the engine.
2. Proceed as below to check the battery and cables:
 - Stored energy of the battery decreases in very cold weather. Therefore, fully charge the battery for start-up in winter.
3. Proceed as below to prevent the door lock from being frozen by ice and snow:
 - Spray some de-icer spray or glycerin into the door lock hole to prevent the door lock from being frozen.
4. The washer fluids containing antifreeze shall be used:
 - These products are available at GAC Motor authorized shop.
 - The mix ratio of water to antifreeze shall comply with the manufacturer's instructions.
5. No accumulated ice and snow shall be found beneath the mudguard:
 - Because accumulated ice and snow beneath the mudguard may result in difficult steering. Stop the car regularly to check for accumulated ice or snow beneath the mudguard while driving the car in severe cold winter.
6. According to different road conditions, it is recommended to bring several necessary emergency items such as:
 - Tire chains, a window scraper, a bag of sand or salt, a flashing light, a plough staff, connecting cables, etc., which are recommended to be placed in the car.
7. In cold winter (especially in northern China), avoid starting the engine frequently and shutting down the engine immediately after a short-time start. If the engine is often in an alternating heat & cold cycle, the condensed water is likely to form in the engine. Condensed water adhering to the engine oil (where applicable) may give an illustration of water-in-oil emulsion. When the engine has been restarted and warmed up, this illusion will be shattered; in addition, please change the oil regularly as required by the Warranty Manual.

5.7.4 Efficient use of car

- Before driving, make sure that the park brake is completely released and the park brake indicator lamp is off.
- Maintain sufficient tire pressure, as insufficient tire pressure can cause tires to wear out quickly and waste fuel.
- Ensure the wheel alignment is accurate. Otherwise tires will wear out quickly, and the engine load will increase, causing fuel wasted.
- Do not overload the car. Unload unnecessary items from the car, as excessive load increases the engine load and wastes fuel.
- Accelerate the car slowly and smoothly to avoid rapid acceleration.
- Avoid roads with traffic jams as much as possible, as traffic jams waste fuel.
- Observe traffic lights or maintain a safe distance with other cars while driving to avoid unnecessary stop or emergency braking, so as to save fuel and reduce wear on the brake system.
- Do not step on the brake pedal when the car is running, for fear of premature wear and overheating of brake pads and waste of fuel.
- When driving, select good road surface. If driving on uneven roads, control the car speed to avoid collision or scratches.
- If the chassis is stained with objects such as excessive dirt, clean them in time to not only reduce the car's weight but also prevent corrosion.
- Perform regular maintenance on the car to maintain its optimal working condition. Dirty air filter, spark plugs, oil, and grease will reduce the engine performance and waste fuel.
- Drive slowly for a few minutes after starting the engine at low temperature, and ensure the engine is warmed up before acceleration.
- Do not open windows when driving at high speed.
- Reasonably use A/C, etc.
- In case of parking for a long time, please shut down the engine to avoid wasting fuel due to long time idling of engine.

5.7.5 Fire prevention

In order to prevent car fires, pay attention to the following during use:

1. It is forbidden to store flammable or explosive items in the car:
 - In hot summer days, the internal temperature of cars parked in the sun can be as high as 70°C or more. If flammable or explosive items such as lighters, cleaning agents and perfumes are stored in the car, fire and even explosion can be easily caused.
 - After people leave the car, items such as lithium batteries or power banks that are at risk of fire are also likely to cause fire.
2. Make sure the cigarette butts are completely extinguished after smoking:
 - If the cigarette butts are not completely extinguished, fire may be caused.

5. Driving Guide

3. It is recommended to regularly drive to the GAC Motor authorized shop for inspection:
 - Regular inspections of all electric lines of the car are also required. Check whether the connectors, insulation, and fixing positions of electrical units and wiring harnesses are normal. If problems are found, they shall be dealt with in a timely manner.
4. It is forbidden to modify the electrical circuits or add electrical units:
 - Adding electrical units (such as high-power audio device and xenon headlamps) will cause excessive load on the electrical line, and wiring harnesses can be heated and result in a fire.
 - It is strictly forbidden to use fuses that exceed the rated specifications of the electrical units or other metal wires to replace the fuses.
5. Precautions for driving:
 - During driving and parking period, especially in summer, pay attention to whether there are flammable items under the car, such as hay, dry branches, leaves, wheat stalks, etc. Since the temperature of components such as engine exhaust pipe increases after long time driving, if there are flammable items under the car, they are likely to be ignited and cause a fire.
 - Do not park the car in places where there is serious rat infestation, such as garbage dumps, and do not store items that attract rats, such as snacks, because rats will bite through the wire harnesses and may cause a fire.
6. Always place a lightweight fire extinguisher in the car, and master the use method:
 - In order to ensure the safety of the car, place a fire extinguisher in the car, and regularly check and replace it; at the same time, be familiar with the use method of the fire extinguisher, so as to be prepared and avoid being helpless when accidents occur.

6.1 Maintenance instructions

Safety precautions

To avoid potential hazards, please read this section before starting work and confirm that you have the necessary tools and techniques.

- Make sure that the car is parked on level ground, shut down the engine, and apply the park brake.
- When cleaning parts and components, use commercially available degreasers or parts cleaners, instead of gasoline.
- Keep lit cigarettes, sparks, and open flames away from batteries and all fuel system related components.
- When working on batteries or with compressed air, wear goggles and protective clothing.

⚠ WARNING
Incorrect car maintenance or driving the car before the problem is solved may cause a traffic accident, resulting in serious injury or death.

Potential hazards of the car

- Carbon monoxide: carbon monoxide in the exhaust gas of the engine is toxic. Be sure to start the engine in a well-ventilated place.
- Burns: the engine and exhaust system are at high temperature during operation, which can easily cause burns. Therefore, wait till the engine and exhaust system cool down before touching the related parts and components.

👁 NOTE
 This section lists some of important safety precautions. We can not list all the dangers you may encounter during maintenance work.

6.2 Interior maintenance

Cleaning and maintenance of instruments and plastic parts

Clean the surface of instruments and plastic parts with a clean soft cloth and clean water.

If it can not be cleaned, it is required to use a special solvent-free plastic cleaning agent for cleaning.

👁 NOTE
 Solvent-based cleaning agents can damage plastic parts.

⚠ WARNING
It is forbidden to use cab sprays and solvent-based cleaning agents to clean the surface of the instrument panel and airbag assembly. Otherwise, it may loosen the surface and trigger the airbag, which may cause serious injury to occupants.

6. In-service Maintenance

Cleaning and maintenance of carpet

Vacuum the dust on the carpet frequently.

Scrub the carpet regularly with detergent to keep it clean.

NOTE

Please perform the cleaning in strict accordance with the use instructions of cleaning agents.

WARNING

It is forbidden to add water to the foam cleaner. The carpet shall be kept as dry as possible.

Cleaning and maintenance of leather*

- Vacuum the dust.
- Clean the leather with a clean soft cloth and clean water.
- Wipe the leather dry with another dry soft cloth.
- If the cleaning methods described above are not enough to clean stains, please combine these methods with special leather cleaning soap or detergent.

NOTE

If a leather stain remover is used, wipe it dry with a soft dry cloth as soon as possible.

WARNING

Never leave a soft cloth wet with leather stain remover on any part of the interiors for a long time. Avoid discoloring or breaking the resin or fibers of interior fabrics.

Cleaning and maintenance of seat belts

- Pull the seat belt out slowly and keep it extracted.
- Remove dirt from the seat belt by using a soft brush and neutral soapy water.
- After seat belts dry completely, retract the seat belts.

NOTE

- Wait till the seat belts dry completely before retracting them. Otherwise, seat belt retractors may be damaged.
- Regularly check all the seat belts in the car to ensure that the seat belts are clean and avoid hindering the normal operation of seat belts.

WARNING

- **If the seat belt webbing, connectors, retractor mechanism or buckles are damaged, please go to the GAC Motor authorized shop for replacement as soon as possible.**
- **For the overhaul of an accident car, seat belts must be replaced, no matter whether they are damaged.**
- **Avoid foreign objects or liquids entering the seat belt buckles, which may result in the buckles and seat belts not working properly.**
- **Under any circumstances, it is forbidden to remove or modify seat belts without authorization.**
- **It is forbidden to use chemical cleaning agents to clean the seat belts, for fear of damaging the seat belt base and impairing the function of seat belt.**

Cleaning and replacement of filters

The car is equipped with an air filter, an A/C filter, an oil filter, a fuel filter, etc. They aim to filter gas or oil. If they are too dirty or clogged, the normal operation of corresponding systems will be affected. Therefore, it is recommended to regularly clean or replace the filters at the GAC Motor authorized shop according to the provisions of the *Warranty Manual*.

6.3 Exterior maintenance

Car washing

Washing the car frequently helps to protect its appearance.

Car washing shall be performed in a cool place, rather than under direct sunlight. If the car is left in the sun for a long time, wait till the car body surface cools down before washing the car.

When using an automatic car washer, be sure to follow the instructions of the operator of the automatic car washer.

WARNING

The engine start/stop button must be turned off before car washing.

6. In-service Maintenance

NOTE

The strength of the paint surface of the car body is sufficient to withstand the washing of the automatic car washer. However, the effects on the paint surface must be paid attention to. The structure of the automatic car washer, the cleaning agent, the filtering state of the clean water, and the type of wax solvent that do not meet the requirements may cause damage to the paint surface.

Manual car washing

- Rinse the car with plenty of water to remove floating dust.
- Prepare a bucket of water and add a special cleaning agent for car washing to it.
- Gently scrub the car with a soft cloth, sponge, or soft brush, and rinse it several times from top to bottom.
- Rinse the parts such as wheels and door sills at last. Replace sponges or soft cloth when washing the car.
- After scrubbing, rinse the car thoroughly with plenty of water.
- After washing, carefully dry the paint surface of the car using a soft towel or antelope skin.

NOTE

When the car body has dirt such as asphalt, it needs to be cleaned with a special cleaning agent, and then rinsed with clean water to avoid damaging the surface finish of the car body. Check the body for paint peeling and scratches while wiping the body. If any, drive to the GAC Motor authorized shop for touch-up.

When using a steam cleaner or a high-pressure cleaner to wash the car, be sure to be very careful. Be sure to wash the car in accordance with the operation instructions and requirements of the steam cleaner or high-pressure cleaner. Pay attention to the working pressure, temperature and spraying distance:

- When using a steam cleaner or a high-pressure cleaner to wash the car, keep a sufficient water spray distance from the car, and ensure the temperature does not exceed 60°C.

- If the car is equipped with an electric sunroof, keep the water spray distance more than 80 cm when washing the car. If the high-pressure cleaner is close to the car, or if excessive pressure or temperature is used, the car may be damaged.
- Do not wash the radar sensor or parking camera with a high-pressure cleaner for a long time; when washing the radar sensors or parking assist cameras, keep the water spray distance more than 30 cm.

WARNING

- **When washing the car manually, pay attention to personal safety and beware of angular parts at the bottom of the car to avoid being scratched.**
- **When washing the car, pay special attention to the bottom of the car and the inner side of wheelhouses. Do not hurt hands and arms with sharp parts.**
- **Never spray water directly into the engine compartment when washing the car. Otherwise, it will affect the service life of various parts and components in the engine compartment.**

Waxing

Regular waxing can protect the paint surface of the car body and keep the car body clean. In order to effectively protect the paint surface of the car body, it is recommended to apply high-quality hard wax once a year to protect the paint surface against corrosion by external bad environments and to resist light mechanical scratch.

Be sure to wipe the appearance of the entire car dry before waxing. When waxing the car, please select a high-quality wax protectant. High-quality wax protectant generally falls into the following two types of products:

- Car body wax: a wax used to protect the paint surface against damage by external bad environments such as sun exposure and air pollution. This type of wax is generally used for new cars.
- Polishing wax: a wax which can restore the gloss of the paint surface that has been oxidized or tarnished. This type of wax is generally used to restore the gloss of paint surface.

Cleaning and maintenance of external plastic parts

External plastic parts are generally washed with clean water, soft cloth and soft brushes. If they can not be cleaned, please use the special solvent-free plastics cleaner approved by our company.

NOTE

Do not use solvent-based cleaning agents when washing plastic parts. Otherwise, it is easy to damage the plastic parts.

Washing of window glasses and rearview mirrors

Clean the window glasses and rearview mirrors with alcohol-based glass cleaner, and then wipe the glass surface dry with a clean, lint-free soft cloth or antelope skin.

After curing the surface of the car body, remove the wax residue on the glasses with a special cleaning agent and cleaning cloth. Avoid scratching the wiper blades.

Remove snow from the windows and rearview mirrors using a small brush.

Remove accumulated ice using de-icing spray. An ice shovel can also be used, but special care must be taken to avoid damage to the components, and ice must be shaved in the same direction.

NOTE

- It is forbidden to scrape the surface back and forth.
- It is forbidden to remove ice and snow from the windshields and rearview mirrors using warm water or hot water. Otherwise, the windshields may burst.
- If there are residual objects such as rubber, grease and silicone on the glass, they must be removed with a special window cleaner or silicone cleaner.

6. In-service Maintenance

Cleaning of wiper blades

- Raise the wiper arm and carefully wipe off the dust and dirt on the wiper blade with a soft cloth.
- After cleaning, gently lower the wiper arm back to the windshield.

NOTE

- Be careful when lowering the wiper arm to prevent it from falling and hitting the windshield instantly.
- The wiper blades are coated with a layer of graphite which makes the wiping operation smooth and does not produce scraping noise. Solvent-based cleaning agents, hard sponges, and sharp objects can damage the graphite layer. Damaged graphite layer will increase the wiping noise of the wiper, and the wiper shall be replaced in time.
- In winter or cold conditions, be sure to check whether the wiper blade is frozen together with the windshield before using the wiper. If so, perform de-icing first. Otherwise, the wiper blade and wiper motor will be damaged.

Maintenance of sealing strips

Frequent and proper protection of the rubber sealing strips of the doors, windows and other parts of the car is appropriate to maintain their flexibility and prolong their service life. Such protection can also improve the tightness, make the door easy to open, reduce the impact sound of closing the door, and prevent freezing in winter.

When performing maintenance on sealing strips, remove dust and dirt from surfaces using a soft cloth. Apply special protective agent to rubber sealing strips regularly.

Cleaning and maintenance of wheels

Regularly remove anti-skid salts on the wheels and debris on the brake linings, keep the wheels aesthetic, maintain the surface smooth and prolong the service life of wheels. It is recommended to perform the following operations regularly:

- Remove anti-skid salts on the wheels and debris on the brake linings using acid-free detergent every two weeks.
- Apply high-quality hard wax to the alloy wheels every three months.

NOTE

- It is prohibited to treat the wheel surface with car polish or other abrasives.
- Wheels with damaged protective coating on surface must be repaired in time.
- Using a high-pressure cleaner may cause permanent visible or invisible damage to the wheels, resulting in serious injury or death.
- It is forbidden to use cluster head nozzles to spray the tires. Otherwise the tires will be damaged, causing traffic accidents.

6.4 Checking and adding fluids

6.4.1 Fuel

As the amount of fuel decreases when the car is running, the fuel meter scale will gradually decrease. => See Page 39

When the fuel amount is too low,  the yellow indicator lamp flashes, and the instrument cluster will give an alarm message. At this time, fuel shall be added as soon as possible.

Add fuel



- Press and hold the fuel tank cap opening button  to make the fuel tank cap pop up.

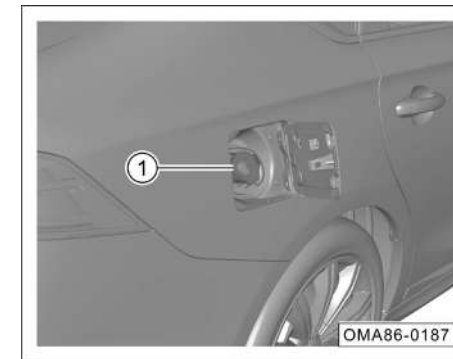

- Open the fuel tank cap completely, and slowly unscrew the filler cap ① counterclockwise. When the filler cap is completely unscrewed, leave the filler cap ① in place for a while till the fuel vapor inside the fuel tank is released, then remove it.

6. In-service Maintenance

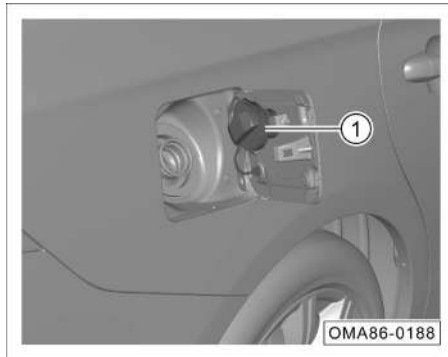

- Hang the filler cap on the inner side of the fuel tank cap and start adding fuel.
- After adding the fuel, tighten the filler cap ① clockwise till a “click” sound is heard, indicating that the filler cap is tightened.

i NOTE

Please refer to the description on the fuel requirement label at the fuel filler door of each vehicle.

i NOTE

This model complies with China VI emission standards. The fuel supply system of China VI is designed with a closed fuel and gas recovery system. During refueling, the fuel gun switch may be triggered due to high ambient temperature or high fuel flow rate, and the fuel gun is switched off when the fuel tank is not filled fully. This is a normal phenomenon. At this time, the refueling speed shall be slowed down.

👁 NOTE

Low-grade fuel or substandard fuel may damage the engine or make the engine fail to meet performance requirements.

⚠ WARNING

- **At any time, be sure to turn off the engine when refueling, and pay attention to open flames and fire.**
- **Please avoid contact of fuel with skin or clothing.**
- **Please refuel the car according to the car fuel grade. If fuel not complying with the regulations is added accidentally, do not start the engine. Please contact the GAC Motor authorized shop immediately for treatment.**

Emergency unlocking

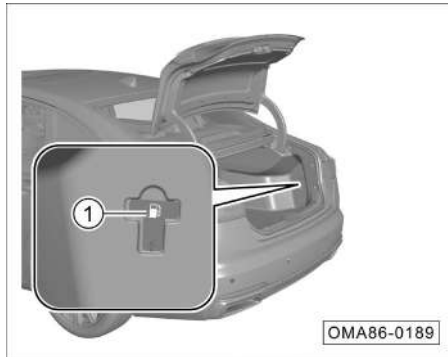

When the battery is out of power or the electric switch of the fuel tank cap does not work, open the fuel tank cap by the following steps:

- Open the trunk lid.
- Pull the emergency unlock switch ① to unlock the fuel tank cap.

6.4.2 Engine oil

Function of engine oil

Engine oil has functions such as lubrication, sealing, cooling, anti-rusting and cleaning.

Specifications of engine oil

When the car leaves the factory, the engine has been filled with high-quality engine oil, which can be used in the year-round climate except for extreme cold weather.

When purchasing engine oil, please check whether the specifications indicated on the outer packaging of the engine oil are suitable for the engine of this car.

i NOTE

- Engine oil grade: SN and above.
- Engine oil viscosity: SAE5W-30.

⚠ WARNING

Always use the engine oil approved by our company. Otherwise, the resulting engine damage will not be covered by the warranty.

i NOTE

- Be sure to go to the GAC Motor authorized shop to change the engine oil according to the period specified in the *Warranty Manual*.
- If the car is used under severe conditions, fuel with high sulfur content is used, engine idles for a long time (e.g., a taxi), the car is driven in a high-dust area, the car is often used to tow a trailer, or the car is used in an alpine area, the maintenance periods shall be shortened and the maintenance times shall be increased.

6. In-service Maintenance

Low oil pressure alarm lamp

When driving, if the  alarm indicator lamp comes on, be sure to stop the car in a safe place and shut down the engine. After the engine cools down, check the oil level.

If the engine oil level is normal, but the alarm indicator lamp is still on after the engine starts, do not continue to start the engine. Contact the GAC Motor authorized shop timely for inspection.

WARNING

- Ignoring the alarm indicator lamps and related warning instructions may damage the engine.
- The low oil pressure alarm indicator lamp can not indicate the oil level, and the oil level must be checked regularly.

Check the oil level

Be sure to check the oil level regularly. Park the car on level ground, apply the park brake, and shut down the engine. After the engine cools down, open the engine hood and check the oil level.

WARNING

- Be extremely careful when working in the engine compartment.
- The engine compartment is a high-risk area. Be sure to read and follow the relevant warning instructions carefully before opening the engine hood.

NOTE

When checking the oil level, ensure the engine is cold.

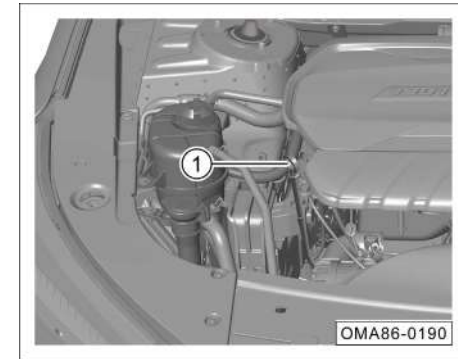

- Pull out the dipstick ①.

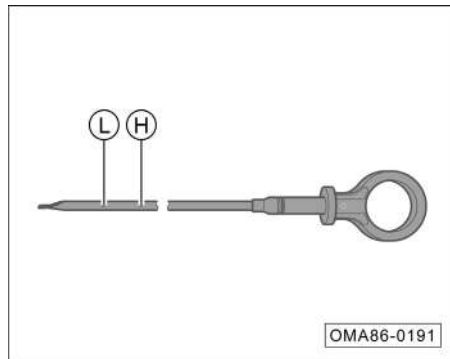

- Wipe off the oil on the dipstick using a clean cloth, and then insert the dipstick completely.
- Pull out the dipstick again and read the measured oil level, which shall be between the lower limit mark "L" and the upper limit mark "H".
- If there is too little engine oil, please add engine oil in time. Otherwise, poor lubrication will damage the engine.

Add oil

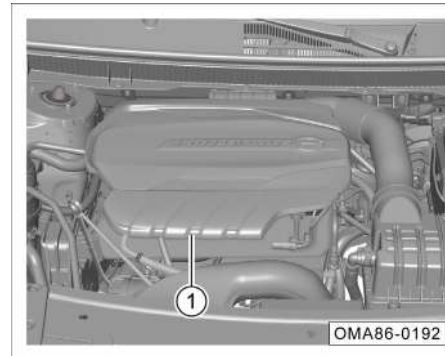

After checking the oil level, if required, add oil following the steps below:

- Lift up and remove the engine upper guard plate ①.

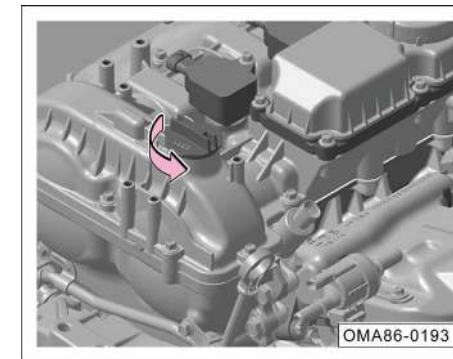

- Unscrew the oil filler cap counterclockwise.
- Add the engine oil in small quantities several times, and check the oil level after each filling.
- When the oil level is close to the upper limit mark "H", indicating the engine oil is sufficient, stop adding oil, refit the oil filler cap and tighten it clockwise.

6. In-service Maintenance

WARNING

- **Be careful when adding the engine oil. Do not spill it. If the engine oil gets on skin, be sure to rinse the skin thoroughly.**
- **If too much oil is added, do not start the engine. Please contact the GAC Motor authorized shop as soon as possible for treatment. Otherwise, the three-way catalytic converter may be damaged.**
- **After filling, be sure to tighten the oil filler cap to prevent the engine oil from splashing when the engine is being started, for fear of a fire.**
- **Engine oil is toxic. It shall be stored in the original container and kept out of children's contact to avoid poisoning due to accidental ingestion.**
- **Do not add any lubricants to the engine oil. Otherwise, the engine will be damaged. Engine failure caused by adding lubricants is not covered by the warranty.**

6.4.3 Coolant

Function of coolant

Coolant has functions such as cooling, anti-freezing and anti-corrosion.

Specifications of coolant

When the car leaves the factory, the cooling system has been filled with coolant, which can be used in the year-round climate except for extreme cold weather.

NOTE

- Specifications of coolant: DF-6, -35°C coolant.
- Be sure to go to the GAC Motor authorized shop to change the coolant according to the period specified in the *Warranty Manual*.
- If the coolant is discolored, the maintenance period shall be shortened and the coolant shall be changed at a GAC Motor authorized shop.

High engine coolant temperature indicator lamp

When driving, always observe the indication of the engine coolant temperature gauge to know the coolant temperature.

If the coolant temperature is too high, the indicator lamp in the instrument cluster  comes on in red, and an alarm message is given to prompt the driver; at this time, the engine must be stopped in a safe place and the engine turned off. After the engine cools down, check the coolant level.

If the coolant level is normal but the indicator lamp is still on after the engine starts, do not continue to start the engine. Contact the GAC Motor authorized shop timely for inspection.

Check the coolant level

Be sure to check the coolant level regularly. Park the car on level ground, apply the park brake, and shut down the engine. After the engine cools down, open the engine hood and then check the coolant level.

WARNING

- **Be extremely careful when working in the engine compartment.**
- **The engine compartment is a high-risk area. Be sure to read and follow the relevant warning instructions carefully before opening the engine hood.**
- **If steam or coolant flows out from the engine compartment, do not open the engine hood, for fear of burns; wait till there is no steam or coolant overflowing and the engine cools down before opening the engine hood.**

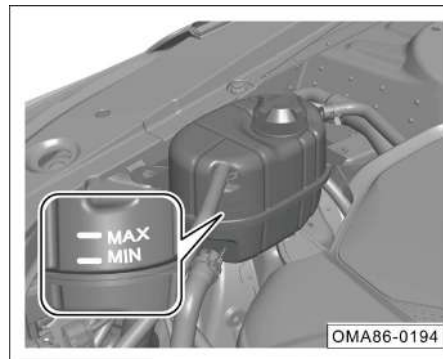

Check whether the coolant level in the expansion tank is between the upper limit mark "MAX" and the lower limit mark "MIN".

NOTE

When the engine is not cooled, the coolant level will be high, and there will be errors in checking the coolant level.

NOTE

When the coolant level is lower than the lower limit mark "MIN", coolant must be added. Too little coolant will affect the cooling effect and cause engine damage.

6. In-service Maintenance

Add coolant

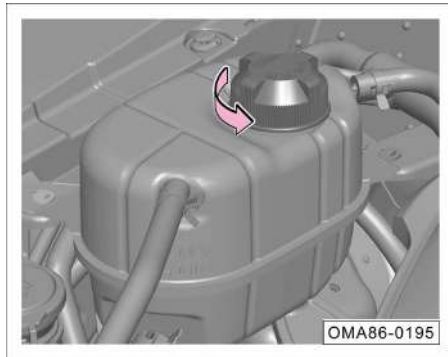

After checking the coolant level, if required, add coolant following the steps below:

- Wrap the expansion tank cap with a thick cloth and unscrew it counterclockwise.
- Add coolant between the upper limit mark "MAX" and the lower limit mark "MIN".
- Tighten the expansion tank cap clockwise.

NOTE

- When the engine is not cooled, the cooling system is under high pressure. Do not open the expansion tank cap, otherwise the emerging coolant will cause scald.
- Coolant can only be added after the engine has cooled down. The coolant level after filling must not exceed the upper limit mark "MAX". Otherwise, when the engine starts and the cooling system is under high pressure, coolant will overflow.
- Only add fresh coolant.

WARNING

- **It is forbidden to mix coolant that is not approved by our company into the original coolant.**
- **In case of emergency, if other coolant is used or pure water is added, go to the GAC Motor authorized shop to clean the cooling system and change the coolant in time.**
- **If the coolant consumption is too much or too fast, there may be a leak in the cooling system. Please go to the GAC Motor authorized shop for inspection in time.**
- **Coolant must be contained in the original container, and kept out of children's contact to avoid poisoning due to accidental ingestion.**

6.4.4 Windshield washer fluid and wiper blade

Add the windshield washer fluid

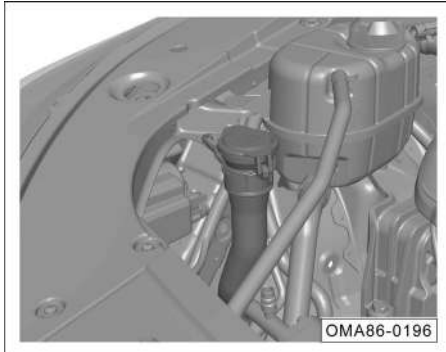

If the level of the washer fluid is too low, the washer fluid shall be added in time.

NOTE

Do not mix and use the windshield washer fluid with other cleaning liquids. Otherwise, the washer fluid will decompose and block the nozzle of the windshield washer.

WARNING

- Be extremely careful when working in the engine compartment. Be sure to read and follow the relevant warning instructions carefully before starting work.
- Do not misuse coolant or any other additives as windshield washer fluid. Otherwise, oil stains will be left on the windshield during cleaning of the windshield, which will affect the visual field and easily cause accidents.
- It is forbidden to use windshield washer fluid with more than 10% ethanol content. Under high temperature environment, this type of windshield washer fluid will cause corrosion of lamps and crack lamps. It is recommended to use methanol washer fluid.

Replace the front windshield wiper blades

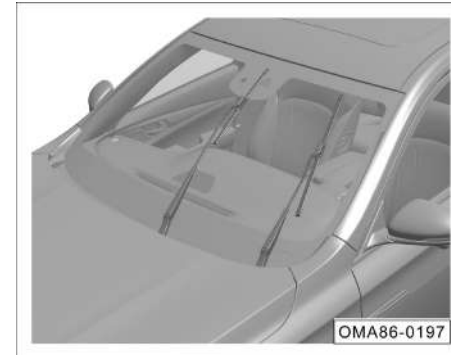

- Switch the engine start/stop button to the "ON" position and then to the "OFF" position.
- Set the wiper combination switch to MIST within 10 s. The wiper arm will stop after running for half a circle.

6. In-service Maintenance

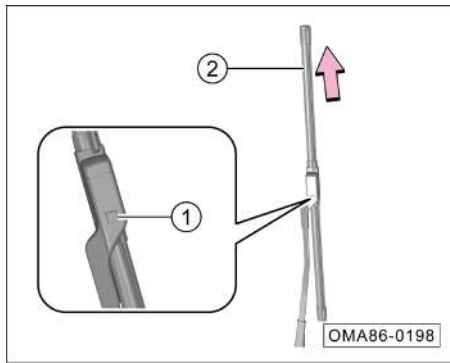

- Lift up the wiper arm, press the lock button ①, and slide the wiper blade ② upward in the arrowed direction to remove it.
- Install the new wiper blade into the wiper arm in reverse steps. It is installed in place when a “click” sound is heard.
- Gently put the wiper arm back on the windshield.
- Switch the engine start/stop button to the “ON” position to let the wiper arm automatically return in place.

If replacing wiper blades is required, it is recommended to go to the GAC Motor authorized shop for replacement.

NOTE

- When lifting up the wiper arm, please grasp the wiper arm with hands, rather than grasp the soft wiper blade.
- New wiper blades with the same length and specifications as the previous ones must be used.
- Be careful when lowering the wiper arm to prevent it from falling and hitting the windshield instantly.
- The status of the wiper blades must be checked regularly, and the wiper blades must be replaced as specified. Damaged wiper blades must be replaced in time.
- Excessively worn or dirty wiper blades are very easy to scratch the windshield, and will affect the field of vision when used, reducing driving safety.

6.4.5 Brake fluid

Function of brake fluid

Brake fluid is used to transmit power in the hydraulic brake system of the car.

The brake fluid is water-absorbent. It continuously absorbs moisture in the surrounding air during use. If the brake fluid stays in the system for too long and absorbs too much moisture, air resistance will generate in the system pipeline during braking, reducing the braking effect and impairing driving safety; it may even cause the complete failure of the brake system, resulting in accidents. Therefore, be sure to go to the GAC Motor authorized shop to check the brake fluid level or change the brake fluid according to the period specified in the *Warranty Manual*.

i NOTE

Specifications of brake fluid: DOT4.

⚠ WARNING

- **Using waste or old brake fluid or using brake fluid not applicable to the car will remarkably reduce the braking effect and even cause the brake system to fail! The company does not assume any responsibility (including quality guarantee) for car failures and damage caused thereby.**
- **Brake fluid in use must meet the criteria, and be fresh.**

Indicator lamp of brake system

When the car is running, if the  indicator lamp comes on in red, and the instrument cluster displays the information "Please add brake fluid", be sure to immediately stop the car at a safe place and check whether the brake fluid level is normal.

Check the brake fluid level

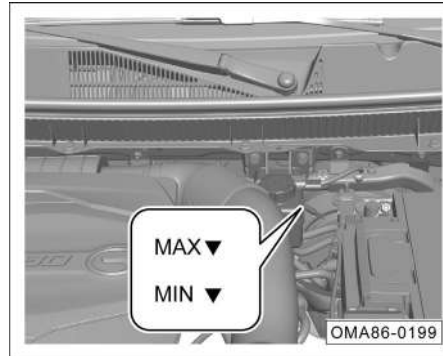

When the engine cools down, check whether the brake fluid level is between the upper limit mark "MAX" and the lower limit mark "MIN".

During car use, the brake fluid level will slightly drop due to the worn brake linings and automatic adjustment.

If the brake fluid level drops significantly in a short period of time or drops below "MIN", it indicates that the brake system may leak.

i NOTE

- After check of the brake fluid level, if the fluid level is below the lower limit mark "MIN", brake fluid must be added.
- If the brake system alarm indicator lamp does not go out or comes on again after the brake fluid is added, there may be a leak in the brake system, causing the brake fluid level to drop quickly, or the brake system malfunctions. In this case, do not continue to drive and contact the GAC Motor authorized shop in time for inspection.

Add brake fluid

In order to ensure the normal operation of the brake system, the added brake fluid shall meet the specifications:

- Open the brake fluid reservoir cap counterclockwise.
- Add fresh brake fluid to the upper limit mark "MAX" and stop adding.
- Tighten the brake fluid reservoir cap clockwise.

6. In-service Maintenance

NOTE





- The brake fluid will corrode the paint surface of the car body. Brake fluid splashed on the paint surface shall be wiped off in time.
- Using waste or old brake fluid or using brake fluid not applicable to the car will remarkably reduce the braking effect due to incompatibility and even cause the brake system to fail.

WARNING

- **Brake fluid is toxic. It must be contained in the original sealed container, placed in a safe place, and kept out of children's contact to avoid poisoning due to accidental ingestion.**
- **Brake fluid must be stored in accordance with environmental protection laws.**

6.4.6 Battery

Warning symbols and instructions for battery operation

	Goggles must be worn during operation!
	The battery electrolyte is highly corrosive. Protective gloves and goggles must be wore during operation!
	Open flames, sparks, uncovered lamps and smoking are prohibited in the workplace!
	Very explosive gas mixture is generated when the battery is being charged!
	Children must stay away from electrolytes and car batteries!

If not familiar with the operation process or without special tools, never carry out any operations on the electrical system of the car. The relevant operations shall be carried out by the GAC Motor authorized shop.

Charging system alarm lamp

The alarm indicator lamp is used to indicate alternator failure.

When the engine start/stop button is switched to the ON position and the engine is not started,  the alarm indicator lamp comes on. After the engine is started, the alarm indicator lamp shall go out.

When the car is running, if the alarm indicator lamp comes on, it indicates that the alternator is no longer charging the battery. Please go to the GAC Motor authorized shop for inspection as soon as possible.

Check the battery

The battery must be checked according to the period specified in the *Warranty Manual*.

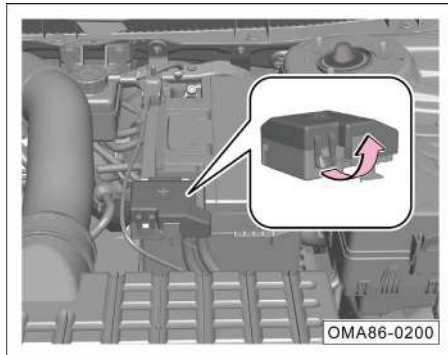

- Flip up the cover of the battery's positive terminal.
- Check the connection of the battery connector and the cable for corrosion or looseness; check the appearance of the battery for cracks, swelling, etc. If the phenomena above are found, please go to the GAC Motor authorized shop for inspection as soon as possible.
- If the car is not used for a long period of time, check the battery condition frequently.

i NOTE

- If the battery is low or damaged, making the engine difficult to start, please contact the GAC Motor authorized shop to charge or replace the battery.
- If it is required to replace the battery, please go to the GAC Motor authorized shop for replacement; if a wrong type of battery is used, the car may not run due to incompatibility or the electrical system may fail.

Instructions for using the battery

After the engine is turned off, the battery will quickly discharge when electrical equipment on the car is being used:

1. Do not use electrical equipment on the car for a long time after the engine is turned off.
2. When leaving the car, make sure that the doors are closed and all electrical equipment (e.g., lamps) is turned off.

i NOTE

- If the engine can not be started due to depleted battery, please try emergency start. If the engine still can not be started, please contact the GAC Motor authorized shop for overhaul.
- To avoid damage to the electrical system of the car, never connect power generation equipment such as solar panels or car battery chargers to a 12V power outlet.
- The battery contains toxic substances such as sulfuric acid and lead, so it must be disposed of properly and must not be treated as ordinary household waste.

6. In-service Maintenance

6.5 A/C filter

Check and clean the A/C filter

Check or clean the A/C filter regularly according to the provisions in the *Warranty Manual*. If the A/C filter is too dirty because the car runs in a harsh environment, it is recommended to shorten the replacement cycle of the A/C filter.

i NOTE

If it is impossible to remove and refit the A/C filter by yourself, please go to GAC Motor authorized shop to seek professional help.

Remove and refit the A/C filter



1. Open the glove box.
2. Disconnect the glove box from the damper in the arrowed direction.

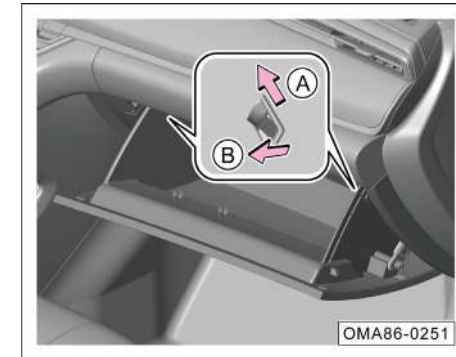

3. Push the glove box support block in the direction of arrow A.
4. Remove the glove box support block in the direction of arrow B.
5. Remove the glove box.

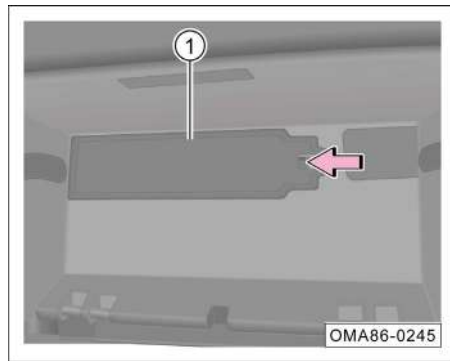

6. Press the cover clip in the arrowed direction and take out the cover ①.

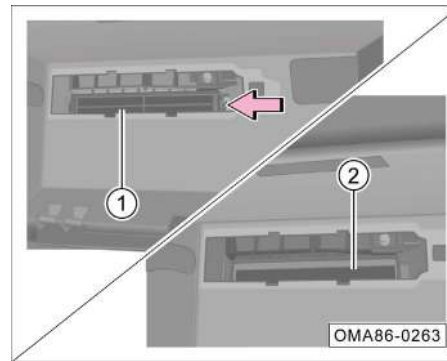

7. Press the filter element cover clip in the arrowed direction, and take out the filter element cover ①.

8. Take out the A/C filter ②. Tap the A/C filter to remove the dust.

9. Refit the A/C filter as per the reverse steps.

NOTE

- Because the fiber layer on the back of the A/C filter can not be blown with an air gun, it can not be cleaned and needs to be replaced in time after getting dirty.
- Since the A/C filter is made of special material, it shall not be washed with water. Otherwise, dust will accumulate and form clots, which will cause decreased air volume of A/C or even blockage.

6. In-service Maintenance

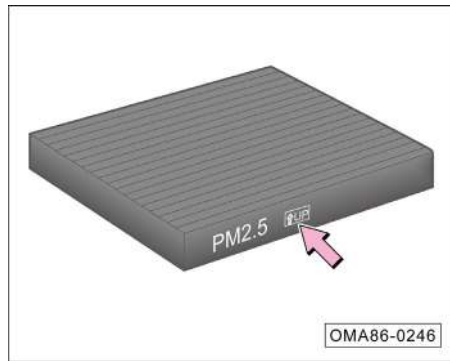

- When installing the A/C filter, install it according to the upward mark of the A/C filter.

6.6 Replacing bulb

Instructions for replacing bulbs

When replacing bulbs, be careful not to touch the bulb glass with fingers. Otherwise, the heat of the bulb will evaporate the grease on the bulb from fingerprints and condense it on the bulb glass, reducing the illuminance of the lamp.

After replacing bulbs, be sure to check the working status of lamps, and go to the GAC Motor authorized shop to check the beam status in time.

i NOTE

- Lamps for the car include halogen and LED types. If the LED bulb is damaged, please go to the GAC Motor authorized shop for replacement.
- The removal and refitting methods of the left and right bulbs are basically the same. Here only the removal and refitting methods of halogen bulbs on one side are described.

👁 NOTE

Damaged bulbs must be replaced with new ones with the same specifications. For the bulb specifications of this car, => [see page 259](#).

⚠ WARNING

If unfamiliar with the operation process, safe operation specifications and tool operation methods, do not replace bulbs yourself.

- **Turn off all lamps before replacing bulbs, and wait for bulbs till they are cool before replacement.**
- **Pay attention to the sharp parts on the combination lamp housing in the engine compartment during operation, and be careful not to scratch hands when replacing bulbs.**

Preparation for replacing bulbs

If it is found that any bulb is damaged, it shall be replaced as soon as possible. Before replacement, make the following preparations:

1. Turn off all lamps.
2. Turn the engine start/stop button to the "OFF" position.
3. Check whether the related fuse is blown. When the fuse is in good conditions, perform bulb inspection and replacement.

Replace the door courtesy lamp bulbs

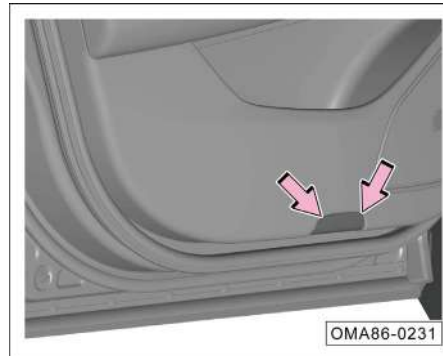

1. Pry out the arrowed door courtesy lamp.

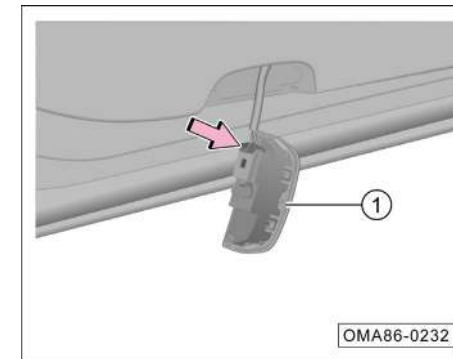

2. Disconnect the plug in the arrowed position, and remove the door courtesy lamp ①.

6. In-service Maintenance

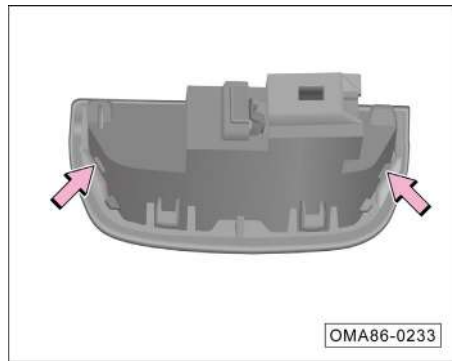

3. Carefully disengage the plastic clip in the arrowed position, and remove the door courtesy lamp shade.

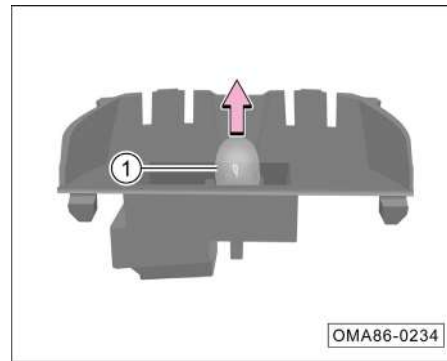

4. Take out the door courtesy lamp bulb ①.
5. Perform refitting in the reverse order.

6.7 Wheels

WARNING

Within the first 500 km, the road adhesion of new tires is unlikely to reach the best condition. Therefore, the car shall be driven carefully at a moderate speed to prevent accidents.

- Inadequate road adhesion of tires not subject to running-in period or excessively worn can directly affect the braking effect.
- If it is found that the car is abnormally vibrating or deviating, stop the car immediately and check whether the tires are damaged.
- If it is found that the tires are unevenly and excessively worn, please go to the GAC Motor authorized shop for inspection as soon as possible.

WARNING

If tires burst or leak when the car is running, it is very easy to cause serious traffic accidents.

- **Never use damaged tires and wheels, or use tires of which the treads have been worn to the wear indicators. Otherwise, it is very easy to cause an accident, because such tires may burst during driving, causing traffic accidents and injury. Such tires and wheels shall be replaced in time.**
- **The tire pressure must meet the regulations. Otherwise, it may cause an accident. If the tire pressure is insufficient, the continuous high-speed running of the car will cause the tire to deflect, and the tire is extremely easy to overheat, which may cause tread separation or tire burst.**
- **Be careful not to expose the tires to chemicals, oil, grease, fuel and brake fluid.**

WARNING

- **Never use old wheels and tires of unknown origin under any circumstances. Although such wheels and tires do not have visible damage, they may have been damaged. During driving, they may cause the car to lose control and lead to traffic accidents.**
- **It is not recommended to use recycled tires. For such tires, the carcass may degrade as the service time passes, and the durability may also be restrained, impairing the driving safety.**

Precautions for wheel failure

- When driving over curbs or similar obstacles, keep a slow speed in the vertical direction of the obstacles as much as possible.
- Be careful not to let the tires contact with grease, oil and fuel.
- Regularly check the damage status of tires (i.e., splitting, abrasion, shedding, deformation or bulging).
- Regularly remove debris embedded in the grooves of the tire pattern.

Instructions for storing tires

- Before removing the tire, make a mark on the tire to indicate the rotation direction of the tire. Refit the tire according to the mark to ensure the rotation direction and the dynamic balance of the wheel are unchanged.
- Store the removed wheels or tires in a cool, dry place, and preferably in a dark place.
- The tire mounted on the rim must not be stored upright.

6. In-service Maintenance

New tires and wheels

- Select the new tire and wheel carefully, and make sure that the dimensions, load range, rated speed and structure type of new tire are the same as those of original one.
- Replace at least two tires on the same axle at the same time, rather than only one tire individually.
- Do not use tires of different dimensions or types, and do not mix summer tires, all season tires and winter tires in use.
- Once wheels are installed, check whether the tightening torque of the wheel bolts ($125 \pm 10 \text{ N} \cdot \text{m}$) meets the requirements.

Non-full-size spare tires

Spare tires and standard tires are different in aspects such as structure, pattern, speed grade and load index, and can not be exchanged.

After emergency use of the spare tire, it is necessary to drive safely to the GAC Motor authorized shop or the wheel repair shop as soon as possible to replace it with a standard tire, so as to avoid the hidden safety hazards of long-term use of the spare tire.

WARNING

- **Spare tires can only be used temporarily for emergency, and the maximum driving speed shall not exceed 80 km/h.**
- **The storage and service life of spare tires is 6 years. It is prohibited to use them beyond the time limit.**

Summer tires

Summer is a rainy season. The tire tread depth directly affects the driving safety in rainy days. In summer, when the tire tread depth is less than 3 mm, there is a high risk of water slippage.

Winter tires

Winter tires still have good grip performance when roads are covered with snow and ice. The specially designed rubber tread makes the tires less affected by low temperature environment and excellent braking ability, ensuring driving safety.

- Use winter tires on all the four wheels.
- It is recommended to use winter tires when driving in icy or snowy days in winter or when the temperature is below 7°C .
- Use only radial winter tires of same dimensions, load range and rated speed as original ones.

- Please note that the tread of winter tires shall have patterns deep enough (tread depth not less than 4 mm; otherwise, the applicability in winter will be limited).
- After installation of tires, check the tire inflation pressure.

⚠ WARNING

- **Winter and summer tires are designed according to their respective typical lane conditions under the corresponding seasonal conditions. It is recommended to use winter tires in winter. At low temperatures, the adaptability of summer tires is significantly poorer, thereby losing road adhesion and braking ability.**
- **In severe cold conditions, if summer tires are used, cracks may appear on the tires, thereby completely damaging the tires, and causing excessive tire noise and loss of balance.**

⚠ WARNING

- **Winter tires may lead to decreased traction force of the car on dry roads, increased road noise and shortened service life of tread. Please pay attention to the performance change of the car in terms of maneuvering and braking after the winter tires are used.**
- **Please note that the maximum speed for winter tires is relatively low. Do not exceed the allowable maximum speed for the tires.**
- **Please note that when driving in atmospheric temperature rising above 7°C, in order to ensure driving safety and performance, please replace the winter tires with summer tires in time.**
- **When driving with winter tires, if a spare tire is installed, unstable steering characteristics may occur due to different tires, weakening driving stability. In this case, driving styles need to be adjusted and driving shall be performed carefully.**

Check tire pressure

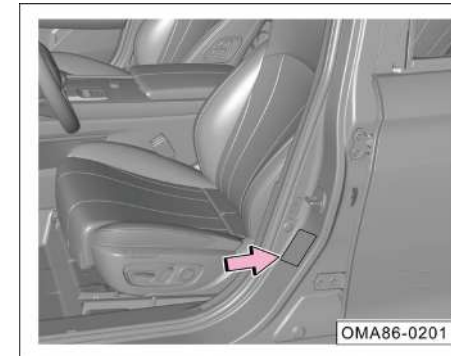

The standard tire pressure data label of the original tire of this car is attached to the B pillar on the driver's side.

- Check the tire pressure value applicable to the car from the data label (the listed pressure values apply to both summer and winter tires).
- Unscrew the valve cap (if the valve cap is missing, a new one shall be provided in time).
- A high-quality tire pressure gauge is required to check the tire pressure. It is impossible to determine whether the tire pressure is appropriate only by visual inspection.
- Attach the tire pressure gauge to the valve.

6. In-service Maintenance

- For inspection of tire pressure, the tire must be in a cold state. When the temperature increases, the tire pressure can be slightly higher than the specified value, and it is not necessary to reduce the tire pressure.
- Balance the weight of occupants and luggage, avoid slopes, and adjust tire pressure according to car load.
- Check the tire pressure of the spare wheel or emergency spare wheel at the same time.
- Install and tighten the valve cap.

i NOTE

- The current tire pressure of the wheel can be checked through the information on the display of the instrument cluster.
- Be sure to refit the valve cap to the valve core. The valve cap can prevent dust and moisture from entering the tire.

⚠ WARNING

- **Abnormal tire pressure may cause tire burst, resulting in a traffic accident, injury or even death.**
- **Check the tire pressure at least once a month or before long-distance driving. The tire pressure must meet the specified requirements to prevent accidents.**
- **Insufficient tire pressure will exacerbate tire deflection, and tires are extremely prone to overheating, which may lead to tread separation and tire burst.**
- **Abnormal tire pressure, too low or too high, will cause early wear of tires and reduce the maneuvering stability of the car.**

Service life of tires

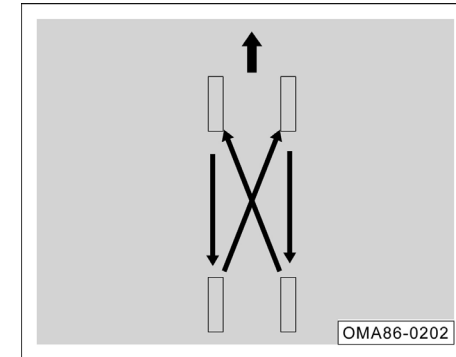

Service life of tires depends on tire pressure, driving style and tire assembly conditions.

If the front tires are worn more serious than the rear tires, it is recommended to perform tire rotation for the front and rear wheels as shown, so as to make the service life of all tires about the same.

⚠ WARNING

For cars with a tire pressure monitoring system, tire rotation or replacement needs to be operated by professionals at the GAC Motor authorized shop.

Tire wear indicator

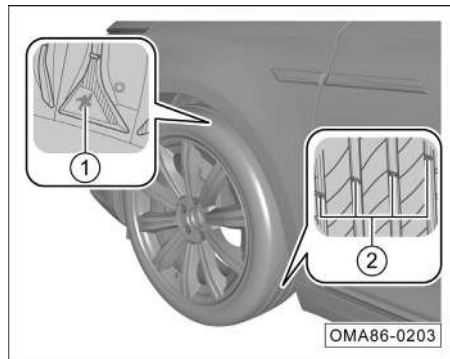

The mark ① is used to indicate the wear condition of the tire outer circle pattern. If the tire outer circle pattern wears to the condition as shown, the tire can no longer be used safely and must be replaced immediately.

The tread wear indicator mark ② is 1.6 mm high. If the tread pattern wears to the marked surface, the tire can no longer be used safely and must be replaced immediately.

Wheel balance

The wheels of the new car are already balanced. Due to various reasons, the wheels may go unbalanced during operation, which can be manifested by the vibration of the steering mechanism.

Because unbalanced wheels can cause excessive wear on the steering system, wheel suspension mechanism and tires, the wheels shall be rebalanced.

In addition, wheels must be rebalanced after installation of a new tire or tire repair for any wheel.

Wheel misalignment

Wheel misalignment will cause uneven and excessive wear of the tires, affecting driving safety. If uneven and excessive wear of the tires is found, please go to the GAC Motor authorized shop to check the wheel alignment as soon as possible.

6.8 Tire chain

In winter, driving in harsh environments such as snowy or icy roads can increase the degree of tire wear or cause other failures. To reduce failures in winter, the following opinions must be followed:

- When driving in deep snow, it is necessary to install tire chains on the tires. If so, be sure to choose an equivalent product whose size and type meet the specifications of the tires on the car. Failure to do this will adversely affect the performance and safety of the car. Moreover, operations such as full-load driving, speeding, emergency acceleration, emergency braking, and emergency turning are potentially dangerous.
- During deceleration, make full use of the engine braking function. Emergency braking on snowy or icy roads will cause the car to flick and slip. Maintain an appropriate safety distance from the car in front, step on the brake pedal slightly, and pay attention that installing tire chains on the tires can increase certain friction force, but can not prevent side slipping.

6. In-service Maintenance

NOTE

Various countries and regions have different regulations on tire chains. Before assembling tire chains, please refer to the laws and regulations of the corresponding country and region. Do not install tire chains without understanding the laws and regulations of the corresponding country and region that may restrict the use of tire chains.

NOTE

- For installation of tire chains on all tires, ensure that the car can be driven in a balanced manner in all weathers. It shall be borne in mind that after installation of tire chains, the car power may be insufficient. Even if the road surface is in good condition, drive carefully. When driving, do not exceed the specified speed limit of tire chains, nor exceed 50 km/h, whichever is lower.

NOTE

- If tire chains are installed on the tires, the size and type of tire chains shall be consistent with those of the standard tires on the car. Otherwise, the driving safety and maneuvering of the car will be adversely affected.
- Tire chains must be installed in pairs on the front wheels, rather than on the rear wheels.
- Do not install the tire chain on an emergency spare tire. If a spare tire is installed on the front wheel and a tire chain is required, be sure to exchange the positions of the spare tire and the rear tire.
- Do not use tire chains on dry ground. After driving to snow-free roads, remove tire chains.
- After installing the tire chains as closely as possible to the front tires, drive 0.5~1.0 km, and then tighten the tire chains again.

7.1 VIN

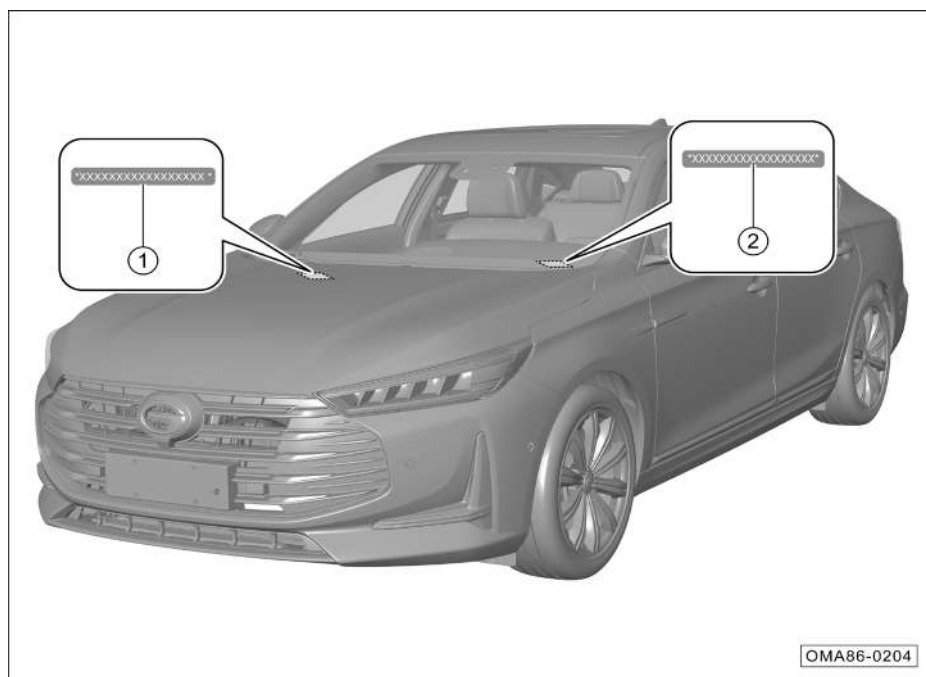

The locations of the vehicle identification number (VIN) is shown in the figure:

- ① Vehicle identification number (VIN): located on the engine compartment partition.
- ② Vehicle identification number (VIN): located on the left side of the instrument panel.

i NOTE

The position indication and quantity of vehicle identification number (VIN) are not complete. Please refer to the actual car.

7. Technical Data

OBD (on-board diagnostic) interface

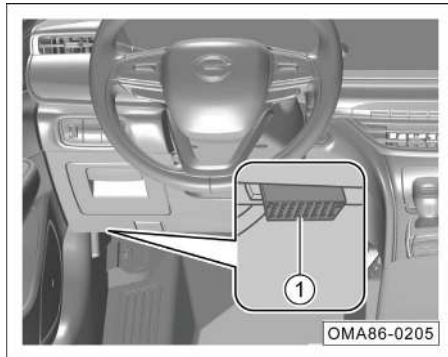

The OBD interface ① for reading the electronic VIN is located at the lower left rear of the instrument panel. Data such as the electronic VIN and car status information can be read through a special scan tool.

Engine model and factory number

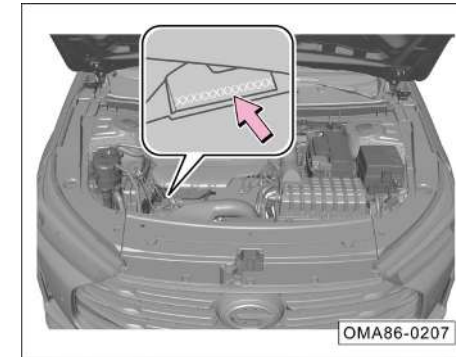

The engine model and factory number as arrowed are indicated on the engine block (behind the alternator).

7.2 Vehicle dimension parameters

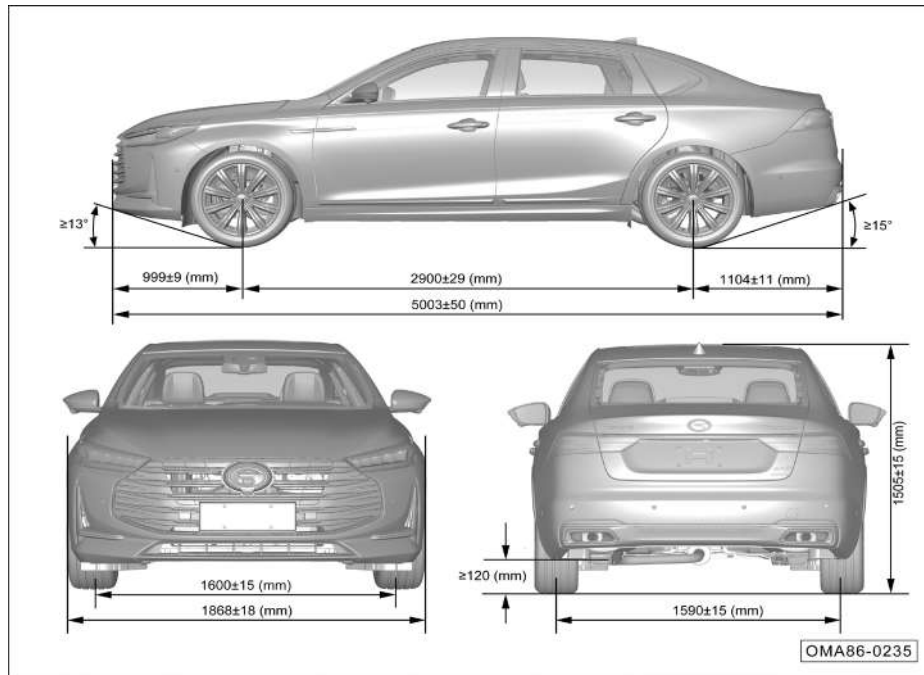

Dimensions

Item	Parameters		
	Numerical value	Unit	
Overall length	5003 ± 50	mm	
Overall width	1868 ± 18	mm	
Overall height	1505 ± 15	mm	
Wheel base	2900 ± 29	mm	
Wheel track	Front wheel	1600 ± 15	mm
	Rear wheel	1590 ± 15	
Front suspension	999 ± 9	mm	
Rear suspension	1104 ± 11	mm	
Minimum ground clearance (full load)	≥ 120	mm	
Approach angle (full load)	≥ 13	°	
Departure angle (full load)	≥ 15	°	

Note: The external rearview mirrors (respective one on the right and left) near the junction of the lower end of the A pillar and the front door and the shark fin antenna above the rear of the roof are not included in the overall width.

7. Technical Data

7.3 Vehicle mass, engine and fluid parameters

Weight

Model	Kerb mass of complete car (kg)			Maximum gross mass (kg)		
	Kerb mass	Front axle load	Rear axle load	Maximum gross mass	Front axle load	Rear axle load
GAC7200L1A6	1705 ± 51	1040 ± 31	665 ± 19	2105	1168	937
GAC7200L2A6	1705 ± 51	1040 ± 31	665 ± 19			
	1730 ± 51	1046 ± 31	684 ± 20			

Comprehensive parameters

Item	Performance parameters		Unit
	GAC7200L1A6	GAC7200L2A6	
Number of occupants	5	5	Person
Minimum turning diameter	≤ 12.1	≤ 12.1	m
Maximum gradeability	40	40	%
Time required to accelerate from start to 100 km/h	≤ 7.8 (1 person)	≤ 7.8 (1 person)	s
	≤ 9.3 (half load)	≤ 9.3 (half load)	
Maximum vehicle speed	≤ 210	≤ 210	km/h
Fuel consumption in urban running conditions	≤ 10.8	≤ 10.8	L/100 km
Fuel consumption in suburban running conditions	≤ 6.1	≤ 6.1	L/100 km
Fuel consumption in comprehensive running conditions	≤ 7.8	≤ 7.8	L/100 km

7. Technical Data

Parameters of engine

Model	4B20J1
Type	Gasoline engine, spark-ignition, in-line, four-cylinder, four-stroke, water-cooled, in-cylinder direct injection, double overhead camshafts, exhaust gas turbocharging
Number of cylinders (pcs)	4
Ignition order	1-3-4-2
Bore (mm)	83
Travel (mm)	92
Displacement (mL)	1991
Compression ratio	10:1
Rated power/speed (kW/(r/min))	185/5250
Maximum net power/speed (kW/(r/min))	170/5250
Maximum torque/speed (N·m/(r/min))	390/1750~4000
Maximum net torque/speed (N·m/(r/min))	380/1750~4000
Stable idle speed (r/min)	700 ± 50
Emission standard	China VI

7. Technical Data

Specifications and capacity of fuel/oil/fluid

Item	Specifications	Capacity	
Fuel	Please refer to the description on the fuel requirement label at the fuel filler door of each vehicle.	Total	65L
Engine coolant ²⁾	DF-6, -35°C coolant	Total	7.2 ± 0.2 L
Engine oil	Engine oil grade: SN and above Engine oil viscosity: SAE5W-30	Total ³⁾	5.3±0.1L
		Change ⁴⁾	4.5L
Automatic transmission fluid	AW-1	Total	6.6±0.1L
Brake fluid	DOT4	Total	0.75±0.05L
Windshield washer fluid	44% methanol, and 56% water with hardness not more than 205 g/t	Total	2L
A/C refrigerant	R134a	Total	500±20 g

Notes: 1) Long-term use of fuels with a sulfur content higher than the standard value may result in excessive emissions. Please pay attention and use fuels that comply with local standards for cars.

2) Including the coolant in the expansion tank and the residual coolant in the engine.

3) The oil capacity for overhaul of engine assembly.

4) Including the oil capacity for replacement of oil filter.

7.4 Transmission and chassis parameters

Transmission parameters

Model	TF-83SC
Type	AT, 6 gears
Final ratio	3.749
1st gear	4.188
2nd gear	2.416
3rd gear	1.556
4th gear	1.153
5th gear	0.852
6th gear	0.673
Reverse gear	3.203

Wheel

Rim specifications	7J × 17*, 8J × 18*			
Tire specifications	235/45R18*, 225/55R17*			
Tire pressure	Half load		Full load	
	Front wheel	Rear wheel	Front wheel	Rear wheel
	240kPa	240kPa	240kPa	240kPa
	240kPa	240kPa	260kPa	240kPa
Specifications of spare tire	T125/80D17			
Pressure of spare tire	420kPa			

Note: The standard tire pressure data label of the original tire of this car is attached under the B pillar on the driver's side.

7. Technical Data

Suspension

Type	Front suspension	Rear suspension
	Double wishbone independent	Multi-link, independent

Steering gear

Type	Rack and pinion mechanical steering gear
Power steering type	Electric power

Brake

Type	Vacuum booster, X-type hydraulic double circuit
Front wheel	(Disc brake)
Rear wheel	(Disc brake)
Parking brake	Electric park brake (EPB)

Driving type

Driving type	Front wheel drive
--------------	-------------------

Dynamic balance of wheels

Designation		Residue dynamic unbalance
Front wheel	Inner side	≤ 8 g
	Outer side	≤ 8 g
Rear wheel	Inner side	≤ 8 g
	Outer side	≤ 8 g

Free travel of brake pedal

Designation	Parameters
Travel	114 ± 10 mm
Free travel	≤ 10 mm

Technical parameters of brake linings

Designation	Parameters
Wear limit of front wheel brake lining (excluding the backplate of brake lining)	2 mm
Wear limit of rear wheel brake lining (excluding the backplate of brake lining)	2 mm

Wheel alignment

Designation		Parameters
Front wheel	Single wheel toe-in	2'±3'
	Wheel camber angle	-1'±30'
	Kingpin caster angle	4°41'±45'
	Kingpin inclination angle	6°26'±30'
Rear wheel	Single wheel toe-in	6'±3'
	Wheel camber angle	-14'±30'

Battery

Model	SLIH6	
Parameters	Rated voltage	12 V
	Capacity at 20 hr	75Ah
	Low temperature start current (EN)	680A

Fuse

Instrument panel PDU	=> See Page 269
Engine compartment PDU	=> See Page 272

Lamps

Lamps		Model	Power
Front combination lamp	High beam	LED	/
	Low beam	LED	/
	Daytime running lamp*	LED	/
	Front position lamp	LED	/
	Front turn signal lamp	LED	/
Rearview mirror side turn signal lamp		LED	/
Rear fog lamp		LED	/
Rear combination lamp	Brake lamp	LED	/
	Rear position lamp	LED	/
	Rear turn signal lamp	LED	/
	Reversing lamp	LED	/
License plate lamp		LED	/
High-mounted stop lamp		LED	/
Front roof lamp		LED	/
Rear roof lamp		LED	/

7. Technical Data

Lamps		Model	Power
Courtesy lamp		ART10C-2R	5W
Glove box lamp		LED	/
Trunk lamp		LED	/
Ambient light*	Instrument panel left atmosphere lamp	LED	/
	Instrument panel right atmosphere lamp	LED	/
	Driver's and front passenger's side foot lamps	LED	/
	Storage box atmosphere lamp	LED	/
	Door interior trim panel atmosphere lamp	LED	/
	Console mobile phone storage box atmosphere lamp	LED	/
Courtesy lamp*		LED	/
Sun visor vanity mirror lamp		LED	/

For replacement of bulbs=> [See Page 242](#), some bulbs are only suitable for certain models. Please refer to the actual car configuration!

8.1 Driver's tools and spare tire

Driver's tools

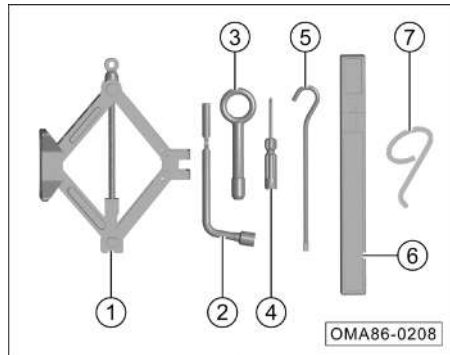

The following tools are provided with this car. After use, they shall be cleaned in time and placed in the tool kit.

- ① Jack
- ② Wrench bolt removal wrench
- ③ Towing hook
- ④ Dual-purpose screwdriver
- ⑤ Special wrench for jack

⑥ Warning triangle

⑦ Hub trim cover screwdriver*

Spare tire

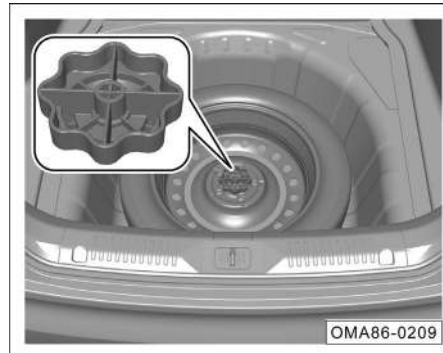

Remove the spare tire:

- Open the trunk lid and remove the trunk carpet.
- Take out the tool kit.
- Unscrew the spare tire center handwheel counterclockwise and take out the spare tire.
- The spare tire has been inflated. Check its pressure regularly to ensure that it is at the specified maximum tire pressure, and perform multiple inspections every year.

⚠ WARNING

- The spare tire shall be used strictly in accordance with its use requirements to avoid danger.
- It is strictly prohibited to install and use more than one spare tire at the same time.
- It is forbidden to use spare tires that have been damaged or worn to the limit.
- The storage and service life of spare tires is 6 years. It is prohibited to use them beyond the time limit.
- After installing the spare tire, check the tire pressure as soon as possible to keep it within the specified range.
- The maximum speed of spare tires must not exceed 80 km/h, and rapid acceleration and emergency braking shall be avoided.

8. Accident Handling

8.2 Use of warning triangle

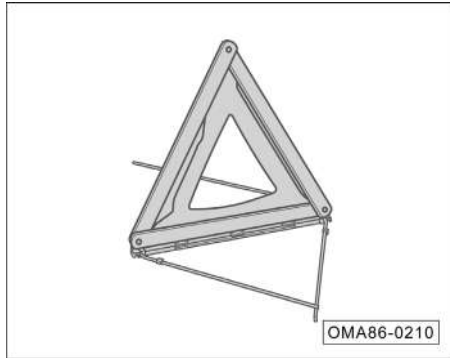

- Open the trunk lid, remove the warning triangle and unfold it for use.

Placement distance

Ordinary highway		Expressway
Daytime	Night	
≥ 50 m	≥ 80m	≥ 150m

NOTE

The data above is for reference only. Please place the warning triangle at the distance specified by traffic regulations.

8.3 Use of reflective vest

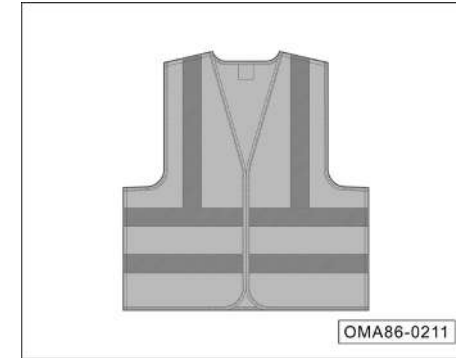

- If the car needs to stop due to an accident or other failures, take out the reflective vest from the glove box and wear it neatly before getting off the car to check and deal with the car failure.

i NOTE

- When handling car accidents, regardless of the lighting conditions, be sure to wear a reflective vest as required to attract the attention of passersby or other drivers.
- After using the reflective vest, please store it in the glove box properly. If necessary, clean it according to the collar mark to maintain the reflective performance.

8.4 Replacing leaky tires

Preparations

- Apply the park brake.
- Shift the gearshift lever to "P".
- Turn the engine start/stop button to the "OFF" position, and turn on the hazard warning lamp.
- Place a warning triangle in a suitable position behind the car.
- Find a suitable object to catch the wheel in the diagonal position of the one to be replaced to prevent the car from moving.
- Take out the driver's tools and spare tire.

⚠ WARNING

- **Relevant regulations must be strictly followed.**
- **All occupants must leave the car and wait in a safe place.**

Loosen the wheel bolts

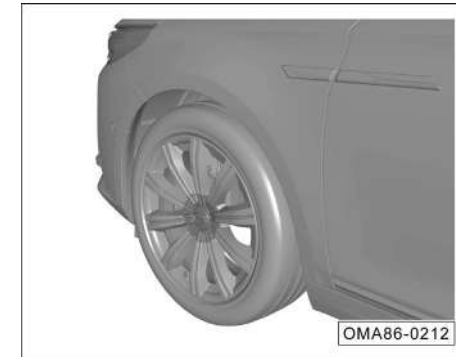

Pry off the hub trim cover using a hub trim cover screwdriver.

8. Accident Handling

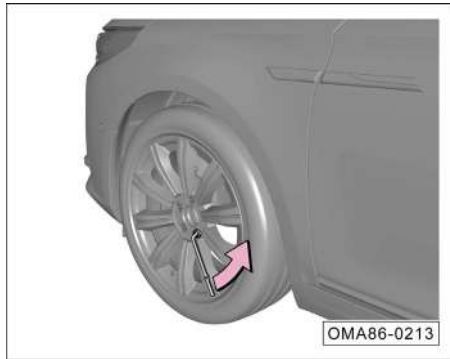

Set the wheel bolt removal wrench firmly on the wheel bolt, and loosen the wheel bolts counterclockwise.

NOTE

Loosen the wheel bolts just one turn before lifting the car. After lifting the car, unscrew the wheel bolts completely, and then remove the flat tire.

Lift the car

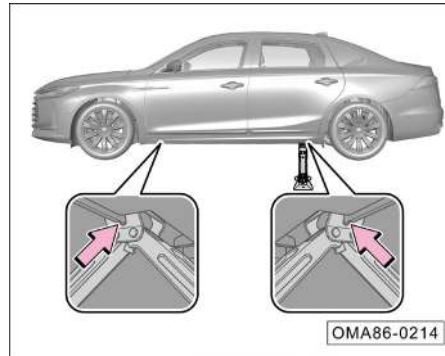

- Place the jack directly under the spine closest to the flat tire.
- Extend the jack high to ensure that the groove of the jack can engage with the spine.
- Check whether the jack is stable and tightly attached to the ground.

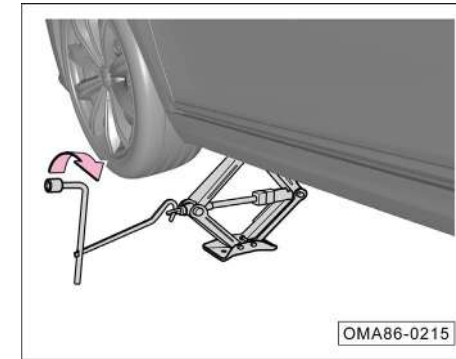

- Assemble the wheel bolt removal wrench, the special wrench for jack and the jack.
- Extend the jack clockwise to lift the car and lift the tire off the ground.

 WARNING

Improper use of jacks can cause serious injury.

- The jack must be used on a hard and flat ground, and a hard pad (height not more than 1 cm) can also be placed under the jack as needed.
- Strictly observe the precautions for jack operation.
- If there is a trailer, the trailer must be separated from the car.
- Observe the status of the car continuously during the lifting process. If the car body is noticeably tilted, stop the lifting, find the problem, and then lift the car after solving the problem.

 WARNING

- The jack on the car can only be used to lift the car, rather than other heavy objects or cars.
- When using the jack, do not start the engine, otherwise an accident may occur.
- When lifting the car with a jack, remember not to place any part of your body under the car to avoid accidents.
- If it is required to work under the car, be sure to place a suitable protective support under the car.

Install the spare tire

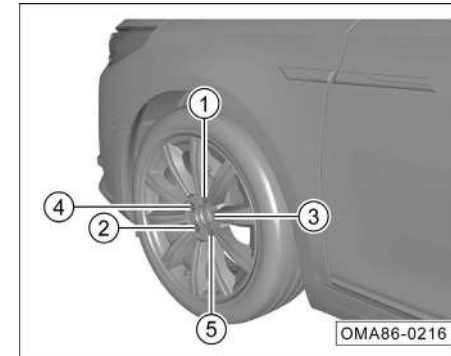

- Install the spare tire to the car.
- Install all the wheel bolts, and pre-tighten them using the wheel bolt removal wrench according to the sequence ①~⑤ in the figure.
- Give a verbal warning, and after confirming that nobody is around the car, rotate the jack wrench counterclockwise to lower the car.
- Tighten all wheel bolts using the wheel bolt removal wrench.

8. Accident Handling

- In order to avoid the noise of the car during driving later on, please remember the locations of various tools, put them back in place after use and fix them.

NOTE

After installing the wheel, please go to the GAC Motor authorized shop in time to check the tightening torque of the wheel bolts (125 ± 10 N•m). Otherwise, the bolts may loosen while the car is running, easily causing traffic accidents.

WARNING

- **The thread on the wheel bolt and the hub must be kept clean, so that the bolt is easy to tighten, and there must be no adherent matters such as grease.**
- **For replacement of a tire, if the bolts are corroded or difficult to tighten, they must be replaced and the thread hole cleaned.**
- **When the spare tire is not in use, it must be securely fixed in the place where the spare tire is mounted.**

8.5 Microwave window

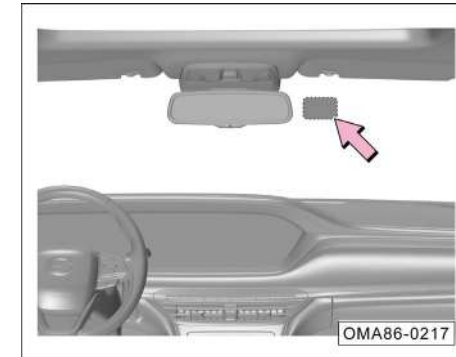

- The microwave window is set on the right of the front windshield corresponding to the interior rearview mirror.

NOTE

Microwave window can be used for installation of ETC card.

8.6 Fuse

Instrument panel PDU

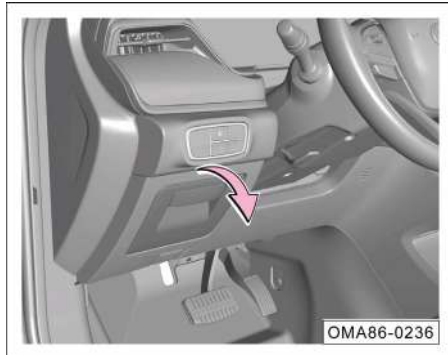

- Open the cab lower protective plate storage box in the arrowed direction and pull it out to see the fuse above the instrument panel PDU.

Engine compartment PDU

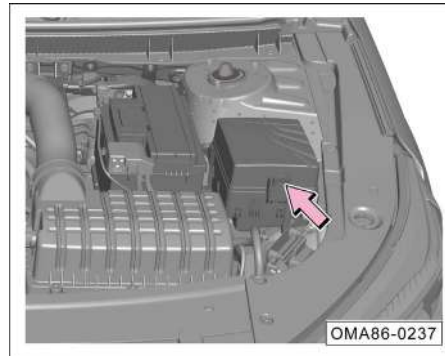

- Open the engine hood.
- Press the fixing clip in the arrowed direction to release the cover of the PDU.
- Remove the cover of the PDU to see the fuse above the engine compartment PDU.

Replace the fuse

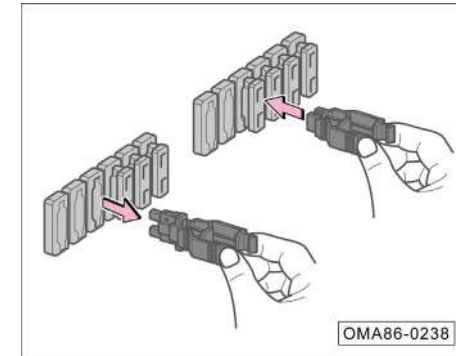

- Pull out or install the fuse using the fuse puller in the engine compartment PDU.

8. Accident Handling

Blown fuse

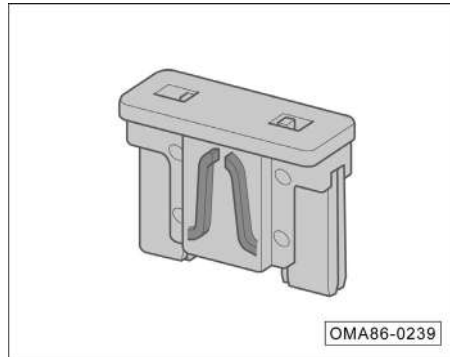

- If the fuse has blown, it is recommended to replace it at a GAC Motor authorized shop.

NOTE

Some electrical units may be equipped with multiple fuses each, or multiple electrical units may share a single fuse.

NOTE

- All electrical equipment must be turned off before replacement of fuses.
- If it is required to replace the fuse, please consult the GAC Motor authorized shop.

WARNING

- **Fuses must not be reused.**
- **Do not use a fuse with rated current higher than the specified value, otherwise other components of the electrical system will be damaged.**
- **Using an inappropriate or repaired fuse will cause a short circuit or even a fire.**
- **The color and logo of the replaced fuse must be exactly the same as the original one.**
- **Never replace a fuse with metal sheets, clips, etc.**
- **The PDU must be kept clean inside. Pay attention to protection against moisture.**

8.6.1 Fuses in instrument panel PDU

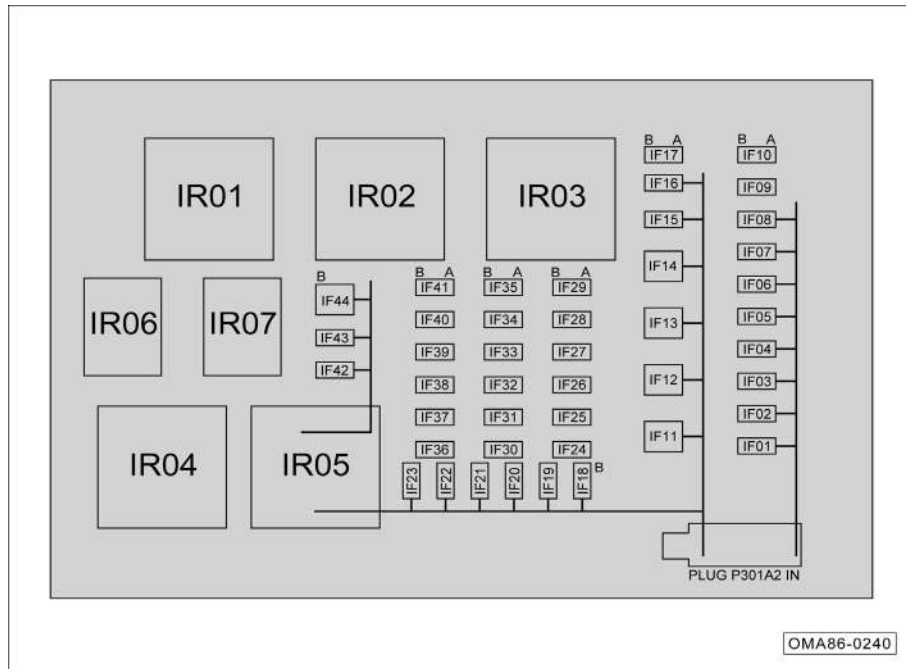

The picture is not guaranteed to be suitable for every car model. If it is required to know the purpose of the fuse, please check it on the actual car. For different car models, fuses may be slightly different.

8. Accident Handling

No.	Rated value	Feature/part
IF01	Shorting link	—
IF02	7.5A	A/C control panel/rear central control panel*/audio display screen/ Instrument cluster/front central control panel
IF03	15A	Audio control unit/audio control unit (w/integrated T-BOX function)*
IF04	10A	Rearview mirror folding relay*/rearview mirror unfolding relay*
IF05	15A	Body control unit
IF06	20A	Sunroof sunshade motor*/panorama sunroof control unit*/electric sunroof control unit*
IF07	7.5A	OBD (on-board diagnostic) interface
IF08	10A	IG2 relay
IF09	—	—
IF10	—	—
IF11	30A	Left front window regulator motor/body control unit/right rear window regulator motor (w/o express-up and down feature)*/*right rear window regulator motor (with express-up and down feature)*/*body control unit
IF12	30A	Front right window regulator motor (w/express-up and down feature)*/*body control unit/left rear window regulator motor (w/express-up and down feature)*/*left rear window regulator motor (w/o express-up and down feature)*
IF13	30A	Gearshift lever module
IF14	30A	Gearshift lever module
IF15	20A	Body control unit

No.	Rated value	Feature/part
IF16	7.5A	Keyless start and smart entry system control unit/gateway control unit*
IF17	7.5A	Gateway control unit*/body control unit/keyless start and smart entry system control unit
IF18	10A	Body control unit
IF19	15A	Body control unit
IF20	7.5A	Keyless start and smart entry system control unit
IF21	20A	Body control unit
IF22	7.5A	High-mounted stop lamp
IF23	20A	Body control unit
IF24	—	—
IF25	10A	Mobile phone wireless charging module*/USB5V power supply/left front seat connector C/rear sunshade*/amplifier module*/audio control unit (w/integrated T-BOX function)*/*audio control unit (USB2 only)/exterior rearview mirror adjustment switch (w/o memory)*
IF26	7.5A	Body control unit/keyless start and smart entry system control unit
IF27	—	—
IF28	—	—
IF29	—	—
IF30	7.5A	Left front combination lamp/right front combination lamp/headlamp leveling switch*/ Headlamp automatic adjustment control unit*

8. Accident Handling

No.	Rated value	Feature/part
IF31	7.5A	Electric sunroof control unit*/right front seat connector A/rain light sensor*/panoramic sunroof control unit*/negative ion generator*/A/C control panel/A/C control unit/air quality sensor*/rear central control panel*/front central control panel
IF32	7.5A	Reversing radar control unit*/panorama parking control unit*/automatic parking control unit*/lane departure warning module*/forward radar module*/audio control unit (w/integrated T-BOX function)*/instrument cluster/T-BOX control unit*
IF33	7.5A	Steering angular velocity sensor/electric power steering control unit/gearshift lever module
IF34	10A	Airbag control unit
IF35	7.5A	Electronic stability and parking control module/brake switch/engine control unit/automatic transmission control unit
IF36	7.5A	Panoramic parking control unit*/blind spot detection auxiliary control unit*/blind zone detection main control unit*/lane departure warning module*/forward radar module*
IF37	7.5A	Headlamp automatic adjustment control unit*/T-BOX control unit*
IF38	7.5A	Right front door handle switch/left front door handle switch
IF39	15A	Mobile phone wireless charging module*/left front seat connector C/A/C control unit/left front door centralized control switch/PM2.5 sensor*
IF40	—	—
IF41	—	—
IF42	—	—

No.	Rated value	Feature/part
IF43	7.5A	Right exterior rearview mirror/left exterior rearview mirror
IF44	30A	Rear windshield defogger
IR01	—	IG2 relay
IR02	—	ACC relay
IR03	—	IG1 relay
IR04	—	Fuel tank cap lock relay
IR05	ACC	Defogger relay
IR06	—	Rearview mirror folding relay*
IR07	—	Rearview mirror unfolding relay*

8. Accident Handling

8.6.2 Fuses in engine compartment PDU

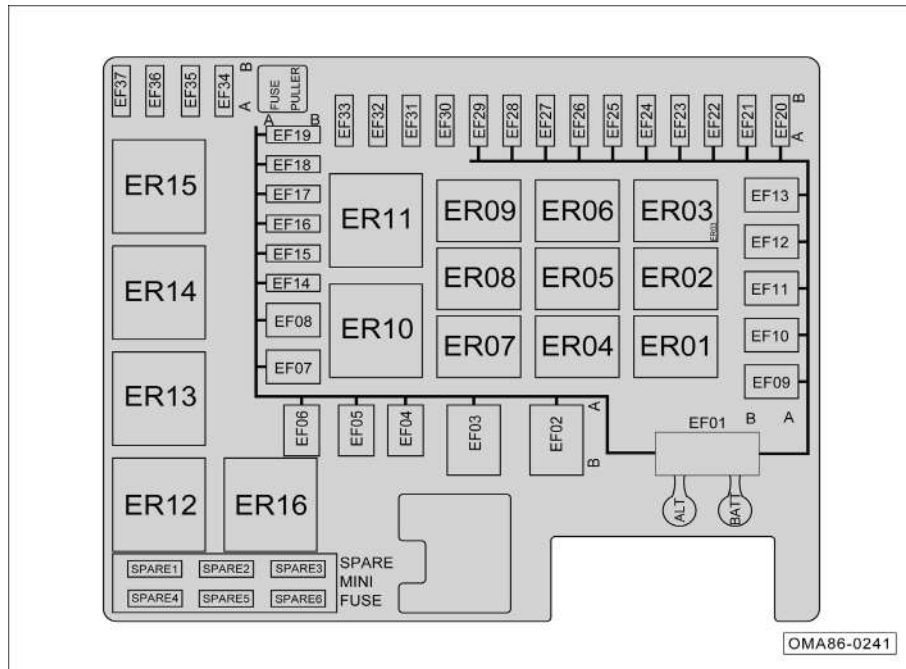

The picture is not guaranteed to be suitable for all car models. If it is required to know the purpose of the fuse, please check it on the actual car. For different car models, fuses may be slightly different.

8. Accident Handling

No.	Rated value	Feature/part
EF01	150A	Alternator/battery
EF02	80A	Electronic power steering control unit
EF03	80A	Instrument panel PDU
EF04	60A	Radiator fan relay
EF05	40A	ACC relay
EF06	—	—
EF07	—	—
EF08	40A	Blower relay
EF09	40 A/60 A	Electronic stability and parking control module
EF10	50A	Instrument panel PDU
EF11	40A	Electronic stability and parking control module
EF12	30A	Starter relay 1
EF13	30A	IG1 relay
EF14	15A	Amplifier module*
EF15	20A	Right front seat connector A
EF16	15A	Amplifier module*
EF17	7.5A	A/C compressor relay
EF18	20A	Left front seat connector A
EF19	20A	Right front seat connector A
EF20	20A	Fuel pump relay
EF21	30A	Wiper relay/wiper speed control relay
EF22	7.5A	Brake switch/engine control unit

No.	Rated value	Feature/part
EF23	15A	Horn relay
EF24	15A	Automatic transmission control unit
EF25	—	—
EF26	15A	High beam relay
EF27	10A	PCV heater relay
EF28	Shorting link	Low beam relay
EF29	Shorting link	Main relay
EF30	10A	Electronic thermostat/relief valve/variable cam timing (exhaust end)/variable cam timing (intake end)/canister solenoid valve/CSV
EF31	20A	Ignition coil 1/ignition coil 2/ignition coil 3/ignition coil 4
EF32	15A	Engine control unit/fuel pump relay
EF33	10A	Starter relay 1/starter relay 2/A/C compressor relay/radiator fan relay/front oxygen sensor/rear oxygen sensor
EF34	10A	Left front combination lamp
EF35	10A	Right front combination lamp
EF36	7.5A	Engine control unit
EF37	10A	PCV heater relay
ER01	—	Wiper relay
ER02	—	Wiper speed control relay
ER03	—	Fuel pump relay
ER04	—	PCV heater relay
ER05	—	—

8. Accident Handling

No.	Rated value	Feature/part
ER06	—	Horn relay
ER07	—	Low beam relay
ER08	—	A/C compressor relay
ER09	—	High beam relay
ER10	—	Starter relay 2
ER11	—	Main relay
ER12	—	Radiator fan relay
ER13	—	—
ER14	—	Blower relay
ER15	—	—
ER16	—	Starter relay 1

8.6.3 Fuses in battery PDU

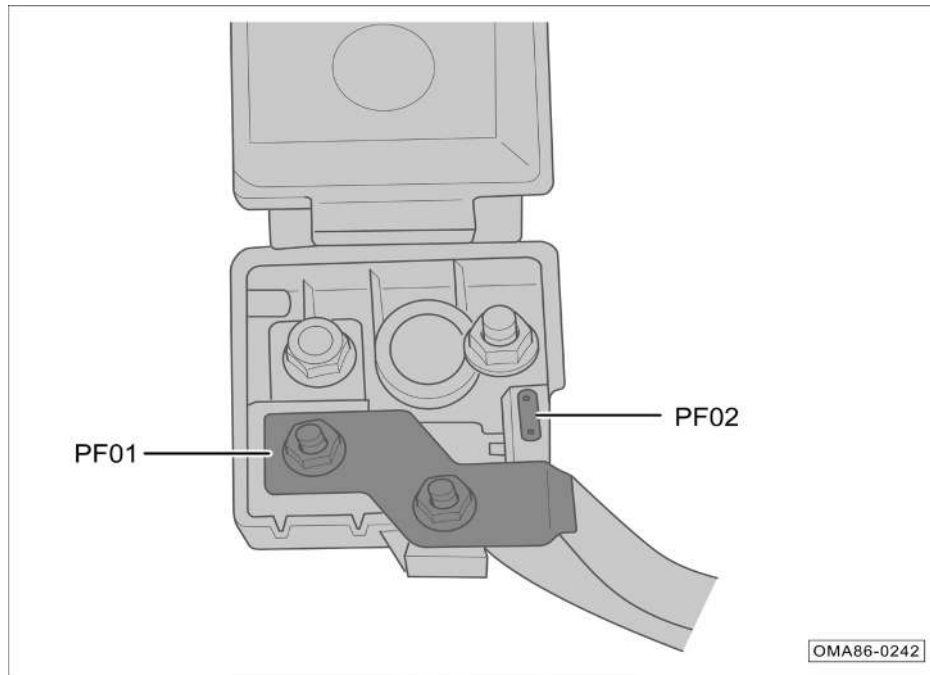

The picture is not guaranteed to be suitable for all car models. If it is required to know the purpose of the fuse, please check it on the actual car. For different car models, fuses may be slightly different.

No.	Rated value	Feature/part
PF01	300A	Starter/engine compartment PDU
PF02	7.5A	Battery sensor

8. Accident Handling

8.7 Emergency start

Jumper cable

If the engine can not start because the battery is too low, it can be started by connecting this battery to the battery of another car with jumper cables.

⚠ WARNING

- **The engine compartment is a high-risk area. Improper operation can easily cause casualties.**
- **Before starting work on the battery, be sure to carefully read and follow the warning instructions for safety related to battery operation.**

When connecting the batteries of two cars, be sure to first connect the positive terminal and then the negative terminal.

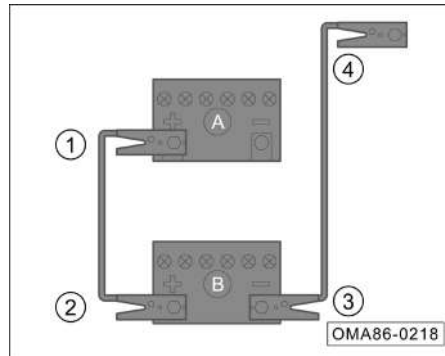

- Switch the engine start/stop button to the "OFF" position.
- Connect the ① end of the red cable to the positive pole (+) of the depleted battery "A", and the other end ② to the positive pole (+) of the power battery "B".

- Connect the ③ end of the black cable to the negative pole (-) of the power battery "B", and connect the other end ④ to the engine block, or a metal part firmly connected to the engine block, of the car with the depleted battery "A".

👁 NOTE

Properly place the jumper cable to avoid contact between the cable and the moving parts of the engine.

- Start the engine of the car with power battery and let it idle. Then, start the engine of the car with the depleted battery till the engine runs smoothly.

 **WARNING**

- **Be sure to turn off the headlamps before removing the jumper cables.**
- **Turn on the blower and rear windshield heater of the car with the depleted battery to reduce the voltage peak generated when the cable are being removed.**
- **Remove the jumper cables in the reverse order with the engine running.**

 **WARNING**

- Improper use of jumper cables may cause battery explosion and serious injury.**
- **The voltage of the power battery must be the same as that of the depleted battery, and the capacity of the two batteries shall also be the same. Otherwise, it may cause an explosion.**
 - **Never expose the battery to an open flame, for fear of an explosion.**
 - **Never connect the negative cable directly to the negative pole of a depleted battery. There shall be no static electricity near the battery. Otherwise, the combustible gas produced by the battery may be ignited by sparks, causing an explosion accident.**
 - **Never connect the negative cable to fuel system components or brake lines. Never lean over the battery during operation. Be careful not to get burned by acid.**

8. Accident Handling

8.8 Towing

If the car needs to be towed, it shall be towed by the GAC Motor authorized shop or a professional towing company.

It is recommended to use a rollback tow truck for towing. If the conditions can not be met, a wheel-lift truck can also be used for towing according to the situation.

Towing by a rollback tow truck

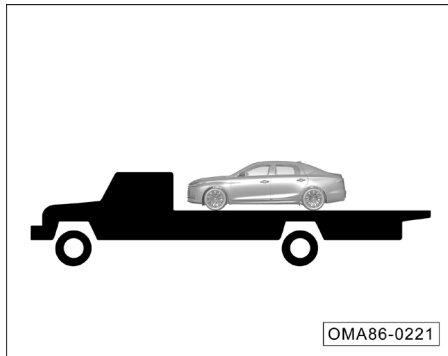

Towing by a wheel-lift truck from the front

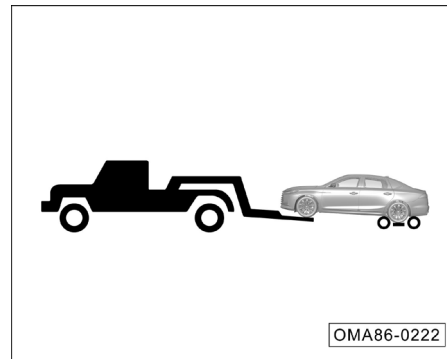

- Place a dolly under the rear wheels.

Towing by a wheel-lift truck from the rear

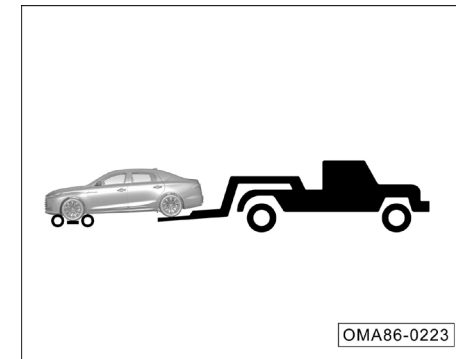

- Place a dolly under the front wheels.

Emergency towing

If it is impossible to find a tow truck in an emergency, fasten the towing cable or towing chain in the emergency towing ring to temporarily tow the car. However, this method is only suitable for low speed and short distance towing on a solid and flat road.

 **WARNING**

In emergency towing, drive slowly to avoid violent operation. Excessive towing force will damage the car.

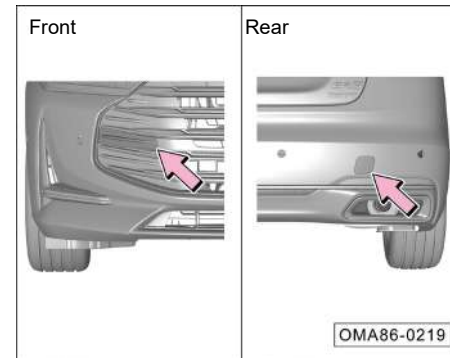
Install a towing hook

- Pry off the towing hook cover in the arrowed position using a slotted screwdriver wrapped with a cloth.

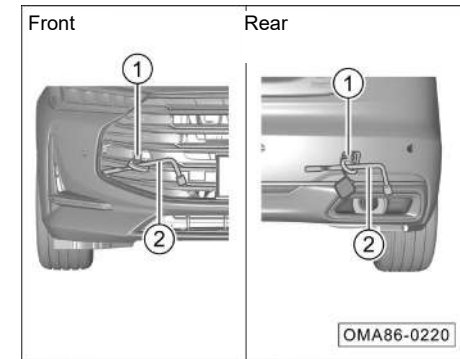

- Take out the towing hook ① and wheel bolt removal wrench ② from the tool kit in the trunk.
- Turn the towing hook ① clockwise into the thread hole.
- Insert the wheel bolt removal wrench ② into the round opening of the towing hook, and turn the wheel bolt removal wrench clockwise to make the towing hook firmly screw into the thread hole.

8. Accident Handling

Precautions for towing

Before emergency towing, be sure to follow the instructions below:

- Hazard warning lamps of both towing and towed vehicles must be turned on, and local traffic regulations must be complied with.
- The towing hook must be firmly tightened in the thread hole. Otherwise, the towing hook may slip out of the thread hole during towing.
- For the towed vehicle, the gearshift lever must be switched to the "N" gear.
- For the towed vehicle, it needs to switch the engine start/stop button to the "ON" gear and turn the steering wheel back and forth to confirm that the steering wheel can turn.

During the emergency towing, be sure to follow the instructions below:

- Start the engine and drive at a slow speed till the towing rope is tight and then perform acceleration slowly.
- Be sure to drive steadily, and do not accelerate, decelerate, or turn the car sharply.
- For towing, the towed vehicle shall be braked earlier than normal conditions, with the brake pedal lightly depressed.
- During towing, the towing rope must always be in a tight state.

8.9 Getting out of a trap

If the car is stuck on a soft road such as sandy, muddy or snowy road, follow the steps below to get out of the pit:

1. Observe the areas in front of and behind the car to ensure that there are no obstacles.
2. Turn the steering wheel left and right to grind areas around the front wheels to remove mud, snow or sand trapped around the tires.
3. Place wooden blocks, stones or other materials to help increase tire friction.
4. Start the engine and accelerate the car slowly to get the car out of the pit.
5. If the car still can not get out of the pit after a few attempts, it is required to have a tow truck for rescue.

i NOTE

In the acceleration process, human assistance can be provided to push the car from the front and rear for driving the car out of the pit.

9.1 Environmental protection information code

Number	Type	Environmental protection information code	Number
1	GAC7200L1A6	CNQQG6Z20B82000042	000001
2	GAC7200L2A6	CNQQG6Z20B82000043	000001
			000002

9. Environmental Protection Information

9.2 Environmental protection information

Environmental protection information	Type	
	GAC7200L1A6	GAC7200L2A6
Engine model/manufacturer	4B20J1/Guangzhou Qisheng Powertrain Co., Ltd.	
Catalytic converter model/manufacturer	Front: 1986092X/front: Sanshui branch company of Faurecia (Guangzhou) Automotive Systems Co., Ltd. Rear: 1986092X/rear: Sanshui branch company of Faurecia (Guangzhou) Automotive Systems Co., Ltd.	
Painting/carrier/packaging manufacturer	Painting: front: unit 1: Johnson Matthey (Shanghai) Chemical Co., Ltd./rear: unit 1: Johnson Matthey (Shanghai) Chemical Co., Ltd. Carrier: front: unit 1: NGK AUTOMOTIVE CERAMICS (Suzhou)/rear: unit 1: Corning (Shanghai) Co., Ltd. Packaging: front: Sanshui branch company of Faurecia (Guangzhou) Automotive Systems Co., Ltd./rear: Sanshui branch company of Faurecia (Guangzhou) Automotive Systems Co., Ltd.	
Particulate filter model/manufacturer	/	
Painting/carrier/packaging manufacturer	/	
Canister model/manufacturer	2140003CAD00/Langfang Huaan Automotive Equipment Co., Ltd.	
Oxygen sensor model/manufacturer	Front: OSL; rear: RE94/Beijing Delphi Wanyuan Engine Management System Co., Ltd.	
Crankcase emission control device model/manufacturer	10090082040000/Shentong Technology Group Co., Ltd.	
EGR model/manufacturer	/	
OBD system supplier	Delphi (Shanghai) Dynamics and Propulsion Systems Co., Ltd.	
ECU model/manufacturer	MT92.1/Delphi (Shanghai) Dynamics and Propulsion Systems Co., Ltd.	
Transmission type/gear number	Automatic/6	
Muffler model/manufacturer	Front: 2617577X; left rear: 2617652X; right rear: 2617658X/Sanshui branch company of Faurecia (Guangzhou) Automotive Systems Co., Ltd.	
Turbocharger model/manufacturer	RHS4/Wuxi IHI Turbo Co., Ltd.	
Intercooler type	Air-to-air	

This manual describes related information of GAC Motor entire series, including their configuration, functions, performance parameters and product schematic diagrams. Its content is valid when allowed to be printed. However, the actual configuration and function of the cars are subject to the specific car delivered. If there is any difference between the schematic diagrams and the specific car delivered, the actual product shall prevail.

GAC Motor Co., Ltd. reserves the right to alter, supplement or terminate the contents and technical specifications in this manual without prior notice.

GAC Motor Co., Ltd. owns the copyright to this manual. Without the written consent of GAC Motor Co., Ltd., it is not allowed to photocopy or extract the contents of this manual.

GAC Motor Co., Ltd.

For operation guidelines of GA8 model, please refer to:
<http://www.gac-motor.com>