

Thank you for choosing the vehicle from Guangzhou Automobile Group Motor Co., Ltd. (GAC Motor for short). To better enjoy the driving pleasure provided by your vehicle, please carefully read this *User's Manual*. This Manual will allow you to fully understand its operations and important notes. The proper use of the vehicle will improve driving safety and increase service life.

The on-board *Warranty Manual* describes the warranty services provided by GAC MOTOR which you can enjoy, as well as regular maintenance of your vehicle. Read this Manual thoroughly so you can understand your rights and responsibilities.

After reading this Manual, please keep it in the vehicle for easy reference.

Your dealer is dedicated to your satisfaction and will be pleased to answer any questions and concerns.

If you have any advice or comments, welcome to call GAC MOTOR customer service hotline: +86-400-158-9999.

Thank you for your support and great kindness to GAC MOTOR. Wish you a happy driving!

GAC MOTOR



Safety Instructions

Your safety, and the safety of passengers, is very important. Therefore, operating this vehicle safely is an important responsibility.

To help you be familiar with relevant safety notes, we have provided operating steps and instructions on signboards of the vehicle and in this Manual, to alert you to warn potential hazards that could hurt you or passengers.

It is not practical or possible to list all the hazards associated with operating or maintaining your vehicle. Therefore, you must use your own good judgment.

You will find these important safety instructions in a variety of forms, including:

- Safety Signboards — Attached to the car.
- Safety Information — Words preceded by a symbol of ,  and  as well as one of the three signal words: "Warning", "Caution" or "Hint".

 **Warning** Instruction for important or possible personal injury.

 **Caution** Instruction for important or possible vehicle damage.

 **Hint** Instruction for potential risks that will not cause injury or damage.

- Some paragraphs in this Manual are inapplicable to all the models, and corresponding caption texts are labeled with "*" for reference.
- Unless otherwise specially stated, vehicle directions (front, rear, left, right) herein are based on the vehicle's driving direction.
- The series models are provided with Engine Start/Stop switch and traditional ignition switch which are collectively called ignition switches unless otherwise described.

1. Important Safety Precautions	1	4.2.6 Engine Hood.....	62
2. Pictorial References	3	4.2.7 Electric Windows	64
2.1 Exterior	3	4.2.8 Electric Sunroof	66
2.2 Interior	6	4.2.9 Basic Operations of Anti-Theft on Vehicle Body	71
3. Safety Operating Instructions	9	4.3 Lights and Visual Field	72
3.1 Safe Driving	9	4.3.1 Exterior Lights	72
3.1.1 General Instructions	9	4.3.2 Interior Lights.....	79
3.1.2 Correct Sitting Position of Occupants	10	4.3.3 Wiper Combination Switch	82
3.2 Seat Belts	11	4.3.4 Windshields	86
3.2.1 Why Wear Seat Belts	11	4.3.5 Rear-View Mirror	87
3.2.2 Seat Belt.....	13	4.3.6 Sun Visor.....	90
3.3 SRS System	18	4.4 Seats and Storage Devices	91
3.3.1 Cases When Airbags Could Deploy.....	23	4.4.1 Headrest.....	91
3.3.2 Cases When Airbags Could Not Deploy	24	4.4.2 Front Seats	92
3.4 Safety Rules for Children.....	26	4.4.3 The Second/Third Row Seats	94
3.4.1 General Instructions	26	4.4.4 Storage Devices	96
3.4.2 Child Safety Seat.....	27	4.4.5 Power Outlet.....	102
3.4.3 Information about Child Safety Seat	28	4.4.6 Mobile Phone Wireless Charging System*	104
3.4.4 Install a Child Seat Properly.....	30	4.4.7 Trunk	107
3.5 Dangerous Exhaust Gases	34	4.4.8 Accessories and Modifications	109
3.6 Safety Labels.....	35	4.5 A/C System.....	111
4. Operating System and Equipment	36	4.5.1 General Instructions	111
4.1 Cab	36	4.5.2 Auto A/C System*.....	112
4.1.1 Steering Wheel.....	36	4.5.3 Manual A/C System*	119
4.1.2 Instrument Cluster	38	4.5.4 Air Outlets.....	124
4.1.3 Indicator Light.....	44	4.6 AUDIO System	126
4.2 Vehicle Opening and Closing	47	4.6.1 Control Buttons on the Steering Wheel.....	126
4.2.1 Smart Key.....	47	4.6.2 Basic Operations	128
4.2.2 Mechanical Key	52	4.6.3 Radio	131
4.2.3 Locking System	53	4.6.4 USB Play	133
4.2.4 Door.....	59	4.6.5 Bluetooth	134
4.2.5 Hatchback Door.....	60	4.6.6 System Setting	136

Contents

4.6.7	Vehicle Setting	138	6.	Usage and Maintenance	184
5.	Driving Directions	140	6.1.	Maintenance Instructions	184
5.1	Starting and Driving	140	6.2	Interior Maintenance	185
5.1.1	Ignition Switch	140	6.3	Exterior Maintenance.....	187
5.1.2	Engine Start.....	142	6.4	Checking and Adding Fluids.....	192
5.1.3	Engine Stop.....	144	6.4.1	Fuel Oil	192
5.1.4	Gear Instructions	146	6.4.2	Engine Oil.....	194
5.2	Brake System	150	6.4.3	Coolant	197
5.2.1	Service Brake	150	6.4.4	Windshield Washing Liquid and Wiper Blade	200
5.2.2	Electronic Parking Brake (EPB) System	153	6.4.5	Brake Fluid	202
5.3	Service Electronic Brake System	158	6.4.6	Battery	205
5.3.1	Anti-Lock Braking System (ABS)	158	6.5	A/C Filter.....	207
5.3.2	Electronic Stability Program (ESP)	160	6.6	Replacing Bulbs.....	210
5.3.3	Hill Hold Control (HHC)	162	6.7	Wheels	214
5.3.4	Hill Descent Control (HDC)	163	6.8	Tire Chain	220
5.4	Driver Assistance System.....	164	7	Technical Data.....	221
5.4.1	Cruise Control System *	164	7.1	Vehicle Identification Numbers	221
5.4.2	Tire Pressure Monitoring System (TPMS) *	166	7.2	Vehicle Parameters	223
5.5	Reversing Assist System.....	167	7.3	Vehicle Parameters	224
5.5.1	Parking Sensor System.....	167	7.4	Vehicle Parameters	228
5.5.2	Reversing Rear-view System *	170	8.	Handling of Accident.....	231
5.5.3	Panorama Parking System *	172	8.1	Vehicle Tools and Spare Tire	231
5.6	Electric Power Steering (EPS) System	176	8.2	Usage of Warning Triangle.....	233
5.7	Driving Skills	177	8.3	Replacing the Flat Tire	234
5.7.1	Safety Check for Driving	177	8.4	Fuse.....	237
5.7.2	Driving during Running-in Period	178	8.4.1	Fuses in the Instrument Panel Fuse Box	239
5.7.3	Important Tips for Driving	180	8.4.2	Fuse in Engine Compartment Fuse Box	242
5.7.4	High-efficiency Use of Vehicle	182	8.5	Emergency Start.....	245
5.7.5	Fire Prevention	183	8.6	Emergency Towing.....	247
			9.	Environmental Protection Information	251

9.1 Environmental Protection Information No.....251
9.2 Environmental Protection Information252

1. Important Safety Precautions

◆ **Be sure to wear the seat belt correctly**

In collision accidents, seat belts are protective devices that perform best. Air bags are designed to enhance safety provided by seat belts rather than take the place of seat belts. Thus even if the car is equipped with air bags, make sure that you and other occupants always correctly wear seat belts.

◆ **Never leave children in unattended cars**

Never leave children in unattended cars. Children may trigger one or more vehicle control devices, resulting in injury or death. Children may also cause the car to move and collide due to misoperation, resulting in injury or death. Depending on the ambient temperature, extreme temperature may be reached in the car, resulting in injury or death.

◆ **Protect all children**

Children 12 years old and under must never ride in the second seat. For infants and babies, child safety seats shall be used. For older children, both child safety seats and three-point seat belts shall be used.

◆ **Note that air bag may cause danger**

Air bags can save lives. However, deployment of air bags could result in serious or fatal injury to the occupant too close to them or improperly restrained.

Air bags present greatest threats to infants, babies and short adults. Therefore, be sure to observe all instructions and warnings contained in this manual.

◆ **Never drive after drinking alcohol**

Even drinking a little alcohol can suppress capability of dealing with changing situations, besides, it takes longer time for doing so. Never drive after drinking alcohol.

◆ **Observe road traffic safety regulations and be polite while driving**

◆ **Pay due attention to driving safety**

Answering the phone or doing other things while driving could cause you to pay no attention to road conditions, other vehicles and pedestrians. This could result in accidents. Keep in mind that avoid distraction while driving.

◆ **Control the vehicle speed**

Vehicle speed being too fast is one of the main causes for traffic accidents. The faster the vehicle speed is, the greater the risk will be. Therefore, please choose appropriate vehicle speed to drive safely according to the actual road conditions.

◆ **Periodic maintenance**

Tire burst or mechanical fault can be very dangerous. To reduce possibility of these problems, check tire pressures and conditions from time to time, and have the vehicle serviced periodically according to the *Warranty Manual*.

1. Important Safety Precautions

Accident data recorder

Equipped with relevant equipment of accident data recorder, the car can record the real-time data of certain collision (such as airbag deployment or collision with obstacles) to help better understand the collision and injury.

Such data shall be owned by the car owner. If necessary, GAC Motor Automobile Sales Co., Ltd. or its authorized representative shall have the right to obtain data of the accident data recorder, but only for technical diagnosis, research and development of vehicle.

Service diagnosis recorder

Equipped with relevant equipment of service diagnosis recorder, the car can record the power system performance and the driving condition. Such data can assist technicians in diagnosis, repair and maintenance of the car.

Such data shall be owned by the car owner. If necessary, GAC Motor Automobile Sales Co., Ltd. or its authorized representative shall have the right to obtain data of the service diagnosis recorder, but only for technical diagnosis, research and development of vehicle.

2.1 Exterior

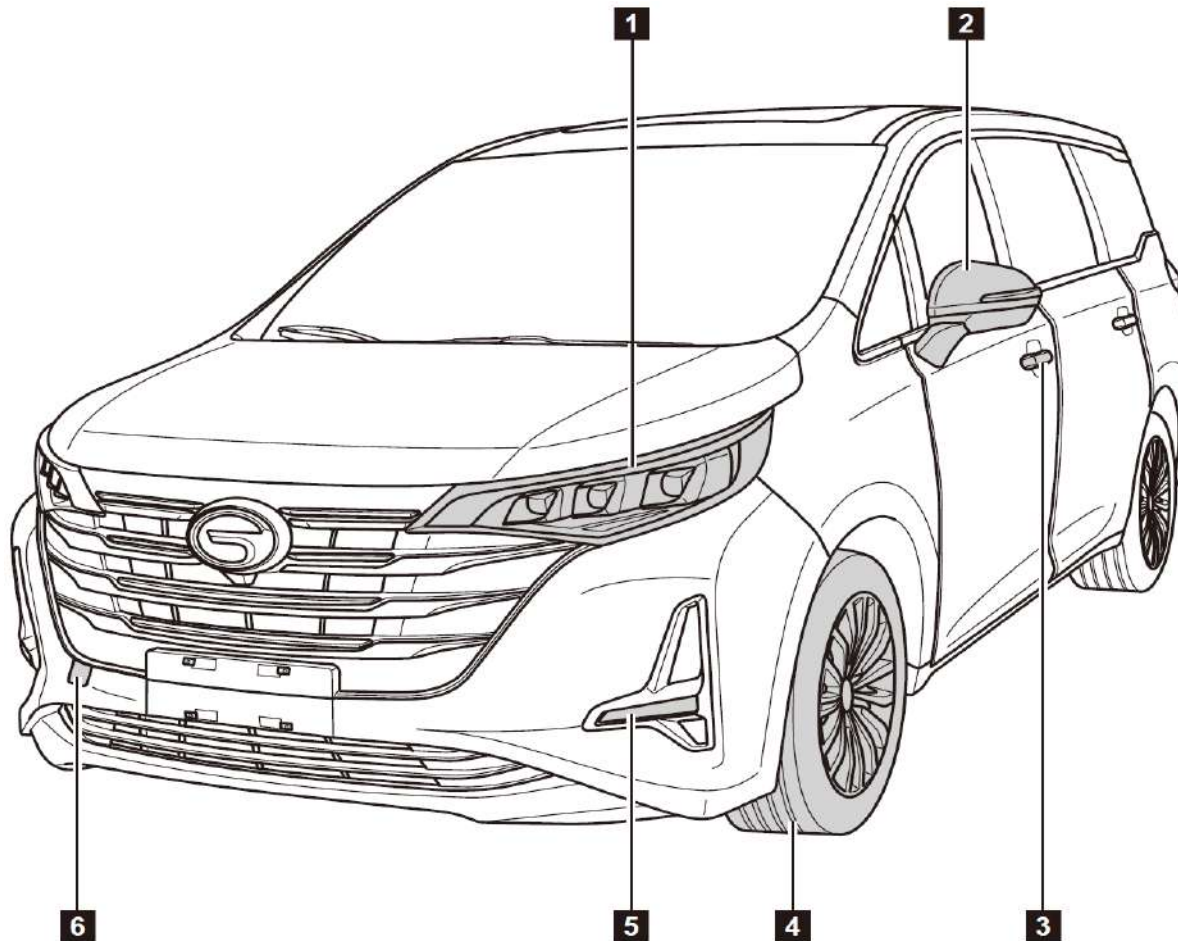

1. Front combination light
 - Turn on the light =>Refer to Page 72
 - Replace the bulb =>Refer to Page 210
 - Front combination light bulb specifications =>Refer to Page 230
2. Exterior rear-view mirror =>Refer to Page 88
 - Side turn signal light=>Refer to Page 72
 - Side turn signal light specifications =>Refer to Page 230
3. Keyless entry =>Refer to Page 57
 - Door lock hole =>Refer to Page 54
4. Wheels =>Refer to Page 214
5. Front fog light * =>Refer to Page 77
 - Front fog light specifications * =>Refer to Page 230
6. Front towing =>Refer to Page 248

2. Pictorial References

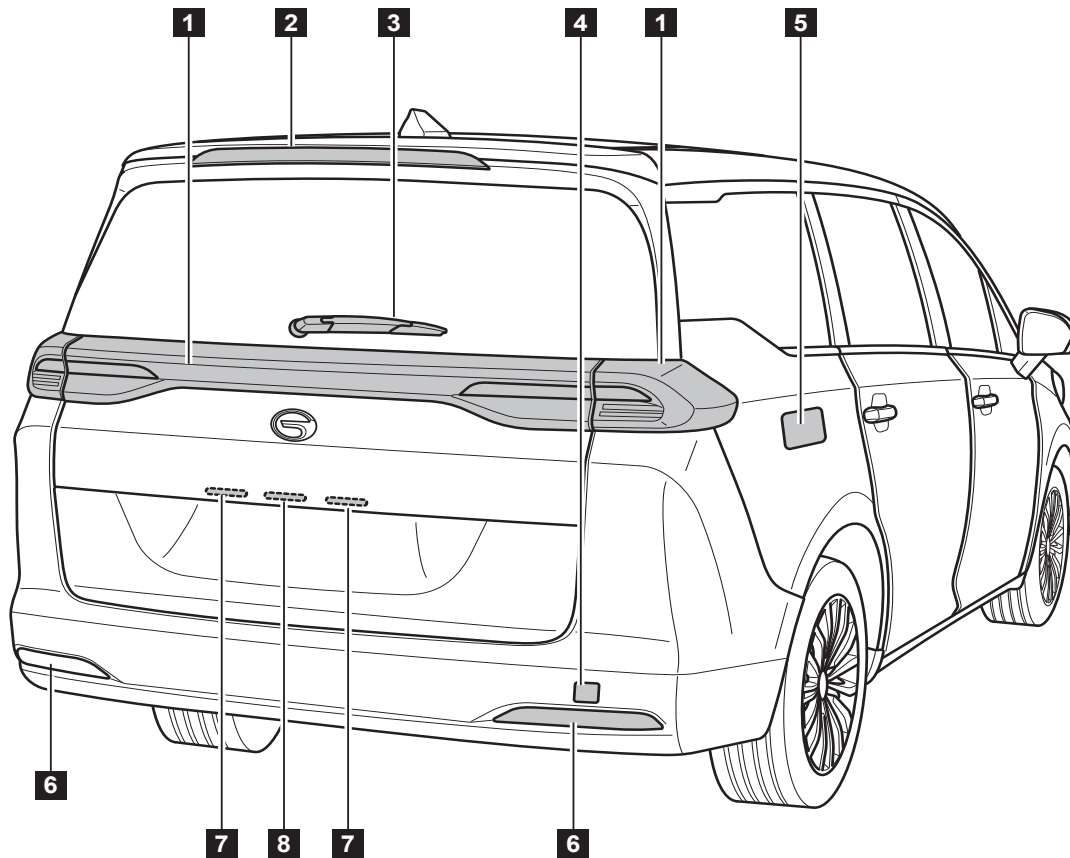

1. Rear combination light
 - Rear combination light specifications =>Refer to Page 230
2. High brake light
 - High brake light specifications =>Refer to Page 230
3. Rear windshield wiper blade=>Refer to Page 201
4. Rear towing =>Refer to Page 247
5. Fuel tank lid =>Refer to Page 192
6. Rear fog light =>Refer to Page 77
 - Rear fog light specifications =>Refer to Page 230
7. Number plate light
 - Number plate light specifications =>Refer to Page 230
8. Hatchback door release button (Refer to Page 60)

2. Pictorial References

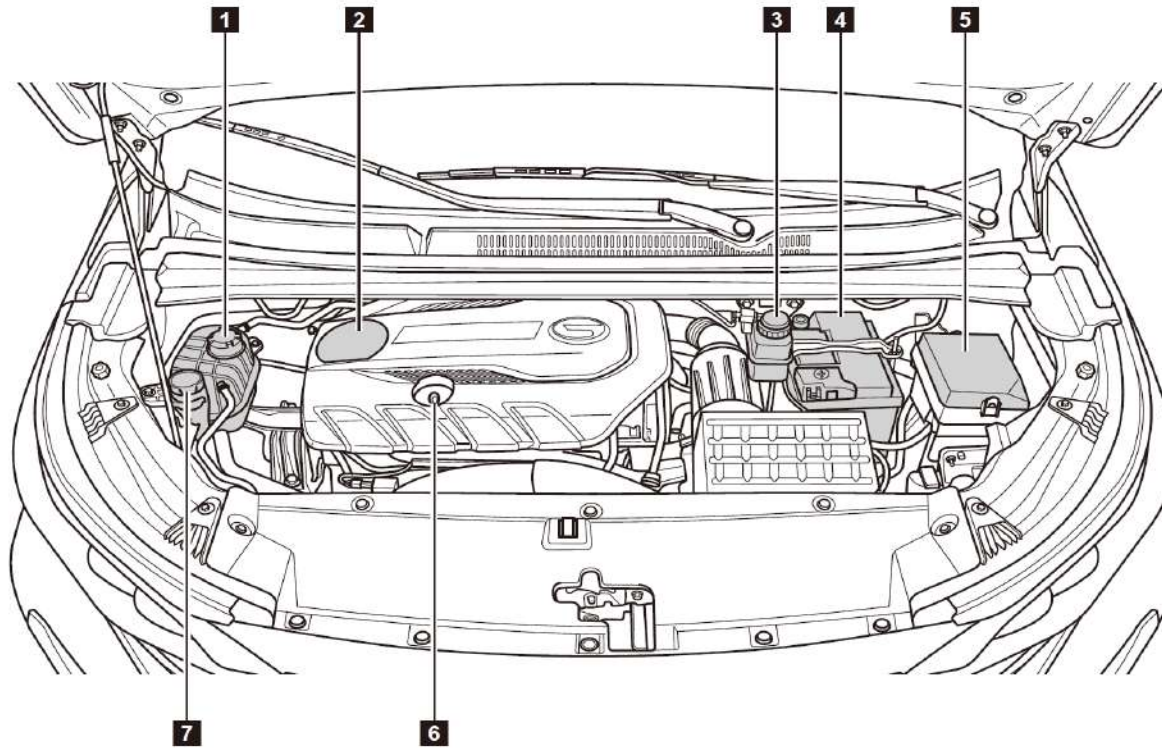

FER

1. Coolant expansion tank =>Refer to Page 198
2. Engine oil filler cap =>Refer to Page 196
3. Brake fluid tank =>Refer to Page 202
4. Battery =>Refer to Page 205
5. Front engine compartment fuse box =>Refer to Page 238
6. Engine oil dipstick =>Refer to Page 195
7. Windshield washing liquid storage tank =>Refer to Page 200

2. Pictorial References

2.2 Interior

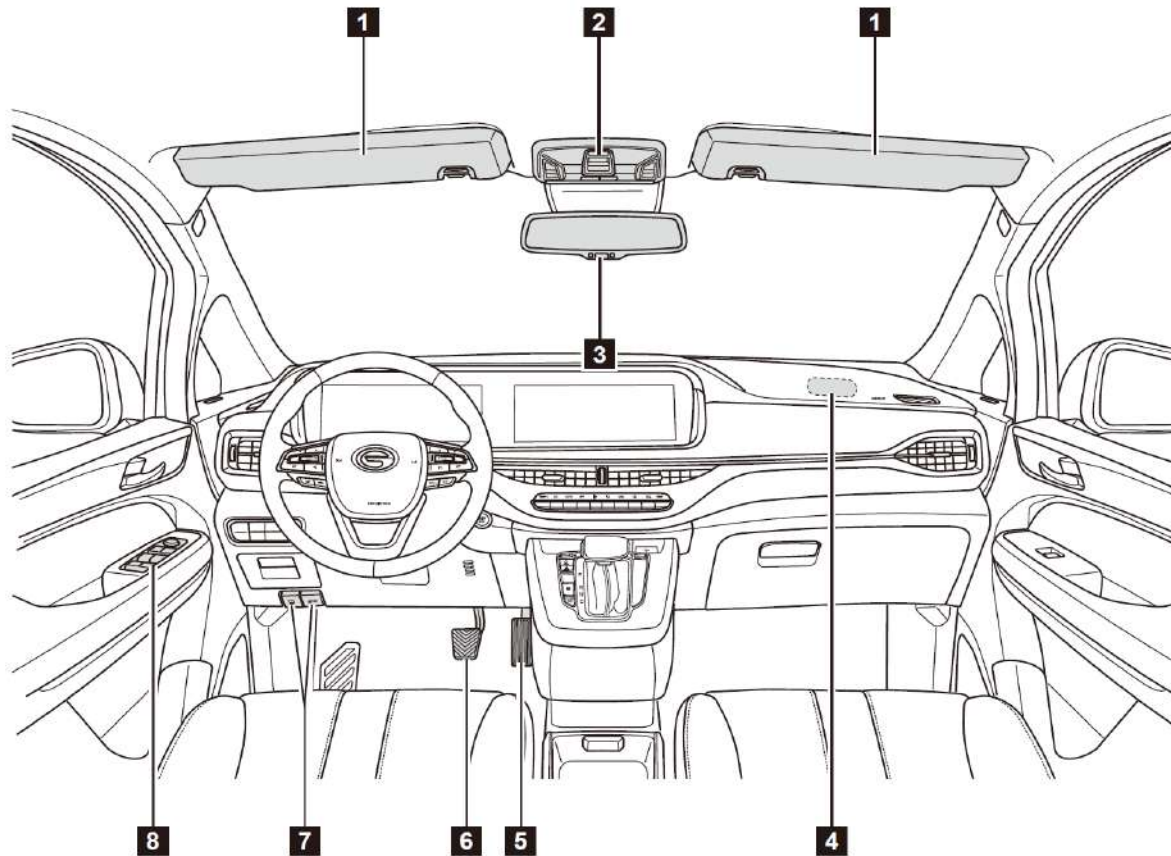

1. Sun visor => Refer to Page 90
2. Front roof lights =>Refer to Page 79
 - Electric sunroof keypad *=> Refer to Page 66
 - Electric sunshade keypad* => Refer to Page 67
 - Glasses case => Refer to Page 98
3. Interior rear-view mirror =>Refer to Page 87
4. Front passenger front airbag => Refer to Page 20
5. Accelerator pedal
6. Brake pedal
7. FER hood open handle => Refer to Page 62
 - Fuel tank lid open handle=> Refer to Page 192
8. Electric window button on the driver's side => Refer to Page 64
 - Central locking button =>Refer to Page 53
 - Exterior rear-view mirror adjustment button => Refer to Page 88

2. Pictorial References

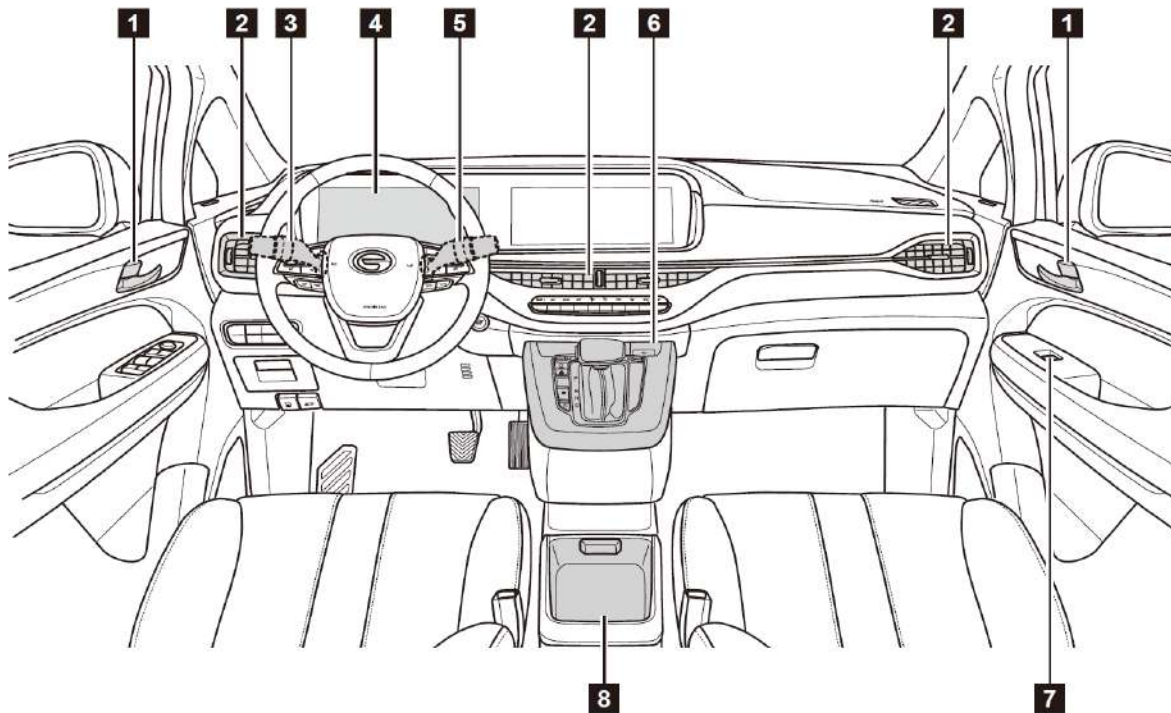

1. Door lock latch and inner handle =>Refer to Page 53
2. Air outlets =>Refer to Page 124
3. Light combination switch =>Refer to Page 72
4. Instrument cluster => Refer to Page 38
 - Indicator light =>Refer to Page 44
5. Wiper combination switch =>Refer to Page 82
6. Central console panel:
 - AUDIO system USB interface =>Refer to Page 101
 - Seat heating button* =>Refer to Page 93
 - Hazard warning indicator light button =>Refer to Page 78
 - Driving mode button*=> Refer to Page 147
 - EPB system button=> Refer to Page 153
 - Gearshift => Refer to Page 146
7. Passenger side electric window button =>Refer to Page 65
8. Mobile phone wireless charging area * =>Refer to Page 104
 - USB power outlet =>Refer to Page 102

2. Pictorial References

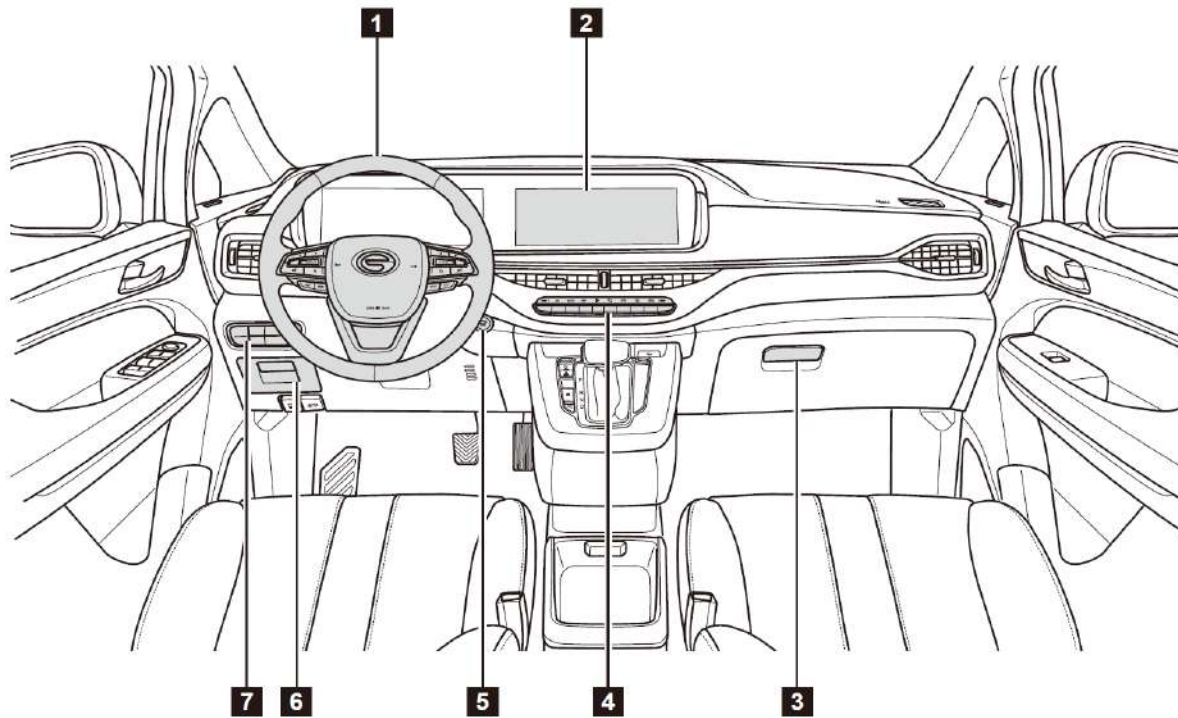

1. Steering wheel => Refer to Page 36
 - Steering wheel button =>Refer to Page 37
 - Driver front airbag =>Refer to Page 19
2. Audio system =>Refer to Page 126
3. Handle of glove box =>Refer to Page 98
4. Control panel of A/C system =>Refer to Page 111
5. Engine Start/Stop switch *=>Refer to Page 140
6. Storage shelf for lower panel in the cab =>Refer to Page 96
 - Instrument panel fuse box => Refer to Page 238
7. Switch Group of Left Side of Instrument Panel:
 - Headlight height manual adjustment knob=> Refer to Page 76
 - Downhill assist control system button =>Refer to Page 163
 - Panorama parking system keypad*=> Refer to Page 172
 - ESP OFF button =>Refer to Page 160

3.1 Safe Driving

3.1.1 General Instructions

This Section describes important information, operating essentials, recommendations and safety precautions for driving safety. For your safety and the safety of your passengers, please read it carefully and observe the relevant regulations.

Hint

Please Keep the *User's Manual* always in your car. Please make sure the Manual stays with the vehicle if you lend or sell it to the next owner. It is an integral part of the vehicle.

You should do the following inspections before driving your vehicle:

- Make sure that all car lights are under normal working condition.
- Ensure sufficient fuel level.
- Ensure sufficient coolant level.
- Ensure sufficient brake fluid level.
- Ensure sufficient windshield washer fluid level.
- Make sure that tire pressure is under normal condition.
- Make sure all windows are clean and unobstructed.
- Make sure that no items obstruct the pedal movement in the footwell.
- Adjust the seats, headrest and rear view mirrors according to height and body type.
- Make sure the child is protected with suitable child seat and properly wear the seat belt.
- Wear your seat belt correctly. Check that your passengers have fastened their seat belts correctly.
- Confirm whether the surrounding environment is safe.

Warning

Please observe the following precautions when installing the driver's foot mat:

- Never use two or more foot mats simultaneously.
- Never bottom up the foot mat or place it back to front.

Caution

- Do not let yourself be distracted from driving because of external factors.
- Do not drive your vehicle when your reaction capacity weakens. Medicines, alcohol, drugs and others will impair your reaction capacity.
- Follow the traffic laws strictly.

3. Safety Operating Instructions

3.1.2 Correct Sitting Position of Occupants

Correct Sitting Position of the Driver

Correct driving position has a direct influence on driving safety and fatigue. The driver shall perform as follows before driving:

- Sit up straight and adjust the seat backrest to proper position, so that your back can fully contact with the seat backrest.
- Adjust the driver's seat, so that you can effectively operate all pedals with legs bent slightly.
- Adjust the headrest properly. => Refer to Page 91
- Wear the seat belt correctly. => Refer to Page 15
- Steering wheel position adjustment. => Refer to Page 36

Warning

During driving, the driver must not adjust the seat, headrest or steering wheel, otherwise the car may be out of control and accidents may occur.

Correct Sitting Position of Passengers

To ensure the safety of passengers and reduce the risk of accidental injury and death, passengers should do the following operations:

- Sit upright, and adjust the headrest properly. => Refer to Page 91
- The front passenger shall adjust the distance between the seat and the instrument panel according to own needs.
- The front passenger should adjust the seat backrest to proper position, so that your back can fully contact with the seat backrest.
- Wear the seat belt correctly. => Refer to Page 15
- Put the feet on the floor.
- Whenever an infant or child rides in your car, be sure to use suitable child safety seat to protect the infant or child in accordance with the provisions. => Refer to Page 27

Warning

- If the front passenger sits too close to the instrument panel, he/ she cannot get effective protection from airbags.
- While driving, keep correct sitting position and wear the seat belt correctly to avoid injury caused by emergency braking or a crash.

3. Safety Operating Instructions

3.2 Seat Belts

3.2.1 Why Wear Seat Belts

Protection from Seat Belts



In case of crash, correctly wearing seat belts can restrict the driver and passengers at proper positions, reducing inertia of forward motion, to prevent loss of control of motion and being ejected out of the vehicle, allow the driver and passengers to get effective protection from the airbags, and minimize injury due to impact.

The seat belts can assist other safety systems and absorb most of the kinetic energy resulting from a collision to reduce the risk of injury further.

Warning

Airbags cannot replace your seat belts. Whether the airbag is equipped or not, make sure you and your passengers always wear seat belts properly.

Consequences Arising from not Wearing Seat Belts

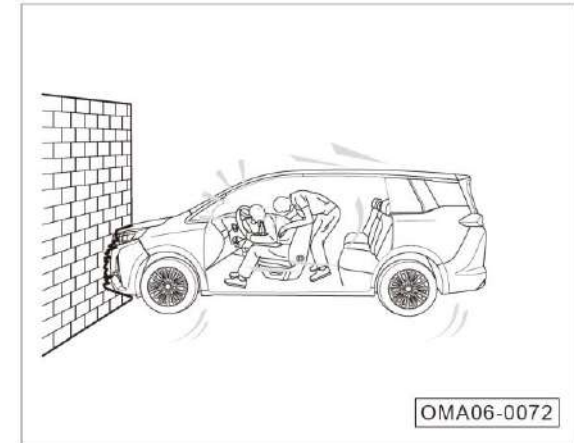

In the event of a crash, the unrestrained passengers will be thrown forward and injured due to inertia.

3. Safety Operating Instructions



Even if the car is at low speed, the force exerted on human body, when a collision occurs, is big, and driver and passengers cannot control his own body by hands. The unrestrained driver and passengers will be thrown forward and injured once colliding with other objects in the car.



The second/third seat passengers must wear the seat belts properly as well. Otherwise, the passengers can be thrown forward during a crash. The passengers not wearing the seat belts can be injured and endanger other occupants.

3.2.2 Seat Belt

Seat Belt Indicator Light

 : Driver seat belt indicator light

 : Front passenger seat belt indicator light

When the ignition switch is at the "ON" position, there are the following alarm messages:

- When the vehicle speed is less than 20km/h, if the driver or front passenger does not fasten his/her seat belt, the corresponding indicator light on the instrument cluster will flash about 6s and then stay on, accompanied with alarm message.
- When the vehicle speed is greater than or equal to 20km/h, if the driver or front passenger does not fasten his/her seat belt, the corresponding indicator light on the instrument cluster will flash about 20s and then stay on, accompanied with alarm message also sounds continuously.

Caution

- Before starting driving, check whether there are any heavy on the seat to prevent the system from mistaking that there is occupant on it and giving a false alarm.
- If the above alarm messages appear when the seat belts are fastened correctly, the seat belt device may fail. Please go to an authorized GAC MOTOR special store timely to have your car checked and repaired.

 : Rear seat belt indicator light*

If the rear seat belt indicator light turns white, it indicates that the seat belts are fastened; while if it turns red, it indicates that the seat belts are not fastened or the safety belt system fails. If the indicator light still stays red when the seat belts are fastened correctly, the seat belt device may fail. Please go to an authorized GAC MOTOR special store timely to have your car checked and repaired.

The rear seat belt indicator light goes off after 35s, and goes on again in the following cases:

- When the engine starts, the rear passengers do not wear the seat belts.
- When the rear doors are opened/closed, the rear passengers do not wear the seat belts.
- The rear passengers wear or unbuckle the seat belts.

3. Safety Operating Instructions

Seat Belt Pretensioner Equipment



The seat belt pretensioner equipment can reduce the pressure exerted by the seat belt on the chest and improve the protection performance.

- The seat belt restrains the driver and passengers to keep correct sitting position, preventing the body over tilting forward before collision.
- The seat belt pretensioner equipment will be activated in the event of a severe collision, and then drive the seat belt webbing to tighten by immediate pulling back.

- In the event of collision, the driver's body will move forward then the seat belt pretensioners activate, to make the restraining force to the body at a certain range, preventing a further injury towards the driver; at the same time, the seat belt pretensioners activate in conjunction with the airbag to provide an optimal protection.

i Hint

- When being initiated, the seat belt pretensioner equipment releases little harmless smoke and generates sound, which is normal.
- Initiated pretensioner cannot be reused, and indicator light of  the supplemental restraint system (SRS) will stay on. Please contact an authorized GAC MOTOR special store for replacement.

Adjust Seat Belt Height

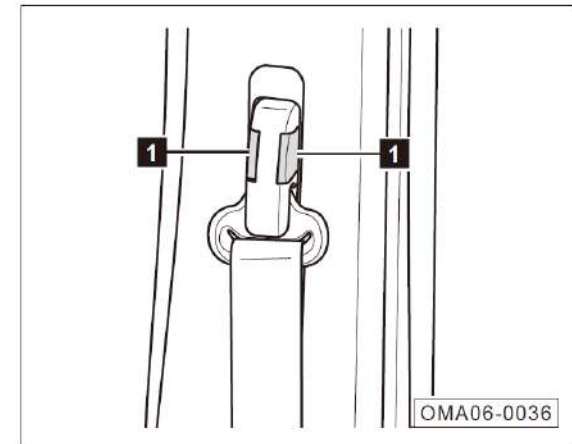

- Upward adjustment: Hold the guide part and move it up and down to adjust the seat belt to the desired height.
- Downward adjustment: Press the unlocking switch ① of the guide and move it downward to adjust the shoulder belt to the desired height.
- After the completion of adjustment, check whether the guide part is securely locked.

3. Safety Operating Instructions

Wear Front Seat Belts

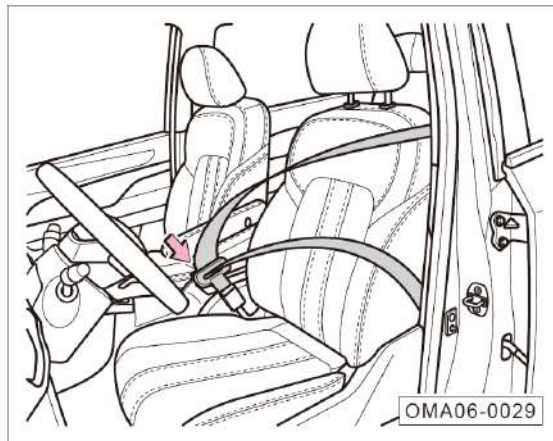

- Keep correct sitting position. => Refer to Page 10
- Gradually draw the seat belt out at constant speed, and insert the latch plate into the corresponding buckle until you hear a click.
- Pull the lock tongue to ensure that it is properly locked.

i Hint

The methods for wearing the seat belts at the second rows and the third rows both sides in the same way. The driver has the responsibility to remind other occupants to wear seat belts correctly.

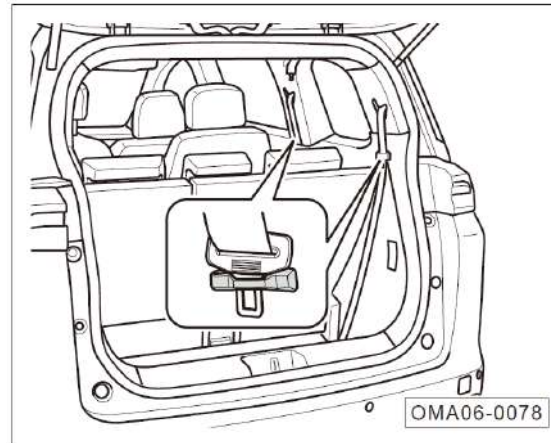

When wearing the seat belts on both sides of the second and third rows, pull out the seat belt latch plate from the trim panel clip, and then move out the seat belt webbing, and pull the seat belt for wearing to avoid of damage to clip due to pulling of seat belt.

Wear the Third Row Middle Seat Belt *

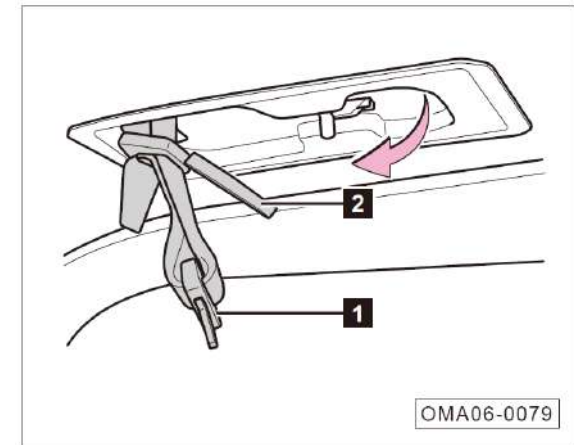

1. Draw out the latch plates ① and ② from the hold-down groove of the roof.

3. Safety Operating Instructions

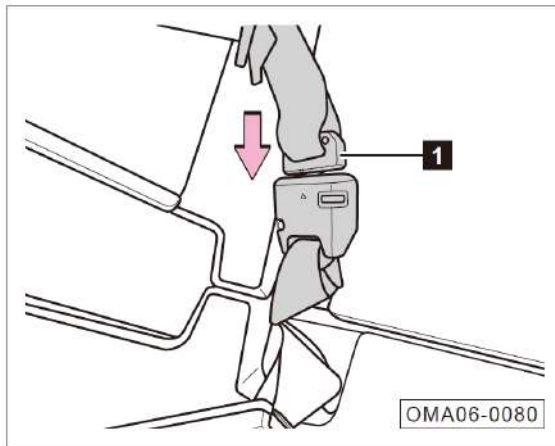

2. Align the latch plate ① with the triangular sign on the buckle, and insert the latch plate ① into the buckle until you hear a click.

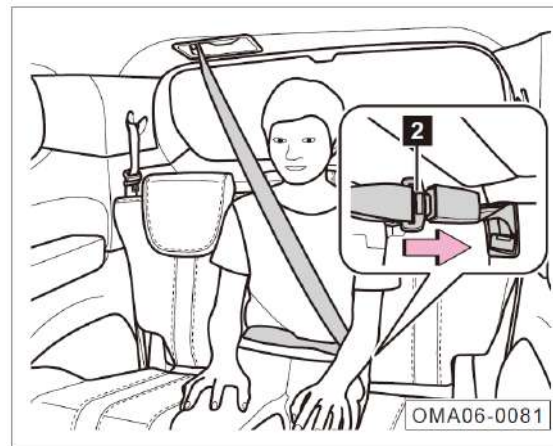

3. Insert the latch plate ② into the buckle until you hear a click.
4. Pull the lock tongue to ensure that it is properly locked.

Unbuckle the Seat Belt

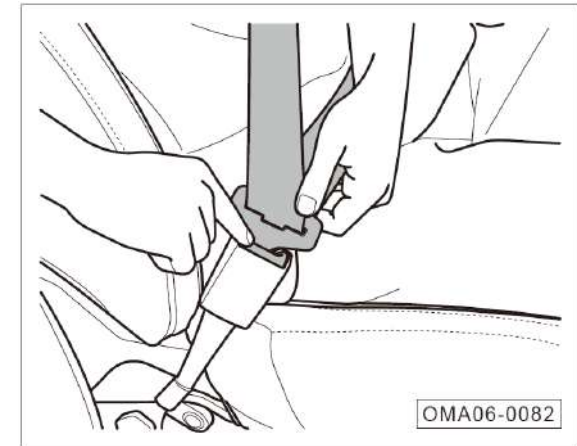

- When the red PRESS button of the buckle is pushed, the latch plate pops up automatically.
- Grasp the belt so that it retracts gradually.

3. Safety Operating Instructions

Unbuckle the Third Row Middle Seat Belt *

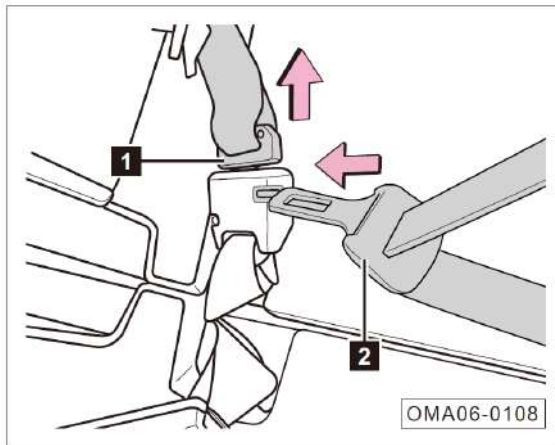

- Press the red button of the buckle, take out the latch plate ②, insert the latch plate ② into the slot on the side of the buckle, and take out the latch plate ①.
- Grasp the seat belt so that it retracts gradually. Fix the latch plates ① and ② in the hold-down groove of the roof.

A Pregnant Woman Must Wear Seat Belt Correctly



Pregnant women must wear the seat belts properly as follows.

- Adjust the seat and its headrest to the desired position.
- Hold the latch plate and pull the shoulder part of the belt to go across your shoulder slowly, and position the waist part of the belt as low as possible across your hips, not across your abdomen.
- Insert the latch plate into the corresponding buckle until you hear a click.
- Pull up the shoulder part of the belt parallel to your upper body, and tug on the hip part of the belt to make sure that the latch plate is locked securely.

⚠ Warning

To reduce injury risk of the occupants in case of emergency braking or accident, please observe the following precautions:

- Be sure you and your passengers wear seat belts properly before driving.
- Never share the seat belt. Two people (including children) should never use the same seat belt.
- Never excessively incline the front seat backrest for comfort.
- Never put the shoulder part of the seat belt below or behind the arm.
- Be sure to insert the latch plate into its own buckle. Never insert it into other buckles.
- Do not unfasten the seat belt until the vehicle is completely stationary.

3. Safety Operating Instructions

3.3 SRS System

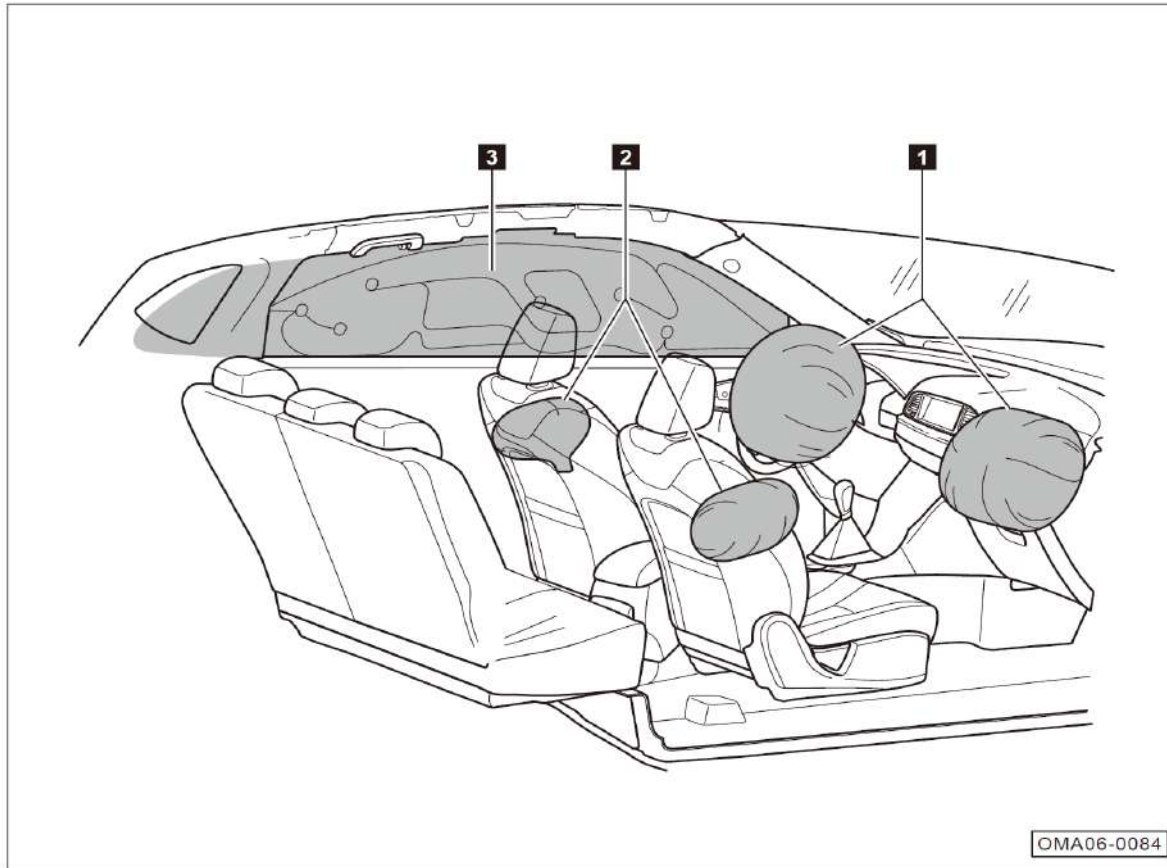

Depending on the configuration, the SRS system consists of the following airbags:

1. Front seat frontal airbag
2. Front seat side airbag*
3. Side curtain airbag*

i Hint

When the airbags inflate, you may see what looks like smoke. This is a normal phenomenon.

3. Safety Operating Instructions

Supplemental restraint system (SRS) indicator light

Switch the Start or Ignition switch to the "ON" position, the indicator light illuminates for a few seconds then extinguishes after self-checking.

The indicator light indicates a fault developing in the system in one of the following conditions:

1. After the Start switch is switched to "ON" position, the indicator light does not illuminate.
2. After the ignition switch is switched to the "ON" position, the indicator light does not go off after self-check of the system.
3. After the ignition switch is switched to "ON" position, the indicator light self-check illuminates again after turning off.
4. When the vehicle is running, the indicator light will be illuminated or flash.

Warning

- Do not repair, adjust or modify any airbags by yourself without authorization.
- An airbag inflates only once. If the airbag ever inflates during a crash, it must be replaced by an authorized GAC MOTOR special store.
- If the SRS system fails, go to the authorized GAC MOTOR dealer immediately to have the system checked/repared. Otherwise, the control unit system may not trigger the airbags or trigger the airbags abnormally during a collision.

Front Seat Frontal Airbag



The driver's frontal airbag is installed in the steering wheel (dotted dash area), and "SRS AIRBAG" is an airbag sign.

3. Safety Operating Instructions

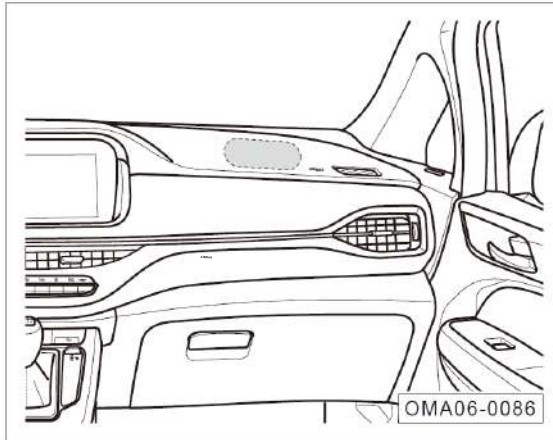

The front passenger frontal airbag is installed inside the dashboard (dotted dash area), and "AIRBAG" is an airbag sign.

When the vehicle has a severe frontal collision and the trigger condition is reached, the frontal airbag inflates immediately in conjunction with the seat belt to provide protection to the front passengers.

The system may activate the airbag at other positions when some type of collision occurs.

Warning

Do not attach or place any trim to or on the surface of the instrument panel. When the car runs or the air bags are inflated, the trim may fall, knock over or roll around in the car, affecting the driver and injuring the occupants.

The front row frontal airbags may not be triggered in one of the following conditions:

- The ignition switch is at the "ACC" or "OFF" position.
- Minor frontal collision.
- Side collision.
- Rear collision.
- Rollover.
- Other special conditions.

Hint

-Minor" is based on the feeling of the vehicle controller, regardless of the extent of damage to the vehicle.

3. Safety Operating Instructions

Front Seat Side Airbag*



The front seat side airbag is installed inside the driver's seat and front passenger's seat back against the door (dotted dash area), and the "AIRBAG" is an airbag sign.

When the vehicle has a severe side collision and the trigger condition is reached, the side airbag inflates immediately in conjunction with the seat belt to provide additional protection to the front occupants.

The system may activate the airbag at other positions when some type of collision occurs.

The front row side airbags may not be triggered in one of the following conditions:

- The ignition switch is at the "ACC" or "OFF" position.
- 100% frontal collision.
- Minor side collision.
- Rear collision.
- Other special conditions.

i Hint

-Minor" is based on the feeling of the vehicle controller, regardless of the extent of damage to the vehicle.

3. Safety Operating Instructions



Warning

- Please observe the warnings on the door side. Do not lean on the door side where any side airbag is installed during driving.
- Never cover the side airbag with seat cover or other objects so that the side airbag fails in case of an accident.

Side Curtain Airbag*

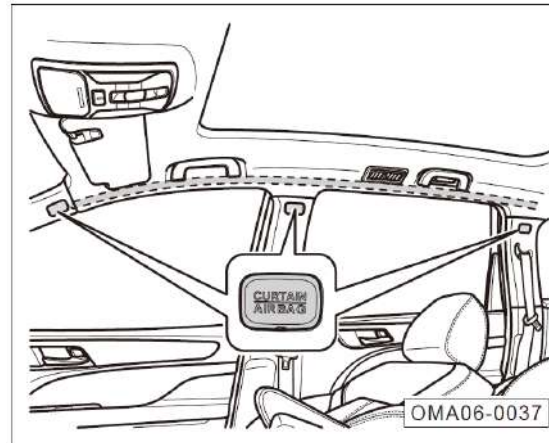

The airbag is installed inside the right and left side of the roof (dotted dash area), and the "CURTAIN AIRBAG" is an airbag sign.

When the vehicle has a severe side collision and the trigger condition is reached, the side curtain airbag inflates immediately in conjunction with the seat belt to provide additional protection to the occupants.

The system may activate the airbag at other positions when some type of collision occurs.

The side curtain airbag may not be triggered in the following conditions:

- The ignition switch is at the "ACC" or "OFF" position.
- 100% frontal collision.
- Minor side collision.
- Rear collision.
- Other special conditions.

Hint

-Minor" is based on the feeling of the vehicle controller, regardless of the extent of damage to the vehicle.

3.3.1 Cases When Airbags Could Deploy

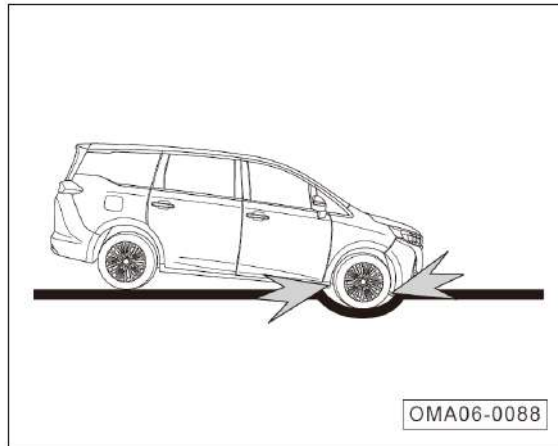

- The vehicle front collides with the ground when the vehicle wheels are attempting to pass over a deep trough.

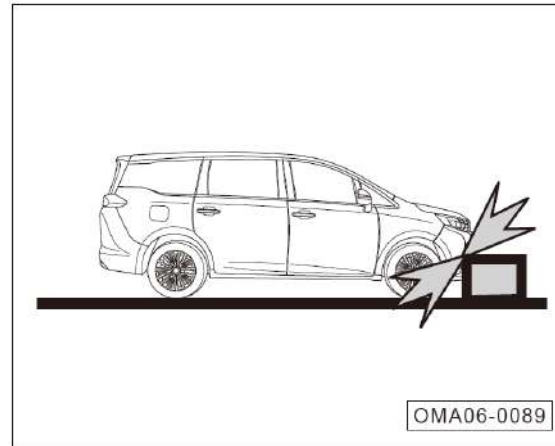

- The vehicle collides with an obstacle or street curb, etc.

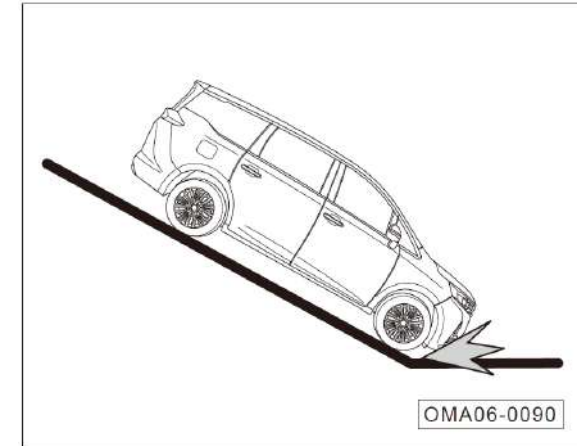

- The vehicle front collides with the ground when the vehicle is travelling down a steep slope.

3. Safety Operating Instructions

3.3.2 Cases When Airbags Could Not Deploy

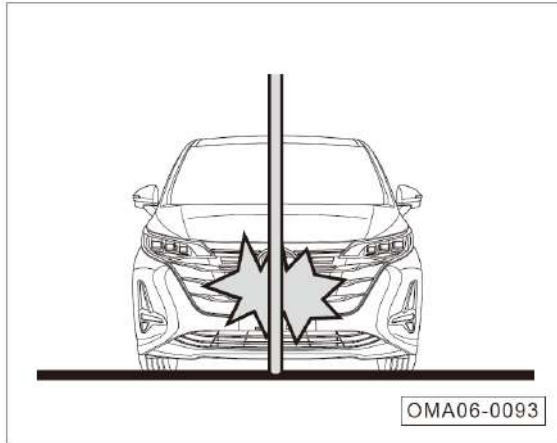

- The vehicle collides with a concrete structure, pillar, tree, or other vimineous object.

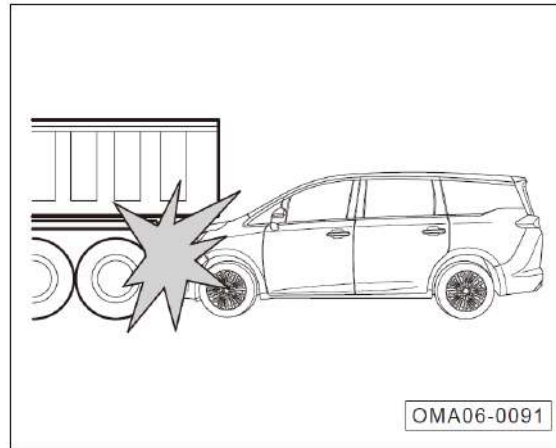

- The vehicle collides with the tail of a large truck.

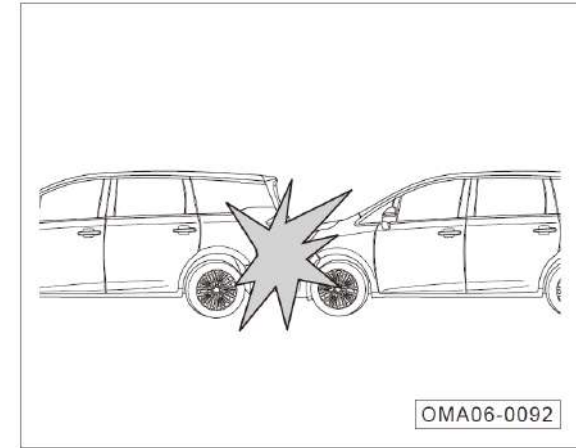

- Another vehicle collides with your vehicle from behind.

3. Safety Operating Instructions

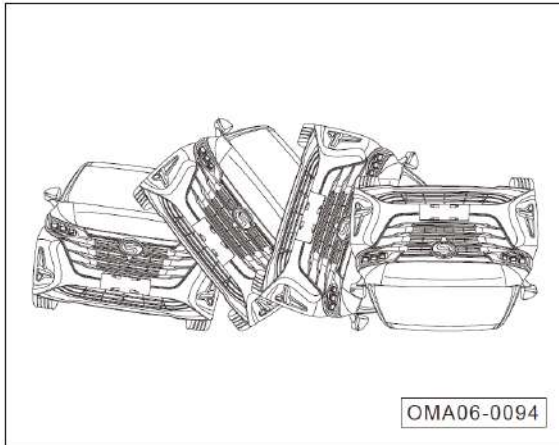

- The vehicle rollover or laterally rollover.

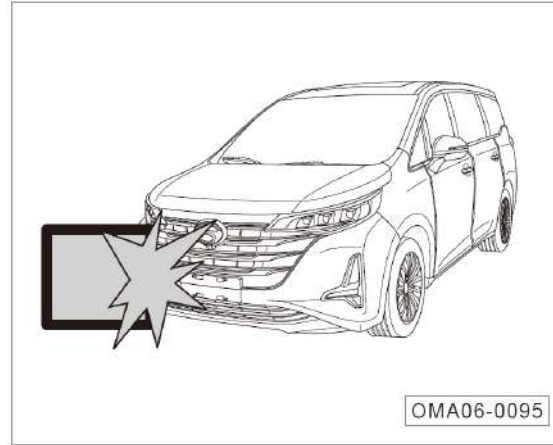

- The corner of the vehicle collides with the wall or another vehicle.

3. Safety Operating Instructions

3.4 Safety Rules for Children

3.4.1 General Instructions

The child must sit in the second row. Appropriate child safety seat should be selected according to the age of the child.

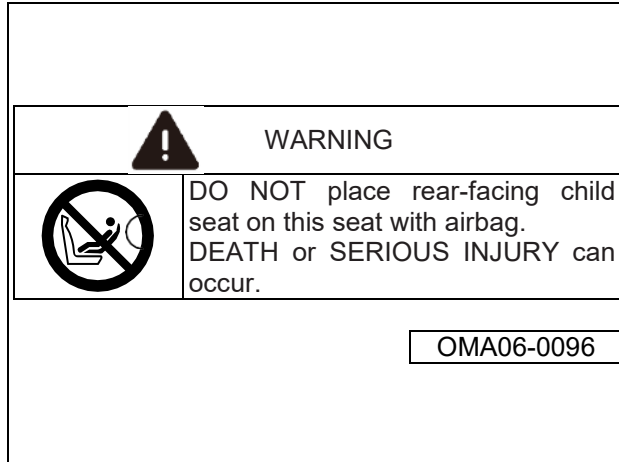

The safety signboards are on the front and back of the right sun visors. They warn you of the front passenger frontal airbag's potential hazards. Read these signboards carefully and follow their instructions.

⚠ Warning

- Do not use a child restraint system against the driving direction on a seat protected by a frontal airbag!
- Even if the child is seated in the child safety seats, never let her/his head or any body part lean on the door area (the deployment area of the front seat side airbag or side curtain airbag*) as it is risky when any of these airbags inflates, and the impact may cause serious injury, even death of the child.
- Don't let the child stand or kneel on the seat.
- Don't let the child operate any equipment that may clamp the body, such as electric window and sunroof.

⚠ Warning

- Do not leave the child in the vehicle alone.
- Never hold an infant or child on your lap!
- Seat belt is unsuitable for any infant. It may injure the infant in a crash.
- Be sure that the children are not easy to be injured due to collision with hard objects in the car in a crash or emergency braking.

3. Safety Operating Instructions

3.4.2 Child Safety Seat



OMA06-0097

Child Seat Classification (For Reference Only):

- a. **Group 0/0+ child safety seats:**
 - For infants or babies less than 13kg.
- b. **Group I child safety seats:**
 - For infants or babies within 9kg~18kg.
- c. **Group II child safety seats:**
 - For children within 15kg~25kg.
- d. **Group III child safety seats:**
 - For children within 22kg~36kg.

3. Safety Operating Instructions

3.4.3 Information about Child Safety Seat

Applicability of different riding positions to child restraint system:

Mass group	Position to fix the system		
	Front passenger seat	The Second Row Seat	Third-row seats
Group 0: <10kg	X	U	X
Group 0+: <13kg	X	U	X
Group I: 9~18kg	X	U/UF	X
Group II: 15~25kg	X	UF	X
Group III: 22~36kg	X	UF	X

Note: **Meanings of the letters in the table:**

U= Permitting use of “General” child safety seats in this mass group

UF= Permitting use of “General” front-facing child safety seats in this mass group.

X= Not applicable for use of child safety seats

Dimension ranges may be specified for some child safety seats. Find the dimension range from the manufacturer's instructions, packaging, or child safety seats. For how to correctly install the child safety seats, refer to their use instructions.

3. Safety Operating Instructions

ISOFIX child safety seats anchoring points

Mass group	Size	Anchoring module	Position to fix the system		
			Front passenger seat	The Second Row Seat	Third-row seats
Portable infant bed	F	ISO/L1	X	X	X
Group 0: <10kg	G	ISO/L2	X	X	X
Group 0+: <13kg	E	ISO/R1	X	IL	X
	E	ISO/R1	X	IL	X
	D	ISO/R2	X	IL	X
	C	ISO/R3	X	IL	X
Group I: 9~18kg	D	ISO/R2	X	IL	X
	C	ISO/R3	X	IL	X
	B	ISO/F2	X	IUF	X
	B1	ISO/F2X	X	IL	X
	A	ISO/F3	X	IUF	X
Group II: 15~25kg	—	—	X	—	X
Group III: 22~36kg	—	—	X	—	X

Note: **Meanings of the letters in the table:**

IUF—General type ISOFIX child safety seats, front-facing and fixed using upward tensioning straps.

IL—Special type ISOFIX child restraint systems, which may be those used for special vehicles, or restricted, or semi-general.

X= Not applicable for use of child safety seats.

Dimension ranges may be specified for some child safety seats. Find the dimension range from the manufacturer's instructions, packaging, or child safety seats. For how to correctly install the child safety seats, refer to their use instructions.

3. Safety Operating Instructions

3.4.4 Install a Child Seat Properly

Child seat has three types of installations, i.e. three-point seat belt, ISOFIX system, and LATCH system.

i Hint

When installing child safety seats, be sure to refer to their use instructions and observe.

Installing the Child Safety Seat Using the Three-Point Seat Belt



1. Place the child safety seat on the second-row seat.
2. Pass the seat belt through the child safety seat, and insert the latch plate into the buckle until it clicks.

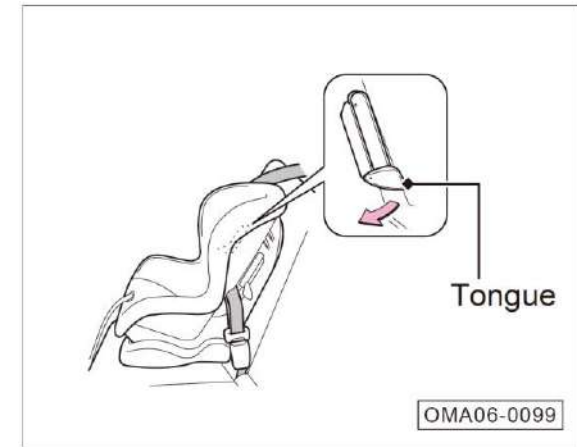

3. Push downward the tongue, and pass the shoulder part of seat belt through the narrow gap on the side of child safety seat.

3. Safety Operating Instructions

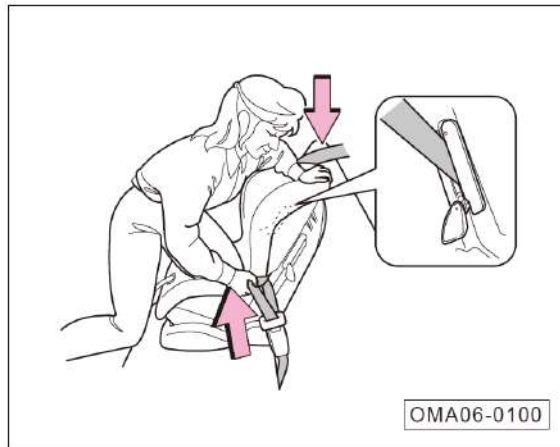

4. Hold the shoulder part of seat belt near the buckle, and pull it upward so that the lap part of seat belt is no longer loose. Press the safety seat using your own weight and push it in the seat.

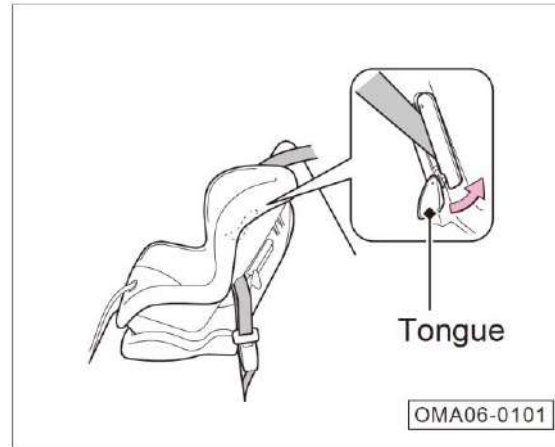

5. Place the seat belt correctly and push upward the tongue. Ensure that the seat belt is not twisted. While pushing upward the tongue, pull upward the upper shoulder part of seat belt so that the seat belt is no longer loose.

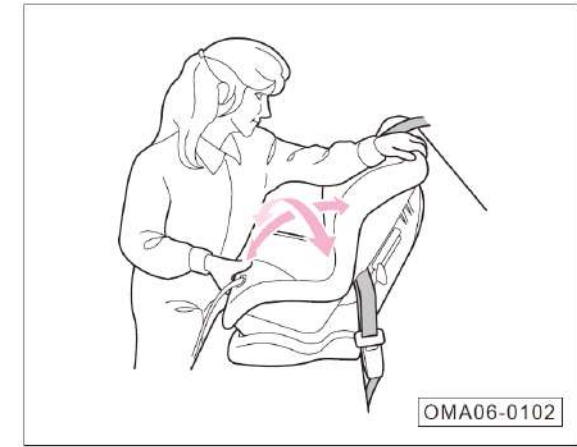

6. Shake the child safety seat forward and backward, leftward and rightward to ensure it is securely anchored.
7. Ensure that all unused seat belts within reach of children are locked.

3. Safety Operating Instructions

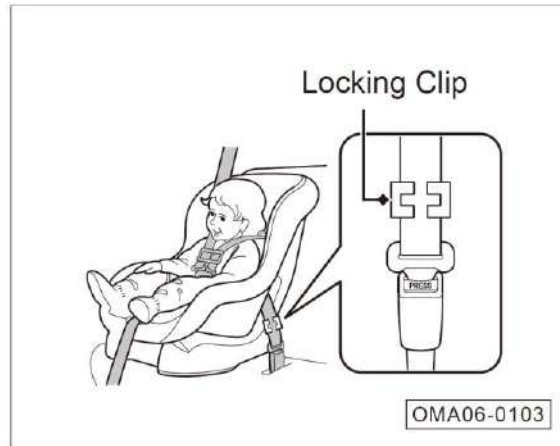

If the child safety seat has no means for fixing the seat belt, install a locking clip to the seat belt.

- With steps 1 and 2 completed, pull upward the shoulder part of seat belt so that the lap part of seat belt is no longer loose.
- Tightly hold the seat belt near the latch plate. Hold together the two parts of seat belt so that they cannot slide out of the latch plate. Release the seat belt from the buckle.

Install the locking clip as shown in the figure. With the clip as close to the latch plate as possible, insert the latch plate in the buckle. Perform steps 6 and 7.

Install the LATCH System or ISOFIX System

The seats in the second row for this vehicle are equipped with LATCH system. Therefore, both LATCH and ISOFIX system child safety seats can be installed. The installation instructions for LATCH system child seat are mainly introduced as follows:

Warning

- The anchoring point for child seat of this car can only be used to fix the child seat.
- Do not connect any other things like fastening belt, hard or sharp objects or other things other than child seat items to the anchoring point. Otherwise, it may endanger the child's life when accident occurs.

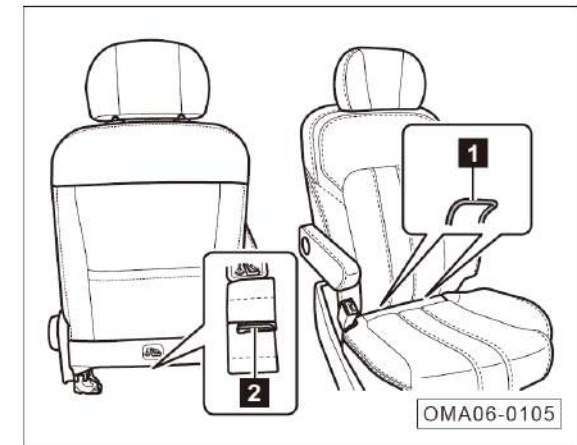

Hint

The lower anchoring point ① of the second row seats is hid in the gap between the seat backrest. You can see the upper anchoring point ② at the rear of the seat backrest.

3. Safety Operating Instructions

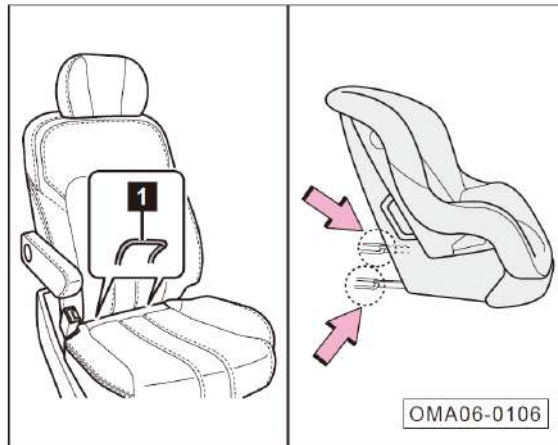

1. Place the child safety seat on the seat. Find the lower anchor point ①. Insert the lower guide slot (see the arrows) into the lower anchor point ① until it clicks.

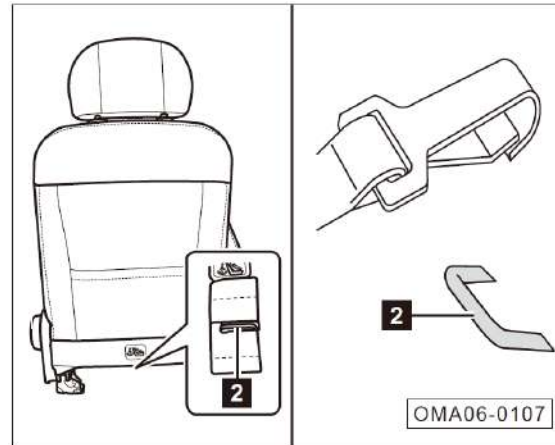

2. Raise the headrest to the upmost position. Pass the anchoring strap through the headrest support and open the protective cover of upper anchoring ② to engage the upper anchor point ②. Ensure that the anchoring strap is not twisted.
3. Tighten the anchoring strap, and shake the child safety seat to make sure it is securely anchored.

3. Safety Operating Instructions

3.5 Dangerous Exhaust Gases

Carbon Monoxide

Exhaust gases from the engine contains carbon monoxide, a toxic gas. Please use the car properly to prevent carbon monoxide from entering the car.

Please go to your authorized GAC MOTOR special store to check whether the exhaust system is normal under the following circumstances:

- Abnormal noise coming out of exhaust system
- Abnormal color of exhaust gases coming out of exhaust system

Driving with the trunk open can cause exhaust gases entering the car resulting in danger. If you have to drive with the trunk open, open all windows and turn on the air conditioning system.

1. Select the external air circulation mode.
2. Select the  mode.
3. Set the fan speed to maximum.

If the engine is idling during parking, operate the air conditioning system in the same manner.

Warning

- Inhaling carbon monoxide can cause unconsciousness, even death.
- Running the engine in confined areas (such as garage) can cause rapid accumulation of carbon monoxide. Do not run the engine in confined areas, which will result in high content of carbon monoxide inside the car. Drive away immediately after the engine is started.

3. Safety Operating Instructions

3.6 Safety Labels

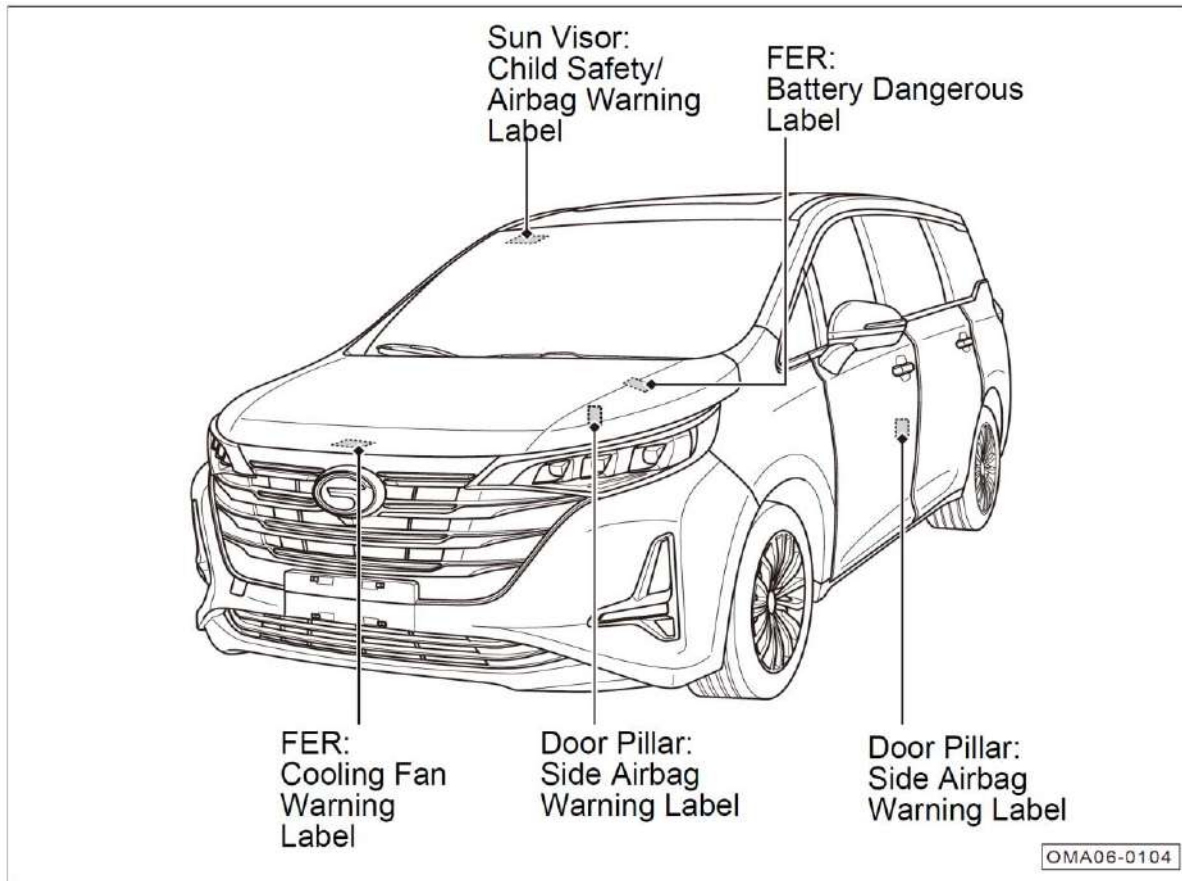

Shown in the figure are examples of the locations of labels. These labels are intended to indicate potential risks that could cause serious injury even death, please read these labels carefully.

If any label comes off or becomes illegible, contact authorized GAC MOTOR special store for replacement.

i Hint

Note that actual locations and quantities of labels may be different from those shown in the figure.

4. Operating System and Equipment

4.1 Cab

4.1.1 Steering Wheel

Steering Wheel Position Adjustment



- Adjust the driver seat to a proper position to ensure that the distance between the steering wheel and the chest is less than 25cm.

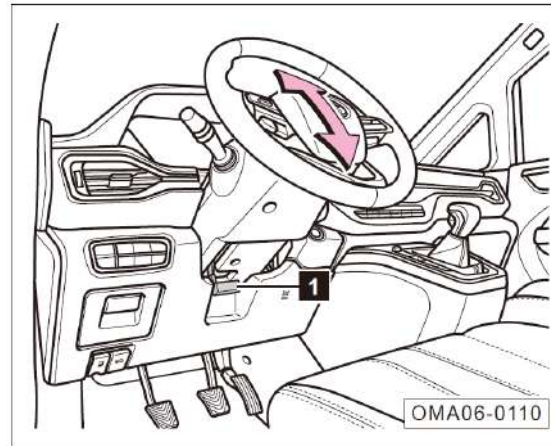



- Pull up the locking handle ① to unlock the steering wheel.
- Adjust the steering wheel position up and down as required.
- Press down the locking handle ① to lock the steering wheel, and make sure that it is locked firmly.

⚠ Warning

- Your hands should always hold the steering wheel outside edge (at the 9 o'clock and 3 o'clock positions) during driving.
- After adjusting the steering wheel, remember to lock the steering wheel to prevent displacement of steering wheel during driving.
- To avoid traffic accident, it is not allowed to adjust the steering wheel unless the vehicle is stopped.
- After adjusting the steering wheel, ensure that the instrument cluster and all the indicator lights can be seen.
- For safety, the steering wheel shall face the chest. Otherwise, the driver cannot get effective protection from the front airbag during a crash.

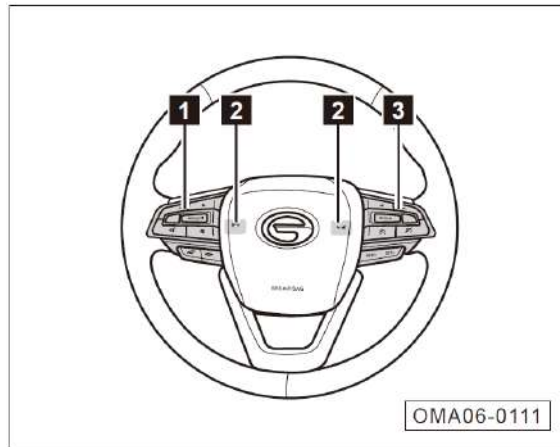
Steering wheel button



1. Audio system control button =>Refer to Page 126
2. Horn button: Press the  button, the horn sounds. Release the button, the horn stops sounding.

Warning

Do not press the  button for a long time. Otherwise it will be easily damaged.

3. The buttons at right include the instrument cluster display control button and constant speed cruise control button.
 - Instrument cluster display screen control button:
 - Travel information operation =>Refer to Page 42
 - Menu setting operation =>Refer to Page 43
 - Alarm message operation =>Refer to Page 44
 - Cruise control button *=>Refer to Page 164

4. Operating System and Equipment

4.1.2 Instrument Cluster

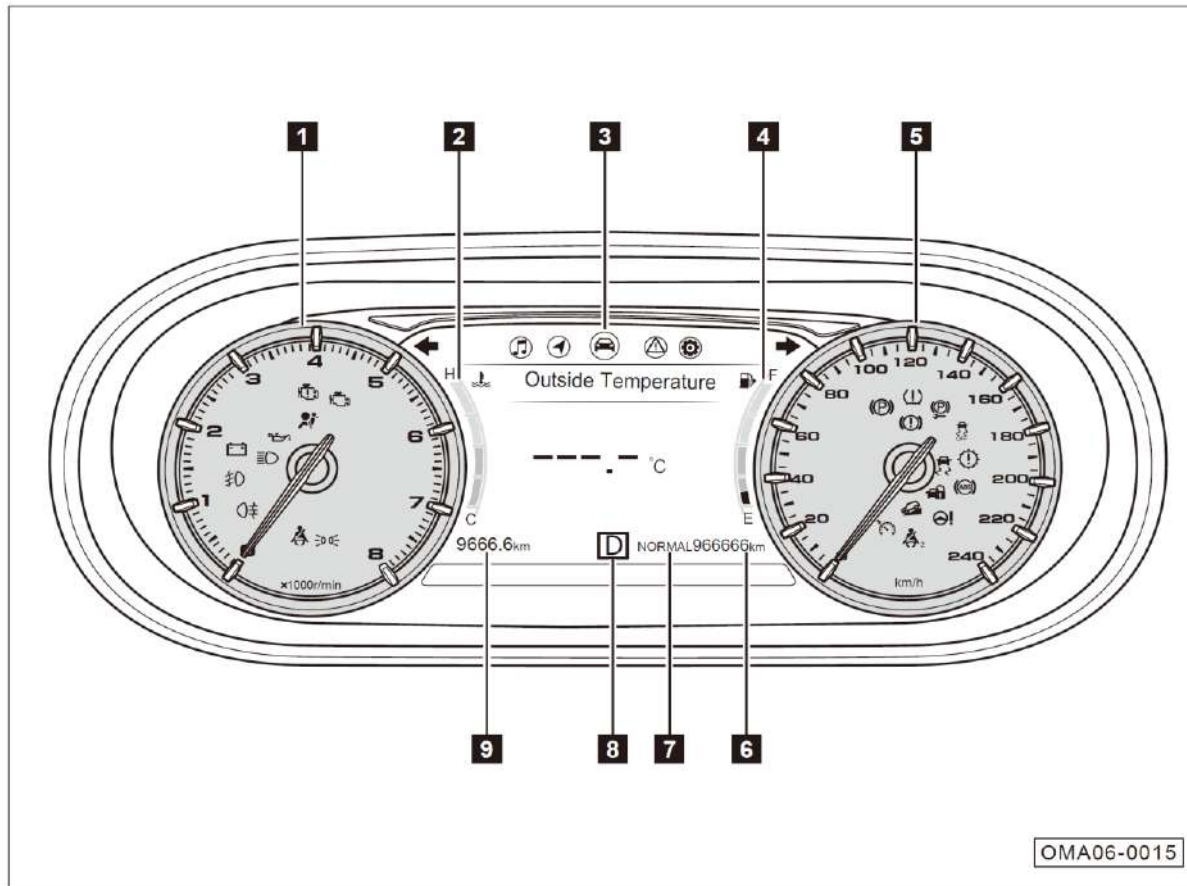

7" Instrument Cluster*

1. Engine tachometer
2. Engine coolant temperature gauge
3. Instrument cluster display
4. Fuel gauge
5. Speedometer
6. Total mileage
7. Driving mode*
8. Gear display*
9. Trip

Engine Tachometer

The engine tachometer is used to indicate the current engine speed, in x1,000 r/min.

Hint

6000~8000r/min is the high load range of engine. The engine shall not reach this range. Otherwise, the engine is extremely easy to damage.

Instrument cluster display

The display information includes: travel information, menu setting, navigation information*, audio and entertainment information, alarm message and call information*.

Caution

In case of abnormal display of the instrument cluster display, for the sake of safety, stop the car immediately, and contact an authorized GAC MOTOR special store for maintenance.

Engine coolant temperature gauge

Engine coolant temperature gauge (i.e., water temperature gauge) used for indicating the current engine coolant temperature.

- The indication range is C ~ H, in which, "C" represents low temperature and "H" indicates high temperature.
- After the engine is started, an appropriate number of bars of the coolant temperature gauge come on depending on the temperature. In normal cases, the bars come on to the middle. When all the bars come on, the current engine coolant temperature is too high.

Fuel gauge

Fuel gauge is used to indicate the current fuel remaining in the tank.

- The indicating range is E~F, in which, "E" represents that the fuel tank is empty, and "F" represents that the fuel tank is full.
- An appropriate number of sections are illuminated depending on the residual fuel. No bar or only the 1st bar coming on indicates insufficient fuel in the fuel tank. The yellow indicator light  on the instrument cluster flickers with alarm message.

Gear Information*

- The current gear information is displayed according to the received signal P, R, N or D.

Driving Mode Information*

- The current driving mode of the car is displayed according to the received signal.

Trip

- Display range: 0 km~9999.9km. – When the trip is greater than 9999.9km, it will be reset and then continue to accumulate.
- The trip may be reset through "Trip" in the settings of instrument cluster menu.

Total mileage

- Display range: 0 km~999999 km.

Speedometer

Speedometer is used for indicating the current vehicle speed, in km/h.

Caution

In order to drive safely, please strictly abide by traffic rules. Do not overspeed at will.

4. Operating System and Equipment

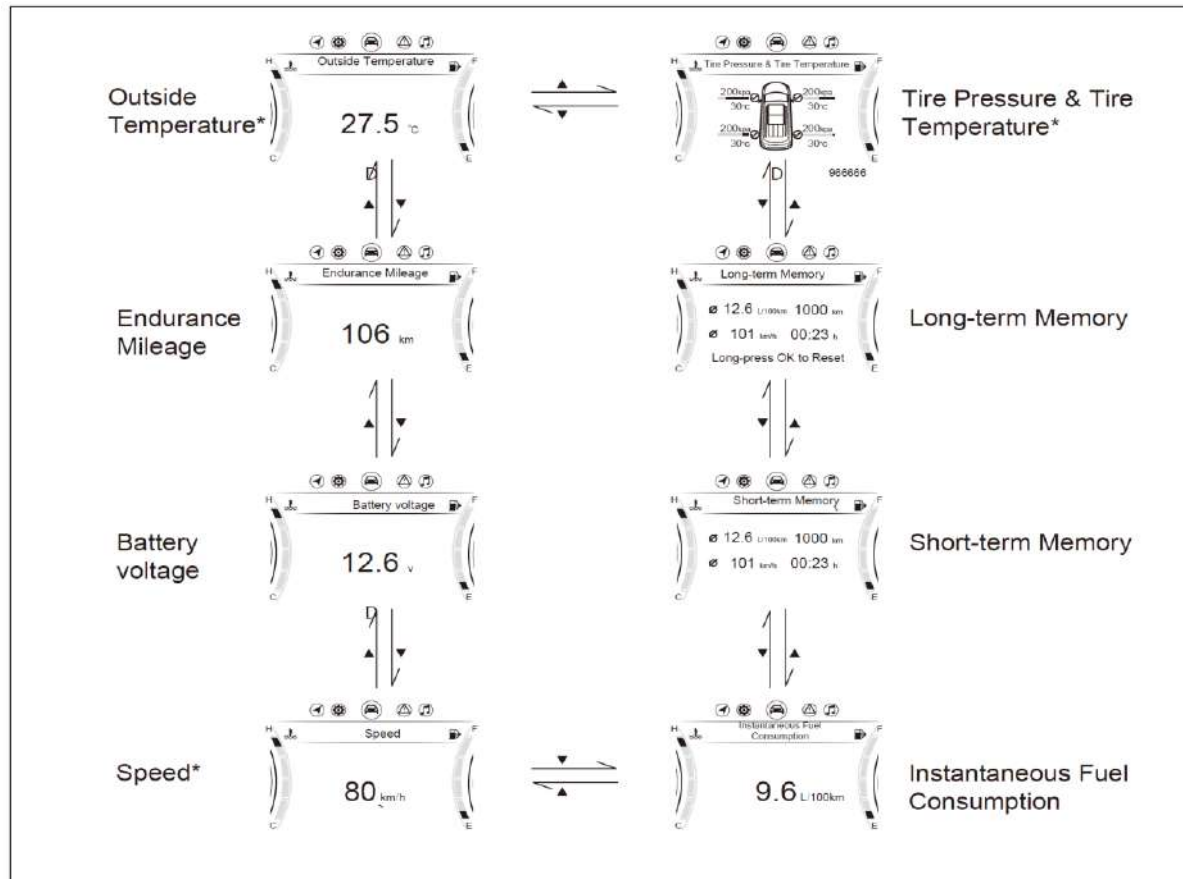

Travel Information

Press ◀▶ on the right side of the steering wheel to enter the travel information interface when the ignition switch is at "ON" position; and then press ▲/▼ on the OK button to switch among travel information interfaces.

i Hint

- When no valid information is received, no valid data will be displayed on the travel information interface.
- Long-term memory interface data can be reset by long pressing OK.
- Operation of other instrument clusters is similar to that of 7-inch instrument cluster as shown in the figure.
- Please refer to the actual vehicle configuration in case of any difference of the travel information interface.

4. Operating System and Equipment

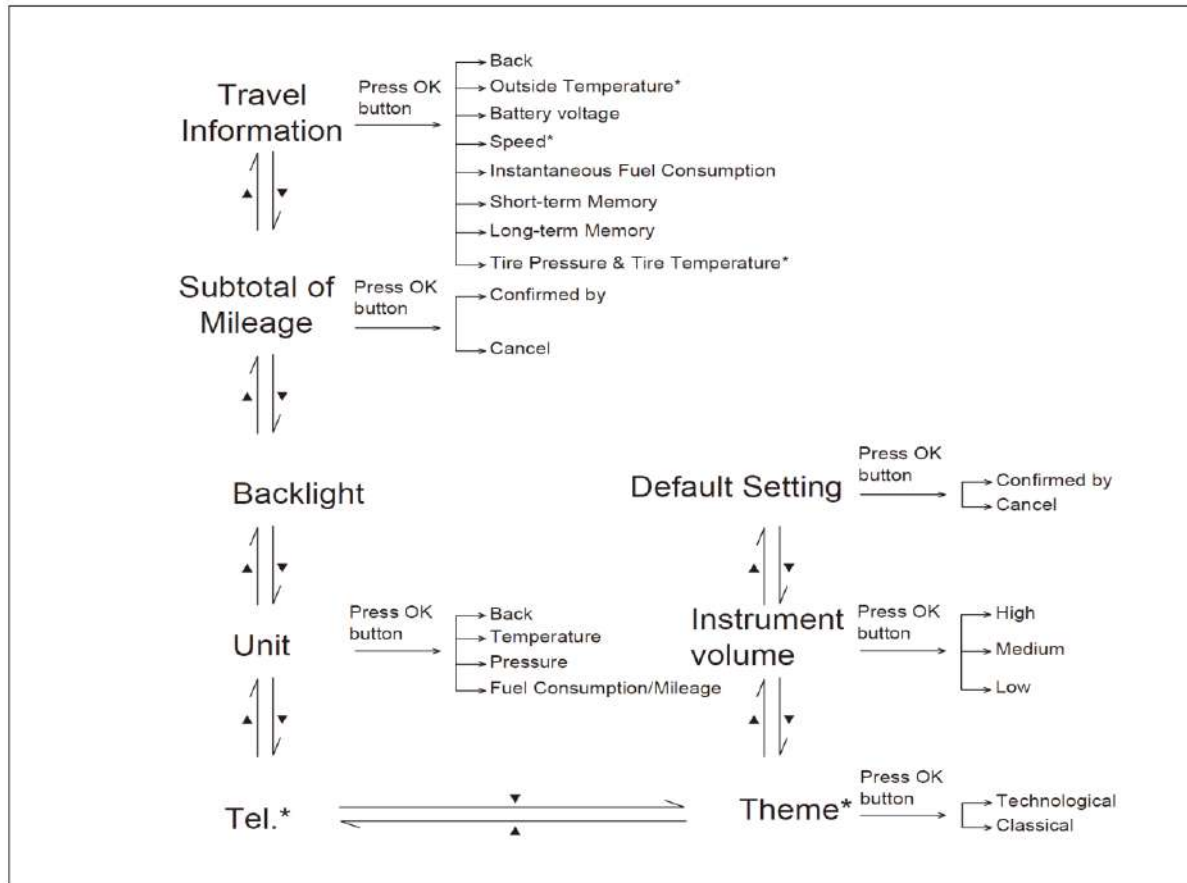

Menu setting

Press on the right side of the steering wheel to enter the menu setting interface when the ignition switch is at "ON" position and the vehicle speed is zero; and then press on the OK button to move the cursor, press OK to enter the menu at the lower level, and press OK again to select, confirm or cancel.

Hint

- Operation of other instrument clusters is similar to that of LCD instrument cluster as shown in the figure.
- If menu setting operation is conducted when the vehicle speed is not zero, the alarm message "Safe Driving Tip: No setting operation before the car is stopped". If the message is displayed for over 5s, the instrument cluster will automatically switch to the travel information interface.
- Please refer to the actual vehicle configuration in case of any difference of the menu setting.

4. Operating System and Equipment

Alarm Message



Alarm messages are displayed in the form of text or picture or beeping to indicate the current status of the car. The driver should always pay attention to the presence of alarm messages.

- When the ignition switch is at "ON" position, in case of any abnormality of the car, the instrument cluster will display the alarm message in priority, and return to the previous interface when the alarm message is confirmed with "OK" pressed. In the event of no operation, the alarm message will appear again 5s later.

- In case of multiple alarm messages, press ◀▶ to switch to the alarm message interface, and ▲/▼ on the OK button to read the previous/next alarm message.
- If the car is in good condition and there is no alarm message, "No message" will be displayed on the alarm message interface.

Call Information*

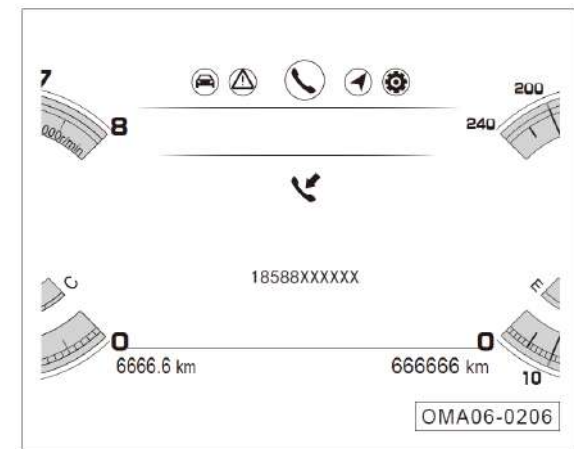

- After the audio system is connected to the mobile phone via Bluetooth and when there is any call, it displays the call information, including incoming call, call, and missed call.

i Hint

Operation of other instrument clusters is similar to that of LCD instrument cluster as shown in the figure.

Audio and Entertainment Information*

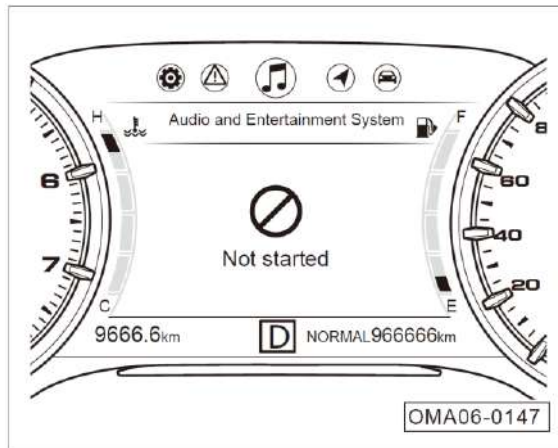



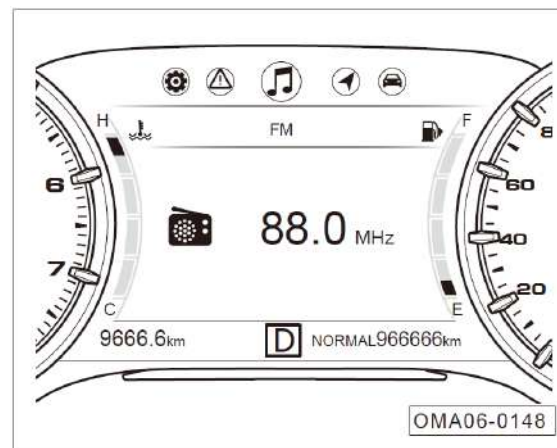





- When the ignition switch is at "ON" position, press ◀ / ▶ to enter the audio and entertainment information interface. Before the audio system is started, this interface displays "not started".













- When the audio system is started, the current play information of the audio system is displayed on the audio and entertainment information interface.

4. Operating System and Equipment









4.1.3 Indicator Light

S/N	Icon	Name	Color	Function
1		Charging system warning light	Red	With the Ignition switch at "ON" position, the warning light is lit when the engine is not started and is off after the engine is started.
				After the engine starting, if the warning light is lit, it indicates that there is a fault in the charging system.
2		Engine malfunction indicator light	Yellow	With the Ignition switch at "ON" position, the indicator light illuminates for a few seconds and then extinguishes after self-checking of the system if the engine is not started and there is no fault.
				After the engine starting, if the indicator light is lit, it indicates that there is a fault in the engine system.
3		Low engine oil pressure warning light	Red	With the Ignition switch at "ON" position, the warning light is lit when the engine is not started and is off after the engine is started.
				After the engine starting, if the warning light is still on, it indicates that the engine oil pressure is low.
4		Emission malfunction indicator light	Yellow	With the Ignition switch at "ON" position, the indicator light is lit when the engine is not started and is off after the engine is started.
				After the engine starting, if the indicator is still on, it indicates that there is a fault in the exhaust system.
5		Left turn signal and hazard warning indicator light	Green	When the left turn signal indicator light flashes alone, it indicates that the left turn light is turned on. When the hazard warning indicator light switch is pressed, the left/right turn signal indicator lights will flash together with all the outside turn signal lights.
6		High engine coolant temperature indicator light	Red	If the indicator light is lit (red), it indicates that the engine coolant temperature is too high.
7		Supplemental restraint system (SRS) indicator light	Red	If the indicator light is lit (red), it indicates that there is a fault in the SRS system.
8		Low fuel indicator light	Yellow	If the indicator light flashes (yellow), it indicates that less fuel remains in the tank.
				If the indicator light is lit (yellow), it indicates a possible fault with the fuel pump.

4. Operating System and Equipment

S/N	Icon	Name	Color	Function
9		Right turn signal and hazard warning indicator light	Green	When right turn signal indicator light flashes alone, it indicates that the right turn lights are turned on. When the hazard warning indicator light switch is pressed, the left/right turn signal indicator lights will flash together with all the outside turn signal lights.
10		Immobilizer lock system indicator light	Red	If the indicator light is lit (red), it indicates that the engine immobilizer system or the car anti-theft system is enabled.
11		EPB status indicator light	Red	If the indicator light is lit (red), it indicates that the EPB is applied. If the indicator light (red) flashes, it indicates that the EPB is partly engaged or failed.
			Green	If the indicator light is lit (green), it indicates that electronic automatic parking is activated.
12		EPB malfunction indicator light	Yellow	If the indicator light is lit (yellow), it indicates that there is a fault in the EPB system.
			Yellow	– If the indicator light flashes (yellow), it indicates that the EPB system is in maintenance mode.
13		Parking brake and brake system indicator light	Red	If the indicator light is lit (red), it indicates that the brake fluid level is too low or there is a fault in the electric brakeforce distribution (EBD) system.
14		Vehicle Stability Program (ESP) indicator light	Yellow	If the indicator light is lit (yellow), it indicates that there is a fault in the ESP system.
			Yellow	If the indicator light flashes (yellow), it indicates the ESP is working.
15		Electronic Stability Program Off (ESP OFF) indicator light	Yellow	If the indicator light is lit (yellow), it indicates that the ESP system is switched off.
16		Anti-lock brake system (ABS) indicator light	Yellow	If the indicator light is lit (yellow), it indicates that there is a fault in ABS.
17		Transmission malfunction indicator light*	Yellow	If the indicator light is lit (yellow), it indicates that there is a fault in the transmission system.
			Yellow	If the indicator light flickers (yellow), it indicates that the oil temperature of the automatic transmission is high.
18		Tire pressure monitoring system (TPMS) indicator light*	Yellow	If the indicator light is lit (yellow), it indicates that there is a fault in the TPMS or the tire state is abnormal.
19		Electronic Power Steering (EPS) indicator light	Yellow	If the indicator light is lit (yellow), it indicates that there is a fault in the EPS system.

4. Operating System and Equipment

S/N	Icon	Name	Color	Function
20		Cruise control indicator light*	White	If the indicator light is lit (white), it indicates that the adaptive cruise system is making preparation.
			Green	If the indicator light is lit (green), it indicates that the adaptive cruise system is enabled.
21		Front passenger seat belt indicator light	Red	If the indicator light is lit (red), it indicates that the front passenger seat belt is not fastened or there is a fault in the belt system.
22		Driver seat belt indicator light	Red	If the indicator light is lit (red), it indicates that the seat belt is not fastened or there is a fault in the belt system.
23		High beam indicator light	Blue	If the indicator light is lit (blue), it indicates that high beams are turned on.
24		Position light indicator light	Green	If the indicator light is lit (green), it indicates that the position lights, instrument panel light, number plate lights, and atmosphere light, etc . are turned on.
25		Rear fog light indicator light	Yellow	If the indicator light is lit (yellow), it indicates that rear fog lights are turned on.
26		Front fog light indicator light*	Green	If the indicator light is lit (green), it indicates that front fog lights are turned on.
27		The second seat belt indicator light*	White	If the indicator light comes on in white, it indicates that the corresponding second seat belt is fastened.
			Red	If the indicator light comes on in red, it indicates that the second seat belt is not fastened or the belt system fails.
28		Hill descent control (HDC) indicator light	Yellow	If the indicator light is lit (yellow), it indicates that HDC system is turned on.

Note: If any indicator light or warning light in the instrument cluster illuminates after car starting or during driving, it indicates relevant system or function may work or failure occurs. You should read through the indications of each indicator light, warning light carefully; please have your car checked and repaired at the authorized GAC MOTOR special store timely when failure occurred.

4.2 Vehicle Opening and Closing

4.2.1 Smart Key

Models with Engine Start/Stop switch* are provided with smart keys (containing emergency mechanical keys) and key bar codes. Models with traditional ignition switch* are provided with common keys (containing mechanical keys) and key bar codes. If you need to re-customize the key or the key bar code is lost, contact an authorized GAC MOTOR special store.

Low Signal Intensity of Smart Key

In following cases, it may be impossible or difficult to operate by pressing the key buttons:

- The equipment nearby is emitting strong wireless electric wave.
- The smart key is carried together with telecommunication equipment, laptop, mobile phone or wireless signal transmitter.
- The smart key is contacted with covered by any metallic objects.

Caution

There is an electric loop inside the smart key to trigger the immobilizer system. If this loop is damaged, it may fail to start the engine. Thus:

- The smart key shall be protected from direct sunlight, high temperature and high humidity.
- Dropping the smart key from a high place or crushed with a heavy thing shall be avoided.
- Contacting the smart key with fluids shall be avoided. Please dry it immediately when got wet.

Hint

- The standard remote control distance is 15m, and the longest remote control distance exceeds 50m.
- When the ignition switch is at "ACC" or "ON" position, the operation of any button on the smart key is not available.
- Quickly press the buttons on the key shortly for 3 times to recover its function when the lock or unlock function is failed.

4. Operating System and Equipment

Operation of Buttons

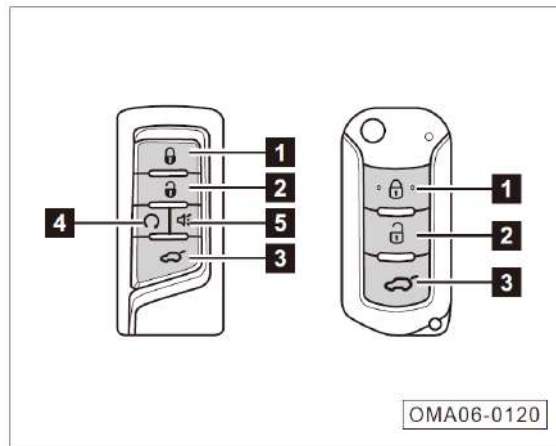

1. Lock button
2. Unlock button
3. Hatchback door unlocking button
4. Engine Start/Stop button *
5. Anti-theft alarm button*

1. Button

- Short pressing this button once within the effective range, all doors will be locked; pressing this button and hold for 2s, the driver side window will close automatically; pressing this button and hold for 3s, the sunroof will close automatically. If this button is released while the window or sunroof is closing automatically, the closing will be stopped.
- Pressing this button twice continuously within 0.5s, the vehicle locating function can be activated, and the turn signal light will flash quickly for 3 times.



2. Button

- Short pressing this button once within the effective range, all doors will be unlocked; pressing this button and hold for 2s, the driver side window will open automatically; pressing this button and hold for 3s, the sunroof* will open automatically. If this button is released while the window or sunroof* is opening automatically, the opening will be stopped.

Caution

During remote closing of window or sunroof, make sure that no body parts (such as head and hand) are within the track. Otherwise, they may be crushed.



Hint

- Activate or deactivate remote control of window and sunroof via "Vehicle Setting → Smart Body → Remote Control of Window and Sunroof" in the audio system.
- When the door is locked, the turn signal will flash once, and the horn honks once. When the door is unlocked, the turn signal will flash twice, and the horn honks twice. Activate or deactivate the horn beeping via "Settings → Sound → Unlock/Lock Horn Beeping" in the audio system.
- Via "Vehicle Setting → Smart Body → Remote Unlocking" under the audio system, press the  button to unlock all the doors or only the left front door.
- After pressing the  button to unlock the door, the system will lock the door again if it is not opened within about 30s.



3. Button

- Within effective range, long pressing this button for 2 seconds, the hatchback door can be unlocked.



4. Button*

- In the effective range, short press  once, and then long press  within 2s until the turn signals flash when the engine can be started remotely.
- With the engine remotely started, long press the  button for 3s till the turn signal flashes. You can remotely stop the engine.

Hint

- Before remote shutdown of the engine, confirm whether the car is locked. If this cannot be confirmed, press  button once and then long press  button before shutting down the engine.
- In remote startup of the engine, stay within effective range. Otherwise, it is possible to trigger the unlock function but fail in startup.
- The function of remotely starting engine remains on at a time for at most 5 minutes in default. To change the period, contact authorized GAC MOTOR special store.



5. Button*

- Long pressing this button for 3s activates anti-theft alarm, with the horn sounding and the turn signals flashing 30s. Short pressing  or  can stop anti-theft alarm.

4. Operating System and Equipment

Switch between "Sound and Flash" and "Flash" Alarm Modes

The "light" alarm indicates the vehicle warns the driver only with turn signal light, while the "sound and flash" alarm mode indicates the vehicle warns the driver both with turn signal light and horn sound.

When the ignition switch is at "OFF" position, press the  button and  button on the remote key at the same time for 2s to switch between the "flash" alarm mode and "sound and flash" alarm mode. If the switching is successful, the turn signals will flash at the same time 3 times (only applicable to electronic anti-theft alarm).

Battery Replacement

The indicator light of the key flashes once every time the button on the key is pressed. If it does not flash when the key is pressed, or if the button has to be pressed several times to lock or unlock the door, the battery could be run out or nearly run out. In this case, it is recommended to replace the battery at authorized GAC MOTOR special store as required.

Caution

- Be sure to use a new battery with the same rated voltage and size for replacement.
- Using of improper battery may damage the smart key.
- Used batteries must be disposed as per relevant regulations and laws for environment protection.

Steps to Replace Battery

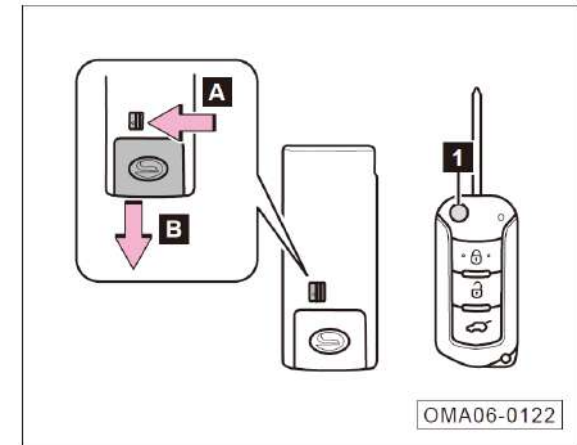

- Key for models with Engine Start/Stop switch*: Move the switch in the direction of arrow A and pull out the emergency mechanical key in direction of arrow B.
- Key for models with traditional ignition switch*: Press the button ① to eject the mechanical key.



- Key for models with Engine Start/Stop switch*: Use the emergency mechanical key to prise out the smart key case at the position indicated by the arrow.
- Key for models with traditional ignition switch*: Pull open the smart key case in the direction of arrow.

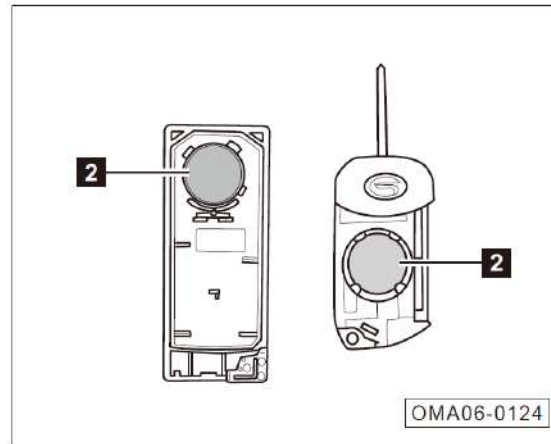

- Remove the smart key battery ②.
- Install the smart key in the reverse order.

4. Operating System and Equipment

4.2.2 Mechanical Key

Mechanical Key

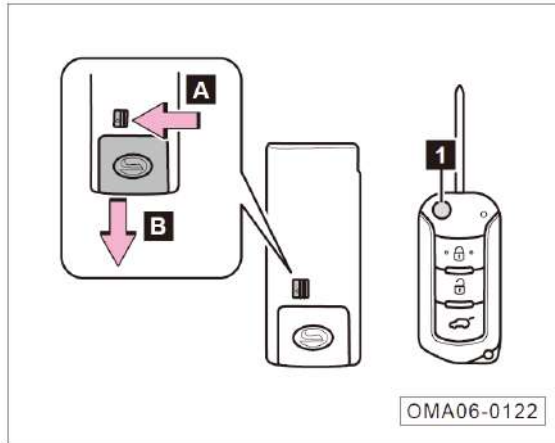

- Key for models with Engine Start/Stop switch*: Move the switch in the direction of arrow A and pull out the emergency mechanical key in the direction of arrow B to lock all the doors or unlock the driver side door, and make car start fail.
- Key for models with traditional ignition switch*: Press the button ① to eject the mechanical key to lock all the doors or unlock the driver side door, and start the engine.

Spare Mechanical Key*





- The spare mechanical key can be used to lock all the doors or unlock the driver side door, and start the engine.

4.2.3 Locking System

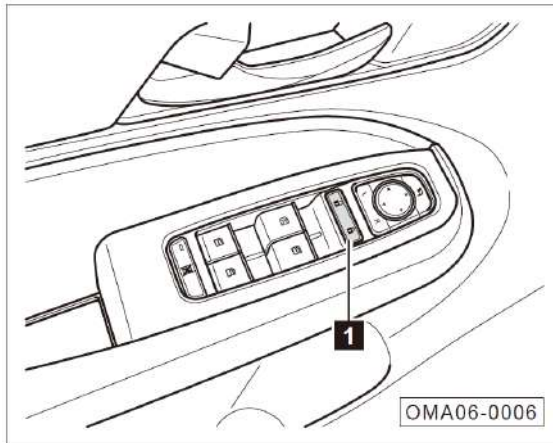
Central Locking Button



With the Ignition switch at ON position, use the central locking button ①.

- Locking: press the  end of the central locking button ① to lock all the doors.
- Unlocking: press the  end of the central locking button ① to unlock all the doors.

Door Lock Latch and Inner Handle

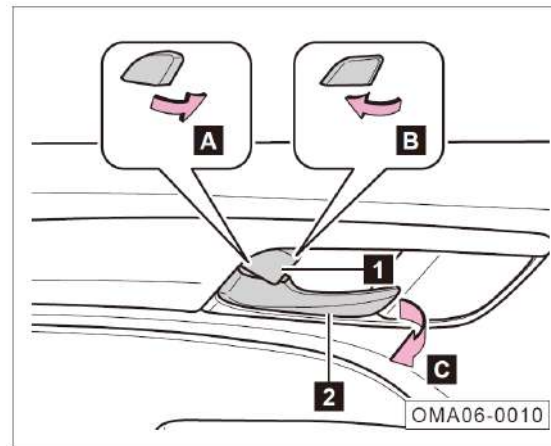

- Pushing the door latch ① inward in direction of arrow A, corresponding door can be locked.
- Pulling the door latch ① outward in direction of arrow B, corresponding door can be unlocked. Then, pull the inner handle ② in direction of arrow C to open corresponding door.

Hint

With the child safety lock unlocked =>(Refer to Page 54), even if the rear door latch is in the unlocked state, the rear door cannot be opened by inner handle. In such case, the rear door can be opened from outside. Do not rudely pull the inner handle. Otherwise it may be damaged.

Caution

After the door latch is locked, do not forcedly pull the inner handle.

4. Operating System and Equipment



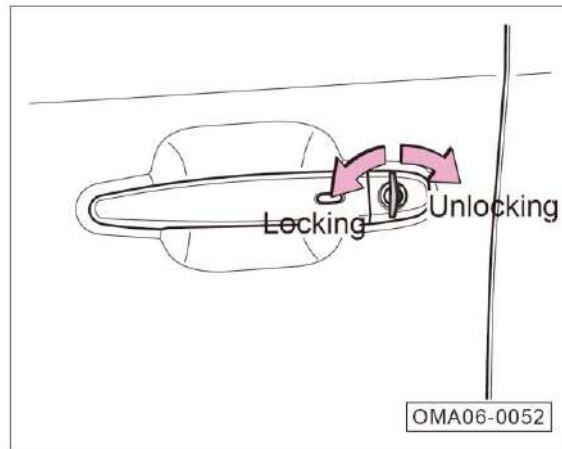

Door Lock Hole

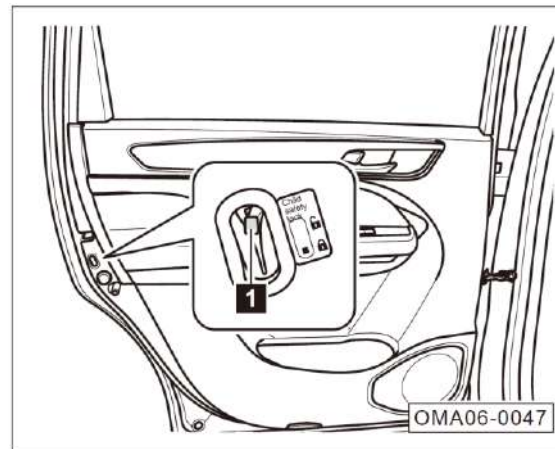

- Take out the mechanical key*. => Refer to [Page 52](#)
- Insert the emergency mechanical key into the lock hole of door at driver side.
- Rotate the key anticlockwise, and all doors can be locked.
- Rotate the key clockwise, and only the door at driver side can be unlocked.

Child Safety Lock



- Activation: Turn the child safety lock ① from  to  to activate the child safety lock.
- Deactivation: Turn the child safety lock ① from  to  to deactivate the child safety lock.

Hint

- The child safety lock can prevent the child from opening the door unintentionally, which is able to reduce the accident risk.
- When the child safety lock is opened, the rear door cannot be opened by inner handle. In such case, the rear door can be opened from outside. Do not rudely pull the inner handle, otherwise it may be damaged.

Warning

Never leave the child or the disabled alone in the vehicle. Once the door is locked and an emergency occurs, it is hard for the child or the disabled to leave the vehicle by self. In the event of accidents, locked doors will certainly increase the difficulty of rescue.

Auto-Unlock Function

If the car stops with the doors locked, all the doors can be unlocked automatically when the ignition switch is switched to "OFF" position.

i Hint

Activate or deactivate automatic unlocking via "Vehicle Setting → Smart Body → Automatic Unlocking" in the audio system.

Collision unlocking function

In the event of a collision during driving with the ignition switch at "ON" position, if permitted, four doors can be unlocked at the same time. Four doors will be unlocked again 3s after the first unlocking.

Smart Active Unlocking*

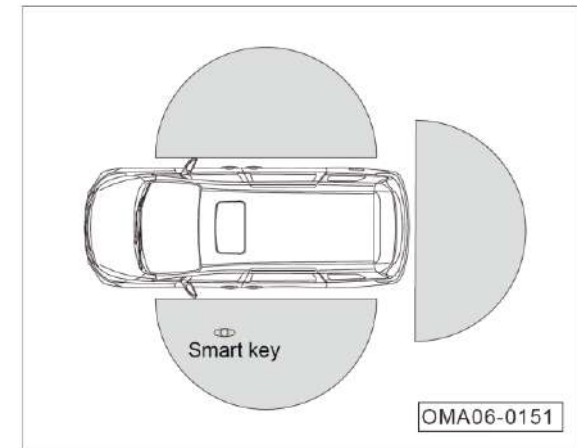

- With this function activated, the car can be unlocked automatically with the smart key is within 1m from the car.

4. Operating System and Equipment

i Hint

- Activate or deactivate smart active unlocking via "Vehicle Setting → Smart Body → Smart Active Unlocking" in the audio system.
- After successful smart active unlocking, the turn signals flash twice and the horn sounds twice.
- If the car is stationary for over 7 days, to reduce the power consumption of the car, smart active unlocking will be deactivated automatically, but smart key unlocking or induction unlocking of door handle should be activated. When the car is started, the smart active unlocking function will be activated.

Smart Active Locking*

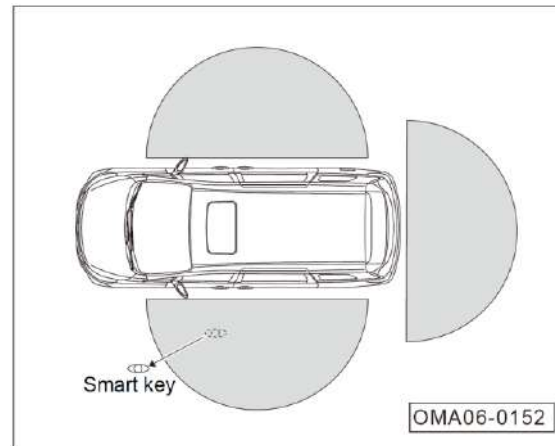

- With the smart active locking function activated and the Engine Start/Stop switch at "OFF" position, after all the doors are closed, the vehicle will be locked automatically if the user with the smart key leaves the vehicle and stays within 2m from the vehicle for over 2min or leaves the vehicle by over 2m.
- If the user stays within 2m from the vehicle for over 2min, for the purpose of saving power, the system will deactivate the smart active locking function temporarily. After the user stays for over 4min, the system will temporarily deactivate the smart active locking function, smart guest greeting light and other functions. The smart active locking function can be activated only after the user opens any door again and closes it.

i Hint

- Activate or deactivate smart active locking via "Vehicle Setting → Smart Body → Smart Active Locking" in the audio system.
- After successful smart active locking, the turn signals flash once and the horn sounds once.
- When the user with the smart key remains within 2m of the car, the indicator light on the smart key flickers continuously till the doors are locked.
- If the hatchback door is insecurely closed, audible and visual alarm will be given after successful smart active locking.
- If any door is not securely closed, the instrument cluster can provide the corresponding information.

i Hint

- With the smart active locking function active, if you approach again the car within 3 seconds, the system thinks you are checking for any door not securely locked. In this case, the system does not activate the smart active unlocking function. You can pull the rear door handle to check whether the doors are securely locked.
- When the ignition switch is at "OFF" position with released hatchback door and the smart key in the car, if the hatchback door is not closed within 10 minutes, the car will be locked automatically and the horn will sound to remind that the hatchback door is still open. If the hatchback door is closed, the car will be unlocked to prevent locking the smart key in the car.

It should be noted that the smart active locking function becomes inoperative in any of the following cases:

- Engine Start/Stop switch is at the "ACC" or "ON" position.
- There is a smart key inside the car.
- No smart key is detected within 2m from the car.
- Any door (excluding hatchback door or engine hood) is not closed.
- Smart key is thrown through the window into the car.
- The smart key is too close to the car.

⚠ Caution

- Windows cannot close automatically with the smart active locking function. Please confirm that all the windows and sunroof are closed before leaving.
- Do not leave any child or disable in the car when using the smart active locking function.

Keyless Entry*

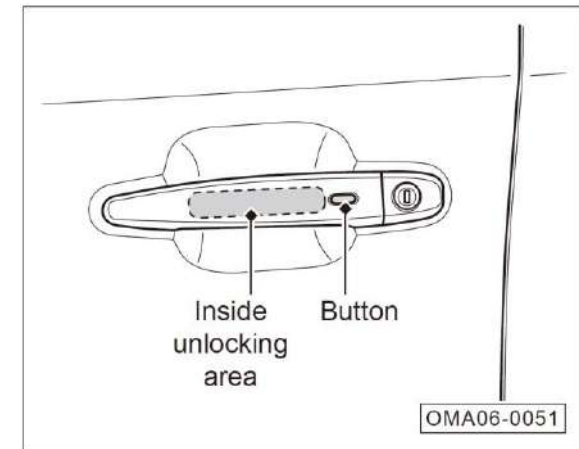

- With the Engine Start/Stop switch at OFF, carry the smart key with you, approach the car, and put your hand on the inner side of the handle of the front door (unlocking area), then effective sensing unlocks all the doors.
- With the Engine Start/Stop switch at OFF position, if the user leaves the vehicle with the smart key and presses the locking button after all the doors are closed, then all the doors will be locked after effective sensing.

4. Operating System and Equipment

Caution

- After locking doors using keyless entry function, it takes 5s before the keyless entry function can be activated to unlock doors.
- If both the unlocking and locking areas are touched at the same time, unlocking may be preferred. Do not touch them at the same time.
- Snow or ice on the front vehicle door handle should be removed as soon as possible, which affects the keyless entry function.
- If the locking button is pressed by mistake during door closing, it may trigger the anti-theft alarm.
- If the front door handle is wet due to rain or vehicle washing while the smart key is in the effective range, it is possible for the vehicle door to be unlocked.

Caution

- If grasping door handle with glove on hand, door sensor may response to door unlocking slowly or unable to respond.
- Pulling the front door handle immediately after holding it, perhaps you cannot open the door. Hold the handle, check that the vehicle is unlocked, and then pull the handle.
- Even if the smart remote key is in the 1m range from the vehicle, locking/unlocking vehicle door may be impossible if the smart keys controller of the smart key is quite above or below the external door handle.
- The smart key could not operate if it is too close to the car door or door window. If the effective range of the transmitter varies, possible cause is a weak battery.

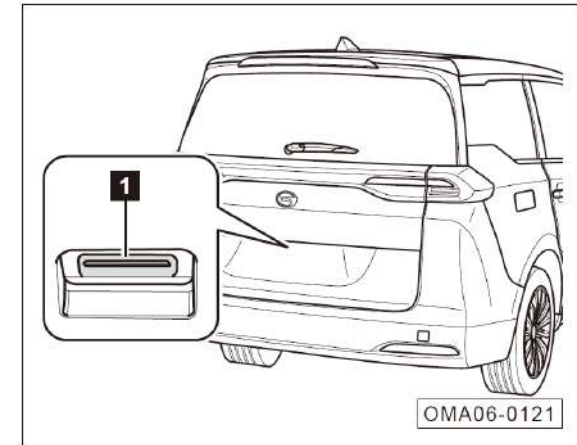

- When the Engine Start/Stop switch is at "OFF" position, if the user with smart remote key approaches to the hatchback door, pressing the release button ① of the hatchback door may unlock and open the hatchback door.
- If the car is unlocked and stationary, you may unlock and open the hatchback door by pressing the pressing the release button ① without carrying the smart key.

4.2.4 Door

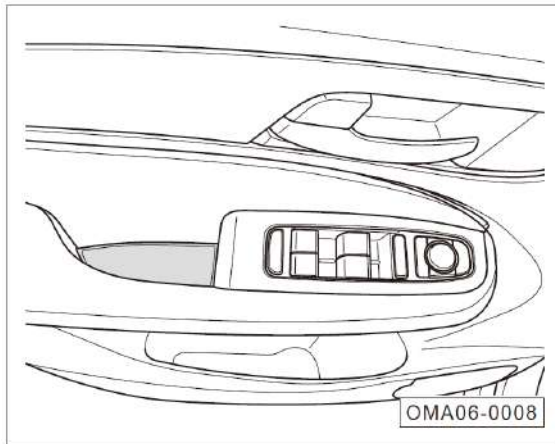

- Pull inward the handle from inside.
- Push the door directly from outside.

Caution

Before opening the door, observe whether any vehicle or pedestrian is around to avoid occurrence of collision accident.

Warning

- Before travel, make sure that all doors are already closed. Otherwise, insecurely closed doors may be opened during travel, causing injury or accident.
- The doors can only be opened or closed when the car is stationary.
- To avoid pinch, hands must be away from the door edge while the door is closed.

Hint

- If the door is not closed well, please re-open the door, and then close it.
- An alert will appear on the instrument cluster display if any door is insecurely closed; When the vehicle speed exceeds 5km/h, you will hear a warning beep.

4. Operating System and Equipment

4.2.5 Hatchback Door

Open Hatchback Door

1. With the smart key: When the Ignition switch is at "OFF" position, press the  button on the smart key for about 2s within the effective range to unlock the hatchback door, and manually open it to the highest position.
2. With keyless entry function *: Carry the smart key and press the hatchback door release button within about 1m from the hatchback door to unlock the hatchback door, and then manually open it to the highest position. => [Refer to Page 54](#)

Opening Hatchback Door in Emergency

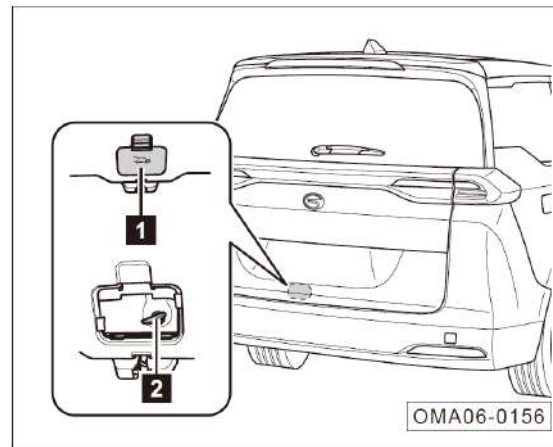

When the battery is under-voltage or the hatchback door cannot open as normal, you can try to open it from inside the car in emergency:

- Open the trim cover ①.
- Insert the mechanical key ② into the unlocking mechanism slot, and turn the mechanical key to unlock and open the hatchback door.

Hint

If it cannot be opened, please go to the authorized GAC MOTOR dealer timely to have your car checked and repaired.

Closing the Hatchback Door



- Lower the hatchback door down to the rear bumper cover, and then press it down to close it with hands.

i Hint

An alert will appear on the instrument cluster display if the hatchback door is insecurely closed; When the vehicle speed exceeds 5km/h, you will hear a warning beep.

⚠ Caution

- Before closing the hatchback door, please check that no people or animals are within the hatchback door coverage.
- Check that the hatchback door is locked. Otherwise, it could open accidentally while the vehicle is traveling, accidents may occur.

4. Operating System and Equipment

4.2.6 Engine Hood

Open the Engine Hood

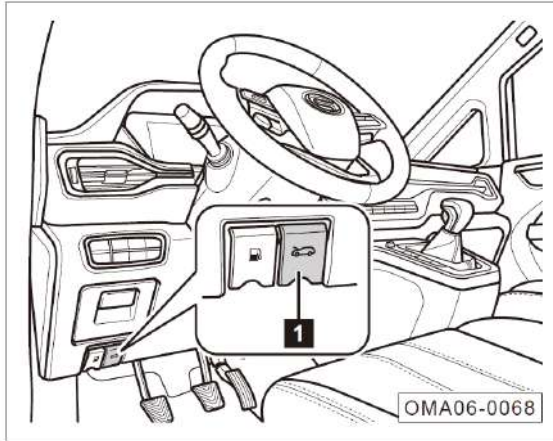

- When the release handle ① of engine hood is pulled, the engine hood will be unlocked and slightly springs up.

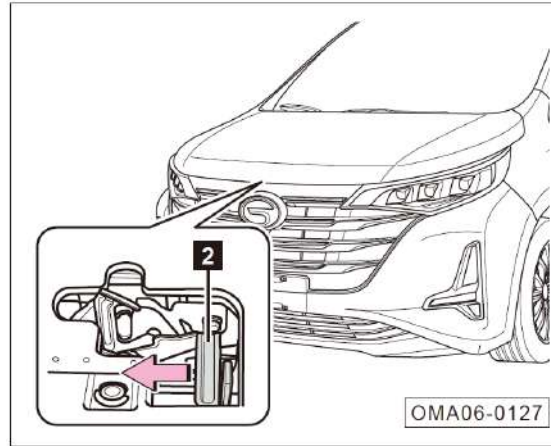

- Push the lockup mechanism in direction of the arrow to fully unlock the engine hood.
- Lift the engine hood to the highest position.

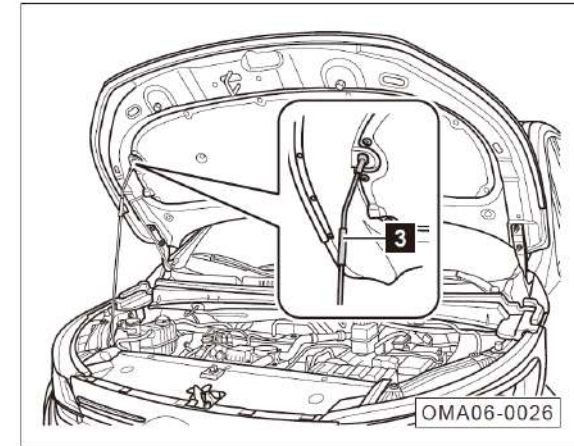

- Use a prop rod ③ to support the engine hood.

Close the Engine Hood

- Take out the prop rod, lower the engine hood to a height of about 30 cm from the lock body, and then release it to let the engine hood drops freely for locking.

Hint

An alert will appear on the instrument cluster display if the engine hood is insecurely closed; When the vehicle speed exceeds 5km/h, you will hear a warning beep.

4. Operating System and Equipment

4.2.7 Electric Windows

With the Ignition switch at "ON" position, the electric windows can be operated. Within 40s after the Ignition switch is turned to "ACC" or "OFF" from "ON", the electric windows can be operated. However, if the door is opened within this 40s, it cannot be operated.

Caution

- Please close all the windows before leaving the car.
- To avoid pinch, hands must be away from the window edge while the window is being closed.

Electric Window Button on the Driver's Side

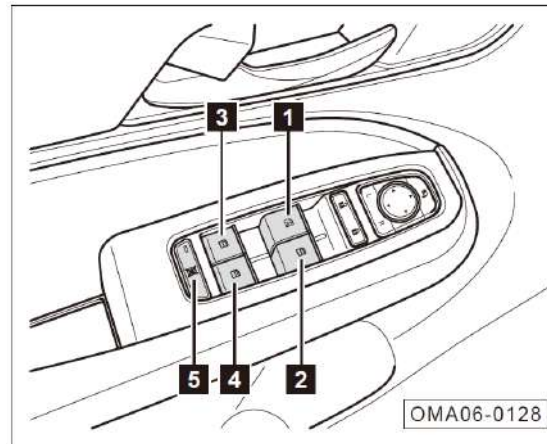

1. Front left electric window button
2. Front right electric window button
3. Rear left electric window button
4. Rear right electric window button
5. Passenger window lock button

- When button ① is pulled up lightly, the electric window moves up. It stops moving if it has reached the highest position or the button is released.
- When the button ① is pulled up heavily, the electric window automatically moves up to the highest position*.
- Lightly press button ①, the electric window moves down. It stops moving if it has reached the lowest position or the button is released*.
- When Button ① is heavily pressed, the electric window moves down all the way to the lowest position.

i Hint

- To interrupt the window movement during automatic lifting/lowering, pull/push the button ①.
- Buttons ②, ③ and ④ are operated in the same manner as Button ①.

i Hint

Only the front left window with anti-pinch function has the anti-pinch function.

- If the passenger window locking button ⑤ is pressed once, the button indicator light comes on, and the passenger side electric window buttons cannot be used for effective operation of respective window. To unlock, press the button again. Then, the button indicator is off.

Passenger side electric window button

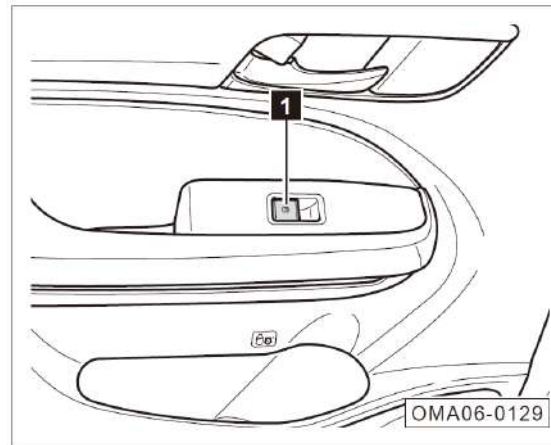

- For operation of the passenger side electric window button ①, please refer to that of the driver side electric window button.

Initialization of Anti-pinch Function

The anti-pinch function fails if the front left power window has no anti-pinch function. Initialization shall be performed.

1. When the front left electric window button is pulled up, the window moves up step by step until it is closed completely.
2. Then continue to pull up and hold the front left power window button for 2 ~ 3s. The initialization is thus completed.

⚠ Warning

- During initialization learning, the window has no anti-pinch function, so do not use any part of the body or other articles to obstruct the window movement. Otherwise, injury may be caused and the initialization affected.
- If the electric window fails, contact the authorized GAC MOTOR dealer to have it checked and repaired.

4. Operating System and Equipment

4.2.8 Electric Sunroof

With the Ignition switch at -ON" position, the electric sunroof can be operated. Within 40s after the Ignition switch is turned to -ACC" or -OFF" from -ON", the electric windows can be operated. However, if the door is opened within this 40s, it cannot be operated.

Hint

With the Ignition switch at "OFF", the instrument cluster will display "Sunroof Not Closed" and the buzzer will sound to alert if the door on the driver's side is opened but the electric sunroof is not closed. In this case, please check whether the sunroof is closed timely.

Caution

Please close the sunroof. Otherwise, rainwater can enter the car when it rains.

Common Sunroof*

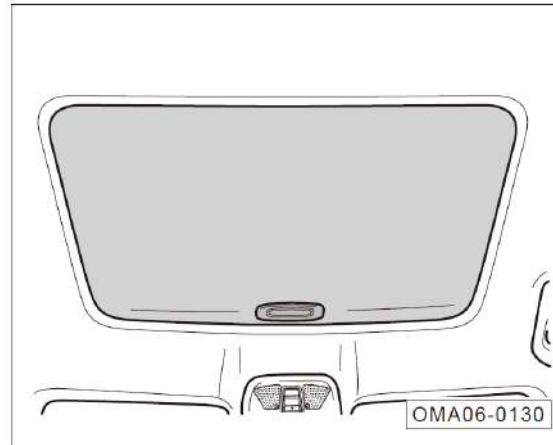

- Automatic opening: When the sunroof slides to open, the sunshade opens automatically with the sunroof.
- Manual opening: Push backward the sunroof to open it.
- Manual closing: After closing the electric sunroof, push forward the sunshade to close.

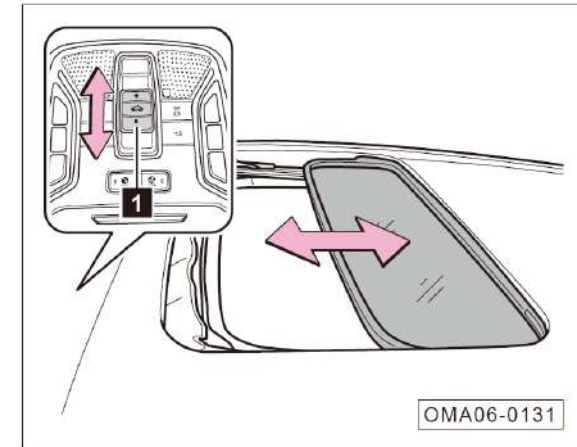

- To slightly open the sunroof, briefly backward press sunroof switch ①. The sunroof will move a short distance and then stop.
- To slightly close the sunroof, briefly forward press sunroof switch ①. The sunroof will move a short distance and then stop.

4. Operating System and Equipment

- When the sunroof switch ① is pushed backward and held for a while, the sunroof will automatically move to the fully open position.
- When the sunroof switch ① is pushed forward and held for a while, the sunroof will automatically move to the fully closed position.

i Hint

During the sunroof automatically opens or closes, if the sunroof switch ① is pushed again, the sunroof will stop at the current position.

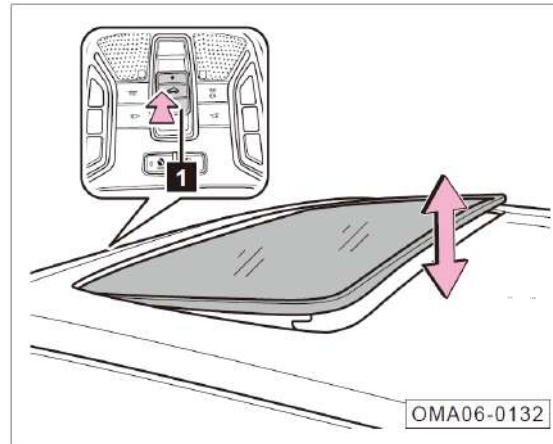

- When the sunroof is fully closed, if the sunshade is opened manually and ⇄ position on the sunroof switch ① is pressed, the sunroof will tilt outward. To close the sunroof, push forward the sunroof switch ①.

Panorama Sunroof*

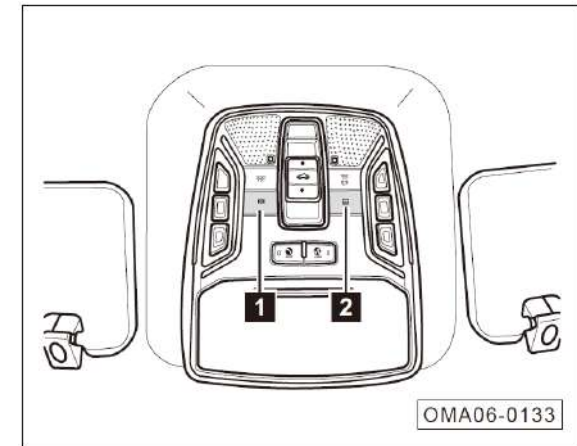

- To slightly open the electric sunshade, briefly short press the switch ①, the electric sunshade will move for a short distance and then stop.
- To slightly close the electric sunshade, briefly short press the switch ②, the electric sunshade will move for a short distance and then stop.
- When the switch ① is pressed downward and held for a while, the electric sunshade will automatically move to the fully open position.
- When the switch ② is pressed downward and held for a while, the electric sunshade will automatically move to the fully closed position.

4. Operating System and Equipment

i Hint

- When the sunroof opens, the electric sunshade automatically opens too.
- When the electric sunshade closes, the sunroof automatically closes too.
- During automatic opening or closing of the electric sunshade, if the switch ① or ② is pressed again, the sunshade will stop at the current position.

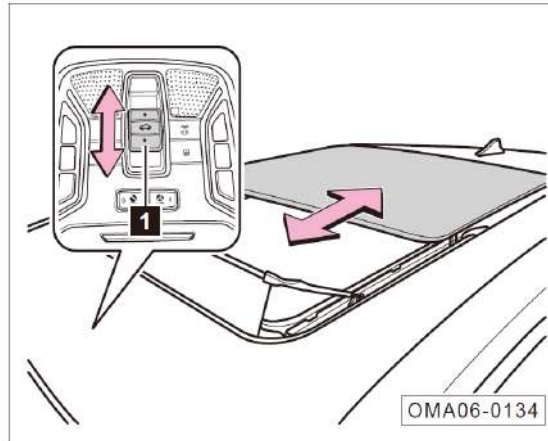

- To slightly open the sunroof, briefly backward press sunroof switch ①. The sunroof will move a short distance and then stop.
- To slightly close the sunroof, briefly forward press sunroof switch ①. The sunroof will move a short distance and then stop.

- When the sunroof switch ① is pushed backward and held for a while, the sunroof will automatically move to the comfort position. When the sunroof switch ① is pushed backward again, the sunroof will move to the fully open position.
- When the sunroof switch ① is pushed forward and held for a while, the sunroof will automatically move to the fully closed position.

i Hint

- When the sunroof automatically opens or closes, if the sunroof switch ① is pushed again, the sunroof will stop at the current position.
- The comfort position is set to balance the wind noise generated by the sunroof during driving.

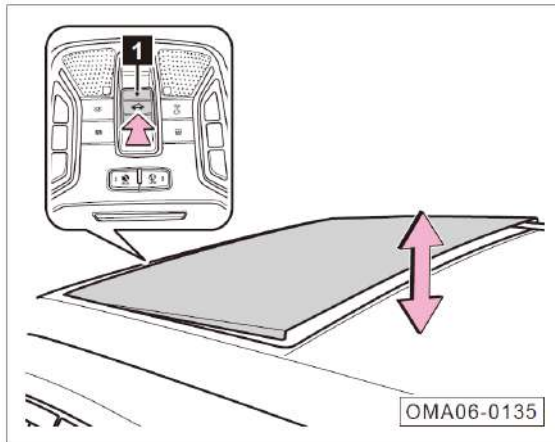

- When the sunroof is fully closed, if the sunroof switch ① is pressed, the sunroof will tilt outward. To close the sunroof, push forward the sunroof switch ①.

Sunroof Anti-pinch Function

The sunroof can enable anti-pinch function during closing:

- When the sunroof is slide from tilting, if the anti-pinch function is triggered, the sunroof will move a certain distance along the open direction and then stop.
- When the sunroof is closed from tilting, if the anti-pinch function is triggered, the sunroof will move along the tilt direction until the maximum tilt position.

Caution

Do not try to operate the electric sunroof below -20°C . In such environment, the anti-pinch function may not be activated, resulting in accidents. In addition, the low temperature may cause certain damage to the motor.

Warning

- The anti-pinch function cannot prevent the sunroof from pinching light and thin or other items in small size.
- When close the sunroof. To avoid serious injury, make sure that nobody stays within the closing movement area of the sunroof.
- The electric sunroof stops sensing obstacle when it is almost closed. At this time, there is no anti-pinch function.
- Do not attempt to activate the anti-pinch function by hand or other body parts. Doing so can cause serious injury to your body easily.

4. Operating System and Equipment

Sunroof Manual Initialization and Adaptive Learning

Common Sunroof*

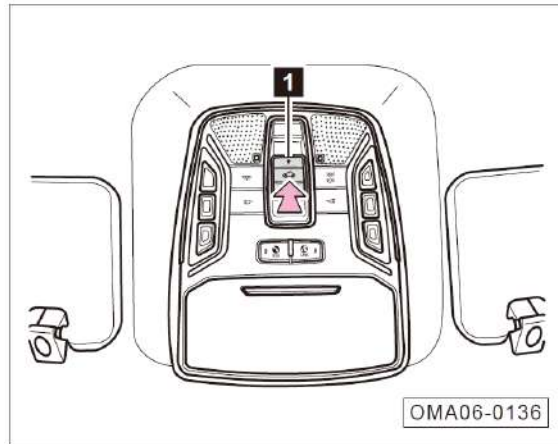

- When the sunroof is tilted, if the position on the sunroof switch ① is pressed upward and held for over 10s, the sunroof will start initialization.
- With the position on the sunroof switch ① pressed upward (or the sunroof switch ① pushed forward), the sunroof will finish adaptive learning after performing "Tilt down to Close → Slide to Open → Fully Close".

Panorama Sunroof*

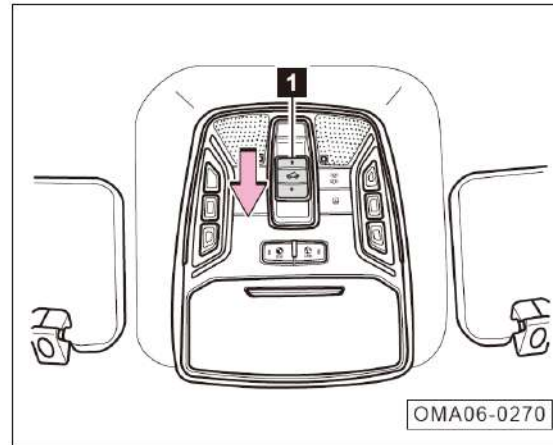

- When the sunroof is closed, if the sunroof switch ① is pushed forward and held for over 10s, the sunroof will start initialization.
- With the sunroof switch ① pushed forward, the sunroof will finish adaptive learning after performing "Tilt up → Open → Close".

Caution

If the electric sunroof fails, contact an authorized GAC MOTOR special store to have it checked and repaired as soon as possible.

4.2.9 Basic Operations of Anti-Theft on Vehicle Body

Anti-Theft on Vehicle Body - Unlock

With the ignition switch at "OFF" position and the car locked, if you carry the smart key with you, approach the car, and put your hand on the inner side of the handle of the front door (unlocking area) for effective sensing* or unlock the car remotely, then the door unlocking and the anti-theft is released, and the turn signals will flash twice.

Anti-Theft on Vehicle Body - Lock

With the ignition switch at "OFF" position and four doors, engine hood and hatchback door closed, if you take the smart key away from the car and press the handle of the front door unlocking button for effective sensing * or lock the car remotely, the car will be locked and the car will enter anti-theft status, the turn signals will flash once.

Activate the Anti - Theft on Vehicle Body

With the ignition switch at "OFF" position and release of door lock, if any door is opened forcibly or using an illegal key, the anti-theft system will be triggered, the horn will beep and the turn signals will flash for about 30s.

When the car is locked at anti-theft status by smart key, the immobilizer system will trigger horn sound and both turn signal lights will flicker for alarm within several seconds after the door on the driver's side is opened with the mechanical key.

Hint

Before the alarm is triggered or during an alarm, if  on the smart key is pressed or the Ignition switch is switched to -ON" position, the alarm stops and the car is unlocked. In an alarm cycle, the alarm can be triggered 10 times at most.

Anti-Theft on Engine

With the Ignition switch at "OFF", car body immobilizer system released and the smart key inside the car, if the Ignition switch is switched to -ON" position and the engine immobilizer system passes validation, the system will releases the engine anti-theft.

If it fails the validation, the engine cannot be started and anti-theft alarm will be triggered.

Maintenance Instructions for Car Body Anti-Theft

Normal use requires no maintenance. Contact authorized GAC MOTOR special store when a problem occurs.

4. Operating System and Equipment

4.3 Lights and Visual Field

4.3.1 Exterior Lights

Light combination switch

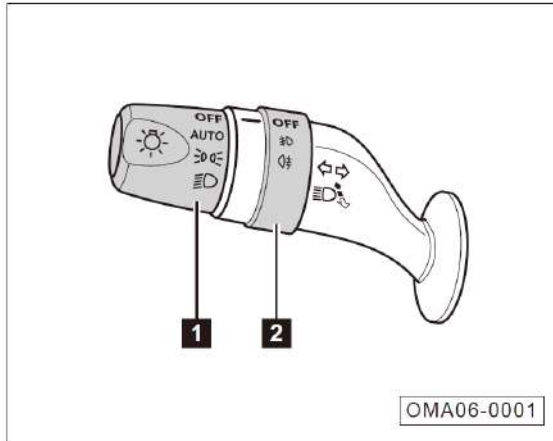

1. Light switch
2. Fog light switch

i Hint

After driving in rainy days or washing the car, frosting/fogging may occur on inner side of the light due to difference of temperature inside and outside the light. This is similar to fogging on window in rainy days and has not impact on the service life of the light. The fog can be eliminated by turning on the light. If a great quantity of water droplets or water is found inside the light, please contact the authorized GAC MOTOR dealer to have it checked and repaired.

Turn signal light

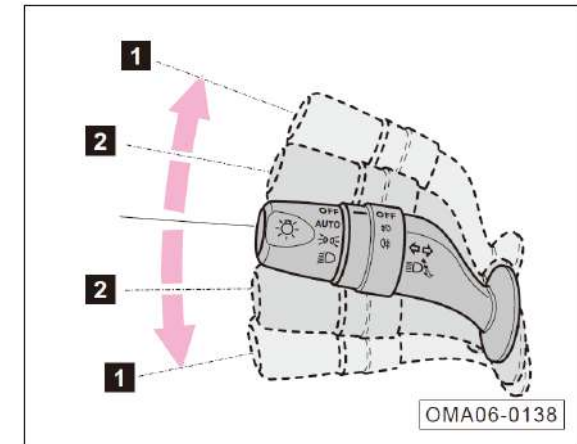

- With the ignition switch at "ON" position, by pushing the light combination switch up or down to position ①, the right or left turn signal is turned on, and ➡ or ⬅ in the instrument cluster flashes.

Lane Change Signal Light

- In the event of lane change or overtaking, by pushing the light combination switch up or down to position ②, and then releasing it to let it return to the original position, both the corresponding turn signal and ➡ or ⬅ in the instrument cluster flashes 3 times.

- By pushing the light combination switch up or down to position ② and keeping it at this position, the corresponding turn signal and also the ➡ or ⬅ in the instrument cluster flash continuously. If released to let it return to the original position, the flashing stops.

Caution

If any turn signal fails, flashing frequency of corresponding indicator ➡ or ⬅ in the instrument cluster will be doubled.

Light switch

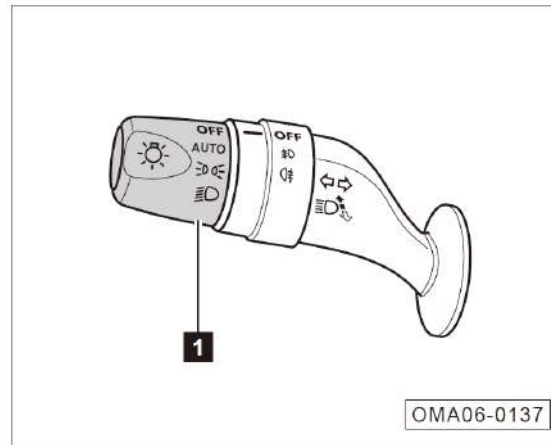

With the ignition switch at "ON" position, turn the light switch ① to turn on or off AUTO (auto lighting)*, ☼ (position light) or ☹ (low beam).

Turn the light switch to "OFF" to turn off all the lights.

AUTO (Auto Lighting)*

- Turn the light switch to "AUTO" position to turn on auto lighting.

i Hint

- After auto lighting enabled, lights of the car will be turned on or off depending on the environmental light. When the ambient lighting outside the car dims gradually, the position lights and low beams are turned on at the same time. When the ambient lighting outside the car brightens gradually, the position lights and low beams are turned off at the same time.
- Adjust the auto light sensitivity via "Vehicle Setting → Light Control → Auto Light Sensitivity" in the audio system.

4. Operating System and Equipment

Caution

- If the instrument cluster display "The sensor fails, please control the lighting manually", for the sake of safety, the system will keep low beams turned on. In this case, you should control the lighting manually, and go to an authorized GAC MOTOR special store to have your car checked and repaired.
- The auto lighting may be affected in heavily foggy or misty weather. Please manually control the lighting.



Daytime Running Light*

- With the engine started and the position lamp is not turned on, the daytime running lights can be automatically turned on. When the position lights are off or the engine stops work, the daytime running lights will be automatically turned off.

Hint

Activate or deactivate daytime running light via "Vehicle Setting → Light Control → Daytime Running Light" in the audio system.

Position light

- By turning the light switch to  position to turn on position lights, the position lights, instrument panel lighting lamp, number plate lights are turned on and  in the instrument cluster is on accordingly.

Hint

To save the battery capacity, if the position light is not turned off, when the Ignition switch is put to "OFF" position and the vehicle is not locked, the position light will automatically turn off after continuous illumination for 15min. When the Ignition switch is put to "OFF" position and the vehicle is locked, the position light will immediately turn off.

Warning

- Never turn on the position light alone when driving at night or in other road environment of low visibility. Otherwise, it can cause accidents easily.
- When the lighting is required to indicate the vehicle position during temporary stop due to flameout at night or in the road environment with poor visibility, do not use the position light as a parking light due to power saving function of the position light. The hazard warning indicator light shall be turned on for warning.

Low beam

- Turn the light switch to  position to turn on the low beams.

High beam

- After turn on the low beams, pushing forward direction of the car the light combination switch to position, high beams are turned on and  in the instrument cluster flashes.
- By pulling backward the light combination switch to the original position, high beams are turned off.

High Beam Flashing

- By pulling backward the light combination switch to position, the high and low beams are turned on.
- By releasing the light combination switch, it returns to the original position automatically and the high and low beams are turned off.

Hint

- High beams will dazzle the drivers of other vehicles nearby and result in accidents. Please use them properly.
- When all the lights are turned off and the light combination switch is pulled in the backward direction of the car, the high and low beams will be turned on and corresponding  in the instrument cluster will come on.

4. Operating System and Equipment

Manually Adjust Headlight Height

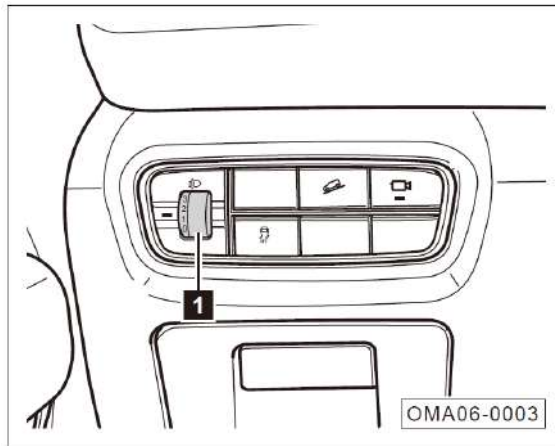

Turn the knob ① to manually adjust the range of headlights (low beams) at positions "0, 1, 2 or 3". The lighting height will decrease along with the increase of the adjusted value.

Position Light Reminder

After the Ignition switch is switched to "OFF" position, if the position lights are on when the door on driver side is opened, the system will raise the alarm of buzzing. Meanwhile, the alarm message "Light Not Off" appears on the instrument cluster display.

Headlight Lag Off (Follow Me Home) Function

Within 10 min after the Ignition switch is switched to "OFF" position, if the light switch is rotated from OFF position to another position and then back to OFF position within 2s, headlight lag off function is activated. The low beams will be on for 30s. If any door (including four doors, engine hood and hatchback door) is opened within this 30s, the time will be reset and the low beams will remain on for 80s. If all the doors are closed within this 80s, the time will be reset again and the low beams will remain on for 30s, and so on.

i Hint

Activate or deactivate Follow Me Home via "Vehicle Setting → Light Control → Follow Me Home" in the audio system.

Fog Light Switch

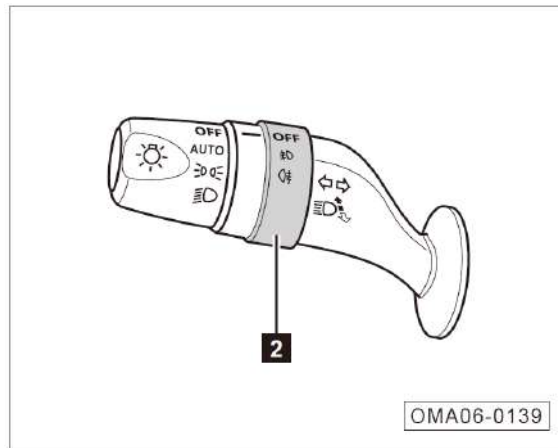

With the ignition switch or low beams at "ON" position and position lights turned off, turn the fog light switch ② to turn on or off ƒD (front fog light) * 0ƒ (rear fog light).

- Turn the fog light switch ② to ƒD to turn on the front fog lights*.
- Turn the fog light switch ② to 0ƒ position, and release it to let it return to ƒD position* to turn on the rear fog lights. Repeat these steps to switch between the mode of only front fog lights on and the mode of both front *and rear fog lights on.

- Turn the fog light switch to "OFF" to turn off all the fog lights.

i Hint

When the front* and rear fog lights are on, they can be turned off by turning the light switch to "OFF" position. In this case, the front *fog lights can be turned on again by turning the light switch to ƒD position, while the rear fog lights can be turned on again by using the fog light switch ②.

Hazard Warning Indicator Light

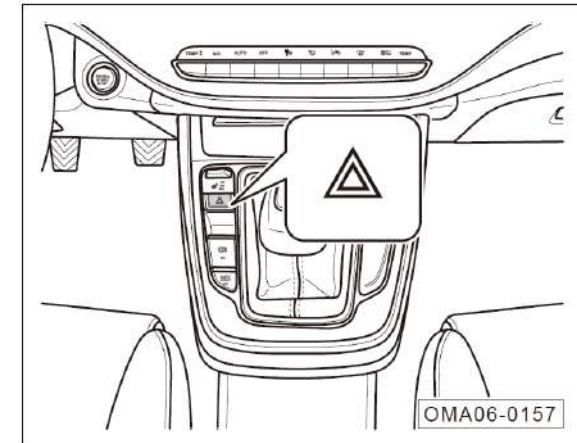

With the Ignition switch at any position, if \triangle switch is pressed, the red background light of the switch is flash, i.e. the hazard warning indicator light turned on. After the switch is pressed again, the light is turned off.

After the hazard warning indicator light is turned on, all the turn signals flash at the same time, together with \blacktriangleright and \blacktriangleleft in the instrument cluster.

4. Operating System and Equipment

In the following cases, use the hazard warning indicator light to attract the attention of other people on the road, so as to reduce the risk of accidents:

- In case of any car fault.
- At the end of traffic flow during traffic jam.
- Towing another vehicle or being towed.
- When it is necessary to warn the coming vehicle due to temporary stop in the environment with poor visibility.



Hint

- The hazard warning indicator light will consume battery. Turn them off if permitted.
- Follow the relevant laws and regulations when using the hazard warning indicator light.
- If the hazard warning indicator light fails in emergency, other warning means meeting the relevant traffic rules must be taken to attract attention of other people on the road.

Emergency Braking Warning Light

- During emergency braking at high speed, the brake light turns on, and the turn signal flashes at the same time.

Approach Light

- By pressing the  button on the smart key within the effective range, the position lights will be on for 25s as auxiliary lighting. If  unlock button on the smart key is pressed again, the position lights will be on for another 25s. If switching the Ignition switch to "ON" position, the position lights go out.

Lighting for Locating the Car

- If  on the smart key is pressed twice successively within 0.5s, the position lights will be on for 8s and the turn signals will flash 3 times so that the car can be located easily.

Intelligent Guest Greeting Light*

- When the ignition switch is at "OFF" position and all the doors are closed and locked, approach the car with smart key. When you are less than 3 meters to the car, the roof lights and atmosphere lights *are turned on automatically. These lights will go out automatically 25s later if any door is not opened, or you leave the car with the smart key.

Hint

Activate or deactivate the intelligent guest greeting light via "Vehicle Setting → Light Control → Intelligent Guest Greeting Light" in the audio system.

Caution

If the car engine is not started for more than 7 days, the intelligent guest greeting light function will be disabled automatically. After the car engine is started, the intelligent guest greeting light function will be activated again.

4.3.2 Interior Lights

Auto On Function of Roof Lights

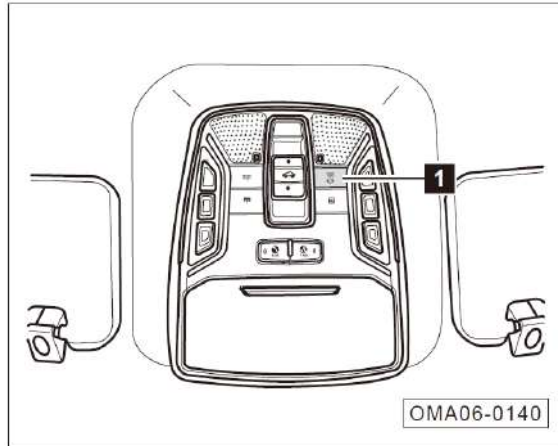

- Press the switch ① (down) to disable the Auto On function of the roof lights, and press the switch ① again (up) to enable the function.

Lag Off Function of Interior Lights

In the case that the Auto On function of roof lights is enabled with roof lights off:

- With the Ignition switch at "OFF", the roof light automatically turns on when any door is opened and turns off about 30s after the door is closed.
- With the Ignition switch at "OFF", the roof light automatically turns on and then turns off about 30s later when the door is unlocked by smart key.
- When the Ignition switch is switched from "ON" to "OFF", the roof light automatically turns on and then turns off about 30s later.

i Hint

With all doors closed and roof lights on in the above conditions, by lock the car with smart key or switching the ignition switch to "ON" position, the roof lights will go off automatically.

Roof Lights

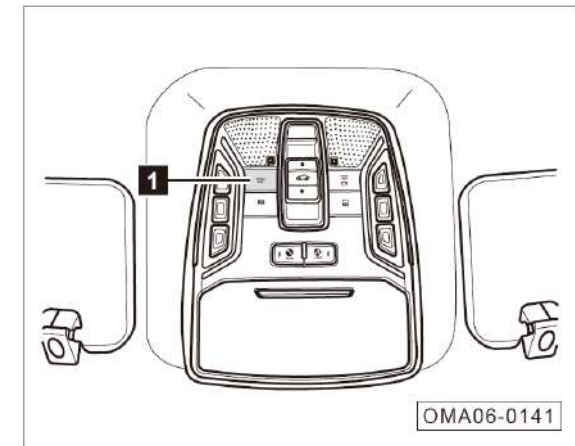

- When the roof lights are off, press the switch ① (down) to turn on the roof lights; and press the switch ① (up) again to turn off the roof lights.

i Hint

When the roof lights are not turned on via the switch ①, it is ineffective to press the switch ①.

4. Operating System and Equipment

Apply to panorama sunroof

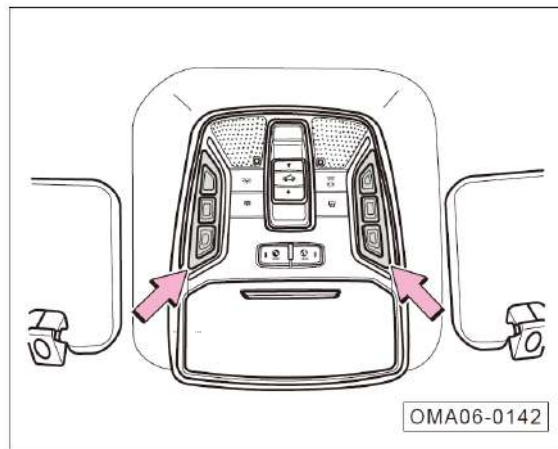

- When front roof lights are off, touch to turn on the front roof lights at corresponding side, and touch again to turn off the front roof lights at corresponding side.

i Hint

- The touching position should be close to the center area and the touching diameter should be greater than 12mm.
- If the front roof lights are not turned on by touching, touching is ineffective.

Apply to common sunroof

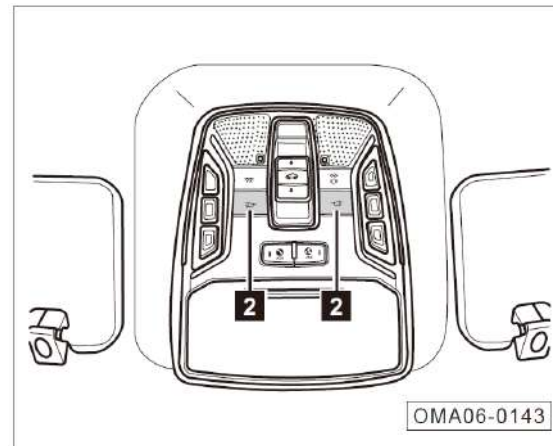

- When front roof lights are off, press the switch ② (down) to turn on the front roof lights at corresponding side; and press the switch ② (up) again to turn off the front roof lights at corresponding side.

i Hint

When the front roof lights are not turned on via the switch ②, it is ineffective to press the switch ②.

Second/third row roof light

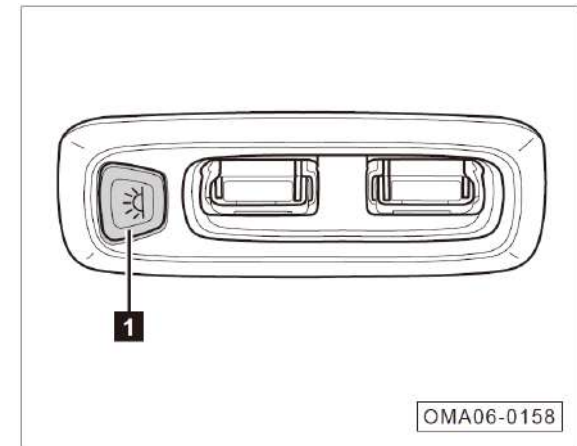

- When second/third row roof lights are off, press the switch ① to turn on the lights at corresponding side; and press the switch ① again to turn off the lights at corresponding side.

i Hint

When second/third row roof lights are not turned on via the switch ①, it is ineffective to press the switch ①.

Glove Box Light*

- By opening the glove box, the glove box light turns on automatically.
- By closing the glove box, the glove box light goes out automatically.

Trunk Light

- By opening the hatchback door, the trunk light turns on automatically.
- By closing the hatchback door, the trunk light goes out automatically.

Courtesy Light*

- When the door is opened, the courtesy lights go on automatically.
- When the door is closed, the courtesy lights go off automatically.

Vanity Mirror Light*

- The vanity mirror light automatically turns on when the vanity mirror cover is opened.
- The vanity mirror light automatically turns off when the vanity mirror cover is closed.

Atmosphere Light*

- When the position lights are on, the atmosphere lights go on automatically.
- When the position lights are off, the atmosphere lights go off automatically.

Hint

Activate or deactivate the atmosphere light via "Vehicle Setting → Light Control → Atmosphere Light" in the audio system.

AUTO: Automatic Wiping*

- If the wiper combination switch is pushed to ③ AUTO position to turn on the automatic wiper function, and the wiper system will adjust the wiping speed based on the current rainfall and real-time vehicle speed.
- Activate or deactivate the auto wiping function via "Vehicle Setting → Smart Body → Auto Wiping Function" in the audio system. When the function is deactivated, the wipers work in the same way at "AUTO" position and "INT" position.

Caution

- If the instrument cluster displays "The sensor fails, please control the wiper manually", for the sake of safety, in this case, you should control the wiper manually, and go to an authorized GAC MOTOR special store to have your vehicle checked and repaired.
- Before auto wiping in winter, make sure whether the wiper blades are frozen.

Caution

- It is suggested to disable the auto wiping function during car washing and in dust weather or rainless weather to prevent damage or injury due to inadvertent wiping.
- Auto wiping is an auxiliary function. The driver should operate the wipers manually depending on the driving condition to ensure safe driving.

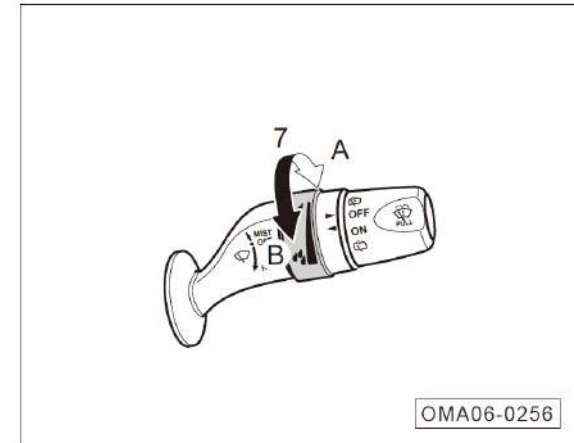

- Rotate the knob ⑦ up/down to adjust the wiper sensitivity.
- A: Increase the wiper sensitivity.
- B: Reduce the wiper sensitivity.

4. Operating System and Equipment

INT: Intermittent Wiping*

- If the wiper combination switch is pushed to ③ INT position, the front wipers will work intermittently at a certain frequency.
- For models with auto wiping function, switch to the intermittent wiping mode via "Vehicle Setting → Smart Body → Auto Wiping Function" in the audio system.

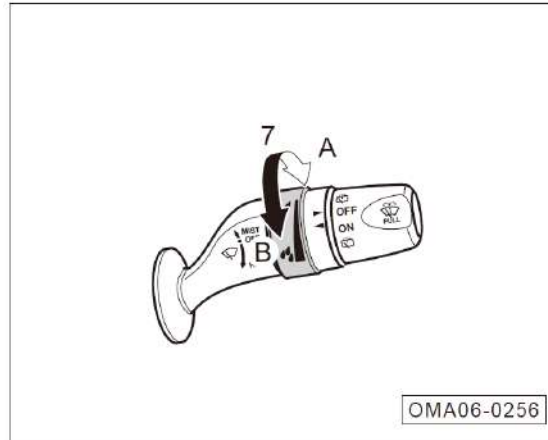

- Rotate the knob ⑦ up/down to adjust the intermittent wiping speed.
- A: Increase the intermittent wiping speed.
- B: Reduce the intermittent wiping speed.

LO: Low-Speed Wiping

- If the wiper combination switch is pushed to ④ LO position, the front wipers will work at a low speed.

HI: High-Speed Wiping

- If the wiper combination switch is pushed to ⑤ HI position, the front wipers will work at a high speed.

Turning on Front Windshield Washer System

- If the wiper combination switch is pulled in the backward direction of the car to position ⑥, the front washer starts to jet water and the front wipers wipe a little later.
- If the wiper combination switch is released to let it return to the original position, the front windshield washer system is off and the front wipers wipe once after 6s.
- After a pause of 6s, the front wipers operate once to remove residual water stains on the glass.

Turning on Rear Windshield Washer System

- When the hatchback door is closed and the rear wiper knob is rotated up/down to position ⑧ , the washer starts to jet water and the rear wiper starts to wipe. When the rear washer is switched off, the rear wiper stops wiping and wipe once after 6s.

ON: Rear Wiper On

- When hatchback door is closed, if the rear wiper knob is turned to ⑩ ON, the rear wipers begin to work.

OFF: Rear Windshield Washer or Rear Wiper Off

- If the rear wiper knob is turned to position ⑨ OFF, the rear windshield washer system will be closed, or the rear wipers will stop work.

Front Wiper Maintenance

- Within 10s after the Ignition switch is switched to "OFF" position, if the wiper combination switch lever is pushed to MIST and then pulled back rapidly, the front wipers will move to the highest positions and then stop.

Hint

Activate or deactivate the front wiper maintenance function via "Vehicle Setting → Smart Body → Front Wiper Maintenance" in the audio system.

4. Operating System and Equipment

4.3.4 Windshields

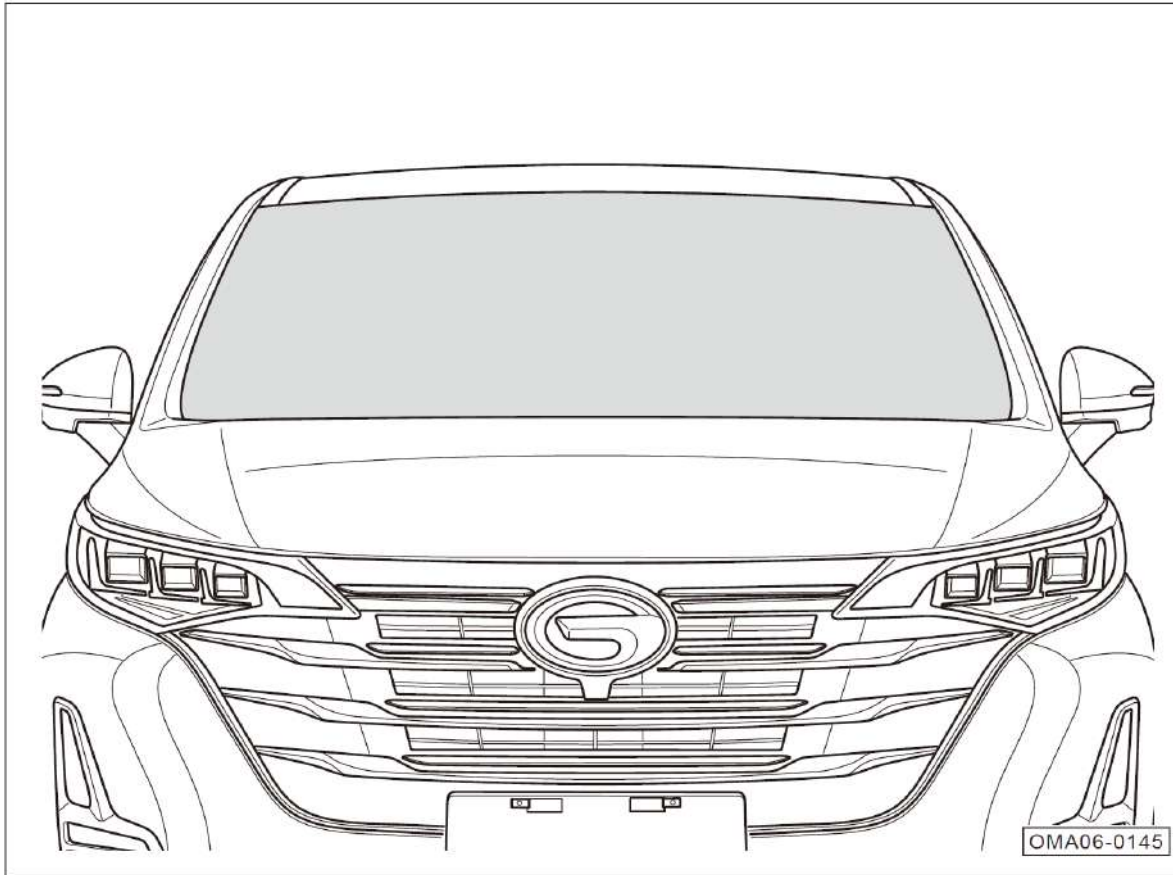

Windshield

The front windshield, of green, insulated, laminated and anti-scattered glass, can effectively reduce the risk of injury during a crash.

Warning

- Always keep the windshield clean.
- Stick certificates to the windshield in accordance with local traffic regulations. Do not apply irrelevant stickers or attach articles to the front windshield. They may obstruct driver's view and could result in accident.

4.3.5 Rear-View Mirror

Interior Rear-view Mirror

Automatic Anti-Glare Interior Rear-view Mirror*

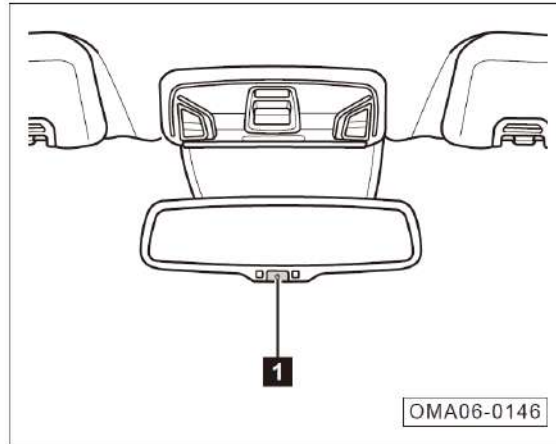

The light sensor of automatic anti-glare interior rear-view mirror can monitor light rays behind and ahead of the car to reduce the intensity of reflection of light rays coming from behind the car and provide excellent rear view.

- When Ignition switch is "ON", the auto anti-glare function starts automatically, and the switch light turns on. Press the switch ① to manually enable or disable it. The switch indicator light turns off during enabling.

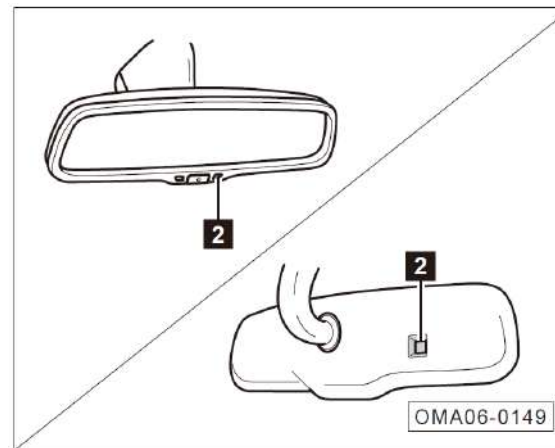

⚠ Caution

To guarantee that the light sensor function is normal, do not cover the light sensor ②.

i Hint

If the temperature in the car is low, it could take a little longer time for the anti-glare rear-view mirror to respond to intense light rays.

Manual Anti-Glare Interior Rear-view Mirror*

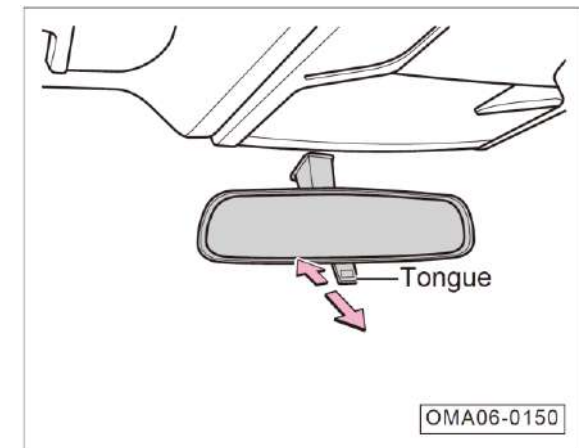

By manually adjusting the manual anti-glare interior rear-view mirror, the intensity of reflection of light coming behind the car can be reduced to provide excellent rear view.

- As shown in the figure, if the tongue is at the normal rear-view angle, move it forward to bias reflection of light coming behind the car and achieve anti-glare effect.
- Then move the tongue backward to adjust back to the normal rear-view angle.

4. Operating System and Equipment

Exterior Rear-View Mirror

Warning

The exterior rear-view mirrors with curved surface (convex and spherical) are able to expand view, but compared with the real objects, their reflected images are smaller and further. Do not judge the distance from the rear vehicle based on its reflected image when changing a lane, doing so can cause accidents due to misjudgment.

Hint

If the function of the exterior rear-view mirror fails, please go to your authorized GAC MOTOR special store as soon as possible to have your car checked and repaired.

Power Adjustment

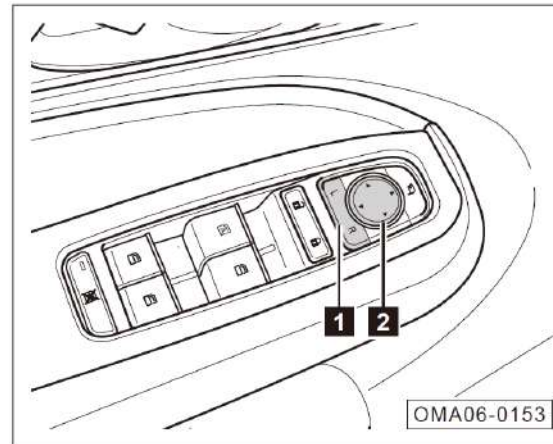

- Press L or R on the exterior selection button ① (select left or right exterior rear-view mirror).
- Press the adjusting button ② to adjust the selected exterior rear-view mirror to an appropriate rear-view angle.
- After the rear-view mirrors are adjusted, return the selection button ①.

Power Folding-Up*

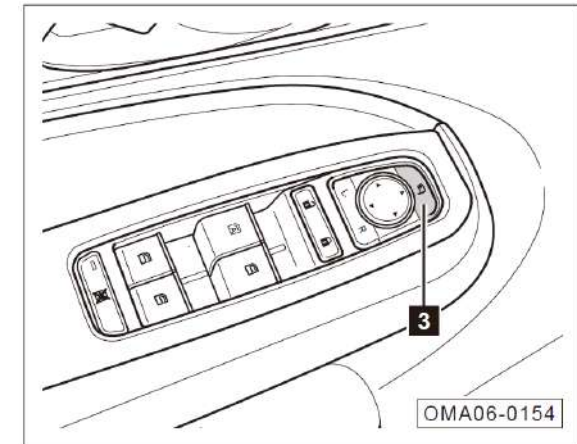

- When the folding-up button ③ is pressed, the exterior rear-view mirrors fold.
- When the folding-up button ③ is pressed again, the exterior rear-view mirror unfolds.

Automatic Folding-Up*

- If the car is locked from outside, the exterior rear-view mirrors can be folded up automatically.
- If the car is unlocked from outside, the exterior rear-view mirrors can be unfolded automatically.

Hint

Activate or deactivate exterior rear-view mirror automatic folding via "Vehicle Setting → Smart Body → Exterior Rear-view Mirror Automatic Folding" in the audio system.

Caution

- If the exterior rear-view mirror is not equipped with power folding function or the power folding function fails, manually fold it. After that, please manually unfold it. In case of manual unfolding, clicks can be heard.
- Special attention should be paid not to make your fingers injured by the rear-view mirror or its base when an exterior rear-view mirror is folded.

Defogging Function*

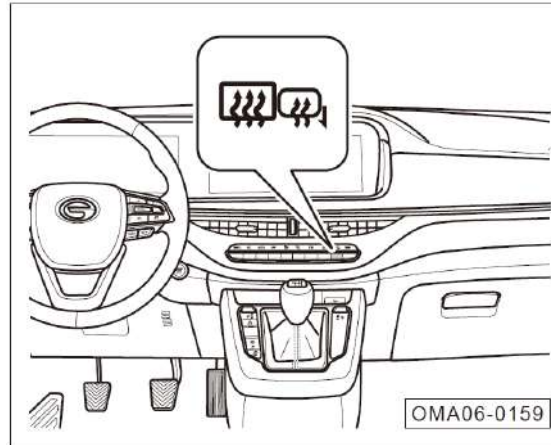

- Pull/Push  button, the indicator light of the button is on and the heating function is enabled to remove fog or frost from exterior rear-view mirrors and rear windshield.
- This function will be disabled automatically about 15 minutes later or it can be disabled manually by pull/push the button again during heating. When the heating function is disabled, the indicator light goes out.

Caution

- If defogging/defrosting is necessary after the defogging function is automatically disabled, lift/press the  button again.
- Do not have the defogging function operating for a long time. This could cause overheating or damage to the heater.
- To save battery power, press the button to disable the defogging/defrosting function when it is unnecessary.

4. Operating System and Equipment

4.3.6 Sun Visor

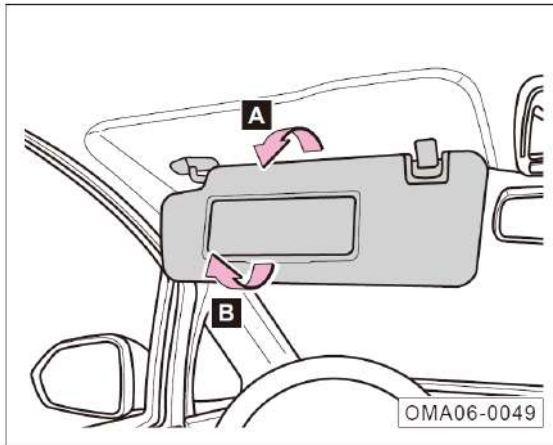

- Pull down the sun visor on the driver side or the front passenger side in the direction of arrow A to block sunshine coming in through the front windshield.
- To use the vanity mirror, pull down the sun visor, and then open the vanity mirror cover in the direction of arrow B. The vanity mirror light* goes on automatically at the same time.

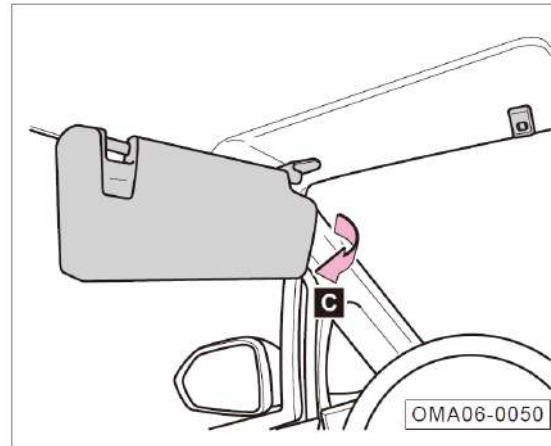

- Draw out the sun visor on the driver side or the front passenger side from the movable support on one side in the direction of arrow C to block sunshine coming in through the side windows after it is pulled down.

i Hint

The vanity mirror light* will go off automatically several minutes after the ignition switch is at "OFF" position or the car is locked.

4.4 Seats and Storage Devices

4.4.1 Headrest

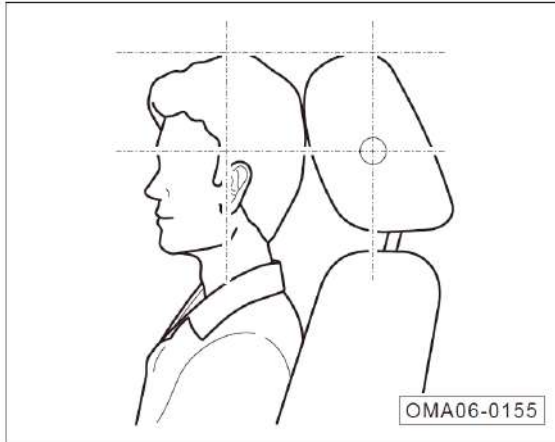

Adjusting the headrests properly is of great importance to protect the driver and passengers and reduce the risk of casualty.

All the drivers and passengers must adjust their headrests to correct positions (as shown in the figure) according to their own body types.

⚠ Warning

To reduce the risk of injuries and deaths during accidents, be sure to observe the following matters:

- While driving, do not adjust the headrests.
- It is not allowed to drive after the headrest is removed. If the driver drives after the headrest is removed or the headrest is installed improperly to cause an accident, the driver's and passengers' heads cannot be effectively protected.

Adjusting Front Seat Headrests

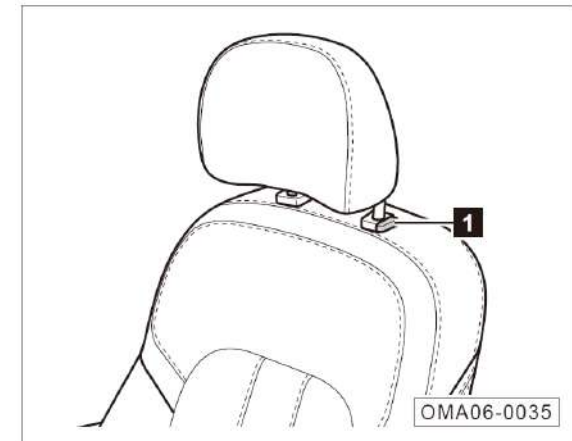

- Lower: Press and hold the locking button ①, and lower the headrest to the desired position.
- Raise: Directly raise the headrest to the desired position.

i Hint

The other headrests are adjusted in the same way.

4. Operating System and Equipment

4.4.2 Front Seats

Hint

When measuring the depth of seat cushion, adjust the seat to the middle of the sliding rail and adjust the seat backrest to serviceable condition (25°).

Warning

- Never place any objects under the front seats. Otherwise, these objects may be jammed between the seat and guide rail, hindering seat locking.
- It is not allowed to adjust the front seat during travel.
- When adjusting the seat forward or backward, please pay attention to the front-back distance to prevent from personal injury due to excessive adjustment.
- After the Ignition switch is switched to "OFF" position, the electric adjusting mechanism of seats* still works. Never leave a child alone in the car to prevent her/him from improper operation of electrical seats and causing accidents.

Power Seat*

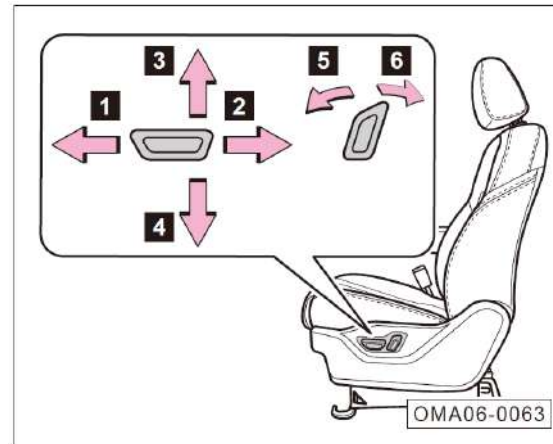

Forward/Backward adjustment of seat:

- Move the switch in the direction of arrow ① or ② to slide the seat forward or backward.

Up/Down adjustment of seat:

- Move the switch in the direction of arrow ③ or ④ to raise or lower the seat.

Forward/Backward adjustment of backrest:

- Move the switch in the direction of arrow ⑤ or ⑥ to tilt the backrest forward or backward.

Manually Adjustable Seat*

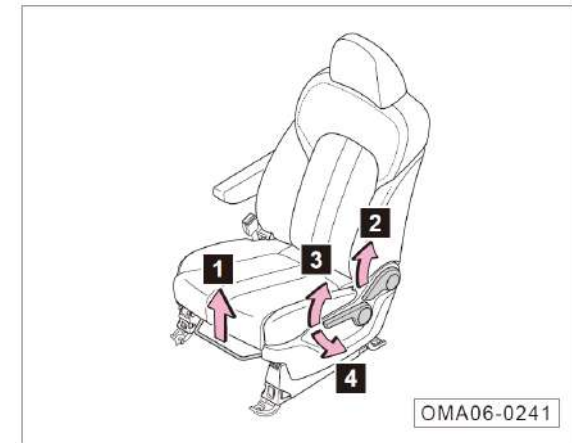

Forward/Backward adjustment of seat:

- Pull up the adjusting handle in the direction of arrow ① to slide the seat forward or backward. Release the adjusting handle, and slide slightly the seat forward or backward until the seat lockup is firmly.

Forward/Backward adjustment of backrest:





- Pull up the adjusting handle in the direction of arrow ② to adjust the backrest to proper position and then release the handle.

Vertical adjustment (just driver's seat)*:

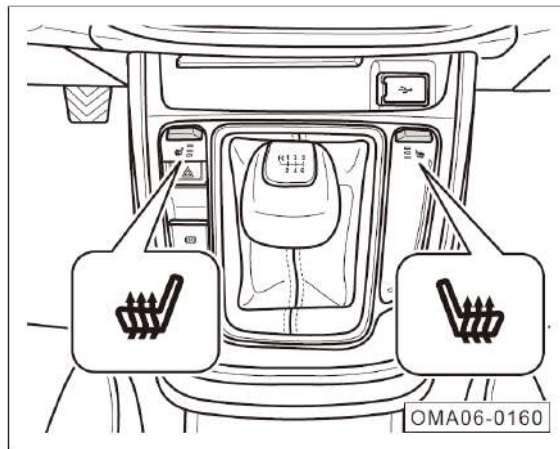
- Move the switch in the direction of arrow ③ or ④ to raise or lower the seat.

Seat Heating*



- Switch the ignition switch to "ON" position.
- Short press  /  backward to turn on the button light and start heating the corresponding seat.
- Long press  /  backward for about 1.5s to directly deactivate the heating function and turn off the button light.

There are three seat heating positions: position 3 for the highest temperature, position 2 for the second highest temperature, and position 1 for the lowest. Press the key backward and the gear will change for one level with the order of 0→3→2→1→0 cyclically, and the number of illuminated key indicators will also change.

If pressing the corresponding side heating key backward during the automatic heating process, the automatic heating will be exited and the gear will be changed by one level based on the current gear.

Hint

Activate or deactivate automatic ventilation and heating via "Vehicle Setting → Seat Setting → Auto Heating" in the audio system.

Warning

If you are sensitive to the temperature change due to seat heating, never use seat heating function, to avoid burning by the heater.

Caution

- To avoid damage to electrical components inside the seats, never knee on the seat or apply force to some point of seat cushion and backrest.
- If you cannot feel the seat temperature change or feel hot after being heated for a long time, immediately disable seat heating and go to authorized GAC MOTOR special store for inspection and maintenance.

4. Operating System and Equipment

4.4.3 The Second/Third Row Seats

The Second Row Seat

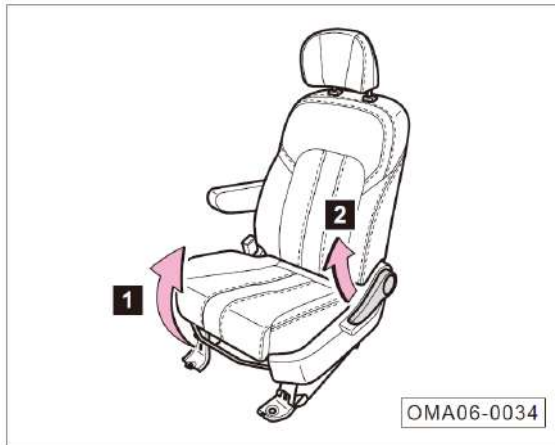

Forward/Backward adjustment of seat:

- Pull up the adjusting handle in the direction of arrow ① to slide the seat forward or backward. Release the adjusting handle, and slide slightly the seat forward or backward until the seat lockup is firmly.

Forward/Backward adjustment of backrest:

- Pull up the adjusting handle in the direction of arrow ② to adjust the backrest to proper position and then release the handle.

Third Row Seat Folding

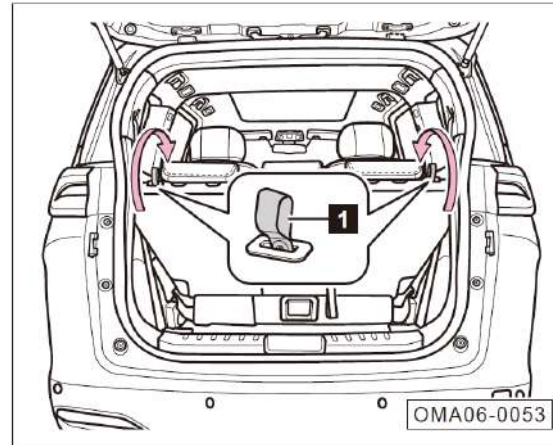

- Unbuckle the third row middle seat belt.
- Lower the third row seat headrest to the lowest position.
- Pull the cable ① to unlock the third row seat backrest, and lay it down forward.

i Hint

Pull the cable ① to unlock the third row seat backrest, and then adjust its angle.

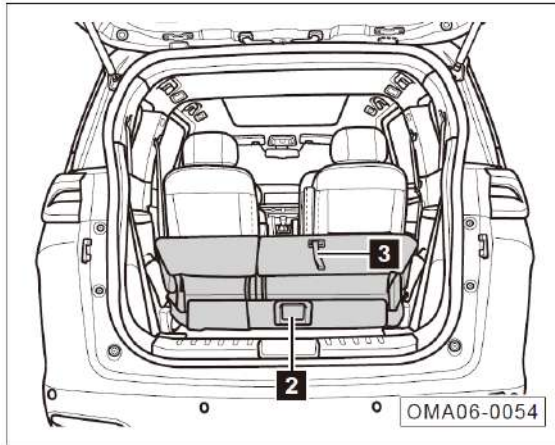

- Pull the cable ② to unlock the third row seats, and pull the cable ③ to flip them backward as a whole at the same time.

Caution

Before folding the third row seats, please empty the trunk articles, including warning triangle and towing hook. Otherwise, the seats cannot be fixed after flipping.

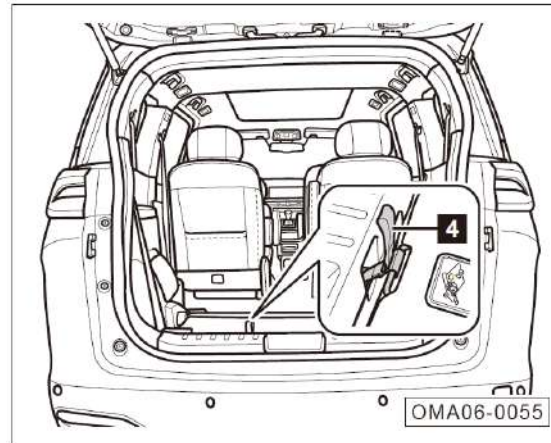

- Press the third row seats, pull the cable ④, and hook the fixed hook on the third row seats.

Hint

Unfold the third row seats in the reverse order.

4. Operating System and Equipment

4.4.4 Storage Devices

Storage Sink in Door Interior Trim Panel

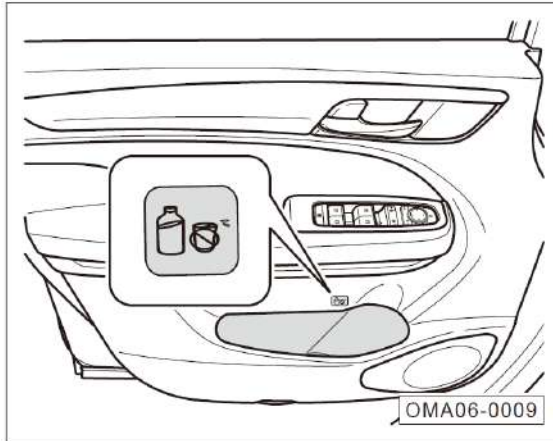

- For storage of such articles as beverage bottles, maps and manuals.

Storage Shelf for Lower Panel in the Cab

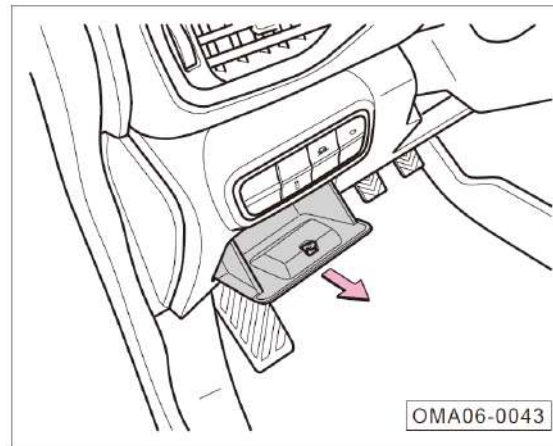

- Open the storage shelf for lower panel in the cab in the direction of the arrow for storage of small articles.
- Push it back, and close it after it clicks.

Front Row Storage Sink

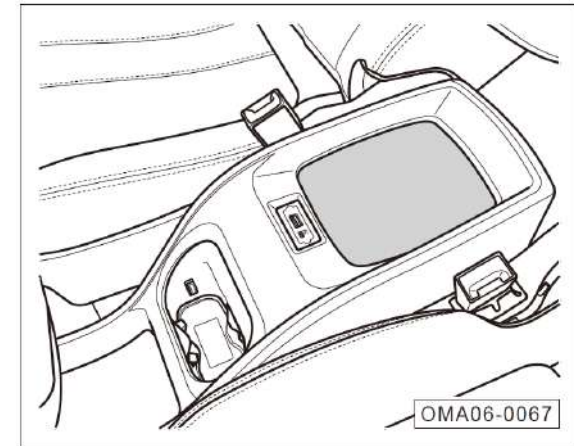

- Small articles may be placed in it.

i Hint

Certain models are equipped with mobile phone wireless charging function*, so the area may be taken as the charging area. Articles may be placed after the mobile phone wireless charging function is disabled.

Storage Sink under Instrument Panel

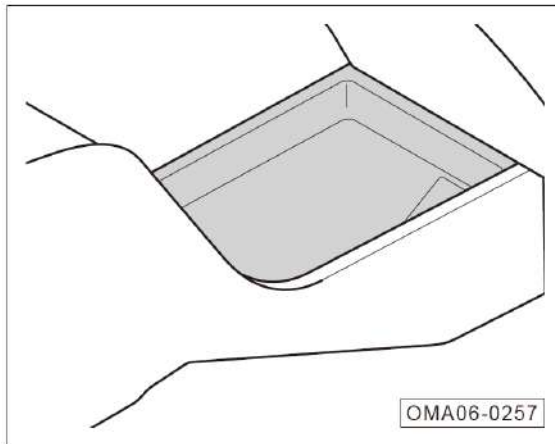

- Small articles may be placed in it.

Warning

Do not place the items that are easy to roll on the storage sink under the instrument panel to prevent the items from rolling to the pedal area. During emergency braking, it may hinder the pedal movement to cause an accident.

Storage Sink on Instrument Panel

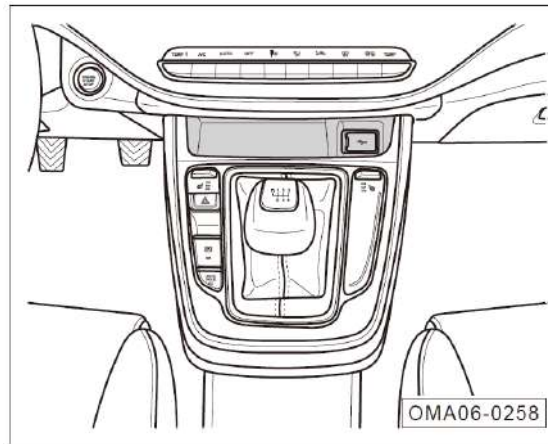

- Small articles may be placed in it.

Second Row Storage Sink



- Small articles may be placed in it.

4. Operating System and Equipment

Cup Holders

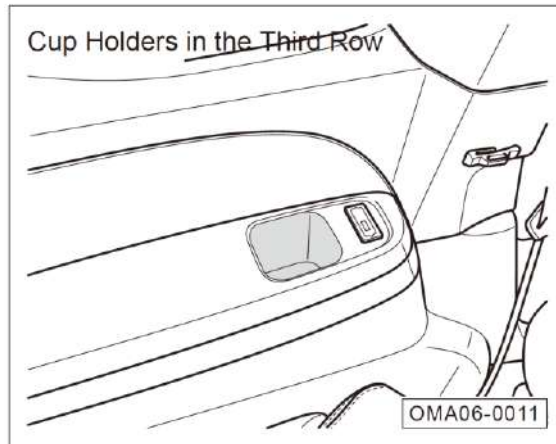
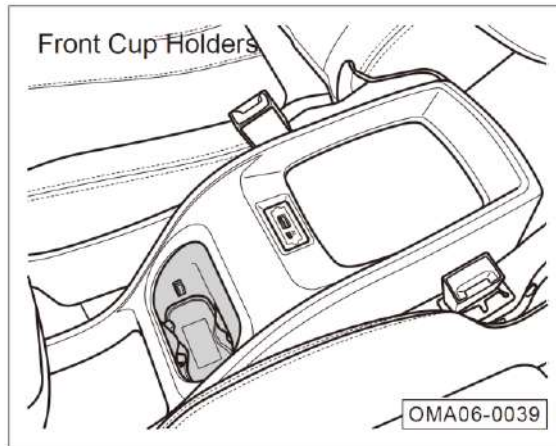

- The beverage bottle can be placed in it.

Warning
Never place any hot beverage bottle in cup holders to avoid scalding due to splashing during traveling.

Glasses case



- Press the glasses case to open it gradually for storage of small articles like sun glasses.
- Push back the glasses case, and close it until it clicks.

Glove Box on Front Passenger Side

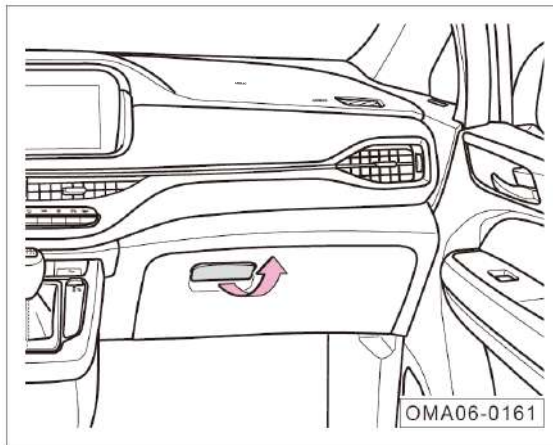

- Pull the opening handle to open the glove box for storage of articles such as file bag.
- Push back the glove box until it clicks to close it.

Warning

Always keep the glove box closed while driving. Otherwise, articles inside the glove box may be thrown out, injuring your passenger in a crash or emergency braking.

Seat Backrest Storage Bag

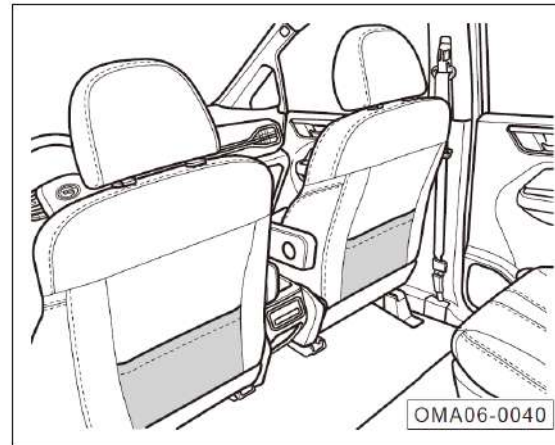

- Pull back and open the storage bag for storage of such articles as books and foldable umbrella.

Reflective Vest

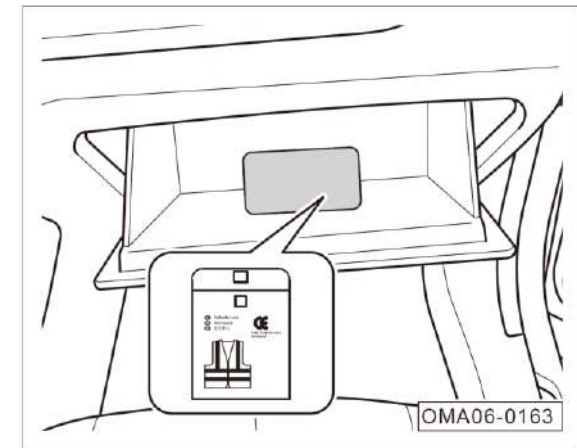

- Take the reflective vest out of the glove box if the car should be parked due to any car accident or other faults.

4. Operating System and Equipment

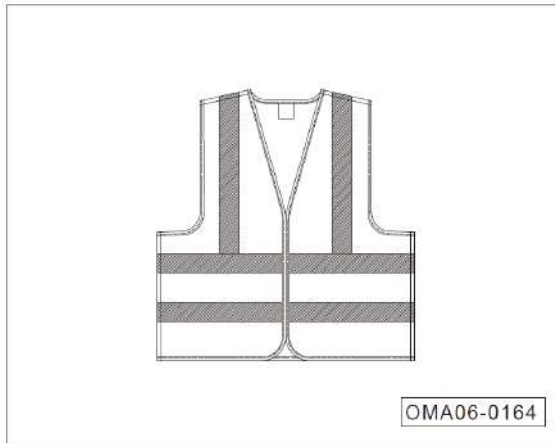

- Wear the reflective vest.

i Hint

- During accident handling, wear the reflective vest as required irrespective of the lighting conditions to draw attention of the passerby or other drivers.
- After using the reflective vest, return it to the glove box properly, or wash it when necessary as per the notes on the collar to ensure reflecting performance.

Microwave Window

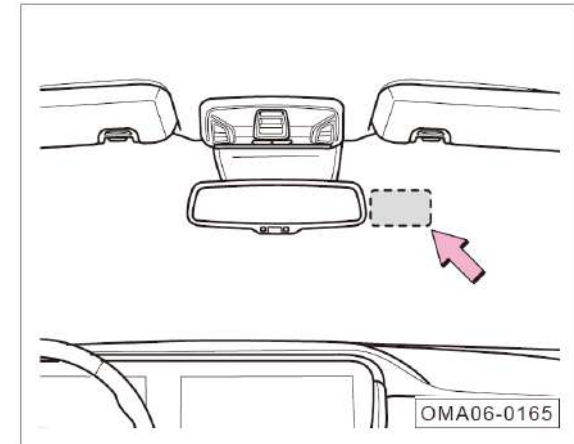

- The microwave window is on the right side of the front windshield corresponding to the interior rear-view mirror.

i Hint

The microwave window can be used for installing ETC card.

AUDIO system USB interface

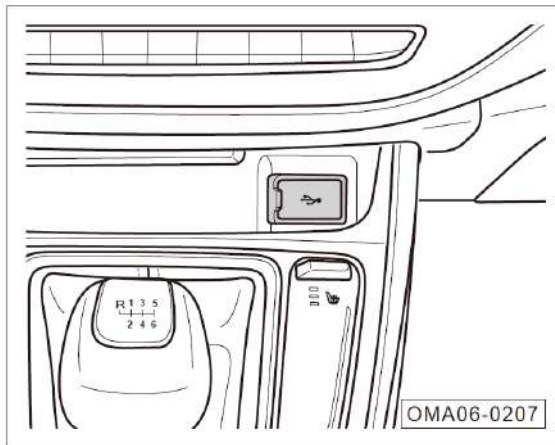

- Open the cover, and connect the equipment successfully. The AUDIO system can be switched to the USB playing source.

4. Operating System and Equipment

4.4.5 Power Outlet

Front Power Outlet

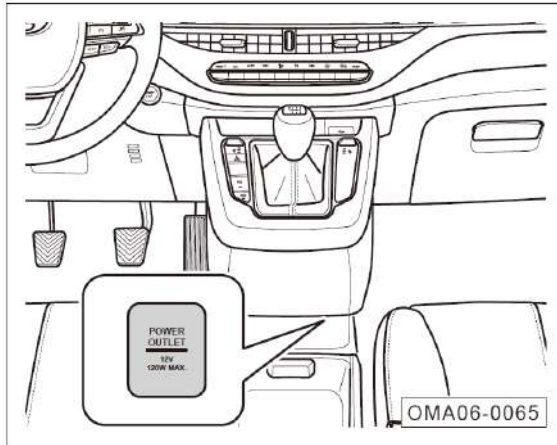

- With the ignition switch at "ACC" or "ON" position, connect the charged device to the front power outlet after pulling up the rear power outlet cover.

USB Power Outlet

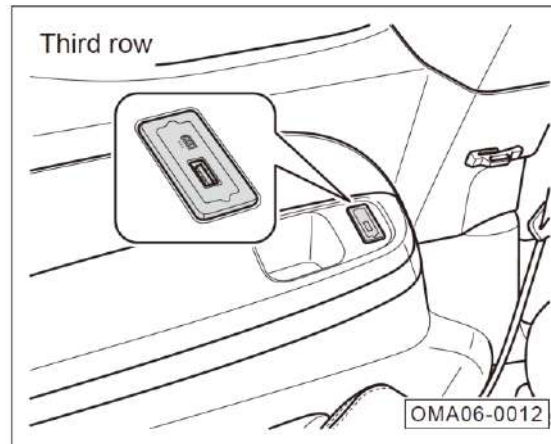
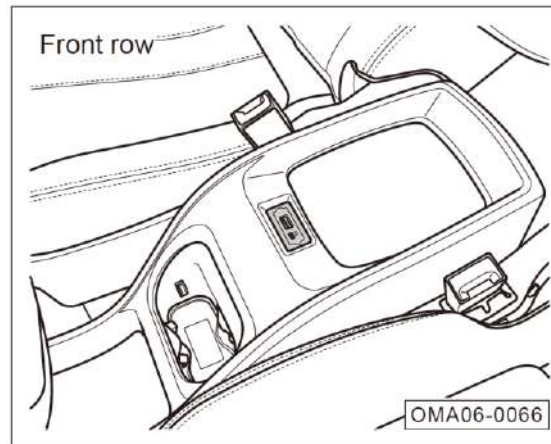

- With the ignition switch at "ACC" or "ON" position, connect the charged device to the USB charging port.

Trunk Power Outlet

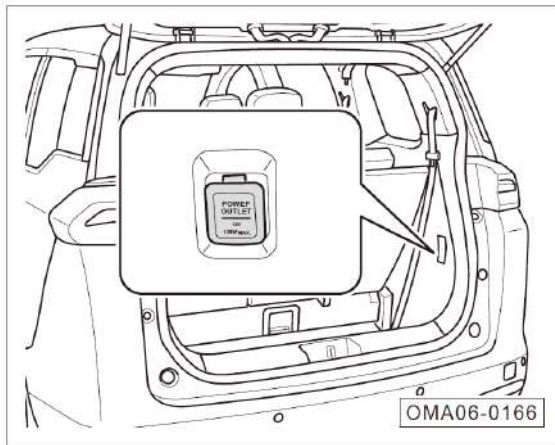

- With the ignition switch at "ACC" or "ON" position, connect the charged device to the rear power outlet after pulling up the rear power outlet cover.

Caution

- To avoid damage to the electrical system, do not connect any generating equipment to the power outlet.
- Use only electrical equipment in line with the national electromagnetic compatibility norms.
- To switch the ignition switch to "ON" or "OFF", disconnect the charged device from the power outlet to avoid damage to electrical equipment due to voltage fluctuation.

Warning

- It is not allowed to use the power outlet when nobody is in the vehicle. Improper use of power outlet can cause fire.
- Do not let a child operate a power outlet.
- It is not allowed to use the electric equipment with high power.

4. Operating System and Equipment

4.4.6 Mobile Phone Wireless Charging System*

The mobile phone wireless charging system realizes wireless charging through electromagnetic induction, without wire connection.

Caution

Mobile phone wireless charging system does not apply to all mobile phones. It only applies to the mobile phones with -Qi- certificate. In case that any accident is caused by using the mobile phones and charging receivers without -Qi- certificate, our company shall not bear any liability or loss caused therefrom.

Mobile Phone Wireless Charging Switch

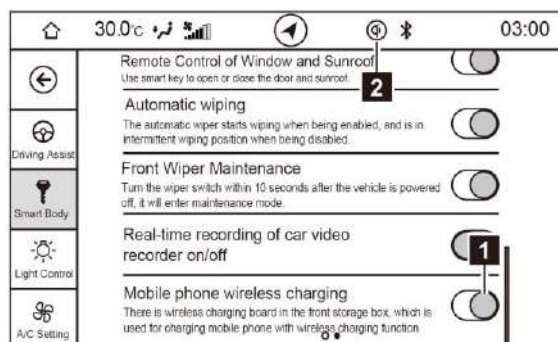

With the ignition switch at "ON" position, enter "Vehicle Setting → Smart Body → Mobile Phone Wireless Charging" in the audio system:

- Click the slider ① to enable or disable the mobile phone wireless charging system.

i Hint

When the mobile phone wireless charging system is enabled, a symbol will be displayed at position ② in the interface. The symbol status will change according to use of the system.

Symbol Status

Symbol	Color	Status	Hint
ⓐ	White	Standby	—
ⓑ	Green	Charging	By clicking the symbol, "Mobile phone being charged" will be shown.
ⓒ	Green	Fully charged	By clicking the symbol, "Mobile phone fully charged" will be shown.
ⓓ	Red	Charging fault	By clicking the symbol, relevant fault information will be shown. Please refer to "Mobile Phone Wireless Charging Fault".

Mobile Phone Wireless Charging Fault

Abnormal Scenario	Content of Prompt
Internal over-temperature of wireless charging module	Over-temperature, please remove your phone and try again later
Existence of foreign metal article in the placement area of wireless charging module	Foreign metal article existing, please remove it and place your mobile phone again
Power supply voltage of wireless charging module too low or too high	Abnormal voltage, please remove your phone and try again later
Charging power requested by the receiving end too high, or transmitting power of wireless charging module too high	Abnormal power, please remove your phone and try again later
Abnormal status at the receiving end	Charging interrupted, please remove your phone and try again later

Hint

- Only one mobile phone can be charged at a time.
- To ensure normal charging of mobile phone, make sure that the center of the mobile phone is aligned with the Qi logo in the front storage box as far as possible.
- For AT models, opening a door will interrupt the charging function. Make sure that all the doors are closed during charging.
- While the vehicle is running on a bumpy road, mobile phone wireless charging could interrupt intermittently then resume. If the charging stops due to mobile phone departure from the charging area, move the mobile phone back to the charging area.
- Any fault of the system or the mobile phone may result in a failure to charge.
- The mobile phone charging may stop at too high temperature, and resume charging after the temperature drops.

Caution

- Do not place anything between the mobile phone and the charging panel during charging. Non-metallic articles may degrade the charging performance. Articles such as magnetic cards or chip cards may be damaged. Foreign metal articles such as keys and coins may be heated, posing a driving safety hazard.
- Disable the wireless charging function before placement of any foreign metal article in the front storage box. Otherwise, the metal article may slide into the charging area and be heated during driving, posing a safety hazard.
- During mobile phone wireless charging, if any foreign metal article is found between the mobile phone and the rubber pad, do not remove it immediately to prevent finger burning. In this case, immediately disable the system, and remove the article after cooling.
- Please never sprinkle water in charging area, lest the water enters wireless charger module through the clearance of rubber pad to cause wireless charger module faults.

4. Operating System and Equipment

Warning

- When driver is not in the car, please do not place mobile phone inside for charging, so as not to cause potential safety hazards.
- Please do not check the mobile phone charging status frequently in driving, to avoid potential traffic danger.
- Please do not place weight in charging area to avoid damage to the mobile phone wireless charging system.
- If there is any problem in the product and it cannot be used normally, please stop operation and go to the authorized GAC MOTOR special store to have it checked and repaired.
- Our company shall not be liable for any problem due to abnormal operation (e.g., connection to external wireless charging coil). If the product has ever been unpacked or modified, free warranty service will be terminated.

4.4.7 Trunk

To ensure operation stability of the car, items shall be distributed in the trunk as even as possible, and heavy items shall be placed in the front portion of the trunk.

Warning

- The center of gravity of the car may change if heavy items are loaded. If the heavy items in the trunk slide suddenly, the operation stability of the car will change.
- The items in the trunk must be fixed. Otherwise, they may fly forward to injure you or your passengers in a crash or emergency braking.
- Never put items that are fragile, flammable or explosive in the trunk.

Trunk Capacity

- Third seat can be put down to increase the trunk capacity. => Refer to Page 94

Caution

Ensure that any liquid container in the trunk is securely sealed to prevent leakage. Do not place the container on the folded seat to prevent liquid leakage wetting the seats.

Trunk Accessories

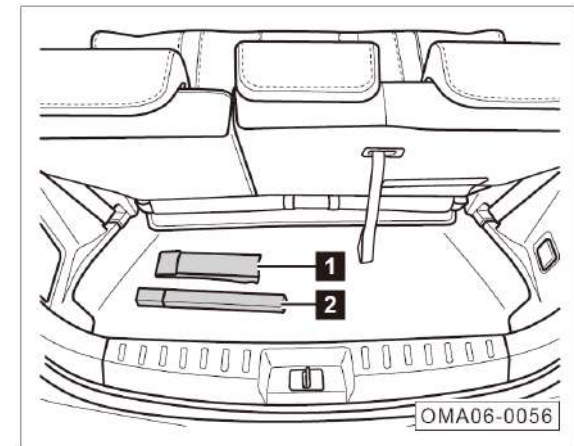

- The towing hook ① and warning triangle ② are provided in the trunk.

4. Operating System and Equipment

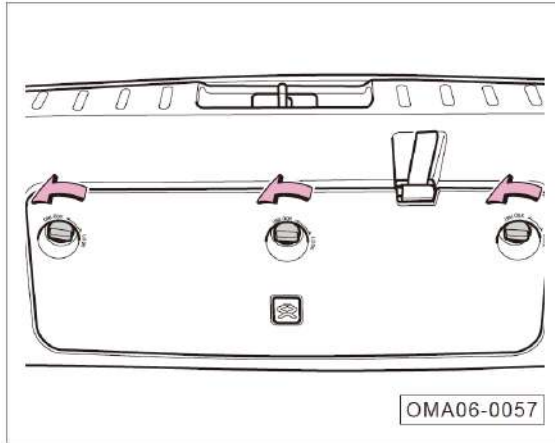

- Turn the 3 buckles to UNLOCK position to unlock the trim panel.

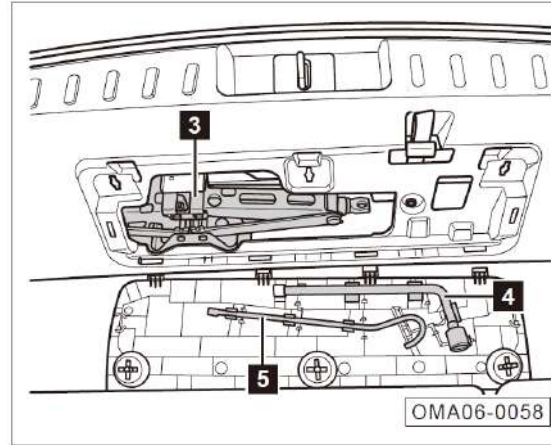

- Take down the trim panel. The jack ③, wheel bolt removal wrench ④ and special wrench for jack ⑤ are provided.

4.4.8 Accessories and Modifications

The data labels and signboards attached to the fuel tank lid, engine hood lock rack and other vehicle components of the car, when delivered, contain important data and information on car operation. Do not remove or damage such labels and signboards. Always keep the data and information on the labels and signboards clear and readable.

This car is designed with the latest safety technique to ensure excellent active safety and passive safety. Therefore, to maintain the car's excellent features, before installing accessories or replacing components, be sure to consult authorized GAC MOTOR special store.

We recommend you always use the accessories and components which have been designed and approved for your car. We are not responsible for any component not manufactured by us.

Warning

Improper accessories or modifications may affect your car's operation stability and other performance, and may lead to severe injury or death.

If car phone, alarm device, two-way radio equipment, and low-power AUDIO system need to be installed, they should not interfere with your car's computer control system, such as ABS and TPMS.

Before installing any accessory:

1. Make sure that the accessory does not dim any light, or affect normal operation or performance of the car.
2. Do not install accessories on the B pillar or across the rear windows for cars equipped with integrated side airbag curtain, because accessories installed in these areas may interfere with normal operation of side airbag curtain.

Hint

For installation of boutiques (such as headrest, seat cover, foot mat and sun cover pad), inferior boutiques may influence the air quality in the car due to VOC not complying with national standards and emission of abnormal odor. It is suggested to select high-quality OEM parts to ensure a comfortable driving environment.

4. Operating System and Equipment

Modifying Your Car

Removing components from your car, or replacing components with non-GAC MOTOR model components could seriously affect your car's operation stability and reliability. For example:

- Installing larger or smaller wheels and tires can interfere with normal operation of ABS and other systems.
- Modifying the steering wheel or any other safety facility may lead to system failure.

Warning

- Improper accessories or modifications can easily cause faults and accidents. We recommend you always use the approved accessories and components with strictly-verified adaptability, reliability and safety by GAC MOTOR.
- Improper maintenance or modifications can weaken the protection from airbags, and cause system failure and fatal accidents. Do not install or connect the beverage cup holder, phone holder and other accessories onto the cover of airbag assembly or in the range of action of airbags.
- Improper operation or modifications (modification of the engine, brake system or components affecting the performance of the wheels and tires) can affect the function of the SRS system, resulting in serious injury or death.
- Do not install wheels and tires not approved by GAC MOTOR.

Warning

- Modifying the front part of the car and the engine compartment can deteriorate pedestrian protection performance of the car and violates the road regulations.

4.5 A/C System

4.5.1 General Instructions

The A/C filter can filter the pollen and dust brought in from the inlet of the A/C system.

The A/C filter must be cleaned and replaced regularly in accordance with the regulations in "Regular Maintenance Schedule" in the *Warranty Manual*.

If the car often runs in areas with poor air quality, the replacement interval of the A/C filter shall be shortened. If the air flow from the A/C air outlet is not smooth as usual, the A/C filter may be blocked. Clean or replace the A/C filter as soon as possible.

Warning

Turbid air in the car will make the driver fatigued, depressed and distracted, resulting in accidents and casualties easily. The air circulation mode shall be selected according to the actual situation.

Caution

If the A/C system has any fault (such as refrigeration failure and outlet air with abnormal odor), please go to any authorized GAC MOTOR special store for maintenance.

Hint

- When the Ignition switch is at "ON" position, the A/C system can be operated.
- Water drops from the bottom of the car when the A/C is turned on, and water accumulates at the bottom of the car when the car is parked for long with A/C on. These phenomena are normal.
- The air inlet at the bottom of the front windshield should be unblocked, and not clogged by snow, ice and leaves to ensure normal air inlet of the A/C system.
- All the windows and the sunroof must be closed for the A/C system to play a maximum effect. If the car has been exposed to the burning sun and it is very hot in the car, you should open the windows for a short time to dissipate the heat before using the A/C for cooling.

4. Operating System and Equipment

4.5.2 Auto A/C System*

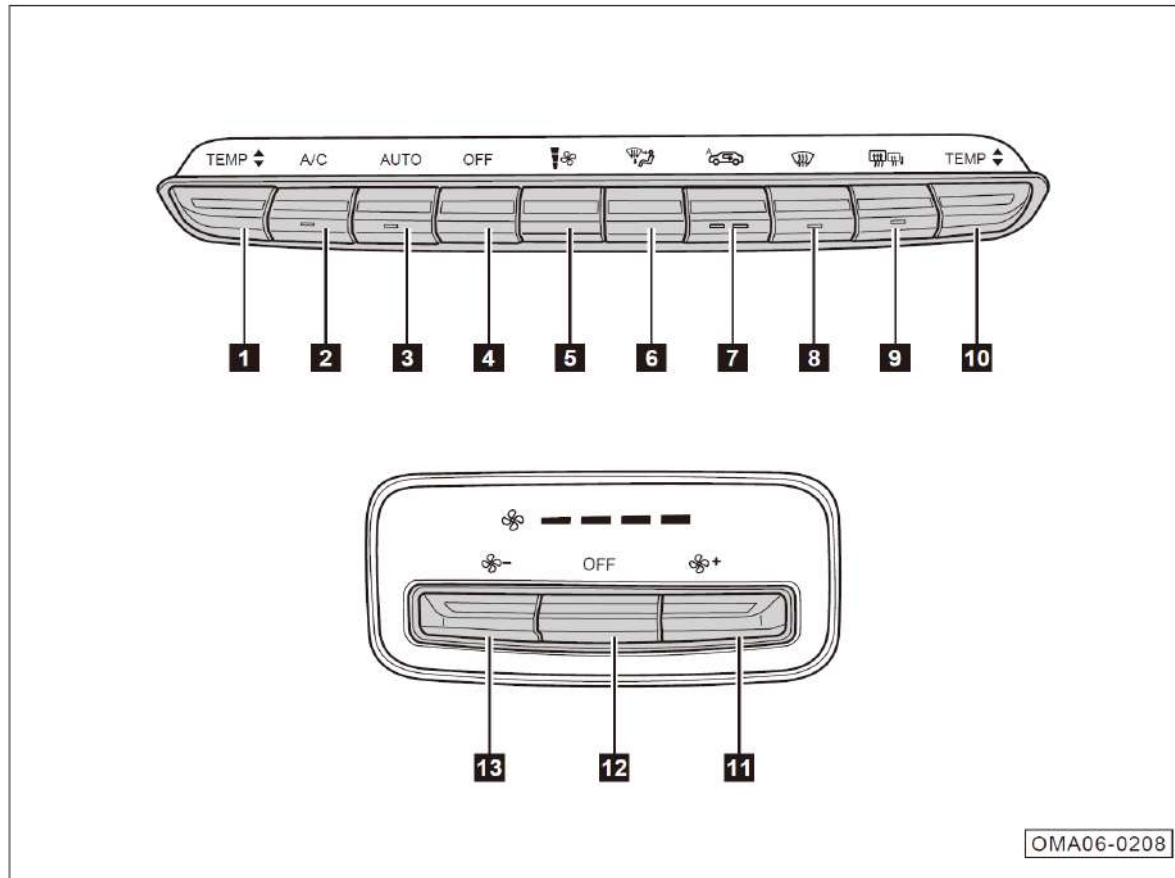

1. TEMP ↕ Temperature control button (left)
2. A/C refrigeration button
3. AUTO mode button
4. OFF button (front row)
5. Air speed control button
6. Air vent mode button
7. Interior/exterior air circulation button
8. Front windshield defrosting/defogging button
9. Rear windshield and exterior rear-view mirror* defogging/defrosting button
10. TEMP ↕ Temperature control button (right)
11. Air volume + button (rear row)
12. OFF button (rear row)
13. Air volume - button (rear row)

i Hint

- The A/C system can also switch the audio system display interface to the A/C system control interface by pulling up or pressing any button of the A/C control panel.
- Some special functions of the A/C system can be set in the "Vehicle Setting → A/C Setting" interface of the audio system.

Temperature Setting

Pull/push the ^{TEMP}  button to raise/lower the temperature at a step of 0.5°C.

- The temperature is shown on the audio display. The temperature is adjustable within 18.5°C ~ 31.5°C. When the set temperature is lower than 18.5°C, LO is shown; and when the set temperature is higher than 31.5°C, HI is shown.

In AUTO mode, LO/HI is reached, the system will keep operating in a large air supply state.

In AUTO mode, in order to obtain the most ideal interior temperature, we recommend that the set temperature is 25.0°C. If necessary, you can adjust the temperature by yourself.

A/C refrigeration button

Pull/push the A/C refrigeration button, the button light will be on and the refrigeration function of the A/C system will be enabled. After the refrigeration function is enabled:

- This means the refrigeration is needed, but the compressor is not necessary to operate.
- If the outside temperature is below 0°C, the button light will be on, but the compressor may not work.



If the refrigeration button is pulled up or pressed again, the button light turns off, and the A/C system disables the refrigeration function.

4. Operating System and Equipment

AUTO Mode

When AUTO button is pulled/pushed, the button light is on, the A/C system enters the AUTO mode, and the following items are controlled automatically as per respective set value:

- Air vent temperature
- Air volume at the air outlet
- Air Vent Mode
- Air circulation mode
- Working conditions of A/C.
- Working conditions of anion purifier

Operate  button or  button to exit the auto mode of the A/C system.







Air Speed Setting

By pull/push  button, the air speed increases/decreases by one scale. The audio system display shows corresponding wind speed scale.

In auto mode, to make the interior temperature reach the target value, the A/C system will automatically control the wind speed. Operate  button to exit the auto mode of the A/C system.

A/C Off

Pull/push OFF button to turn off the A/C system.

After the A/C system is turned off,  button,  button and  button* can be operated effectively without turning on the A/C system. It is ineffective to operate  button. The A/C system can be turned on by operating AUTO button, A/C button,  button or  button.

Air Circulation

Automatic Control of Interior/Exterior Circulation

Pull/push  button. When the right button light goes on, the system will enter AUTO control mode of interior/exterior circulation.

In this mode, the air inlet mode is controlled automatically according to the exterior air quality. The air inlet mode is interior circulation in case of poor exterior quality and exterior circulation in case of good exterior air quality.

Interior Circulation

Pull/push  button. When the right button light goes on, the system will enter interior circulation mode.

In case of poor exterior air quality, this mode can prevent exterior air from entering the car to form interior circulation of the interior air.

External Circulation

Pull/push  button. When all the button lights go off, the system will enter exterior circulation mode.

In case of good exterior air quality, this mode can prevent exterior air from entering the car and keep the interior air fresh.

Caution

- Prolonged interior circulation will cause accumulation of carbon dioxide in the car, and it is not conducive to keep the driver awake.
- Using the interior circulation mode in cold or rainy weather is easy to cause fogging of window, affecting the driver's vision.

Front Windshield Defrosting

Pull/Push  button to light on the button light and enable the front windshield defrosting function. The system will perform the following control automatically:

- Turn on the A/C.
- Enter front windshield blowing mode.
- Enter exterior circulation mode.

Pull/push  button again to light off the button light, disable the front windshield defrosting function, and return to the state before the defrosting action; or pull/push AUTO button to directly enter the AUTO mode and disable the front windshield defrosting function.

In auto mode, if the "Vehicle Setting → A/C Setting → Auto Defogging" function of the audio system is set as enabling, the A/C system will automatically detect the fog situation of the interior front windshield and automatically defog to prevent the front windshield from fogging to provide more support for safe driving.

Caution

- When the lowest temperature is set, enabling the defrosting function may cause fog on the outside of the windshield to affect the driver's vision. When the defrosting function is enabled, the temperature is suggested to be set to be close to the exterior ambient temperature.
- When the defrosting function is used at an ambient temperature of greater than 0°C, if the A/C function is off manually, it may cause the fog on the front windshield to affect the driver's vision.

4. Operating System and Equipment

Rear Windshield Defrosting

Pull/push  button to light on the button light, enable the rear windshield defrosting function, and heat the rear windshield and the exterior rear-view mirrors electrically.

During the rear windshield defrosting, pull/push  button again to light off the button light and disable the rear windshield defrosting function. If the rear windshield defrosting function is not manually off, this function will be off automatically after continuous working for 15 min.

Hint

If the engine is not started, prolonged rear windshield defrosting function may cause low battery voltage, leading to start failure of the car.

Dual-Zone Mode

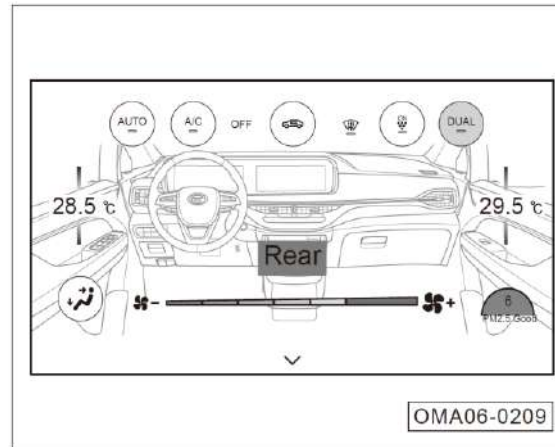

Switch the audio system to the A/C system control interface. Click DUAL soft button to light on the soft button light, or pull/push the temperature control button (right) to enter dual-zone control mode of the A/C system. Temperatures of left and right zones will be controlled independently:





- Set the regional temperature on the left side via the temperature control button (left).
- Set the regional temperature on the right side via the temperature control button (right).

Press DUAL soft button again to light off the button light. The A/C will exit dual-zone control mode to enter single-zone control mode. The regional temperature on whole car area will be controlled at the same time:

- Temperature control button (left) to control temperature in the whole car area.

Air Vent Mode

Pulling/pushing  button can switch among the following air outlet modes in loop:

-  Face blowing mode: Air is blown out from the air outlet of the instrument panel.
-  Face and foot blowing mode: Air is blown out from the air outlets of the instrument panel and the footwell.
-  Foot blowing mode: Air is blown out from the air outlet of the footwell.
-  Foot and front windshield blowing mode: Air is blown out from the defrosting air outlet of the front windshield and the air outlet of the footwell.

In auto mode, the A/C system will automatically control the air vent mode. When the air vent temperature is high, most of the air will be blown towards the feet. When the air vent temperature is low, most of the air will be blown towards the face. Operate  soft button to exit the auto mode of the A/C system.

Hint

- To ensure that A/C system can effectively control all the air vent modes automatically, please open all the air outlets.
- Under cold start in winter, the air vent mode will be switched over from the front windshield blowing mode in AUTO mode.

Anion Air Purifier

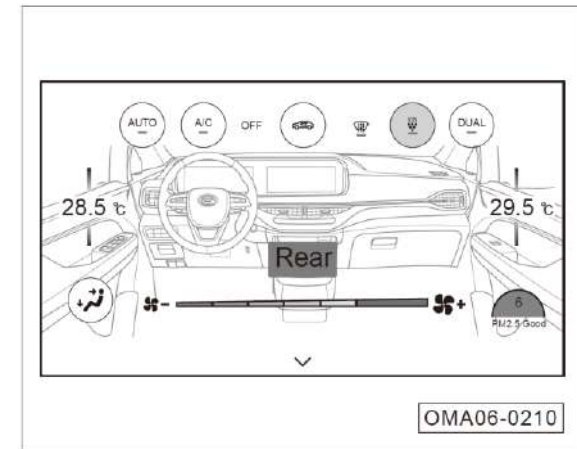

Switch the audio system to the A/C system control interface. Click  soft button to light on the soft button light and start the anion air purifier of the A/C system. It produces anions which can effectively decompose the interior formaldehyde, benzene and other harmful gases and purify the interior air.

Click  button again to light off the soft button light and turn off the anion air purifier of the A/C system.

4. Operating System and Equipment

Rear Row A/C Control

Press or button to increase or decrease the rear row air volume.

Press OFF button to turn off the rear row A/C. Press or button to turn on the rear row A/C.

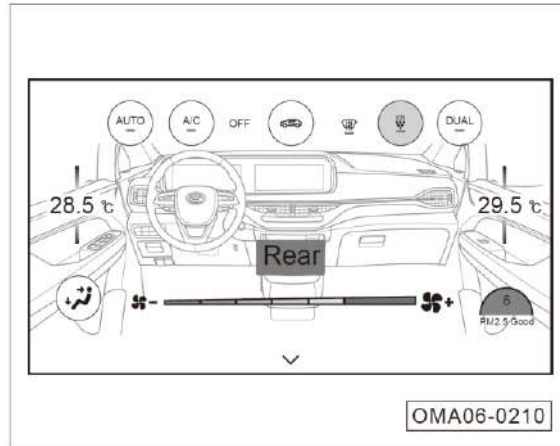

Switch the audio system to the A/C system control interface. Click "Rear" soft button to switch to the rear row A/C control interface and enable the front row controlling the rear row function of the A/C system.

- OFF button
- button.

Hint

The rear row A/C only has the refrigeration function. If the rear passengers want to heat from the second row foot blowing air outlet.

Sunlight Sensor

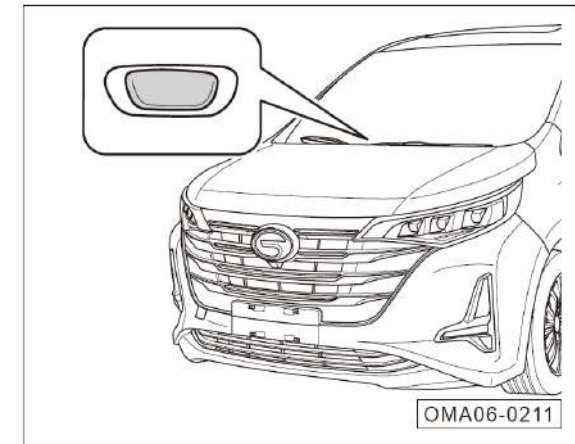

In AUTO mode, the A/C system can detect the interior and exterior temperatures and sunlight via sunlight sensor. The sunlight sensor shall not be covered.

Caution

Due to different environment areas and vehicle conditions, the ambient temperature shown may be different from the actual value.

4.5.3 Manual A/C System*

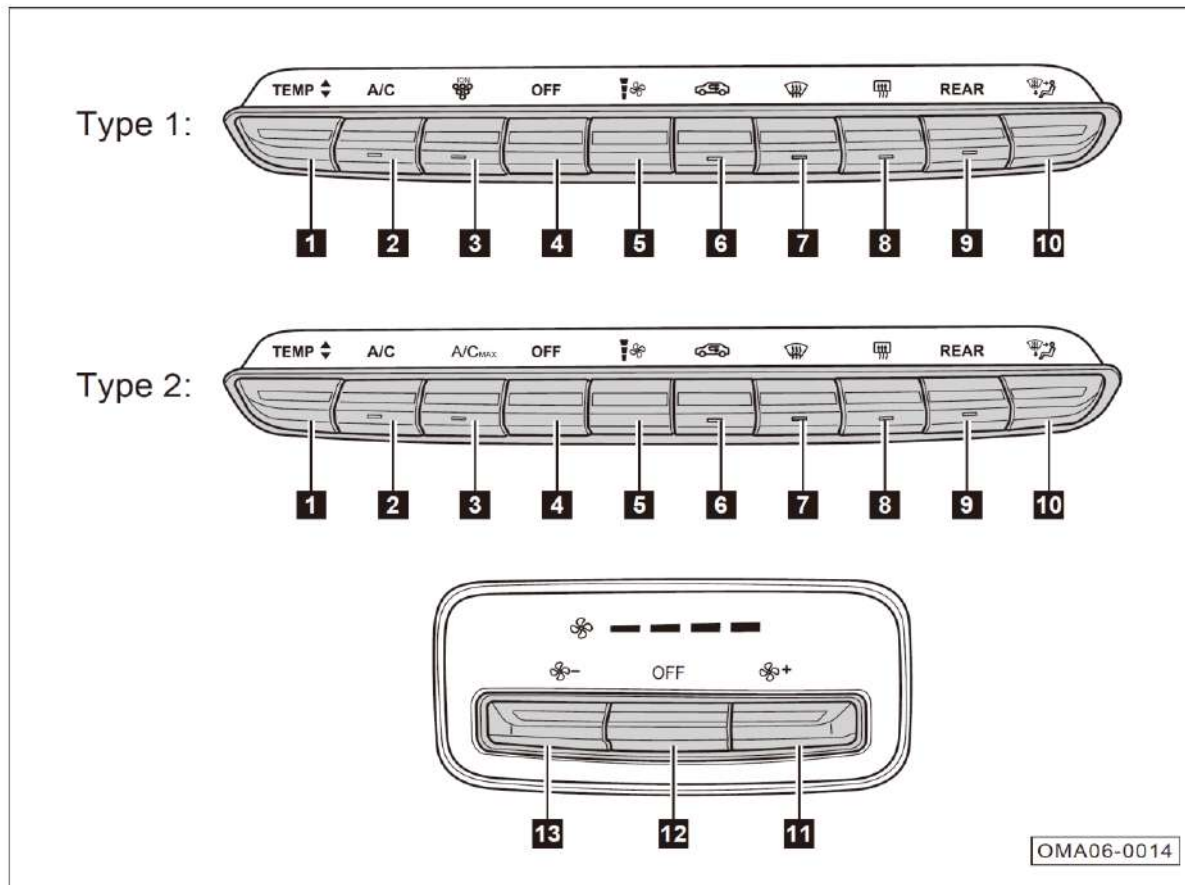

1. TEMP \updownarrow Temperature control button
2. A/C A/C refrigeration button
3. Anion air purifier button *
- A/C_{MAX} A/C maximum mode button*
4. OFF OFF button (rear row)
5. Air speed control button
6. Interior/exterior air circulation button
7. Front windshield defrosting/defogging button
8. Rear windshield defrosting/defogging button
9. REAR REAR control button
10. Air vent mode button
11. Air volume + button (rear row)
12. OFF OFF button (rear row)
13. Air volume - button (rear row)

4. Operating System and Equipment

Hint

- The A/C system can also be controlled by switched the audio system display interface to the A/C system control interface.
- Some special functions of the A/C system can be set in the "Vehicle Setting → A/C Setting" interface of the audio system.

Temperature Setting

- Pull/push the TEMP  button to raise/lower the temperature at a step of 0.5°C.
- The temperature is shown on the audio display. The temperature is adjustable within 18.5°C ~ 31.5°C . When the set temperature is lower than 18.5°C, LO is shown; and when the set temperature is higher than 31.5°C, HI is shown.

A/C refrigeration button

Pull/push the A/C refrigeration button, the button light will be on and the refrigeration function of the A/C system will be enabled. After the refrigeration function is enabled:

- This means the refrigeration is needed, but the compressor is not necessary to operate.
- If the outside temperature is below 0°C, the button light will be on, but the compressor may not work.

If the refrigeration button is pulled up or pressed again, the button light turns off, and the A/C system disables the refrigeration function.

Anion Air Purifier*

Pull/Push  button to light on the button light and start the anion air purifier of the A/C system. It produces anions which can effectively decompose the interior formaldehyde, benzene and other harmful gases and purify the interior air.

Pull/Push  button to light off the button light and shut down the anion air purifier of the A/C system.

Max Cool Mode*







Pull/Push A/C_{MAX} button to light on the button and let the A/C system enter max cool mode. The system will perform the following settings automatically:

- Turn on the A/C.
- Set the temperature at LO.
- Set the air vent mode as face blowing mode.
- Set the air circulation mode as interior circulation mode.
- Set the air speed at the air outlet as the maximum.

Pull/Push the A/C_{MAX} button again to light off the button light, let the A/C system exit the max cool mode, and return to the state before open the max cool action.

A/C Off

Pull/push OFF button to turn off the A/C system.

After the A/C system is turned off,  button,  button,  button and  button* can be operated effectively without turning on the A/C system. It is ineffective to operate $TEMP \updownarrow$ button. The A/C system can be turned on by operating A/C button,  button,  button or A/C_{MAX} button*.

Air Speed Setting

By pull/push  button, the air speed increases/decreases by one scale. The audio system display shows corresponding wind speed scale.

Air Circulation

Interior Circulation

Pull/push  button. When the button light goes on, the system will enter interior circulation mode.

In case of poor exterior air quality, this mode can prevent exterior air from entering the car to form interior circulation of the interior air.

External Circulation

Pull/push  button. When all the button lights go off, the system will enter exterior circulation mode.

In case of good exterior air quality, this mode can prevent exterior air from entering the car and keep the interior air fresh.

4. Operating System and Equipment

Caution

- Prolonged interior circulation will cause accumulation of carbon dioxide in the car, and it is not conducive to keep the driver awake.
- Using the interior circulation mode in cold or rainy weather is easy to cause fogging of window, affecting the driver's vision.

Front Windshield Defrosting

Pull/Push  button to light on the button light and enable the front windshield defrosting function. The system will perform the following control automatically:

- Turn on the A/C.
- Enter front windshield blowing mode.
- Enter exterior circulation mode.

Pull/push  button again to light off the button light, disable the front windshield defrosting function, and return to the state before the defrosting action.

Caution

- When the lowest temperature is set, enabling the defrosting function may cause fog on the outside of the windshield to affect the driver's vision. When the defrosting function is enabled, the temperature is suggested to be set to be close to the exterior ambient temperature.
- When the defrosting function is used at an ambient temperature of greater than 0°C, if the A/C function is off manually, it may cause the fog on the front windshield to affect the driver's vision.

Rear Windshield Defrosting

Pull/push  button to light on the button light, enable the rear windshield defrosting function, and heat the rear windshield electrically.





During the rear windshield defrosting, pull/push  button again to light off the button light and disable the rear windshield defrosting function. If the rear windshield defrosting function is not manually off, this function will be off automatically after continuous working for 15 min.

Hint



If the engine is not started, prolonged rear windshield defrosting function may cause low battery voltage, leading to start failure of the car.



Air Vent Mode

Pulling/pushing  button can switch among the following air outlet modes in loop:

-  Face blowing mode: Air is blown out from the air outlet of the instrument panel.
-  Face and foot blowing mode: Air is blown out from the air outlets of the instrument panel and the footwell.
-  Foot blowing mode: Air is blown out from the air outlet of the footwell.
-  Foot and front windshield blowing mode: Air is blown out from the defrosting air outlet of the front windshield and the air outlet of the footwell.

Rear Row A/C Control

Press  or  button to increase or decrease the rear row air volume.

Press OFF button to turn off the rear row A/C. Press  or  button to turn on the rear row A/C.

Pull/Push the REAR button to light on the button light and enable the front row controlling the rear row function of the A/C system.

- OFF button
-  button.

After the REAR button is pulled/pushed or no operation exceeds 6s, the front row A/C panel controlling the rear row A/C function will be disabled.

Hint

The rear row A/C only has the refrigeration function. If the rear passengers want to hot air, it is suggested to heat from the second row foot blowing air outlet.

4. Operating System and Equipment

4.5.4 Air Outlets

Side Air Outlets of Instrument Panel

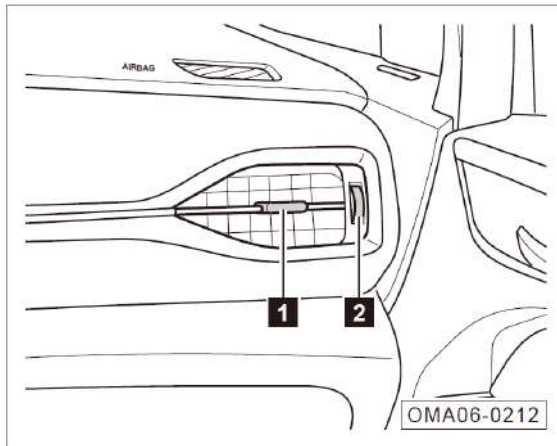

- Move the flap ① to adjust the air direction.
- Turn the knob ② to adjust the air volume or close the air outlet.

Central Air Outlets of Instrument Panel

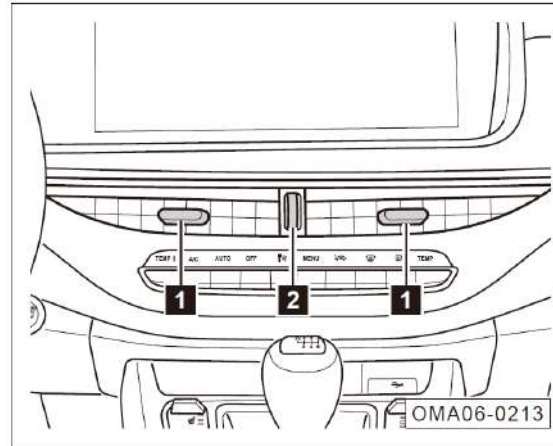

- Move the flap ① to adjust the air direction.
- Turn the knob ② to adjust the air volume or close the air outlet.

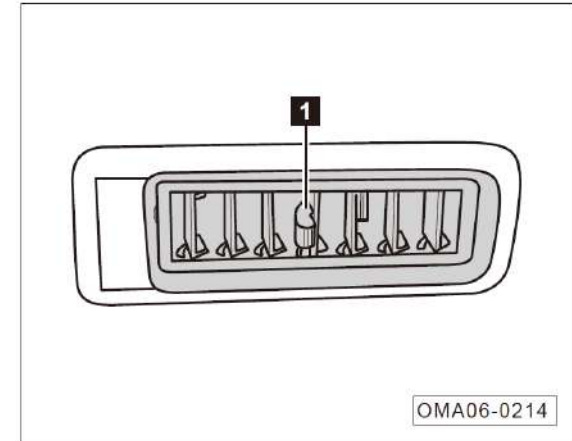

Second/Third Row Air Outlet



- Move the flap ① to adjust the air volume and the air direction.

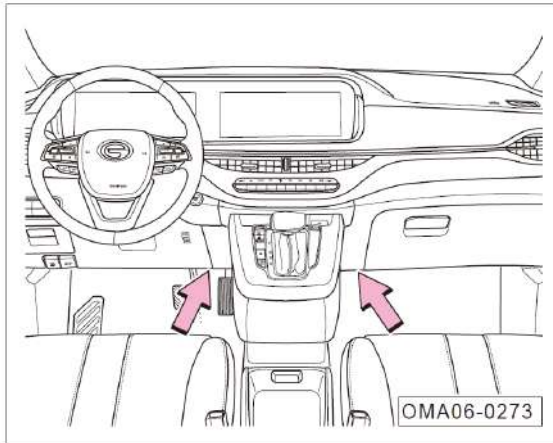

Front Row Foot Blowing Air Outlet

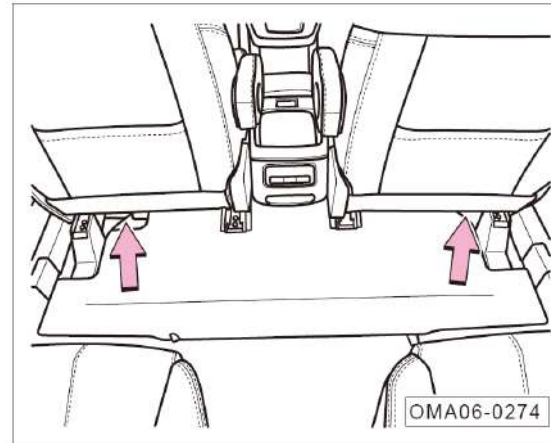

- The front row foot blowing air outlet is under the dashboard. When  or  air vent mode is used, the air volume can be blown from the foot blowing air outlet.

Second Row Foot Blowing Air Outlet



- The second row foot blowing air outlet is under the front seat. When  or  air vent mode is used, the air volume can be blown from the foot blowing air outlet.

4. Operating System and Equipment

4.6 AUDIO System

4.6.1 Control Buttons on the Steering Wheel

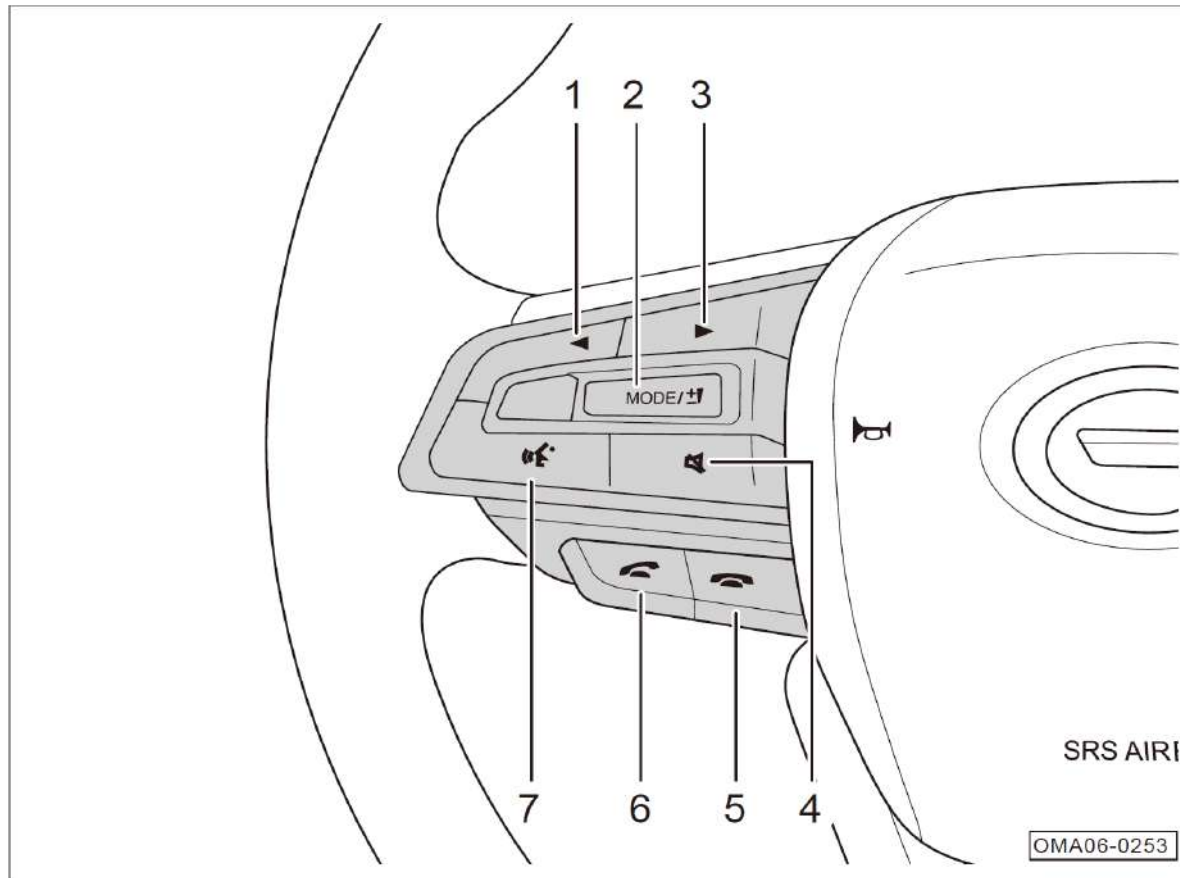

1. ◀ Button
 - In radio mode, search the station towards LF automatically. If an effective station is met, auto search stops and the station starts playing.
 - Change the track into the previous one in media source play.
2. Audio source switching button / volume adjustment button
 - Short press this button continuously to switch: FM → AM → USB → Bluetooth music → FM.
 - Pressing this button will not actively switch to CarLife music. If CarLife music is played currently, press this button to switch to the radio mode.
 - Stir the button up or down to adjust the volume.

3. ► Button

- In radio mode, search the station towards HF automatically. If an effective station is met, auto search stops and the station starts playing.
- Change the track into the next one in media source play.

4. Mute Button

- Short press this button to mute the media source.
- After muting, press again to unmute.

5. Hang-up Button

- When an incoming call is in the Bluetooth Phone system, press this button to reject.
- Press this button to end the current call in the call process.

6. Answer Call Button

- When an incoming call is in the Bluetooth Phone system, press this button to answer.
- When there is no incoming call in the Bluetooth phone system, you can press this button to enter the "Bluetooth Call" interface.
- When there is no incoming call in the Bluetooth phone system and Bluetooth is not connected, you can press this button to enter the "Bluetooth Setting" interface.

4. Operating System and Equipment

4.6.2 Basic Operations

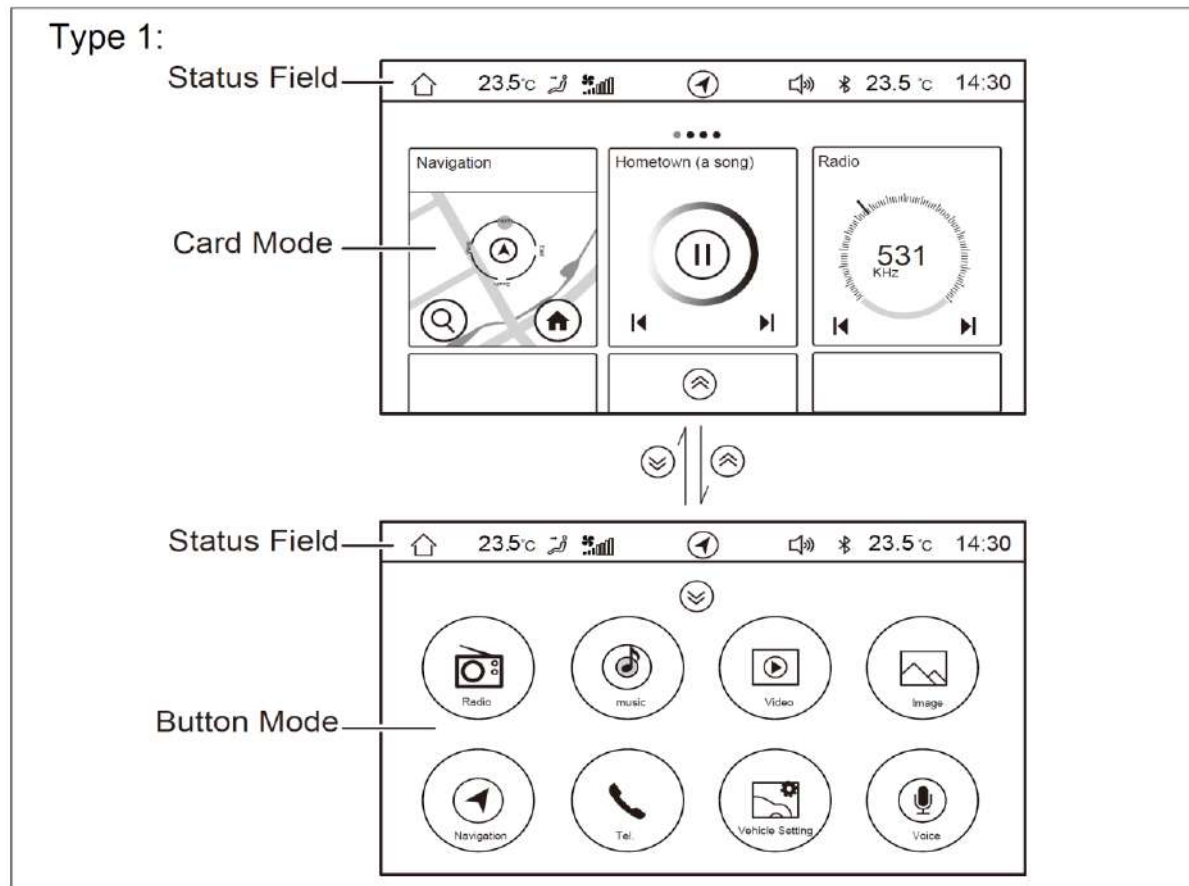

The main interface is divided into card mode and button mode.

- Slide left/right to switch the interface.
- Click card to enter corresponding functions. Click soft buttons in card to perform corresponding functions.
- Slide on the opposite angles of the screen towards the middle with thumb and forefinger at the same time to enter the edit mode, and long press and drag the card to edit the card sequence.
- Click button mode corresponding functional soft button to enter the corresponding function.

Status Field

- The status field shows the system information. Part of the icons support to enter corresponding functional interface by clicking.

i Hint

The main interface is only based on a certain configuration. It can be referred to the assembly of AV/AVN host model. The specific functions and interfaces shall be subject to the configuration of actual vehicle.

4. Operating System and Equipment

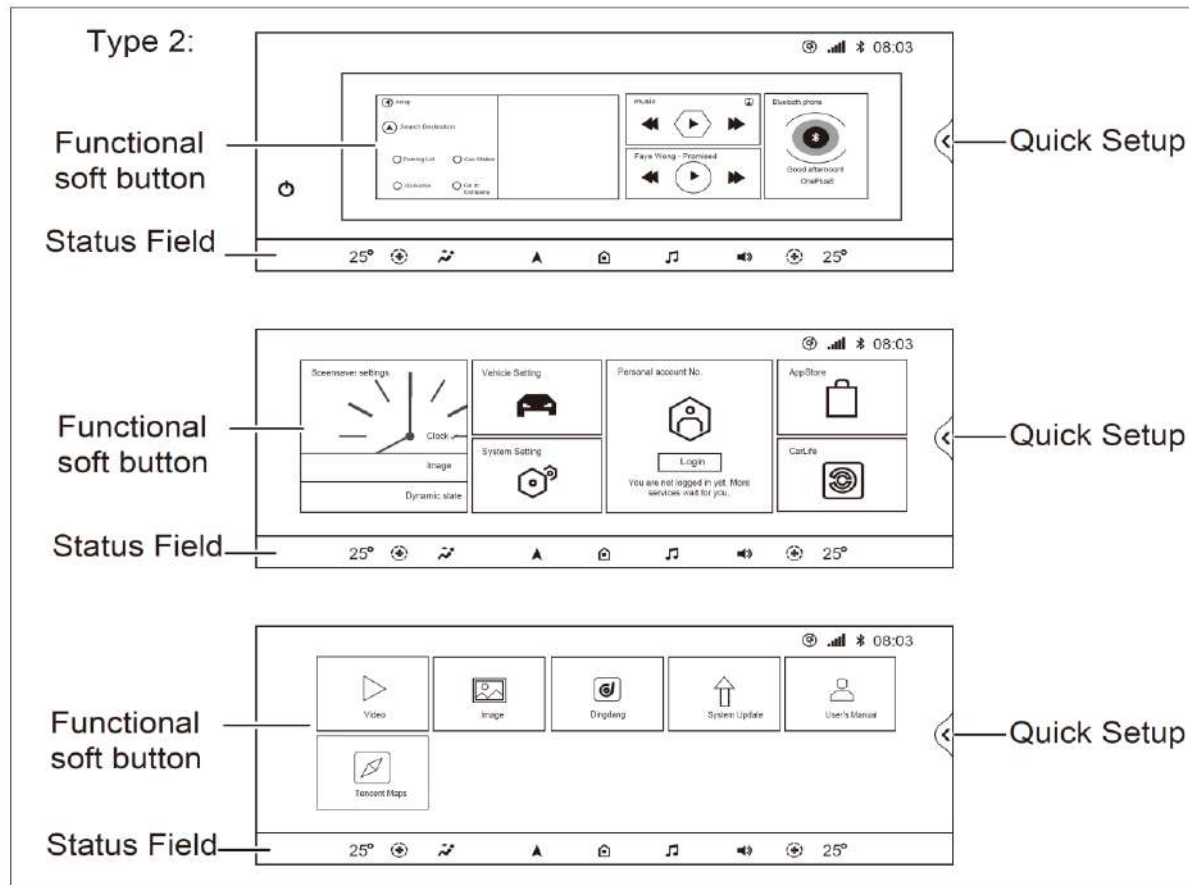

- Slide left/right to switch the interface.
- Click each card to enter corresponding functional interface. Click soft buttons in each card to perform corresponding functions.

Status Field

- The status field shows the system information. Part of the icons support to enter corresponding functional interface by clicking.

Quick Setup

- Click the "Quick Setup" soft button to pop out the quick setup interface to set part of functions.

i Hint

The main interface is only based on a certain configuration. It can be referred to the assembly of AVNT host model. The specific functions and interfaces shall be subject to the configuration of actual vehicle.

4. Operating System and Equipment

⏻ Operation of Buttons

AV/AVN Host Model *

- When the Ignition switch is put to "ACC" or "ON" position, the audio system displays the standby screensaver interface. Short press ⏻ button to start the audio system.
- In start state, short press ⏻ button. The audio system displays the screensaver interface, and all audio sources are off. Short press ⏻ button again to start the audio system.
- Turn ⏻ button to adjust the volume of audio system.

4.6.3 Radio

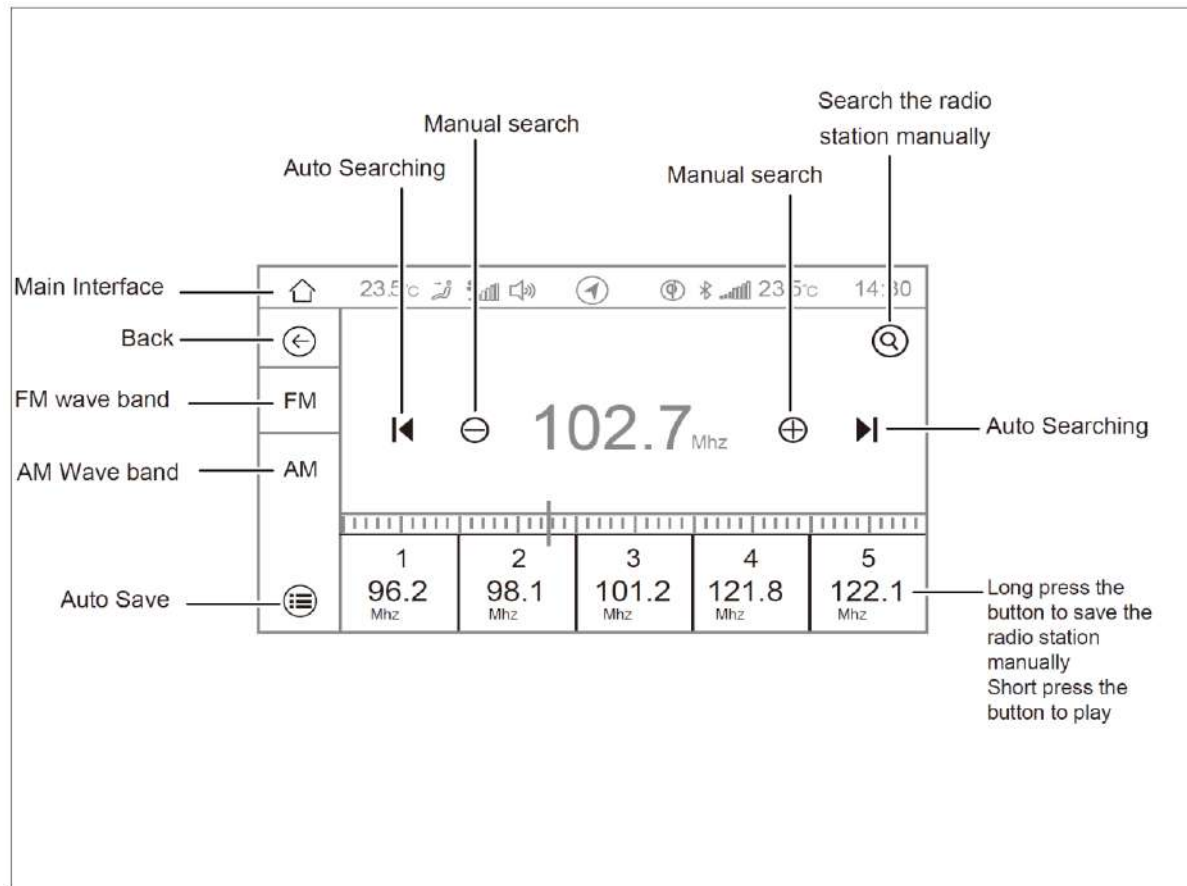

AV/AVN host enters the radio play interface through the following ways:

- Click the "Radio" in card mode to enter the radio mode.
- Click the "Radio" soft button in button mode* to enter the radio mode.
- Continuously press MODE button on the left side of the steering wheel to switch to radio.

4. Operating System and Equipment

Reception Form of AM/FM Car Audio

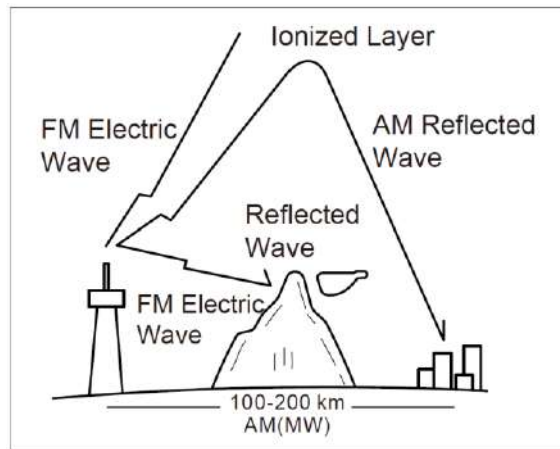

VHF channels on FM will pass through the ionosphere directly without reflection, but once they hit high mountains, high-rise buildings and other barriers, they will produce reflection. FM spreading distance is usually about 40~50 kilometers. It will become shorter when stereo signals are transmitted.

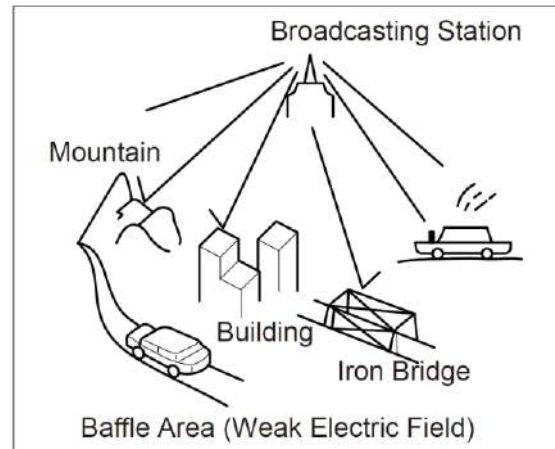

The radio is far away from the broadcasting station, so the signals are too weak to be received. As a result, the radio will only receive noises. When the car is driven between the areas to receive two strong stations with a close signal frequency at the same time, the radio may lose sound suddenly or produce noise interference.

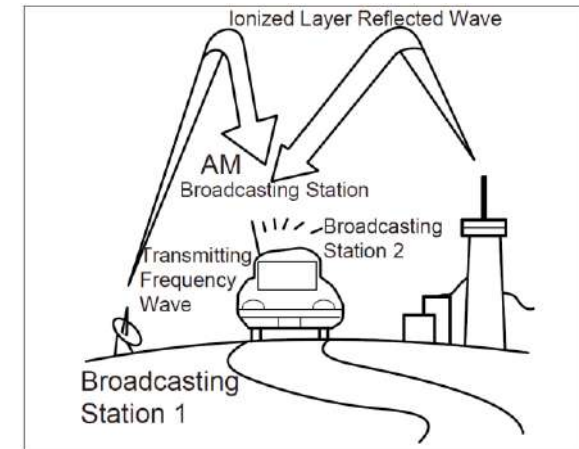

Although MW or SW of AM cannot pass through ionosphere, it will produce diffraction. As a result, when the radio waves hit high mountains and high-rise buildings, its spreading distance will be farther than that of FM. Therefore, it is likely to simultaneously receive the signals from two AM stations.

4.6.4 USB Play

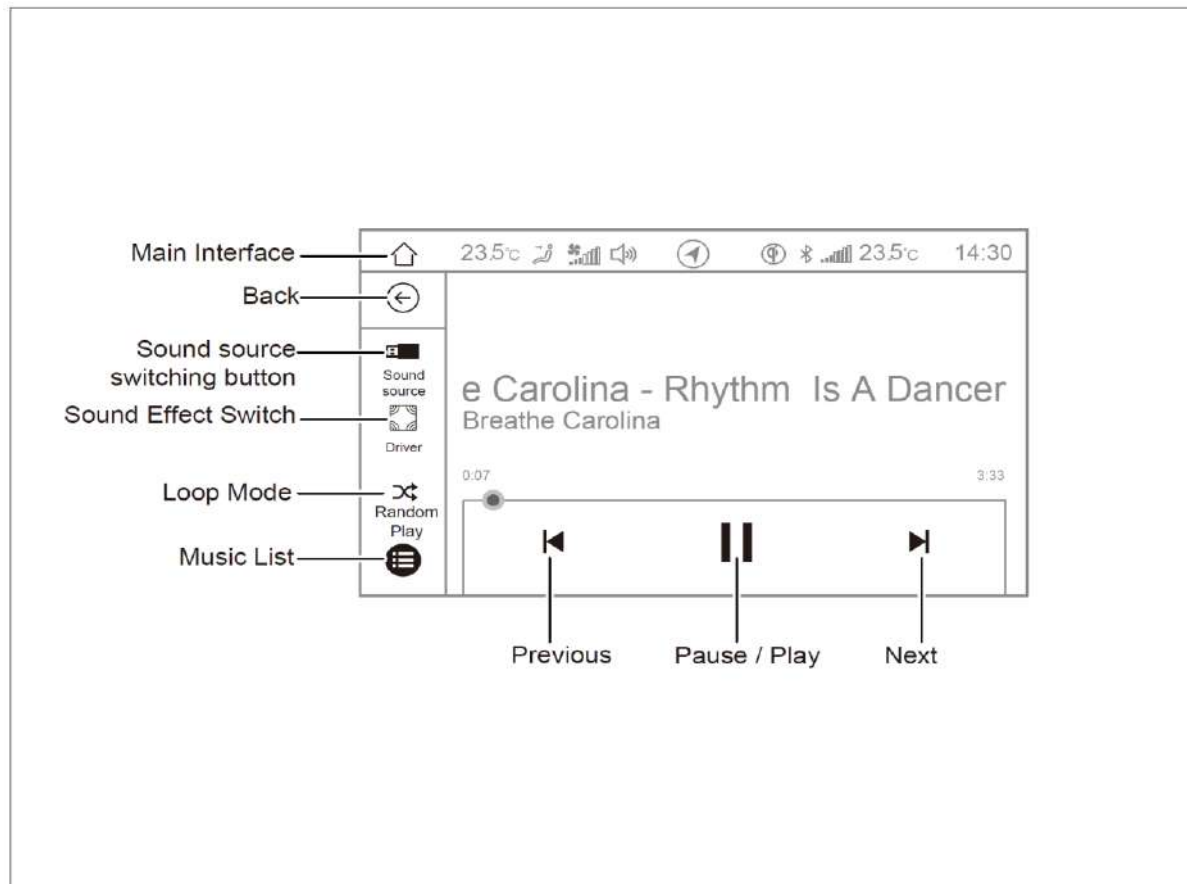

AV/AVN host enters the USB play mode through the following ways:

- Click the "Music" in card mode to enter the USB play mode.
- Short press MODE button on the left side of the steering wheel continuously to switch to the USB play mode.
- Click "Music*", "Image" or "Video" soft button on the button mode main interface to switch to the USB play mode.

i Hint

- After USB device is successfully connected, a prompt will be popped up. USB music, pictures and videos are compatible.
- If iPod function is provided, refer to the USB operation.

4. Operating System and Equipment

4.6.5 Bluetooth

AV/AVN Host Bluetooth Mode

You can enter Bluetooth mode by the following ways:

- Click "Bluetooth Telephone" on main interface of card mode to enter Bluetooth mode.
- In non-call mode, short press  button on the left side of steering wheel to enter Bluetooth mode.
- Click "Phone" soft button on the button mode main interface to enter the Bluetooth mode.



- If there is no Bluetooth device connected, the system will prompt in connecting new device.
- Enter Bluetooth setting interface by clicking  soft button, and use it after setting and connecting the Bluetooth function.

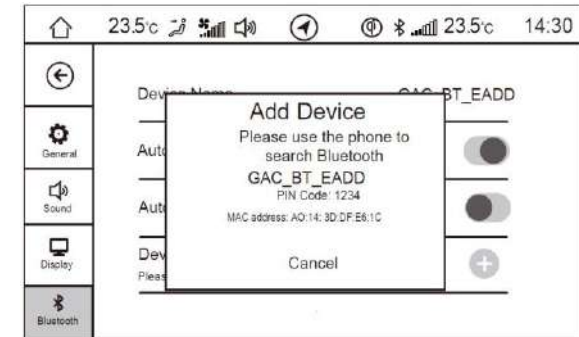

- Click "+" soft button on the right of the device list to make the Bluetooth discoverable.

4. Operating System and Equipment

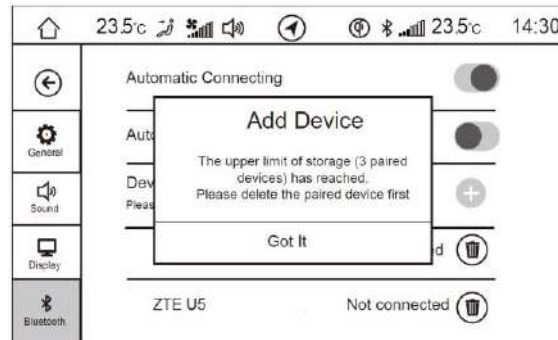
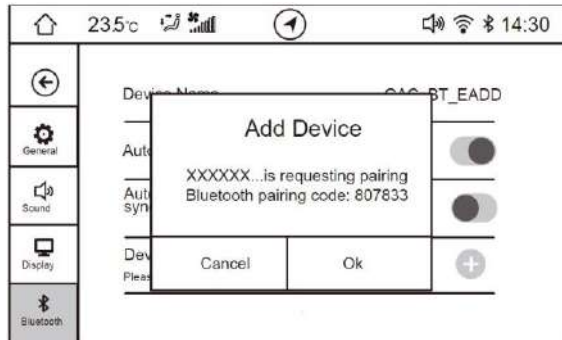

- Use the phone to search and obtain the device name, and click the device name for pairing. The confirmation box will pop up after the system receives the pairing request (entering the PIN code or not will be determined according to the phone model).
- Click "OK" soft button to start pairing. Click "Cancel" soft button to end pairing. The device name will be shown in the device list after successful connection.
- The Paired Bluetooth devices will be listed in the device list. If a device is successfully connected, it will be shown as "Connected".
- After the Bluetooth device is connected, enter the interface and click "Audio", "Phone Book" or "Call" to enter corresponding interface.

4. Operating System and Equipment

4.6.6 System Setting

AV/AVN host model: Click the "Settings" soft button in the main interface of button mode to enter the system settings interface. AVNT host model: Click the "Settings" soft button in the main interface to enter the system settings interface. Click the options in the settings interface to select and click slider  for enabling or disabling, and drag the progress bar for adjustment.

Setting Group	Function	Description	Optional Setting
General	Language*	Change the display language	Chinese/English
	Time and Date	Set the date and time	24-hour system/Settings*/GPS time and date synchronizing*
	IPhone priority connection *	For setting of phone connection, the system prefers CarLife or iPod connection	CarLife/iPod
	Navigation signal mode *	Select the navigation reception signal mode.	GPS/BDS/GPS+BDS
	Version*	View the host software version information.	/
	Car Information*	View the vehicle head unit information.	/
Sound	Multimedia volume*	Adjust the volume of the radio, USB music, Bluetooth music, and APP store music	/
	Voice recognition/phone volume*	Adjust the voice recognition/Bluetooth phone volume	/
	Navigation volume*	Adjust the navigation volume and synchronize with the navigation application	/
	3D sound effect	Select the best listening position	OFF/driver/all passengers
	Preset Sound Effect	When the 3D sound is selected to OFF and "Custom" is selected for the pre-set sound, manually adjust high, middle and low pitch.	Classic/Popular/Jazz/Rock/Default/Custom
	Virtual subwoofer*	When the 3D sound effect selected as "Driver" or "All passengers", set the virtual subwoofer	On/Off

4. Operating System and Equipment

Setting Group	Function	Description	Optional Setting
Sound	Sound Field	Adjust the sound field position via touching	Reset
	Power-on Volume	Set the power-on volume	Constant/Adaptive
	Speed Dependent Volume Control	Adjust the volume change under the influence of acceleration or deceleration	OFF/Low/Medium/High
	Button Tone	Adjust the button tone of touch screen	Off/modern/vintage
	Reverse Media Volume	Select the volume of the audio system during reversing	Constant/Mute
	Unlock/Lock horn beeping * (unlocking/locking prompt tone *)	Set the horn to sound when the car is unlocked/locked	On/Off
Display	Screen Brightness	Adjust the screen brightness	/
	Brightness Mode*	Set the brightness mode	Day/Night/Auto
	Holding Time of A/C Interface	Set the holding time of A/C interface after operation	3s/5s/15s/30s
Bluetooth	Automatic Connecting*	Set whether to connect automatically	On/Off
	Automatic answering*	Set whether to answer automatically	On/Off
	Device List*	Add devices to the device list	/
	History devices *	View the bluetooth devices successfully connected in history.	/
	Other devices *	View the bluetooth devices searched.	/
	Ignore this device *	Set the bluetooth device to be ignored.	/
	Sync contact *	Set whether to synchronize the Contact automatically	On/Off
Website*	Mobile network*	Enable or disable mobile network	On/Off
	Personal hotspot*	Enable or disable personal hotspot	On/Off
	WIFI*	When the personal hotspot (if any) is "OFF", enable or disable WIFI	On/Off
Factory reset	/	Reset the above setting groups to the factory defaults.	/

4. Operating System and Equipment

4.6.7 Vehicle Setting

AV/AVN host model: Click the "Vehicle Setting" soft button in the main interface of button mode to enter the vehicle setting interface. AVNT host model: Click the "Vehicle Setting" soft button in the main interface to enter the vehicle setting interface. Click the options in the settings interface to select and click slider  for enabling or disabling, and drag the progress bar for adjustment.

Setting Group	Function	Description	Optional Setting
Seat Setting*	Automatic Heating*	/	On/Off
	Smart Key Recognition*	/	On/Off
	Seat Guest Greeting Function*	/	On/Off
Driving Assist	Safe speed prompt (km/h)	Set safe speed prompt	Range: 0~200
	Steering Mode	Set the steering force magnitude of the steering wheel	Comfort/Normal/Sport
Smart Body	Smart Active Locking*	/	On/Off
	Smart Active Unlocking*	/	On/Off
	Remote Unlocking	Set to unlock the doors with smart key	All Doors/Only FL Door
	Automatic Unlocking	/	On/Off
	Exterior Rear-view Mirror Automatic Folding*	/	On/Off
	Remote Control of Window and Sunroof	/	On/Off
	Automatic wiping*	/	On/Off
	Front Wiper Maintenance	/	On/Off
Mobile phone wireless charging*	/	On/Off	

4. Operating System and Equipment

Setting Group	Function	Description	Optional Setting
Light Control	Auto Lighting Sensitivity*	Select auto lighting sensitivity	Low/Medium/High
	Atmosphere light switch *	/	On/Off
	Follow Me Home	Select the Follow Me Home lighting mode	OFF/Low Beam/Low Beam + Rear Fog Light
	Daytime Running Light	/	On/Off
	Intelligent Guest Greeting Light*	/	On/Off
A/C Setting	Interior/Exterior Circulation Smart Control	/	On/Off
	A/C Comfort Curve	Select the A/C comfort curve	Soft/Normal/Fast
	Air quality sensor	Select the air quality sensor mode	Low Sensitivity/Medium Sensitivity/High Sensitivity
	Automatic air volume setting	Select the automatic air volume mode	Low/Medium/High
	Auto defogging	Select the auto defogging mode	OFF/Low Sensitivity/Medium Sensitivity/High Sensitivity
	A/C Control	Click  on the status bar to enter A/C control interface:	/

5. Driving Directions

5.1 Starting and Driving

5.1.1 Ignition Switch

Engine Start/Stop switch*

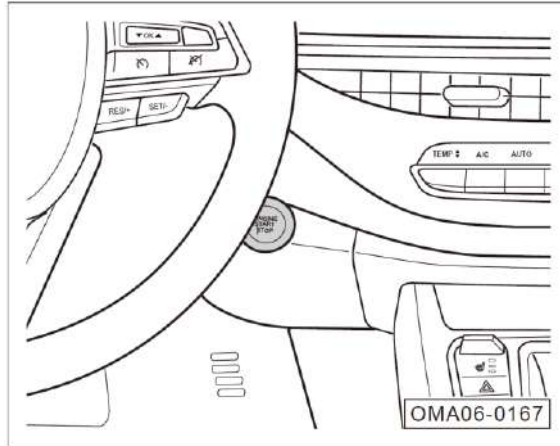

Only when the smart key is detected in the vehicle can the start switch (ENGINE START STOP button) be operated.

When the automatic transmission shift lever is in the "P" or "N" position and the brake pedal is depressed, the start switch indicator light turns green, and then press the start switch to start the engine.

When the AT gearshift is at -P" position without pressing the brake pedal, press the start switch and then it will switch by the order of -OFF → ACC → ON → OFF ”.

- OFF: Switch indicator light is off and the Start switch is off.
- ACC: When the switch indicator light is orange, the circuits of power outlet and other accessories are switched on.
- ON: Switch indicator light is orange, instrument light is on and all electrical equipment circuits are switched on.

i Hint

- For models with manual transmission, it is recommended to operate the Start switch when the manual transmission gearshift is in neutral position.

i Hint

- With the start switch at "ON" position, when the AT gearshift is at any position other than "P" position without depressing the brake pedal, press the start switch to switch it from "ON" to "ACC". If you continue to press the start switch, it will switch in the sequence of "ON → ACC → ON" and will not return to "OFF". With the switch at "ACC" position, when the AT gearshift switch from any position other than "P" to "P", the switch will automatically return to "OFF" position without being pressed.
- When the AT gearshift is at the "P" position and the start switch is switched from "OFF" to "ACC" and kept at the "ACC" position for an hour, the car will enter the power saving mode and the switch will return to "OFF" position automatically.

Limphone Mode

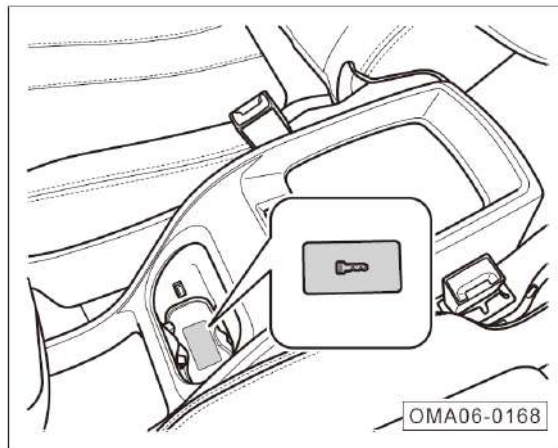

If "No key detected" is shown on the instrument cluster display due to low power of the smart key, please try to place the smart key horizontally on the key mark at the bottom of the front cup holder, press the start switch to switch it to "ACC" or "ON" and depress the brake pedal to change the indicator light of the start switch to green, and then press the start switch to start the engine.

This start method is temporary emergency startup. Please replace the battery of smart key as soon as possible.

Conventional Ignition Switch*

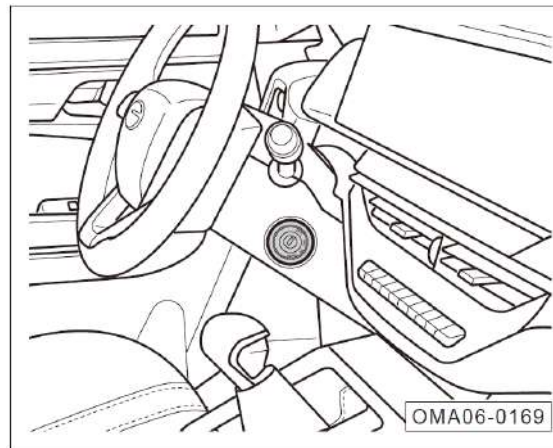

The Ignition switch has 4 gears in total.

- LOCK (OFF): The circuit is disconnected and the key could be pulled out only at this gear.
- ACC: At this position, the circuits of power outlet and other accessories are switched on.

- ON: Instrument light is on and all electrical device circuits are switched on; the ignition switch will be switched to this position after the engine is started.
- START: This gear is only used to start engine.

i Hint

When the key cannot be turned from the "LOCK" to "ACC", the steering wheel can be turned slightly to separate the steering wheel locking mechanism until the key can be turned to switch the ignition switch position.

5. Driving Directions

5.1.2 Engine Start

Vehicle Models with Manual Transmission

Vehicle Models with Ignition Switch

- Insert the mechanical key into the Ignition switch.
- Make sure that the gearshift is at neutral gear.
- Turn the mechanical key to "START" position to start the engine, and then release the mechanical key.

Vehicle Models with Start Switch

- Carry the smart key into the car.
- Make sure that the gearshift is at neutral gear.
- Depress the brake pedal, and make sure the start switch indicator light is green.
- Press the Start switch to start the engine.

i Hint

To ensure safety, when a car with manual transmission is started, it is recommended that the clutch pedal and brake pedal be depressed simultaneously.

Vehicle Models with Automatic Transmission

Vehicle Models with Ignition Switch

- Insert the mechanical key into the Ignition switch.
- Make sure that the gearshift is at "P" or "N".
- Step on the brake pedal.
- Turn the mechanical key to "START" position to start the engine, and then release the mechanical key.

Vehicle Models with Start Switch

- Carry the smart key into the car.
- Make sure that the gearshift is at "P" or "N".
- Depress the brake pedal, and make sure the start switch indicator light is green.
- Press the Start switch to start the engine.

i Hint

- If the engine is of cold start, it needs idle running to let it warm up before driving. At the same time, because valve lifter takes a few of seconds to reach normal working pressure, it can produce running noise, which is normal phenomenon.
- Vehicle models with start switch: if the engine cannot be start normally caused by brake signal, speed failure, or low temperature in winter and other reasons, it can try to switch the start switch to the "ACC" gear, ensure the transmission gearshift in "P" or "N" gear, and press start switch for 15 seconds, and then start the engine forcefully.

Caution

- Engine startup time cannot exceed 15s. If engine fails to start successfully, wait about 30s to try again.
- After startup, do not depress the accelerator pedal suddenly to run the engine at high speed or overload. Otherwise, the engine is extremely easy to damage.
- If the battery power is too low to start the engine, you can try the emergency start by connecting cable. => Refer to Page 245
- Do not start an engine by pushing or pulling it.

Warning

- Do not start the engine in a poorly ventilated or enclosed room for a long time. Because engine off-gas contains harmful gas, it can cause coma and even death from suffocation.
- Do not let the engine run at idle speed in the unattended state.
- Do not start the engine by starting auxiliary device.
- Do not install any auxiliary starting device to start the engine. Otherwise, the engine may run at high speed, and explosion may occur.

5. Driving Directions

5.1.3 Engine Stop

Vehicle Models with Manual Transmission

- Stop the car steadily, and apply parking brake.
- Switch the gearshift to neutral gear.
- Turn the mechanical key to switch the Ignition switch to LOCK position, and thus shut down the engine. (Apply to models with conventional ignition switch)
- Press the Start switch to shut down the engine. (Apply to models with Engine Start/Stop switch)

Vehicle Models with Automatic Transmission

- Stop the car steadily, and apply parking brake.
- Put the gearshift at "P" gear.
- Turn the mechanical key to switch the Ignition switch to LOCK position, and thus shut down the engine. (Apply to models with conventional ignition switch)
- Press the Start switch to shut down the engine. (Apply to models with Engine Start/Stop switch)

Hint

The radiator fan may still run for some time after the engine is shut down.

Emergency flameout

During driving, long press the Start switch or press the Start switch three times fast continuously, then the Start switch will switch from "ON" to "ACC" position to stop the engine and achieve emergency flameout.

The engine can be restarted a few seconds after emergency flameout. Restart the engine in accordance with the following operations:

- Vehicle Models with Automatic Transmission: Put the gearshift to **-P** position or "N" position, and press the Start switch to start the vehicle.
- Vehicle Models with Manual Transmission: Put the gearshift to "N" position, and press the Start switch to start the vehicle.

Warning

No emergency flameout is allowed in normal driving. It may be easy to cause vehicle damage, failure of safety protection and power steering as well as traffic accident.

Precautions for Parking

When parking, put the gearshift to the "P" gear or the neutral gear and pay attention to the following matters:

- Pay attention to the car parking direction and do not make the exhaust discharged to the plant to damage the green belt.
- Try to park on a straight road and avoid a steep slope.
- When parking, no matter the car faces the top or base of a slope, the front wheels should face curb.
- The vehicle should be applied with the parking brake. Shut down the engine, and turn off all lights and other electrical equipment.
- When leaving the vehicle, be sure to bring your valuables and vehicle keys with you, and confirm that the skylight, window, door and hatchback door are locked.
- Check whether the anti-theft start locking system indicator light  on the instrument cluster is on, and confirm that the anti-theft system has been activated.

Warning

- When leaving the car, shut down the engine, apply the parking brake, and carry the car keys with you.
- Do not leave any person in the car. Otherwise, person in the confined car is likely to lose consciousness or even die due to suffocation.
- Do not park vehicles near flammable and explosive items.

5. Driving Directions

5.1.4 Gear Instructions

Vehicle Models with Automatic Transmission*

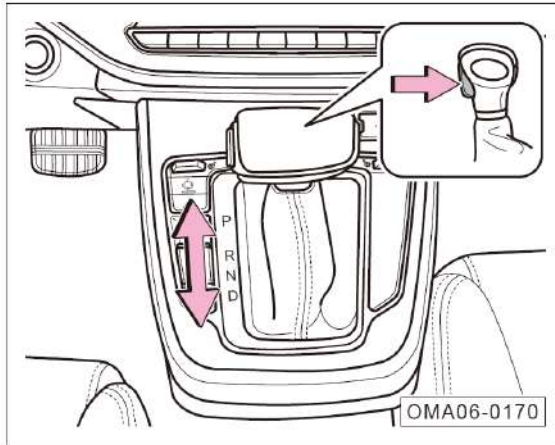

Available positions of the gearshift include "P, R, N, and D". With the Ignition switch at "ON" position, after the gearshift is switched to certain position, the instrument cluster will display the corresponding position information.

Warning

The "R" or "P" position can be switched when the vehicle is completely stationary. Otherwise, it may damage the transmission.

P: PARK

- When the vehicle is completely at rest, press the unlock button at the front end of the gearshift to switch the gearshift to the **P** gear.
- Depress the brake pedal and press the unlock button at the front end of the gearshift to switch the gearshift out of "P" gear.

R: Reverse

- When the car is completely at rest, depress the brake pedal and press the unlock button at the front end of the gearshift to switch the gearshift to "P" gear.
- Release the brake pedal and depress the accelerator pedal slowly to reverse the car.

N: Neutral

- You can directly put the gearshift from "R" or "D" to **N** gear.
- Please depress the brake pedal when switching the gearshift out of "N" gear.

Warning

When driving, do not switch to "N" gear to slide. Otherwise, it can easily cause an accident.

D: Drive

This gear is engaged generally during driving.

- The gearshift is directly moved from "N" to **D** gear. At this gear, the system will automatically upshift or downshift according to engine load and car speed.

Driving Mode

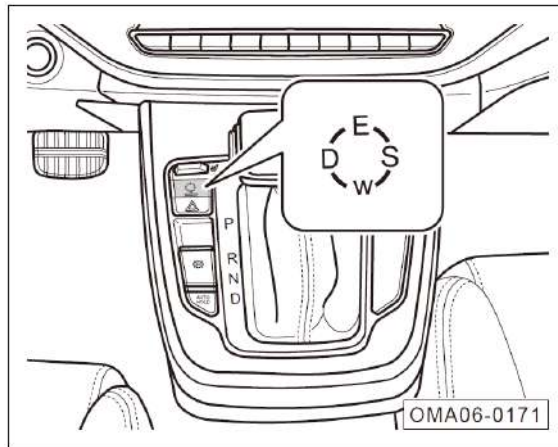

With the Ignition switch at "ON" position, press the driving mode button to switch the "W→D→E→S" mode.

W -Winter Mode

When the car is in this mode, the transmission will control the starting gear automatically to ensure more stable and softer torque output of the car to avoid slipping of the car on road with ice and snow or other slippery roads and help the driver control the car in snowfield more easily.

i Hint

Winter mode will limit the PTO of the engine, so that it is suggested that the winter mode should only be used when driving on road with ice and snow or other slippery roads; while on other roads, the winter mode is not recommended, so as to avoid influencing the drivability and fuel economy.

D -Default mode

In general, the transmission is in the "D" mode by default.

E -ECO Mode

When the vehicle is in this mode, not only the economic gear shift strategy is applied for the TCU, but the corresponding economic strategy is adopted for the A/C system.

i Hint

- When the car enters ECO mode, the "ECO" indicator light on the instrument cluster is on.
- ECO mode can be applied when the gearshift is at "P, R, N, D" gear, but only works at "D" gear.
- The ECO mode has a memory function, that is, when the engine is restarted after flameout, the transmission will remain in ECO mode.

S-Motion mode

The "S" mode is mainly used for driving in the pursuit of dynamic driving and driving on mountainous road, to prevent frequent shifting. When the vehicle enters this mode, the transmission will downshift to a lower gear according to resistance change (such as pulling and uphill driving), and the engine will run at a higher speed to provide greater power.

When the vehicle enters this mode, press "+/-" on the side of the gearshift for upshift/downshift to enter manual mode.

i Hint

In non-S mode, with the gearshift at "D" position, the driver can directly operate the "+/-" button on the side of the gearshift for upshift/downshift to realize manual mode intervention for a short time. It will automatically recover to the original mode after a certain time. However, the manual mode entered from S mode will be in manual mode for a long time.

Unlocking the Gearshift Locking

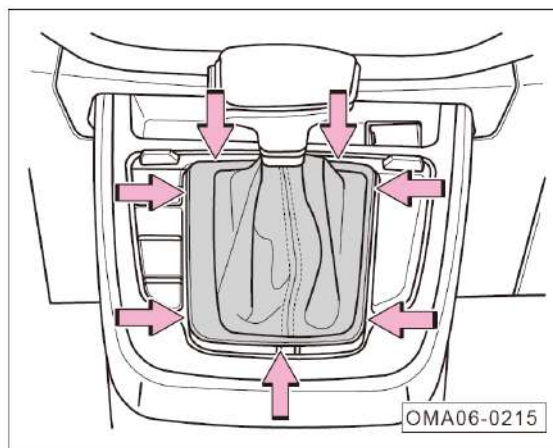

When the gearshift cannot be moved out of the "P" position due to being locked, the gearshift locking shall be released.

- Turn off the ignition switch.
- Prise out the gearshift leather cover ① in the direction of the arrow.

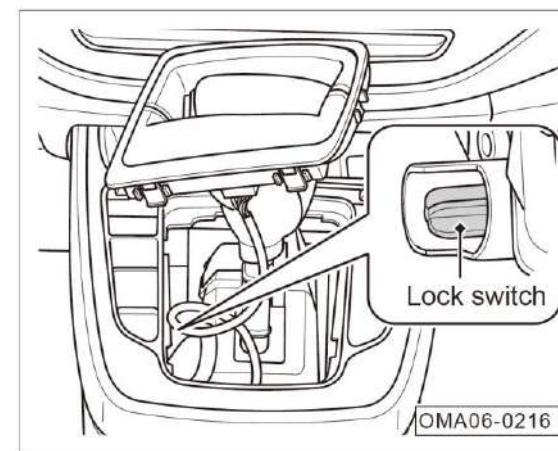

- Press the lock switch to unlock, press the unlock button at the front end of the gearshift at the same time, and then switch the gearshift from "P" position to "N" position.
- Install the gearshift leather cover.
- Press the brake pedal, start the engine and check whether the gearshift restores the normal engagement operation.

Caution

If the gearshift is locked and cannot be withdrawn from the "P" gear, this method can be used for withdrawal. However, the occurrence of this failure usually indicates that the car may have problems and should be checked and repaired as soon as possible at your authorized GAC MOTOR special store.

Vehicle Models with Manual Transmission

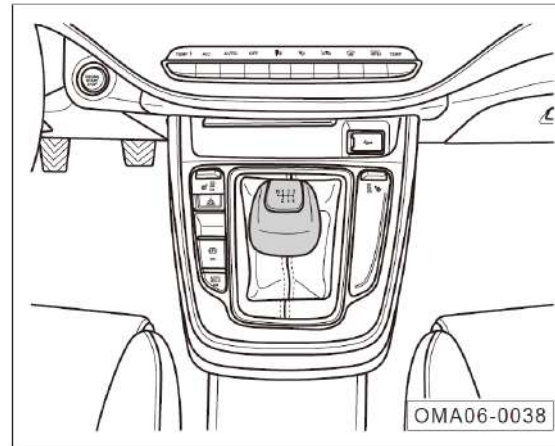

Gear positions of the models equipped with manual transmission are -R, 1, 2, 3, 4, 5 or 6".

- Depress the clutch pedal to full range in case of gear shift during driving to switch the shift lever to the gear positions of 1, 2, 3, 4, 5 or 6.

Switch to reverse gear

- When the car is completely at rest, depress the clutch pedal to full range.
- Press the unlock button at the front end of the gearshift to switch the gearshift to the -R" gear.

i Hint

- When putting to "R" position, make sure that the vehicle is completely stationary and that the engine speed is not too high. Otherwise, the transmission may be damaged.
- Use soft power to gear shift and avoid excessive force.
- Avoid starting at high speed.
- Do not put your hands on the gearshift during the driving, so as not to break the fork prematurely.

5. Driving Directions

5.2 Brake System

5.2.1 Service Brake

When you press down or slightly press the brake pedal for the first time under some driving or weather conditions, you may hear the brake squeaking or screaming, or other noise. Or you may hear braking noise occasionally during mild or moderate braking, especially in a new vehicle (without brake running-in). It is normal and not an indication that the brake system is faulty or that the brake safety and performance are affected.

Caution

- If there is any metal-to-metal sharp friction sound, the brake lining may be close to its wear limit. You should go to any authorized GAC MOTOR special store for maintenance as soon as possible.
- If the steering wheel keeps vibrating or oscillating during braking of the vehicle, you should go to any authorized GAC MOTOR special store for maintenance as soon as possible

Hint

- Do not put your foot on the brake pedal to rest when driving. Otherwise, the temperature of the brake may rise abnormally, resulting in excessive wear of the brake lining and brake pad and longer braking distance.
- When driving down a long or steep slope, set the transmission to a lower gear to avoid continuous use of the brake, make full use of the engine to brake and reduce the load of the brake.
- Continuous use of the brake may result in overheating of the brake and temporary loss of brake performance.

Hint

- Brake dust may accumulate on the wheel under normal driving conditions due to the wear of the brake. It is inevitable. A small amount of brake dust will not affect the brake performance.
- If the brake lining and brake disc are rusty because they are not used or they are used at a low rate, the brake may make a noise when it is pressed for the first time. It is normal. It is recommended to brake the vehicle several times in a safe area or on a safe road to clean the brake lining and brake disc.

Brake Booster

Brake boosters are used to increase the pressure that the driver applies on the brake pedal, but they do not work until the engine is running.

If a brake booster cannot work properly due to any fault or the vehicle is being towed, the pressure on the brake pedal should be increased to compensate the boosting effect of the brake booster.

Warning

- Do not make your vehicle slide under inertia with the engine off. Otherwise, it is easy to cause accidents because the brake booster will not function and the braking distance will be much longer.
- If the brake booster does not work (for instance, when the vehicle is being towed), press the brake pedal with much greater force than normally required.

Braking Effect and Braking Distance

The braking effect and braking distance depend on driving environments, road conditions and driving styles.

A worn brake pad cannot provide effective braking. The wear speed of a brake lining mainly depends on service conditions and driving styles. For a vehicle for frequent urban driving, short drive or racing, it is recommended to check the thickness of the brake pad more frequently within the maintenance cycle specified in the *Maintenance Manual*.

The brake pad may become damp or icy in winter after wading, rainstorm or vehicle washing, reducing brake effect. In this case, press down the brake pedal slightly to heat the brake by friction to make water evaporate and restore the braking effects. Replace the brake fluid once every two years. If the brake fluid is left in the brake system for a too long time, air resistance may be generated in the pipe of the brake, degrading braking effects.

Warning

The best adhesion and friction characteristics cannot be realized for new tires and braking pad without running-in.

- As new tires do not yet have the best traction, you must drive carefully for the first 500 km to avoid accidents!
- As a new brake pad does not yet have the best friction feature for the first 200-300 km, reducing the braking effects, it must go through a running-in. An increased force on the brake pedal can compensate the braking effect. After replacement, the new brake pad shall also go through running-in.
- Do not drive too close to other vehicles or in situations where emergency braking is likely to occur. Drive carefully especially when new tires or brake pads without running-in are used. Avoid the above mentioned situations and prevent accidents.

5. Driving Directions

Warning

The braking may be delayed if the brake is damp or icy or when the vehicle passes a road with salt. Drive carefully in such cases to prevent accidents.

- A longer braking distance or a faulty braking system may increase the accident rate.
- Press the brake pedal slightly to check it.
- Press the brake pedal slightly to dry it and remove the ice or anti-skid salt on it.

Warning

An overheated brake will reduce braking effects and lengthen the braking distance.

- Take care to avoid overheating the brake.
- The brake load will increase when the vehicle is driven down a slope, leading to overheating easily.
- It is recommended to shift to a low gear when the vehicle is driven down on a long slope to decelerate the vehicle, make full use of the braking effects of the engine and reduce the load of the brake.
- Do not press the brake pedal continuously. Otherwise, the brake may be overheated and the braking distance may be longer. Brake the vehicle intermittently based on road and traffic conditions.
- Do not make your vehicle slide under inertia, with the engine off. Otherwise, it is easy to cause accidents because the brake booster will not function and the braking distance will be much longer.

Warning

- Replace the brake fluid once every two years. If the brake fluid is left in the brake system for a too long time, air resistance may be generated in the pipe of the brake, degrading braking effects and driving safety or even leading to a failure of the brake system. It is easy to cause accidents in such conditions.
- Both the non-standard front spoiler and damaged spoiler may block the cooling air to the brake, resulting in brake overheating and degrading braking effects.

5.2.2 Electronic Parking Brake (EPB) System

By operating the buttons of the EPB, the driver can apply or release braking. In ramp conditions, auxiliary starting function can be used. Under the parking situation, after depressing the accelerator pedal, EPB will be released automatically provide the driver with a convenient driving assistance.

Caution

The EPB system will park the car with fixed force according to slope. If:

- If the car glides after ramp parking, the EPB will increase the braking force automatically.
- If the car continues to glide after the automatic increase of braking force, please depress the brake pedal and stop the car on a flat road. Please contact the authorized GAC MOTOR special store for maintenance as soon as possible.

Applying Static Parking Brake

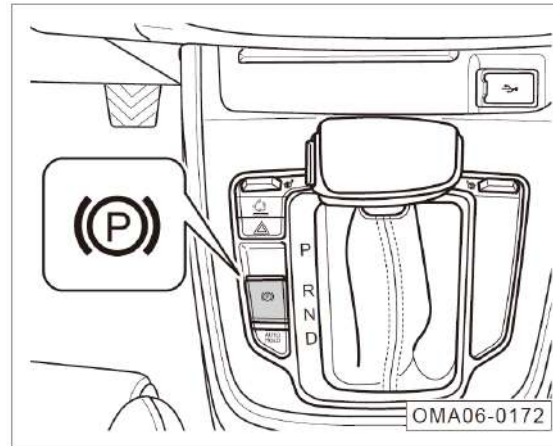

- When the vehicle is still, pull up EPB button, the button indicator light and indicator light on the instrument cluster (P) are on, which indicates that the EPB has been applied.

Hint

- The EPB can be applied when the ignition switch is at the "OFF" position.
- After the vehicle is parked steadily, apply the EPB first.
- Applying the EPB may generate running noise, which is a normal phenomenon.
- If the car is used to pull other vehicles or is parked on a ramp with larger slope, pull the EPB system button again after the completion of first application of EPB to ensure the maximum parking force.
- On the slope of 17 ~ 30%, a clamping will be performed again 5min later upon the first application of the EPB. Running noise is normal at this moment.

5. Driving Directions

Caution

- The EPB must be applied when parking.
- When the vehicle is in driving process, it is not allowable to decrease the speed by using EPB when unnecessary, because the parking brake only exerts power on the rear wheels, which can easily cause traffic accidents.

Releasing Static Parking Brake

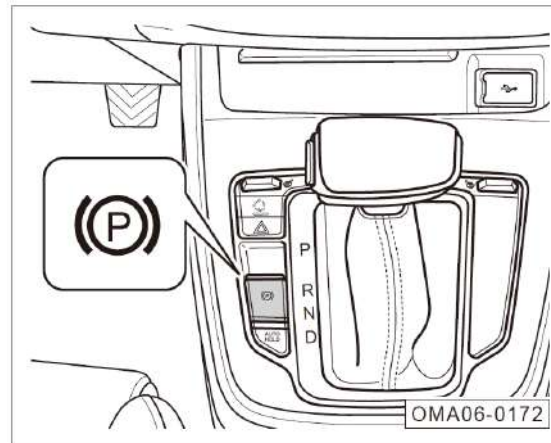

- Press the brake pedal when the ignition switch is at the “ON” position.
- Press the EPB system button ①, the button indicator light and ② the indicator light on the instrument cluster are off, which indicates that the EPB has been released.

Hint

- If the brake pedal is not depressed, the EPB will not be released by pressing the EPB system button, and the instrument cluster display will show the alarm message, accompanied with a beeping alarm.
- Releasing the EPB may generate running noise, which is a normal phenomenon.
- In case of low battery, the EPB cannot be released. Conduct the emergency start through bridging the cable if allowable (=> Refer to Page 245), and then release the EPB. Please contact your authorized GAC MOTOR special store for handling.
- If the EPB is not applied for a long time, the system will detect the conditions automatically with audible running noise.

Applying Dynamic Emergency Brake

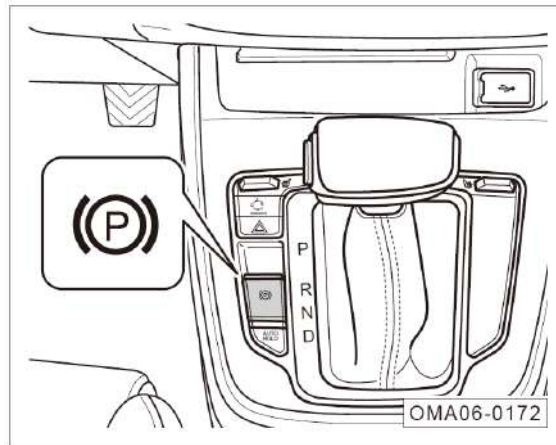

- If the service brake fails during driving, try to pull the EPB button continuously for an emergency braking. Release the EPB system button or depress the accelerator pedal to exit the emergency braking.

Caution

In case of any of the following phenomena, please operate the EPB again. If the fault persists, please go to any authorized GAC MOTOR special store for maintenance.

- If the indicator light (P) flashes in red continuously, it indicates that the EPB is in partial combination/ removal state or there is a fault in the system.
- If the indicator light (P) lights up in red when the EPB is not applied, the system is abnormal.
- If the indicator light (P) (yellow) is on, it indicates that a fault is detected in the EPB system and the EPB performance decreases.

Caution

- Do not apply the dynamic emergency braking when unnecessary, which can easily cause traffic accidents. In addition, the dynamic emergency braking distance is longer than pedal braking distance, and the service life of the parking brake system will be shortened.
- During driving, pull the EPB system button. The instrument cluster display will show the alarm message, accompanied with a beeping alarm.
- During the deceleration, the release state of parking brake can be recovered by releasing the EPB or depressing the accelerator pedal. If the EPB system is continuously pulled up until the vehicle is stopped, the parking brake will remain in combination state.

5. Driving Directions

AUTO HOLD

AUTO HOLD will keep the car still automatically according to the driver's braking needs; the braking will be released automatically when the system detects the driver's intention to start (e.g., depressing the accelerator pedal); it can ensure the start convenience under auto release condition based on the ramp information and make the car still by supercharging actively when the braking force is insufficient.

On and Off

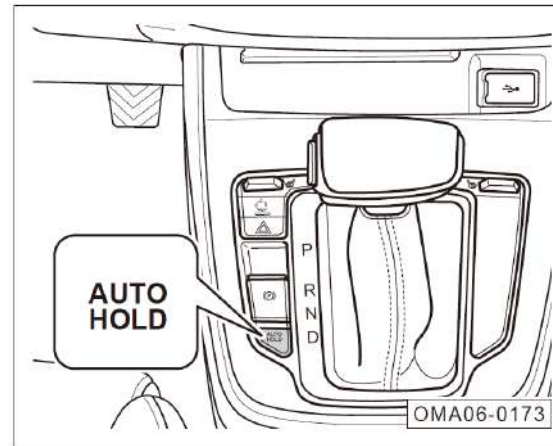

- When the engine is started and the driver's safety belt is fastened, press the automatic parking button. Then the indicator light is on and the automatic parking function is enabled. Press the button again. Then the indicator light is off and the automatic parking function is disabled.

Activation

After being activated, the function supports the auto holding and releasing of brake in moving and stopping conditions. When the driver stops the vehicle by using brake, the vehicle will be parked automatically to avoid the sliding at starting.

Deactivation

The AUTO HOLD function will be deactivated and the parking brake will not be locked in following conditions:

1. The accelerator pedal is depressed at starting.
2. The engine is shut down during driving.
3. The EPB is released manually.
4. Press the automatic parking button when depressing the brake pedal.

In order to ensure safety, the AUTO HOLD function activated will be disabled and the parking brake will be locked in the following conditions:

1. The engine is shut down.
2. The driver side door is opened or the seat belt is unbuckled in stop state.
3. Press the automatic parking button to disable automatic parking function.

 **Caution**

When the car is transferred via conveyor belt to cleaning device and other devices, the AUTO HOLD function must be disabled. Otherwise, the car cannot move or may deviate from the driving track.

EPB Adaptive Learning

In some cases (e.g. the battery suffers power failure suddenly, or the car has not been used for a long time), the red indicator light (P) will flicker, and manually pulling the EPB button will cause EPB unable to work. In this case, the driver shall depress the brake pedal and press EPB button to make EPB execute adaptive learning, enabling EPB to work normally.

5. Driving Directions

5.3 Service Electronic Brake System

5.3.1 Anti-Lock Braking System (ABS)

When the driver brakes, the ABS will automatically monitor the slip rate of all front and rear wheels. Before wheel lock, the wheel cylinder hydraulic is adjusted through such stages as pressure maintaining, pressure reduction, and pressure boost, to make the wheel slip rate within a specified range to prevent wheel lock.







The driver will feel the vibration of brake pedal accompanied by the “tick” sound produced by brake master cylinder operation when depressing the brake pedal in emergency. In this case, the ABS is in operating state. Under the following conditions, ABS will operate by depressing the brake pedal. It is normal to feel vibration:

- When shifting gears.
- During emergency braking.
- When turning at high speed.
- When driving on slippery road.
- When driving on projected or pit road.
- When making sudden start after the vehicle is started.

Anti-lock brake system (ABS) indicator light

Switch the Start or Ignition switch to the "ON" position, the indicator light  illuminates for a few seconds then extinguishes after self-checking.

The occurrence of the following conditions indicates that there is a fault in the system:

- The start switch is switched to the "ON" position, but the indicator light  is not on.
- The Start switch is switched to "ON" position, but the indicator light  is still on after a few of seconds.
- When the vehicle is running, the indicator light  is on.
- When the ABS is faulty, the indicator lights ,  and  will turn on.

Electric Brakeforce Distribution (EBD)

EBD system is a part of ABS and used for balancing the brakeforce distribution on front and rear wheels according to the vehicle load in conventional vehicle braking.

EBD exerts more brakeforce on the rear wheel through adjusting slip rate to obtain the shortest braking distance under the premise of ensuring braking stability. In particular, the stability and maneuverability of vehicle braking are improved when driving on a road with poor conditions or a slippery road.

Hydraulic Brake Assist (HBA)

The Hydraulic Brake Assist (HBA) assists you to have shorter braking distance in emergency by utilizing the pressure rapidly generated in the braking system. It makes full use of the characteristics of ABS. The HBA will be deactivated automatically when the brake pedal is released, and then the braking system will return to its normal working state.

Most drivers can hit the brakes timely in dangerous situation, but cannot depress the brake pedal with enough force in a short time. Therefore, the braking system does not produce maximum brakeforce, resulting in the increase of braking distance, increasing the risk of the accidents.

However, for vehicles with HBA, quickly depressing the brake pedal and maintaining the state will produce a greater brakeforce than that under normal braking, which gives full play to critical value of ABS, enabling the braking system to produce the pressure required for the maximum deceleration in the shortest time. Therefore, the shortest braking distance is obtained.

Warning

HBA can improve driving safety, but it is impossible to go beyond kinematics rules. Please adjust your driving speed according to the road condition and regulated traffic speed.



5. Driving Directions

5.3.2 Electronic Stability Program (ESP)

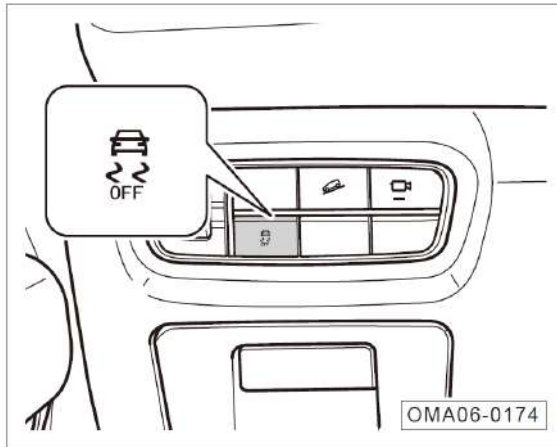

ESP can effectively reduce the risk of vehicle sliding.

On and Off









The ESP is activated by default when the vehicle is moving. The ESP can be shut down by long pressing the button  (longer than 3s but shorter than 10s). Then the indicator light  is on and the warning information is displayed.

Hint

- The ESP will be activated automatically when the vehicle speed is greater than 80 km/h.
- The ESP deactivated can be reactivated by pressing  button at a speed of less than 80 km/h.
- When pressing the  button, if it is pressed for more than 10 seconds, the system will consider it as wrong operation but it will not have any effect on the working state of the system.

ESP indicator light

- Switch the ignition switch to the "ON" position. Then the indicator lights  and  are on for a few seconds and then off after a self-check.
- If the ESP works in the driving process, the indicator light  will flash.
- The indicator light  will light up after the ESP is deactivated.
- The indicator light  will light up when the ESP fails to function.

If the  indicator light is turned on after the vehicle is started, it indicates that the ESP is deactivated. The instrument cluster display will show the alarm message. You may try to put the Ignition switch to "OFF" position, and then to "ON" position to restart the system. When the  indicator light is turned off, it indicates that the system is in operating state.

The indicator light  may be on when you reconnect the battery joint to cable after disconnection and turn on the Ignition switch, and it shall be off after short-distance driving.

The ESP should be activated for driving safety. The ESP function can be deactivated in special circumstances:

- The vehicle is running with tire chain.
- The vehicle is running on deep snowy or spongy road.
- The vehicle gets stuck in muddy road or other roads, and needs to be moved back and forth.

Traction Control System (TCS)

Traction Control System (TCS) is the subsystem of the ESP. It can judge whether the drive wheel is skidding according to rotation speed of drive wheel and driven wheel. When the rotation speed of drive wheel is higher than that of driven wheel, the TCS can control the rotation speed of drive wheel to prevent the vehicle from sliding.

When the ESP is activated or deactivated, the TCS is activated or deactivated too.

5. Driving Directions

5.3.3 Hill Hold Control (HHC)

HHC can prevent the vehicle from accident due to sliding when starting on slopes without using the parking brake.

Activation Conditions for HHC

- HHC is activated to apply braking pressure to vehicle with pressure maintenance time of 1 second, if the driver loosen the brake pedal in following condition: When ramp slope is more than 4%, the gearshift is not in "P" or "N" gear, EPB is not applied, the driver depresses on the brake pedal to stop the vehicle and the vehicle is in static state.
- During the working time of HHC, when the engine torque exceeds the vehicle resistance torque, the braking pressure will be released and the activation will be completed successfully.
- HHC also works when the vehicle goes downhill and the gearshift is switched to "R" gear.

Hint

- The HHC will apply a brakeforce automatically when starting on a steep uphill or shifting to reverse gear on downhill, to prevent slipping.
- HHC is integrated on the ESP system. If the HHC fails, the ESP indicator light will be on and alarm message will appear on the instrument cluster display accordingly.

5.3.4 Hill Descent Control (HDC)

HDC is the subsystem of the ESP. In the downhill process, the HDC exerts the brakeforce to drive down the slope actively through ESP without depressing the brake pedal.

On and Off

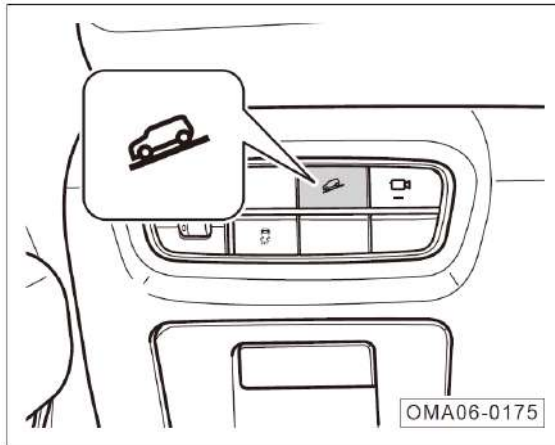

- When the vehicle speed is less than 35 km/h, press the button to activate the HDC. The  indicator light will turn on. When the HDC operates, the brake light turns on.

- Press the button again to deactivate the HDC and turn off the  indicator light.

After activating the HDC, the vehicle will travel at the minimum speed of 8 km/h and maintain this speed constant during downhill without depressing the brake pedal.

The driver can depress the accelerator pedal or the brake pedal to adjust the speed:

- If the driver releases the pedal at a speed of 8~35 km/h, the HDC will be activated again and the vehicle will continue to move downhill at such a speed.
- The HDC is automatically deactivated after the vehicle exceeds 60km/h.
- When the HDC control is effective, if the wheel skids excessively, the ESP, the ESP will be activated automatically.

Hint

- When the HDC fails, it will be deactivated automatically, and the instrument cluster display will show alarm information, accompanied with audible alarm for about 5s. In this case, the HDC system will not work properly. The driver shall depress the brake pedal when traveling down a steep slope, and go to authorized GAC MOTOR special store for maintenance as soon as possible.
- Under some special circumstances, HDC will be in thermal protection mode due to high braking temperature. For example, if the system is used for a long time at relatively high ambient temperature, the temperature of braking system will increase constantly due to friction; when the limit value is reached, HDC will enter thermal protection mode: this function is activated but does not work. The vehicle will show acceleration sign; HDC will work again when the temperature of braking system drops to effective working temperature.

5. Driving Directions

5.4 Driver Assistance System

5.4.1 Cruise Control System *



The cruise control system can be set at 40km/h or higher. Once the speed is set, the driver can release the accelerator pedal and the car will run at the preset speed.

Warning

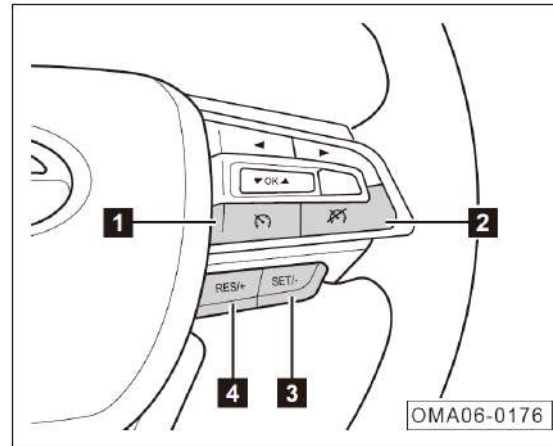

- To avoid accidents, the cruise control system cannot be used where there is dense traffic, hills, winding roads, or slippery roads.
- Use the cruise control system carefully. Make sure that the vehicle has a safe distance from the front one after the speed is set.

Operation Button





1. : Enable/disable cruise
2. : Stop cruise control
3. SET/-: Activate the cruise control function/deceleration
4. RES/+: Restore the cruise control function/acceleration

Enable cruise

- Short press the button  to turn on the cruise control system. Then the indicator light  on the instrument cluster goes on in white.
- Increase the speed to more than 40 km/h.
- Short press the button -SET/--. The indicator light  on the instrument cluster turns to green and the vehicle enters the cruise control state.

Stopping Cruise Control

The following operations will stop cruise control:

- Step on the brake pedal.
- Short press the button  (stopping cruise control but retain the set speed).
- Short press the button  (stopping cruise control and clear the set speed).
- Operate the EPB button.
- ESP system starts.

Restoring Cruise Control

With the cruise control system activated, after the cruise control is exited, the  indicator light in the instrument cluster will turn to white. Short press the "RES/+" button to restore:

- When the speed is above 40 km/h with short pressing of the button "RES/+", the indicator light  on the instrument cluster will turn to green from white and the speed will restore to the previously set cruise speed.

Increasing Cruising Speed

- Short press the RES/+ button to increase the speed by 2 km/h each time.
- Long press the RES/+ button to increase the speed continuously until the button is released.

Hint

- The allowable maximum cruising speed is 140km/h. The speed above 140km/h cannot be adjusted through pressing the RES/+ button.
- The car exits the cruise control mode as the accelerator is stepped on and then runs at the accelerated speed; after the accelerator pedal is released, the car will restore the cruise control.

Decreasing Cruising Speed

- Short press the SET/- button to decrease the speed by 2 km/h each time.
- Long press the SET/- button to decrease the speed continuously until the button is released.

Hint

The speed below 40 km/h cannot be adjusted through pressing the SET/- button again.

5. Driving Directions

5.4.2 Tire Pressure Monitoring System (TPMS) *

The tire pressure monitoring system (TPMS) monitors the tire pressure and temperature and has current tire pressure and temperature shown on the instrument cluster.

Ignition switch is at "ON" position, if the car does not move or moves at a speed lower than 25 km/h, the pressure and temperature values on the instrument cluster are both displayed as "--" on the instrument cluster. After the speed is higher than 25 km/h, the instrument cluster displays current tire pressure and temperature.

- If the tire pressure is higher than 330 Kpa, the (⚠) indicator light will be on, and the instrument cluster will display the alarm message of "high tire pressure".
- If the tire pressure is lower than 190 Kpa, the (⚠) indicator light will be on, and the instrument cluster will display the alarm message of "low tire pressure".
- If the tire pressure continuously decreases below a specified value, the (⚠) indicator light will be on, and the instrument cluster will display the alarm message of "tire leakage".

- If the tire temperature is higher than 85°C, the (⚠) indicator light will be on, and the instrument cluster will display the alarm message of "high tire temperature".

⚠ Caution

- Some added electronic equipment may cause abnormal operation of the TPMS due to interference.
- If it is necessary to replace the tire pressure sensor, or replace or reposition the tire, TPMS shall be learned and matched again. Please go to your GAC MOTOR dealer for learning and matching.

i Hint

- If the tire suffers high temperature, high pressure, low pressure, or rapid air leakage, the instrument cluster will give early warning, with position of the failed tire displayed in circular manner. If the TPMS fails, the instrument cluster will give "Please check the TPMS" displayed in circular manner.
- Where there is high temperature alarm, it is recommended to stop the car and wait until the tires cool.
- The traveling alarm not handled until the car stops will remain when the car starts again, with pressure and temperature displayed as "--". But when the speed exceeds 25 km/h, the receiver will receive updated data and update relevant data, and then the alarm disappears.
- After replacing with a spare tire or with a new tire in some other places, the low tire pressure alarm lasts during traveling because of the missing tire sensor. Do not mistake this as abnormal tire pressure signal.

5.5 Reversing Assist System

5.5.1 Parking Sensor System

Parking sensor system transmits and receives ultrasonic waves via the radar sensor and calculates the distance between the vehicle and the obstacle based on the ultrasonic waves sent and reflected upon coming across an obstacle.

On and Off

When the EPB is released, the gearshift is put to **R** position and the reversing speed is less than 10 km/h, the parking sensor system will work. When the vehicle speed is greater than 12 km/h, the parking sensor system will stop working. When the gearshift is moved out of "R" position, and the EPB is applied, the parking sensor system will also stop working.

Dynamic Icon *

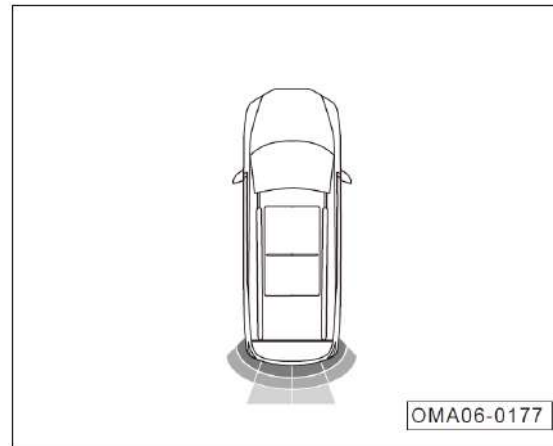

The dynamic icon shown on the display will indicate the distance from the vehicle to the obstacle. The outermost layer of the vehicle as is in green line as shown in the figure. The line will turn to yellow and red gradually from the outside to the inside. When the obstacle is closer to the vehicle, the color lines will gradually disappear.

The change of such dynamic icons synchronizes with the change of distance reference alarm sound.

Distribution of Radar Sensor

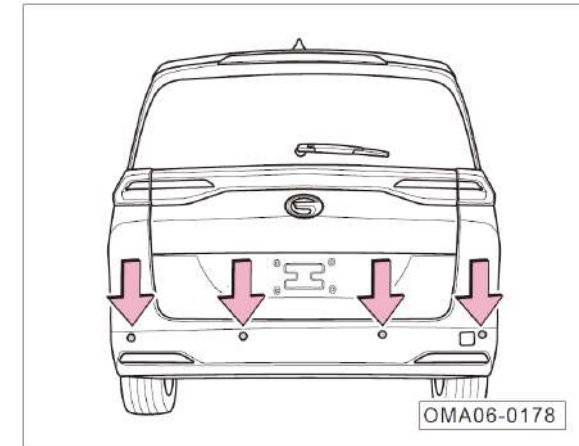

The radar sensor is installed on the rear bumper cover.

5. Driving Directions

Caution

- Always keep the radar sensor surface clean, and do not cover the radar sensor.
- Keep the radar sensor clean and avoid icing to ensure its function.
- Clean the radar sensor surface with soft wet cloth to avoid surface scratching.

Warning

- The parking sensor system does not take the place of the driver's observation to the surrounding environment, so the driver shall focus attention on reversing safely parking position according to actual conditions.
- There may be blind spot when the radar sensor is detecting obstacles, so the driver must observe carefully during reversing, to avoid accident.
- During reversing in a narrow space or on uphill, the radar sensor may not detect railings, trees or slope, which is considered normal.
- At fast reversing speed, the detection accuracy of the radar sensor may decrease somewhat. It is suggested that the reversing speed should not exceed 10km/h. The continuous alarm sound from the parking radar system indicates that the car is very close to the obstacles. The driver shall stop revising immediately to avoid accident.

Warning

- Clean the radar sensor with high pressure cleaning device in a short time and in gentle manner; keep at least 10 cm between the nozzle and the sensor.
- Water drops on the radar sensor can influence sensitivity of the sensor. To restore sensitivity, wipe off the water drops.
- Surfaces of certain materials cannot reflect the signals from the radar sensor, so that the sensor cannot detect such objects or persons in clothes made of such materials.
- The radar sensor may not detect the objects if interfered by outside noise.
- The radar sensor is a precision part. Do not dismantle or repair it by yourself. Damage caused by such dismantling or repairing is not covered in the warranty of GAC MOTOR.

5. Driving Directions

Detected Distance to Obstacles				Alarm Sound
Rear left sensor	Rear right sensor	Rear left middle sensor	Rear right middle sensor	
		90~150cm	90~150cm	Low-speed intermittent alarm sound
		60~90cm	60~90cm	Low-speed intermittent alarm sound
30~60cm	30~60cm	30~60cm	30~60cm	High-speed intermittent alarm sound
Within 30cm	Within 30cm	Within 30cm	Within 30cm	Continuous alarm sound

Distance Reference Alarm Sound

The alarm sound changes with the distance between the obstacles and the rear bumper; meanwhile the color shown on the audio system display also changes. If the car is approaching an obstacle, the system will give out audible alarms. The shorter the distance between the car and the obstacle is, the shorter the alarm sound will be; if the distance is very short, the system will give out continuous alarm sound. If, under this case, the car continues approaching the obstacle, the system will be unable to detect the obstacle any more.

5. Driving Directions

5.5.2 Reversing Rear-view System *

The reversing rear-view system can provide 130° wide-angle video coverage, display a wide range of rear view by video on the audio system display to help the driver see the complex road conditions behind the car, enhancing the reversing safety.

On and Off

When the Ignition switch is at "ON" position, placing the gearshift at "R" position can make the reversing rear-view system work automatically, and the audio system display will start displaying the rear shot images marked with the reference distance line.

Switching the shift lever from "R" position can make the reversing rear-view system exit automatically, and the audio system will stop displaying reversing image.

Warning

The reversing rear-view system does not take the place of the driver's observation to the surrounding environment, so the driver shall focus attention on reversing safely parking position according to actual conditions.

Reference Distance Line

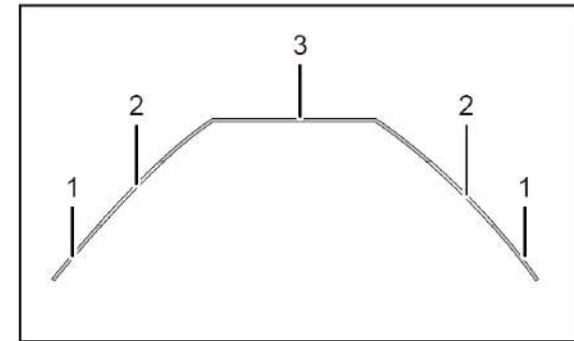

The lines in three colors on the display represent the reference horizontal distance between the line position and the vehicle.

Line 1: 0.1~0.5m

Line 2: 0.5~1m

Line 3: 1~3m

Caution

The above distance is measured on flat ground and is only taken as a reference value of view distance. If there is a slope, the above distance may be deviated.

Hint

- The longitudinal lines on both sides of the reference distance line can be used as the reference lines for determination of the required space for reversing.
- The reference distance lines change with turning of the steering wheel.

Rear-view camera

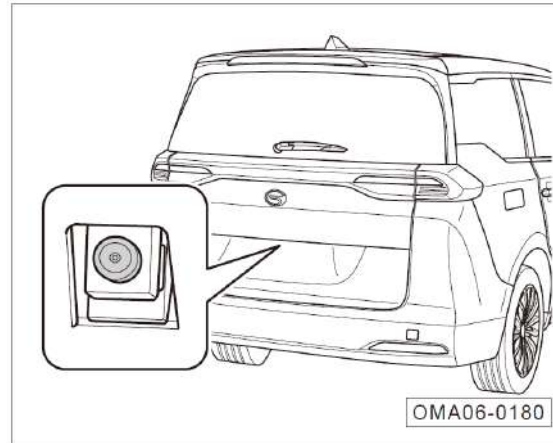

The rear-view camera is installed beside the number plate light.

Warning

- Blind spot exist in detecting scope of the rear-view camera, because the camera may be unable to detect children or small animals. Pay special attention to children or small animals around when reversing.

Warning

- Upright objects with higher elevation, such as protruding wall edges, may also not be detected by the rear-view camera.

Caution

- Always keep the rear-view camera surface clean. When cleaning the rear-view camera, use soft wet cloth to avoid scratching.
- Do not use high pressure cleaning device to clean the rear-view camera for a long time, and keep a distance of at least 30 cm from the rear-view camera when cleaning.
- Do not cover the rear-view camera.

5. Driving Directions



5.5.3 Panorama Parking System *

The panoramic parking system captures images at front, rear, left and right sides of the car and merges them into a 360° aerial view, which is displayed via audio system display to provide the information of environment around the vehicle to the driver to reduce the blind spots of driving. It can also forecast the movement track of the vehicle in combination with steering wheel angle and vehicle dimensions and other related parameters, and adding such information into the panoramic image can make the driver fully understand the traveling direction of the vehicle and judge whether the reversing is safe.

On and Off

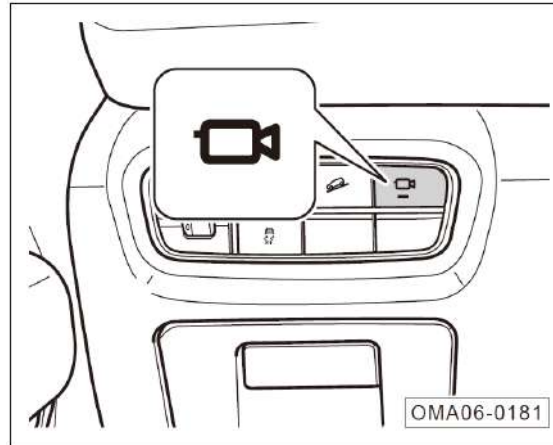
1. Turn on/off the system with the gearshift when the ignition switch is at the -ON position:
 - Placing at -R position can make the system automatically start.
 - The gearshift is shifted from -R gear and no other operation is performed by the driver, the system will exit automatically after 30 seconds of display.



2. Turn on/off the system with the button when the ignition switch is at the -ON position:
 - Short press  button, the button light will light on and the system will start.
 - Short press  button again, the button light goes out and the system shuts down.

Hint

- When the system starts, the audio system display will show the images shot around the vehicle and auxiliary lines.
- If the forward vehicle speed is greater than 20 km/h, the system will automatically shut down.
- If the vehicle is not on -R gear and the system has been activated for more than 30s, the system will automatically stop (when the speed is zero).
- The system cannot work normally if the audio system is not turned on fully.

Interface Description

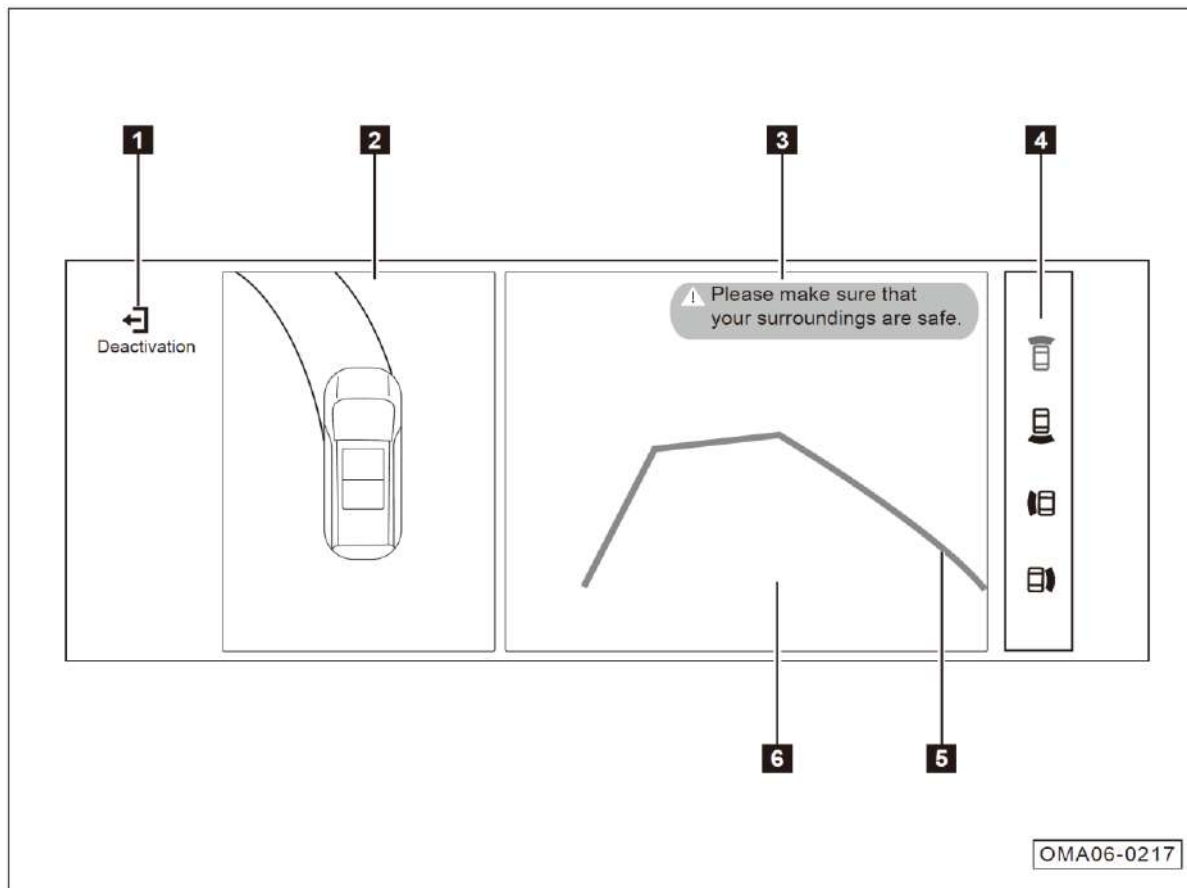

1. Soft exit key
2. Mosaic display zone
3. Text prompt
4. View angle prompt
5. Dynamic trajectory
6. Single view display zone

5. Driving Directions

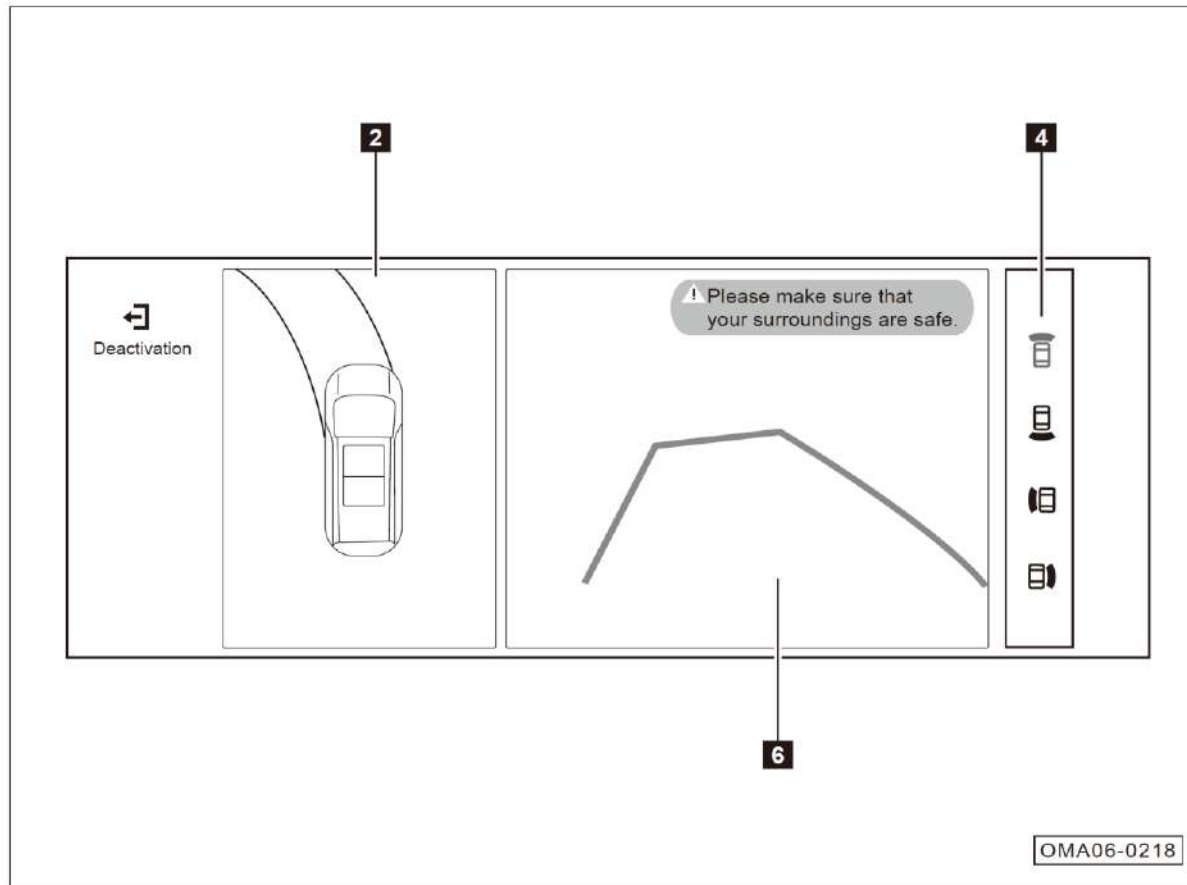

When the system works, enter the 2D view interface:

- Touch the front/rear/left/right zone of the vehicle in the mosaic display zone ② or the mode of view angle prompt ④. The single view display zone ⑥ will switch to display the front/rear/left/right single view.

i Hint

- The display interface instruction is only for reference. In case of any difference, the actual vehicle shall prevail.
- When the gearshift is at "R" position, the system is in the rear-view interface by default. When the gearshift is at "non-R" position, the system is in the front-view interface by default.

Camera Distribution

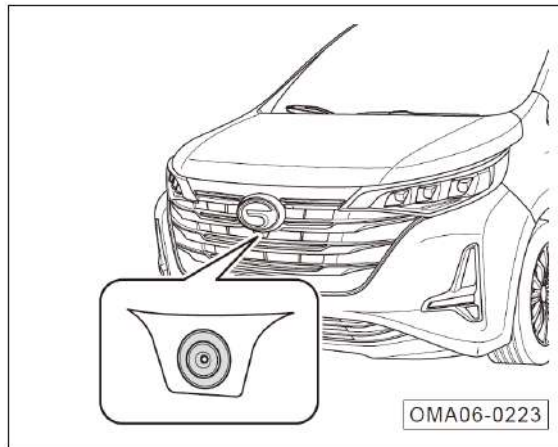

The front camera is installed below the car logo on front grille.

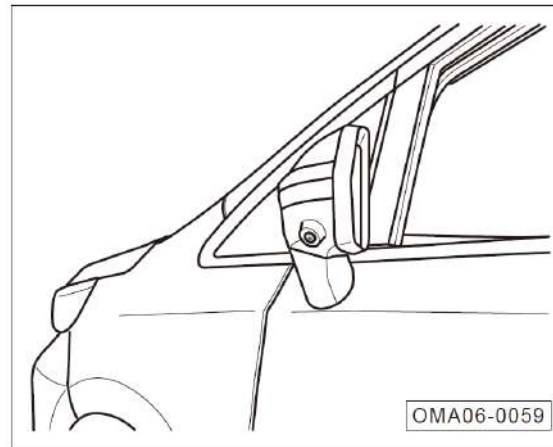

The left/right cameras are installed at the left/right exterior rear-view mirrors.

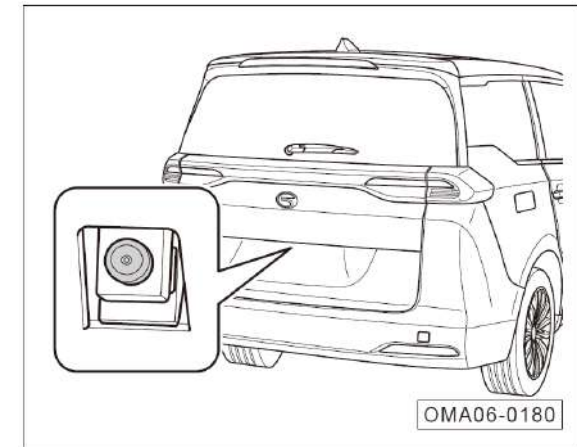

The rear-view camera is installed beside the number plate light.

Caution

- Keep the camera surface clean.
- Do not use high pressure cleaning device to clean the camera for a long time, and keep a distance of at least 30 cm from the camera when cleaning.

5. Driving Directions

5.6 Electric Power Steering (EPS) System

The EPS is a power steering system directly relying on the motor to provide assist torque. It mainly consists of torque sensor, motor, decelerating mechanism and electric steering control unit (ECU).

By detecting the driver's torque input and signals of whole car conditions, for example, speed and engine speed, the ECU controls the torque output of the assist motor in real-time manner, so as to realize the best steering assist, ensure flexibility at low speed and stability at high speed, and improve driving comfort and car safety.

Electronic power steering (EPS) system indicator light

When the ignition switch is at the "ON" position, the indicator light  will go on. After the engine is started for several seconds, the EPS control unit will finish the self-inspection and the indicator light will go off, indicating that the EPS system works normally.

If the indicator light  goes on after start of the engine or during driving, the EPS system is faulty, and the instrument cluster display shows the warning message. In such a case, park the vehicle at a safe place. Try to shut down the engine first and then start it again. If the indicator light keeps on or it goes on again during driving, do not continue driving, but contact any authorized GAC MOTOR special store for maintenance.

Steering Mode

There are "Standard", "Sport" and "Comfort" steering modes. You may have to steer harder with "Sport" mode. "Standard" is the default mode of the system. Set the steering mode in the audio system through "Vehicle Setting → Driving Assist → Steering Mode".

Caution

During driving, it is not allowed to set the steering mode to prevent from an accident.

5.7 Driving Skills

5.7.1 Safety Check for Driving

Daily Check

- Check the tires for normal tire pressure, no incision, bulge, damage or excessive wear.
- Check the wheel bolts for looseness or missing.
- Check that the front and rear combination lights and all other lights work normally. Check the irradiation direction of the front combination light.
- Check the seat belt for wear and damage. Fasten the seat belt and check whether it is secure.
- Check that the pedal has enough free travel.
- Check whether the coolant level, engine oil level, brake fluid level and windshield washing liquid level are normal.
- Check the battery terminals for corrosion or looseness and check the shell for crack or expansive deformation.
- Check whether there is leakage of fuel, engine oil, water or other liquid from the vehicle bottom. Water drops from the use of A/C is normal.

After Start/During Driving

- Check whether the instrument cluster works normally and whether there is any indicator light or warning information.
- Check whether the controllers work normal, such as light combination switch, wiper combination switch, defrosting switch, etc.
- For checking and confirming the brake on safe road, the car shall not deviate to any side.
- For other abnormalities: check for no loose components or leakage; listen whether there is any abnormal noise.

5. Driving Directions

5.7.2 Driving during Running-in Period

To ensure your car's service life, you have to run it in at the initial stage before putting it into normal use. When your car is in running-in period, please observe the following requirements:

- The mileage of running-in period is 1,500 km.
- Drive on good roads under reduced load at limited speed.
- Avoid full-accelerator starting or rapid acceleration.
- Avoid emergency braking for the first 300km.
- Strictly follow the operating instructions and keep the normal operating temperature of the engine. Do not change the engine oil before the regular maintenance.
- Carefully do routine maintenance; frequently check and fasten the external bolts and nuts; pay attention to the changes of sounds and temperature of each assembly during running, and adjust timely.

Running-in of the Engine

You have to run a new engine in for 1500km. Within 1000km of traveling mileage of the car:

- The speed shall not exceed 3/4 of the maximum speed.
- Avoid full-accelerator driving.
- Avoid high engine speed.
- Do not tow a trailer.

When the traveling mileage is within 1000km-1500 km, the engine speed and speed can be gradually increased to the maximum allowable range.

At the early stage of running-in period, the internal frictional resistance of the engine is much greater than that after the running-in. All the moving components of the engine coordinate well only after running-in.

Full running-in of the engine can increase the service life and reduce fuel consumption.

Running-in of Tires and Braking Pads

Drive the new vehicle at a moderate speed for the first 500 km of the mileage to properly run the new tires in.

Drive the new car at a moderate or low speed and avoid emergency braking as much as possible within the first 200-300 km of the mileage as the new braking pad cannot realize the optimal friction status.

Warning

- The best adhesion and friction cannot be realized for new tires and braking pad without running-in. Therefore, drive carefully for the first 500km to run in the tires well and avoid accidents.
- After replacement, the new braking pad shall also go through running-in period in accordance with the above requirements.
- Keep an appropriate distance with other vehicles during driving to prevent emergency braking, because at that time, both the new tires and braking pad are not fully run-in, and emergency braking may cause traffic accident.
- If the brake is damped or frozen, or the car is running on salt spreading road, the braking effect weakens.

Warning

- Heavy work load of the brake during running downhill makes it prone to overheat. It is recommended to slow down by shifting to a lower gear and fully use engine braking to reduce its work load.
- Always brake the car according to the road and traffic conditions. Avoid unnecessary press of brake pedal. Doing so can make the brake overheating, resulting in a longer braking distance and excessive wear.
- Do not let your car coast with the engine off, because as the brake booster is disabled, the braking distance will be much longer, making the situation accident-prone.

5. Driving Directions

5.7.3 Important Tips for Driving

Precautions for Various Road Conditions

- Decelerate the vehicle in advance and control the speed and steering wheel well when driving on a road full of crosswind and gust.
- Avoid passing through sharp objects or other road barriers, otherwise it may cause tire burst or serious damage.
- Drive the vehicle at a low speed on a bumpy or uneven road to avoid scratching the chassis and damaging the vehicle.
- Decelerate and shift down (manual mode or MT model) the vehicle in advance when driving down a slope and avoid the brake system overheating or wearing too fast due to any emergency braking.
- Be careful to accelerate, shift up/down (manual mode or MT model) and brake the vehicle when driving on a slippery road. Sharp acceleration or emergency braking may result in wheel slip.
- Drive the vehicle at a low and even speed and avoid sharp acceleration or emergency braking on an ice snow covered pavement. Install nonskid chain as necessary.

Precautions for Driving through Ponding Road

1. Before driving through a waterlogged road section, find out the ponding depth which shall not exceed the lower edge of car body.
2. In case of driving through water, turn off the air conditioner before starting; drive slowly; slightly step on the accelerator pedal and do not release; drive through the waterlogged section at a stable and low speed.
3. Do not park your car in water, nor reverse or turn off the engine.
4. After passing the waterlogged section, slightly step on the brake pedal for several times to evaporate water on the braking disc, so as to recover braking performance as soon as possible.

Hint

After the vehicle is washed or driven through a road with deep ponding and the braking pads and brake disc are soaked, the braking effects will be significantly weakened, the braking distance will be much longer than normal and the vehicle may be deflected to one side. At this time, drive at a low speed and slightly press down the brake pedal for several times to eliminate water drops on the brakes, and then drive normally as the braking effects resume.

Important Tips for Driving in Winter

1. Check whether the coolant is in proper conditions for antifreezing.
 - Fill the cooling system with the coolant of the same model as the originally used according to the environment temperature.
 - The engine can be damaged by unsuitable coolant solution.
2. Check the conditions of battery and cable:
 - Battery energy may decrease in cold weather, so that sufficient energy shall be reserved for starting in winter.
3. Prevent the door lock from being frozen by ice and snow.
 - Spray deicing agent or glycerin into keyhole to avoid freezing.
4. Use detergent containing anti-freezing agent.
 - These products are available in the authorized GAC MOTOR special store.
 - The mixing ratio between water and anti-freezing agent shall be based on the manufacturer's instructions.
5. There shall be no ice or snow accumulated under the mudflap.
 - Accumulated ice or snow under the mudflap causes hard steering. In winter, stop the car frequently to check if there is accumulated ice or snow under the mudflap.
6. Based on different road conditions, it is recommended that necessary emergency tools or articles should be carried.
 - Tire chain, window scraper, a bag of sand or salt, signal flasher, scoop, connecting cable and other necessary articles are better to be placed on the car.
7. In cold winter (especially in the north area), frequent starting of the engine or flameout of the engine after a short time of running shall be avoided. If the engine is often in an alternate cooling and heating state, condensation water may be produced inside the engine. The condensation water attached to the oil may cause the illusion of oil emulsification. After the engine starts, this illusion will disappear. Please replace the oil regularly according to the requirements in the *Warranty Manual*.

5. Driving Directions

5.7.4 High-efficiency Use of Vehicle

- Before driving, make sure the parking brake is released fully and its indicator light is off.
- Keep sufficient tire pressure. Insufficient tire pressure will result in tire wear and fuel waste.
- Make sure wheels are accurately positioned. Inaccurate positioning makes the tires wear out faster, increases engine load and wastes fuel.
- Do not overload the vehicle. Unload unnecessary articles from the vehicle. Overload will increase the load of the engine and waste fuel.
- Accelerate the vehicle slowly and evenly, but not sharply. For MT models, shift the gear based on the speed as soon as possible.
- Avoid traffic jams, which will waste fuel, as far as possible.
- Drive according to traffic signal lights or keep a safe distance from other vehicles, and avoid unnecessary park or emergency braking to save fuel and reduce wear of the brake system.
- Do not put the food on the brake pedal during driving to prevent untimely wear and overheating the brake pad and waste of fuel.
- Select good pavement when driving. When driving on an uneven road, control the speed well to avoid collision or scratch.
- Remove mud or other foreign matters stuck on chassis to reduce vehicle weight and prevent corrosion.
- Maintain the vehicle regularly to keep it under best operating conditions. Dirty air filters, unclean spark plugs, polluted engine oil and grease will weaken engine performance and waste fuel.
- Drive slowly for several minutes after starting at low temperature, and then accelerate after the engine warms.
- Do not open windows when driving at high speed.
- Use the AC and other devices properly.
- Shut off the engine for long-time parking and prevent it from long-time running at idle speed and waste fuel.

5.7.5 Fire Prevention

In order to prevent car fire, the following notices shall be kept in mind:

1. Flammables and explosives shall not be stored in your car:
 - In hot summer, the internal temperature of car parking in the sun can reach higher than 70 °C. If there is lighter, detergent, perfume, and other flammables and explosives in your car, it is very easy to cause fire or even explosion.
 - When there is no person in the car, the lithium battery, power bank and other articles that have fire risk in the car may also cause fire.
2. After smoking, confirm the cigarette end goes out completely:
 - Cigarette not put out completely may cause fire.
3. Please go to your authorized GAC MOTOR special store for check regularly.
 - Regularly check the circuits of the whole car to make sure connectors, insulation and fixing positions of all electric appliances and harness are in good condition. Once problems are found, troubleshoot timely.
4. Refitting the car circuits or adding electrical components is prohibited:
 - Adding other electric appliances (e.g. high-power audio device and xenon headlights) will overload the circuit, and the harness will be prone to heat and cause fire.
 - It is strictly prohibited to use fuse out of the rated specifications of electric appliance, or use other metal wire to substitute fuse.
5. Precautions for driving:
 - During driving and parking, especially in summer, be sure to check whether flammables exist under your car, such as hay, deadwood, leaves, or wheat straw, because the temperature of engine exhaust pipe or other components increase after long-time running, and flammables under the car may cause fire.
 - Do not park your vehicle at scrap heaps or other rat-infested places or store anything that appeals to rats, like snacks. The rats may bite through the harness, leading to fire.
6. Portable fire extinguisher shall always be kept on your car, and you should know how to use it:
 - In order to guarantee safety, fire extinguisher shall be kept on your car and also be checked and replaced periodically. You should know how to use a fire extinguisher, so as to be prepared for accident.
7. During maintenance, disconnect the negative wire of battery.

6. Usage and Maintenance

6.1. Maintenance Instructions

Safety Precautions

To avoid potential hazards, please read this chapter and make sure you have tools and technology required before maintenance.

- Make sure your car is parked on level ground, the engine is off, and the parking brake is applied.
- Use degreasant or detergent to clean parts and do not use gasoline.
- To reduce the possibility of fire or explosion, keep cigarettes, sparks, and flames away from the battery and all fuel-related parts.
- Wear goggles and protective clothing when working with the battery or compressed air.

Warning

Driving after incorrect maintenance or before solving safety related failures may cause traffic accidents and lead to severe injury or death.

Potential Hazards

- Carbon monoxide: Carbon monoxide from engine exhaust is poisonous. Be sure there is adequate ventilation whenever you operate the engine.
- Scald: the engine and exhaust system will produce high temperature when working, which is very easy to cause scald. Therefore, do not touch any components until the engine system has been closed for at least 30 minutes and the engine and exhaust system has cooled down.

Hint

Some of the most important safety precautions are given in this chapter. However, we cannot warn you of every conceivable hazard that can be reduced in maintenance.

6.2 Interior Maintenance

Cleaning and Maintaining the Instrument and Plastic Parts

Clean the surfaces of the instrument and plastic parts with a clean soft cloth and fresh water.

Otherwise, use the special solvent-free plastic cleaning agent to clean them.

Caution

Cleaning agent with solvent may damage the plastic parts.

Warning

Do not use any driver's compartment spray or cleaning agent with solvent to clean the surfaces of the instrument panel and airbag module. Doing so could loosen the surfaces and trigger the airbags, resulting in serious personal injury.

Cleaning and Maintaining the Carpet

Remove dust on the carpet with a vacuum cleaner regularly.

Clean the carpet with cleaner regularly to keep it clean.

Caution

Follow the instructions of the detergent to do the cleaning work.

Warning

It is strictly forbidden to add water into foam-type cleaner. Make sure that the carpet is dry.

Cleaning and Maintaining the Leather*

- Vacuum dirt and dust from the leather frequently.
- Clean the leather with a soft cloth dampened with clear water.
- Then, buff it with a clean, dry cloth.
- If further cleaning is needed, use special saddle soap or detergent to clean it.

Caution

After you wipe the leather using the special detergent, wipe it dry as soon as possible with a soft, dry cloth.

Warning

Do not place soft cloth soaked with detergent on any interior parts for a long time, to avoid discoloration or breakage to the resin or fiber of the interior braided fabrics.

6. Usage and Maintenance

Cleaning and Maintaining the Seat Belts

- Pull out each belt slowly and hold it there.
- Use a soft brush and neutral soap water to clean dirt.
- Let the seat belts dry completely before retracting them.

Caution

- Do not retract the seat belts until they are completely dry. Otherwise, the seat belt retractor may be damaged.
- Check all seat belts in the vehicle regularly and keep them clean to ensure their proper operation.

Warning

- Please contact the authorized GAC MOTOR special store for replacement in case of any damage to webbing, connection unit, retractor or buckle of the seat belt.
- Whether damaged or not, be sure to replace the seat belts after a collision.
- Prevent foreign matters or liquids from entering the seat belt buckles. Failure to do so can cause the buckles and the belts to function abnormally.
- Do not remove or transform the belts in any case by yourself.
- Do not use chemical cleaning agents to clean the seat belts to avoid damaging the seat belt base, thus affecting its function.

Cleaning and Replacing Filters

The vehicle is equipped with air filter, air conditioner filter, oil filter and fuel filter, which play a role in filtering gas or oil. If the filter is too dirty or blocked, the normal work of the corresponding system will be influenced, so it is recommended that the user should go to the authorized GAC MOTOR special store periodically to clean or replace the filter according to the provisions of the *Warranty Manual*.

6.3 Exterior Maintenance

Vehicle Washing

Frequent washing helps preserve your car's appearance.

Wash your car in a shady area, not in direct sunlight. If your vehicle is exposed to the sun for a long time, wait until the exterior cools down before washing.

Follow the instructions of the operator when using an automatic car washer.

Warning

Switch off the Ignition switch before washing the vehicle.

Caution

Although the body paint is strong enough to withstand the flushing from the automatic car washer, pay attention to its impact on the paint. The washer structure, used cleaner, filtration state of fresh water, and type of wax solvent which do not meet the specified requirements are likely to damage the paint.

Manual Washing

- Rinse the vehicle thoroughly with clean water to remove floating dust.
- Prepare a bucket of clear water and mix the water with special washing cleaner.
- Wash the vehicle gently with soft cloth, sponge or a bristle brush and rinse it from top to bottom frequently.
- Finally, rinse the wheels, doorsills and others. Remember to replace the sponge or soft cloth during washing.
- Then rinse the vehicle thoroughly with a plenty of water.
- Then, dry it with a chamois or soft towel.

6. Usage and Maintenance

Caution

If there is asphalt or other dirt on the car's body, special cleaner needs to be used. Then rinse the body with water to avoid damage to the finish. As drying the vehicle, check it for chips and scratches. If any, go to the authorized GAC MOTOR special store for repair.

Be careful when washing the vehicle with a steam washer or a high-pressure washer. Follow the instructions and requirements of the steam washer or the high-pressure washer when doing so and pay attention to operation pressure, temperature and washing distance.

- When washing the vehicle with a steam washer or a high-pressure washer, keep enough spraying distance with the vehicle and keep the temperature not greater than 60°C .
- Keep a spraying distance of more than 80 cm when washing the vehicle with an electric sunroof. Short distance between the high-pressure washer and the vehicle or excessive high temperature or pressure may damage your vehicle.
- Do not face the high-pressure washer to the radar sensor or the parking camera for a long time when washing the vehicle. When washing the radar sensor or the parking camera, keep a spraying distance of more than 30 cm.

Warning

- Pay attention to personal safety and avoid being scratched by angular parts under the bottom of the vehicle during manual washing.
- Pay special attention to the bottom of the vehicle and the inside part of the wheel cover during washing and prevent your hand and arm from being hurt by sharp parts.
- Do not directly spray water into the engine compartment when washing the vehicle. Otherwise, the service life of parts in the engine compartment may be affected.

Waxing

Regular waxing helps protect vehicle body's paint and keep the body bright and clean. In order to protect body paint surface, it is suggested to apply high quality hard wax every year to protect the paint surface from being corroded due to poor environment and withstand light mechanical scratch.

The waxing operation must be executed after the surface of the whole vehicle is wiped dry. High quality paint protective wax shall be used. In general, there are two types of products:

- Body wax: A wax coats the finish and protects it from the damage by exposure to sunlight, air pollution, and other poor external environment. It always applies to new cars.
- Polishing wax: Polishing wax can restore the luster of oxidized paint or the paint without gloss. It is mainly used to restore the luster to paint.

Cleaning and Maintaining the External Plastic Parts

In general, clean the external plastic parts with fresh water, soft cloth and bristle brush. If further cleaning is needed, use the special solvent-free plastic cleaning agent recommended by GAC MOTOR.

Caution

Do not use any cleaning agent with solvent to clean the plastic parts. Doing so can cause damage to the plastic parts.

Cleaning the Windows and Exterior Rear-View Mirror

Clean the window glass and rear-view mirrors with alcoholic glass cleaner, and then dry glass surface with a clean, lint-free, soft cloth or antelope skin.

After maintaining the car body surface, the wax remaining on the glass shall be removed by special cleanser and cleaning cloth to prevent scratching the windscreen wiper.

Remove the snow on the windows and rearview mirrors with a bristle brush.

Remove ice using the special deicing spray. You can also remove the ice using the scraper with extra care to avoid damage to the components. Be sure to scrape the ice in the same direction.

6. Usage and Maintenance

Caution

- Do not scrape the ice back and forth.
- Do not use warm or hot water to remove the ice and snow on the windows and rear-view mirrors. Doing so may crack the glass.
- If there is any residual rubber, grease or silicone on the glass, remove it with a special window cleaner or silicone cleaner.

Cleaning Front Wiper Blades

- Lift the wiper arm and carefully remove the dust and dirt from the wiper blade with a soft cloth.
- Carefully lower the wiper arm back to the windshield when the cleaning is finished.

Caution

- Carefully lower the wiper arm to prevent striking the windscreen due to instantaneous drop.
- A wiper blade surface is coated with a layer of graphite which can make the wiper blade move smoothly without scratching noise. Cleaner with solvent, hard sponge and sharp tools will damage the graphite layer. Damaged graphite layer may increase scratching noises. Be sure to replace it timely.
- In winter or cold weather, check whether the wiper blades are frozen with the windshield before operating them. If so, remove the ice from the wiper blades firstly. Failure to do so may cause damage to the wiper blades and the wiper motor.

Maintaining the Sealing Strips

Frequent and appropriate protection of the rubber sealing strips for the doors, windows and other parts can maintain their flexibility, prolong their service life. Such action can improve the leakproofness, making the doors easier to open and reducing the closing sound and it's difficult to get frozen in winter.

When maintaining the sealing strip, use soft cloth to remove the surface dust and dirt. Apply the special protective agent to the rubber sealing strips regularly.

Cleaning and Maintaining the Wheels

Regular cleaning of non-slip salt on the wheel and abrasive dust on the brake lining can keep the wheel artistic and surface smoothness, and increase the service life. It is suggested to perform the following operations regularly:

- Use acid-free cleanser to remove the antiskid salt and brake lining abrasive dust on the wheel every two weeks.
- Wax the alloy wheels with high-quality hard wax every three months.

Caution

- Do not clean the wheels surface with the vehicle polishing agent or other grinding agents.
- If the protective layer of the wheels is damaged, be sure to repair it in time.
- The high-pressure washer may cause permanent visible or invisible damage to the wheels, resulting serious injury or death.
- Never spray the tires with the cluster nozzles. Otherwise, it will damage the tire to trigger an accident.

6. Usage and Maintenance

6.4 Checking and Adding Fluids

6.4.1 Fuel Oil

The scale of the fuel gauge will decrease gradually with the decrease of fuel oil during the traveling process. =>Refer to Page 41

The low fuel indicator light  will flash in yellow and the instrument cluster will display warning information when the fuel level is too low. Add fuel as soon as possible.

Filling the Fuel

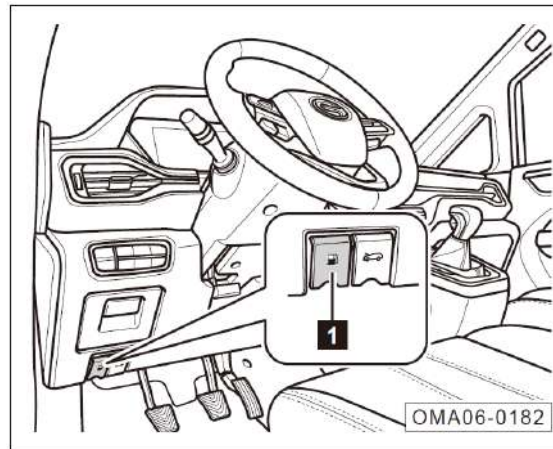

- Pull the handle ① of fuel tank cap and the fuel tank cap will bounce outward.

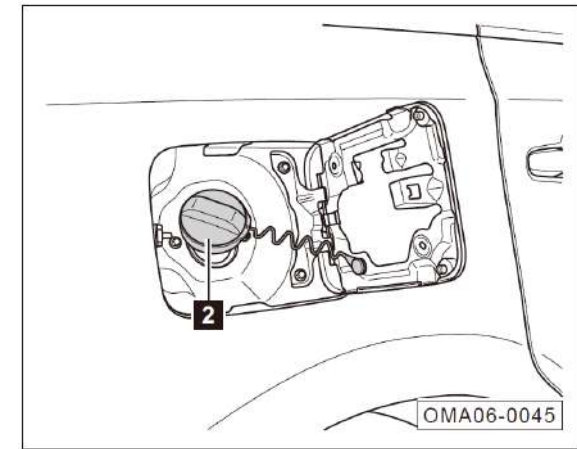

- Fully open the fuel tank cap, slowly screw out the filler cap ② anticlockwise, hold the filler cap at the original position for a moment when fully screwing out to allow the fuel tank to release the internal fuel vapor pressure, and then take out the filler cap.

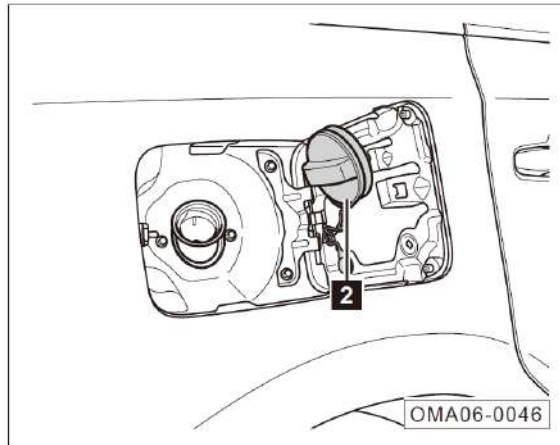

- Hang the filler cap ② inside the fuel tank cap, and start adding fuel oil.
- When finishing adding fuel oil, screw the filler cap ② clockwise until you hear three "clicks", which indicates the filler cap is fully tightened.

Hint

Please refer to the description on the fuel requirement label at the fuel filler door of each vehicle.

Caution

Using fuel grade with lower grade or not meeting the standard may damage the engine or may not satisfy the performance requirements.

Warning

- In any case, during refueling, make sure to shut down the engine, and pay attention to no open fire and kindling around.
- Please keep the fuel away from the skin or cloth.
- Please refuel the vehicle according to the fuel grade. If the fuel inconsistent with the provisions is filled accidentally, do not start the engine, and go to the authorized GAC MOTOR dealer immediately for treatment.

6. Usage and Maintenance

6.4.2 Engine Oil

Function of Engine Oil

Engine oil contributes to engine's lubrication, sealing, cooling, anti-corrosion, cleaning, etc.

Engine Oil Specification

High-quality engine oil, which can be used throughout the year, except for extreme cold weather, has been filled into the engine when the vehicle is delivered.

Check whether the specifications of the oil are applicable to your engine when purchasing.

Hint

- Engine oil grade: SN and above
- Engine oil viscosity: SAE 5W-30

Warning

Make sure to use the engine oil accepted by GAC MOTOR. If the engine oil with other specifications is used, the damage to the engine therefrom is not included in the warranty range.

Hint

- Replace engine oil in intervals specified in the *Warranty Manual* at the authorized GAC MOTOR special store.
- If the vehicle is used under severe conditions, fuel with higher sulfur content is used, the vehicle has to idle for a long time (e.g. Taxi), be driven in dusty area or alpine regions or it has to drag trailers frequently, increase the times of maintenance or shorten the maintenance interval.

Low engine oil pressure warning light

If the warning light  goes on during driving, park the vehicle at a safe place and shut down the engine. Check the engine oil level after the engine has cooled down.

If the engine oil is at normal level and the warning light is still on after the engine is started, do not start the engine any more but contact the authorized GAC MOTOR special store for repair in time.

Warning

- Ignoring the warning light and relevant warnings may damage the engine.
- The low engine oil pressure warning light cannot indicate the engine oil level. Ensure to check the oil level regularly.

Check Engine Oil Level

Ensure to check the engine oil level regularly. Park the vehicle on the level ground, apply the parking brake, shut down the engine and then open the engine hood when the engine has cooled down to check the engine oil level.

Warning

- Be sure to operate inside the engine compartment with extra care.
- The engine compartment is a high-risk area. Before opening the engine hood, please carefully read and comply with relevant warnings and instructions.

Hint

During inspection of engine oil level, the engine shall be in the cold state.

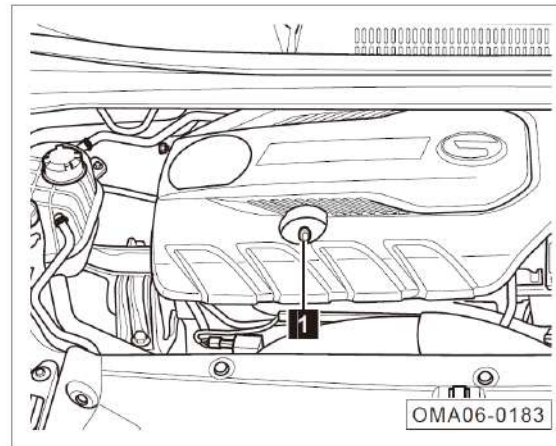

- Draw out the engine oil dipstick ①.

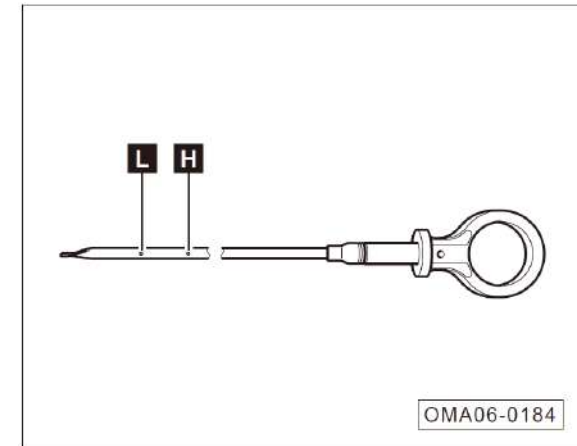

- Wipe off the oil stains on the dipstick with a clean cloth. Then insert the dipstick all the way back.
- Draw out the dipstick again. Read the measured oil level which should be between mark low limit mark (L) and mark high limit mark (H).
- Add engine oil if it is insufficient to prevent poor lubrication and damage to the engine.

6. Usage and Maintenance

Add Engine Oil

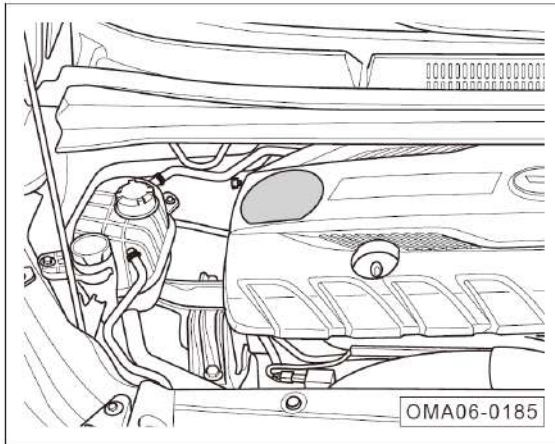

Add engine oil according to the following steps if found necessary after the engine oil level is checked:

- Press and open the engine oil filler cap.

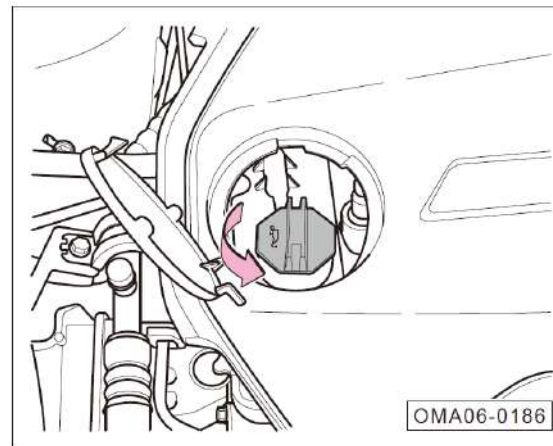

- Screw out the engine oil filler cap anticlockwise.
- Fill engine oil into the filler repeatedly by small amount, and check the engine oil level after each filling.
- When the oil level is close to the upper limit mark “H”, i.e. the engine oil is sufficient, stop adding oil, assemble the filler cap and tighten clockwise.

Warning

- Be careful when adding engine oil to prevent spilling. If the engine oil splashes on the skin, rinse it thoroughly.
- If too much engine oil is added, do not start the engine, but contact the authorized GAC MOTOR special store for handling in time. Otherwise, the three-way catalytic converter may be damaged.
- After the engine oil is added, tighten the engine oil filler cap to prevent the engine oil from spilling and avoid fire when the engine is operating.
- The engine oil is poisonous. Therefore, store it in the original container and keep it beyond the reach of children to prevent eating by mistake and poisoning.
- Add no other lubricant into engine oil; otherwise, the engine will be damaged. Any fault caused by addition of lubricant isn't included in quality guarantee.

6.4.3 Coolant

Function of Coolant

The coolant possesses cooling, anti-freezing, and anti-corrosion functions.

Specification of Coolant

During delivery, the cooling system of this vehicle has been added with coolant. The coolant can be used throughout the year except for extreme cold weather, prevent the alloy components of cooling system from corrosion and the system from scaling.

Hint

Specification of coolant: DF-6, -35°C coolant.

Hint

- Replace coolant in intervals specified in the *Warranty Manual* at the authorized GAC MOTOR special store.
- Shorten the maintenance interval and change the coolant at the authorized GAC MOTOR special store if the coolant is discolored.

Too high engine coolant temperature indicator light

Check the indication of the engine coolant temperature gauge frequently and get the coolant temperature during driving.

When the coolant temperature is too high, the indicator light  on the instrument cluster will go on in red and a warning message will be shown to remind the driver. At this moment, stop the vehicle and shut the engine down. Then check the coolant level after the engine has cooled down.

If the coolant is at normal level and the indicator light is still on after the engine is started, do not start the engine any more but contact the authorized GAC MOTOR special store for repair in time.

6. Usage and Maintenance

Checking the Coolant Level

Ensure to check the coolant level regularly. Park the vehicle on the level ground, apply the parking brake, shut down the engine and then open the engine hood when the engine has cooled down to check the coolant level.

Warning

- Be sure to operate inside the engine compartment with extra care.
- The engine compartment is a high-risk area. Before opening the engine hood, please carefully read and comply with relevant warnings and instructions.
- If any steam or coolant runs out from the engine compartment, do not open the engine hood until the steam or coolant ceases to run out and the engine has cooled down to prevent scald.

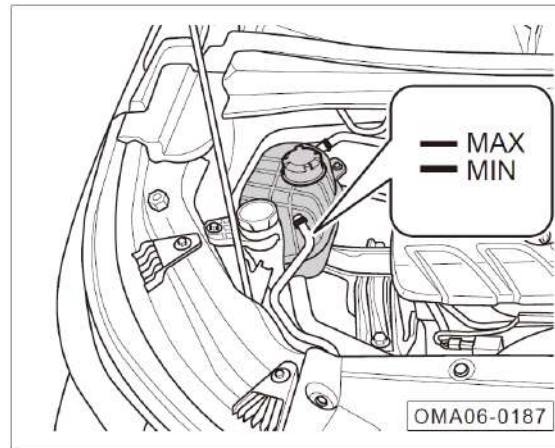

Check whether the coolant level in the coolant expansion tank is within the range of upper limit mark "MAX" and lower limit mark "MIN".

Hint

When the engine has not cooled down, the coolant level will be higher and cannot be measured accurately. Therefore, check it when the engine has cooled down.

Caution

When the coolant level is lower than the lower limit mark "MIN", add the coolant. Insufficient coolant will affect cooling effects, resulting in damage to the engine.

Adding Coolant



After inspecting the coolant level, add coolant if necessary in the following steps:

- Wrap the expansion tank cover with a thick cloth and unscrew it anticlockwise.
- Add coolant till its level reaches upper limit mark -MAX”.
- Screw the expansion tank cover clockwise.

Caution

- When the engine has not cooled down, the cooling system is under high pressure. Do not open the coolant expansion tank cover at this moment. Otherwise, you will be scalded by the steam.
- When unscrewing the expansion tank cover, use a thick cloth to wrap it to avoid scald.
- Do not add coolant until the engine has cooled down. The coolant level should not exceed the upper limit mark -MAC”. Otherwise, the coolant will spill out when the engine is started and the cooling system is under high pressure.
- Add new coolant only.
- Add coolant based on the ambient temperature to prevent it from freezing in inclement climate.

Warning

- Do not mix the original coolant with any other unrecognized coolant. Otherwise, the engine may be damaged seriously due to incompatibility.
- If any other coolant is mixed or pure water is added for an emergency, go to any authorized GAC MOTOR special store to clean the cooling system and replace the coolant in time.
- If the engine consumes too much coolant or consumes coolant too fast, the cooling system may have some hidden leakage. Go to any GAC MOTOR special store for maintenance in time.
- Store coolant in accordance with environmental protection laws and regulations.
- Store coolant in the original container and keep them out the reach of children to prevent eating by mistake and poisoning.

6. Usage and Maintenance

6.4.4 Windshield Washing Liquid and Wiper Blade

Adding Windshield Washer Fluid

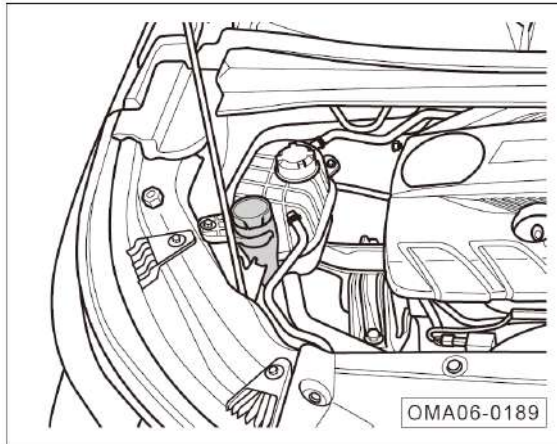

When founding the washing liquid level is too low, timely add washing liquid into the washing liquid tank.

Caution

Do not mix the windshield washing liquid with any other washing liquid. Otherwise, the component of the washing liquid will resolve, plugging the nozzle of the windshield washer.

Warning

- Be sure to operate inside the engine compartment with extra care. Before operation, carefully read and comply with relevant safety warnings and instructions.
- Do not misuse any coolant or any other additive as the windshield washing liquid. Otherwise, oil stains may be left on the windshield, affecting view and causing accidents.
- Do not use any windshield washing liquid containing more than 10% ethanol. In a high temperature environment, such kind of windshield washing liquid will corrode and crack tail lights. It is recommended to use methanol washing solution.

Replacing Front Windshield Wiper Blade

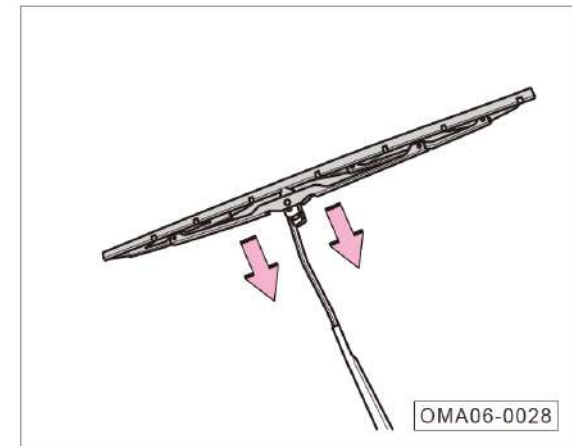

- Lift the wiper arm, rotate the wiper blade (as shown in the figure), and press the wiper to remove it.
- Place a new wiper blade back to the wiper arm in reverse steps, and install after hearing a “click”.
- Carefully lower the wiper arm back to the windshield.

Replacing Rear Windshield Wiper Blade

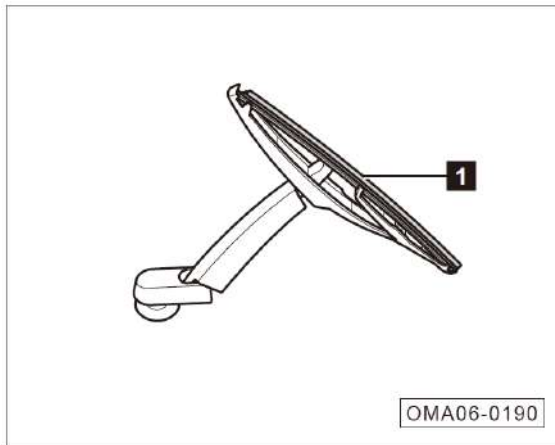

- Lift the wiper arm.
- Draw and remove the wiper blade ①.
- Install the new wiper blade back to the wiper arm.
- Carefully lower the wiper arm back to the windshield.

It is recommended to replace your wiper blade at authorized GAC MOTOR special store when necessary.

Caution

- When lifting the wiper arm, grasp the wiper arm with hand, and do not grasp the soft wiper blade.
- Be sure to use new wiper blade with the same length and specification.
- Carefully lower the wiper arm to prevent striking the windscreen due to instantaneous drop.
- Check the condition of the wiper blades regularly, and replace them as required. Replace any damaged wiper blade in time.
- Seriously worn or dirty wiper blade is very easy to scratch the windscreen, and will influence the forward visibility and reduce the driving safety during use.

6. Usage and Maintenance

6.4.5 Brake Fluid

Function of Brake Fluid

The brake fluid is used to transfer power in the hydraulic brake system.

The brake fluid used for the vehicle is specially developed by GAC MOTOR. To ensure normal operation of the brake system, only the brake fluid recommended by GAC MOTOR can be used.

The brake fluid is water-absorbing. It can absorb moisture from the air around constantly in the process of usage. If the brake fluid stays inside the system for a too long time and thus absorbs too much water, air lock will be produced inside the pipeline of braking system, reducing brake effect and driving safety, and even causing complete failure of the braking system and accidents. Therefore, check the brake fluid level or replace the brake fluid regularly in an interval specified in the *Warranty Manual* at any the authorized GAC MOTOR dealer.

Hint

Specification of brake fluid: DOT4.

Warning

- Using waste brake fluid or brake fluid not suitable for this vehicle will greatly decrease the braking effect, or even cause failure of the brake system! GAC MOTOR will assume no responsibility to any fault or damage raised therefrom, including warranties.
- Use the brake fluid that conforms to the standard and is unused.
- The brake fluid container is labeled with the specifications. Always use the brake fluid with correct specifications.

Brake system indicator light

If the indicator light  goes on in red and the instrument cluster displays the message "Please add brake fluid" when driving, park the vehicle at a safe place immediately and check whether the fluid level is normal.

Inspecting the Brake Fluid Level

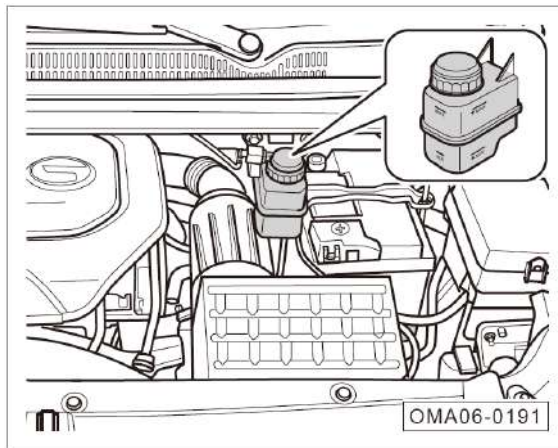

During engine cooling, check whether the brake fluid level is within the range of upper limit mark "MAX" and lower limit mark "MIN".

The fluid level will be slightly lower during driving due to wear of the brake lining and self-adjustment.

If the brake fluid level drops or falls to below MIN , the braking system may leak.

i Hint

- Read and follow the warnings and instructions before opening the engine hood.
- Check the brake fluid level. If it is below the lower limit mark MIN , add brake fluid.
- If the brake system warning light does not go off or it goes on during driving after the brake fluid is added, the brake system may leak, dropping the fluid level, or it is faulty. In such cases, do not continue driving, but contact an authorized GAC MOTOR special store for maintenance.

Fill the brake fluid.

Add the brake fluid of specified specification to ensure the brake system to operate properly:

- Unscrew the brake fluid storage tank cap anticlockwise.
- Add unused brake fluid till the level reached the upper limit mark MAX .
- Screw the brake fluid storage tank cap clockwise.

6. Usage and Maintenance

Caution





- The brake fluid is corrosive to the body paint. If you get brake fluid on the body paint, wipe it off timely.
- Using waste brake fluid or brake fluid not suitable for this vehicle will greatly decrease the braking effect due to incompatibility, or even cause failure of the brake system.

Warning

- Store the brake fluid in its original sealed container and put it in a safe place as it is poisonous. Keep the container away from children to avoid eating by mistake and poisoning.
- Store brake fluid in accordance with environmental protection laws.

6.4.6 Battery

Alert Symbols and Descriptions of Battery Operation

	Always wear goggles when operating!
	The electrolyte of storage battery belongs to a strong corrosive material, so that protective gloves and goggles must be worn when operating!
	Make sure the workplace is free of open flames, sparks, naked lights, and smoke.
	Highly explosive mixed gas will be generated when the battery is charged!
	Children must keep away from the electrolyte and vehicle battery!

Do not perform any operation on the electrical system but have an authorized GAC MOTOR special store to complete relevant operations if you are not familiar with the operational process or do not have proper equipment.

Warning

- Before operation, carefully read and comply with relevant safety warnings and instructions about the operation of the battery.
- Do not perform operation on the battery unless you have enough expertise.
- Do not remove the battery. Beware of chemical burns and battery explosion.
- Damaged or leaked battery isn't allowed to use. It should be recycled and disposed according to laws and regulations of environmental protection.
- Make sure the workplace is free of open flames, sparks, naked lights and smoke. When operating the cables and electrical equipment, be sure to prevent sparks and static electricity. Do not allow the battery terminals to be short-circuited. Otherwise, the high energy spark from short circuit may injure the operator.

Charging system warning light

This warning light indicates the generator fault.

Switch the Ignition switch at "ON" position, the  warning light is lit when the engine is not started and is off after the engine is started.

If the warning light comes on when the car is moving, it indicates that the generator cannot charge the battery any more. Go to authorized GAC MOTOR special store to check the car as soon as possible.

6. Usage and Maintenance

Check battery

Check the battery as required by the *Warranty Manual*.

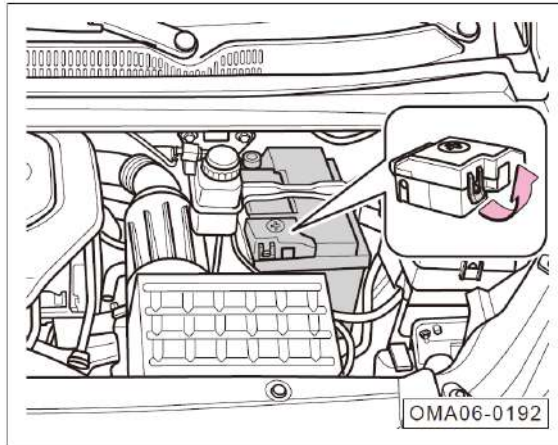

- Turn over the battery positive pole cover.
- Check the battery connection for corrosion or loosening and check the battery appearance for cracks and expansion. In any case mentioned above, go to your authorized GAC MOTOR special store for troubleshooting as soon as possible.
- Check the battery more frequently if the vehicle is parked for a long time.

i Hint

- If it is hard to start the vehicle due to low or damaged battery, contact the authorized GAC MOTOR special store to charge or replace the battery.
- Go to the authorized GAC MOTOR special store to replace the battery when necessary. Do not use any battery of a wrong model. Otherwise, you may be unable to use the vehicle or the electrical system may fail due to incompatibility.

Notes for Use of Battery

The battery will discharge rapidly when any electric device on the car is used after the engine is shut down.

1. Do not use any electrical equipment for an extended period after the engine is shut down.
2. When leaving the vehicle, be sure to close the doors tightly and turn off all the electrical equipment (e.g., lights, etc.)

⚠ Caution

- Try the emergency start if the engine cannot be started due to low battery. If the engine cannot be started by such a way, contact the authorized GAC MOTOR special store for maintenance.
- To avoid damaging your vehicle's electrical system, do not connect the solar panels or battery charger and other power generation equipment to the power outlet.
- As the battery contains toxic materials such as sulfuric acid and lead, dispose it carefully and don't take it just as a common household waste.

6.5 A/C Filter

Check and Clean Air Filter

Periodically inspect or clean the A/C filter according to the provisions of the *Warranty Manual*. When the vehicle is driven in dusty environment, the A/C filter may become very dirty and earlier replacement is recommended.

i Hint

Please go to authorized GAC MOTOR special store for help of professional personnel if you are not able to remove and install the A/C filter.

Removing and Installing A/C Filter

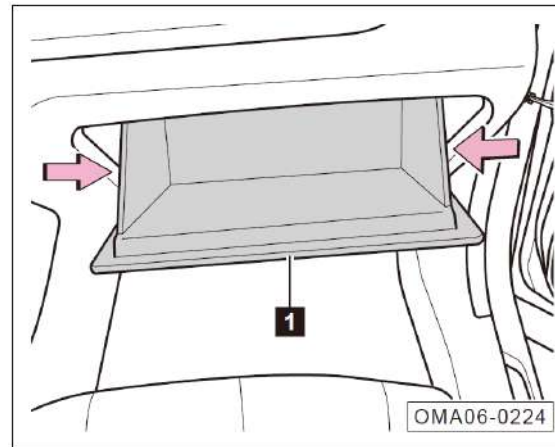

1. Open the glove box.
2. Press the glove box in the directions of arrows, and disconnect the glove box ① from the instrument panel assembly.

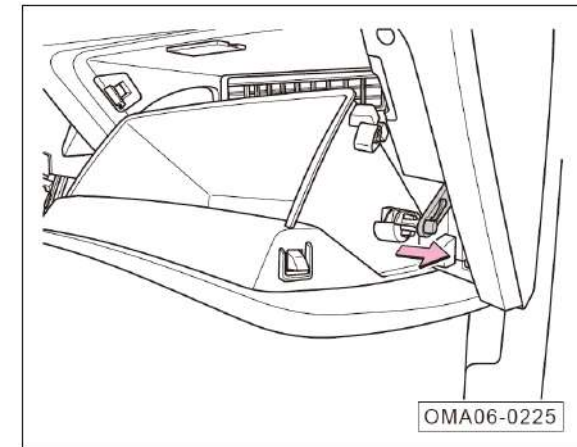

3. Disconnect the glove box from the damper in the direction of arrow.
4. Remove the glove box.

6. Usage and Maintenance

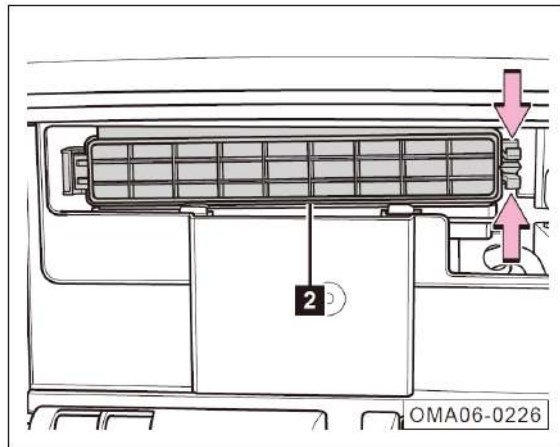

5. Press the clip of the filter element cover in the directions of arrows, and take out the filter element cover ②.

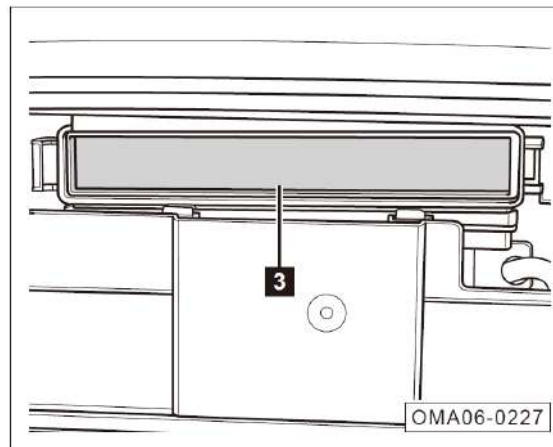

6. Take out the A/C filter element ③. Pat the AC filter element to remove dust.
7. Install the A/C filter in the reverse order.

Caution

- The A/C filter has a fibrous layer on the back and cannot be cleaned up with an air gun. Replace the AC filter in time if it is dirty.
- The A/C filter cannot be washed with water as it is made of special materials. Otherwise, dust will cake on the A/C filter, reducing air volume or even clogging the system.

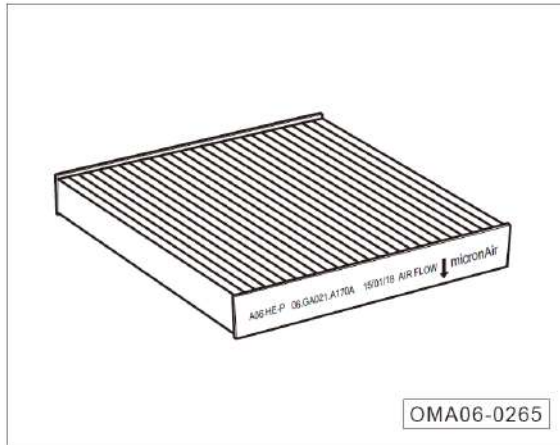

i Hint

During installation, install the A/C filter element with the side mark ↓ facing down.

6. Usage and Maintenance

6.6 Replacing Bulbs

Notes for Bulb Replacement

Do not touch the bulb with any finger during replacement. Otherwise, the bulb heat will evaporate your fingerprint and make it condense on the bulb glass, reducing the illuminating brightness.

Check the work conditions of the light after the bulb is replaced and go to the authorized GAC MOTOR special store to check the beam in time.

Hint

- Halogen or LED bulbs are used in the vehicle. If any LED bulb is damaged, go to the authorized GAC MOTOR special store to replace it.
- Basically the same methods will be used for removing or installing the bulbs on the left and right sides, so that only the removing or installing for one side halogen bulb will be described herein.

Caution

Replace the burned-out bulb with a new one of the same specification only. => Refer to Page 230 for bulb specifications.

Warning

Unless you have the expertise about the operational process, safe operation specifications and the tools, have your authorized GAC MOTOR special store replace the bulb.

- Turn off all lights first. Replace the bulb after it has cooled down.
- During operation, pay attention to sharp components on the combination light housing in the engine compartment. Be careful to protect your hands from being scratched.

Preparations Before Replacing Bulbs

If you find that any bulb is damaged, replace it in time. Make the following preparations before operation:

1. Turn off all lights.
2. Set the ignition switch at the —OFF” position.
3. Check whether the corresponding fuse is blown. If it is in good conditions, check and replace the bulb.

Replacing Low Beam Light Bulb

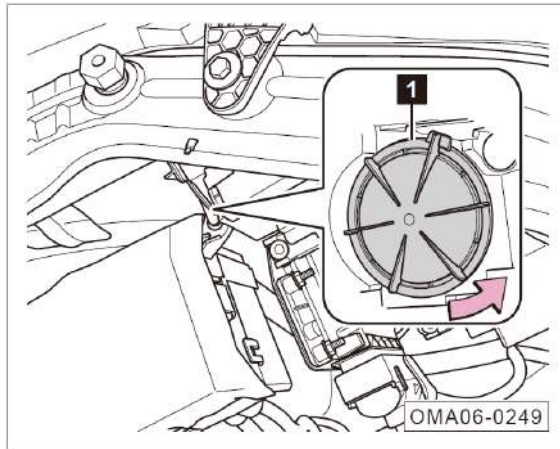

1. Unscrew the low beam seal cap ① anticlockwise.

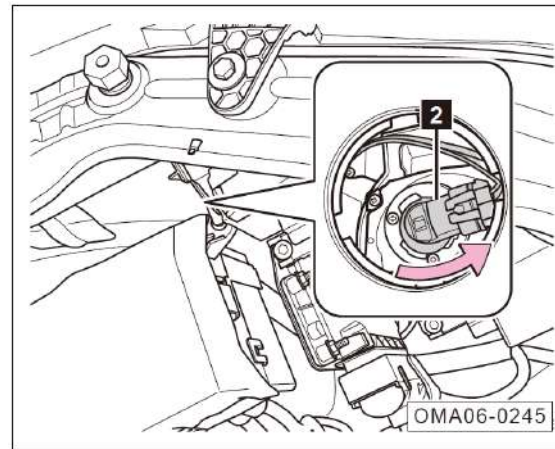

2. Unscrew the low beam bulb ② anticlockwise.

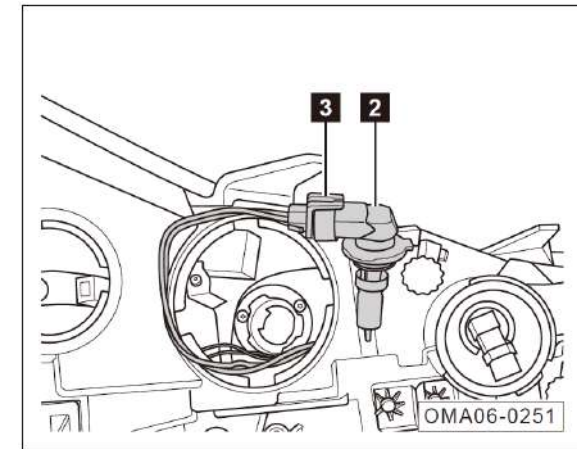

3. Pry out the connector clip ③ with a straight screwdriver and draw the low beam bulb ② out.
4. Operate in a reverse order after the low beam bulb is replaced.

6. Usage and Maintenance

Replacing High Beam Light Bulb

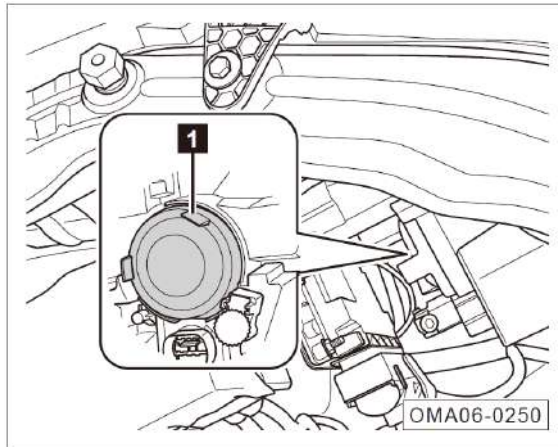

1. Take out the high beam seal cap ①.

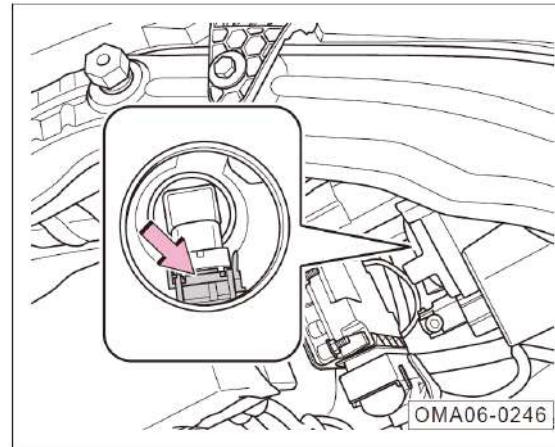

2. Disconnect the high beam bulb connector (see the arrow).

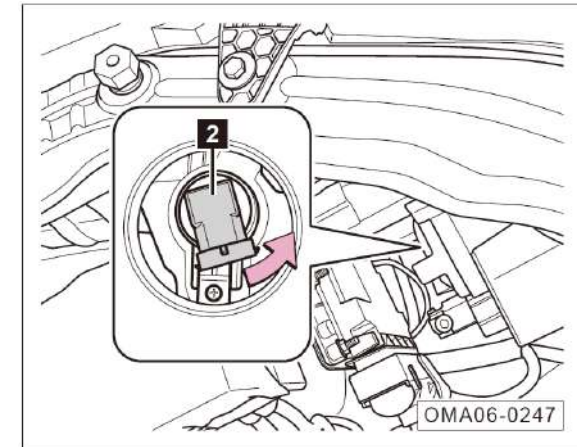

3. Unscrew the high beam bulb ② anticlockwise.
4. Operate in a reverse order after the high beam bulb is replaced.

Replacing Front Turn Signal Light Bulb

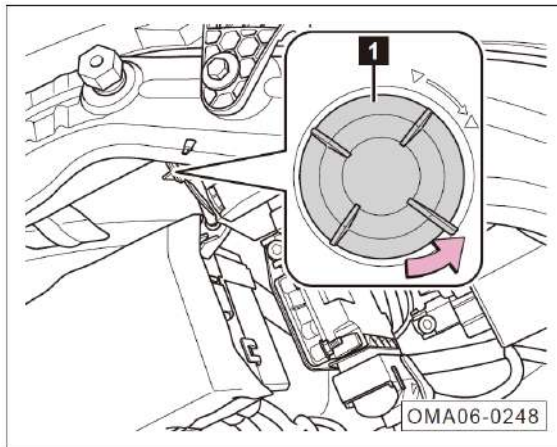

1. Unscrew the front turn signal seal cap ① anticlockwise.

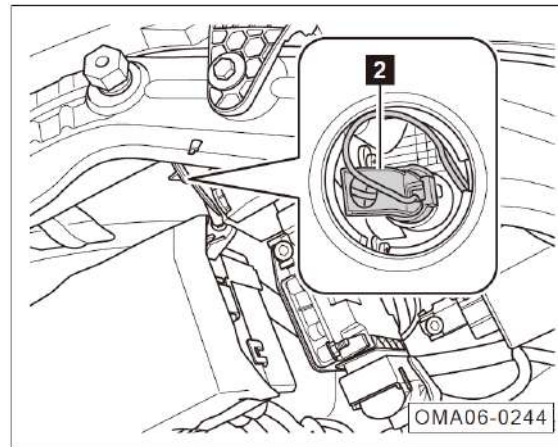

2. Set aside the front turn signal holder ②.

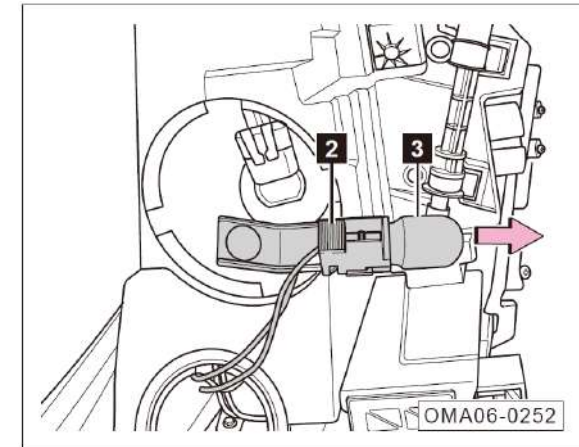

3. Set aside the bulb ③ from the front turn signal holder ②.
4. Install the front turn signal bulb in a reverse order after replacement.

6. Usage and Maintenance

6.7 Wheels

Warning

You cannot get the best adhesion from a new tire during the first 500km, so drive your vehicle at a moderate speed with care to avoid accidents.

- The tire which has not been run in or has been overworn provides insufficient adhesion, directly affecting the braking effect.
- If the vehicle vibrates abnormally or departures, stop the vehicle at a safe place immediately and check the tires for damage.
- If uneven excessive wear of the tires is found, go to authorized GAC MOTOR special store for inspection as soon as possible.

Warning

Tire burst or air leakage during traveling can cause serious traffic accidents.

- Do not drive with damaged tires or wheels or tires worn to the wear mark of tread pattern. Otherwise, it may cause accidents. Because the damaged tires may explode during traveling and cause traffic accidents and injure persons. Replace such tires and wheels timely.
- Tire pressure must comply with specifications. Otherwise it may cause accidents. If the tire pressure is insufficient, constant high-speed driving will cause tire deflection, resulting in tire overheating which may lead to tire shelling or burst.
- Always prevent the tires from touching chemicals, oil, grease, fuel and brake fluid.

Warning

- Try to avoid using a tire more than six years old. If no other choice, be sure to drive at a low speed with extra care.
- Do not use any old wheels and tires with dubious background under any circumstances. Such wheels and tires which may be already damaged invisibly will cause the vehicle out of control while driving, resulting in accidents.
- It is not recommended to use reclaimed tires, of which the carcass may change with time and the service life may be limited, affecting driving safety.

Prevention Measures for Wheel Fault

- To cross over curbs or similar obstacles, slow down your vehicle and drive in the vertical direction of the obstacle as far as possible.
- Prevent the tires from touching grease, oil and fuel.
- Periodically inspect the tire damage state (e.g. tire cut, wear, crack, peeling off, deformation, bump and other damages).
- Periodically remove sundries embedded in the tire tread pattern groove.

Notice of Tire Storage

- Make a mark on the tire to indicate the direction of rotation before removing the tire. Re-install the tire according to the mark to keep the direction of rotation and the dynamic balance state of the wheel unchanged.
- Store any removed wheel or tire at a cool, dry and preferably dark place.
- The tire installed on the rim should not be stored upright.

New Tires and Wheels

- Select appropriate wheels and tires with care. Ensure that the new wheels and tires are much the same as the original one in dimensions, load range, rated speed and structure.
- Do not to replace one tire only. At least the two tires on the same axle shall be replaced simultaneously.
- Do not use any tire that its effective size is not recognized for relevant models by GAC MOTOR. Otherwise, accidents may occur due to envelope interference or collision of the vehicle body.
- Do not confuse tires of different dimensions or types, such as summer tire, all-season tire and winter tire.
- It is recommended to use the tires or wheel combination recognized for relevant models by GAC MOTOR. For those unrecognized, GAC MOTOR cannot make any judgment and cannot ensure safe driving.
- Each time after a wheel is installed, check whether the tightening torque of wheel bolts reaches $(125\pm 10\text{N}\cdot\text{m})$ as required.

Non-full Size Tire

The spare tire is different from the standard tire in such aspects as structure, pattern, speed grade, and load index. Therefore, the spare tire cannot replace the standard tire.

After a spare tire is used in emergency, go to the authorized GAC MOTOR special store or a wheel repair store to replace the main tire to avoid potential safety hazards due to long time use of the spare tire.

Warning

- The spare tire can only be used temporarily in emergency and its maximum speed is less than 80 km/h.
- The storage life of a spare tire is 6 years. Do not use any spare tire beyond the storage lift.

6. Usage and Maintenance

Summer Tire

As it rains a lot in summer, the depth of tread directly relates to the safety of driving in rainy days. A very high risk of hydroplaning exists when the tread depth is less than 3 mm in summer.

Winter Tire

The winter tire has good holding performance on the icy and snow-covered pavement. Benefiting from special tread rubber design, the winter tire is not likely to be affected much by the low temperature environment and it has excellent brake performance to ensure driving safety.

- Winter tires shall be used on all four wheels.
- It is recommended to use winter tires in snowy days in winter or when the temperature is below 7°C.
- Only use the recognized radial winter tires for the vehicle with the same dimension, load range and rated speed as the original ones.

- It should be noted that sufficient tread depth shall be reserved on the tread of winter tire (The tread depth shall not be less than 4mm, otherwise the winter applicability will be restricted).
- After installing the tire, inspect the inflation pressure of the tire.

Warning

- The winter and summer tires are designed according to the traveling conditions on their respective typical lanes under corresponding season conditions. Winter tire is recommended in winter. At low temperature, the adaptability of summer tire is obviously poor, and it may lose adhesive force and braking capacity.
- Under severe cold conditions, if a summer tire is used, crack may appear on the tire, which will damage the tire completely, and cause excessive tire noise and out of balance.

Warning

- Winter tires may reduce the traveling traction on dry roads, increase noise and reduce the service life of the tread. When using the winter tires, pay attention to changes in operation and control.
- The maximum speed applicable to winter tire is relatively low. Do not drive at a speed beyond the allowable speed of the winter tires.
- Replace the winter tires with the summer tires after the temperature rises back to above 7°C to ensure driving safety and performance.
- When winter tires and a spare tire are used at the same time, the vehicle is less stable during turning and traveling. Adjust driving mode and drive carefully.

Hidden Damage

The damage of tires and rims is often invisible. If abnormal vibration or deflection occurs when the vehicle is traveling, the tire may be damaged. If you are suspicious of tire damage, be sure to decrease the speed immediately. Stop the vehicle and inspect the tire damage condition. If the damage is unable to be perceived from outside, please slow down and continue driving, and go to authorized GAC MOTOR special store as soon as possible for inspection.

Tire Marked with Rolling Direction

Some tires are marked with arrows on their sides to indicate rolling direction. This rolling direction must be followed when the tire is used. If the tire is installed with reverse rolling direction, it may shake, produce noise or be worn faster during driving, or have an obvious weakened road holding performance in rainy days.

Checking Tire Pressure

Tire Pressure kPa (kgf/cm ²)		
215/55R17 94V 215/60R16 99V	Front Tire	Rear Tire
Half load	240 (2.4)	240 (2.4)
Full load	240 (2.4)	260 (2.6)

OMA06-0193

The standard pressure data of the original tires are also given on the tire information label on the B-pillar on the driver's side.

- Look up the data label to find out tire pressure suitable for this car (pressure listed is suitable for tires in summer and winter).
- Unscrew the protective cap of the valve stem (If the protective cap is lost, be sure to re-install a new one timely).
- Check the tire pressure with a quality tire gauge. It is impossible to determine whether the tire pressure is appropriate by visual inspection.
- Install the tire pressure gauge to the valve stem.

- Check the tire pressure when the tires are cold. When the temperature rises, the pressure is a little bit higher than the specification. But there is no need to reduce the tire pressure.
- Keep the weight of passengers and baggage in balance. Avoid slope and adjust the tire pressure according to the load of the vehicle.
- Check the pressure of the spare tire or the emergency tire at the same time.
- Re-install and tighten the protective cap of the valve stem.

Hint

- For some models, the cluster screen can display current tire pressure.
- Install the protective cap of the valve nozzle back to the valve core. The protective cap can prevent entering of dust and moisture.

6. Usage and Maintenance

Warning

- Abnormal tire pressure may cause tire burst, resulting in accidents, personal injury or even death.
- Check the tire pressure once a month at least and before long-distance driving. Make sure the tire pressure meets the specification to avoid accidents.
- Insufficient tire pressure will exacerbate tire deflection, resulting in tire overheating which may lead to tire shelling and burst.
- Both underinflated and overinflated tires may cause early wear, and adversely reduce the vehicle's handling stability.

Tire Service Life

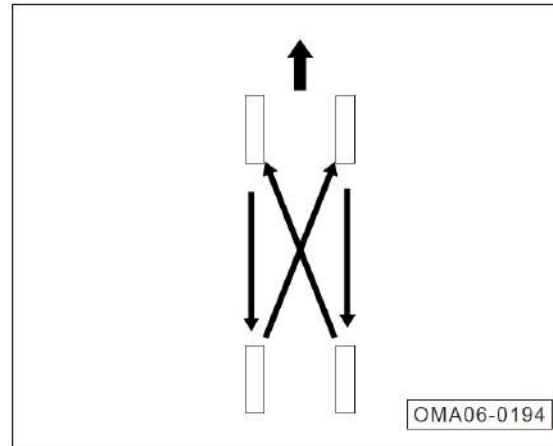

The service life of tire depends on tire pressure, driving style and tire assembly condition.

If the front tires are worn more seriously than the rear tires do, it is recommended to exchange the tires as shown in the figure, thereby making all the tires have the similar service life.

Warning

If the vehicle is equipped with tire pressure monitoring system, the tire exchange or replacement shall be operated in GAC Motor dealer.

Tread Wear Marks

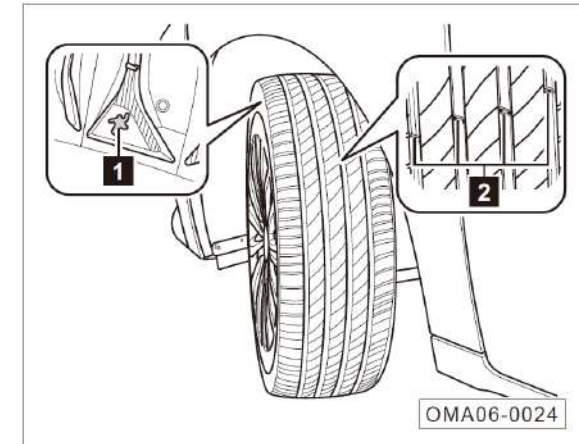

Pattern ① is used to indicate the wear of tread pattern on the outer circle. If the tread pattern on the outer circle is worn to the position of this pattern, the tire cannot be used safely, and must be replaced immediately.

The tread wear indication mark ② is 1.6 mm high. If the worn tread pattern is of the same height with such mark, the tire cannot be used safely, and must be replaced immediately.

Wheel Balance

The wheels of a new vehicle have been balanced, however, during the running process, the wheels may be out of balance due to various influences, which can be perceived from the shaking of steering mechanism.

The imbalance of wheel will cause excessive wear of steering system, wheel suspension mechanism and tire, so that the wheel shall be rebalanced.

In addition, if a new tire is installed or the tire is repaired, the wheel must also be rebalanced.

Incorrect Wheel Alignment

The misalignment of wheels will cause uneven excessive wear of tires, and affect the traveling safety; if uneven excessive wear of tires is found, go to authorized GAC MOTOR special store to inspect the wheel alignment as soon as possible.

6. Usage and Maintenance

6.8 Tire Chain

When driving on snow or ice road or in other severe environments in winter, the tire wear degree may increase or other failure may occur. The following suggestions must be observed in order to reduce the failure in winter:

- When driving in deep snow, it is necessary to install tire chain. If a tire chain is to be installed, an equivalent product with its size and type conforming to the tire specification must be selected. Otherwise, the vehicle performance and safety will be adversely affected. High risk exists for such operations as full-load, speeding, emergency acceleration, emergency braking and emergency steering.
- When decelerating, make the best of the braking function of the engine. Emergency braking on roads with snow or ice will cause vehicle drifting or slipping. Keep a safe distance with the front vehicle, slightly tread the brake pedal, and note that the tire chain installed can provide certain force of friction but cannot prevent the occurrence of sideslip.

Hint

Different countries and regions have different laws and regulations on tire chain, which shall be referenced before a tire chain is assembled. Do not install a tire chain without understanding the laws and regulations of a country or region, which may restrict the use of tire chain.

Caution

- Installing tire chain on tires shall guarantee the balanced driving under various weather conditions. Keep in mind that the vehicle may be short of power after being installed with tire chain. Drive with care even if the road condition is good. The driving speed shall not exceed the specified speed for tire chain, nor exceed 50km/h, whichever is smaller.

Caution

- If a tire chain is to be installed, make sure that the size and type of the tire chain are consistent with those of the standard tire. Otherwise, the safety and controllability of the vehicle will be adversely affected.
- Install tire chains in pair and do not install them on the rear wheels.
- Do not install any tire chain on a spare tire. If one of the front tires is a spare tire, replace the spare tire with a rear tire.
- Do not use tire chains on dry roads. Remove the tire chains when driving to a road without snow.
- Install the tire chains close to the front tire as much as possible. Tighten them after driving for 0.5~1.0 km.

7.1 Vehicle Identification Numbers

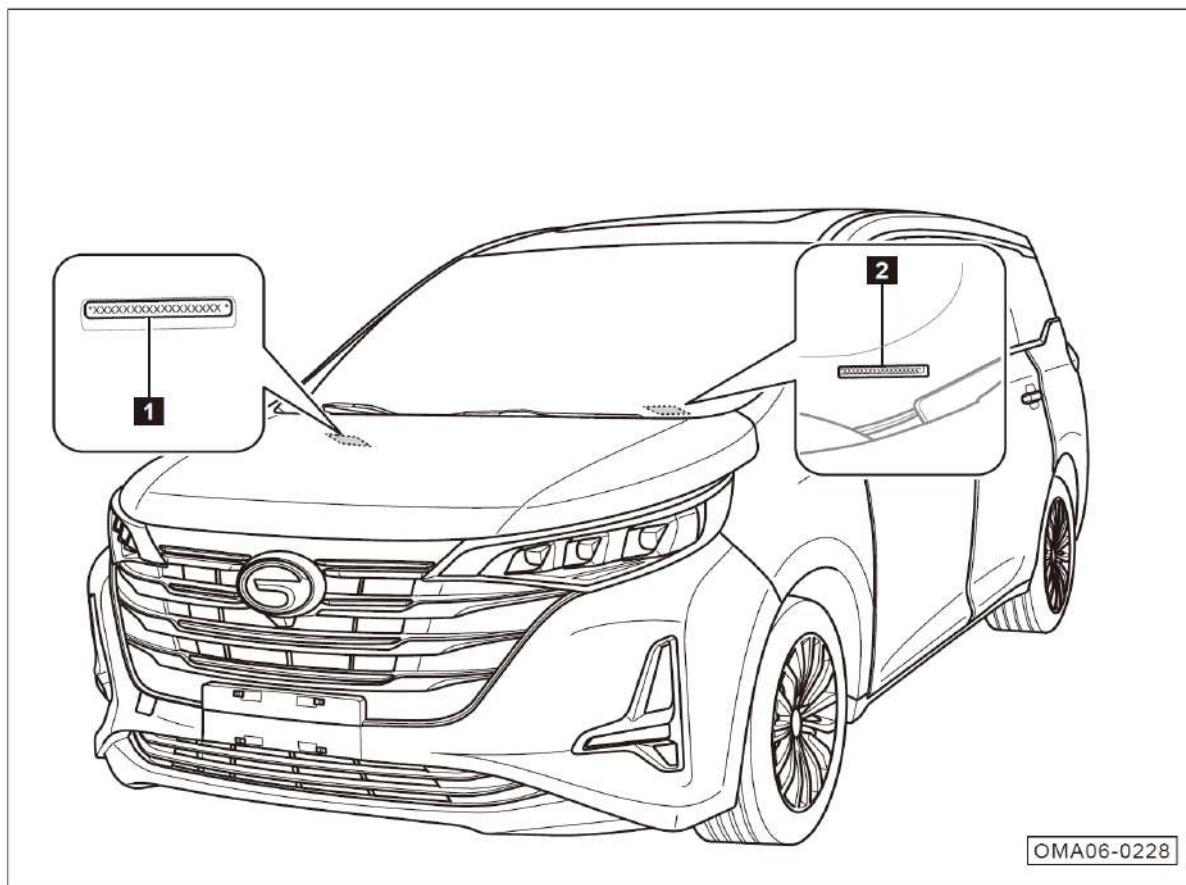

The positions of vehicle identification numbers (VINs) are shown in the figure:

1. Vehicle identification number (VIN): on the engine compartment diaphragm
2. Vehicle identification number (VIN): on the left side of instrument panel

i Hint

The position indication and quantity of vehicle identification numbers (VINs) are not complete. Please refer to the actual vehicle.

7 Technical Data

OBD Diagnosis Interface

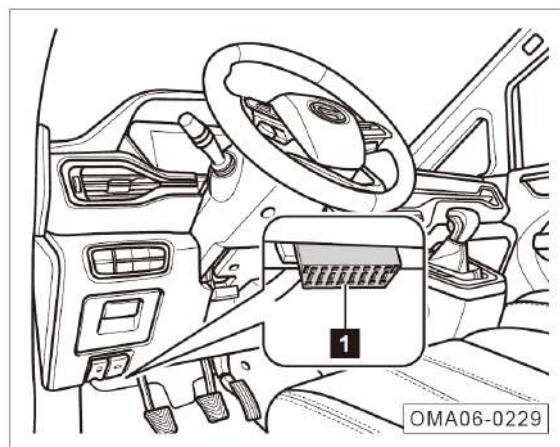

The OBD interface ① for reading the electronic VIN is located at rear left lower part of the dashboard. It can be used to read electronic VIN, vehicle status information and other data via special GIDS.

i Hint

Go to the authorized GAC MOTOR special store to consult and purchase the GIDS.

Engine Model and Factory Number

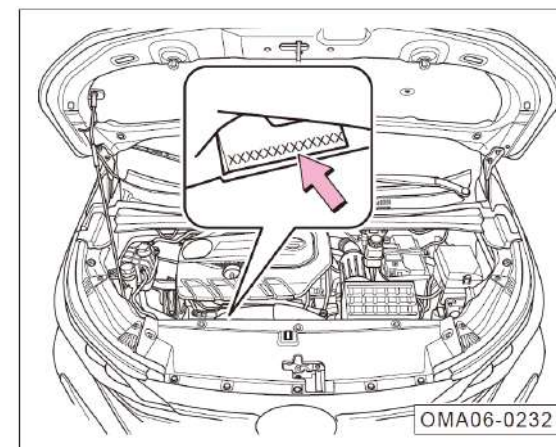

Engine model and factory number (see the arrow) is marked on the engine cylinder block (behind the generator).

7.2 Vehicle Parameters

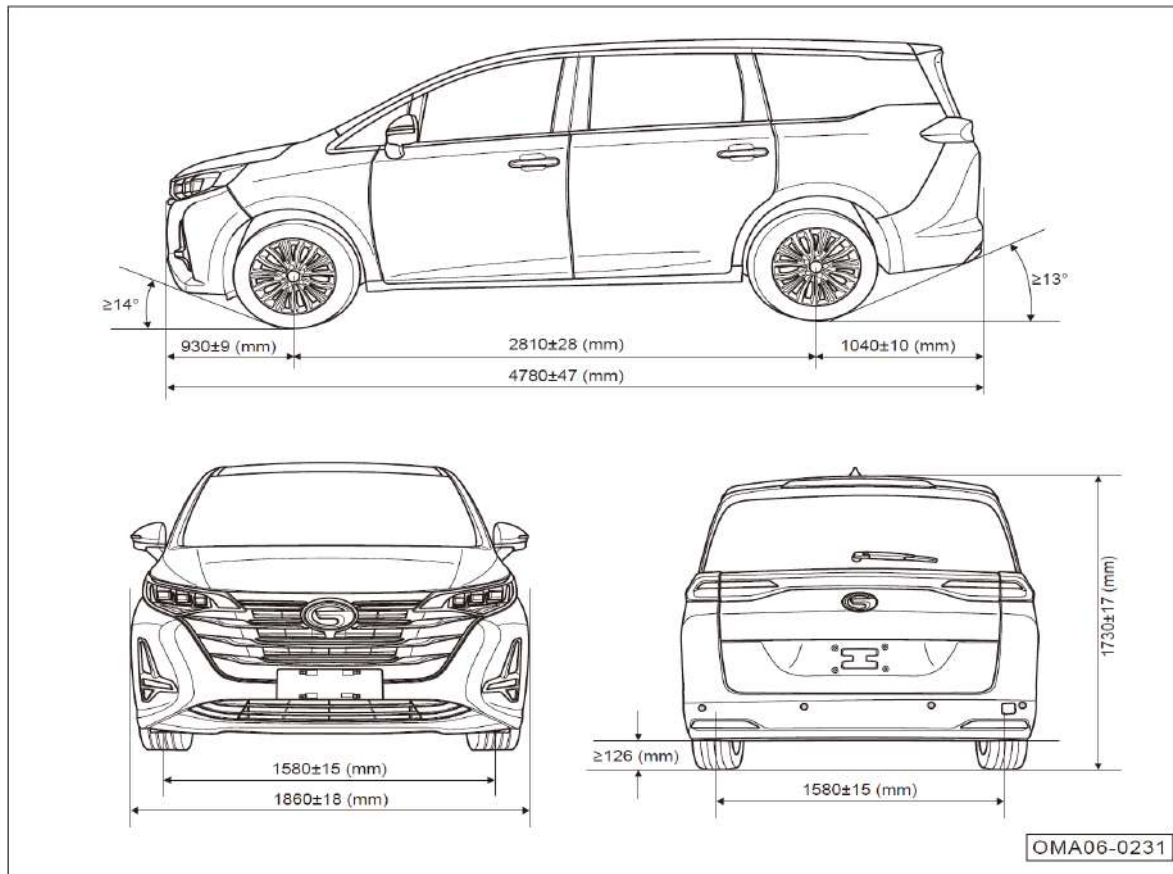

Dimension

Project	Parameters	
	Value	Unit
Total length	4780±47	mm
Total width	1860±18	mm
Total height	1730±17	mm
Wheel base	2810±28	mm
Tread	Front Wheel	1580±15
	Rear Wheel	1580±15
Front overhang	930±9	mm
Rear overhang	1040±10	mm
Minimum ground clearance (full load)	≥126	mm
Approach angle (full load)	≥14	°
Departure angle (full load)	≥13	°

Note: The left/right exterior rear-view mirror near the connection between the lower A-pillar and the front door and the antenna on the rear roof are not included in the width.

7 Technical Data

7.3 Vehicle Parameters

Mass

Model	Complete Vehicle Kerb Mass (kg)			Max. Total Mass (kg)		
	Kerb Mass	Front Axle Load	Rear Axle Load	Max. Total Mass	Front Axle Load	Rear Axle Load
GAC6480K1J5	1600±48	920±27	680±20	2327	1119	1208
GAC6480K2J5	1645±49	930±27	715±21			
GAC6480K1K5 GAC6480K1K5A	1615±48	920±27	695±20			
GAC6480K2K5 GAC6480K2K5A	1660±49	945±28	715±21			

Integrated Parameters

Project	Performance Parameters			Unit
	GAC6480K1J5 GAC6480K2J5	GAC6480K1K5 GAC6480K2K5	GAC6480K1K5A GAC6480K2K5A	
Number of occupants	7	7	6	oriented
Minimum turning diameter	≤11.5	≤11.5	≤11.5	m
Maximum gradeability	≥40	≥40	≥40	%
Time required to speed up to 100 km/h from zero	≤12.1	≤12.3	≤12.3	s
Maximum speed	≥195	≥185	≥185	km/h
Fuel consumption under urban conditions	≤9.4	≤9.6	≤9.6	L/100km
Fuel consumption under suburb conditions	≤6.1	≤6.2	≤6.2	L/100km
Fuel consumption under comprehensive conditions	≤7.3	≤7.4	≤7.4	L/100km

7 Technical Data

Engine Parameters

Model	4A15J1
Type	Gasoline, spark ignition type, in-line, four-cylinder, four-stroke, water-cooling, direct injection, double overhead camshafts, exhaust turbocharging
Number of cylinders	4
Ignition order	1-3-4-2
Cylinder diameter (mm)	75
Stroke (mm)	84.6
Displacement (mL)	1495
Compression ratio	9.8:1
Rated power / Rotated speed per Minute (kW/(r/min))	126/5000
Maximum net power / rotated speed per minute (kW/(r/min))	119/5000
Maximum torque / Rotated speed per Minute (Nm/(r/min))	265/1700~4000
Maximum net torque / Rotated speed per Minute (Nm/(r/min))	250/1700~4000
Idling stabilization RPM (r/min)	700±50
Emission level	National V

Oil Specification and Capacity

Project	Specification	Volume	
Fuel ¹⁾	Please refer to the description on the fuel requirement lable at the fuel filler door of each vehicle.	-	52 L
Engine coolant ²⁾	DF-6, -35°C coolant	MT model	7.1 L
		AT model	7.3 L
Engine oil	Engine oil grade: SN or above, viscosity: SAE 5W-30	Total ³⁾	4.5 L
ATF	AW-1	-	6.7 L
Manual transmission gear oil	SAE 75W-90 API GL-4	-	2.2 L
Brake fluid	DOT4	-	0.8 L
Windshield washer fluid	44% methyl alcohol and 56% water with hardness not greater than 205g/t	-	4 L
A/C refrigerant	R134a	-	900±20g

- Note:
- 1) Adding fuel oil with sulfur content higher than the standard for a long time may cause excessive emission. Please pay attention to use the fuel oil meeting the standards of vehicle selling place.
 - 2) Including the coolant in the storage tank and the coolant remaining in the engine.
 - 3) Volume required for overhaul of engine assembly.

7 Technical Data

7.4 Vehicle Parameters

Transmission Parameter

Model	6MF26B	TF-71SC
Type	MT	AT
Final drive ratio	4.353	4.316
1 st gear	3.833	4.044
2 nd gear	2.045	2.371
3 rd gear	1.323	1.556
4 th gear	1.029	1.159
5 th gear	0.825	0.852
6 th gear	0.707	0.672
Reverse gear	3.667	3.193

Wheels

Rim	6.5Jx16 *, 7Jx17 *	
Tire Specification	215/60R16*, 215/55R17*	
Tire Pressure	Front Wheel	Rear Wheel
	240 kPa (half load)	240 kPa (half load)
	240 kPa (full load)	260 kPa (full load)
Specification of spare rim	4.00B×16	
Spare tire specification	T135/90D16	
Spare tire pressure	420kPa	

Note: The standard pressure data of the original tires are pasted on the tire information label on the B-pillar of the driver's side.

Suspension

Type	Front	Rear
	McPherson independent type	Torsion beam semi-independent type

Steering gear

Type	Pinion-and-rack
Power type	EPS

Steering angle value

Maximum steering angle of inner wheel	38.83°
Maximum steering angle of outer wheel	31.08°

Brake

Type	Vacuum servo, X type hydraulic double-loop
Front Wheel	Disc brake
Rear Wheel	Disc brake
Parking brake	Electronic Parking Brake (EPB)

Drive Type

Drive Type	Front-wheel drive
------------	-------------------

Wheel Dynamic Balancing Value

Name		The Residual Amount of Dynamic Unbalance
Front Wheel	Inside	$\leq 8g$
	Outside	$\leq 8g$
Rear Wheel	Inside	$\leq 8g$
	Outside	$\leq 8g$

Brake Pedal Free Stroke

Name	Parameters
Stroke	106.4±10mm
Free stroke	$\leq 5.4mm$

Technical Parameters of Brake Lining

Name	Parameters
Wear limit for front brake lining (excluding its backing plate)	2 mm
Wear limit for rear brake lining (excluding its backing plate)	2 mm

Wheel Alignment Number

Name		Parameters
Front Wheel	Toe-in of single wheel	$0^{\circ}5'\pm 3'$
	Wheel camber	$-0^{\circ}15'\pm 30'$
	Kingpin caster angle	$7^{\circ}14'\pm 45'$
	Kingpin inclination angle	$12^{\circ}16'\pm 45'$
Rear Wheel	Total toe-in	$0^{\circ}12'\pm 18'$
	Thrust line	$0^{\circ}\pm 25'$
	Wheel camber	$-1^{\circ}6'\pm 30'$

Battery

Model		VARTA
Parameters	Rated voltage	12 V
	20hr rated capacity	55 Ah
	Low-temperature start current (EN)	530 A

Fuse

Instrument panel fuse box	=> Refer to Page 240
Engine compartment fuse box	=> Refer to Page 243

7 Technical Data

Lights

	Lights	Model	Power
Front combination light	High beam*	H8 (halogen)	35W
	Low beam*	HB3 (halogen)	60W
	High beam*	LED	23W
	Low beam*	LED	32W
	Daytime Running Light*	LED	20W
	Front position light	LED	3.6W*
		LED	3.1W*
	Front turn signal light	LED	11.4W*
WY21W (halogen)		21W*	
Front Fog Light *		LED	9.45W
Rear Fog Light		P21W (halogen)	21W
Side turn signal light		LED	0.5W
Rear combination light	Brake Light	LED	2.8W+5.5W
	Rear position light	LED	3.0W+4.8W*
		LED	3.0W+1.8W*
	Rear turn signal light	LED	6.6W+4.5W*
		LED	6.6W*
Reversing light		W16W	16W
Number Plate Light		LED	1.7W
High brake light		LED	2.56W
Front Roof Light		LED	2.16W

Lights	Model	Power
Second or Third Row Roof Light	LED	2.5W
Glove Box Light*	LED	0.5W
Trunk Light	LED	0.8W
Atmosphere Light*	LED	2W
Vanity Mirror Light*	LED	0.2W
Courtesy Light*	T10WB	5W

If the bulb is to be replaced => Refer to Page 210, please refer to the configuration of the actual vehicle, because some bulbs only apply to certain vehicles!

8.1 Vehicle Tools and Spare Tire

Vehicle Tools

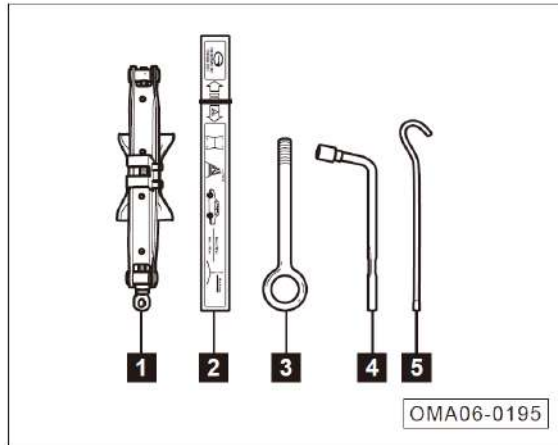

The following tools are delivered with the vehicle in the trunk => Refer to Page 107. After using, timely clean and place them back to the original position.

1. Jack
2. Warning triangle
3. Towing hook
4. Removal wrench for wheel bolts
5. Special wrench for jack

Jack

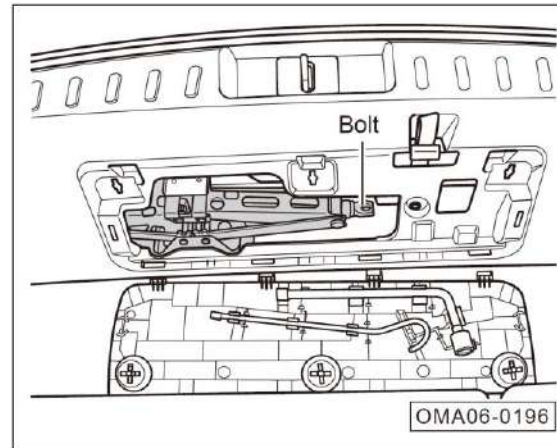

- Taking out: Rotate the bolt to shrink the jack for taking out.
- Fixation: After using the jack, place it back to the original position and rotate the bolt to slightly lift up to fix the jack.

Spare Tire

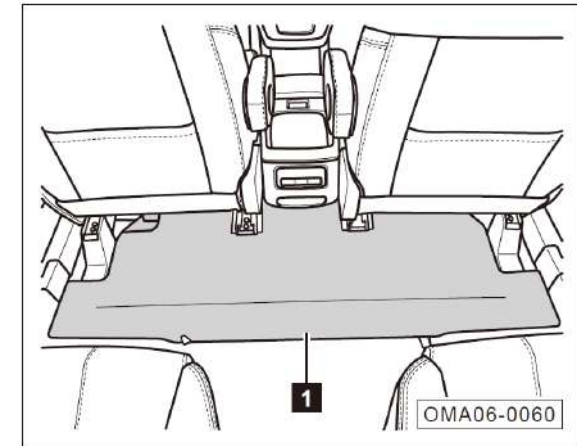

Take out the spare tire:

- Adjust the second row seats backward to the limit position.
- Turn over the carpet ① and take it out.

8. Handling of Accident

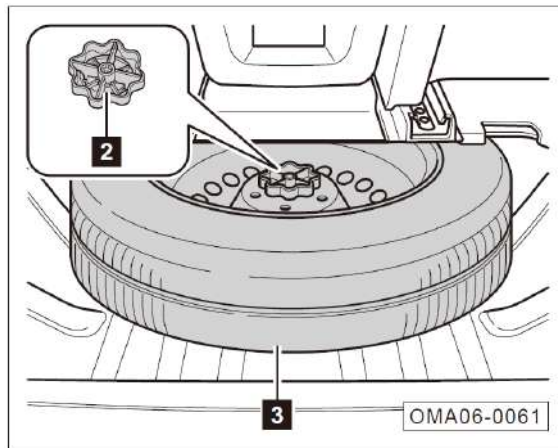

- Unscrew the central handwheel② of the spare tire and remove the spare tire③.

i Hint

Spare tire has been inflated; check the pressure regularly to ensure the maximum pressure and check it several times a year.

⚠ Warning

- Use it in strict accordance with the operating requirements of spare tire to avoid risks.
- It is forbidden to install more than one spare tire.
- Do not use the spare tire which has been damaged or worn down to the wear mark.
- The storage life of a spare tire is 6 years. Do not use any spare tire beyond the storage lift.
- After finishing installing the spare tire, check its pressure and make sure it is within the specified range.
- When using the spare tire, make sure that the speed does not exceed 80 km/h, and avoid sharp acceleration and emergency braking.

8.2 Usage of Warning Triangle

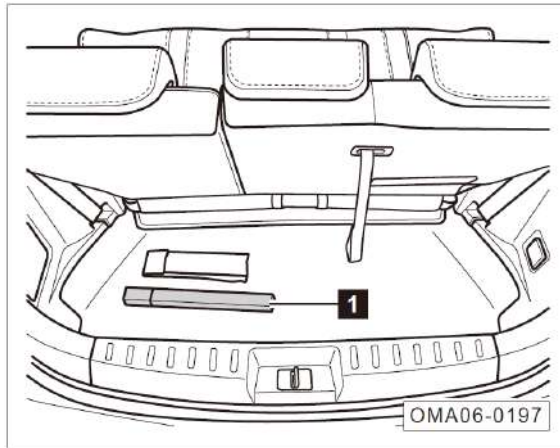

- Open the hatchback door. Take out and unfold the warning triangle ① for use.

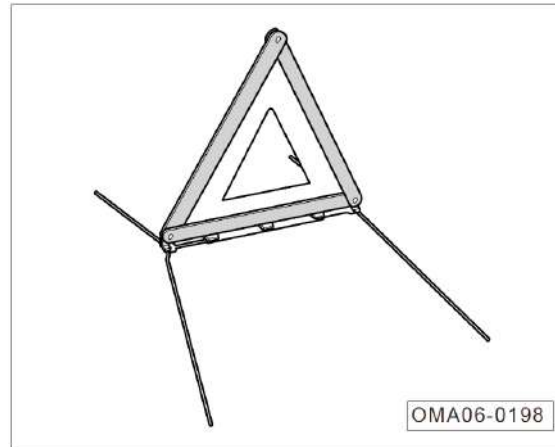

Location of Placement

General roads		Expressway
Daytime	Night	
≥50m	≥80m	≥150m

⚠ Caution

The above data is for reference only. For specific distance, please follow the relevant traffic regulations.

8. Handling of Accident

8.3 Replacing the Flat Tire

Preparations

- Apply parking brake.
- For vehicle models with automatic transmission, turn the gearshift to the "P" gear.
- For vehicle models with manual transmission, turn the gearshift to 1st gear.
- Turn the ignition switch to the "OFF" position, and turn on the hazard warning indicator light.
- Put the warning triangle at the appropriate place behind the vehicle.
- Wedge the vehicle with appropriate articles to prevent it moving and change the diagonal wheel.
- Take out the vehicle tools and the spare tire.

Warning

- Strictly obey relevant laws and regulations.
- All passengers must get off the car and wait in a safe place.

Unscrewing the Wheel Bolts

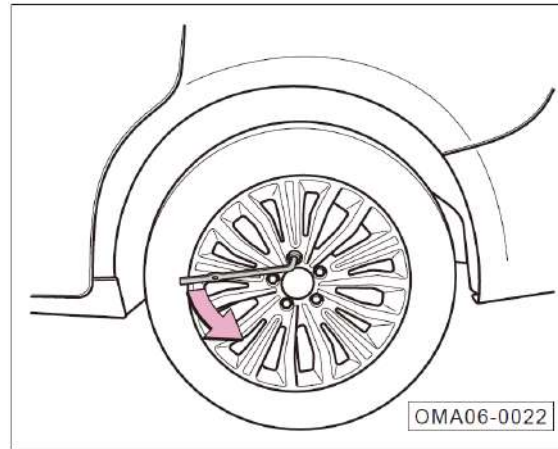

Put wheel bolt removal wrench firmly on the wheel bolt and loosen the bolt counterclockwise.

Caution

Unscrew the wheel bolt for one turn only before lifting the vehicle. Unscrew the wheel bolt out after the vehicle is lifted. Then remove the flat tire.

Lifting the Vehicle

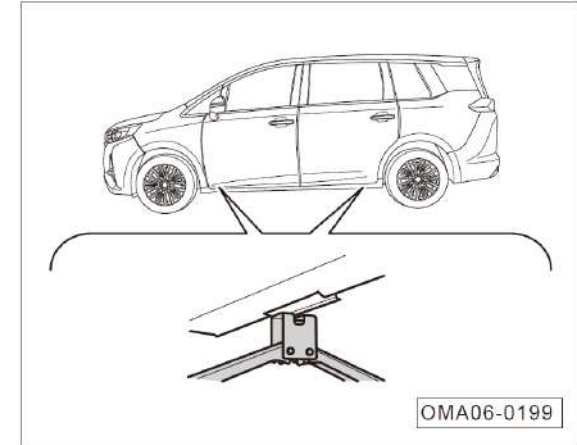

- Place the jack at the position just under the ridge nearest to the flat tire.
- Lift the jack and ensure its groove to fit the ridge.
- Check whether the jack is placed steadily and fits the ground tightly.

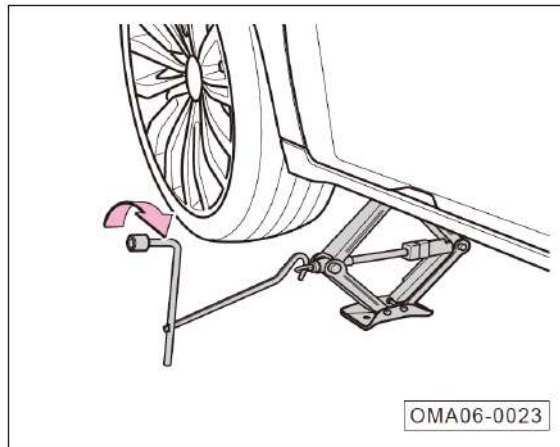

- Assemble the wrench for removing wheel bolts as well as special wrench for jack, and jack.
- Lift the jack clockwise to raise the vehicle and make the tire off the ground.

⚠ Warning

Improper use of the jack will cause serious damage.

- The jack should be used on hard and flat ground. You may place a hard base plate not thicker than 1 cm under the jack as necessary.
- Follow the precautions for operating the jack.
- Disconnect your vehicle from the trailer (if equipped).
- When lifting the car, continually observe its conditions. If the car inclines obviously, stop lifting and find out the cause before trying again.

⚠ Warning

- Only use your jack to jack up your vehicle and not to jack up other weights or vehicles.
- Do not start the engine when using the jack. Otherwise, an accident may occur.
- To avoid the risk of personal injury, do not put any part of your body under the vehicle when the vehicle is on the jack.
- Place appropriate protective support under the vehicle if the operation has to be done under the vehicle.

8. Handling of Accident

Installing the Spare Tire

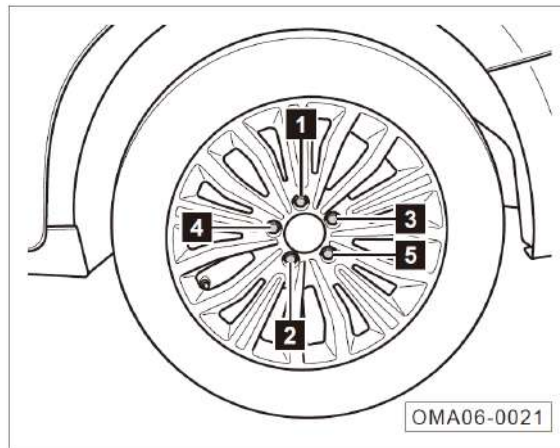

- Mount the spare tire on the vehicle.
- Install all wheel bolts, and pre-tighten them with the wrench as per the orders 1-5 shown in the figure.
- Give oral warning to ensure there is no other one around the vehicle. Turn the jack handle in a reverse direction to lower down the vehicle.
- Tighten all wheel bolts with the wrench.
- Remember the location of each tool and put the tool back and fix it to its original location after use to avoid noise from the vehicle during driving.

Caution

Go to the authorized GAC MOTOR special store to check the wheel bolt tightening torque ($125\pm 10\text{N}\cdot\text{m}$ for aluminium wheels and $110\pm 10\text{N}\cdot\text{m}$ for steel wheels) in time after tires are installed. Otherwise, the bolt may loosen during driving, resulting in traffic accidents.

Warning

- Keep the threads of the wheel bolts and hub clean, and make sure the bolts can be screwed easily. No grease or other attachment is permitted.
- When a tire is replaced, if any bolt is corroded or difficult to screw, replace it and clean the threaded hole.
- After the spare tire is out of service, it must be securely fixed on the spare tire installation position.

8.4 Fuse

Instrument panel fuse box

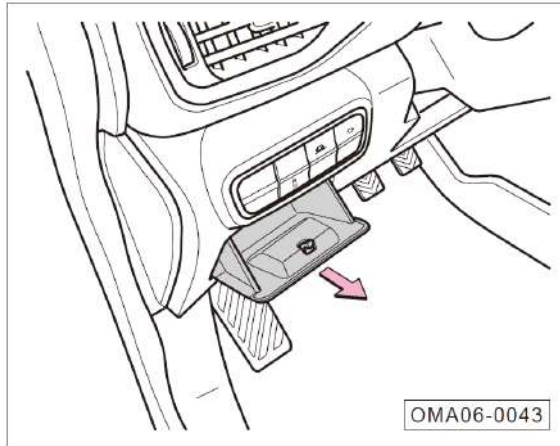

- Open and withdraw the storage box on lower guard plate of the driving cab in direction of the arrow, and then you will see the fuse on the instrument panel fuse box.

Engine compartment fuse box

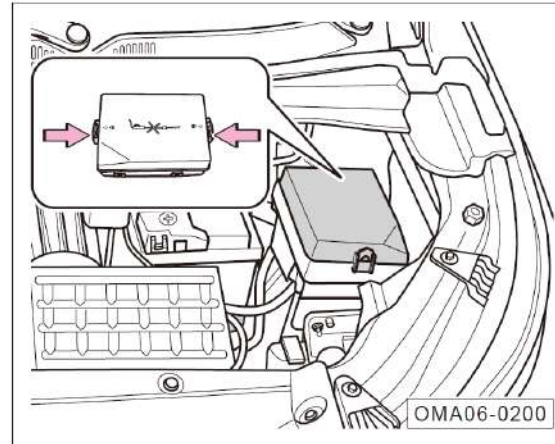

- Open the engine hood.
- Press the fixing clip in direction of the arrow and release the fuse box cover.
- Remove the fuse box cover, and then you can see the fuse on the fuse box of the engine compartment.

Replace the fuse

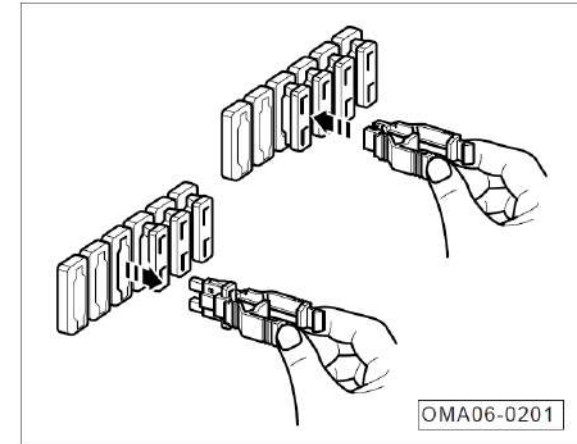

- Use the fuse extractor in the fuse box of engine compartment to extract or install the fuse.

8. Handling of Accident

Blown fuses

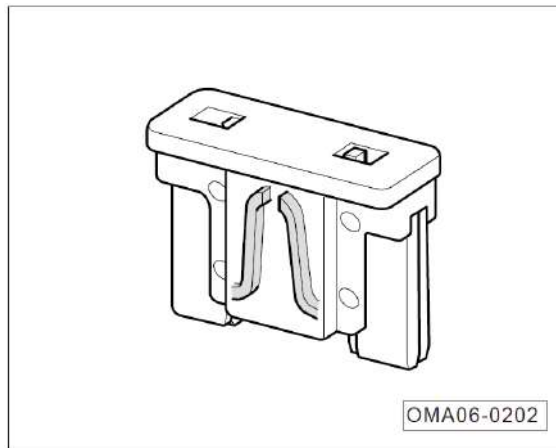

- If the fuse is blown, replace it with a new one at the authorized GAC MOTOR dealer.

Hint

One electric appliance may be equipped with multiple fuses, or several electric appliances may share a common fuse.

Caution

- Turn off all the electrical equipment before replacing the fuses.
- For replacement of fuse, consult your GAC MOTOR special store.

Warning

- Do not reuse any fuse.
- Do not use any fuse with rated current higher than the specified. Otherwise, other components of the electric system will be damaged.
- Using an inappropriate or repaired fuse may cause short circuit or even fire.
- Make sure that the color and identification of the new fuse are the same as those of the original one.
- Do not use a sheet metal, paper clip and the like to replace the fuse.
- Keep the inside of the fuse box clean and dry.

8.4.1 Fuses in the Instrument Panel Fuse Box

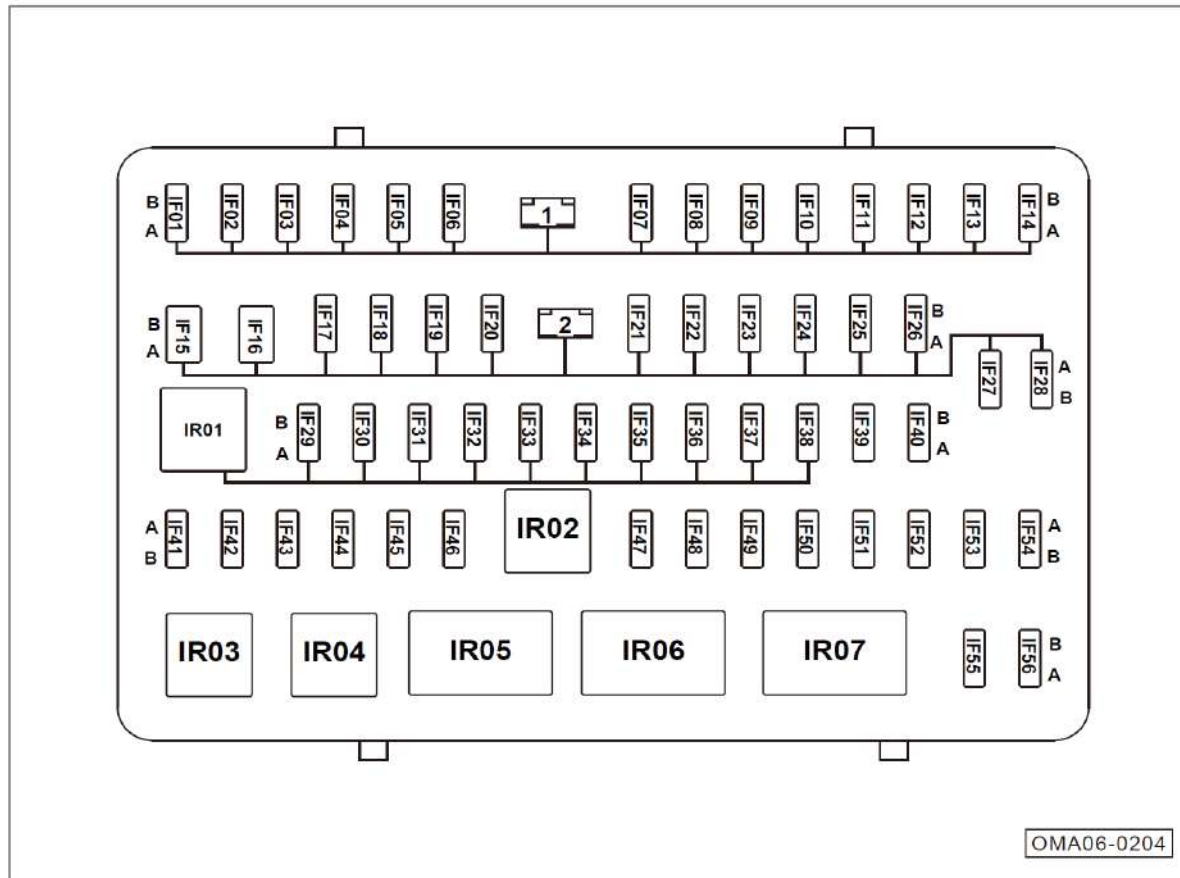

This figure does not apply to all vehicle models. Please check the purpose of the fuses on the real vehicle. The fuses depend on the vehicle model.

8. Handling of Accident

No.	Rated Value	Function/Component
IF01	—	—
IF02	20A	Electric seat adjustment*
IF03	20A	Power sunroof control unit*/panorama sunroof control unit*/panorama sunroof sunshade motor*
IF04	—	—
IF05	20A	Body control module (front right window regulator)
IF06	20A	Body control module (front left window regulator)
IF07	20A	Body control module (rear right window regulator)
IF08	20A	Body control module (rear left window regulator)
IF09	7.5A	Smartphone wireless charging module*
IF10	—	—
IF11	15A	Body control module (windshield washer and rear wiper motor)
IF12	10A	Rear-view mirror folding*
IF13	—	—
IF14	—	—
IF15	—	—
IF16	30A	Instrument panel fuse box
IF17	7.5A	OBD Diagnosis Interface
IF18	20A	Body control module (main light)
IF19	7.5A	Gateway module
IF20	7.5A	Gearshift module*
IF21	10A	Body control module (turn signal)

No.	Rated Value	Function/Component
IF22	—	—
IF23	7.5A	PEPS control unit * / Ignition switch * / ESCL *
IF24	20A	Body control module (main light)
IF25	7.5A	High brake light / EPB switch
IF26	20A	Body control module (door lock)
IF27	—	—
IF28	SHUNT	Divider
IF29	10A	SRS control unit
IF30	7.5A	Engine control unit/AT control unit*
IF31	7.5A	Gateway module/ body control module / PEPS control unit*
IF32	—	—
IF33	7.5A	Steering angular speed sensor/EPS control unit/gearshift module*
IF34	7.5A	Brake switch/ESP and EPB control module
IF35	7.5A	Parking sensor control unit / panoramic parking control unit * /rear A/C control panel / seat heating *
IF36	7.5A	Air quality sensor/anion generator*
IF37	7.5A	Front left combination light (height adjustment motor)/front right combination light (height adjustment motor)/headlight height adjustment switch /automatic headlight control unit
IF38	7.5A	Rain and light sensor * / power sunroof control unit / panoramic sunroof control unit * / front A/C control panel / A/C control unit / instrument cluster / AUDIO control unit

8. Handling of Accident

No.	Rated Value	Function/Component
IF39	15A	AT control unit*
IF40	15A	AUDIO control unit
IF41	7.5A	Body control module / PEPS control unit*
IF42	7.5A	USB charging port 1/ USB charging port 2
IF43	25A	Right trunk 12V power supply interface
IF44	7.5A	AUDIO control unit / rear-view mirror adjustment switch
IF45	25A	Front 12V power supply interface
IF46	—	—
IF47	7.5A	Front blower relay / rear blower relay / defogging relay / PEPS control unit * / electric anti-glare interior rear-view mirror *
IF48	—	—
IF49	—	—
IF50	7.5A	Body control module / PEPS control unit * / engine control unit / starter relay 1 / starter relay 2
IF51	7.5A	Panoramic parking control unit*
IF52	7.5A	Automatic headlight control unit *
IF53	7.5A	Front left door handle switch
IF54	7.5A	A/C control unit / PM2.5 sensor *
IF55	15A	Body Control Module
IF56	7.5A	Front A/C control panel / rear A/C control panel / AUDIO display / instrument cluster
IR01	—	IG1 relay

No.	Rated Value	Function/Component
IR02	—	IG2 relay*
IR03	—	—
IR04	—	—
IR05	—	ACC relay*
IR06	—	Rear-view mirror folding relay*
IR07	—	Rear-view mirror unfolding relay*

8. Handling of Accident

8.4.2 Fuse in Engine Compartment Fuse Box

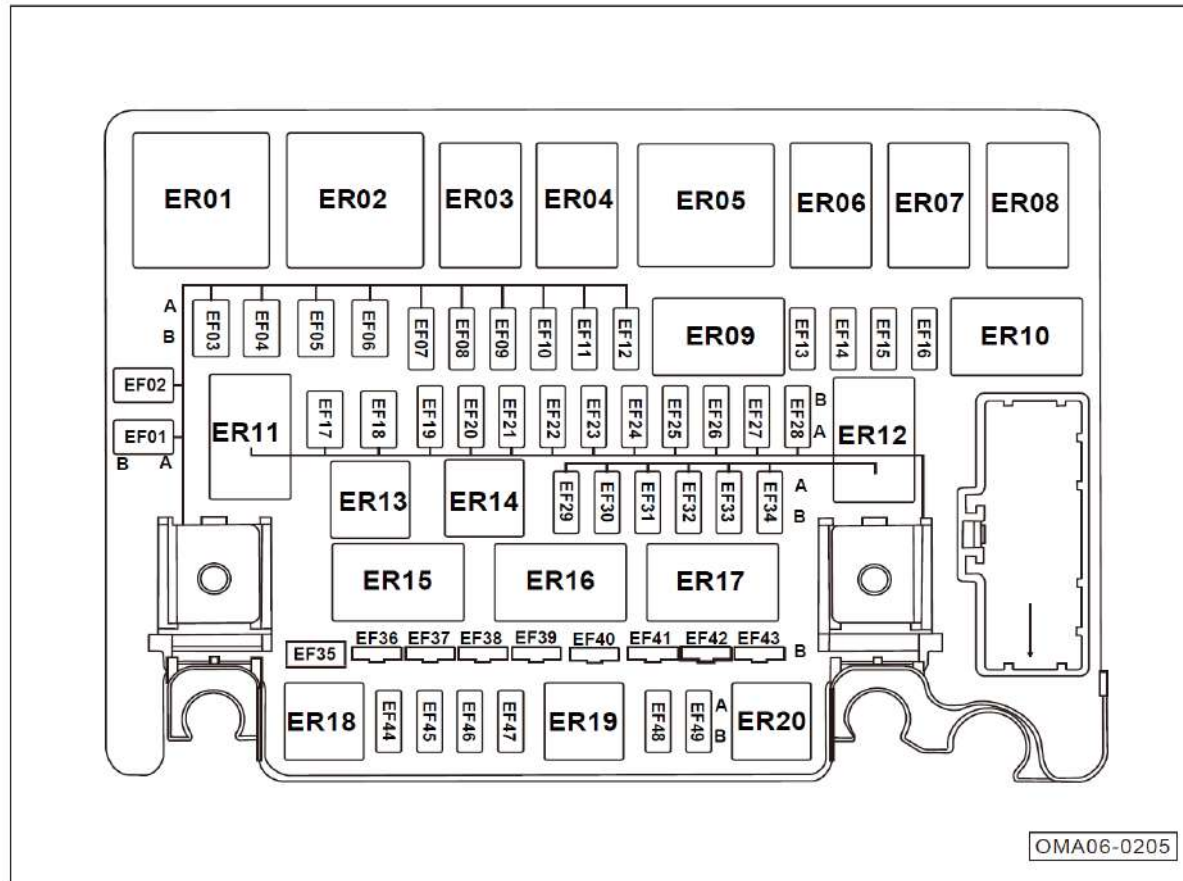

This figure does not apply to all vehicle models. Please check the purpose of the fuses on the real vehicle. The fuses depend on the vehicle model.

8. Handling of Accident

No.	Rated Value	Function/Component
EF01	—	—
EF02	—	—
EF03	40A	Rear Blower
EF04	40A/60A	ESP and EPB control module
EF05	—	—
EF06	—	—
EF07	7.5A	A/C compressor
EF08	—	—
EF09	—	—
EF10	20A	Seat Heating*
EF11	20A	High beam relay (high beam)
EF12	—	—
EF13	15A	Front Left Low Beam
EF14	15A	Front Right Low Beam
EF15	7.5A	Engine control unit
EF16	7.5A	Left rear-view mirror defogger*/right rear-view mirror defogger*
EF17	—	—
EF18	40A	ACC relay*/ignition switch/IG1 relay
EF19	7.5A	Low Beam Relay
EF20	—	—
EF21	—	—
EF22	—	—

No.	Rated Value	Function/Component
EF23	20A	Fuel pump
EF24	25A	Wiper
EF25	7.5A	Brake switch / main relay / starter relay 1 / starter relay 2 / engine control unit / ESP and EPB control module
EF26	15A	Horn relay / horn
EF27	—	—
EF28	—	—
EF29	—	—
EF30	10A	Variable cam timing (intake end)/variable cam timing (exhaust end)/discharge valve/throttle valve/carbon canister solenoid valve/oil pump solenoid valve
EF31	10A	Compressor relay/front oxygen sensor/rear oxygen sensor
EF32	15A	Engine control unit / clutch position sensor * / starter relay 1
EF33	15A	Ignition coil 1/ignition coil 2/ignition coil 3/ignition coil 4
EF34	10A	Electronic fan relay / fuel pump relay
EF35	80A	EPS control unit
EF36	40A	Instrument panel fuse box
EF37	40A	Front Blower
EF38	40A	ESP and EPB control module
EF39	40A	Rear-view mirror defogger * / rear windshield defogger
EF40	150A	Divider

8. Handling of Accident

No.	Rated Value	Function/Component
EF41	30A	Starter relay 1 / starter relay 2 / ignition switch / IG2 relay *
EF42	—	—
EF43	50A	Instrument panel fuse box
EF44	—	—
EF45	—	—
EF46	—	—
EF47	—	—
EF48	—	—
EF49	—	—
ER01	—	Front Blower Relay
ER02	—	Rear Blower Relay
ER03	—	Fuel pump relay
ER04	—	—
ER05	—	Electronic fan relay
ER06	—	Wiper speed regulation relay
ER07	—	Wiper relay
ER08	—	High Beam Relay
ER09	—	Defogging relay
ER10	—	—
ER11	—	Low Beam Relay
ER12	—	Main Relay

No.	Rated Value	Function/Component
ER13	—	Compressor Relay
ER14	—	—
ER15	—	Starter relay 1
ER16	—	Starter Relay 2
ER17	—	—
ER18	—	—
ER19	—	Horn Relay
ER20	—	—

8.5 Emergency Start

Jumper Cable

If you cannot start the engine because of low battery energy, you can use the jumper cable to connect with another vehicle's battery to start the engine.

Warning

- Engine compartment is a hazard area where improper operation may cause injuries or deaths.
- Before battery operation, carefully read and comply with relevant safety warnings and instructions about the operation of the battery.

Connect the positive terminals of the batteries before connecting the negative ones.

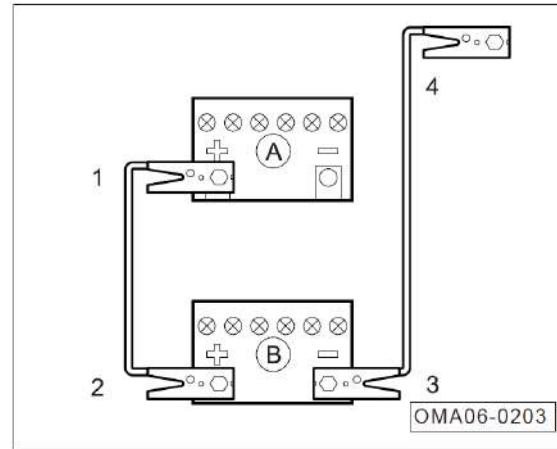

- Switch the Start switch to “OFF” position.
- Connect one end ① of the red cable to the positive electrode (+) of flat battery “A”, and the other end ② to the positive electrode (+) of booster battery “B”.

- Connect one end ③ of the black cable to the negative electrode (-) of booster battery “B”, and the other end ④ to the engine cylinder block or the metal component securely connecting with the engine cylinder block of the vehicle with flat battery “A”.

Caution

Place the jumper cables in position to prevent them from touching the moving parts of the engine.

- Start the engine of the vehicle with booster battery and let it idle, and then start the engine of the vehicle with flat battery until the engine runs smoothly.

8. Handling of Accident

Warning

- Do not remove the jumper cables until the headlights have been turned off.
- Turn on the air blower and rear windshield heater in the vehicle with flat battery to reduce the voltage peak resulting from removing the cables.
- Once your engine is running, disconnect the jumper cable in reverse sequence.

Warning

A battery can explode if you cannot use the jumper cable properly, seriously injuring anyone nearby.

- Make sure the voltage of the booster battery is equal to that of the flat battery, and the capacity of the booster battery is similar to that of the flat battery. Otherwise, it may cause explosion.
- Keep open flames away from the battery to avoid explosion.
- Do not connect the negative cable to the negative electrode of the flat battery directly. Make sure there is no static near the battery. Otherwise, combustible gas produced by the battery can be ignited by sparks, causing explosion.
- Do not connect the negative cable to the fuel system component or brake pipe. During operation, do not face the battery to avoid acid burns.

8.6 Emergency Towing

The front and rear parts of the vehicle are both provided with emergency traction port of threaded hole structure, to which the towing hook (a vehicle tool) can be installed for traction operation.

i Hint

The towing hook shall be placed on the vehicle so as to be used when needed.

⚠ Warning

Towing a vehicle in emergency is risky. If you have no experience, do not tow any other vehicle to prevent accidents.

Installation of Towing Hook

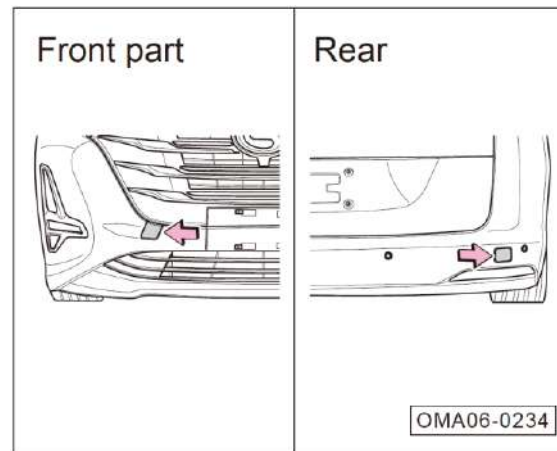

- Open the towing hook cover with a word knife wrapped in cloth at the position indicated by the arrow.

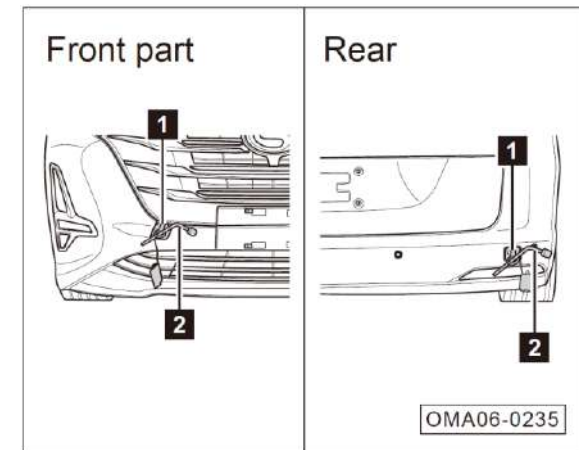

- Take out the towing hook ① and the wrench for removing wheel bolts ② from the tool box in the trunk.
- Screw the towing hook ① into the threaded hole clockwise.
- Insert the wrench for removing wheel bolts ② into the towing hook port, and rotate the wrench clockwise to securely screw the towing hook into the threaded hole.

8. Handling of Accident

Precautions for Traction

Before emergency traction, be sure to operate according to the following precautions:

- The drivers of the towing and towed vehicles must turn on the hazard warning indicator lights, and must observe the local traffic regulations.
- The towing hook must be securely screwed into the threaded hole. Otherwise, the towing hook may slip from the threaded hole during traction process.
- The towed vehicle must have its gearshift at the "N" position (Vehicle Models with Automatic Transmission) or at the neutral gear (Vehicle Models with Manual Transmission).
- The towed vehicle must have its start or switch at "ON" position. Rotate the steering wheel back and forth to confirm that it is not locked.

During emergency traction process, be sure to operate according to the following precautions:

- Start and move slowly until the tow rope strains, and then accelerate gradually.
- Drive smoothly, and do not accelerate, decelerate or turn sharply.
- Always remember that the brake booster and steering booster of the towed vehicle will not work. Normally, press the brake pedal in advance but press it slightly.
- During the traction operation, the tow rope must always be strained.

If the vehicle transmission suffers oil leakage, during the emergency traction, only the driving wheel of the vehicle can be lifted for traction, and:

- The towing speed shall not be greater than 50km/h.
- The maximum towing distance shall be 50km.

Warning

- The oil pump of the transmission cannot work when the engine is off. If the driving wheel rotates on the ground, the transmission will be at a working condition of poor lubrication when the vehicle is towed at a high speed and for a long distance, which will damage the transmission.
- Please do not lift the rear traction of the vehicle, otherwise the wheel will rotate backwards, and the gear in transmission will reach a very high rotating speed, causing serious damage to the transmission within a short time.

Towing

If your car has an accident and requires to be towed, we suggest using a platform truck to tow your car. If it is not available, you can also use a wheeled truck to tow your car if necessary.

Select proper towing method according to the configuration and fault condition of your car. But the following precautions must be noted:

- Contact your GAC MOTOR special store or the professional towing company for towing, and do not tow the vehicle by yourself without full confidence, otherwise the vehicle is very easy to be damaged.
- All towing methods require the use of safety chain system and shall comply with relevant traffic laws.
- You must tow your car according to the specification; otherwise it may cause the damage to your car and threaten traffic safety.

Tow the Car by Using a Platform Truck

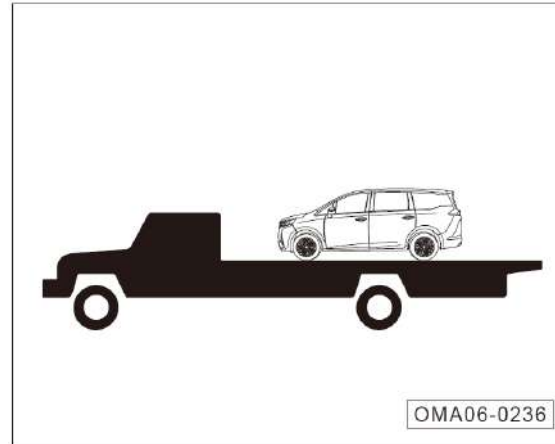

This towing method is applicable to all models of fault cars. We suggest using this method as much as possible.

Caution

Pay attention to apply parking brake and fix four wheels, to prevent the vehicle from moving during emergency braking of the trailer.

Tow the Car from the Front by Using a Wheeled Truck

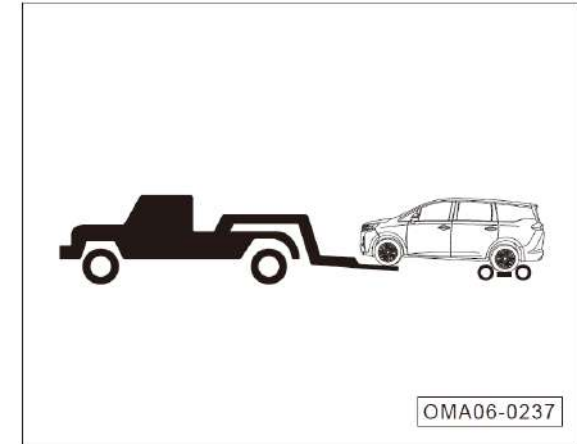

If your vehicle's rear wheels and rear axle are damaged, the towing platform shall be placed beneath your vehicle's rear wheels.

8. Handling of Accident

Caution

- For models with electronic parking brake (EPB), during dragging, a dragging trolley must be placed under the rear wheels. Otherwise, it may be easy to damage the brake and tire.
- When lifting the wheel, ensure that an appropriate ground clearance is reserved at the rear of the vehicle. Otherwise, the outer cover of rear bumper or underbody of the towed vehicle may be damaged.

Tow the Car from the Rear by Using a Wheeled Truck

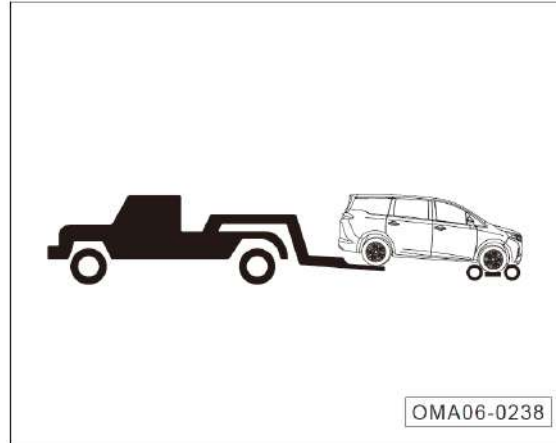

If your vehicle's front wheels and front axle are damaged, the towing platform needs to be placed beneath your vehicle's front wheels.

Caution

Do not tow the vehicle in excessive speed or for excessive length with the front wheels down to the ground, which will seriously damage the transmission.

Lifting Truck is Strictly Forbidden to Use.

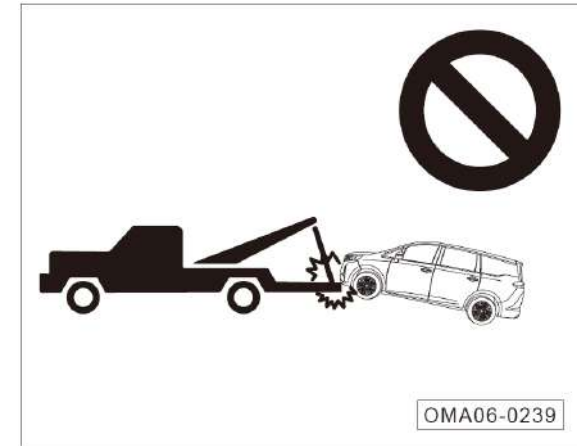

Do not use lifting truck to tow the car from the front or rear of the car. Otherwise, it may cause damage to the body.

9. Environmental Protection Information

9.1 Environmental Protection Information No.

S/N	Model	Environmental Protection Information No.	S/N
1	GAC6480K1J5	CN QQ G5 Z2 0B82000138	000001
2	GAC6480K2J5	CN QQ G5 Z2 0B82000139	000001
3	GAC6480K1K5	CN QQ G5 Z2 0B82000140	000001
4	GAC6480K2K5	CN QQ G5 Z2 0B82000141	000001
5	GAC6480K1K5A	CN QQ G5 Z2 0B82000142	000001
6	GAC6480K2K5A	CN QQ G5 Z2 0B82000143	000001

9. Environmental Protection Information

9.2 Environmental Protection Information

Environmental Protection Information	Model	
	GAC6480K1J5	GAC6480K2J5
Engine model/manufacturer	4A15J1 / GAC MOTOR	
Catalytic converter model/manufacturer	Front: 2079577X/front: Faurecia (Guangzhou) Automobile Parts and Systems Co., Ltd. Sanshui Branch Company	
Coating/carrier/encapsulation manufacturer	Coating: front: unit1: Wuxi Weifu Environmental Catalysts Co., Ltd. Carrier: front: unit1: NGK (Suzhou) Environmental Ceramics Co., Ltd. Encapsulation: front: Faurecia (Guangzhou) Automobile Parts and Systems Co., Ltd. Sanshui Branch Company	
Fuel evaporative control device model / manufacturer	2140003AAF00/Guangdong Hengbo Filter Co., Ltd.	
Oxygen sensor model/manufacturer	Front: LSF4; rear: LSF4/United Automotive Electronic Systems Co., Ltd.	
Crankcase emission control device/ manufacturer	10090082040000/Ningbo Shentong Moulding Co., Ltd.	
EGR model/manufacturer	/	
OBD model/manufacturer	MED17/United Automotive Electronic Systems Co., Ltd.	
IUPR monitoring	Conforming	
ECU model/version/manufacturer	MED17/MED17/United Automotive Electronic Systems Co., Ltd.	
Transmission model/number of gear positions	Manual/6	
Muffler model/manufacturer	Front: 2235452X; rear: 2235490X / Faurecia (Guangzhou) Automobile Parts and Systems Co., Ltd. Sanshui Branch Company	
Turbocharger model/manufacturer	KP39/BorgWarner Automobile Parts (Ningbo) Co., Ltd.	
Intercooler type	/	

9. Environmental Protection Information

Environmental Protection Information	Model			
	GAC6480K1K5	GAC6480K2K5	GAC6480K1K5A	GAC6480K2K5A
Engine model/manufacturer	4A15J1 / GAC MOTOR			
Catalytic converter model/manufacturer	Front: 2079577X/front: Faurecia (Guangzhou) Automobile Parts and Systems Co., Ltd. Sanshui Branch Company			
Coating/carrier/encapsulation manufacturer	Coating: front: unit1: Wuxi Weifu Environmental Catalysts Co., Ltd. Carrier: front: unit1: NGK (Suzhou) Environmental Ceramics Co., Ltd. Encapsulation: front: Faurecia (Guangzhou) Automobile Parts and Systems Co., Ltd. Sanshui Branch Company			
Fuel evaporative control device model / manufacturer	2140003AAF00/Guangdong Hengbo Filter Co., Ltd.			
Oxygen sensor model/manufacturer	Front: LSF4; rear: LSF4/United Automotive Electronic Systems Co., Ltd.			
Crankcase emission control device/ manufacturer	10090082040000/Ningbo Shentong Moulding Co., Ltd.			
EGR model/manufacturer	/			
OBD model/manufacturer	MED17/United Automotive Electronic Systems Co., Ltd.			
IUPR monitoring	Conforming			
ECU model/version/manufacturer	MED17/MED17/United Automotive Electronic Systems Co., Ltd.			
Transmission model/number of gear positions	Auto/6			
Muffler model/manufacturer	Front: 2235452X; rear: 2235490X / Faurecia (Guangzhou) Automobile Parts and Systems Co., Ltd. Sanshui Branch Company			
Turbocharger model/manufacturer	KP39/BorgWarner Automobile Parts (Ningbo) Co., Ltd.			
Intercooler type	/			

This Manual describes information related to configurations, functions, performance parameters and product schematic drawings of vehicles from GAC MOTOR. Its contents are effective when printing is allowed. But actual car configurations and functions are subject to actually delivered cars. If there is any difference between the product schematic drawing and actual car, the actual one should prevail.

GAC Motor reserves the right to alter, supplement or terminate the contents or technical specifications in this Manual without further notification.

All copyright is reserved by GAC Motor. Without written permission by GAC Motor, no printing and extracting of contents of this Manual is allowed.

GAC MOTOR

For operational guideline of GN6 models, refer to:
<https://trumpchi.gacmotor.com/index.php/teach/chm>