

GWM

ORA GOODCAT

Owner's Manual

2022.11-MY

Owner's Manual

ORA GOODCAT

GWM

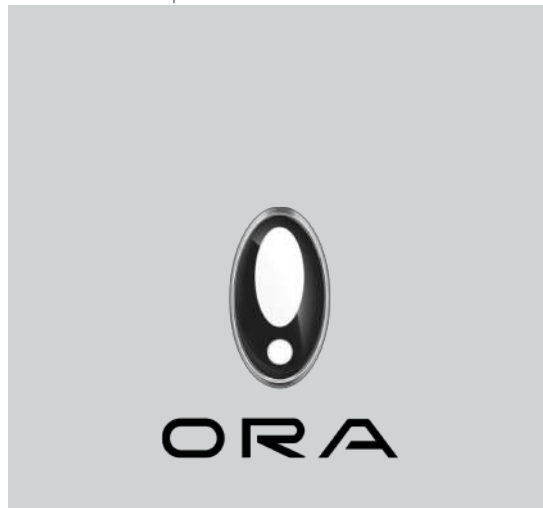

Thank you for choosing a ORA vehicle.

Familiarizing yourself with your vehicle will make driving easier and more comfortable. Therefore, we suggest:

Before using your vehicle, please read this manual carefully. You will find important information concerning the operation of the vehicle, which will allow you to make full use of its technological advantages. Additionally, you will find very useful information concerning the vehicle's safety features, traffic safety and preserving the highest value for your vehicle.

We hope you have a safe and happy journey!

27/04/2022

Overview

Vehicle equipment

Please note that this manual contains all the standard equipment, country-specific equipment and special equipment for this model series. Thus, some equipment or features described in this manual may not be installed onto your vehicle or are only available in some markets. For specific configuration information, please refer to relevant sales materials or consult your vehicle dealer.

Accessories, spare parts and modifications

There is now the availability of a variety of other spare parts and accessories that are suitable for our vehicle. If you need to replace parts, it is suggested that you use genuine parts for replacement; you can also use other parts that meet the quality requirements.

Please understand that we are unable to offer any warranty and do not assume any responsibility or liability for non-genuine spare parts and accessories as well as replacement and installation by using non-genuine spare parts and accessories. In addition, vehicle damage and performance issues arising from the use of non-genuine spare parts and accessories are not covered by the quality warranty.

Timeliness of manual

All information provided in this manual

is up to date at the time of publication. However, due to continuous improvement of the product, the contents of this manual will be updated at any time without notice.

Depending on the vehicle specifications, vehicles shown in the figure may differ from your vehicle.

About symbols

WARNING

This indicates a warning.

Failure to observe these warnings may result in serious injury or death. Such warnings indicate what you must or must not do in order to reduce the risk of serious injury or death to yourself and others.

CAUTION

This indicates a caution.

Failure to observe these precautions may result in damage to the vehicle or its equipment. Such cautions indicate what you must or must not do in order to avoid or reduce the risk of damage to the vehicle or its equipment.

NOTICE

This indicates a reminder.

This reminder contains ancillary information that may be helpful to you.



Herein, a circle with a slash through it indicates "no", "do not do this", or "do not allow such conditions to occur".

(▶ Page X)

This symbol indicates that more details can be seen on this page.

Tips for safety

WARNING

General precautions for your driving:

- › Keep sober when you are driving: it is prohibited to drive vehicles after drinking or taking drugs (which may affect your ability to control the vehicle).
Alcohol and certain drugs may delay reaction time, affect judgment and coordination, as a result, it may give rise to accidents and serious injuries.
- › Drive carefully: be sure to drive carefully. Always keep an eye on improper movements of other drivers or pedestrians on the road so as to make timely judgments and prevent accidents.
- › Concentrate on driving: be attentive when driving. Anything that distracts the driver's attention, such as adjusting control buttons, call up and answer a mobile phone or reading, may give rise to a crash accident and serious injury to you, passengers on the

vehicle and other people.

WARNING

It is prohibited to leave children alone in the vehicle and you shall not allow children to carry or use the keys.

Children may start the vehicle or operate the gear shift arbitrarily. Children who play with the windows, sunroof, or other equipment in the vehicle may injure themselves. In addition, if the temperature within the vehicle is too high or too low, it may also cause fatal injury to children.

Exteriors (type 1)

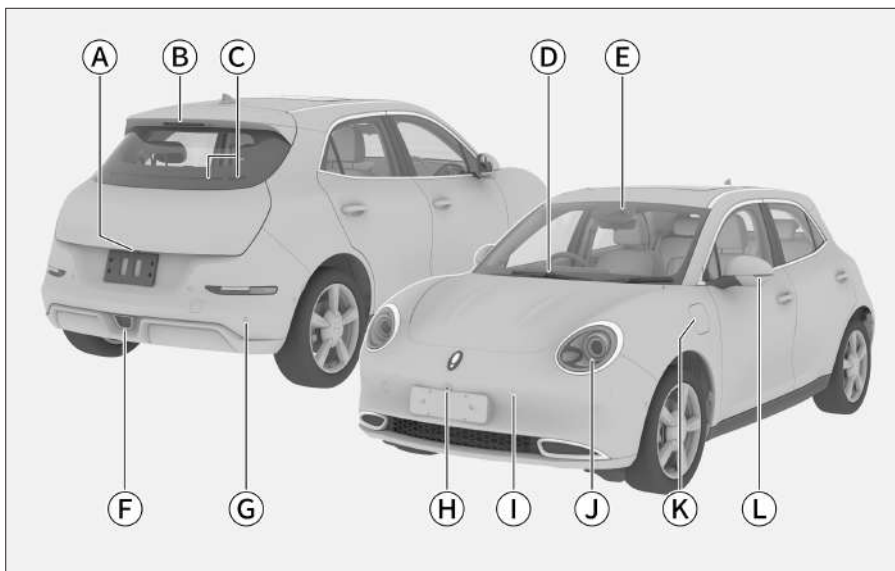

D785D6CED5BC

- Ⓐ Camera, depending on model configuration, is used for:
 - Reverse camera [114](#)
 - Panoramic surround-view image [115](#)
- Ⓑ High-mounted brake lamp
- Ⓒ Rear combination lamp
- Ⓓ The following parts may be assembled, depending on the configuration of vehicle models:
 - Electric wiper [61](#)
 - Automatic wiper [62](#)
- Ⓔ Depending on model configuration, the camera is used for:
 - Forward assist system [138](#)
 - Lane assist system [140](#)
 - Traffic sign information [148](#)
- Ⓕ Rear fog lamp [57](#)
- Ⓖ Reverse radar [113](#)
- Ⓗ Camera is used for:
 - Panoramic surround-view image [115](#)
- Ⓘ Anti-collision radar [113](#)
- Ⓙ Front combination lamp
- Ⓚ Charging port cover [39](#)
- Ⓛ Outside rearview mirror [52](#)

Exteriors (type 2)

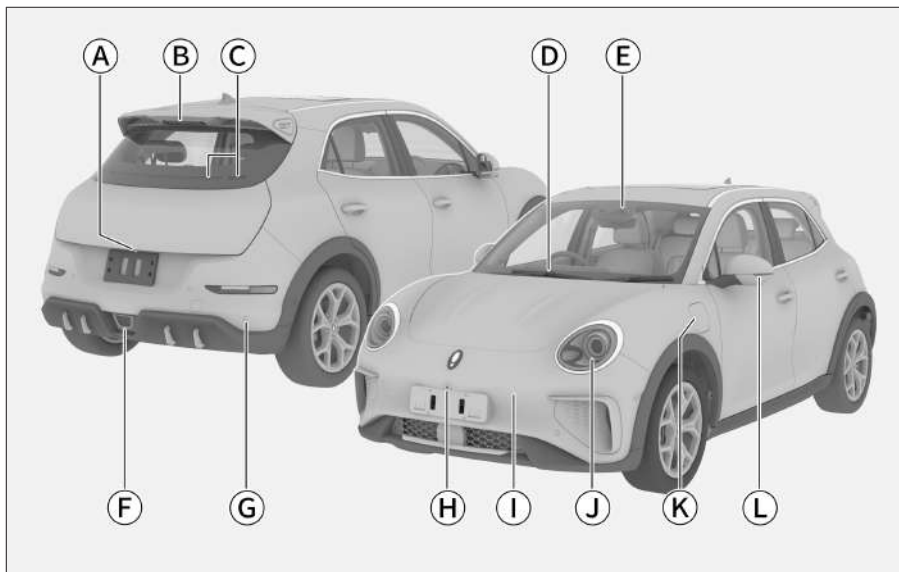

D5D1052F30F3

- Ⓐ Camera, depending on model configuration, is used for:
 - Reverse camera [114](#)
 - Panoramic surround-view image [115](#)
- Ⓑ High-mounted brake lamp
- Ⓒ Rear combination lamp
- Ⓓ Automatic wiper [62](#)
- Ⓔ Camera, depending on model configuration, is used for:
 - Forward assist system [138](#)
 - Lane assist system [140](#)
 - Traffic sign information [148](#)
- Ⓕ Rear fog lamp [57](#)
- Ⓖ Reverse radar [113](#)
- Ⓗ Camera is used for:
 - Panoramic surround-view image [115](#)
- Ⓛ Anti-collision radar [113](#)
- Ⓜ Front combination lamp
- Ⓨ Charging port cover [39](#)
- Ⓩ Outside rearview mirror [52](#)

Interior trim

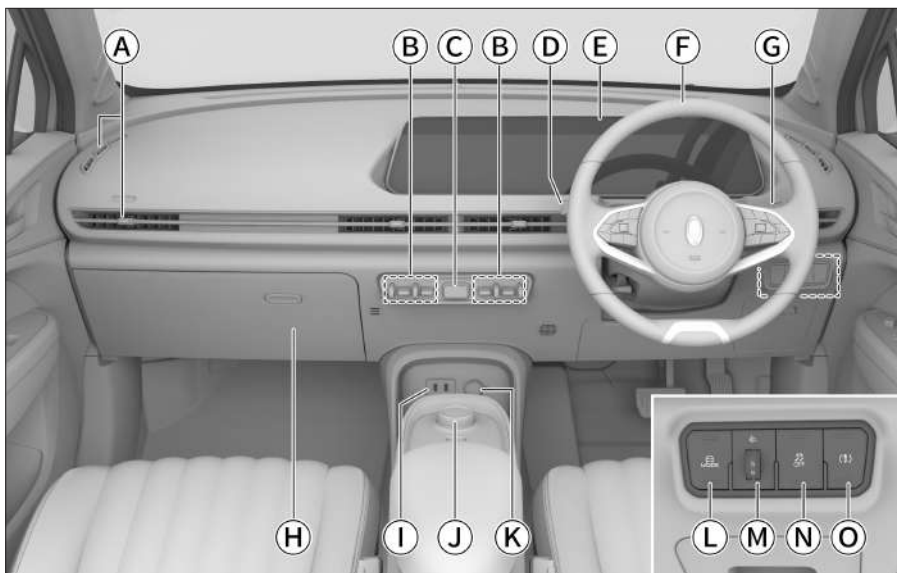

- Ⓐ A/C vent [72](#)
- Ⓑ Air conditioning control switch [66](#)
- Ⓒ Emergency flasher switch [58](#)
- Ⓓ Light control combination switch [56](#)
- Ⓔ Display screen is used for:
 - Virtual instrument [154](#)
 - Instrument indicator [160](#)
 - Multimedia [175](#)
- Ⓕ Steering wheel [55](#)
- Ⓖ Wiper control combination switch [61](#)
- Ⓗ Storage box [75](#)
- Ⓘ USB interface [175](#)
- Ⓝ Shift knob [102](#)
- Ⓚ Standby power [77](#)
- Ⓛ Driving mode switch [105](#)
- Ⓜ Regulating switch for light height [59](#)
- Ⓝ Due to different model configurations, the switch is used for:
 - Electronic stabilization program [152](#)
 - Electric sensory back door [24](#)
- Ⓞ Vehicle power supply switch [97](#)

Table of contents

1 Operation

This Chapter introduces the method for operating on-board vehicle equipment, such as keys, doors, windows and seats.

2 Driving

This Chapter introduces the driving information, such as vehicle start, gear shifting and instrument of the vehicle.

3 Audiovisual system

This Chapter introduces the Bluetooth telephone, system setting and other audio-visual system related information.

4 Safety

This Chapter introduces the functional equipment, such as anti-theft system and seat belts.

5 Emergency

This Chapter introduces the treatment methods for vehicle failures such as flat tyre and battery loss.

6 Maintenance

This Chapter introduces the routine inspection and regular maintenance of the vehicle.

7 Technical data

This Chapter introduces the vehicle parameters, identification number and other information.

8 Index

This Chapter introduces the alphabetical index in this manual.

Operation

Key	16	Sunroof.....	33
About the key	16	Opening and closing the sunroof ..	33
Button introduction.....	16	Opening and closing the sunshade ..	34
Battery replacement.....	17	Linkage function.....	34
Door lock.....	20	Anti-pinch function	34
Locking and unlocking through the		Delay function	35
PEPS	20	Speedy closing.....	35
Locking and unlocking with key but-		Automatic sunroof closing.....	35
tons	21	Initialization	35
Locking and unlocking with center		Engine hood.....	37
control buttons	21	Opening.....	37
Unlocking with the interior handle		Closing.....	37
.....	21	Vehicle charging.....	39
Locking and unlocking with the me-		Charging mode.....	39
chanical key	22	Charging cable.....	40
Locking during emergencies	22	Ordinary charging.....	41
Back door	23	Emergency unlock.....	44
Child safety lock	28	Fast charging	44
Parking unlock.....	28	Seats	46
Auto driving lock	28	Headrest.....	46
Automatic resetting function	29	Front seats	46
Automatic unlock upon collision ...	29	Rear seats	50
Vehicle windows	30	Rearview mirrors	52
Window switch	30	Interior rearview mirror	52
Thermal protection function	31	Side mirrors	52
Anti-pinch function	31	Steering wheel.....	55
Delay function	31	How to adjust	55
Speedy closing.....	32	Horn.....	55
Initialization	32	Light control	56

Lamp settings	56	Before driving.....	80
Light control combination switch ..	56	Precautions for driving.....	81
Emergency flashers	58	Precautions for passengers.....	82
Daytime running lamp	58	Parking the vehicle	83
Follow me home function.....	59	Economic driving.....	83
Emergency braking warning.....	59	Suggestions for driving in harsh envi- ronment	85
Light height adjustment.....	59	Driving in foggy weather	85
Interior lamps.....	59	Driving in the rain	85
Wiper control.....	61	Fording drive.....	85
Electric wiper	61	Driving during the hot seasons.....	86
Automatic wiper.....	62	Driving during the cold season	87
Front wiper washing setting.....	65	Suggestions for driving in running-in period	90
Air conditioning system	66	Tyre	90
Air conditioning control panel	66	Friction lining of brake	90
A/C setting interface	67	Pure electric vehicles.....	91
A/C comfort setting.....	69	About pure electric vehicle.....	91
A/C system control.....	71	Power battery recovery.....	92
Cleaning function of the seat com- partment	72	Heat preservation function of the plug	93
Vent.....	72	About energy recovery.....	94
Mobile wireless charging.....	73	Battery safety switch	96
How to use	73	High voltage warning label	96
Interior equipment	75	Vehicle's power supply.....	97
Sun visor.....	75	Vehicle power supply	97
Vanity mirror.....	75	Parking brake	99
Storage device	75	Tips for safety	99
Power socket	77	Electronic parking brake	99
Driving		Transmission	102
Driving norms.....	80		

Introduction to gear position	102	System introduction	127
How to shift	102	How to use	127
Creep function.....	103	Cruise assist system	130
Start the vehicle	103	System introduction	130
Stop the vehicle.....	104	Combination instrument display	130
Driving mode.....	105	How to use.....	131
Switching method.....	105	Queuing auxiliary function	134
Super power-saving mode	107	Curve road auxiliary function.....	134
Super power-saving mode.....	107	Lane center keeping function during	
Single pedal mode.....	108	cruising	135
One-pedal mode	108	Functional limitations.....	135
Voice prompt system	110	Sensor.....	136
How to use	110	Intelligent drive assist system.....	137
Power-steering mode.....	111	How to use	137
Switching method	111	Sensor.....	137
Parking assist system	112	Forward assist system.....	138
Tips for safety.....	112	Lane assist system.....	140
Reverse radar	113	Rear side assist system	144
Anti-collision radar.....	113	Traffic sign information.....	148
Reverse camera.....	114	Driving assist system.....	151
Panoramic surround-view image	115	Tips for safety	151
Fully automatic integrated parking		Anti-lock brake system.....	151
system	120	Electronic braking force distribution	
Reversing assist.....	122	system	152
Parking settings.....	123	Braking force assist system.....	152
Tyre pressure monitoring system ..	125	Traction control system	152
System introduction	125	HHC (Hill-start hold control).....	152
Monitoring function.....	125	Electronic power steering system	
Alarm function.....	126	152
Cruise control system	127	Electronic stabilization program.	152

Virtual instrument	154	Navigation system	178
Summary.....	154	Menu interface	181
Steering wheel button.....	156	Shortcut panel.....	184
Driving data interface.....	156	Voice assistant.....	185
Audio media interface.....	157	System settings	186
BT phone interface	157	Energy consumption assistant....	190
Navigation information interface	157	Mobile interconnection.....	192
Alarm information interface.....	157	Comfort mode	193
Menu setting interface	158	Multimedia player - type II.....	194
Indicator lights on instrument panel		Steering wheel button.....	194
.....	160	Power switch	195
Instrument indicator	160	External devices	195
Power management system	168	Multimedia display screen operation	
System introduction	168	196
Information you should know.....	169	Central display screen status bar	197

Audiovisual system

Tips for safety.....	172	Interface introduction	197
Safety	172	Shortcut panel.....	198
About the use	172	Apple CarPlay	199
About the radio	172	Android Auto	199
About USB storage devices	172	Local multimedia.....	200
About Bluetooth.....	172	System setting	201
Multimedia player - type I.....	174	Energy consumption assistant....	203
Vehicle equipment.....	174	Contact	204
Steering wheel button.....	174		
Power switch	175		
External devices	175		
Central display screen operation	176		
Central display screen status bar	177		

Safety

Seat belt	208
Tips for safety	208
Wear the seat belt properly.....	209
Pretensioner seat belt.....	209
How to use the three-point seat belt	
.....	210

Airbag	212	kit.....	232
Tips for safety	212	When the tyre is punctured or the tyre pressure is insufficient.....	233
Airbag	213	Inflator and tyre repair fluid.....	233
Front airbag	213	Emergency tyre repair.....	234
Front passenger airbag switch....	215	Tyre inflation.....	235
Side airbags	216	In case of vehicle accident.....	236
Curtain airbags.....	217	Traffic accidents occur to vehicles	236
Child restraint system	219	For the fire accident of vehicle:...	236
Recommended child seat type ...	219	Jump start	238
Fixing point for child seat	219	Symptoms of a drained vehicle battery	238
Applicability information of child seat	219	How to jump start the vehicle.....	238
Installation method of child seat	221	Towing.....	240
Precautions for installing child seats	223	Use a professional transport	240
Vehicle anti-theft system	225	When the vehicle gets stuck or bottoms out,.....	240
About the system.....	225	Tow hook.....	242
System activation.....	225	Service and rescue	243
Alarm trigger condition	225	On-board phone	243
Alarm cancellation	225	Manual services	243
System off	225	Emergency rescue	243
Emergency cut-off system	227	Car networking function indicator	245
Emergency cut-off system	227		
Event data recorder.....	228		
System introduction	228		
Data reading.....	228		
Data disclosure.....	228		

Emergency

On-board tools.....	232
Storage location for on-board tool	

Maintenance

Necessity of vehicle maintenance..	248
Engine compartment	249
Tips for safety.....	249
Fluid level	250

Brake fluid.....	251
Coolant.....	251
Windshield washer fluid	252
Active intake grille.....	252
Battery.....	252
Safety labels and identifiers	253
Parts replacement	255
Fuse.....	255
Wiper blade.....	256
Bulbs	257
Vehicle maintenance.....	259
Tyre maintenance	259
Sunroof maintenance.....	261
Exterior maintenance.....	262
Interior maintenance	263
Anti-corrosion measures	265
Long-term storage of the vehicle	265

Index

Alphabetical index	274
--------------------------	-----

Technical data

Vehicle identification.....	268
Vehicle identification number	268
Number of drive motor.....	268
Overall parameters	269
Basic parameters	269
Power parameters	269
Tyre specifications	270
Wheel parameters	270
Braking parameters.....	271
Fluid parameters.....	271
Seat parameters.....	272



1

Operation

Key	16
Door lock.....	20
Vehicle windows	30
Sunroof	33
Engine hood	37
Vehicle charging.....	39
Seats	46
Rearview mirrors	52
Steering wheel	55
Light control	56
Wiper control	61
Air conditioning system	66
Mobile wireless charging.....	73
Interior equipment.....	75

Key

1

Operation

Vehicle equipment

Please note that this manual contains all the standard equipment, country-specific equipment and special equipment for this model series. Thus, some equipment or features described in this manual may not be installed onto your vehicle or are only available in some markets. For further configuration information, please refer to relevant sales information or consult with your distributor selling the vehicle to you.

About the key

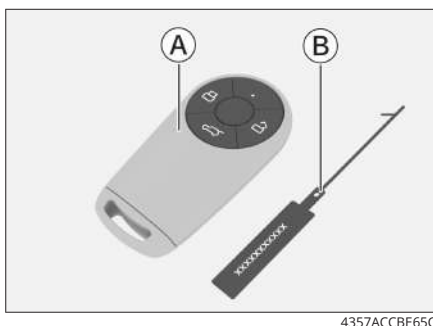

- Ⓐ Intelligent key
- Ⓑ Key number tag

i NOTICE

The communication equipment complies with NBTC standards or technical requirements.

i NOTICE

- › Please store the key number tag in a safe place. The key number tag contains a code necessary for the generation of replacement keys. You can

only request a new key from your service provider using this code.

- › When purchasing or transferring the vehicle, the key number tag should also be handed over to the purchaser.

Button introduction

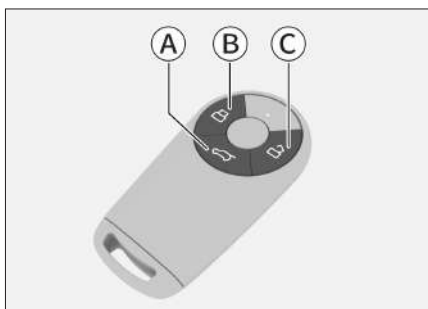

- Ⓐ Back door control button
- Ⓑ Lock button
- Ⓒ Unlock button

Lock button

Press the lock button to lock all the doors and back door. In this case, the turn signal lamp will flash once.

i NOTICE

When the door is locked, check whether all the doors and the back door are completely closed if the turn signal lamps do not flash.

Unlock button

Press the unlock button to unlock all the doors and back door. In this case, the turn signal lamp will flash twice.

i NOTICE

- › Unlock mode can be set via **【Vehicle Settings】** → **【In-Car】** → **【Body】** on the multimedia display screen.

If the unlock mode is set to **【Driver】**, when the unlock button is pressed, only the driver's door and back door will be unlocked. At this time, if the unlock button is pressed again, all vehicle doors will be unlocked.

If the unlock mode is set to **【Four Doors】**, when the unlock button is pressed, all vehicle doors will be unlocked.

- › If active welcome function is activated via **【Vehicle Settings】** → **【In-Car】** → **【Light】**, the turn signal will not flash.

Back door control button

Manual back door: press and hold the back door control button to unlock the back door and press the back door micro switch to open the back door within 30 seconds after unlock.

Electric back door: press and hold the back door control button to automatically open or close the back door.

Vehicle locating

When all doors and back door are locked, press lock button consecutive twice to turn on the locating function so that you can quickly find your vehicle in

a parking lot.

Press the lock button again during vehicle locating alarm to cancel the locating function.

i NOTICE

The vehicle locating mode can be set via the **【Vehicle Settings】** → **【In-Car】** → **【Light】** interface on the multimedia display screen.

! CAUTION

- › Modifying the transmission frequency of the intelligent key, boosting the key's transmission power (including by installing a frequency-power amplifier), connecting it to an external antenna, or using other transmitting antennas is forbidden.
- › It is strictly forbidden to use the key to interfere with various legal wireless communication services. Once such interference has been discovered, the use of the key should be halted and measures should be taken to prevent such interference before resuming use.
- › The use of the key may be affected by the interference of various wireless equipment, resulting in short-term failure of its function.

Battery replacement

! WARNING

The button battery is included in the

key.

- › The button battery included in the key is hazardous, whether the new or used battery should be away from children.
- › The button battery will cause serious or fatal damage within 2 hours or less than 2 hours, if it is swallowed or put into any part of the body.
- › If it is suspicious that the battery is swallowed or put into any part of the body, please seek medical help in time.
- › Please dispose of used batteries in accordance with local laws and regulations. Improper disposal of used batteries can pose a risk to the environment.

⚠ CAUTION

- › Both hands must be dry during the process, moisture may cause rusting of the battery.
- › Do not touch or move any other parts.
- › Make sure that the positive and negative terminals of the battery are in their proper positions.
- › When replacing the battery, be careful not to lose the parts.

1. Press the the release button of intelligent key to eject the mechanical key.

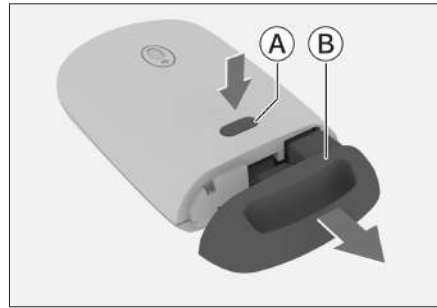

8CC014F2D82A

- Ⓐ Release button
- Ⓑ Mechanical key

2. Pry open the cover of the key using a flathead screwdriver, and remove the cover.

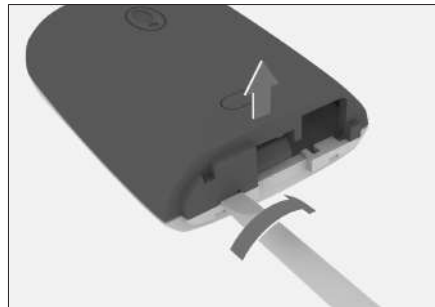

EF6BBD1493D6

3. Take out the battery and insert a new battery in its place.



B32C065C97FD



When installing the battery, make sure that the positive terminal of the battery is upward.

Battery model: CR2032

4. Install the rear key cover.

After installation, make sure that all the key buttons are working properly.

1

Operation

Door lock

1

Operation

Vehicle equipment

Please note that this manual contains all the standard equipment, country-specific equipment and special equipment for this model series. Thus, some equipment or features described in this manual may not be installed onto your vehicle or are only available in some markets. For further configuration information, please refer to relevant sales information or consult with your distributor selling the vehicle to you.

Locking and unlocking through the PEPS

If you carry the intelligent key with you, you can use the passive entry and passive start system (PEPS) to lock and unlock the vehicle door.

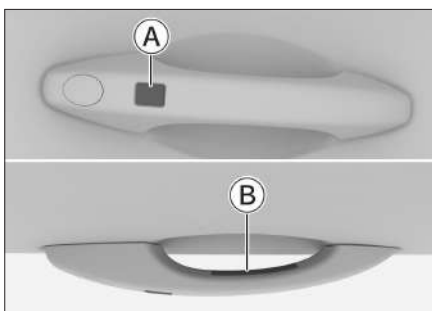

- Ⓐ Lock sensor
- Ⓑ Unlock sensor

Unlocking

Touch the unlock sensor to unlock all the doors and back door. In this case, the turn signal lamp will flash twice.

i NOTICE

› Unlock mode can be set 【Vehicle Settings】 → 【In-Car】 → 【Body】 on the multimedia display screen.

If the unlock mode is set to 【Driver】 , when the unlock button is pressed, only the driver's door and back door will be unlocked. At this time, if the unlock button is pressed again, all vehicle doors will be unlocked.

If the unlock mode is set to 【Four Doors】 , when the unlock button is pressed, all vehicle doors will be unlocked.

› If active welcome function is activated via 【Vehicle Settings】 → 【In-Car】 → 【Light】 , the turn signal will not flash.

Locking

Touch the lock sensor to lock all the doors and back door. In this case, the turn signal lamp will flash once.

i NOTICE

When the door is locked, check whether all the doors and the back door are completely closed if the turn signal lamps do not flash.

i NOTICE

When using intelligent key

› Only the doors with intelligent key detected can be operated.

- › Please do not lock and unlock the door at the same time.
- › If you wear gloves to operate the door handle, you may not be able to unlock or lock the door.
- › The radio waves of the PEPS is a little weak. When surrounded by other radio equipment or blocked by other barriers, the communication between the intelligent key and the vehicle may be affected and the system will not work properly.
- › Every time the door is successfully locked or unlocked, the smart entry system will stop working for 3 s.

Locking and unlocking with key buttons

See the key button for introduction.
(▷ Page 16)

Locking and unlocking with center control buttons

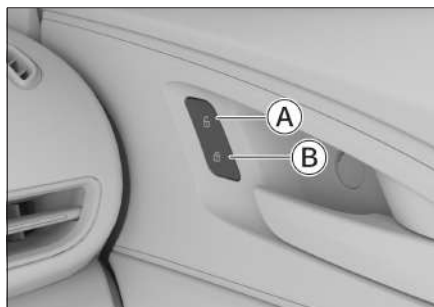

- Ⓐ Unlock button
- Ⓑ Lock button

The center control button is located on

the driver's door. Press the central control buttons to lock or unlock all doors.

Unlocking with the interior handle



When a vehicle door is locked, pulling the interior handle will unlock it. Pull the handle again to open the door.

i NOTICE

Make sure that the child lock is not active when opening the rear doors with the inner handle; otherwise, the rear doors cannot be opened.

Locking and unlocking with the mechanical key

1. Pull out the door handle and push the cover from the inside to remove it.



39DD566AECE

2. Insert the mechanical key into the door lock hole, turn the key to lock or unlock the door.

For how to take out the mechanical key, please refer to *Replacing the Battery for Key*. (▷ Page 17)

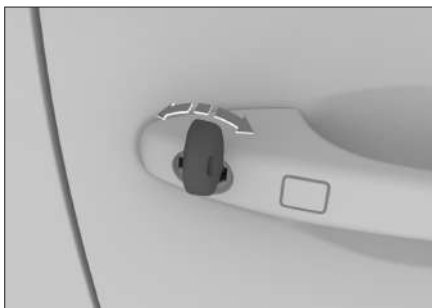

08F60885455F

⚠ CAUTION

After the door is unlocked, the mechanical key must be pulled out before opening the driver side door.

i NOTICE

When the mechanical key is used to unlock the door, the vehicle anti-theft alarm may be triggered. (▷ Page 225)

Locking during emergencies



C58BC19DE96E

The front passenger's door and the rear door are equipped with the door emergency locking device.

Insert the mechanical key into the emergency lock hole as shown in the figure, move it to the lowest position, and then close the door to lock it.

i NOTICE

If you need to use this method to lock the door, it means that the electric door lock system has malfunctioned. In this case, please go to the service provider for maintenance as soon as possible.

Back door

Manual back door

Opening

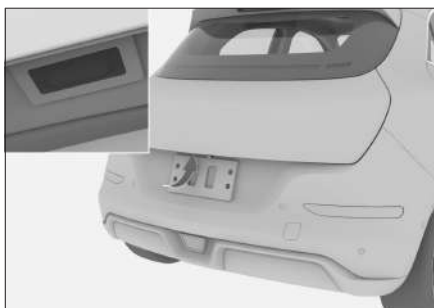

50CCF69097B9

- › When you carry the intelligent key with you, press and pull up the back door microswitch.
- › When the power supply is in the LOCK position, press and hold the back door control button on the key, and press and pull up the back door microswitch within 30 seconds.
- › When the driver's door is unlocked, press and pull up the back door microswitch.

Closing



57BC139F67D1

1. Pull the back door assist grip and

release the assist grip before the back door is fully closed.

2. Press the back door from outside the vehicle to make sure that it is fully closed.

! WARNING

- › When closing the back door manually, be sure to press the back door outside the car to ensure it completely closed. If the back door is closed directly by the auxiliary handle, it is easy to pinch the hand and cause serious personal injury.
- › It is forbidden to drive the vehicle with the back door open.
- › No passengers are allowed in the baggage area.
- › If there are other people near the back door during the opening or closing of the back door, make sure no harm will be caused to other people.
- › When closing the back door, please pay attention to the carry-on bag or tie not to be caught by the back door.
- › Do not let children operate the back door; otherwise, it may cause accidental injury.

! CAUTION

- › Do not use too much force when opening the back door; otherwise, it could damage the back door.
- › Be careful when opening the back

door in strong wind, as the back door may open too wide, resulting in deformation of the back door.

- › If the back door is frozen or covered with snow and ice, do not open the back door by force. Open the back door after the temperature inside the car rises by using the air conditioning and heating functions.

When the back door must be opened in an emergency, warm water should be poured to melt the ice. Try to open the back door after the icing position is loose.

- › Do not install or paste any ornaments on the back door support rod.
- › Do not pull the back door laterally; otherwise, it will lead to bending and deformation of the support rod.

i NOTICE

- › When the ambient temperature is lower than 0°C, the back door support rod may not support the back door automatically. In this case, the back door can be lifted manually to be opened.
- › Do not install heavy accessories on the back door; otherwise, it may cause the support rod to fail to support the back door smoothly.
- › The telescopic movement of the back door support rod needs oil-assisted lubrication, so it is normal that there may be oil stains near the dust cover

of the support rod.

Electric sensory back door

Opening



50C3AF891D65

- › When you carry the intelligent key with you, press the back door micro-switch.
- › With the power supply switch in the LOCK mode, press and hold the back door control button on the key.
- › When the driver's door is unlocked, press the back door micro-switch.
- › When the driver's door is unlocked, press the back door control switches near the steering wheel.



04091290D786

- › If you carry the intelligent key with you, kick in the detection area under the rear bumper.

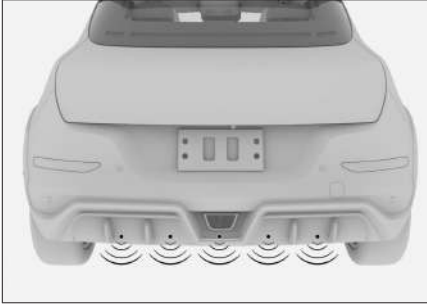

F2F6D94EB494

Closing

- › Press the close button on the back door.



6D9D1CF7CF6D

- › Press the back door button near the steering wheel.
- › With the power supply switch in the LOCK mode, press and hold the back door control button on the key.
- › Make a kicking motion in the detection zone under the rear bumper.

Open or close back door induction opening function through multimedia display screen via **【Vehicle Settings】** → **【In-Car】** → **【Body】** .

i NOTICE

- › When making the kicking motion, your foot should be close to the rear bumper and your toes should be at least 10 cm in under the bumper but not touching the bumper. Then quickly pull your foot back. Otherwise, the back will not open or close.
- › If you move your foot left and right under the bumper, the back door may not open or close.
- › If you keep your foot in the kicked-out position under the bumper for too long, or if you kick too slowly, the back door will not open or close. When this happens, please repeat the kicking motion with a faster speed.
- › If you have kicked several times and the back door still has not opened, wait a moment, then try again.
- › You can also close the back door when you do not have the smart key with you by making a similar kicking motion in the detection zone under the rear bumper.

! CAUTION

To prevent the back door from accidentally opening, be sure the smart key is not in the back door's detection zone when washing the vehicle or using a high pressure washer.

⚠ WARNING

- › Be sure you are standing firmly on the ground when making the kicking motion, and maintain enough space between yourself and the back of the vehicle. Otherwise, you may lose your balance (for example, on an icy surface).

- › To prevent the back door from accidentally opening or closing, do not carry the smart key with you in the following situations:

When putting something down or picking up something up behind the vehicle.

When polishing or doing other maintenance on the back of the vehicle.

⚠ WARNING

- › In certain situations you need to manually close the back door, be sure to push on it from outside the vehicle to make sure it closes all the way.
Using the handle to close the back door can pinch your hand and result in serious injury.
- › Do not drive the vehicle when the back door open.
- › No one should ride in the luggage area.
- › Be careful not to injury anyone near the back door when opening or closing.

- › When closing the back door, be careful not to pinch any object, such as a bag or necktie.
- › Do not allow children to operate the back door, otherwise it can result in accidental injury.

⚠ CAUTION

- › In certain situations, if you need to manually open or close the back door, move it slowly and smoothly. Do not exert sudden force to compel the back door to open or close more quickly.
- › Always be careful when opening the back door in strong wind. The strong wind can cause the back door to open too far and deform.
- › If the back door is frozen or covered in snow and ice, do not force it open. First use the heating function to warm the interior of the vehicle, then open the back door.
If you must open the back door in an emergency, pour warm water on it to melt the ice. Once the frozen spots loosen, try opening.
- › Do not install or glue any ornaments onto the back door support rod.
- › Do not pull sideways on the back door, Doing so can bend and deform the support rod.
- › While the back door is opening or closing, do not force it in the opposite direction. Doing so can cause

injury and can damage the back door.

i NOTICE

- › When the ambient temperature is lower than 0°C, the back door support rod may not be able to automatically push the back door up. In such cases, you can manually lift the back door to open it.
- › Do not install heavy accessories on the back door. This can prevent the support rod from smoothly pushing the back door up.

Anti-pinch function

If the back door hits an obstacle while automatically closing, it will automatically return to the open position.

Setting the opening angle

If you need to set the opening angle of the back door, use the following steps:

1. Open the back door, adjust it to the height that you want and hold it there.
2. Press and hold the close button on the back door until the vehicle gives a light signal. Then the opening angle of the back door is set successfully.

Emergency unlock

1. Pry down the emergency cover plate at the bottom of inner side of the back door using a flathead screwdriver.

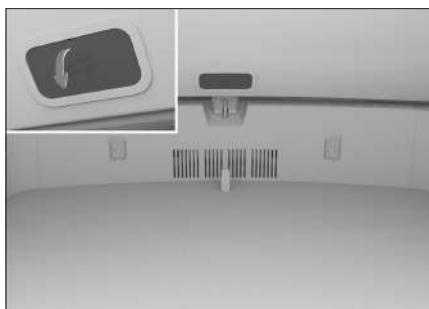

6902A399A857

i NOTICE

Please wrap the head of the screwdriver with a cloth before removal.

2. Toggle the emergency opening device counter-clockwise in the direction shown in the figure with a flat-head screwdriver to open the back door.

Manual back door

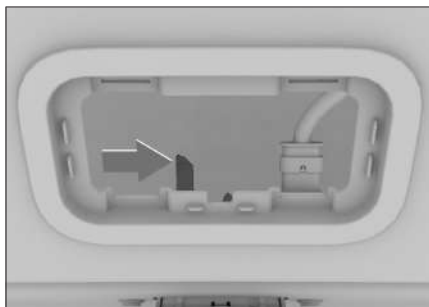

1FA59C1D4C17

1

Operation

Electric sensitive back door



F57ED31F5376

i NOTICE

In some cases, if you need to directly move the emergency opening device with your hands, please try not to touch the sheet metal parts to avoid cutting your hands.

Child safety lock

If there are child passengers within the vehicle, we recommend that they seat in the comparatively safer rear seats where child safety locks are available with the corresponding vehicle doors to prevent inadvertent opening of the vehicle doors.



DC348560039

Move the lever in the direction of the arrow to open the child safety lock. Move the lever in the opposite direction to close the child safety lock.

⚠ WARNING

Only the rear doors are equipped with child locks. If a child is alone in the rear row, please activate the child locks on both rear doors at the same time to avoid accidents caused by accidental opening of the doors.

i NOTICE

After the child lock is activated, the door can only be opened by pulling the door handle from outside the car.

Parking unlock

When the vehicle is fully stopped but in power on status (the READY indicator is on), and the driver unfasten the seat-belt, all the doors and back door will be unlocked automatically.

This function can be turned on or turned off via the **【Vehicle Settings】** → **【In-Car】** → **【Body】** on the multimedia display screen.

Auto driving lock

All the doors and back door are locked automatically when the vehicle speed exceeds 15 km/h.

The vehicle speed of auto driving can be set via **【Speed locking】** on **【Vehicle Settings】** → **【In-Car】** → **【Body】**

multimedia display screen.

i NOTICE

Make sure that all doors and back doors are completely closed before driving.

Automatic resetting function

When all the doors and back door are locked, touch the unlock sensor on the door handle or press the unlock button on the key to successfully unlock the doors. If the state of all doors and back door do not change within 30 seconds, all the doors and back door will be locked automatically .

Automatic unlock upon collision

With power switch at ON position, if the system detects collision, all doors will unlock automatically.

Vehicle windows

1

Operation

Vehicle equipment

Please note that this manual contains all the standard equipment, country-specific equipment and special equipment for this model series. Thus, some equipment or features described in this manual may not be installed onto your vehicle or are only available in some markets. For further configuration information, please refer to relevant sales information or consult with your distributor selling the vehicle to you.

Window switch

Driver's window switch

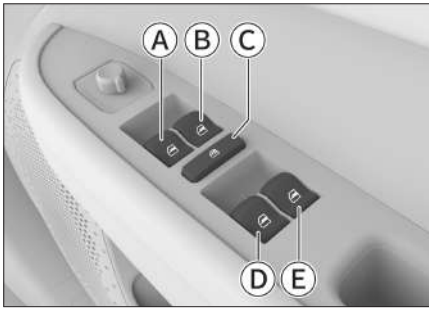

BF1919CBF582

- Ⓐ Front passenger's side window switch
- Ⓑ Driver's window switch
- Ⓒ Window lock switch
- Ⓓ Rear left window switch (L)
- Ⓔ Rear right window switch (R)

Manual operation

To open or close the vehicle windows, press or pull up and hold the corresponding switch until the vehicle window reaches the required position.

⚠ WARNING

Before closing the vehicle window, make sure that all occupants' heads and hands have left the vehicle window space, otherwise, it could cause an extremely serious injury.

One-push raising or lowering

Press the vehicle window switch until it exceeds the pressure point, and then release the switch. At this time, the vehicle window will be automatically opened completely. If you want to stop it half-way, you can just pull up the switch.

Pull up the vehicle window switch until it exceeds the pressure point and then release the switch. At this time, the vehicle window will be automatically closed completely. If you want to stop it half-way, you can just press the switch.

ⓘ NOTICE

In some models, only the driver's window is equipped with the one-button vehicle window opening and closing function.

⚠ CAUTION

In a low temperature environment, ice may freeze between the vehicle window glass and the vehicle window frame, and the glass may fail in ascending and descending due to this reason. Do not repeat the operation by force at this time to avoid damage to

the lifting mechanism. After the temperature inside the vehicle rises and the ice on the glass thaws, the glass will ascend and descend properly.

Vehicle window locking

When the vehicle window locking switch is pressed, the corresponding vehicle window cannot be controlled by the vehicle window switch on the rear door.

Pressing the vehicle window locking switch again will recover the function of the rear vehicle window switch.

WARNING

When there are children in the vehicle, it is recommended that they should sit in the relatively safe rear seats and the vehicle window locking function should be enabled.

Passenger's side window switches

On the armrest of the passenger's side door, there is a window switch which can be used to open or close the corresponding window.

Thermal protection function

Thermal protection may be triggered to protect the glass lifter motor after repeated operation of the window switch. In this case, the window switch will temporarily fail to work and the window lifter will not be controlled. The window

switch automatically returns to normal after the lifter motor cools down.

Anti-pinch function

If the vehicle window detects a foreign object between the window frame and the vehicle window during its automatic closing, it will stop closing and automatically descend a certain distance.

NOTICE

Depending on different vehicle configuration, this function may not be provided for your models. Please refer to actual vehicle.

WARNING

- › Never test the anti-pinch function with any part of your body.
- › At the moment when the window is completely closed, the anti-pinch function will not work if something gets stuck.

NOTICE

Under severe conditions, such as low temperature and severe bumping, the anti-pinch function may be triggered in the process of window glass ascending, and the window cannot be closed smoothly. At this time, please pull up the window switch till it exceeds the pressure point, to close the window.

Delay function

When the vehicle power supply changes

from ON to LOCK mode, you can still operate the windows within 42 seconds.

If you open any door in 42 seconds, windows delay function will be off.

Speedy closing

With the the power supply in LOCK mode and all the doors and back door closed, press and hold the lock button on the key or the lock sensor on the door handle to automatically close the window.

Press the key unlock or lock button to pause the lift during automatic window rise.

i NOTICE

If an obstacle between the vehicle window glass and the vehicle window frame is found during the automatic ascending of the vehicle window glass, the anti-pinch function will be triggered, and the driver must confirm that the vehicle windows are completely closed before leaving.

Initialization

When errors occur in one-push raising or lowering function, you can reset it through the following operations:

1. Switch the power supply to ON mode.
2. Pull up the window switches equipped with one-push raising or lowering function beyond the pressure point until the window is completely

closed and then hold for about 3 seconds.

3. Operate the window switch again so that the window goes through the one-push raising and one-push lowering.

i NOTICE

When the one-push raising or lowering function is disordered or every time the battery is disconnected and re-energized, the windows with one-push function need to be initialized.

Vehicle equipment

Please note that this manual contains all the standard equipment, country-specific equipment and special equipment for this model series. Thus, some equipment or features described in this manual may not be installed onto your vehicle or are only available in some markets. For further configuration information, please refer to relevant sales information or consult with your distributor selling the vehicle to you.

Opening and closing the sunroof



566387D857AC

Manual operation

- › Press upwards and hold the sunroof button to tilt the sunroof to the maximum angle and stop; press and hold the button again to gradually open the sunroof.
- › Press downwards and hold the sunroof button to gradually close the sunroof.
- › To make the sunroof stop in the midway, release the button.

Automatic operation

- › Press upwards and release the sunroof button to tilt the sunroof automatically to the maximum angle and stop; press and release the button again to automatically open the sunroof to the proper position; press and release the button again to automatically and completely open the sunroof.
- › Push downwards and release the sunroof button to automatically close the sunroof.
- › To make the sunroof stop in the midway, press the button again.

! WARNING

- › Do not put your hands or heads out of the sunroof when the vehicle is moving. If objects are outside the vehicle when an emergency braking requirement, it may cause serious personal injury or even death.
- › When closing the sunroof, be careful not to clip other people's hands, heads and neck etc. to prevent serious personal injury.
- › Do not allow children to operate the sunroof.

Opening and closing the sunshade



7411604390DE

Manual operation

- › Press and hold the sunshade button upward to gradually open the sunshade.
- › Press and hold the sunshade button downward to gradually close the sunshade.
- › To make the sunshade stop in the mid-way, release the button.

Automatic operation

- › Press the sunshade button upward and then release it, and the sunshade will open automatically.
- › Press the sunshade button downward and then release it, and the sunshade will close automatically.
- › To make the sunshade stop in the mid-way, press the button again.

⚠ WARNING

- › When closing the sunshade, be careful not to clip other people's hands, heads and neck etc. to prevent

serious personal injury.

- › Do not allow children to operate the sunshade.

⚠ CAUTION

Do not squeeze the sunroof sunshade with force to prevent the sunshade from falling off or being damaged. When parking a vehicle for a long time, it is suggested to close the sunroof sunshade to prevent the inside decoration from being damaged due to the inside high temperature if it is exposed to the sun for a long time.

Linkage function

When the sunshade is in the close position, in the process of opening the sunroof, the system will automatically adjust the opening degree of the sunshade according to the opening of the sunroof.

Anti-pinch function

If the sunroof or sunshade encounters an obstruction during the automatic closing, it will stop closing and return to a certain distance.

⚠ WARNING

Do not attempt to use any part of your body to test the anti-pinch function. At the moment when the sunroof and sunshade are completely closed, the anti-pinch function will not work if any object is stuck.

Delay function

Within a few seconds after turning the power supply to LOCK mode, the sunroof and sunshade still can be operated.

Speedy closing

With the the power supply in LOCK mode and all the doors and back door closed, press and hold the lock button on the key or the lock sensor on the door handle to automatically close the sunroof.

Automatic sunroof closing

- › With the the power supply in LOCK mode, if the rainfall and light sensor perceives rain and snow, the sunroof will be closed automatically.

i NOTICE

In case of a little rain, the sunroof may not be closed automatically. Therefore it is suggested that you ensure the sunroof is completely closed before leaving the vehicle.

- › The sunroof will close automatically if the vehicle speed exceeds 120 km/h in the driving.

Initialization

If the system is in disorder, it can be recovered through the following operations:

1. Close the sunroof and sunshade completely, press and hold the sunroof button until the sunroof and the

sunshade jitter and then release the button.

2. Press and hold the sunroof button again within 5 seconds until the sunroof and sunshade complete the movement from being open to full closed, then release the button, and the initialization is complete.

If the sunroof rebounds during the closing process, it can be forced to initialize through the following operations:

1. When the sunroof rebounds, press and hold the sunroof button immediately, and continue to keep pressing and holding the sunroof button after the rebound is over, until the sunroof is completely closed and jitters once, and then release the button.
2. Press and hold the sunroof button again within 5 seconds until the sunroof completes the movement from being open to fully closed, then release the button, and the sunroof initialization is completed.

If the sunshade rebounds during the closing process, it can be forced to initialize through the following operations:

1. First close the sunroof completely.
2. Then close the sunshade, and if it rebounds, immediately press and hold the sunshade button. After the rebound, continue to keep pressing and holding the sunshade button until the sunshade is completely closed and jitters once, and then release the

1

Operation

button.

3. Press and hold the sunshade button again within 5 seconds until the sunshade completes the movement from being open to fully closed, then release the button, and the sunshade initialization is completed.

Vehicle equipment

Please note that this manual contains all the standard equipment, country-specific equipment and special equipment for this model series. Thus, some equipment or features described in this manual may not be installed onto your vehicle or are only available in some markets. For further configuration information, please refer to relevant sales information or consult with your distributor selling the vehicle to you.

Opening

1. Pull the hood handle located below the instrument panel. The hood will pop open gently.



2. Lift the engine hood slightly. Put your hand into the gap and pull the latch of engine hood in the direction of the arrow to open the engine hood.



3. Take the strut out of the bracket and insert the front end into the recess in the hood to pop it up.

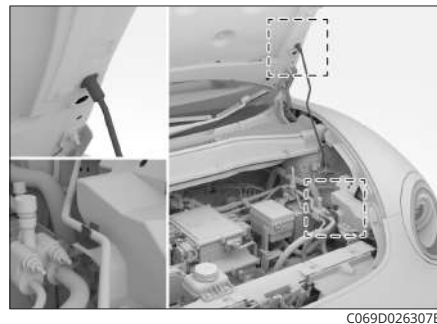

Closing

1. Lift the hood up slightly.
2. Remove the strut and return the hood to its original position.
3. Release the engine hood at a height of about 30cm from the engine hood lock and allow the hood to descend without aid.

4. Make sure the engine hood is fully locked.

⚠ WARNING

Make sure that the engine hood is fully closed and locked before driving. Otherwise it may open unexpectedly during vehicle running that leads to accident.

⚠ CAUTION

- › Before closing the engine hood, make sure that there is no debris left inside the engine compartment.

1

Operation

Vehicle equipment

Please note that this manual contains all the standard equipment, country-specific equipment and special equipment for this model series. Thus, some equipment or features described in this manual may not be installed onto your vehicle or are only available in some markets. For further configuration information, please refer to relevant sales information or consult with your distributor selling the vehicle to you.

Charging mode

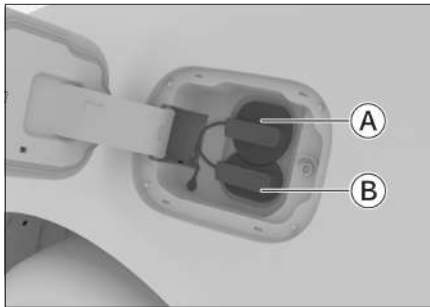

- › (A): Ordinary charging port (AC charging)
- › (A+B): Fast charging port (DC charging)

The time required for charging varies depending on the battery's state of charge, service time, temperature, and power connection status. Under normal temperatures, the charging time is the shortest.

⚠ WARNING

- › If medical device such as cardiac defibrillator is implanted in the body,

you must confirm with the device manufacturer whether the normal operation of medical device will be affected before charging.

- › It is not recommended to occupy the vehicle during the charging. If the people implanted with medical device such as cardiac defibrillator are affected, they are forbidden to enter the vehicle and baggage area.
- › Before charging, make sure that there is no water or other foreign objects in the charging port of the vehicle, socket, power supply device, and charging cable, and check whether the metal terminals are rusted or corroded, otherwise charging is prohibited. Because the abnormal terminal connection may cause short circuit or electric shock, thus threatening life safety.
- › The charging device shall be placed out of the reach of children. And it is forbidden for children and other people in need of care to perform charging operations.
- › In case of severe weather such as rain and snow, charging the vehicle in the open air is prohibited. After charging, make sure that there are no water stains on your hands or the charging port before disconnecting the charging device to avoid the risk of electric shock.

⚠ CAUTION

- › It is forbidden to use fast charging and normal charging at the same time.
- › It is forbidden to use power generation equipment with unstable voltage to charge; otherwise it will cause a vehicle accident.
- › It is recommended to charge the vehicle at a standstill and the N gear is engaged.
- › During the charging, if you find peculiar smell or smoke, you must stop charging immediately, evacuate the crowd, stay away from the electric vehicle, and contact the service provider for inspection.
- › During the charging, the cooling fan in the engine compartment may suddenly start to run. Take care to avoid contact the fan with hands, feet, clothes, decorations, etc.
- › Please disconnect high-power electrical equipment during charging to maintain charging efficiency.
- › It is recommended to charge on a stable power grid line and use the designated charging facility as far as possible. The following conditions may cause the vehicle to fail to charge normally:
The power grid fluctuates greatly, and the amplitude and frequency exceed the value specified by the national standard.

The charging facilities in public places lack effective supervision and maintenance, for example, there are foreign objects or abnormal damages in the charging plugs.

As public infrastructure, some charging piles have not been subject to matching verification, and the charging plugs of different manufacturers are not well matched with the vehicle sockets.

- › For charging piles that require card swiping or code scanning, please complete the card swiping or code scanning within 5 minutes after connecting the charging gun, otherwise, please unplug and re-plug the charging gun before operating.

Charging cable

The charging cable is located in the luggage area.

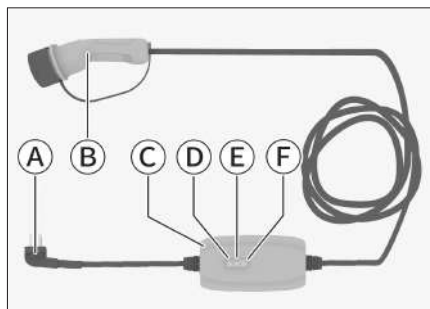

- Ⓐ Connector
- Ⓑ Charging gun
- Ⓒ Control box
- Ⓓ Power indicator

- Ⓔ Failure indicator
- Ⓕ Charging indicator

i NOTICE

- › The charging cable connector may vary from the voltage and target markets, so the figure is only for reference.
- › The on-board charging cable is only suitable for ordinary charging.

⚠ CAUTION

- › Before charging, make sure that the three-hole plug of the charging cable power supply is properly inserted into the socket. Otherwise, there is a risk of electric shock or ablation of the charging cable.
- › Charging is prohibited when the charging cable is damaged.
- › It is recommended to use the original charging cable. If other charging cables are used, it may cause the power battery to fail to charge normally and malfunctions.
- › It is forbidden to disassemble, repair, or modify charging equipment (charging cable, charging port, etc.), otherwise it may cause charging faults and fire.
- › Before starting the vehicle, you must confirm that the charging gun has been completely pulled out; otherwise it may cause damage to the charging device and the vehicle.

- › In order to prevent damage to the charging cable, please pay attention to the following points:

It is forbidden to forcibly stretch, twist, bend, or step on the cable components.

The charging cable must not be placed near objects with high temperature such as heaters.

It is forbidden to store or use the charging cable in a place with a temperature higher than 85°C.

Avoid direct sunlight or usage in humid places.

Ordinary charging

1. Turn the power switch to LOCK mode.

⚠ CAUTION

It is recommended to turn vehicles power switch to LOCK mode when charging. It is not recommended to charge in ON mode.

2. Press one end of the charging port cover to pop open the charging port cover slightly.

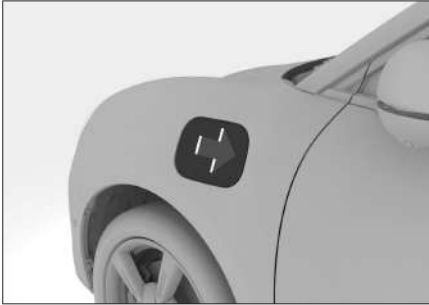

A4850A167008

3. Take out the charging cable and insert the plug into the socket.

⚠ WARNING

- › A circuit breaker must be installed on the power supply side, and you must use a socket that matches the charging cable supplied with the vehicle.
- › For the charging circuit, avoid an excess of line connectors and adapters, and avoid using too long cables. Prevent the abnormal heating and electric leakage from causing fire or electric shock.

4. Remove the dust cap of the ordinary charging port and the protection cover on the head of the charging gun, and insert the charging gun into the ordinary charging port.

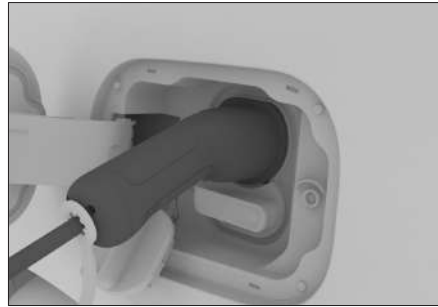

BE6A4C377FEC

After connecting, the charging gun will be automatically locked. At this time, the connection indicator on the control box and the charging indicator on the instrument will be illuminated.

⚠ CAUTION

Do not force the charger plug and charging port to connect if one or both have a foreign object inside. Please contact the service provider immediately. Forcing them to connect will damage the charger and vehicle. Use a blow dryer to defrost a frozen charging port. Using force to insert the charger plug when the port is frozen will cause a failure.



i NOTICE

- › If the charging mode is set to charging now, the vehicle can charge after

connecting to the power supply.

You can be activated or deactivated charging now through 【Energy consumption assistant】 interface on the multimedia display screen.

- › Due to different markets, some market models do not have 【Charge immediately】 switch.

5. When charging, the indicator  and indicator  on the instrument are illuminated, the power indicator on the control box and the connection indicator are normally on, and the charging indicator flashes. When the charging indicator on the control box is normally on, it means that the charging is finished.

Through 【Set the upper limit of charging】 switch on 【Energy consumption assistant】 interface on multimedia display screen, the charging percentage can be set, and the charging will automatically stop when the charging reaches the set limit. If normal charging cannot be achieved, please refer to the indicator description on the charging cable control box.

If there is a fault, please contact the service provider as soon as possible.

6. When charging is finished, pull out the charging gun once the driver's door is unlocked. Then unplug the plug from the power source.

NOTICE

If the charging gun cannot be pulled out, you can use the following methods to unlock the charging gun again.

- › Lock the door then unlock the door again.
- › Emergency unlock method.

7. Close the protection cover of charging gun and the dust cap of the ordinary charging port, then close the charging port cover and put the charging cable back to the original position.

CAUTION

- › The power displayed on the instrument panel may have differences if using the vehicle first time or using vehicle after leaving the vehicle parked for a long time. It is recommended to fully charge the vehicle before using.
- › Do not charge when the power is too low. Regularly charging can optimize the power supply work state. Please fully charge the vehicle once a week to ensure the accuracy of estimated power.
- › When the vehicle exits REDAY mode due to low power battery, the vehicle

may not be charged after the charging gun is inserted. In this case, you need to switch the power mode to ON, then to OFF, and then start to charge. If it still can not be charged, please contact the service provider.

Emergency unlock

1. When unlocking fails in normal charging mode, open the engine hood, find the emergency unlocking cable at the back of the normal charging port, and pull the emergency unlocking cable as indicated by the arrow.

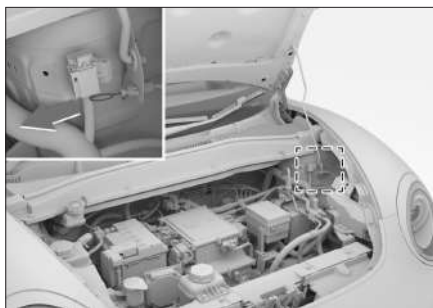

E78492AD5D38

2. Then pull out the charging plug.

Fast charging

Before fast charging, please read the relevant operating instructions on the charging device carefully, and strictly comply with the relevant regulations of the charging station.

1. Switch the power switch to LOCK mode.



⚠ CAUTION

It is recommended to switch vehicles power supply to LOCK mode when charging. It is not recommended to charge in ON mode.

2. Press one end of the charging port cover to pop open the charging port cover slightly.



A4850A167008

3. Remove the dust cap of the fast charging port, and then strictly follow the operating instructions on the charging device.
4. After connecting, the charging gun will be automatically locked. At this time, confirm that the indicator  and the indicator  on the instrument are illuminated.

⚠ CAUTION

- › Frequent fast charging will shorten the battery service life, so normal charging is recommended.
- › When using the fast charging port for

charging, make sure that the charging gun is connected in place. Otherwise, the lithium battery cannot be charged or the charging equipment may be damaged.

5. After charging is finished, cover the dust cap, and then close the charging port cover.

1

Operation

Seats

1

Operation

Vehicle equipment

Please note that this manual contains all the standard equipment, country-specific equipment and special equipment for this model series. Thus, some equipment or features described in this manual may not be installed onto your vehicle or are only available in some markets. For further configuration information, please refer to relevant sales information or consult with your distributor selling the vehicle to you.

Headrest

Headrest adjustment

When the headrest center height is aligned with the top of the driver's or passenger's ears, it is at maximum efficiency.

⚠ WARNING

It is forbidden to adjust the headrest during driving.



92E3276581F5

- › To raise the headrest, directly pull it upwards to the desired position.
- › To lower the headrest, push the

headrest down while pressing and holding the headrest adjust button until the headrest reaches the desired position.

i NOTICE

The lowest position of the headrest is not its use position. The headrest must be ascended to the locked position before use.

i NOTICE

After adjusting the headrest, press the headrest to make sure it is locked firmly.

Remove headrest

To remove the headrest, press and hold the headrest adjust button, and remove the headrest.

If necessary, adjust the seat backrest so that the headrest can be removed.

⚠ WARNING

It is forbidden to drive without the headrest. Otherwise, if there is a collision, your neck will be greatly impacted, resulting in serious injury and even death.

Front seats

Manual seat

⚠ WARNING

- › Never adjust the seat when driving.
- › Before driving, please adjust the seat

to a position convenient for correct driving. Otherwise, it may easily cause incorrect operations and may even lead to accidents, and the safety efficiency of seat belts, airbags, headrest and other devices cannot be effectively used.

- › Do not tilt the seat backrest excessively because your body may slip out of the safety belt during collision. The seat belts can provide the best protection only when you sit up straight and lean against the seat backrest.

Forwards/backwards adjustment of the seats



EB5BCC28CBFA

Pull up the seat position adjustment lever, slide the seat back and forth to the required position, and release the adjustment lever.

i NOTICE

After adjusting the seat, make sure that it is locked firmly.

Backrest inclination angle adjustment



F83BC8855D90

Move your body tightly against the backrest, pull up the inclination adjustment handle of the seat backrest, lean back to adjust the backrest to the required angle, and release the adjustment handle.

! CAUTION

Please ascend the backrest inclination adjustment handle completely before adjusting the backrest. Otherwise, the seat may be subject to mechanical failures.

Seat height adjustment



B24C415AA111

- › To ascend the seat, repeatedly pull up the seat height adjustment handle.

- › To descend the seat, repeatedly press down the seat height adjustment handle.

i NOTICE

Some functions only apply to the driver's seat.

Power seat

! WARNING

- › Never adjust the seat when driving.
- › Before driving, please adjust the seat to a position convenient for correct driving. Otherwise, it may easily cause incorrect operations and may even lead to accidents, and the safety efficiency of seat belts, airbags, headrest and other devices cannot be effectively used.
- › Do not tilt the seat backrest excessively because your body may slip out of the safety belt during collision. The seat belts can provide the best protection only when you sit up straight and lean against the seat backrest.

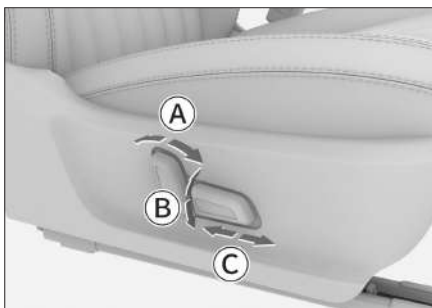

A20A29822FDD

- Ⓐ Backrest inclination angle adjustment
- Ⓑ Seat height adjustment
- Ⓒ Forwards/backwards adjustment of the seats

i NOTICE

Some functions only apply to the driver's seat.

Welcome function of driver's seat

Power on the vehicle, and the welcome function of the driver's seat can be activated and deactivated through the interface **【Vehicle Settings】** → **【In-Car】** → **【Body】** interface on the multimedia display screen.

When the welcome function is turned on:

- › The driver's seat will retreat a short distance when the driver unfasten the seatbelt and open the driver's side door, so as to help the driver leave the vehicle.
- › When the driver seats in the driver's seat and close the driver's door, the driver's seat will restore to the position before backing.

i NOTICE

- › If you operate the seat adjustment switch when the driver's seat is backing up or restoring to the original position, the seat will carry out the instruction to adjust the seat adjustment switch.

- › If any adjustment is set for the seat after the driver's seat retreats a short distance automatically, the seat will not restore to the original position.

Driver's seat memory

Power on the vehicle, and the driver's seat memory in non-personalized registration can be activated and deactivated through **【Vehicle Settings】** → **【In-Car】** → **【Body】** interface on the multimedia display screen.

With activating this function, the current position of the driver's seat can be stored into the memory button. Touch the memory button for a long time, the system can memorize the current position of the driver's seat and remind that the seat position is stored successfully. Touch the memory button, the stored position of the driver's seat of this button can be shown.

i NOTICE

- › When using this function, you should ensure that the ID number of **【Personal Center】** is not registered, otherwise, the function cannot be used.
- › After registering the ID number of **【Personal Center】**, the system will callout the saved position of the personalized setting.

Custom setup for seats

Register personal account through **【Personal center】** on the multimedia host,

the function **【Custom setup】** → **【Personal setup of seat, rearview mirror】** can be activated or deactivated. After activating this function, if the vehicle is in on mode, the account will memorize the current position of driver's seat and position of rearview.

When registering the account next time, the position of custom setup will be popped out automatically.

i NOTICE

Due to different markets, some market models do not have this function.

Front seat massage ventilated function

When the vehicle switched to ON mode, the related functions of front seat can be set through multimedia display screen on the **【Vehicle settings】** → **【In-Car】** → **【Seat setting】** interface.

Massage seat

Touch the seat massage button on the interface repeatedly to set the gear of massage function or deactivate massage function.

Massage function will stop automatically after it operates for 15 minutes.

Seat ventilation function

Touch the seat icon (🪑 or 🪑) at the bottom of the air-conditioning setting interface to set the related seat ventilation functions.

Rear seats

Rear seat adjustment

Backrest folding

After the rear seat backrest is folded, larger storage space can be obtained.

The left or right part of the backrest can be folded separately.



BFCE9663E38F

The unlocked backrest can be folded forwards by pulling up the unlocking handle at the top of the backrest.

i NOTICE

- › Before folding, adjust the headrest to an appropriate position to avoid interference with the seat cushion or front seat.
- › Put the seat belt back in place to avoid interference when folding the backrest.

⚠ CAUTION

- › Remove all objects from the seat before folding the seat backrest.
- › When the backrest is folded, do not put heavy objects on it.

⚠ WARNING

- › It is forbidden to adjust or fold the seat when driving the vehicle.
- › No one is allowed to sit on a folded

seat backrest or in the luggage area.

- › Children are prohibited from entering the luggage area.

Backrest restoring

1. Adjust the seat belt to avoid it being stuck under the seat during backrest recovery.
2. Pull up the backrest and return it to the original position for use. Shake the seat backrest slightly back and forth to ensure that it is locked in place.

1

Operation

Rearview mirrors

Vehicle equipment

Please note that this manual contains all the standard equipment, country-specific equipment and special equipment for this model series. Thus, some equipment or features described in this manual may not be installed onto your vehicle or are only available in some markets. For further configuration information, please refer to relevant sales information or consult with your distributor selling the vehicle to you.

Interior rearview mirror Manual anti-glare inside rearview mirror

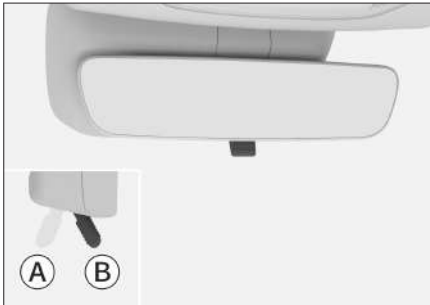

F25390E0F820

- Ⓐ Normal position
- Ⓑ Anti-glare position

Toggle the handle to the rear of the vehicle to switch to the anti-glare position. The reflection of the headlamp of vehicle behind can be reduced at that position.

Side mirrors

Outside rearview mirror adjustment

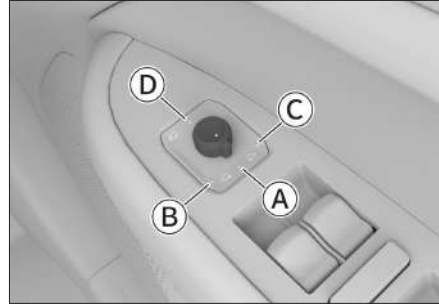

8619F9080B1E

- Ⓐ Original position
- Ⓑ Select the outside rearview mirror, left
- Ⓒ Select the outside rearview mirror, right
- Ⓓ Fold outside rearview mirror

Mirror adjustment

1. Rotate the outside rearview mirror adjustment knob to select the left or right outside rearview mirror.
2. Turn the knob forward or backward, to the left or the right, and you can adjust the left or right outside rearview mirror lens.
3. After adjustment, reset the outside rearview mirror adjustment knob to the initial position.

⚠ WARNING

Do not adjust the rearview mirrors while driving. Otherwise, errors in control can lead to accidents and serious

injuries or death.

Electric folding

Turn the adjustment knob to the  outside rearview mirror folding position and the outside rearview mirror will be folded automatically.

Turn the adjustment knob to a different position and the outside rearview mirror will deploy automatically.

Manual folding

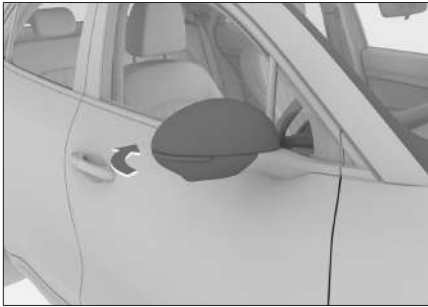

79367204825A

Move the outside rearview mirror in the direction indicated by the arrow and it can be folded.

It is mandatory to have the outside rearview mirrors back in their pre-fold positions prior to driving.

CAUTION

For electric folding outside rearview mirrors, do not fold them manually. Otherwise, the internal structure of the rearview mirror may be damaged.

Auto folding when locking the vehicle

The folding mode of the outside rearview mirror can be set via **【Vehicle Settings】** → **【In-Car】** → **【Body】** interface on the multimedia display screen.

The rearview mirrors in automatic folding mode allows you to link its folding and deploying to the locking and unlocking of the doors.

Custom setup of the rearview mirror

Register personal account through **【Personal center】** on the multimedia display screen, the function **【Custom setup】** → **【Personal setup of seat, rearview mirror】** can be activated or deactivated. After activating this function, if the vehicle is in ON mode, the account will memorize the current position of driver's seat and position of rearview.

When registering the account next time, the personalized position will be popped out automatically.

NOTICE

Due to different markets, some market models do not have this function.

Ground lighting setting of the rearview mirror

1. Selecting the outside rearview mirror with ground lighting function, which can be set via **【Vehicle Settings】** → **【In-Car】** → **【Body】** interface on

1

Operation

the multimedia display screen. The function can be set as driver's side only, front passenger's side only or two sides.

2. Engage R gear and adjust the angle of the outside rearview mirror at the front passenger's side to make it more suitable for reversing vision. After adjustment, exist R gear to finish the storage.
3. When the shift lever is switched to gear R, the outside rearview mirror with ground lighting function can automatically adjust to the saved proper reversing position; after exiting gear R, outside rearview mirror automatically returns to the position before reversing.

Vehicle equipment

Please note that this manual contains all the standard equipment, country-specific equipment and special equipment for this model series. Thus, some equipment or features described in this manual may not be installed onto your vehicle or are only available in some markets. For further configuration information, please refer to relevant sales information or consult with your distributor selling the vehicle to you.

How to adjust



1. Release the adjustment lever beneath the steering wheel.
2. Adjust the steering wheel to align it to your chest and make sure you can see all the instruments and indicators on the combination instrument.
3. After adjusting, retract the lever back to lock the steering wheel.

⚠ WARNING

- › Adjustment of steering wheel during vehicle running is forbidden. Otherwise, serious injury or death may

result from an accident caused by control errors.

- › You must ensure that the steering wheel is locked firmly in place after adjusting it. Otherwise, serious injury or death may result from an accident caused by sudden movement of the steering wheel.

Horn

Press the horn mark on the steering wheel or its surrounding area and the horn honks.

Light control

1

Operation

Vehicle equipment

Please note that this manual contains all the standard equipment, country-specific equipment and special equipment for this model series. Thus, some equipment or features described in this manual may not be installed onto your vehicle or are only available in some markets. For further configuration information, please refer to relevant sales information or consult with your distributor selling the vehicle to you.

Lamp settings

i NOTICE

The layout and operation of multimedia display screen may vary from the model configurations, please refer to the actual vehicle.

Through the multimedia display screen, the following light settings can be carried out :

- › Touch **【Active welcome setting】** button, and the active courtesy setting can be activated or deactivated.

After activating this function, when the power is in LOCK mode or the position lamp is off, unlock the vehicle door from the outside, and the daytime running lamp and the position lamp on the back door will be lightened dynamically.

- › Tap the **【Power saving delay time】** setting button to set the delay

effective time of the power saving function.

After the ignition switch is turned to the LOCK position, if the state of the power supply of the vehicle, the door lock or the emergency flashers switch don't change within the set time, the power saving function will be activated automatically to save power.

- › Tap the **【Ceiling lamp delay time】** button to set the delay time for the interior lamps to go out after all doors are closed when the interior lamps are on due to the door control function.
- › Tap the **【Take me home delay】** button to set the continuous lighting time of the position lamp and the low beam headlamp after the "Follow-me-home" function is triggered.
- › Tap the **【Vehicle search function mode】** setting button to set the vehicle prompt status when the vehicle locating function is triggered.

Light control combination switch

Main lighting switch

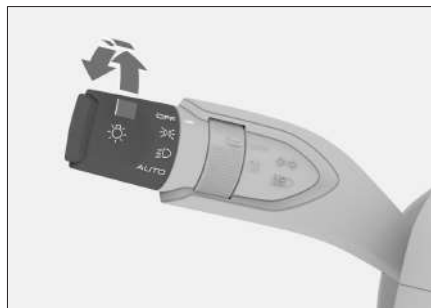

3927AC98287D

- › Turn the main lamp knob to the width lamp position  to turn on the position lamp and the license plate lamp.

CAUTION

Do not use the position lamp to replace the low beam headlamp in the driving. Otherwise, there is a risk of an accident.

The position lamps are not bright enough to illuminate the road in front of the vehicle or allow other vehicles and pedestrians to see the vehicle. Therefore, turn on the low beam headlamp when the weather is dim or visibility is poor.

- › Turn the main lamp knob to the low beam headlamp position  to turn on the low beam headlamp and keep the position lamp and the license plate lamp illuminated.
- › Turn the knob of the main lamp knob to the AUTO position. The width lamps and low beam headlamps will be turned on or off automatically according to the brightness of the surrounding environment.

CAUTION

- › When visibility is affected in the day due to fog, the lamps may not light up automatically. Please turn on the lamps manually in this case.
- › Automatic light control can only assist the driver. At all times the driver

should be responsible for the lighting of the vehicle.

- › Turn the main lamp knob to the OFF position to turn off all vehicle lamps.

Fog lamp switch



DD2CEF12CC39

When the low beam headlamp is illuminated, turn the fog lamp knob to the rear fog lamp position  repeatedly to turn the rear fog lamp on or off. When released, the knob will automatically return.

Turn signal and lane change signal

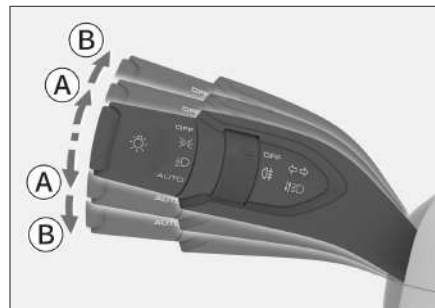

DB397E53DFCA

- Ⓐ Lane change signal
- Ⓑ Turn signal
- › Lane change signal: Pull up or push

down the light control combination switch gently and release it, then the light control combination switch will return automatically and the corresponding turn signal lamp will flash 3 times.

- › Turn signal: Pull up or push down the light control combination switch and release it, then the light control combination switch will not return automatically and the corresponding turn signal lamp will flash continuously.

High/low beam manual switch



44B9EE7AB515

- Ⓐ High beam headlamp on
- Ⓑ High beam headlamp flashes
- › When the low beam headlamp is on, press the light control combination switch in a direction away from the steering wheel to turn on or off the high beam headlamp; when you release the light control combination switch, it returns automatically.
- › The high beam headlamp turns on when you pull the light control combination switch up in a direction close to the steering wheel; when released, the

light control combination switch automatically returns and the high beam headlamp goes out. You can repeat this operation to make high beam headlamp flash.

Emergency flashers

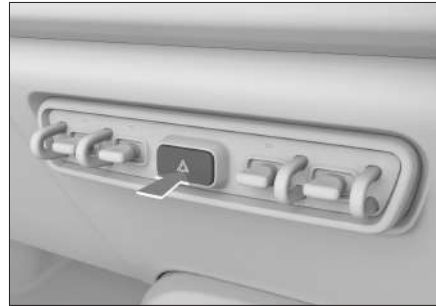

9A856D1FB2AE

In the event of vehicle failure or traffic accident, turn on the emergency flashers to warn other vehicles.

Press the switch to turn on or turn off the emergency flashers.

Daytime running lamp

To allow other drivers to see your vehicle more clearly, the daytime running lamps automatically light up when the vehicle is started.

The daytime running lamps will go out when the following conditions are triggered:

- › When the headlamps lamp is turned on.
- › When the left or right turn signal lamp is on, the daytime running lamp on the same side will turn off.

⚠ WARNING

The daytime running lamp is not designed for the needs of night-time driving.

Follow me home function

The position lamp and the low beam headlamp will automatically illuminate for a period of time when the following conditions are met to ensure that you are able to leave the vehicle in a dark environment.

- › If the vehicle model is equipped with automatic lamp, the the vehicle power supply is in LOCK mode and the main lighting switch is in AUTO position or low beam lamp Ⓛ . Once the current light intensity meets a condition for turning on the low beam headlamp, all the doors and back door are successfully locked outside the vehicle.
- › If the vehicle model is not equipped with automatic light, the vehicle power supply is in the LOCK mode and the main lighting switch is in the low beam headlamp position Ⓛ , all the doors and back door can be successfully locked out of the vehicle.

Emergency braking warning

When the speed of the vehicle exceeds 50 km/h, the turn signal lamp will flash if you perform emergency braking at that time.

Light height adjustment



The headlamp beam height is adjusted according to the number of passengers and the load of the vehicle.

- › Turn the knob upwards to raise the height of the headlamp beam.
- › Turn the knob downwards to lower the height of the headlamp beam.

Interior lamps

Reading lamp

⚠ CAUTION

Do not use the interior lamps for a long time when the vehicle is not started. Otherwise, it may lead to drain battery.



- › Press the reading lamp main switch ☀️ to turn on or turn off the reading lamps.
- › Press the door-control switch 🚪 to enable or disable door-control function.

With the door-control function enabled, the reading lamp will turn on or turn off automatically according to the door condition.

Roof lamp



4BB440EB81C3

- › Press the door control switch 🚪 to enable or disable the door control function.
With the door control function enabled, the roof lamp will turn on or turn off automatically according to the door condition.
- › Press the roof lamp switch ★ to turn on or turn off roof lamp.

Luggage-area light

When the back door is open or closed, the luggage-area lights turn on or off automatically.

Vehicle equipment

Please note that this manual contains all the standard equipment, country-specific equipment and special equipment for this model series. Thus, some equipment or features described in this manual may not be installed onto your vehicle or are only available in some markets. For further configuration information, please refer to relevant sales information or consult with your distributor selling the vehicle to you.

Electric wiper

Front wiper

Front wiper position

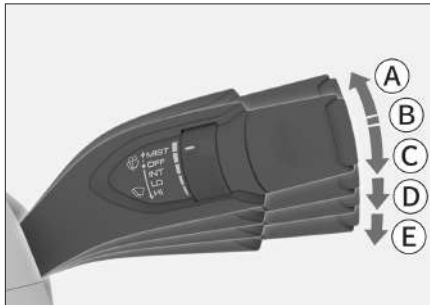

9EEFC6F61A63

A Front wiper mist operation (MIST)

Pull up the wiper control combination switch to the MIST position. After releasing, it will automatically return to its position, and the front wipers will wipe once.

B Front wiper off (OFF)

C Intermittent wipe (INT)

D Low speed wipe (LO)

E High speed wipe (HI)

! CAUTION

- › If the windscreen is dirty or has any foreign object stuck to it (such as snow or tree sap and so on), please clean off and remove the foreign object before use to avoid damaging the blade and the internal structure of the wiper.
- › Before using the wipers in the cold season, you shall check whether the wiper blade is frozen to the windscreen. If the wiper blades are frozen to the windscreen, make sure to defrost them before use to avoid damaging the blade and wiper motor.
- › If the wiper get stuck for any reasons, such as snow, please turn off the wiper and park the vehicle at a safe location as soon as possible. Then remove anything that is preventing the wipers from wiping so that the wiper can work normally.
- › Please do not operate the front wiper when the engine hood is opened. Otherwise, the wiper or the engine hood may be damaged.
- › Do not use the product which can produce cladding on the windscreen (for example, the screenwash contains plated crystal or coating film, glass coating and so on); do not use the windscreen washer containing waxiness; do not wash the vehicle using wax water. Otherwise, the wiper may bounce and make abnormal

sounds when wiping.

- › The blade cannot get contact with oily cleaning agent. They may react chemically which cause the blade deformed.

Intermittent wipe interval adjustment



06BA33617EC3

Rotate the adjustment knob to change the intermittent time, thereby changing the wiping frequency of the front wiper when set to intermittent wiping.

Washing function



34B477211849

Pull up the wiper control combination switch along the vertical angle of the steering wheel. The front wipers will use windscreen washer to wipe the front windscreen.

⚠ CAUTION

- › Avoid using the washer for a long time repeatedly. Otherwise, the washing motor may be damaged. To protect the washing motor, the washer may automatically shut down after a period of continual operation.
- › Always check the liquid level of the windscreen wash tank and add it in time.

In cold weather, use a appropriate screen wash to ensure that the screen wash will not freeze. Otherwise, the wipers will not work, and related components will be damaged from freezing up.

Automatic wiper

Front wiper

Front wiper position



35F31A000F99

- Ⓐ Front wiper mist operation (MIST)
Pull up the wiper control combination switch to the MIST position. After releasing, it will automatically return to its position, and the front wipers will wipe once.
- Ⓑ Front wiper off (OFF)
- Ⓒ Automatic brush (AUTO)
- Ⓓ Low speed wipe (LO)
- Ⓔ High speed wipe (HI)

⚠ CAUTION

- › If the windscreen is dirty or has any foreign object stuck to it (such as snow or tree sap and so on), please clean off and remove the foreign object before use to avoid damaging the blade and the internal structure of the wiper.
- › Before using the wipers in the cold season, you shall check whether the wiper blade is frozen to the windscreen. If the wiper blades are frozen to the windscreen, make sure to defrost them before use to avoid damaging the blade and wiper motor.
- › If the wiper get stuck for any reasons, such as snow, please turn off the wiper and park the vehicle at a safe location as soon as possible. Then remove anything that is preventing the wipers from wiping so that the wiper can work normally.
- › Please do not operate the front wiper when the engine hood is opened.

Otherwise, the wiper or the engine hood may be damaged.

- › Do not use the product which can produce cladding on the windscreen (for example, the screenwash contains plated crystal or coating film, glass coating and so on); do not use the windscreen washer containing waxiness; do not wash the vehicle using wax water. Otherwise, the wiper may bounce and make abnormal sounds when wiping.
- › The blade cannot get contact with oily cleaning agent. They may react chemically which cause the blade deformed.

Adjustment of auto wiping frequency



20A90096558F

Turn the rotation adjustment knob to change the sensitivity settings for the rainfall and light sensor in order to adjust the wiping frequency of the front wiper at the auto wiping position.

Washing function



DE17145CA295

Pull up and hold the wiper control combination switch towards the steering wheel, then the front wipers will use windshield washer fluid to wipe the front windshield. When released, the combination switch will return automatically.

⚠ CAUTION

- › Avoid using the washer for a long time repeatedly. Otherwise, the washing motor may be damaged. To protect the washing motor, the washer may automatically shut down after a period of continual operation.
- › Always check the liquid level of the windscreen wash tank and add it in time. In cold weather, use an appropriate screen wash to ensure that the screen wash will not freeze. Otherwise, the wipers will not work, and related components will be damaged from freezing up.

Rainfall and light sensor



E8DB7C29E1BB

The rainfall and light sensor is located in the center on the top of the front windshield in the vehicle.

⚠ WARNING

- › The rainfall and light sensor does not fully recognize each precipitation and activate the front wiper. If rain on the windshield glass affects the line of sight, you shall manually adjust the front wiper gear or wiper frequency timely as required.
- › When the automatic front wiper is in the AUTO position, the front wiper may operate unexpectedly if it touches the windshield near the inside rearview mirror from outside the vehicle or the windshield glass is vibrated. Be careful not to grip your fingers and other parts by the front wiper.
- › Do not set the automatic front wiper in the AUTO position when you wash the car or no front wiper is required.

to be used. Otherwise, the front wiper may operate unexpectedly.

CAUTION

- › If the surface of the windshield glass near the inside rearview mirror is dirty or attached with any foreign object (snow, gum, etc.), please clean it first and remove the foreign object, otherwise it may affect the normal operation of the automatic wiper.
- › Even if snowflakes come in contact with the rainfall and light sensor, the sensor may not operate normally and the front wipers may not function, as snowflakes come in different shapes. The snow melted may cause the front wiper to automatically brush.

Front wiper washing setting

The wiping interval of the front washer can be set through **【Vehicle Settings】** → **【In-Car】** → **【Body】** on the multimedia display screen, that means the interval from the time when the front washer motor starts to work to the the front wiper starts to wipe.

Air conditioning system

1

Operation

Vehicle equipment

Please note that this manual contains all the standard equipment, country-specific equipment and special equipment for this model series. Thus, some equipment or features described in this manual may not be installed onto your vehicle or are only available in some markets. For further configuration information, please refer to relevant sales information or consult with your distributor selling the vehicle to you.

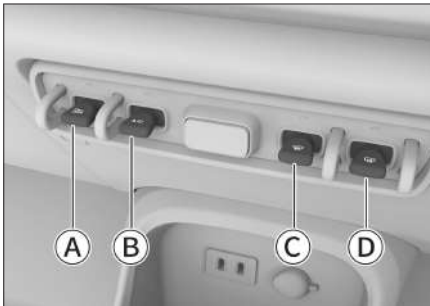

Air conditioning control panel



A2E3AAB8F1DB

- Ⓐ ON / Off button of the air condition (ON / OFF)
 - Ⓑ Cooling button (A/C)
 - Ⓒ Front defroster button
 - Ⓓ Rear window defroster button
- › Press **【ON/OFF】** button to turn on or turn off the air-conditioning system.
- › Press **【A/C】** button to activate or deactivate the cooling mode. The corresponding indicator illuminates, indicating that the cooling mode is activated.

In this mode, the inside temperature and humidity may be reduced.

- › Press the front defroster button  to enable/disable the front defroster function. The corresponding indicator lights up, suggesting that the front defroster function has been enabled, and the frosting and fogging of the front windshield and the side door glass can be gradually eliminated.
- › Press the rear window defroster button  to enable/disable the rear window defroster function. The corresponding indicator lights up, indicating that the rear window defroster has been turned on. At this time, you can gradually relieve the frosting of the rear window.

⚠ WARNING

Once the rear window defrosting function has been enabled, the rear windshield will become hot. Do not touch it to avoid burns.

⚠ CAUTION

When the vehicle is not started, please do not use the rear window defrosting function for a long time, so as to prevent the battery power from being drained.

A/C setting interface

i NOTICE

The layout and operation of multimedia display screen may vary from the model configurations, please refer to the actual vehicle.



type 1



1636F4728E74

type 2



- › Tap heater button  to activate or deactivate the heating mode. The corresponding indicator illuminates, indicating that the heating mode is activated. In this mode, the inside temperature and humidity may be increased.
- › Tap the internal circulation button  to turn on or off the internal circulation mode.

The corresponding indicator lights up, indicating that the internal circulation mode has been turned on.

The corresponding indicator is extinguished, indicating that the external circulation mode has been turned on. In this case, the air outside the vehicle can be







introduced into the vehicle.

i NOTICE

- › Normally, you should put the system in external circulation mode. Use of internal circulation mode tends to cause foggy windows, especially when the compressor is turned off.
- › The internal circulation mode should be used under various circumstances such as driving inside tunnel or in the traffic jam, dirty air outside the vehicle or quick cooling and heating is desired.
- › Tap **【A/C】** button to activate or deactivate the cooling mode. The corresponding indicator illuminates, indicating that the cooling mode is activated. In this mode, the inside temperature and humidity may be reduced.
- › Tap **【AUTO】** button to activate the automatic mode. In this mode, the air outlet mode and the air volume can be automatically adjusted to reach the set temperature.

i NOTICE

If the automatic air-out mode and air flow volume adjusted by the A/C system cannot meet your demand, you can perform manual adjustment; in this case the system will exit the AUTO mode, and the indicator will go out.

- › Touch the  or **【OFF】** button to turn off the A/C system.
- › Tap the face-blowing mode button , the feet and face-blowing mode button , the feet-blowing mode button , or the feet-blowing and defroster mode button  to select the corresponding blowing mode.
- › Touch or slide the temperature display on the right of the air conditioning setting interface to adjust the temperature.
- › Touch the rear window defroster button  to enable/disable the rear window defroster function. The corresponding indicator lights up, indicating that the rear window defroster has been turned on. At this time, the frosting of the rear window is gradually relieved.

The rear window defrosting function will turn off automatically after it has been turned on for a period of time, and the corresponding indicator will go out.



⚠ WARNING

Once the rear window defrosting function has been enabled, the rear windshield

will become hot. Do not touch it to avoid burns.

⚠ CAUTION

When the vehicle is not started, please do not use the rear window defrosting function for a long time, so as to prevent the battery power from being drained.

- › Touch the front defroster button  to enable/disable the front defroster function. The corresponding indicator lights up, suggesting that the front defroster function has been enabled, and the frosting and fogging of the front windshield and the side door glass can be gradually eliminated.
- › Touch the air volume button  to call up the the air volume adjustment pedal. Tap or slide the area on the air volume interface to adjust the air volume.
- › Tap the more A/C setting button , and the A/C comfort setting interface will be popped out.

A/C comfort setting

On the A/C setting interface, tap the  button to pop up the A/C comfort setting interface.

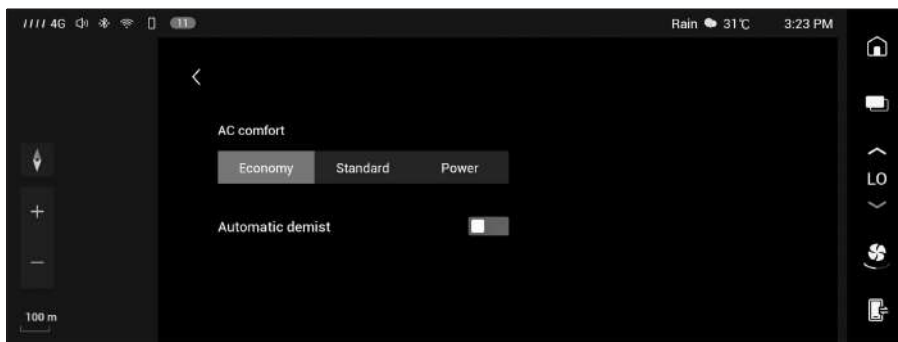

- › Set the comfort effect of the A/C system in AUTO mode on the A/C setting interface:

Soft: The cooling or heating effect of the A/C system is softer with smaller air volume compared with the standard mode.

Standard: The A/C system automatically controls the outlet temperature and air volume according to the temperature set by the user.

Powerful: The cooling or heating effect of the A/C system is stronger with larger air volume compared with the standard mode.

› Automatic defroster

You can turn on or off the automatic defrosting function.

1

Operation

A/C system control

Cooling/heating

After starting the vehicle:

1. Select AUTO mode and the corresponding indicator will illuminate. At this moment, the compressor will automatically turn on or off depending on the temperature and the environment.
2. Select your desired temperature. The A/C system will automatically adjust air-out mode and air flow volume to achieve this temperature.
3. Selecting the internal circulation mode may speed up cooling or heating and help to improve the economy and comfort of the vehicle.

Front defroster/defogger

After starting the vehicle:

1. Select the front defroster mode, the corresponding indicator will illuminate.
2. Adjust the airflow, temperature, turn on or off the compressor, or switch between the internal and external circulating modes on demand.

i NOTICE

If the air is dirty or fog is formed inside the car, switch to external circulation mode.

! CAUTION

- › Check the radiator and the air

conditioning condenser on a regular basis. Use a low-pressure water gun or a soft brush to remove the leaves, insects and dust from their front surface. Otherwise, these objects will block the air flow, thereby reducing the cooling effect.

- › Running the air conditioner regularly keeps the compressor and seals well lubricated and prevents leakage. Therefore, even in the cold season when air conditioning is not required, it is necessary to run the air conditioner at least once a week for more than 10 minutes each time.
- › If the A/C system does not cool as well as before, please head to service provider for maintenance.
- › Direct discharge of refrigerant into the atmosphere is harmful to the environment and the refrigerant shall be recovered by trained and certified technicians using appropriate containers.

i NOTICE

About the air conditioning smell

› Source of the smell

Internal and external air exchange should be carried out for air conditioning as its long-term use may gather dirt which will mould after a long time, resulting in odour.

The air conditioning filter will accumulate water vapor, dust, etc. after

used for a long time, resulting in odour.

› **Recommended measures**

When the outside air is fresh, use the external circulation mode so that the air in the vehicle may maintain the good ventilation.

It is recommended to turn off the air conditioning compressor (A/C), keep the blower to vent for 3 - 5 minutes before the A/C system is shut down so that the A/C system may be dry to prevent mold breeding.

When you feel the smell is very strong, it is recommended to head to service provider for a check and clean or to replace the air conditioning filter if necessary.

Cleaning function of the seat compartment

Cleaning function of the seat compartment can remotely clean the air in the driving compartment through mobile phone application before you entering into the vehicle.

The cleaning function of the seat compartment will be deactivated automatically after opening for a long time. This function will deactivate when opening the door.

i NOTICE

Following conditions should be satisfied when using the cleaning function

of the seat compartment:

- › The SIM network signal in the vehicle will be unblocked.
- › When the vehicle power supply is in LOCK mode and all the vehicle doors are fully closed.



⚠ CAUTION

- › The vehicle will switch to READY mode automatically when activating the cleaning function of the seat compartment so as to avoid battery loss.
- › Do not use this function in bad outside environment.

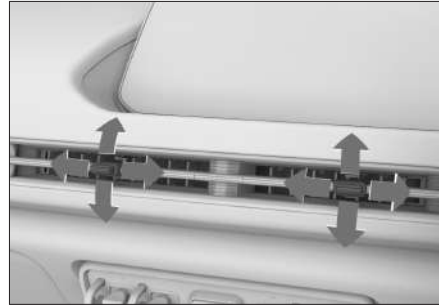
Vent



71CFEF8B7A58

By turning the slats at the center of the vent, adjust the direction of air flow. Slide the slats to the limit position as the direction indicated by the left-to-close marking  or right-to-close marking  to close the air vent.

Vehicle equipment

Please note that this manual contains all the standard equipment, country-specific equipment and special equipment for this model series. Thus, some equipment or features described in this manual may not be installed onto your vehicle or are only available in some markets. For further configuration information, please refer to relevant sales information or consult with your distributor selling the vehicle to you.

How to use

The mobile wireless charging function can be enabled or disabled through the **【Vehicle Settings】** → **【In-Car】** → **【Wireless Charger】** interface on multi-media display screen.

After enabling the wireless charging function of mobile phone, make sure that the doors are closed, turn the power supply of the vehicle to ON position or start the vehicle. Then the mobile phone placed in the charging area can be charged.



B94046B3063B

i NOTICE

In order to achieve a better charging effect, it is necessary to ensure that the charging coil of the mobile phone is facing downwards.

i NOTICE

- › This function is not applicable to all mobile phones, but only to mobile phones that have passed the "Qi" official standard certification and can be normally placed in the charging area.
- › Only one mobile phone can be charged at a time.
- › On bumpy roads, intermittent stopping and resuming of wireless charging may occur. If the mobile phone deviates from the charging area and stops charging, it is necessary to move the mobile phone back to the charging area.
- › It is normal that wireless charging devices and mobile phones will get hot during charging.

When the temperature is too high, the system will stop charging, and will continue charging after the temperature drops.

- › If the phone breaks down, it may also cause failure to charge. Other mobile phones that meet the requirements can be used for wireless charging detection to confirm whether the mobile phone is faulty.

- › If the mobile phone is equipped with protective covers or accessories that do not support wireless charging, they shall be removed first; otherwise, the phone cannot be charged normally.
- › To prevent draining the battery, do not use the wireless charging function for a long time when the vehicle is not started.

WARNING

- › For the sake of safety, drivers shall not perform charging related operations during driving.
- › Please do not place coins, keys, chip cards and other metal objects in the charging area. Otherwise, metal objects may be heated, which may lead to abnormal charging or cause safety accidents.

If metal foreign objects are found in the charging area during charging, please do not remove them by hand immediately to avoid scalding your fingers. Turn off the wireless charging function immediately, and wait a few minutes before removing foreign objects.

- › If you need to use the charging area as a storage box, please turn off the wireless charging function.

CAUTION

- › Do not dump any liquid in the

charging area, so as to avoid the liquid entering the wireless charging system through the gap of rubber pad, which may lead to system failure.

- › Do not modify the wireless charging system to avoid damage to the vehicle or accidents.

NOTICE

The communication device conforms to the standard and requirements of NBTC.

Vehicle equipment

Please note that this manual contains all the standard equipment, country-specific equipment and special equipment for this model series. Thus, some equipment or features described in this manual may not be installed onto your vehicle or are only available in some markets. For further configuration information, please refer to relevant sales information or consult with your distributor selling the vehicle to you.

Sun visor



0EA08BF4F8DB

To block sunlight from straight ahead, flip down the sun visor.



FCBE7BD4848E

To block sunlight coming in from the side, flip down the sun visor, unhook it

and push it to the side.

Vanity mirror



34B196A68108

A vanity mirror is set inside the sun visor. Open the cover and use it.

Please close the lid when not using the vanity mirror.

Storage device

Storage box



D5C45DEC8108

Press the open button of the storage box to open it automatically.

Flip the storage box up until the lock is in place and then close it.

⚠ WARNING

Make sure the storage box is closed when driving. Otherwise, such items

may be dislodged from the storage box and lead to an injury in the case of an accident or emergency braking.

Storage case



E1A369A305C1

There is a storage case below the front seat armrest. To use it, just flip up the seat armrest and open it.

Spectacle case



2347C17A7F04

Press the spectacle case to open it.

⚠ WARNING

Make sure the spectacle case has been closed when driving.

i NOTICE

Certain oversized sunglasses models

may not fit into this case.

Cup holder



21984A4711C7

The front cup holders are located on the auxiliary instrument panel as shown in the figure.

⚠ CAUTION

- › Don't place small or unstable beverage cans in the cup holders, or they may tip over.
- › Make sure that the lid of the beverage can is covered to avoid spilling liquid.

Bottle holder

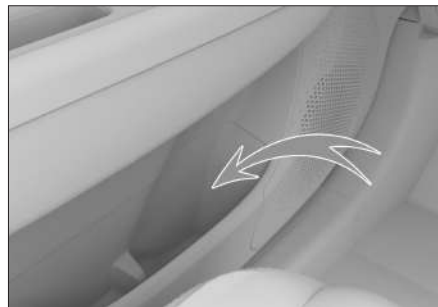

627E2CD5C0A0

There is a bottle holder on the inside of each door, which is used only for placing

the sealed bottle container.

⚠ WARNING

Do not place anything other than bottles inside the bottle holder. Otherwise, in the case of an accident or emergency braking, such items may be dislodged from the bottle holder and lead to an injury.

⚠ CAUTION

Make sure that the lid of the bottle is covered to avoid spilling liquid.

Power socket

USB power socket



CSDA9CBE1FA3

Near the rear of the auxiliary instrument panel.

When the the power supply is in the ON position, the cover can be opened when in use.

This power supply can be used to charge the devices such as mobile phones and tablets.

Standby power



3BB80EEE65E9

Near the front of the cup holder on the auxiliary instrument panel.

When the the power supply is in the ON position, the cover can be opened when in use.

This power supply can provide a 12 V DC power for accessories rated less than or equal to 120 W (10 A).

Power supply of driving recorder



F08F10A14927

It is located near the interior rearview mirror.

This power supply can be used when the vehicle power is in the ON position.

This power supply is designed to provide a 5 V DC power for driving recorders rated less than or equal to 10 W.

⚠ WARNING

For driving safety, be careful not to block the line of sight to prevent danger when installing a driving recorder.

⚠ WARNING

Flammable gases and heaters must be kept away from the power socket.

⚠ CAUTION

- › Do not allow liquids such as beverages or foreign objects to enter the power socket, otherwise it may cause malfunctions such as short circuits, etc. If the power socket has a cover, close the cover when not in use.
- › If you use an attachment that exceeds the rated power, the vehicle fuse may be burnt out.
- › Do not connect precision devices, highly sensitive equipment or other important equipment to this power socket.
- › Do not use this power supply in humid and high-temperature conditions.
- › Don't use it in parallel or in series with any other power supply.
- › If you discover any abnormality (e.g. unusually high temperatures, smoke, odors, etc.) in the course of use, halt use immediately and contact service provider for inspection and maintenance.

- › Modifying or repairing this electrical system without authorization is forbidden.
- › Make sure all connecting wires are sealed and waterproof.

2

Driving

Driving norms	80	Driving assist system.....	151
Suggestions for driving in harsh environment.....	85	Virtual instrument	154
Suggestions for driving in running-in period.....	90	Indicator lights on instrument penal.....	160
Pure electric vehicles	91	Power management system	168
Vehicle's power supply.....	97		
Parking brake	99		
Transmission.....	102		
Driving mode.....	105		
Super power-saving mode ..	107		
Single pedal mode.....	108		
Voice prompt system	110		
Power-steering mode	111		
Parking assist system.....	112		
Tyre pressure monitoring system	125		
Cruise control system	127		
Cruise assist system.....	130		
Intelligent drive assist system	137		

Driving norms

Vehicle equipment

Please note that this manual contains all the standard equipment, country-specific equipment and special equipment for this model series. Thus, some equipment or features described in this manual may not be installed onto your vehicle or are only available in some markets. For further configuration information, please refer to relevant sales information or consult with your distributor selling the vehicle to you.

Before driving

Removing miscellaneous items

Remove the snow and fallen leaves, etc. accumulated on the vehicle before driving.

Check vehicle conditions

Please check the daily checking items such as tyres, fluid, light and body appearance before driving in order to ensure your safe and pleasant driving.

Check the remaining power of the power battery and the driving range before driving to ensure that the vehicle can run to the destination smoothly.

If you are of the opinion that your vehicle requires maintenance or repair, please get in touch with service provider in a timely manner.

Confirm that the vehicle doors and the engine hood are closed

Before driving, make sure all vehicle

doors are closed. If a vehicle door has not been closed properly, it may open unexpectedly during the driving and cause an accident.

Before driving, if you have opened up the engine hood, check that the hood has been locked down. If the engine hood has not been secured and locked properly, it may fly open during driving and cause an accident.

Placing objects within the vehicle

On the instrument panel

Do not place any item on the instrument panel as the items placed on the instrument panel may not only obstruct the driver's view, but also affect the starting and safe driving, which may lead to an accident.

The driver's feet space

Do not place any item at the feet of the driver. Items placed at the driver's feet may be trapped under pedals, causing the driver to lose control of the vehicle, or leading to an accident.

If you want to use a floor mat, please choose an appropriate floor mat. If the selected floor mat shape and its layout position are inappropriate or if floor mats are double stacked, brake pedal performance may be affected. As a result, the vehicle may not be started, it's difficult or unable to change gears or even lead to a higher risk of other accidents.

Under the seat

Do not place any item under the seats. Items placed under the seat will make it difficult to adjust the seat position or or lock the seat in place, which could easily lead to an accident.

Seat backrest

Do not place cushions and other items between the seat backrest and the back of the human body as it might affect the driving posture. Besides, in the event of a vehicle collision, the effectiveness of seat belts and head restraints will not be realized to the full, which may result in serious life-threatening injuries.

On the window glass

Do not attach items such as decorative items using vacuum suction cups on vehicle windows.

Vacuum suction cups can act as a lens, leading to a higher risk of fires.

Precautions for driving

No use of mobile phones

When making or answering a phone call, it's easy to focus on the phone and cause an accident.

If the driver needs to use a mobile phone, please do so when the vehicle has been parked in a safe spot.

Fatigue driving is prohibited

Fatigue driving is extremely dangerous as the judgment, view and attention of driver in fatigue state will drop

substantially. It is likely to bring about severe accident.

Turning the steering wheel fully in either direction and holding it there for an extended period of time is prohibited

Failure to do so may make the power steering system have less efficiency, or even damage the system.

The vehicle's undercarriage, tyres, and wheels suffer a strong impact

When the vehicle's undercarriage, tyres, and wheels suffer a strong impact, stop the vehicle immediately in a safe spot and inspect the vehicle. Check that there is no leaking of brake fluid, and that suspension parts, tyres, wheels, drive shaft and other components are not deformed or damaged. If there is any leakage or damage, stop the vehicle and contact the service provider immediately. If you continue driving in this case, accidents may easily happen.

When going downhill

Slow down when driving on a slope or running downhill over a long steep slope. If you continuously engage the brake pedal, the brake may overheat, thereby compromising braking efficiency and making the occurrence of accidents more likely.

Switch the power supply to LOCK mode when going downhill is forbidden.

The braking force assist device and

power steering system will not work, if the power is turned to LOCK mode forcibly. In this scenario, braking efficiency will be compromised and you feel the steering wheel heavy, making the occurrence of accidents more likely.

Driving on uneven road surfaces

When stopping on a curb or on a road surface with a height difference, make sure that the tyre is not crushed and deformed by the curb or other obstacles.

When the vehicle must pass a curb, a deceleration zone or a similar obstacle, you should try to slow down along the vertical angle of the obstacle. Failure to do so may result in damage to the tyre, especially to the side wall of the tyre.

Driving in the following road conditions may cause damage to the bumper. Please slow down and drive carefully.

- › Where there are varying levels, such as at parking lot entry/exit points.
- › Where there are steep slopes, like in the case of multi-story parking lots.
- › Uneven road and road section with track.
- › Sections of road where there are potholes.
- › When moving from a flat surface onto a slope, or when moving from a slope onto a flat surface.
- › When parking on road with deceleration strip or along curb.

Driving on slippery road surfaces, such as wet, snow-covered, or icy roads

Emergency braking, sudden acceleration, or sudden steering on slippery road surfaces may cause vehicle tyres to skid and the vehicle to go out of control, thereby causing an accident.

In cold weather, you should slow down when driving in areas of ice, such as bridges and shady areas.

Driving on flooded roads

Drive carefully on a road with accumulated water and do not run on the road with too much water.

When driving on a road with accumulated water, the components of the electrical system including power battery packs and motor controller may be seriously damaged.

While driving on a flooded road, the brake pads will become wet and braking efficiency will be reduced, which can easily lead to accidents. Please step gently and repeatedly on the brake pedal in order to warm up the brake until full brake performance has been recovered.

Precautions for passengers

Moving within the vehicle is forbidden

It is forbidden for the passenger to leave his or her seat, or to move around inside the vehicle. Otherwise, during

emergency braking, the passenger's body or head, etc., may suffer injurious impact.

Do not stretch your hands or head outside the vehicle window or sunroof

If you stretch your hands or head out of the vehicle, it could be prone to hitting against the window frame if braking occurs or the window is closed. In this case, it may cause serious injury or even death.

Do not carry child passengers on your lap

When riding as a passenger, do not carry an infant or child passenger on your lap even if you are already wearing a seat belt. Further, do not surround or enclose the infant or child using any part of the seat belt; this may cause grievous injury or even death during collisions or emergency braking.

Child passengers must not be allowed to operate equipment such as vehicle doors, vehicle windows and the sunroof

If child passengers are allowed to operate doors, windows and sunroof, they may be at risk of clipping their hands, heads, necks, etc., in the operation. All these can cause grievous injury.

If the vehicle door is opened during the driving, children could accidentally fall out of the vehicle and consequently, suffer

serious injuries and even death.

Please use a child safety lock and a window lock to prevent children from accidents because of an incorrect operation.

Parking the vehicle

The vehicle shall be parked in a ventilated, dry, and cool place with a suitable temperature to ensure the performance of the vehicle and the service life of the power battery.

Do not park the vehicle close to flammable materials

Do not park your vehicle near flammable materials such as areas with plenty of grass/hay or scrap paper. Otherwise, it can lead to fire accidents.

It is forbidden to park the vehicle in a place with high temperature heat sources

Do not park the vehicle in a place with high temperature heat sources such as flames. Otherwise, accidents will be most likely to happen.

Economic driving

Predictable driving

Maintain a proper distance with the front running vehicle and avoid unnecessary acceleration and braking. The stable vehicle speed can increase the driving range.

Avoid unnecessary weight

The loaded and overloaded driving of

the vehicle will increase energy consumption. Before driving, remove unnecessary items from the vehicle.

Check tyre pressure periodically

Too small tyre pressure will increase the rolling resistance, thus increasing the energy consumption while increasing tyre wear.

Regular maintenance

Regular maintenance ensures a longer service life and the best economy of your vehicle.

Reasonable use of air conditioner

Activating the cooling or heating function of air conditioner will shorten the driving range of your vehicle. If the power battery level is low, it is recommended to reduce the use time of the air conditioner to increase the driving range of the vehicle.

Do not adjust the temperature of the air conditioner too high or too low. You should set the air conditioner to an appropriate temperature to decrease energy consumption.

When the air conditioner is not used, turn it off in time.

Close windows and sunroof

Opening the windows or the sunroof increases drag, thereby increasing energy consumption, so turn them off when you do not need them.

Inertial glide

The accelerator pedal should be released when approaching the red light or on a larger slope, allowing the vehicle to take advantage of inertial glide.

Suggestions for driving in harsh environment

Vehicle equipment

Please note that this manual contains all the standard equipment, country-specific equipment and special equipment for this model series. Thus, some equipment or features described in this manual may not be installed onto your vehicle or are only available in some markets. For further configuration information, please refer to relevant sales information or consult with your distributor selling the vehicle to you.

Driving in foggy weather

Turn on the fog lamps

While driving in fog, you should turn on the fog lamps.

Sound horn to warn pedestrians and vehicles

If you hear the horn of other vehicles, respond immediately by sounding your horn to indicate your position.

Drive at low speed and look out for safety

When driving in foggy weather, try to travel at a low speed and keep a safe distance from the vehicle ahead.

Do not wipe fog on the glass during vehicle running

Due to large temperature difference inside and outside the cab, mist may condensates on the inside surface of the windshield that can affect driver's sight. In this case, you can use the A/C

defrosting function or open the vehicle windows a little to have the same air temperature inside and outside the vehicle. This will prevent condensation to form on the inside surface of windshield.

If you wish to wipe away the condensation on the windshield glass, please do so only after bringing the vehicle to a stop. Never try to do so while driving the vehicle.

Driving in the rain

Please drive carefully on slippery road surfaces

As poor view, foggy windshield and slippery road are likely to occur when running on rainy days, please drive carefully.

Emergency braking, acceleration and sudden steering on wet and slippery road will cause tyre skid and vehicle becomes uncontrollable, which easily leads to accident.

While driving in rain, a film of water is likely to form between the tyre and the ground. At this time the tyre is easy to lose grip, so slow down driving.

WARNING

Try to avoid driving in a heavy rain or rainstorm.

Fording drive

Precautions for fording drive

› Before wading, confirm that the

accumulated water on the road does not go above the lower edge of the vehicle body. If there is a large quantity of accumulated water on the road or the water depth is unknown, the vehicle shall take a detour and do not go through a direct course.

- › When analyzing road conditions, do not allow the vehicle to enter an unknown region. Such regions may contain hidden obstacles, such as ditches or manholes.
- › While fording in the water, keep low speed (speed should not exceed 10 km/h) and do not park or switch gears.
- › When the vehicle passes an intersection, try to avoid the waves generated by the preceding vehicle to prevent water from entering the front grille.

Check and maintenance after fording

Once the vehicle has been safely driven through water, perform the following operations immediately:

- › Step on the brake pedal a few times consecutively, and check whether brake performance has been compromised.
- › Check the horn.
- › Check all vehicle lamps.
- › Please head to service provider as soon as possible for routine check. When the vehicle passes through water, water may enter the components

of transmission system and dilute lubricant, which may lead to system malfunctions.

⚠ CAUTION

- › Travel in water is only applicable in emergency situations and it cannot be used as a part of routine driving.
- › Travel in water may damage the motor controller, power battery pack, transmission system and other components, resulting in serious damage to the vehicle.

Driving during the hot seasons

Hot weather and high temperature in summer are bad for the normal vehicle running and the health of driver. To ensure driving safety, the driver shall pay attention to the following items:

Preventing flat tyre

As air pressure in the vehicle tyre rises with temperature increase, flat tyre is likely to occur in case of hot weather and high temperature in hot season.

If you experience a flat tyre in the course of the drive, hold the steering wheel securely, step gently on the brake pedal to decelerate, and avoid actions such as emergency braking or sudden steering. Failure to adhere to the advice may cause the vehicle to go out of control.

Preventing sunstroke

Strong sunlight and high temperature in hot season easily lead to sunstroke. Keep the driving room well ventilated and prohibit fatigue driving.

WARNING

Never leave a child in the vehicle unattended.

- › Leaving children alone in the vehicle during hot seasons can easily cause heat stroke, dehydration, personal injury or even death.
- › If the child, left alone in the vehicle, plays with matches, lighters, cigarette lighters and other items, it is easy to cause vehicle fire accidents.

CAUTION

When parking the vehicle, do not leave items such as lighters, spray can, soft drink cans, spectacles, etc., inside the vehicle.

- › As temperatures inside the vehicle can get very high, a leakage of gas from the lighter, spray cans or cracks in these containers can lead to fire.
- › Should a soft drink can burst inside the vehicle, its contents may splash onto electrical components and cause short circuit.
- › As temperatures inside the vehicle can get very high, it is easy to make resin lens or glasses deformation, resulting in crack.

Driving during the cold season

Snow tyre

In the cold season when the temperature is low, due to the special characteristics of the standard tyre (tyre width, rubber composition and pattern type, etc.), the tyre elasticity decreases, further weaken the traction and braking force, with the problem of increased tyre noise, even lead to serious standard tyre cracks and abnormal wear and tear and other permanent damage. Therefore, please use snow tyres when the temperature is lower than 7°C in cold season. Snow tyres can greatly improve the handling of the vehicle stability, but also improve the vehicle's braking response and shorten the braking distance.

NOTICE

All-weather tyres with M + S markings, although better for the cold season, still fail to achieve the performance of snow tyres, and still require the replacement of snow tyres when driving on ice or icy roads.

WARNING

Although snow tyres can improve the vehicle's winter driving performance, do take away all risk when driving, you need to still be cautious!

- › Be sure to adjust your speed and driving style based on visibility,

weather conditions, road and traffic conditions.

- › Do not exceed the speed and load rating indicated on the loaded snow tyres when driving.

⚠ CAUTION

Severe snow tyre tread wear, it will largely lose its applicability in the cold season. If the snow tyres have aged, then their suitability for the cold season will largely be lost even though the tyre tread wear is insignificant. Snow tyres specific replacement standards, please consult the dealer.

Snow tyre instructions:

- › Must comply with the relevant laws and regulations of the host country.
- › Must have four wheels at the same time install snow tyres.
- › Always use snow tyres of the same size as the standard tyre size.
- › Must use the model, size (rolling circumference) and the same type of snow tyres.
- › Snow tyres can only be used during the cold season.
- › Please be sure to comply with the maximum allowable snow tyres allowed (such as maximum speed, maximum load, etc.), otherwise it may cause tyre damage and cause traffic accidents.
- › Do not reverse the direction of

rotation of the tyre.

Tyre chains

Regulations regarding the use of tyre chains vary according to location and type of road. Always check local regulations before installing chains.

Install tyre chains on the drive wheels only. Do not install tyre chains on only one tyre. Install tyre chains following the instructions provided with the tyre chains.

⚠ CAUTION

Observe the following precautions when installing tyre chains:

- › Improper size or improper installation of tyre chains will damage the vehicle's brake pipeline, suspension, body and tyres, etc. Choose suitable tyre chains and ensure that they are properly installed.
- › Install and remove tyre chains in a safe location. Turn on the emergency flashers, and set the warning triangle behind the vehicle.
- › Always set the power switch to LOCK mode and apply the parking brake before installing the tyre chains.
- › Do not install tyre chains on emergency wheels or small size spare tyres.
- › Do not install tyre chains when the tyre pressure is low.
- › Do not damage aluminum alloy

wheel rim when using tyre chains.

WARNING

Observe the following precautions when driving with tyre chains:

- › Do not drive in excess of the speed limit specified for the tyre chains being used, or 40 km/h, whichever is lower.
- › After installing tyre chains, always check that the tyre chains are properly installed after traveling a distance of 0.5 to 1.0 kilometers to ensure safety. Re-tighten or reinstall the tyre chains if the tyre chains are loosen.
- › Avoid sudden acceleration, turns and braking, as use of tyre chains may adversely affect vehicle handling and cause accidents.
- › When driving, if you hear the tyre chain knock on the vehicle body or chassis, please stop the vehicle and re-tighten the tyre chain. If you can still hear the sound, slow down until the sound disappears.
- › Avoid driving on bumpy road surfaces or over potholes.
- › Slow down before entering the curve, so you can control the vehicle.
- › Remove the tyre chains when driving on road surfaces without snow, or it may affect driving performance and severely damage tyre.

Suggestions for driving in running-in period

2

Driving

Vehicle equipment

Please note that this manual contains all the standard equipment, country-specific equipment and special equipment for this model series. Thus, some equipment or features described in this manual may not be installed onto your vehicle or are only available in some markets. For further configuration information, please refer to relevant sales information or consult with your distributor selling the vehicle to you.

Tyre

Take extra care in the first 500km when driving with a set of new tyres.

New tyres do not offer optimal grip until they have been broken-in.

Friction lining of brake

New friction lining of brake hardly achieves optimal braking effect within first 400km vehicle running.

New friction lining of brake must also be run-in to achieve the best friction performance. Reduced braking force can be increased by treading on brake pedal with larger force.

During the break-in period, avoid applying extra load on the brake. For example, emergency braking, especially emergency braking at high speed and while running on slope.

CAUTION

- › The friction linings and brake disk

may wear to different degrees depending on the using condition and the driving method.

- › Due to the vehicle speed, braking force and environmental conditions (such as temperature and humidity), there may be noise when braking, which is normal.

Vehicle equipment

Please note that this manual contains all the standard equipment, country-specific equipment and special equipment for this model series. Thus, some equipment or features described in this manual may not be installed onto your vehicle or are only available in some markets. For the further configuration information, please refer to relevant sales information or consult with your distributor selling the vehicle to you.

About pure electric vehicle

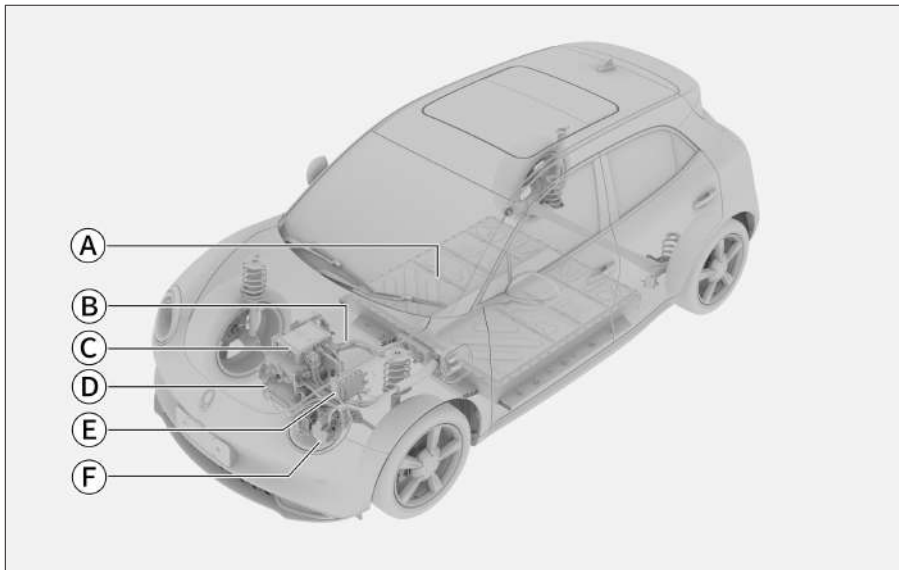

- Ⓐ Battery pack
- Ⓑ High-voltage wiring harness
- Ⓒ Charger
- Ⓓ Drive motor
- Ⓔ A/C heater
- Ⓕ A/C compressor

This vehicle is a pure electric vehicle, which uses high-voltage power battery as the energy storage medium. To ensure your safety while driving and extend the service life of the battery, you must be familiar with the characteristics of pure electric vehicles and drive with care.

⚠ WARNING

- › It is forbidden to touch, remove or replace parts with high-voltage warning signs, orange cables and their connectors on the vehicle to prevent high-voltage electric shock.

- › After the vehicle is started, the power system will be hot. Be careful of high voltage and high temperature, and always follow the instructions on the vehicle safety warning label.

CAUTION

- › It is not recommended to place the vehicle in a high temperature environment above 45°C for more than one day. You should park the vehicle in a cool environment in a timely manner. Otherwise, the performance of the power battery may be affected.
If the temperature of the power battery is too high, the recovered energy and output power will decrease, and in severe cases, the system may cut off the high voltage power and stop the power battery from working.
- › If the vehicle is used at a low temperature, the driving range will be shortened correspondingly because the performance of the power battery is affected by temperature.
- › If the temperature of the power battery is too low, the system will cut off the high voltage power and stop the power battery from working. If you want to use the battery in this case, you can connect a slow charging plug to preheat the battery.
- › Long-term use or abuse of the battery will affect the performance and service life of the power battery, shortening the driving range.

Thermal failure warning of the battery

When the thermal failure of battery is detected by vehicle battery management system, the power supply will be off automatically. The instrument will have text and sound alarm 5 minutes before risk happened in passenger compartment. At this time, the passengers should be evacuated.

Power battery recovery

For the replacement and disposal of the power battery, please always consult service provider and get the recovery requirements. Discarding the power battery at will may pollute the environment or cause safety accidents.

WARNING

- › Never sell, transfer or modify the power battery.
If the power battery is used outside the vehicle or modified in any way, accidents

such as electric shock, burn, smoke, electrolyte leakage and explosion may occur.

- › Do not dispose of the power battery by yourself. Otherwise, it will pollute the environment and electric shock may occur.
- › To ensure your safety, do not open or modify the power battery pack under any circumstances. If the power battery needs to be repaired, disassembled, replaced and scrapped, it shall be handed over to the service provider for disposal.

Heat preservation function of the plug

Function

After fully charged, the plug heat prevention function (heat prevention in winter, cooling preservation in summer) can keep the battery temperature in a proper range so as to keep the battery in a best discharge condition in driving and delay the distance to empty.

How to use

The heat preservation function of the plug can be activated or deactivated through **【Energy consumption assistant】** interface on the multimedia display screen.

Condition to activate the function

When the following conditions are met, the heat preservation function will be activated.

- › Activate the heat preservation function of the plug through switch.
- › The power battery pack is fully charged and the charging plug of the trickle charge is connected effectively.
- › No heating fault of power battery pack.
- › When the vehicle power supply is in LOCK mode and all the vehicle doors are fully locked.
- › Set the charging mode as charging immediately via **【Energy consumption assistant】** on the multimedia display screen.
- › The temperature of power battery pack less than -5°C or more than 30°C .

After activating the heat preservation function for 6 hours, the system will detect once an hour.

- › When the heat preservation function working for 6 hours, the preservation function of the plug will be exited.
- › When the temperature of the battery pack is heated more than 10°C or cooled less

than 20°C, the system will exit the heat preservation function of the plug. After the system detects that the using condition is satisfied again, the system will be activated again.

About energy recovery

The function is mainly used to convert a part of kinetic energy of the vehicle during braking or coasting into electric energy of the power battery, thereby extending the range of the vehicle.

The energy conversion level can be set via **【Energy consumption assistant】** on the multimedia display screen.

2

Driving

i NOTICE

When the single pedal driving mode is started, the energy recovery intensity is not adjustable.

⚠ WARNING

The reduction of vehicle speed caused by energy recovery cannot replace normal braking. The brake pedal shall be depressed during deceleration and parking.

i NOTICE

When the vehicle decelerates obviously as the energy recovery function is activated, the brake lamp may be turned on.

i NOTICE

The energy recovery will not be carried out when the vehicle is under the following conditions.

- › The vehicle is in gear "N" or gear "R".
- › The power battery is fully charged.
- › The temperature of the power battery is too high or too low.
- › The temperature of the drive motor is too high.

⚠ WARNING

When the vehicle cannot carry out energy recovery function in driving, you should make preparation to brake the vehicle. If the vehicle cannot carry out energy recovery function, the electronic driving system cannot brake. Avoid the unnecessary risk

when the vehicle sliding ahead.

2

Driving

Battery safety switch



58269FFC3369

voltage components, which is used to remind you that the component has high voltage. Unauthorized disassembly, repair or replacement is forbidden. Please pay attention to related matters. Otherwise, there are hazards of electric shock.

2

Driving

The battery safety switch, near the supporting rod in the engine compartment, is used to disconnect or connect the power supply of the high voltage system, which can be seen after opening the engine hood.

WARNING

Do not attempt to operate the battery safety switch in the engine compartment. The battery safety switch is only used when servicing the vehicle and performing operations related to high voltage system.

High voltage warning label

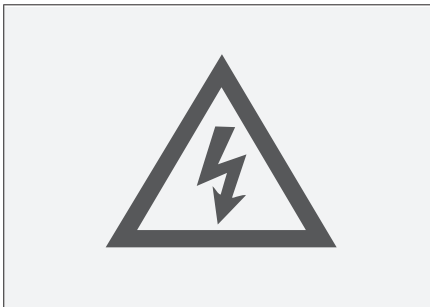

0E59F636B839

The label is located on various high

Vehicle's power supply

Vehicle equipment

Please note that this manual contains all the standard equipment, country-specific equipment and special equipment for this model series. Thus, some equipment or features described in this manual may not be installed onto your vehicle or are only available in some markets. For further configuration information, please refer to relevant sales information or consult with your distributor selling the vehicle to you.

Vehicle power supply

Power supply starting

When unlock the door with intelligent key or PEPS and open the door at driver's side, the power supply will switch to ON mode and connect all the low-voltage electric parts.

Starting vehicle

When the following conditions are satisfied and stepping on the braking pedal, the vehicle will be started (the driving system in the instrument **READY** is ready and the indicator is illuminated).

- › Carry the intelligent key on you.
- › Seat on the driver's side and fasten the seat belt in driver's side.
- › When the N gear is engaged.
- › The electronic steering is unlocked successfully.

Emergency startup



A57A83C374CB

When the prompt "check if the key is in the vehicle" is shown because of the power loss of the intelligent key and other situations, put the intelligent key on the mark in the storage box to meet the starting condition of the vehicle, then step on the braking pedal. If the vehicle cannot be started, please contact service provider immediately.

⚠ WARNING

- › Be sure to sit on the driver's seat before starting the vehicle. Failure to do so may lead to accident, serious injury or even death.
- › Always start the vehicle even if you need to move the vehicle slightly. Failure to do so may result in an accident.

i NOTICE

Instrument prompts that the electronic steering fail to unlock. At this time, turn the steering wheel in accordance with the prompt information. After

successful unlocking, the vehicle can be started.

Turn off the power supply

- › After the vehicle is parked steadily, switch to N gear, and the vehicle doors and back door will be closed. Lock the vehicle doors through intelligent key or PEPS, the power supply will switch to LOCK mode.
- › After the vehicle is stopped steadily, press the power supply off button (Ⓜ), and the vehicle power supply will switch to LOCK mode.



6559BE8DAF9B

Emergency shutting down

When the vehicle is running (vehicle speed is greater than 5 km/h), in the case of an emergency, for example, cannot stop in the normal way, you can press and hold the vehicle power supply off button (Ⓜ) for 5 seconds to switch the power supply to LOCK mode.

⚠ WARNING

- › Switch the vehicle power supply to LOCK mode while driving may cause

a collision or major personal injury.

- › Do not switch the power supply to LOCK mode forcibly while driving in non-emergency situations.

Otherwise, the power assistance of brake and steering wheel will be lost, as a result, it is more laborious to step on the brake pedal and the steering wheel is heavier. Therefore, decelerate as much as possible before operation.

Vehicle equipment

Please note that this manual contains all the standard equipment, country-specific equipment and special equipment for this model series. Thus, some equipment or features described in this manual may not be installed onto your vehicle or are only available in some markets. For further configuration information, please refer to relevant sales information or consult with your distributor selling the vehicle to you.

Tips for safety

⚠ WARNING

- › Parking on a slope steeper than the prescribed limit may cause an accident. Please drive safely and avoid risky parking situations.
- › If the slope is too steep, use of the parking brake system will not be able to stop your vehicle completely. In this case, step on the brake pedal to prevent the vehicle from sliding.

Electronic parking brake

Applying parking brake



2554C150C674

- › After the vehicle has completely stopped, pull up the EPB switch to apply the the electric parking brake (EPB). At this point, the parking brake indicator (P) on the combination instrument turns on.
- › Open the door and unfasten the seatbelt at driver's side after the vehicle has completely stopped, the electronic parking brake will be applied automatically. At this point, the parking brake indicator (P) on the combination instrument turns on.

If the parking brake the is not required, press and hold the EPB switch and press the power off button (P) to switch to N gear.

Emergency braking

In case of emergency, pull up the EPB switch and hold it, then use the EPB system to brake the vehicle. At this time, the combination instrument will sound an alarm.

Emergency braking can be canceled as long as the EPB switch is released or the accelerator pedal is stepped on.

⚠ WARNING

The emergency braking function of the EPB system can only be used in the event of an emergency braking (e.g. when the brake pedal is blocked).

Release the parking brake



D013B185FF06

When the power supply is in the ON mode, step on the brake pedal and press the EPB switch to release the parking brake. At this time, the parking brake indicator (P) on the combination instrument turns off.

i NOTICE

In the event of abnormal power failure of the vehicle, the parking brake fault warning lamp (P) on the combination instrument turns on after it is powered on again. In this case, the system needs to self-learn. Pull up the EPB switch first, then depress the brake pedal and press the EPB switch to

release the EPB normally.

AVH function



C54DF885B16C

Automatic parking (AVH) eliminates the need for the driver to step on the brake pedal for extended periods or apply the electronic parking brake frequently when the vehicle is on a slope, is at a red light or is moving and stopped. It allows the driver to drive more comfortably and reduces the risk of vehicle rolling.

After the driver's door is closed, the driver's seat belt is fastened, and the vehicle is started, press the AVH switch to turn on or off the automatic parking function.

How to use

1. Turn on the AVH function. At this time, the automatic parking function is in the ready state, and the (P) AVH indicator on the combination instrument turns yellow.
2. Depress the brake pedal to stop the vehicle. At this time, the vehicle will automatically apply the parking braking. At this time, the automatic parking function is in operation, and the

Ⓐ AVH indicator on the combination instrument turns green.

3. The parking brake will be released automatically when the accelerator pedal is depressed, with the gear in D or R position.

If the accelerator pedal is not depressed for a long time, the automatic parking function will be deactivated, and the vehicle will automatically switch to the electric parking mode, thus applying the braking force.

The following conditions will de-activate the AVH function:

- › When the driver's side seat belt is released.
- › Open the door at driver's side.
- › Switch the power supply to LOCK mode
- › It works for more than 3 minutes.

i NOTICE

If the system detects that the vehicle is sliding when the AVH function is in operation, it will actively increase the brake pressure to keep the vehicle in a stationary state. In this case, sound and vibration will be heard.

⚠ CAUTION

In the case of automatic vehicle washing, towing, etc., turn off the AVH function.

Automatic departure function

When the vehicle is applied with the parking brake, and the driver is wearing the seat belt and stepping on the accelerator pedal, which allows the system to detect the driver's intention to leave, the parking brake will be automatically released.

On a slope, more traction is required to avoid rolling away.

Transmission

Vehicle equipment

Please note that this manual contains all the standard equipment, country-specific equipment and special equipment for this model series. Thus, some equipment or features described in this manual may not be installed onto your vehicle or are only available in some markets. For further configuration information, please refer to relevant sales information or consult with your distributor selling the vehicle to you.

Introduction to gear position

Reverse gear (R)

The R gear is used for reversing.

Neutral (N) gear

It is used when starting or parking the vehicle, and attention shall be paid to vehicle rollaway.

⚠ WARNING

- › Make sure to apply the parking braking or depress the brake pedal when stopping temporarily with the N gear engaged; otherwise, the vehicle may slip and cause an accident.
- › Vehicles are prohibited from sliding with the N gear engaged; otherwise, there is a risk of accidents.

Automatic mode (D)

The D gear is used for normal driving.

How to shift

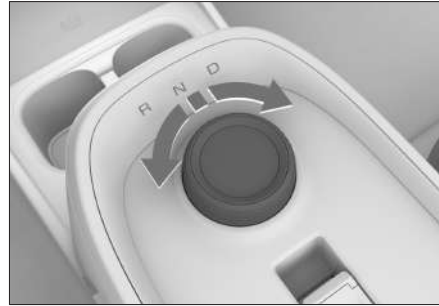

03BAE3AC513D

After starting the vehicle (indicator **READY** on the instrument turns on), step on the braking pedal and turn the knob can shift the gear.

- › Before the start of the vehicle you should always step on the brake pedal; otherwise the vehicle will move if the driving gear of the shift lever has been engaged.
- › When the vehicle is at a standstill, depress the brake pedal to engage in R or D gear
- › Depress the brake pedal to engage in N when the vehicle from moving to standstill.

i NOTICE

- › The engaged gear will be shown on the shift panel and the information center of the combination instrument. When the shift is completed, make sure that the desired gear is switched.
- › When the vehicle speed is lower than 2 km/h, unfasten the seatbelt at

driver's side and open the door at driver's side, the vehicle will be shifted to gear N automatically.

Creep function

After the vehicle is started (the driving status indicator **READY** is on), you should switch to the driving position, release the parking brake and the brake pedal. At this time, you don't need to step on the accelerator pedal, and the vehicle can crawl slowly.

i NOTICE

Depending on different vehicle models, the creep functions of certain vehicle models can be activated when opening the personalized driving mode through multimedia display screen and the creeping function of personalized driving mode is in on mode.

Start the vehicle

How to move off normally

1. Fasten the seat belt and confirm that the parking brake has been applied.
2. Depress the brake pedal and start the vehicle (the **READY** indicator is illuminated).
3. Switch the transmission gear to the **D** position.
4. Release the brake pedal and then gently step on the accelerator pedal to allow the vehicle to accelerate.

i NOTICE

When the vehicle starts, the automatic DDA function will automatically release the parking brake.

Launch control

1. Fasten the seat belt and confirm that the parking brake has been applied. Then start the vehicle (the **READY** indicator is illuminated).
Confirm that the power battery is no less than 40% (power displayed on the SOC indicator is no less than five grids), then switch the driving mode to sport mode and confirm ESC function is closed.
2. Press down the brake pedal by left foot and switch the gear to "**D**" position. At this point, fully press the accelerator pedal by right foot. Then the instrument will prompt "launch control activated".
3. After the brake pedal is released, the vehicle starts to launch until the vehicle is started.

! WARNING

- › Be sure to drive carefully within the limits permitted by law.
- › The launch control function can only be activated in place where have no crossing vehicle flow or pedestrian. It is drivers' obligation to ensure that the driving mode and acceleration will not threaten or impede others'

safety.

- › The function cannot be used when the vehicle runs on slippery roads. Otherwise, the vehicle will get out of control and cause an accident.

CAUTION

If the vehicle remains braking in 3 s after activating the launch control function, the vehicle will exit launch control function and enable the time-out protection to protect the motor system. When the vehicle is in time-out state, it is necessary to release accelerator pedal before disabling the time-out state for the next launch control.

NOTICE

The launch control function may not be normally activated because of the temperature of the power battery.

Stop the vehicle

1. After releasing the accelerator pedal, depress the brake pedal.
2. After the vehicle is parked steadily, switch to N gear.
3. Applying parking brake

NOTICE

When you unfasten the seatbelt at driver's side and open the door at driver's side, the vehicle can applying parking brake automatically.

4. Release the brake pedal.

CAUTION

- › When a temporary stop is required on a slope, the brake pedal must be stepped on or the parking brake must be applied, and the accelerator pedal or the crawling function must not be used to prevent the vehicle from rolling.
- › When stopping the vehicle on a slope, block the wheels with something if necessary to prevent rolling.

Vehicle equipment

Please note that this manual contains all the standard equipment, country-specific equipment and special equipment for this model series. Thus, some equipment or features described in this manual may not be installed onto your vehicle or are only available in some markets. For further configuration information, please refer to relevant sales information or consult with your distributor selling the vehicle to you.

Switching method



E84E1B0C68D1

Press the button to select AUTO mode, standard mode, ECO mode or sports mode.

AUTO

The vehicle will switch the standard mode, ECO mode and sports mode depending on the driver's driving habit, the vehicle state and road state.

STD mode

The vehicle will choose the best driving mode according to the current driving

conditions and the dynamic property and economy of the vehicle.

ECO mode

It delivers optimal energy consumption economy, with fuel consumption reduction and comfort as the primary goal, and is suitable for medium- and low-speed road conditions.

Sport mode

With strong dynamic response capability, it can meet the driving needs of high-speed and overtaking conditions and bring a higher level of driving experience.

The air condition automatic restriction function can be activated or deactivated via **【Energy consumption assistant】** on the multimedia display screen, when selecting ECO mode.

Personalized driving mode

The personalized driving mode can be activated through **【Energy consumption assistant】** interface on the multimedia display screen. After the personalized driving mode is activated, the following items can be set depending on requirement.

- › Energy recovery intensity
 - The percentage of energy recovery intensity
- › Speed limit adjustment
 - Set maximum cruise control speed
- › The sensitivity of the accelerating

pedal

Set the sensitivity of the accelerating pedal.

› Creep function

You can turn on or turn off the creep function. After the vehicle is started (the **READY** drive indicator is on), you should switch to the driving position, and release the parking brake and the brake pedal. At this time, you don't need to step on the accelerator pedal, and the vehicle can drive slowly.

i NOTICE

Depending on vehicle configuration, this function may not be provided for certain models. Please refer to the actual vehicle.

Vehicle equipment

Please note that this manual contains all the standard equipment, country-specific equipment and special equipment for this model series. Thus, some equipment or features described in this manual may not be installed onto your vehicle or are only available in some markets. For further configuration information, please refer to relevant sales information or consult with your distributor selling the vehicle to you.

Super power-saving mode

The super power-saving mode (ECO+ mode) can reduce the unnecessary power consumption and increase mileage. The ECO+ mode can be activated or deactivated through **【Energy consumption assistant】** interface on the multimedia display screen.

i NOTICE

- › This mode cannot be switched if the vehicle speed exceeds 60 km/h.
- › Under ECO+ mode, the vehicle speed should be limited below 86 km/h.

Single pedal mode

2

Driving

Vehicle equipment

Please note that this manual contains all the standard equipment, country-specific equipment and special equipment for this model series. Thus, some equipment or features described in this manual may not be installed onto your vehicle or are only available in some markets. For further configuration information, please refer to relevant sales information or consult with your distributor selling the vehicle to you.

One-pedal mode

The one-pedal mode can be activated or deactivated through **【Energy consumption assistant】** interface on the multimedia display screen, when the vehicle is in stationary.

i NOTICE

- › It is not recommended to activate or deactivate OPD mode when the vehicle is running.
- › In daily driving, maintaining steady acceleration or deceleration will help increase the vehicle's driving range.

OPD mode allows the vehicle to accelerate, coast, decelerate, and come to a full stop while the driver only needs to depress, lift foot off and fully release the accelerator pedal. Meeting the various normal driving requirements, it is operated flexibly and easily and can be used to improve the range significantly.

⚠ WARNING

- › The speed reduction caused by one-pedal driving mode cannot replace normal braking completely. In case of emergency, please step on the brake pedal in time.
- › If the vehicle stops after applying the one-pedal mode, it is strictly forbidden for the driver to leave the vehicle without any operation.
- › The OPD mode is not applicable to long-term parking. If you want to park for a long time, engage into N gear and apply the parking brake.
- › It is not recommended to use the one-pedal driving mode under snow, ice or slippery road conditions.

How to use

When the one-pedal mode is turned on and the gear is in the position "D", the accelerator pedal can be depressed, raised and completely released for accelerating, sliding, decelerating, and stopping completely.

The following conditions may cause the one-pedal driving mode to be turned off or malfunction.

- › When the battery capacity is too high or too low.
- › The temperature of the power battery is too high or too low.
- › The temperature of the drive motor is too high.

- › When ESC is activated.
- › The driving mode is switched in standard, ECO, sports mode.

After the vehicle stops by applying the one-pedal mode, the vehicle can enter crawling state through the following operations:

- › Shift to R gear.
- › Deactivate OPD mode.
- › After disengagement from D gear, re-engage into D gear.

CAUTION

- › The one-pedal driving mode allows the vehicle to slow down and stop by invoking energy recovery. A vehicle can stop on most paved roads, but the deceleration effect will be affected by slope gradient and vehicle load. Therefore, drivers shall always be prepared for braking.
- › When the one-pedal mode is activated with the power battery in high power, the instrument will indicate that the power level is high and the one-pedal function may be limited. Meanwhile, the deceleration effects of the vehicle will be affected to a certain extent, the driver should make preparation for braking.
- › When the gradient is too high or the vehicle is in trouble, please step on the brake pedal in time to prevent the vehicle from slipping.

NOTICE

When the vehicle is braked to stop in one-pedal mode, the EPB will be automatically applied after a few seconds.

Voice prompt system

Vehicle equipment

Please note that this manual contains all the standard equipment, country-specific equipment and special equipment for this model series. Thus, some equipment or features described in this manual may not be installed onto your vehicle or are only available in some markets. For further configuration information, please refer to relevant sales information or consult with your distributor selling the vehicle to you.

How to use

When the vehicle is running at a low speed, the voice prompt system will issue audible prompt tone to pedestrians and vehicles to improve driving safety.

Every time the vehicle is started (the indicator **READY** is on), the voice prompt system is turned on by default.

VSG can be activated or deactivated through the **【Energy consumption assistant】** interface on the multimedia display screen. After the system is activated, you can select the voice of the voice prompt.

After turning on the system, a prompt tone of the system will sound if any following condition is met:

- › The vehicle is moving forward and the speed is less than or equal to 30 km/h.
- › For reversing:

i NOTICE

- › In places where pedestrians may appear, the voice prompt system cannot be turned off. Otherwise, pedestrians cannot hear the prompt tone of the voice prompt system and will fail to notice that a vehicle is approaching, which may cause traffic accident, serious injury or even death.
- › The pause switch of the voice prompt system can only be used when there are no other road users within a short distance, and the prompt tone is not in need for surroundings.

Vehicle equipment

Please note that this manual contains all the standard equipment, country-specific equipment and special equipment for this model series. Thus, some equipment or features described in this manual may not be installed onto your vehicle or are only available in some markets. For further configuration information, please refer to relevant sales information or consult with your distributor selling the vehicle to you.

Switching method

Separate switching: after opening the door and powering on the vehicle, the power-steering mode, including light, comfort and sport, can be switched via the **【Vehicle Settings】** → **【In-Car】** → **【Driving Control】** on the multimedia display screen.

Linkage switch: when switching the driving mode, the power-steering mode will also be linked:

Driving mode	Power-steering mode
Economic mode	Light
Standard mode	Comfort
Sport mode	Sport
AUTO Mode	Comfort
Personalized mode	Comfort
Super power-saving mode	Light
Single pedal mode	Comfort

i NOTICE

Due to the different vehicle configurations, the power-steering mode of some vehicles cannot realize linkage switch with the changing of the driving mode. Please refer to the actual vehicle for details.

i NOTICE

When switching to power-steering mode, the following conditions need to be met:

- › The electric steering power system is functioning correctly.
- › The speed of the vehicle is less than 120 km/h.
- › No apparent steering operation has been carried out.

Light

Increase steering power and easy steering. It is applicable to traffic congestion driving environment such as urban areas.

Comfort

Applicable to general driving habits.

Sport

Reduce steering power and increase steering wheel feedback. It is recommended to use under high speed, rain and snow and other cases.

Parking assist system

Vehicle equipment

Please note that this manual contains all the standard equipment, country-specific equipment and special equipment for this model series. Thus, some equipment or features described in this manual may not be installed onto your vehicle or are only available in some markets. For further configuration information, please refer to relevant sales information or consult with your distributor selling the vehicle to you.

- › Do not tap the camera and sensor.
- › Do not flush the camera and sensor with a high-pressure water gun in the front. Otherwise, water may result in system failure or fire.
- › Do not use wearing or sharp material to clean the camera and sensor. Please wipe with a soft cloth or wash with water (low water pressure) to clean the surface of camera and sensor.

2

Driving

Tips for safety

WARNING

- › The parking assist system is only an auxiliary tool, which cannot replace the driver's judgment on external conditions. In any case, the driver shall be responsible for the safety of the vehicle and observe the surrounding conditions of the vehicle at any time during parking or similar operations.
- › There are blind spots in the parking assist system, and obstacles in some areas may not be detected. Therefore, during parking or similar operations, please make sure that there are no children or animals near the vehicle.

CAUTION

- › When reversing, make sure that the back door is completely closed.

NOTICE

The radar detection device of the parking assist system is affected by ultrasonic characteristics. Incapability or poor detection may be caused under the following circumstances, which are not system failures:

- › The obstacles are tiny objects such as barbed wire, fence, post and rope.
- › When the surface of the obstacle does not reflect detection signals and the obstacle is a person wearing such clothes.
- › When the obstacle is snow, cotton or other substances of which the surface can easily absorb sound waves.
- › When the obstacle is an acute-angle reflector or cone shaped;
- › When driving through grass or over rough terrain.
- › The driver reverses the vehicle on a slope.

- › There are ultrasonic noises with the same frequency around, such as metal noise, high-pressure gas emission noise, and horn sensor buzzing.
- › The license plate is bent or tilted, or a large license plate decorative frame is installed.
- › When the sensor is covered by foreign matters.

In order to ensure the normal operation of the system, the sensor must be kept clean and free of snow and ice.

Reverse radar

System introduction

The reverse radar is a radar-detection device. When the user is reversing, the sensor installed will work to detect obstacles that are present behind the vehicle, as well as the distance between the vehicle and that obstacle. The system will provide the driver with audio prompts to help the driver park as easily and safely as possible, and to avoid collisions.

How to use

Vehicle not equipped with AVM

- › Switch to gear R and the reverse radar will automatically turn on.
- › When the R gear is exited, the reverse radar will automatically turn off.

Vehicle equipped with AVM

The method of turning on and off is the

same as that of the AVM.

Detection scope and alarm mode

Sensor position	Detection scope [m]
Rear on both sides	0.6
Rear center	1.5

If the sensor detects an obstacle within the detection scope after the reverse radar is turned on, the alarm will start.

When the distance between the vehicle and the obstacle reduces, the frequency of alarm sounds will gradually increase. When the distance between the obstacle and the vehicle is within about 0.3 m, the alarm sound will be heard for a long time, and the vehicle shall not be reversed to avoid collision.

Anti-collision radar

System introduction

An anti-collision radar is a radar detection device. During parking, sensors are used to detect whether there are obstacles in front of and behind the vehicle, detect the distance of obstacles, and prompt with sounds to assist the drivers to park safely and easily.

How to use

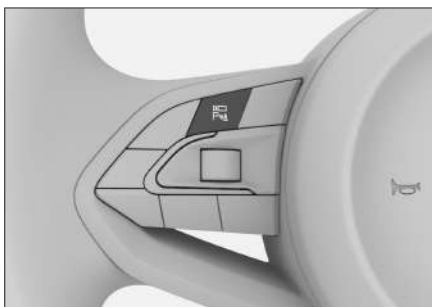

- › When the ignition switch is in ON mode, the anti-collision radar can be opened or closed manually by pressing the button.
- › Switch to the gear R and the anti-collision radar will automatically turn on.
- › If the moving speed exceeds 15 km/h, the anti-collision radar will be automatically stopped.

Detection scope and alarm mode

Radar sensor position	Detection scope [m]
Front on both sides	0.6
Front center	1.0
Rear on both sides	0.6
Rear center	1.5

After the anti-collision radar is started, if the sensor identifies obstacles within the detection range, it will start to give an alarm.

When the distance between the vehicle and the obstacle reduces, the frequency of alarm sounds will gradually increase.

When the distance between the obstacle and the vehicle is within about 0.3 m, the alarm sound will be heard for a long time, and the vehicle shall not be reversed to avoid collision.

Reverse camera

About the system

The reverse camera captures images from behind the vehicle using the rear view camera and transmits the image signal to the screen for display, thereby assisting the driver to safely and easily park the vehicle.

How to use

- › Switch to gear R and reverse camera will automatically turn on.
After the reverse camera system is turned on, you can select various view modes according to personal habits.
- › Exit gear R and the reverse camera will automatically turn off.

Dynamic guide line

The dynamic guide line can display the width of the vehicle body and calculate the movement track of the vehicle according to the turn angle of the steering wheel as well as assist the driver in parking the vehicle.

Panoramic surround-view image

About the system

Around view monitor uses four cameras to capture images surrounding the vehicle and sends a video signal to the display screen for display. This helps the driver to safely and easily drive while avoiding accidents.

How to use

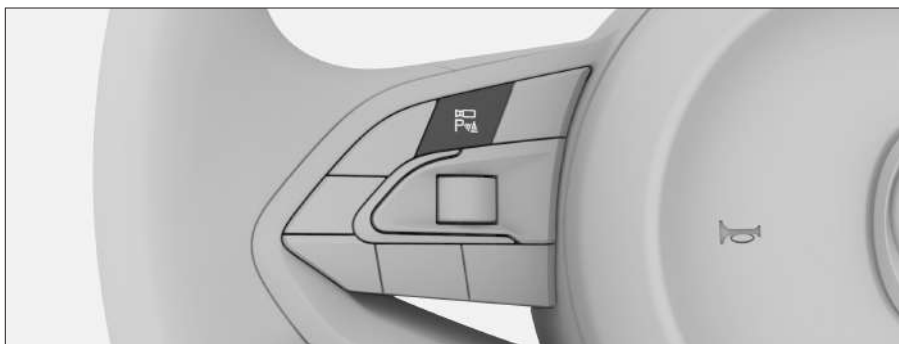

A0A9EA3B745B

- › After the the power supply is in the ON position or the vehicle is started, press the button to turn on or off the AVM.
- › Shift to gear R and automatically start the AVM.
- › The AVM will be turned off automatically when the vehicle moves forward at a speed greater than the setting value.

Camera interface

Vehicle not equipped with fully automatic integrated parking system



450F361FA2D1

Vehicle equipped with fully automatic integrated parking system



2

Driving

- Ⓐ Function setting area
- Ⓑ Top view area
- Ⓒ Image area
- Ⓓ View identification

In 2D view mode, it indicates the orientation of the current view

Function setting

↶ : Back button

Tap the back button to return to the previous interface. Tap the back button on the main interface to exit the image interface.

⊞ : Switch-driving-mode button

Tap the button to switch the view mode between 2D and 3D.

🔍 : View switch button

Tap the button to switch the view mode between normal mode, wide view mode and wheel mode.

📏 : Lane auxiliary line setting button

You can switch the display mode of the assist line by repeatedly touching the assist line setting button. When set to display mode, the guidance line displays the body width, which can assist the driver in parking.

i NOTICE

Considering different vehicle model configurations, this button is located under the system setting menu for certain models.

MOD: Moving object detection

You can activate or deactivate the detect function of the moving object. After the function is activated, when a moving pedestrian is detected, the image interface will display an alarm message.

NOTICE

Considering different vehicle model configurations, this button is located under the system setting menu for certain models.

: Vehicle washing station mode

Touch the button to enable or disable the washing station mode. After the washing station mode is enabled, the tyre's forward track will be displayed, and the line width indicates the tyre width.

: Fully automatic parking button(▷ Page 120)

【Reverse assist】 button:(▷ Page 122)

: System settings

Touch the setting button to set the setting system. The following items can be set on the system interface.

› Intelligent view switch

You can activate or deactivate the intelligent view switch function. After the function is activated:

When the vehicle is in gear D, if the front radar detects an obstacle less than or equal to 1m from the vehicle body, it will automatically switch to the front top image.

When the vehicle is in gear R, if the rear radar detects an obstacle less than or equal to 1m from the vehicle body, it will automatically switch to the rear top image.

It will automatically switch to the previous image after the obstruction is removed.

› Car Model Color

The color of the vehicle model can be changed.

› Car Model Transparency

In the 3D view mode, touch the car model transparency settings button to change the model transparency.

When the vehicle model transparency is selected as 100%, the vehicle bottom

transparency function will be activated.

After the vehicle bottom transparency function is activated, the image interface will gradually display the image of the road under the vehicle as the vehicle moves.

› Radar Display

Touch the radar display setting button repeatedly to change the radar display mode. After the setting is shown and when an obstacle is detected, a radar identification will be shown in the obstacle direction.

2

Driving

View switch

Automatic view switch

When D gear is engaged, it will automatically switch to the front view image; when R gear is engaged, it will automatically switch to the rear view image; in D gear, turn on the left turn signal lamp and the image area will be automatically switched to the left front wheel image, or turn on the right turn signal lamp and the image area will be automatically switched to the right front wheel image.

Manual view switch

When the speed of the vehicle is less than 10 km/h, you can switch the perspective manually.

In 2D mode, you can touch the surrounding area of the vehicles in the top view to switch to the related view image where the area is located.

When the 3D mode is turned on, tap the top view area, then the top view will display the multi-directional buttons. Tap to select the button indicating each direction, then the image area will display the view image corresponding to this button.

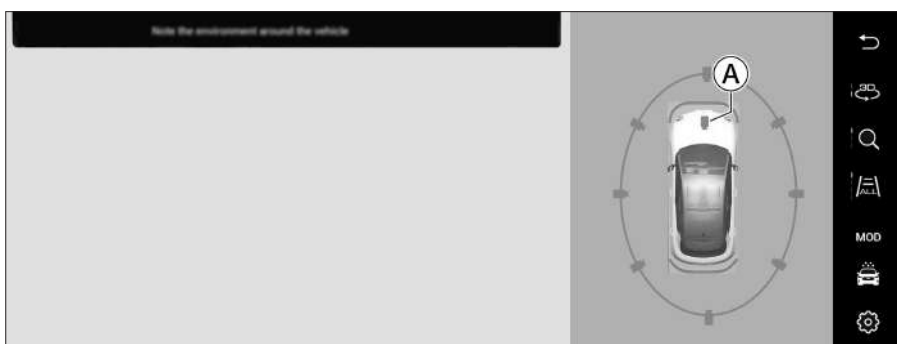

60DA38DF374C

Ⓐ Engine compartment transparent view button

In 3D view mode, tap the transparent view button of the engine compartment, then

the image interface will gradually display the image of the road under the engine compartment as the vehicle runs.

2

Driving

Fully automatic integrated parking system

System introduction

Based on the around view images and the anti-collision radar system, the fully automatic integrated parking system uses radar sensors and cameras to detect vehicle surrounding obstacles, parking lines and other information to identify suitable parking slots and automatically control the vehicle to complete steering, shifting, and braking operations. The driver only needs to drive the vehicle into and out of the parking slot by following the system prompts.

During the parking process, if moving obstacles such as pedestrians or vehicles are detected and there is a risk of collision, the system will automatically perform emergency braking to quickly complete vehicle braking; if a fixed obstacle is detected and there is a risk of collision, the system will perform comfortable braking to achieve smooth braking of the vehicle.

WARNING

The fully automatic integrated parking system is only an auxiliary tool and cannot replace the driver's judgement on the external situation. During the parking process, the driver should observe the surrounding situation and parking prompt information in real time, and emergency control or

necessary measures are required in case of special circumstances to ensure safety.

How to use

In the AVM interface, tap the automatic parking button  to activate the automatic integrated parking system. Automatic parking is completed by following the prompts displayed on the multimedia display screen when the system is activated.

CAUTION

In order to ensure the parking safety, the driver needs to monitor the surrounding environment of the vehicle at any time, to brake and take over the vehicle in time when there is a collision risk.

NOTICE

- › The parking-out function can only be used when the vehicle is stationary.
- › In the process of searching for parking space, please make sure to keep a proper distance (about 0.5~1.5 m) from vehicles or obstacles on both sides. Otherwise, the system may not be able to identify the parking space.

Precautions

During automatic parking process, the following operations may cause temporary interruption of automatic parking.

Automatic parking can be resumed when the interruption disappears.

- › Open the vehicle doors (including the back door).
- › Folding the outside rearview mirror.
- › When the driver's side seat belt is released.
- › Obstacles appear on the parking path.
- › Interfering with the accelerator pedal.

During automatic parking process, the following operations may cause automatic parking to exit.

- › The vehicle speed exceeds 30 km/h in the process of searching for parking space.
- › Interfering with the gear position, steering wheel or parking brake.
- › Recoverable interruption beyond time limit, number of interruptions beyond limit, number of parking movements beyond limit, and total parking time beyond time limit.
- › Touch the auto parking button \mathbb{P} .
- › When exiting from the parking space, if it judges that there is no travel direction or the road is clear, there is no need to use automatic parking function.
- › The slope of the ground where the vehicle is located is too large.

According to the restriction of location and environment factors, the expected functions may not be achieved in some special situations. The following

situations are just examples and do not include all special situations:

- › Parking space line cannot be clearly identified due to the influence of the surrounding environment, for example, the parking line is polluted or covered by massive garbage, weeds, mud, etc., or the surrounding light source has low illumination, and the surface of the parking space has a large reflectivity.
- › The parking space has raised ground and the opposite parking line cannot be detected.
- › There are pits on the ground of the parking space.
- › The front or rear vehicle is too close to the unoccupied parking space, or occupies part of the unoccupied parking space.
- › There are pedestrians or other obstacles in the parking space.
- › Pedestrians and other obstacles stay near the camera when the vehicle is stationary.
- › Previous parking line can be seen in the parking space.
- › Parking space is located in a corner or a curve.
- › Heavy wear of the vehicle tyres or installation of unapproved tyres (including non-full-size spare tyres).
- › When parking on grassy or bumpy roads.

- › There are ultrasonic noises with the same frequency around, such as metal noise, high-pressure gas emission noise, and horn sensor buzzing.
- › The sensor is smudged or covered.
- › Heavy fog, rain or snow.

Cases in which automatic integrated parking assist is forbidden:

- › Tyre chains or spare tyres are installed.
- › The loaded objects exceed the vehicle size.
- › A tow hook is installed.
- › The slope of the ground where the vehicle is located is too large.

Reversing assist

About the system

When the vehicle is running in D gear at a speed lower than or equal to 30 km/h, the system will record the last 50 m route in real time. When the reversing assist function is initiated, the system will control the steering wheel, brakes and vehicle speed so that the vehicle can automatically complete reversing in accordance with the recorded route.

In the process of reversing, if pedestrians, vehicles, and other non-fixed obstacles are detected and there is a risk of collision, the system will automatically perform emergency braking to quickly complete vehicle braking.

i NOTICE

As a result of mechanical deviation, tyre pressure and other factors that affect the system's control accuracy, there will be a certain deviation in the reversing path, thus return along the original path cannot be ensured.

⚠ WARNING

The reversing assist function is only an auxiliary tool and cannot replace the driver's judgment on the external situation. During the reversing process, the driver should observe the surrounding situation and reversing prompt information in real time, and emergency control or other necessary measures are required in case of special circumstances to ensure safety.

How to use

In the around view interface, touch the **【Reversing auxiliary line】** button to activate the reversing assist function. Automatic reversing is completed by following the prompts displayed on the multimedia display screen when the function is enabled.

Precautions

When the following situations occur, the system will stop and the recorded route will be cleared:

- › The vehicle speed exceeds 30 km/h.
- › The vehicle powers off abnormally.

- › The turning angle of the steering wheel is too large (about 450°).
- › The automatic reversing deviates from the recorded route by about 1m.

During reversing, the following conditions will cause the reversing assist function to be interrupted or exited:

- › Touch the **【Reverse assistant】** button.
- › Interfere the gear, steering wheel, parking brake or accelerate pedal.
- › Release the driver's side seat belt.
- › Open the vehicle doors (including the back door).
- › Fold the rearview mirror.
- › The system detects that the vehicle cannot continue driving.
- › Obstacles are detected on the driving track.

i NOTICE

After interruption and exiting due to non-system failure, turn on the reversing assist function again, and the system can control the vehicle to complete reversing along the remaining path.

Parking settings

Through the **【Vehicle Settings】** → **【Parking】** interface on the multimedia display screen, you can set the related functions of the parking assist system. Refer to the actual vehicle for specific

setting items.

› **【Automatic front radar activation】**

You can turn on or turn off the automatic activation function of front radar.

After the function is enabled, if the moving speed is less than 10 km/h and there is an obstacle detected within the detection range, the front radar and image system will be started automatically. The system will be automatically turned off if with a few seconds the distance of the obstacle does not change, the obstacle is far away, or the vehicle is applying the parking brake.

› **【Low speed emergency braking】**

You can turn on or turn off the low speed emergency braking function.

After the function is activated, when the vehicle is running at a low speed, the low speed emergency braking indicator  on the image interface will be illuminated in green, which indicates that the function is normally activated. If an obstacle is detected during low speed driving and a collision risk is determined, the system will automatically apply emergency braking to reduce the risk of a collision. At this moment, the indicator turns red.

! CAUTION

- › The function is only an auxiliary one, which cannot guarantee that all obstacles are detected under all

conditions.

› Under complex road conditions (such as off-road conditions or narrow passages), please turn off the low-speed emergency braking function. Otherwise, the system may apply unnecessary braking.

› Please turn off the low-speed emergency braking function after the vehicle is equipped with traction devices or when the vehicle is towing other vehicles. Otherwise, the system may apply unnecessary braking.

› **【Flank protection SDW】**

You can turn on or turn off the flank protection function.

After the function is enabled and when the sensors on the left and right sides of the vehicle body identify obstacles, the system prompts the driver to park carefully through pictures and sound alarms.

› **【Steering signal on intelligently】**

You can turn on or turn off automatic turning function.

After the function is activated, set to D gear and turn on the turn signal lamp or turn the steering wheel to a certain angle, then the AVM will be automatically turned on. After the steering wheel is restored, the AVM will be automatically turned off when the turn signal lamp is off or the vehicle speed exceeds a certain value.

› **【Look around and exit speed setting】**

The speed for exiting AVM mode can be set.

The AVM will be turned off automatically when the vehicle speed exceeds a certain value.

› **【Road calibration】**

During the using of vehicle, when the camera position changes due to bumping of vehicles or aging of parts, the image mosaic may be misplaced, blurred and distorted. At this time, the image mosaic effect can be optimized through the lane calibration setting.

Please refer to the prompt information on the multimedia display screen for the specific calibration methods and requirements.

› **【Restore factory calibration】**

After re-calibrating the road, you can restore the factory calibration by pressing the “restore factory setting”.

【Worry-free car use】

【Intelligent pre-cooling】

You can activate or deactivate the intelligent view switch function. After the function is activated, the pre-cooling can be set through applications in mobile phone so that the vehicle can get proper temperature before using and improve user experience.

Tyre pressure monitoring system

Vehicle equipment

Please note that this manual contains all the standard equipment, country-specific equipment and special equipment for this model series. Thus, some equipment or features described in this manual may not be installed onto your vehicle or are only available in some markets. For further configuration information, please refer to relevant sales information or consult with your distributor selling the vehicle to you.

System introduction

The tyre pressure monitoring system (TPMS) monitors tyre pressure and temperature in real time and alerts the driver to take appropriate action to avoid an accident when an abnormality occurs in the tyre.

i NOTICE

The communication equipment complies with NBTC standards or technical requirements.

! CAUTION

- › If the tyre replaced is not a standard spare tyre, it may affect the normal operation of TPMS.
- › TPMS may not work properly when the tyre chain is installed or the wheel is covered.
- › TPMS may not work properly due to radio interference.

- › After replacement of tyres or tyre rotation, start the vehicle and drive at a speed higher than 30 km/h for about 9 minutes, then the TPMS will automatically learn the tyre pressure, tyre temperature and location. If the tyre pressure is not displayed or displayed incorrectly after 9 minutes, please contact service provider to reset TPMS as soon as possible.
- › TPMS cannot replace regular tyre maintenance. Check the tyre frequently to ensure proper tyre pressure, even if no alarm is received from TPMS.
- › Tyre pressure can be affected by factors such as the heat generated from vehicle operations, the external environment, journey time, etc. Under normal conditions, the tyre pressure fluctuates around 30 kPa, which is normal.

Monitoring function

Press the steering wheel button to switch the driving data interface of instrument to the tyre pressure monitoring interface, on which you can view the pressure and temperature information of the four tyres in use in real time.
(▷ Page 156)

When the tyre pressure is too low or the temperature is too high, the abnormal tyre icon on the tyre pressure monitoring interface shows red and flashes.

Alarm function

When the tyre pressure is too low or the temperature is too high, the combination instrument will send out the following alarm as follows:

- › The multi-information display will display the corresponding alarm interface. The abnormal tyre icon is displayed as red and sends out audible alarm.
- › Tyre pressure monitoring system warning lamp (⚠) on the combination instrument illuminates.

If the tyre alarm message appears in the trip, you should avoid performing sudden, acute turns and emergency braking. Reduce the speed, drive to a safe area and stop the vehicle as soon as possible. Then contact service provider for trouble handling.

Vehicle equipment

Please note that this manual contains all the standard equipment, country-specific equipment and special equipment for this model series. Thus, some equipment or features described in this manual may not be installed onto your vehicle or are only available in some markets. For further configuration information, please refer to relevant sales information or consult with your distributor selling the vehicle to you.

System introduction

While driving at high speed on straight, smooth highways, the cruise control system allows the user to keep the vehicle at a certain speed without stepping on the accelerator pedal for extended periods of time.

WARNING

- › The cruise control system is an auxiliary tool and cannot take the place of the driver in judging the road and traffic conditions nor the driver's driving. In any case, the driver should be responsible for the safety of the vehicle and always concentrate on driving carefully.
- › In order to avoid operating the cruise control system by mistake, if you do not use it, turn the cruise control system off.
- › Incorrect use of the cruise control system can lead to the collision

accidents.

- › You should only use the cruise control system when there is good weather and the vehicle is traveling on straight highway.
- › Using cruise control system in urban areas, on meandering roads, on wet and slippery roads, or in other adverse weather conditions is not recommended.
- › Do not use the cruise control system when traveling on slopes. The system cannot maintain a set speed while the vehicle is traveling uphill or downhill.
- › The driver must not leave his or her seat when the cruise control system is activated.
- › When the cruise control system is in operation and you want to speed down quickly, press brake pedal as usual.

How to use

NOTICE

Since cruise control system is designed for vehicles driving on highway and other roads with good conditions, the cruise speed should be within the range of 40 to 125 km/h.

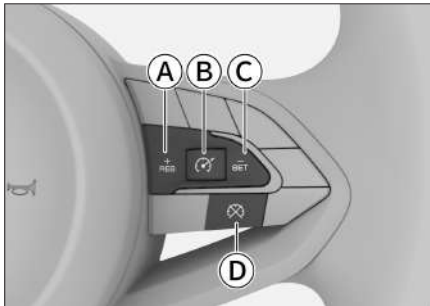

- Ⓐ Restore speed setting/acceleration button
- Ⓑ ON/OFF button
- Ⓒ Speed setting/deceleration button
- Ⓓ Set speed release button

Turning on the system

1. Press the button to light up the CCS indicator on the combination instrument, indicating that the cruise control system has been turned on.
2. Adjust to the required speed, then press the button. The current speed is set and the vehicle is running at this speed. The cruise speed setting information will be displayed on the multi-information display of the combination instrument.

Increasing cruising speed

There are three methods to increase the set speed:

- › Press the button to increase the speed.
- › Press and hold the button to increase the speed continuously.
- › Step on the accelerator pedal to

accelerate to the desired speed, and press button to set a new speed.

Reduce the cruise speed

There are three ways to reduce the cruise speed:

- › Press the button to reduce the speed.
- › Press the button to reduce the speed continuously.
- › Step on the brake pedal to reduce the vehicle to the required speed, and then press the button to set a new speed.

Accelerating temporarily

To accelerate temporarily during vehicle speed setting, depress the accelerator pedal. After accelerating, you can release the accelerator pedal to resume the previously set speed.

Cancel the cruise speed

There are two ways to release the set speed:

- › Step on the brake pedal.
- › Press the set speed release button on the steering wheel.



When the set speed is canceled, the system does not turn off and the CCS indicator on the combination instrument remains illuminated.

Restore the set speed

When you have canceled cruise speed, the system does not turn off. When the

speed meets the system requirements, pressing  button will automatically return to the speed set before it was canceled. The cruise setting information will be shown again in the information center.

Turning off the system

Press the  button to close the cruise control system and cancel the previously set speed and the  indicator on the combination instrument will go out.

Cruise assist system

Vehicle equipment

Please note that this manual contains all the standard equipment, country-specific equipment and special equipment for this model series. Thus, some equipment or features described in this manual may not be installed onto your vehicle or are only available in some markets. For further configuration information, please refer to relevant sales information or consult with your distributor selling the vehicle to you.

System introduction

While driving at high speed on straight, smooth highways, the cruise assist system allows the user to keep the vehicle at a certain speed without stepping on the accelerator pedal. When the system detects that the driving speed of preceding vehicles is less than the cruise speed set by your vehicle, the vehicle will follow the preceding vehicle at a set safe distance.

Vehicles equipped with the TJA mode can also keep driving in the middle of the lanes while cruising.

WARNING

- › The cruise assist system is only an auxiliary tool and is not a substitute for the driver's judgment of road and traffic conditions, nor it can replace the driver's driving. In any case, the driver should be responsible for the safety of the vehicle and always

concentrate on driving carefully.

- › When cruise assist system is not in use, turn it off to avoid incorrect operation.
- › Incorrect use of cruise assist system may result in a crash.
- › The cruise assist system can only be used when driving on a clear road in good weather conditions.
- › The cruise assist system is not recommended for use in conditions such as urban areas, winding roads, narrow roads, wet and slippery roads, heavy rain or other harsh weather conditions.
- › When driving on a slope, the cruise assist system is not recommended, based on the following points:
The cruise assist system cannot maintain the set speed when driving up and down the slope.
After a preceding vehicle has passed the top or bottom of a slope, the cruise assist system may not detect the preceding vehicle, causing sudden acceleration or late braking.

Combination instrument display

NOTICE

Due to different vehicle configurations or different instrument themes, the graphics displayed on the combination instrument are for reference only,

please refer to the actual vehicle.

How to use

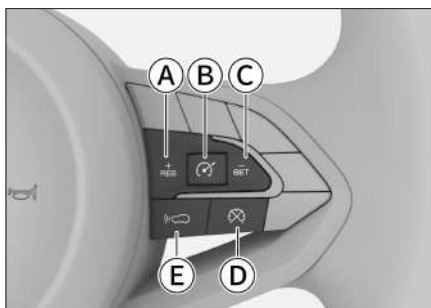

Ⓐ Distance level

The distance level is not a fixed distance, and it is the actual distance between the vehicle and the front vehicle. The actual distance between the vehicle and the front vehicle will vary with the vehicle speed of the vehicle under the same distance level.

Ⓑ Set the speed

Ⓒ Following distance display

When the system detects the presence of a vehicle ahead, it will determine the degree of danger of the current following distance based on the speed of the vehicle, and display it in different colors.

Ⓓ Lane line

Ⓐ Restore speed setting/acceleration button



Ⓑ ON/OFF button

Ⓒ Speed setting/deceleration button



Ⓓ Set speed release button

Ⓔ Distance level adjustment button

Turning on the system



After the engine is started, press the button  on the steering wheel repeatedly, the system can switch from the adaptive cruise assist mode () , intelligent cruise assist mode () or to turn off (OFF).

i NOTICE

- › If the  adaptive cruise control indicator (white) on the combination instrument turns on, it indicates that the adaptive cruise assist mode has been activated.
- › If the  intelligent cruise assist indicator (white) on the combination instrument turns on, it indicates that the intelligent cruise assist mode has

been activated.

Set the cruise speed

Press the **SET** button to set the vehicle speed. After the vehicle speed is successfully set, the  adaptive cruise control system indicator or  intelligent cruise assist indicator on the combination instrument turns from white to green.

The minimum set speed of the cruise assist system is 30 km/h.

i NOTICE

When the adaptive cruise assist mode is activated, the following basic conditions must be met before the cruise speed can be set:

- › All doors are completely closed.
- › The driver wears the seat belt correctly.
- › The vehicle is started and D gear is engaged in.
- › ESC is activated.
- › No parking brake is applied.
- › The vehicle speed is less than 120 km/h.
- › The vehicle driving mode is in the standard, ECO or sport mode.

When the intelligent cruise assist mode is activated, the following basic conditions must be met before the cruise speed can be set:

- › All doors are completely closed.

- › The driver wears the seat belt correctly.
- › The vehicle is started and D gear is engaged in.
- › ESC is activated.
- › No parking brake is applied.
- › The vehicle speed is less than 120 km/h.
- › The system detects a lane boundary.
- › If the vehicle speed is less than 60 km/h and there is no lane boundary, it is necessary to detect a moving target.
- › The vehicle driving mode is in the standard, ECO or sport mode.

Increasing cruising speed

There are three methods to increase the set speed:

- › Press the **RES** button to increase the speed.
- › Press and hold the **RES** button to increase the speed continuously.
- › Step on the accelerator pedal to accelerate to the desired speed, and press **SET** button to set a new speed.

i NOTICE

Only when the road ahead is unjammed will the vehicle be accelerated to the set speed. Otherwise, the vehicle will follow the front vehicle to drive at the set distance level.

Reduce the cruise speed

There are three ways to reduce the cruise speed:

- › Press the **SET** button to reduce the speed.
- › Press and hold the **SET** button to reduce the speed continuously.
- › Step on the brake pedal to reduce the vehicle to the required speed, and then press the **SET** button to set a new speed.

Accelerating temporarily

To accelerate temporarily during vehicle speed setting, depress the accelerator pedal. After accelerating, you can release the accelerator pedal to resume the previously set speed.

Adjust the distance level

Press the distance level adjustment button on the steering wheel to adjust the following distance to the front vehicle.

WARNING

Setting a low distance level may result in a delay in reaction in the event of unexpected situations, and it is always your responsibility to adjust the distance level appropriately.

NOTICE

- › The distance level is not a fixed distance, and the actual distance between the vehicle and the front vehicle will vary with the vehicle speed of



the vehicle.

- › Select a higher distance level when driving on wet and slippery roads than when driving on dry roads.

Cancel the cruise speed

There are two ways to release the set speed:

- › Step on the brake pedal.
- › Press the set speed release button on the steering wheel.

After the set speed is canceled, the system is not turned off, and the  adaptive cruise control indicator or  intelligent cruise assist indicator on the combination instrument turns from green to white.

NOTICE

The set speed will be automatically released under any of the following circumstance:

- › Depress the accelerator pedal to accelerate the driving speed for more than 15 minutes.
- › The N or R gear is engaged.
- › When the driver's side seat belt is released.
- › Open the door at driver's side.
- › Applying parking brake
- › The anti-lock brake system (ABS) is activated.
- › The hill decent control system is activated.

- › The electronic stability control system is activated/deactivated.
- › The vehicle slides backwards.
- › The brake disk is overheated.
- › Shutting down the vehicle.
- › The vehicle driving mode is not in the standard, ECO or sport mode.

Restore the set speed

When you have canceled cruise speed, the system does not turn off. When the speed meets the system requirements, pressing  button will automatically return to the speed set before it was canceled. The cruise setting information will be shown again in the information center.

Turning off the system

Press the  button can close the system and cancel the previously set speed. At this time the indicator on the combination instrument will go out.

Queuing auxiliary function

This function enables the vehicle to follow another vehicle within the speed range of 0~120 km/h.

In the event of traffic congestion, the vehicle can be slowed down to a stop following the preceding vehicle. At this point:

- › If the preceding vehicle leaves within 3 s, the vehicle will automatically follow the preceding vehicle.

- › If the preceding vehicle stops for a long time (3 s -3 min), press the button of resuming speed setting/acceleration or lightly step on the the accelerator pedal to restart the system.
- › If the preceding vehicle is parked for more than 3 minutes, the vehicle will automatically apply the parking brake.
- › If the driver opens the door or releases the seat belt, the vehicle will automatically apply the parking brake.

NOTICE

This function will be turned off at the same time if the set cruising speed is canceled or the cruise assist system is turned off.

Curve road auxiliary function

When cruise assist system is enabled, if the vehicle is entering a curve road at too high speed, the curve road auxiliary function will reduce the vehicle speed appropriately.

WARNING

- › When entering and exiting a curve road or driving in a curve road, the system may not detect the vehicle in front of the same lane in a timely manner, in which case the vehicle may be braked too late, and the driver must be careful and ready to control the vehicle.

- › When driving around a curve road, the system may incorrectly detect vehicles in other lanes, causing unnecessary braking.
- › When driving on a sharp turn road (for example, a serpentine road), if the vehicle in front exits the sensor detection scope, the vehicle may suddenly accelerate, and the driver must be cautious and ready to manipulate the vehicle.

Lane center keeping function during cruising

This feature is only available in TJA mode, which assists the driver in keeping the vehicle in the middle of the lane boundary when the system is operating and the sensor detects a lane boundary or a moving vehicle ahead.

i NOTICE

- › This feature is not available in adaptive cruise control mode.
- › This function is canceled at the same time when the set cruise speed is canceled.

! CAUTION

In some cases, the lane center keeping function may not work properly or not work during cruising. For example:

- › Cruise at a speed higher than 60 km/h (including), there are no lane lines, lane lines at both sides are

blurred, and the non-standard lane boundaries or lane boundaries are covered.

- › Cruise at a speed below 60 km/h, there are no lane lines or the lane lines on both sides are blurred, the non-standard lane boundaries or the lane boundaries are covered, and there is no vehicle running directly in front.
- › There is an object on the road that affects the identification of the lane boundaries (such as water, gaps, ruts, text signs, bumps or pits).
- › Low visibility (such as rain, snow, fog and night etc.).
- › The vehicle is strongly affected by the side wind.
- › The lanes merge or separate.
- › A strong light hits the camera or the light intensity changes abruptly.
- › The front windshield around the camera is polluted, frozen, damaged or covered.
- › Vehicles are running on a sharp turn or a narrow road.
- › If the vehicle is driving too close to the preceding vehicle, the camera detection scope is hindered.

Functional limitations

Under the following conditions, the cruise assist system may not take the braking measures:

- › A vehicle suddenly appears in front of you.
- › A vehicle is running at a low speed in front of you when you are driving at a speed of over 60 km/h.
- › An oncoming vehicle is running in the same lane.
- › A vehicle or object crossing the lane is seen.
- › Pedestrians or animals and small vehicles (such as bicycles and motorcycles) are seen.
- › The vehicle in front of decelerates suddenly.
- › Water, snow or mud splashed by surrounding vehicles hinders the sensor detection.
- › The vehicle head tilts up due to overload in the luggage area.
- › The vehicle is running on a winding or narrow road.

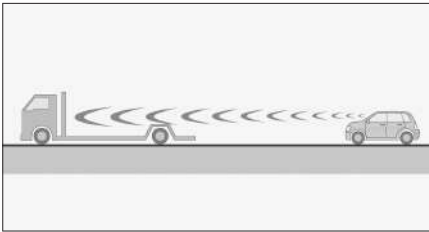

706CBE4C4337

- › The followed vehicle has a relatively small tail dimension or very large ground clearance.
- › The steering wheel operation is unstable or your position in the lane is unstable.

Sensor

The cruise assist system identifies lane boundaries and detects targets based on the following components.

- › Camera.

The camera is located on the upper part of the front windshield.

- › Sensor.

Sensors are located on both sides of the rear bumper.

i NOTICE

When the instrument indicates that the system sensor detection is limited, check that the camera, sensor, and surrounding area are clean and clear of obstructions to ensure proper system operation.

Vehicle equipment

Please note that this manual contains all the standard equipment, country-specific equipment and special equipment for this model series. Thus, some equipment or features described in this manual may not be installed onto your vehicle or are only available in some markets. For the further configuration information, please refer to relevant sales information or consult with your distributor selling the vehicle to you.

How to use

After starting the vehicle, Intellidrive setting interface can be entered via 【Vehicle Settings】 → 【Driving】 on the multimedia display screen to turn on or off the corresponding functions.

Sensor

IntelliDrive assist system identifies lane boundaries and detects targets through the following components.

› Camera.

The camera is located on the upper part of the front windshield.

› Sensor.

Sensors are located on both sides of the rear bumper.

i NOTICE

When the instrument indicates that the system sensor detection is limited, check that the camera, sensor, and surrounding area are clean and clear of obstructions to ensure proper system operation.

i NOTICE

1. The communication equipment complies with NBTC standards or technical requirements.
2. The communication equipment has an electromagnetic field intensity that complies with the *Safety Standards for the Use of Radio Communication Equipment for Human Health* published by the National Telecommunications Commission.

Forward assist system

The forward assist system identifies vehicles on the lane via a camera on the front windshield. When the risk of collision ahead is detected, an alarm will be issued or brake intervention will be performed to mitigate the consequences of the accident.

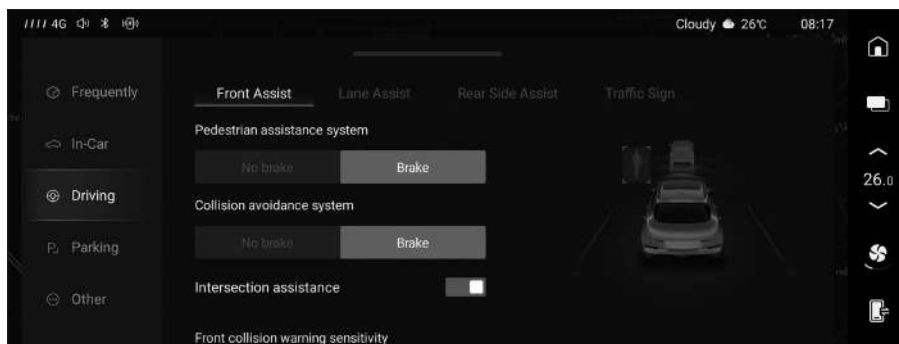

⚠ WARNING

The normal operation of the system cannot be guaranteed in all circumstances. Therefore, it is prohibited to drive the vehicle toward a pedestrian, animal or other vehicle for the purpose of testing the system, which could cause serious injury or death.

In complex driving conditions, the system may apply unnecessary braking. For example, at construction sites and railroad tracks, or when there are sprays or splashes of water in front of the vehicle.

This system may not work normally or even not work in low visibility conditions (such as rain, snow, haze, night, etc.).

Pedestrian/crash safety assist

Pedestrian safety assist : it can detect passengers and cyclists.

Crash safety assist : it can detect most vehicles stationary or driving in the same direction as your vehicle (such as passenger cars, trucks and buses etc).

- › **【No brake】** : the function is turned off.
- › **【Brak】** : the braking assistant function will be activated.

Braking assist

When the vehicle speed exceeds 30 km/h and the system detects that there is collision risk for pedestrians or vehicles, it will give an alarm to prompt the driver to drive

safely. There are 2 alarm levels: sound alarm (pre-alarm), short brake alarm (emergency alarm).

In case of emergency, if the driver does not make braking response, the system will control the vehicle to automatically perform emergency braking (limited braking), and the left and right turn signals will flash quickly to remind the rear vehicle, so as to reduce the collision risk.

i NOTICE

- › At low vehicle speeds, this function may slow the vehicle to a standstill, but will not keep the vehicle stationary. At this point, the driver shall apply the brake actively.
- › This function requires the driver to apply more force to the brake pedal during the automatic braking process.
- › If the driver steps on the accelerator pedal or takes steering intervention during the automatic emergency braking, the system may disengage the automatic emergency braking.

i NOTICE

- › If the vehicle speed exceeds 65 km/h and the system determines that the distance between your vehicle and the preceding vehicle is too short, the combination instrument will show the prompt message of "please keep a safe distance".
- › When cruise assist system is working, the safe distance alert function is blocked.
- › When the light is low, the detection range will be affected, so please turn on the headlamp when driving at night.

Detecting the target

i NOTICE

For valid targets identified by the system, the system may not always achieve the same level of performance, depending on vehicle, pedestrian, scene, road conditions.

- › The cyclist must be an adult and the bicycle must be designed for an adult.
The system can only work best when it detects clear information about the body and the contour of the bicycle, which means that the system needs to clearly identify contour information such as the bike, head, arm, shoulder, thigh, and the

normal cycling of the person.

- › The system detects pedestrians in contrast to the background (e.g., the color of the pedestrian clothing is contrasting with the color of the surrounding environment). If the contrast is low, the pedestrian will be detected later or not at all, meaning that warnings and braking will lag or be unable to achieve.

The system can only work best when it detects clear information about the shape of the body, which means that the system needs to clearly identify information about the head, arm, shoulder, thigh, etc. of the person and the normal walking pattern of the person.

Intersection assist

When the vehicle speed is lower than 20 km/h, and the vehicle turns around at an intersection, if an oncoming vehicle or a pedestrian is detected and there is a risk of collision, the system will apply brake.

The system can detect pedestrians and vehicles driving in the opposite direction as your vehicle, such as passenger cars, trucks, buses, etc. When the light is low, the detection range will be affected, so please turn on the headlamp when driving at night.

Front crash warning sensitivity

Sensitivity is divided into three levels.

- › Standard: it indicates that the distance at alarm time is normal as defined by the system.
- › Low: it indicates that the distance at alarm time is close.
- › High: it indicates that the distance at alarm time is far.

Lane assist system

The lane assist system is designed for vehicles driving on highway and other roads in good condition, which can identify lane boundaries via a camera on the front windshield and alert the driver unaware of lane deviation to correct the route, and even assist the driver to correct direction to mitigate accident consequences with some of its functions.

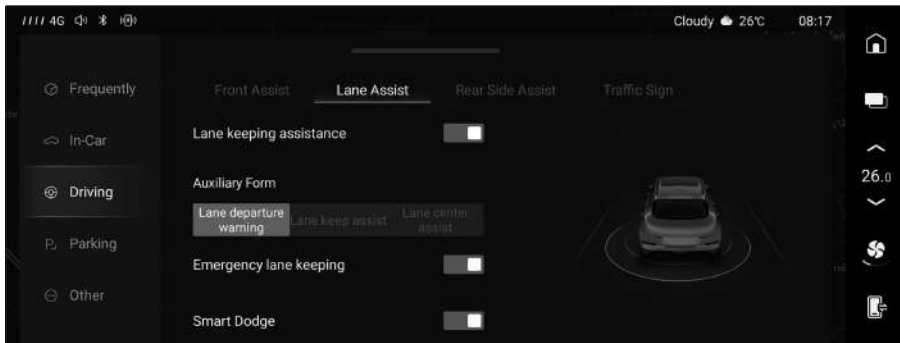

8872BCF059C1

2

Driving

⚠ WARNING

- › The lane assist system is an auxiliary tool and cannot take the place of the driver in judging the road and traffic conditions nor the driver's driving. In any case, the driver should be responsible for the safety of the vehicle and always concentrate on driving carefully.
- › The driver must always keep his hands on the steering wheel and ready to turn at any time. The driver is always responsible for keeping the vehicle in the safe lane.

⚠ CAUTION

The lane assist system properly works only when the lane boundary is clearly visible. In some cases, it may not operate normally nor work. For example:

- › The lane boundary may not be recognized clearly. Or it is a non-standard or covered lane boundary.
- › There are objects on the road that affect the identification of lane boundaries (e.g. water, cracks, ruts, signs, crosswalks, bump and bit etc.).
- › Low visibility (such as rain, snow, fog and night etc.).
- › The vehicle is strongly affected by the side wind.
- › The lanes merge or separate.
- › A strong light hits the camera or the light intensity changes abruptly.
- › The front windshield around the camera is polluted, frozen, damaged or covered.
- › When the vehicle is driving on a sharp turn, narrow road;
- › If the vehicle is driving too close to the preceding vehicle, the camera detection scope is hindered.

i NOTICE

If you turn on the turn signal lamp, turn the steering wheel, operate the accelerator pedal or brake pedal before passing through a lane boundary, the system will not send an alarm. In this case, the system thinks you are taking the initiative to drive the vehicle.

i NOTICE

When the driver controls the steering wheel with a small force, the system may not detect the driver's hand holding the steering wheel, and the combination instrument will send an alarm message.

Lane keeping assistance

When the lane assist function is turned on, the assist type can be selected.

- › Lane departure warning: It can warn the driver to drive safely when the driver is unaware of lane deviation.
- › Lane keep assist: It can assist the driver to correct the steering wheel to keep the vehicle in the lane when the driver is unaware of lane deviation. If the correction fails, it will give out alarm in order to alert the driver to drive safely.
- › Lane center assist: It can assist the driver to correct the steering wheel to control the vehicle to drive in the center of the current lane. If the correction fails or the vehicle is off the current lane, an alarm is given out to alert the driver to driving safely.

i NOTICE

The lane assist function can only work when the vehicle speed is within 60 ~ 150 km/h.

When the lane assist function is turned on, the lane boundaries will be displayed on the combination instrument.

- › Grey: It indicates that the system fails to detect a lane boundary.
- › Green: It indicates that the system detects a lane boundary.
- › Red and flashing: It indicates that the system is alarming, and the driver needs to correct the direction in time to make the vehicle return to the lane.

i NOTICE

The lane center assist functions only when the system identifies the lane boundaries on the left and right sides.

Emergency lane keeping

When the emergency lane keeping is turned on, the system will more actively correct the steering wheel in case of an emergency to reduce the risk of collision. For example: When the driver is unaware of lane deviation or turns on the turn signal lamp and is about to change lanes, there is a risk of collision with the oncoming vehicle in the adjacent lane or a vehicle from the rear in the same direction, or there is a curb or a pit outside the lane.

i NOTICE

The emergency lane keeping functions only when the vehicle speed is within 60-150 km/h.

! WARNING

In some cases, the urgent lane keeping function may not work properly or not work. For instance,

- › For smaller targets (motorcycles, bicycles, etc.).
- › For stationary targets.
- › The current vehicle is driving too close to the preceding vehicle to prevent the camera from detecting it.
- › The rear vehicle is driving too close to the current vehicle to prevent the sensor from detecting it.

Smart dodge

After the smart dodge function is turned on, if the lane assist or intelligent cruise is turned on and in working condition, when the system identifies that the vehicle is about to overtake the adjacent large vehicles (wagon, truck, bus, etc.), it will control the vehicle to move slightly away from the large vehicle. After overtaking the large vehicle, your vehicle will return to the central area of the current lane.

i NOTICE

The smart doge function will not begin to work until the vehicle speed reaches 60 - 150 km/h.

⚠ CAUTION

The following situations may not trigger the smart dodge function:

- › When the system identifies that there is a large vehicle on the adjacent road on one side, and there are vehicles on the adjacent road on the other side or the road is a curb.
- › In severe weather such as night, heavy fog, rain and snow.
- › When the vehicle is in a curve.

Early warning mode

There are three warning modes: sound, vibration, and sound + vibration.

Early warning sensitivity

Sensitivity is divided into three levels: low, standard and high.

Rear side assist system

The rear side assist system can detect vehicles behind the vehicle or in the adjacent lane through sensors on both sides of the rear bumper. If there is a risk of collision, the system will issue an alarm to remind the driver to drive safely.

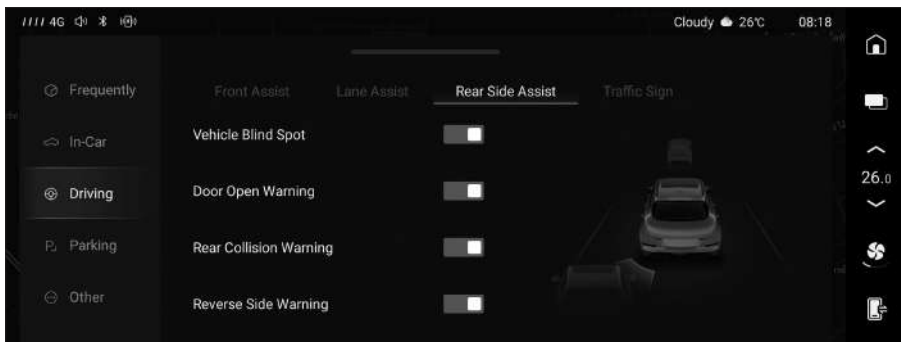

3EBFC707477E

i NOTICE

- › Keep both sides of the rear bumper clean, and do not paste any object and have any ice, snow, mud and other foreign coverage, so as not to affect the normal

work of the sensor.

- › Improper repair or modification of the vehicle may cause the sensors to be dislocated, which may affect the proper operation of the rear side assist system. Therefore, it is recommended that you maintain and repair your vehicle at service provider.
- › Turn off the rear side assist system when towing other vehicles.

Warning lamp

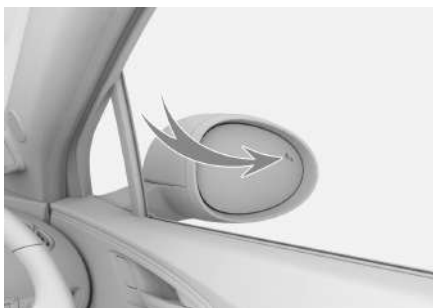

The warning lamps are located on the surfaces of the left and right outside rearview mirrors.

⚠ WARNING

Do not paste any objects on the warning lamps to avoid affecting the system's alarm function.

Vehicle blind spot

During driving (above 15 km/h), the warning lamp on the appropriate side will turn on when the system detects a vehicle in the blind spot of the outside rearview mirror or an approaching vehicle behind on adjacent lane. If you turn on the turn signal lamp at the same side at this time, the warning lamp turns to flash and an audible alarm is accompanied, which indicates that there is danger if continuing to change the lane.

⚠ WARNING

In some cases, the parallel line assist function may not work properly or not work. For example:

- › For fast approaching or departing vehicles.

- › For smaller targets (pedestrians and bicycles etc.).
- › For stationary targets (vehicles and pedestrians etc.).
- › Driving in bad conditions such as rain and snow etc.
- › When driving on a sharp bend, sloping road, wide or narrow lane.

Door open warning

When the system detects that there are approaching vehicles and bicycles and other targets in the adjacent lanes on both sides after the vehicle stops and there is a risk of collision when the car door is opened, the alarm lamp at corresponding side shall be lighted up. If the occupants continue to open the door at this time, the warning lamp will flash with an audible alarm, prompting you that it is dangerous to continue to open the door.

NOTICE

- › The door open warning system will only function if:
Start the vehicle.
Press the power off switch within 2 minutes.
- › The door open warning function is not available when towing other vehicles.

WARNING

In some cases, the door open warning function may not work properly or not work. For example:

- › For fast approaching or departing vehicles.
- › For smaller targets (pedestrian etc.).
- › For stationary targets (vehicles and pedestrians etc.).
- › In harsh environments such as rain, snow, etc.
- › On sharp turns, slopes, very wide or narrow lanes.

Rear collision warning

When the system detects a vehicle, bicycle or other target that is approaching quickly and there is a risk of collision, the left and right turn signal lamps flash rapidly and the warning of "Attention: Behind Vehicle High Speed" is displayed on the instrument to alert the driver, accompanied by an audible alarm, indicating a danger to the vehicle and rear target.

⚠ WARNING

In some cases, the rear collision warning function may not work properly or not work. For instance,

- › The rear vehicle is approaching, and the relative speed of both vehicles is too high or too low.
- › For smaller targets (pedestrian etc.).
- › For stationary targets (vehicles and pedestrians etc.).
- › In harsh environments such as rain, snow, etc.
- › On sharp turns, slopes, very wide or narrow lanes.

Reversing side warning

When the reversing side warning function is enabled, if during reversing the system detects that there is a risk of collision with a moving vehicle in the blind area of the outside rearview mirror, it will give an alarm to remind the driver to drive safely.

Reversing side brake

When the rear cross traffic brake function is enabled, limited braking can be applied when there is a risk in reversing, reducing the risk of collision.

i NOTICE

When the vehicle is started and R gear is engaged, the reverse side assist function is active.

⚠ WARNING

In some cases, the reverse side assist function may not work properly or not work. For instance,

- › For fast approaching or departing vehicles.
- › For smaller targets (pedestrians and bicycles etc.).
- › For stationary targets (vehicles and pedestrians etc.).
- › Driving in bad conditions such as rain and snow etc.
- › When driving on a sharp bend, sloping road, wide or narrow lane.

⚠ WARNING

In some cases, the reverse side braking function may not work properly or not

work. For instance,

- › The current vehicle speed is too high or too low.
- › The driver steps on the accelerator pedal firmly.
- › The driver turns the steering wheel quickly.

Traffic sign information

The traffic sign information function is used to recognize the traffic signs through the camera on the front windshield and display them on the combination instrument to give a prompt to the driver.

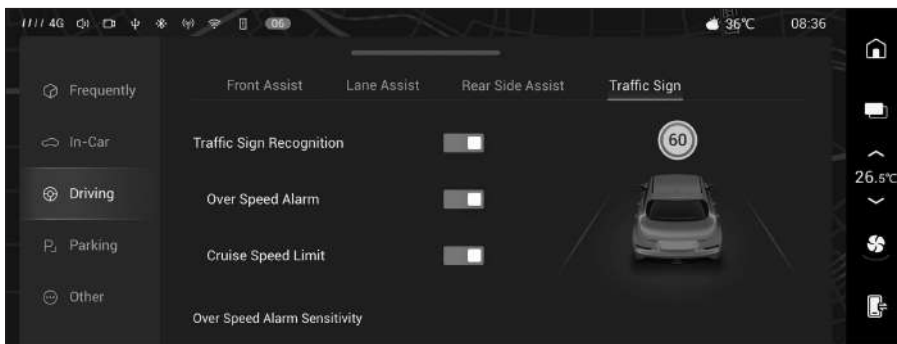

3140CC15E442

Traffic sign recognition

The traffic signs are recognized by the camera on the front windshield and displayed on the combination instrument to prompt the driver.

Over speed alarm

After the speed limit sign is recognized, in case of overspeed, the system will give an alarm to remind the driver to reduce the speed to a suitable range as soon as possible.

Cruis speed limit

After the traffic sign recognition function is enabled, the cruising speed limit function can be enabled.

When the vehicle is running in a cruise control mode, if the system recognizes a speed limit sign showing the speed is ≥ 30 km/h and the cruising speed is higher than the speed limit of the sign, the system will remind the driver if the vehicle speed should be limited in accordance with the current limited value. After confirmation, the system will assist the driver to reduce the vehicle speed to be within the allowable maximum speed limit.

Over speed alarm sensitivity

The alarm timing for overspeed can be set according to your driving habits.

- › 0: Alarm will be issued when the vehicle speed reaches the speed limit.
- › > 0: Alarm will be issued only when the vehicle speed exceeds the speed limit.
- › < 0: Alarm will be issued in advance when the vehicle speed does not reach the speed limit.

WARNING

The traffic sign information function is designed to alert the driver to traffic signs and is not intended to be used in all cases and is not a substitute for the driver's judgment on road speed limit messages.

In all cases, the driver is responsible for the safety of the vehicle and must always drive with care and comply with applicable laws and road traffic regulations.

CAUTION

Traffic sign information function works only when the speed sign is clearly visible. In some cases, it may not operate normally nor work. For example,

- › A sign fades.
- › A sign is on the bend.
- › A sign is placed with an improper angle.
- › A flag is rotating or has been damaged.
- › A sign is fully or partially blocked.
- › A sign is fully or partially covered by frost, snow, dust, etc.
- › A high-speed sign is placed in the position that is too far or too high.
- › A speed limit caution or sign is attached to the road surface.
- › Visibility is low (such as in rainy, snowy and smog days or at night).
- › The camera is illuminated by strong light or the illumination intensity changes suddenly.
- › The front windshield around the camera is polluted, damaged or covered.
- › The vehicle is running closely to the front vehicle, thus blocking the detection range of the camera.
- › The vehicle speed is too low.

i NOTICE

- › The speed limit sign identified by the system shows the default speed unit of xx km/h.
- › For multiple speed limit values on the same speed limit sign, the system will show the maximum value.
- › When multiple speed limit signs are arranged in parallel, the system will display the maximum speed limit value. Please take the actual speed limit value of the current lane as the criterion.
- › When the vehicle is turning, the speed sign may not be identified.

Vehicle equipment

Please note that this manual contains all the standard equipment, country-specific equipment and special equipment for this model series. Thus, some equipment or features described in this manual may not be installed onto your vehicle or are only available in some markets. For further configuration information, please refer to relevant sales information or consult with your distributor selling the vehicle to you.

Tips for safety

About traffic safety

Never take a risk in driving because the vehicle is equipped with driving assist systems and always ensure that the vehicle speed and driving style adapt to vision, weather, road and traffic conditions.

About modification

Suspension modification or use of tyres or wheels of non-specified size will impact driving assist systems and may cause system malfunctions.

About sound and vibration

- › Some driving assist systems (such as ABS) may create a vibration or make a sound during working, which does not indicate a malfunction.
- › When you jump start the vehicle due to battery power loss, the ABS or the ESC warning lamps may light up, which

is caused due to the low battery voltage, and it does not indicate that the ABS or the ESC is faulty.

Anti-lock brake system

When brake is applied or the vehicle is braked suddenly during driving on wet and slippery road, the anti-lock brake system (ABS) helps prevent wheels from locking to maintain steering control of the vehicle.

⚠ CAUTION

During emergency braking, do not step on the brake pedal several times and gently. Otherwise, it will lengthen the braking distance.

The ABS is not designed to shorten the braking distance of the vehicle. Especially in the following cases, compared with vehicles not equipped with the ABS, your vehicle may require a longer braking distance. Be sure to maintain adequate safe distance from the vehicle travelling in front:

- › When driving on muddy, gravel or snowy road.
- › When driving with tyre chains in place.
- › When driving on bumpy road.
- › When driving on potholes or uneven road.

The ABS may not work effectively in the following conditions:

- › When the limit of tyre grip

performance is exceeded (like using excessive wear tyre on snowy road).

- › When driving at a high speed on wet and slippery road.

Electronic braking force distribution system

The electronic braking force distribution (EBD) system is capable of automatically adjusting the front and rear braking force ratio to enhance braking efficiency. It complements the ABS for greater braking stability and thereby vehicle stability.

Braking force assist system

Stepping on brake pedal very quickly can trigger the braking force assist system to help increase the braking effect and shorten the braking distance during emergency braking.

Traction control system

When you start or accelerate on a wet and slippery road, the traction control system (TCS) helps keep a driving force and avoid driving wheel spinning.

HHC (Hill-start hold control)

When the driver starts on a slope and releases the brake pedal, the hill-start hold control (HHC) can maintain the braking force for about 2 seconds to effectively avoid rolling.

⚠ WARNING

When starting on a slope greater than 30%, the vehicle may still roll. Therefore, do not rely excessively on this feature. Please pay attention to the safety while driving.

Electronic power steering system

The electric power steering system can adjust the power in real time by monitoring the driving speed, so as to ensure the portability of low-speed steering and the stability of high-speed steering and enhance the sense of security.

Electronic stabilization program

Electronic stability control (ESC) can help reduce the risk of side slip, and improve driving stability by braking individual wheel under certain driving situation.

When ESC works, the  ESC indicator on the combination instrument flashes. Make sure to be careful at this time.

NOTICE

Generally speaking, ESC is on throughout the drive. The system can be turned off only under following special conditions:

- › When driving with tyre chains in place.
- › When driving in deep snow or on soft ground.

- › When the vehicle is stuck and you need to free it.

Turn on ESC again upon finishing of above conditions.

ON mode or the READY mode.



- › The vehicle speed exceeds 85 km/h.

Closing/opening method

Type 1



D90E79A80169

After the vehicle starts, press the  ESC OFF button. The  ESC OFF indicator on the combination instrument will light up, indicating that the system is shut down. Press the button again to restart the ESC system.

Type 2

The ESC can be activated or deactivated through the multimedia display screen **【In-Car】** → **【Driving control】** → **【Electronic stability program (ESP)】** switch. The  electronic stabilization program off indicator in the instrument turns on, indicating that the ESP is shut down.

NOTICE

The ESC will be automatically turned on in the following conditions:

- › Restart the vehicle power supply to

Virtual instrument

Vehicle equipment

Please note that this manual contains all the standard equipment, country-specific equipment and special equipment for this model series. Thus, some equipment or features described in this manual may not be installed onto your vehicle or are only available in some markets. For the further configuration information, please refer to relevant sales information or consult with your distributor selling the vehicle to you.

Summary

2

Driving

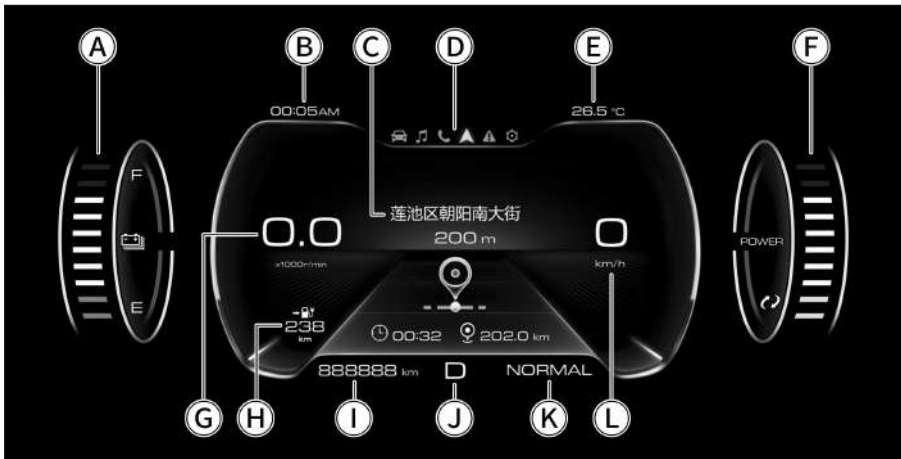

427B4DB464DC

- | | |
|--------------------------|-------------------------|
| Ⓐ Coulombmeter | Ⓔ Tachometer |
| Ⓑ Digital clock | Ⓕ Distance to empty |
| Ⓒ Information center | Ⓖ Mileage |
| Ⓓ Multi-function tab bar | Ⓗ Gear position display |
| Ⓔ Outside temperature | Ⓙ Driving mode |
| Ⓕ Power meter | Ⓚ Speedometer |

Coulbometer

It displays the approximate power battery level.

Power meter

It shows the power of the drive motor. The power meter is divided into green area, white area and red area. Their meanings are described as follows:

- › Green area: it shows the energy recycling power.
- › White area: it shows that the output power of the driving motor is normal.

- Red area: it shows that the the output power of the driving motor is too high and the energy consumption of the current driving status is great.

Tachometer

It shows the revolution speed of the drive motor.

Speedometer







It shows the driving speed of the vehicle.

Information center

Switch the displayed content through the multi-function tab bar.

Multi-function tab bar

Select different function tabs to switch the content displayed on the information center.

Tab	Meaning	Information center
	Driving data	It displays the vehicle speed, the energy consumption, mileage and other information which are related to vehicle operation.
	Audio media	It displays the audio media information that is currently playing.
	BT phone	It displays the information about the currently connected BT phone.
	Naviga- tion infor- mation	It shows the map and relative information about naviga- tion.
	Alarm messages	It displays the currently shielded primary alarm messages and the automatically hidden secondary alarm messages.
	Menu set- ting	The menu setting information can be displayed, and the in- strument can be set accordingly.

NOTICE

The audio media tab may be different based on the media source of the currently playing audio.

Steering wheel button

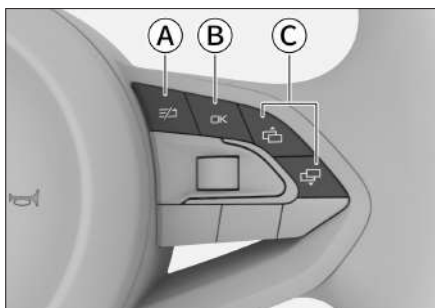

- Ⓐ Menu/ back button
- Ⓑ OK button
- Ⓒ Page-turn button

Menu/ back button

Press the button to return to the previous menu.

Press this button can circularly switch the functions of the multi-function tab bar if there is no previous menu.

OK button

Press this button to enter the next menu, confirm the current settings or shield the primary alarm messages currently shown.

Press and hold this button to temporarily shield all alarm messages currently shown or reset certain driving data interfaces.

Page-turn button

If multiple pages or options are displayed on the multi-information display, press this button to turn pages to view or switch options.

Driving data interface

Press the menu / back button on the steering wheel until the driving data tab is selected. At this time, the driving data interface will be showed in the information center.

Press the up button on or down button on the steering wheel to switch the driving data shown on the information center.

i NOTICE

The tripmeter, driving time, average speed will be displayed on data interface A and B.



- › The data interface A shows the driving data within the current power-on cycle. After the vehicle power supply is turned to the LOCK position for 4 hours, the data will be automatically reset.
- › On the data interface B, the driving data from the last manual reset until the current time is displayed.
- › Press the OK button on the steering wheel when the tripmeter, driving time or average vehicle speed is shown on the information center to switch between the data interface A and the data interface B.
- › Press the OK button on the steering wheel when the tripmeter, driving time or average vehicle speed is shown on the information center to manually reset the corresponding



data on the data interface A or B.

i NOTICE



- › The actual driving distance will vary from driving habits and road conditions.
- › When the warning lamp  on the combination instrument illuminates, you should charge the battery promptly even if the display shows that the vehicle can travel farther.

Audio media interface



Press the menu  / back button on the steering wheel until select the Audio media tab . At this time, the information center will show the media information that is currently playing.



Press the up button  or down button  on the steering wheel can cut the current music and broadcasting station.

Press the OK button on the steering wheel can open the playing list of the current audio source. At this moment, following operations can be done:



- › Press the up button  or down button  on the steering wheel can check playing list entry and switch the selected item.
- › Press the OK button on the steering wheel, and you can play the currently selected item.
- › Press the menu  / back button on the steering wheel to return to previous menu interface.



BT phone interface

Press the menu  / back button on the steering wheel until selecting the BT phone  tab. At this time, the multi-information display will show the call log information.



Press the up button  or down button  on the steering wheel can check call log entry and switch the selected item.



Navigation information interface

Press the menu  / back button on the steering wheel until selecting the navigation messages tab . At this time, the information center will show the navigation information.

Press the up button  or down button  on the steering wheel to switch between the vehicle head direction and navigation information interface.

Alarm information interface

Press the menu  / back button on the steering wheel until selecting the alarm messages tab . At this time, the multi-media display will show the alarm information that this vehicle has.

Press the up button  or down button  to view all the currently shielded primary alarm messages and the automatically hidden secondary alarm messages.

Most alarm messages are accompanied by a corresponding alarm indicator on

the combination instrument. When an alarm message is displayed, the corresponding alarm indicator also turns on. The alarm prompt message has priority over the driving data, so the alarm prompt message will be shown priorly. Please perform all and any operations strictly in accordance with instructions contained in alarm messages. If there are no relevant instructions available, please stop the vehicle for checks or contact service provider for assistance.

CAUTION

- › Do not ignore alarm prompt messages. Failure to heed alarm information can cause severe damage to the vehicle.
- › If an alarm indicator lights up, please stop the vehicle as soon as possible and contact service provider, while paying extra care to safe driving.

Important alarm messages

If there are multiple important alarm messages, they will be shown cyclically in turns. After an alarm condition is canceled, the corresponding alarm message will not be shown at the same time.



Pressing the **【OK】** button on the steering wheel can shield important alarm messages (pressing the button can shield the important alarm messages currently shown, while pressing and holding the button can shield all



important alarm messages), and  will be shown on the instrument cluster to remind you that the alarm messages have not been released.

Secondary alarm messages

The secondary alarm messages will disappear automatically after being shown for a few seconds. The  will be shown on the combination instrument to remind you that the alarm messages have not been released.

Menu setting interface



Press the menu  / back button on the steering wheel until selecting the menu setting tab . At this time, the information center will show the menu setting information.

Press the up button  or down button  on the steering wheel to scroll through the menu settings term by term.

Press the OK button on the steering wheel to enter the next menu or to confirm the current setting.

Overspeed settings

Press the OK button to enable or disable the overspeed alarm function.

After enabling the overspeed alarm function, press the up  or down  button to adjust the alarm speed.

When the driving speed reaches or exceeds the set value, a warning of overspeed will appear on the combination instrument to show an alert to drive

safely.

Theme settings

It can set the theme style of the instrument.

Color settings

It can set the color of the instrument.

Backlight settings

It can set the brightness of the backlight.

Driving data settings

You can set certain driving data on the information center to hidden or displayed.

The data including tripmeter, average fuel, journey time and average vehicle speed can be reset.

Unit setting

You can set the pressure unit and temperature unit.

Language settings

You can set the display language of the combination instrument.

Reset to Factory

Part of the menu settings of the combination instrument can be restored to the factory default state.

Maintenance check

You can check the mileage to the next maintenance.

This information is only used to remind you to maintain your vehicle in time.

Indicator lights on instrument panel

Vehicle equipment

Please note that this manual contains all the standard equipment, country-specific equipment and special equipment for this model series. Thus, some equipment or features described in this manual may not be installed onto your vehicle or are only available in some markets. For further configuration information, please refer to relevant sales information or consult with your distributor selling the vehicle to you.

Instrument indicator

NOTICE

- › When the vehicle power supply is switched to the ON mode, some indicators or warning lamps will light up for a short time. This indicates that the system is doing self-check, which is normal.
- › Due to different vehicle configuration, not all the indicators or warning lamps on the combination instrument will light up.



Primary alarm message indicator

It is illuminated to indicate that the vehicle currently has primary alarm message and at least one piece of primary alarm message has

been manually shielded.

WARNING

Do not ignore any alarm message. Otherwise, it may cause serious damage to the vehicle or an accident.

NOTICE

All current alarm messages of the vehicle can be checked on the alarm message interface of the instrument.



Secondary alarm message indicator

It illuminates to indicate that there are secondary alarm messages.

WARNING

Do not ignore any alarm message. Otherwise, it may cause serious damage to the vehicle or an accident.

NOTICE

- › The secondary alarm messages will be automatically shielded after being displayed on the multi-information display of the combination instrument for a few seconds.
- › All current alarm messages of the vehicle can be

checked on the alarm message interface of the instrument.



Turn signal indicator

When the left turn signal lamp is on, the left turn signal indicator will flash.

When the right turn signal lamp is on, the right turn signal indicator will flash.

When the emergency flashers are on, the turn signal indicator and all external turn signal lamps will flash in unison.

CAUTION

When the turn signal indicator flashes quickly, it usually means that the turn signal lamp has been damaged. Replace it as soon as possible. Otherwise, other drivers on the road will not be able to see your turn signals.



Light on indicator

It illuminates to indicate that the main lighting switch is ON.



Position indicator

It illuminates to indicate that the position lamp and the license-plate lamp are ON.



High beam lamp indicator

It illuminates to indicate that the high beam headlamps are turned on.



Indicator for automatic switching of high and low beams

This indicator illuminates in green to indicate that the automatic switching function of high and low beams is enabled.

This indicator illuminates in yellow to indicate that the automatic switching function of high and low beams failed. In this case, please manually turn on the high beam headlamp or low beam headlamp as needed, and drive the vehicle to service provider for inspection and repair as soon as possible.



Rear fog lamp indicator

It illuminates to indicate rear fog lamps are turned on.



Seat belt unfastened warning lamp

It illuminates to indicate that the driver, the front passenger or the rear passenger hasn't fastened the seat belt.



Vehicle door not closed warning lamp

It illuminates to indicate that

the door is open or not fully closed.



Airbag fault warning lamp

It illuminates to indicate that there is a malfunction in airbag system. At this point, go to service provider as soon as possible for inspection.



Tyre pressure monitoring system warning lamp

It illuminates to indicate that the tyre pressure is too low or the temperature is too high, accompanied by an audio prompt. At this time, please stop the vehicle for inspections and contact service provider.

After the lamp flashes for a period of time, it illuminates to indicate that the tyre pressure monitoring system fails, accompanied by several voice prompts.

WARNING

If this lamp illuminates, sharp turns or emergency braking shall be avoided, and the vehicle shall be parked at a safe place as soon as possible where inspection is performed.

Driving with low tyre pressure or high tyre temperature will

increase the possibility of tyre failure, and even cause serious damage to the vehicle or an accident.



Parking brake indicator

It illuminates to indicate that the parking brake has been engaged.

This indicator flashes to indicate that the brake disk temperature is too high or the pavement slope is too large. At this moment, please depress the brake pedal and park the vehicle on a smooth path as soon as possible, because there is a risk of sliding.



Parking brake fault warning lamp

It illuminates to indicate that there is an electronic parking brake malfunction.



AVH indicator

It illuminates in yellow to indicate that the AVH function is activated and ready for use.

It illuminates in green to indicate that the AVH function has been turned on and kept in working state.



Anti-lock brake system fault

warning lamp

It illuminates to indicate that there is a malfunction in anti-lock brake system. At this time, please contact service provider.

When this warning lamp lights up, the vehicle can still be braked normally although the anti-lock function is not available.

**Brake system fault warning lamp**

It illuminates to indicate that the brake fluid level is too low or there is a malfunction in the electronic braking force distribution system.

In this case, please immediately stop the vehicle in a safe spot and contact service provider. Otherwise, a serious accident is likely to occur.

**Electronic stability control indicator**

This indicator flashes to indicate that electronic stability control system is working.

It illuminates to indicate that electronic stability control system fails.

**Electronic stability control system OFF indicator**

It illuminates to indicate that electronic stability control system is off.

**Electric power steering system failure warning lamp**

It illuminates in yellow to indicate that the steering assist effect is reduced, and greater force is required to operate the steering wheel. If this lamp remains illuminated after the vehicle is restarted or after a short running distance, please drive the vehicle to service provider for inspection and repair as soon as possible.

It illuminates in red to indicate that the electric power steering system fails and the assisted power no longer exists. In this case, park the vehicle in a safe place and turn off the vehicle, then restart the vehicle within several minutes. If the indicator remains illuminated, please go to service provider for inspection and repair as soon as possible.

⚠ WARNING

It illuminates in red to

indicate that the electric power steering system will stop operation. At this time, you need stronger power to operate the steering wheel to realize steering function. Please timely head to service provider for inspection and maintenance.



Cruise control indicator

When the indicator is on, it indicates that the cruise control function is enabled.



Adaptive cruise indicator

When the indicator is on and gives off white light, it indicates that the adaptive cruise control function is activated and ready for use.

This indicator illuminates in green to indicate that the adaptive cruise function is activated and the cruise speed is set successfully.



Warning lamp for adaptive cruise system faults

It illuminates to indicate that something is wrong with the adaptive cruise control system. In this case, do not use the adaptive cruise function, and go to service provider as soon as possible for inspection.



Intelligent cruise control indicator

When the indicator is on and gives off white light, it indicates that the intelligent cruise control function is activated and ready for use.

This indicator illuminates in green to indicate that the TJA function is activated and the cruise speed is set successfully.

When this indicator is on and gives off red light, it indicates a fault in the intelligent cruise control assist system. In this case, do not use the smart cruise assist function, and go to service provider as soon as possible for inspection.



Rear side assist system warning lamp

This lamp illuminates in yellow to indicate that the sensor of the rear side assist system is blocked. In this case, please check whether there are objects covering the inner/outer surface of each side of the rear bumper. If any, please remove them right away.

This lamp illuminates in red to indicate that something is

wrong with the rear side assist system. In this case, do not use the rear side assist system, and go to service provider as soon as possible for inspection.



Parallel line assist function indicator

It illuminates to indicate that the blind spot monitoring is enabled.



Reverse side warning indicator

It illuminates to indicate that the reversing side warning function is enabled.



Lane deviation indicator

When this indicator is on and gives off green light, it indicates that the lane deviation warning function has been turned on.

When this indicator is on and gives off red light, it indicates that the lane deviation warning function has been turned on. In this case, do not use this function, and go to service provider as soon as possible for inspection.



Lane-keeping indicator

When this indicator is on and gives off green light, it indicates that the lane keeping

assist function has been activated.

This indicator illuminates in red to indicate that the lane-keeping function is faulty. In this case, do not use this function, and go to service provider as soon as possible for inspection.



Crash safety assist indicator

When this indicator is on and gives off green light, it indicates that the crash safety assist function has been activated and is able to work normally.

This indicator illuminates in red to indicate that something is wrong with the crash safety assist function. At this point, go to service provider as soon as possible for inspection.



READY indicator

If the indicator is on, it indicates that the vehicle is started and ready for driving. The indicator flashing indicates that the following conditions of the vehicle may occur.

- › The vehicle is started but the driver's door is opened. At this time, please close the driver's door.

- › There are serious faults affecting the normal running of the vehicle. In this case, please immediately stop the vehicle in a safe spot and contact service provider.



Sound prompt system indicator

This indicator illuminates in yellow to indicate that the sound prompt system is turned off.

This indicator illuminates in red to indicate that something is wrong with the sound prompt system. At this point, go to service provider as soon as possible for inspection.



Power reduction indicator

If the indicator is on, it indicates that the vehicle has a fault that affects the power output of the whole vehicle. At this time, the vehicle power is reduced and the speed will be limited.

i NOTICE

When the yellow indicator is illuminated, please reduce the driving speed or stop the vehicle for 5 to 10 minutes. If the yellow indicator goes out, you can continue to drive the

vehicle; if the yellow fault indicator is normally on, please go to service provider to check and repair the vehicle.



Power battery low indicator

It illuminates to suggest that the power battery is too low and charge the battery promptly.



Charging connection indicator

If the indicator is on, it indicates that the charging cable is connected.

i NOTICE

- › If the indicator does not light up during charging, please check whether the charging cable is connected in place.
- › The vehicle cannot be started when this lamp illuminates.



Power battery charging indicator

If the indicator is on, it indicates that the power battery is in charging state.



Warning lamp for power battery malfunction

If the indicator is on, it indicates that the power battery fails. At this time, please contact service provider as soon

as possible.



Power battery cut-off indicator

If the indicator is on, it indicates that the vehicle has a fault that causes abnormal power failure of the power battery.



DC/DC fault warning lamp

It illuminates to indicate a fault in the low voltage charging system. At this point, go to service provider as soon as possible for inspection.



Power system failure warning lamp

If the indicator is on and in yellow, it indicates that the power system of the vehicle fails. In this case, please immediately stop the vehicle in a safe spot and contact service provider.

If the indicator is on and in red, it indicates that the power system of the vehicle has a serious failure and the vehicle cannot continue driving. At this time, please contact service provider.



Warning lamp for motor malfunction

It illuminates to indicate that the drive motor system fails. At this time, please contact

service provider.



E-Park fault indicator

If the indicator is on, it indicates that the gear P controller fails.



Brake energy recovery fault indicator

If the indicator is on, it indicates that the brake energy recovery function fails.

Power management system

Vehicle equipment

Please note that this manual contains all the standard equipment, country-specific equipment and special equipment for this model series. Thus, some equipment or features described in this manual may not be installed onto your vehicle or are only available in some markets. For further configuration information, please refer to relevant sales information or consult with your distributor selling the vehicle to you.

System introduction

The power management system can monitor the power consumption of each electrical equipment in the vehicle and allocate the power reasonably to improve the starting performance of the vehicle and extend the service life of the battery.

The power management system mainly has the following functions:

› Battery monitoring

Continuously monitor the voltage, current and temperature of the battery through sensors, and calculate the current remaining power and health status of the battery according to the calculated value

› Sleep power management

Continuously monitor the power consumption of various electrical equipment during the parking period of the vehicle, and gradually shut down

unnecessary electrical equipment according to the battery monitoring information, so as to avoid a large amount of battery discharge and ensure the starting performance of the vehicle.

› Static power management

Continuously monitor the power consumption of various electrical equipment when the vehicle is not started up, and gradually shut down unnecessary electrical equipment according to the battery monitoring information, so as to avoid a large amount of battery discharge and ensure the starting performance of the vehicle.

› Dynamic power management

Continuously monitor the power consumption of each electrical equipment during the driving of the vehicle, and distribute the power generated by DC/DC to different electrical equipment as needed. When the DC/DC output more power than the demand of the electrical equipment, the dynamic power management system will regulate and supply power to the battery to allow it to reach the optimum charging status.

i NOTICE

It is impossible for a power management system to go beyond the boundaries of physical law. Please note that there are limits to the power and

service life of the battery.

Information you should know

The power management system will give top priority to ensuring the starting performance of the vehicle.

In the event of short-distance travel and driving in urban areas or under low temperatures, the power consumption will increase and the DC/DC will supply less power.

If the vehicle is not started, the use of electrical equipment will directly consume the power of the battery because DC/DC cannot supplement power in this case.

In these situations, the power management system will operate to control the power distribution.

Parking the vehicle for a long time

If the vehicle is not driven for several days or weeks, the power management system will gradually turn off the electrical equipment or reduce the electrical energy being used by the electrical equipment, so as to reduce power consumption and maintain the vehicle's starting performance for a longer time.

If the vehicle has been parked for a long time, certain convenient functions (such as remote unlocking, etc.) may not be available. After starting the vehicle, these functions will be restored.

When the vehicle is not started

If you listen to the radio or use other functions of the audiovisual system with the vehicle not started, the battery will discharge.

If the battery power consumption affects vehicle startup, a message will display on the multimedia display screen or the combination instrument. In this case, if you want to use these functions normally, please start the vehicle.

After the vehicle is started

During driving, the battery may lose power even if the DC/DC can supply power. This situation is prone to occur when the power consumption is too large and the DC/DC power supplies less power, especially when the battery power capacity is low.

In order to restore necessary power supply, the system will temporarily shut down certain electrical equipment with high power consumption or reduce the power consumption of these equipment. Especially, the heating system consumes a considerable amount of energy. If it is found that the seat heating function is inoperative or the air volume of the air conditioning is limited, it means that the system has temporarily turned those functions off or adjusted them to operate at a lower power. When the power is sufficient again, these systems can be used normally again.

3

Audiovisual system

Tips for safety.....	172
Multimedia player - type I ...	174
Multimedia player - type II ..	194

Tips for safety

Vehicle equipment

Please note that this manual contains all the standard equipment, country-specific equipment and special equipment for this model series. Thus, some equipment or features described in this manual may not be installed onto your vehicle or are only available in some markets. For further configuration information, please refer to relevant sales information or consult with your distributor selling the vehicle to you.

Safety

- › Ensure that your use of any of the system's features does not distract you and thereby interfere with safe driving. Your most important responsibility while driving is for the safety of the drive. You must obey all traffic regulations.
- › During driving, the driver is not allowed to operate the system and must keep the volume of the system at an appropriate level, so as not to affect driving safety due to lack of concentration.
- › This system may only be used in areas permitted by law. Some national or local regulations may prohibit use of the display screen within the driver's field of view.
- › Do not disassemble or modify the system.
- › When a failure occurs, stop using the

system and contact service provider. Do not try to repair the system by yourself.

About the use

- › For safety reasons, some functions may not be activated when the vehicle starts to move.
- › Do not press the buttons or knobs on the panel firmly.
- › Do not press the screen forcefully or scratch it with sharp objects.
- › When cleaning the display screen, do not use abrasive wipers or detergent containing organic solvent.
- › Do not strike the screen when image jitter occurs in process of operation.

About the radio

When driving the car, you may not find any radio stations, or you may hear noises or receive different radio signals with same frequency, depending on the environment such as road conditions, weather, etc.

About USB storage devices

Since there are various types of USB storage devices, this system may not be compatible with all USB storage devices.

About Bluetooth

- › Since there are a great number of smartphone brands with different functions, this system may not be

compatible with all the smartphones.

- › If you cannot search and find the Bluetooth device name of this system during Bluetooth pairing, restart the Bluetooth on the smartphone and search it again.
- › If Bluetooth cannot be connected, delete the paired device on the smartphone, and pair it again.
- › If Bluetooth does not function properly when in use, disconnect the Bluetooth and reconnect it.

Multimedia player - type I

Vehicle equipment

Please note that this manual contains all the standard equipment, country-specific equipment and special equipment for this model series. Thus, some equipment or features described in this manual may not be installed onto your vehicle or are only available in some markets. For the further configuration information, please refer to relevant sales information or consult with your distributor selling the vehicle to you.

Steering wheel button

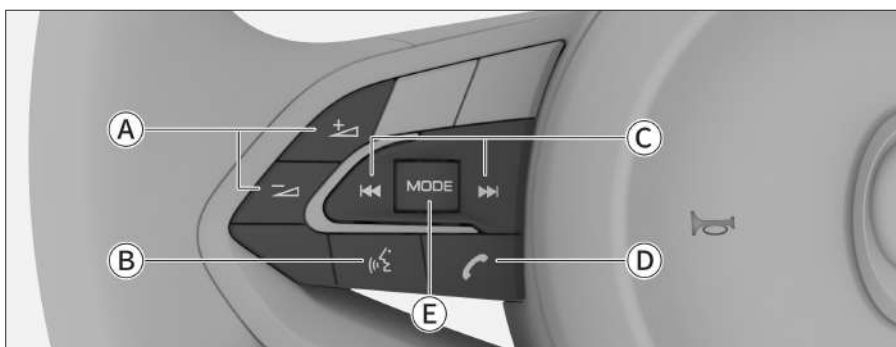

C44AF028E016

- Ⓐ Volume button
- Ⓑ Voice button
- Ⓒ Jump button
- Ⓓ Bluetooth telephony button
- Ⓔ Media switch button

Volume button

Press the volume increase button  to increase volume.

Press the volume reduction button  to decrease volume.

Voice button

Press the voice button  to start or disable voice.

Jump button

Press the skip forward button  to switch to the previous song/station.

Press the skip backward button  to switch to the next song/station.

Bluetooth telephony button

Press the BT phone button  to switch to the Bluetooth call interface.

Media switch button

Press **【MODE】** button to switch to audio sources of media.

Power switch



4D7C26C9F60A

- › Touch the button to enter mute mode. Touch button again to exit mute mode.
- › Touch and hold the button to enter screen standby mode, and touch the button for a long time to light the screen.
- › Tap and hold the screen more than 10 seconds, the system will be restarted.



External devices

USB interface

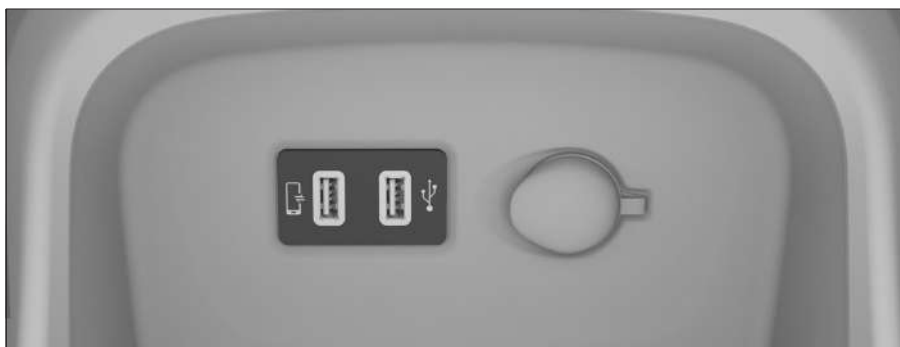
The vehicle has two USB port, and the position of the USB interface is as shown in the figure.



0795883870B0

The icon  is USB1 port. The icon  is USB2 port. When input the USB device into USB port and play the multimedia, the display interface will show USB1 or USB2.

i NOTICE

- › Ensure a firm connection between the external device and the Input port.
- › Do not plug/unplug the device at will during playback, so as to avoid problems such as the system cannot identify the device.

Media specifications

This system supports the following media specifications:

Media	Specification
USB device	USB devices has a partition format of FAT32 and NTFS
Bluetooth audio	It supports A2DP BT audio device with BT 4.0+EDR and AVRCP versions 1.0 to 1.3.

File format

This system supports the following file formats:



File	Format
Audio	MP3、WMA、WAV
Video	ASF、MP4、MOV、MKV、AVI、3GP



i NOTICE

Even file formats supported by this system may cause non-playback due to file characteristics (such as file quality, bit rate, frame rate, resolution, compression quality, or corruption), playback environment and storage devices.

Central display screen operation





You can complete functions such as selecting a target, scrolling the list, or moving an application by touching, sliding, and dragging on the central display screen.







Gesture	Operation	Result
	Tap	Select or enable a function
	Double-tap	Enlarge a picture or map

Gesture	Operation	Result
	Tap and drag	Scroll view or move between pages
	Tap with two fingers and expand	Zoom in
	Tap with two fingers and pinch	Zoom out

Central display screen status bar

The status bar icons are displayed at the top of the central display screen to display the status of each function. The status bar icons will change in real time according to functional characteristics, signal strength, connection status, switch status, etc.

Icon	Function	Function status
	Time	Time display
	Internet of vehicles	The Internet signal of the vehicle will vary from the network status.
	WIFI	WIFI is connected and the signal strength is shown.
	Mute	Mute mode on
	Sound	Sound mode on

Icon	Function	Function status
	Bluetooth connection state	Bluetooth is not connected
		Connected devices
	USB	USB connection
	Wireless charging	Not charging
		Charging in progress
		Charging finished

Navigation system

About navigation

- › Do not operate this navigation when driving. Please operate the navigation in safe condition, so as to prevent traffic accidents or other dangerous situations.
- › The functions and services such as place search, path planning, travel navigation and road conditions provided in this navigation is only for reference, please do not regard it as the only basis for driving or tripping. Please refer to the actual traffic and road conditions, and strictly abide by traffic laws and traffic rules.
- › Using the online services such as online navigation, road condition, data download and so on will use network traffic.
- › When the vehicle only use the off-line navigation, some parts of online function and service cannot be used.
- › Do not paste metal film on the front windshield. The metal film may shield the signal so that the navigation system cannot locate normally.

Enter the navigation interface

Touch the navigation button  to switch to the navigation interface.

Touch the non-button location on the map to pop out the hiding function buttons.



989A26B978C6

- (A) Map view
- (B) Map zooming
- (C) Map scale
- (D) Destination search
- (E) Vehicle position
- (F) Audio playback interface
- (G) Near charging piles
- (H) Range
- (I) Navigation setting
- (J) Mute navigation

Choosing destination on the map

Tap and hold on the map to select a destination and switch to the detail interface of the destination.

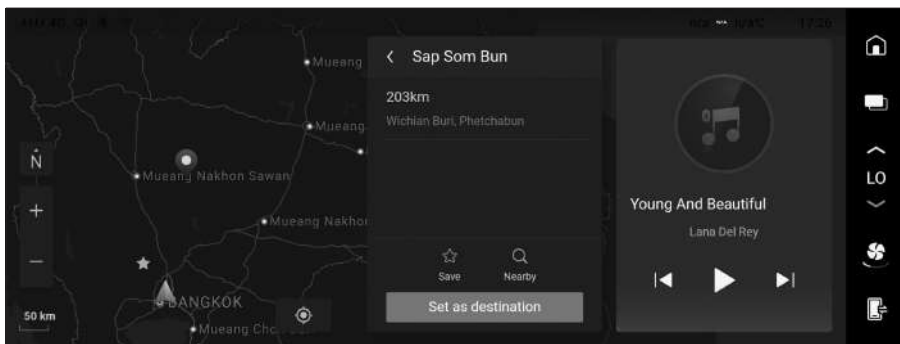

2C7DEB7F08D4

- > Tap the back button < can return to the previous interface.
- > Tap the favorite button ☆ can favorite the current place. Touch this button again to stop collection.
- > Touch the surrounding search button Q can search the near places.
- > Touch the **【Set as destination】** button to set the current place as destination.

Destination search

Touch search button  in the map interface to switch to the destination search interface.

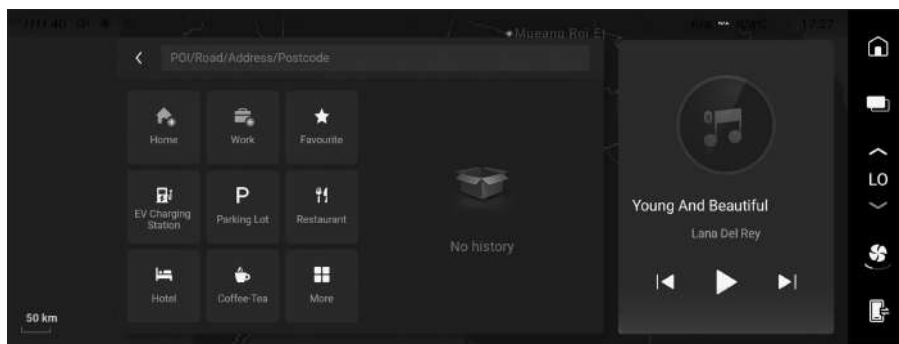

- ▶ Touch the **【Home】** button to set your family address. After that, touch this button can set your family address as destination.
- ▶ Touch the **【Work】** button to set your company address. After that, touch this button can set your company address as destination.
- ▶ Touch **【Favourite】** button to switch to your favourite interface, which shows the favourite places. It can check, delete and set the favourite places

Path planning

After setting destinations via many methods, you can switch to the planning interface.

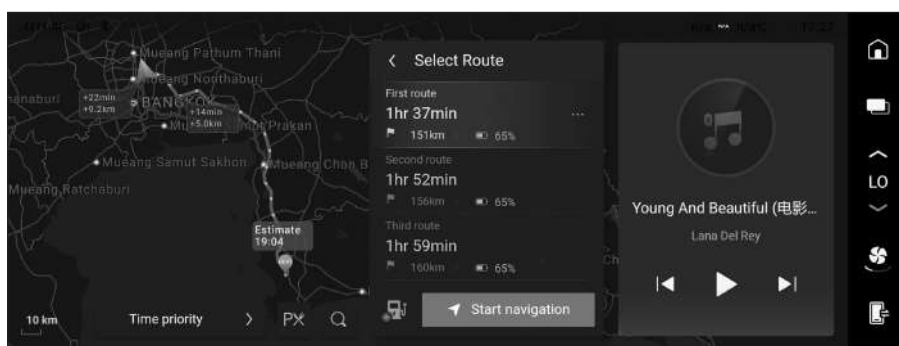

- ▶ It shows the current road name from top to button.
- ▶ Touch search button  to switch to the destination search interface, you can also add passing places or change destinations..

- › Touch the service area button **PX**, all the service area at present will be shown.
- › Touch the **【Time priority】** button to show the prefer path and change your prefer path.
- › Touch **【Start navigation】** button to switch the path leading interface and enter into formal navigation mode.



928FA5613C42

Touch the non-button location on the map to pop out the hiding function buttons.

Navigation setting

Touch the setting button **⚙** on the map interface to switch to the setting interface.

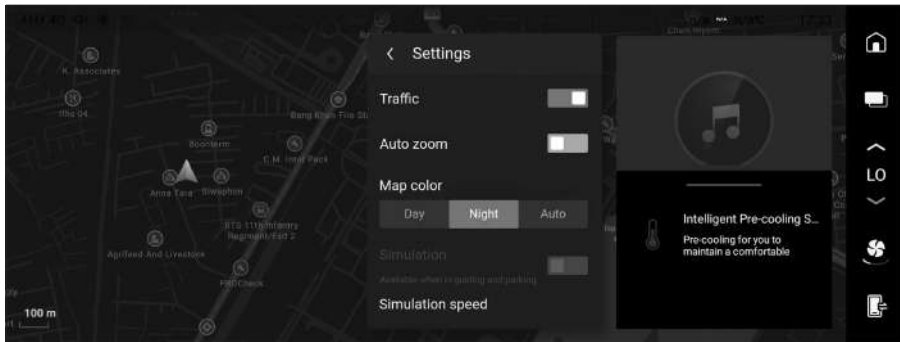

E06351C7871E

You can set current road condition, automatic scale, navigation broadcast, prefer path, family/ company address, delete personal information, update the online map, update USB map and check version information.

Menu interface

In most interfaces, tap the menu button **☰**, then the menu application interface will appear.

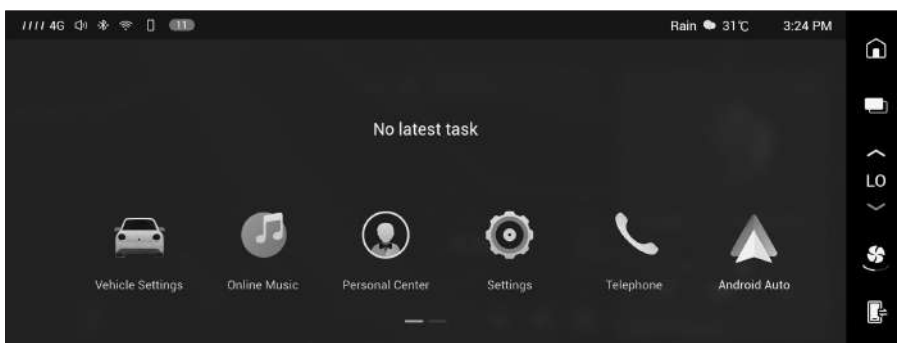

06D7F8D2A7A3

The small windows of recently used applications are displayed on the top. Touch the small application windows to quickly switch to the application interface.

The application icons are displayed at the bottom. Touch the application icons to switch to application interface.

Vehicle settings

Tap the **【Vehicle Settings】** button to switch to the vehicle setting interface, where you can set the function and switch states of the vehicle.

Settings

Tap the **【Settings】** button to switch to the setting interface, where you can set the Bluetooth, Internet, sound, display and so on.

Telephone

Touch **【Telephone】** button to switch to telephone interface. If Bluetooth is not connected, go to **【Settings】** → **【Bluetooth】** to turn on Bluetooth for pairing.

After pairing with other Bluetooth, functions such as dialing and answering calls, checking contacts, call records and SMS can be realized.

i NOTICE

- › When pairing and connecting, please allow access to contacts, call records, messages and other permissions on the mobile phone. Otherwise, these functions cannot be used.
- › Message function is not supported by certain phones due to permission restrictions version systems.

i NOTICE

- › This communication device conforms to standards or technical requirements of NBTC.
- › The electromagnetic field intensity of this communication device conform to *Safety Standard for People to Use Communication Device Healthily* published by National Telecommunications Commission.

Android Auto

Connect the Android phone to the on-board USB1 (with the  icon) through the phone USB data cable.

After connecting successfully, the  Android Auto button will display at the right of the interface, touch this button to switch to Android Auto interface.

Disconnect the USB cable to exit Android Auto.

i NOTICE

- › If the Android phone is not installed with the Android Auto, it can be downloaded from the Google Play application store and installed on the phone.
- › Due to the different compatibilities of mobile phone systems and versions, some Android phones may not support the Android Auto function.
- › When an Android Auto device is connected, the Bluetooth phone function is disabled, and the Android Auto phone function can be used at this time.

Apple CarPlay

Connect the iPhone to the on-board USB1 (with the  icon) interface through the mobile phone USB data cable.

Touch the  Apple CarPlay button to the Apple CarPlay interface by touching the Apple CarPlay button.

Disconnect the USB cable to exit the Apple CarPlay.

i NOTICE

- › Due to the different compatibilities of mobile phone systems and versions, some iPhones may not support the Apple CarPlay function.
- › When an Apple CarPlay device is connected, the Bluetooth phone function is disabled, and the Apple CarPlay phone function can be used at this time.

Local Multimedia

Touch **【Local Multimedia】** to switch to local multimedia interface which includes local radio, Bluetooth music, USB music and USB video.

Pair the system Bluetooth with other audio playback devices to play Bluetooth music on the **【Settings】** → **【Bluetooth】** interface.

Insert the USB device which is used to store media documents into USB connector on vehicle to play USB music and USB video.

Personal Center

Touch **【Personal Center】** button to switch to the personal center interface, where you can log into the account, set account information, switch account and so on.

Message Center

Touch **【Message Center】** button to switch to message center interface where you can check related messages.

Online Multimedia

Touch **【Online Multimedia】** button to switch to online multimedia interface where you can search or select favourite media after connected to the network.

Energy consumption assistant

Touch **【Energy consumption assistant】** button to switch to consumption assistant interface where you can check consumption information, driving suggestions and related settings.

Shortcut panel

In most interfaces, sliding down from the top of the screen will call up the shortcut panel.



E060E3D95F61

Adjustment of volume or brightness

Tap and drag the sliding block to adjust related volume or brightness.

Press the $\Delta \times$ button to enable or disable navigation mute function.

Press $\square \times$ button to enable or disable the media mute function.

Touch the button \odot to enable/disable the automatic adjustment function.

Shortcut switch

Touch the switch directly to execute, switch, turn on or turn off the corresponding function.

The shortcut switch showed on the screen can be compiled or replaced.

Voice assistant

Voice assistant can recognize and execute voice commands to control vehicle functions quickly and improve operation convenience. There are several ways to activate the voice assistant:

- › Press Ⓜ the voice button on the steering wheel.
- › Voice wake-up: it can be activated through the default wake-up words or customized wake-up words

The wake-up words can be found and set through **【Settings】** → **【Customize】** .

⚠ WARNING

Please pay attention to the surroundings and personal safety so as to prevent from severe accidents such as crush, collision and so on when using voice assistant to control the vehicle.

i NOTICE

- › The success rate of speech recognition will be affected by environmental noise, network signal, usage habits, pronunciation and other factors. The specific use effect is subject to the actual vehicle environment.
- › Some functions of the voice assistant can be used only when connecting the network.

System settings

In the menu interface, touch **【Settings】** button to switch to the setting interface.

Bluetooth

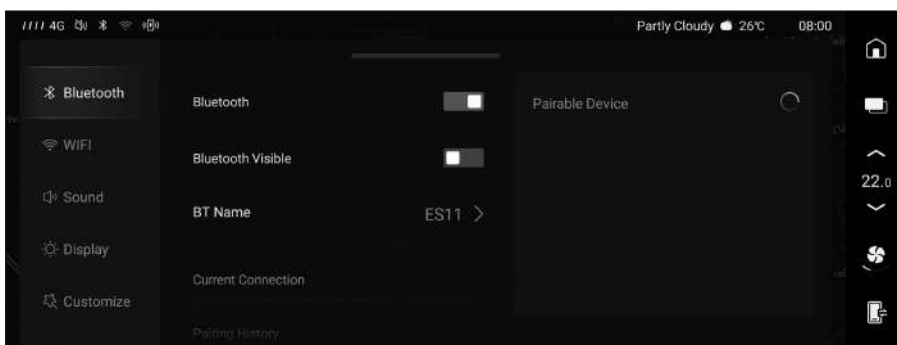

Touch the  button on the multimedia display screen to directly show the Bluetooth setting interface.

- › **【Bluetooth】** : Tap the Bluetooth of this system switch can be touched to turn on or off the Bluetooth.
- › **【Bluetooth visible】** : When this switch is turned on, other devices are allowed to detect the Bluetooth of this system and perform pairing connection.
- › **【BT name】** : It displays the name of the Bluetooth device, which can be modified to a custom name.
- › **【Pairing history】** : It shows the current Bluetooth device, which can be connected or deleted.
- › **【Paired device】** : It shows all the bluetooth device which can be searched. You can search for Bluetooth devices. Touch the name of the searched Bluetooth device to initiate a matching request. Touch the **【Search】** button to search for bluetooth devices again.

i NOTICE

1. The communication equipment complies with NBTC standards or technical requirements.
2. The communication equipment has an electromagnetic field intensity that complies with the *Safety Standards for the Use of Radio Communication Equipment for Human Health* published by the National Telecommunications Commission.

WIFI

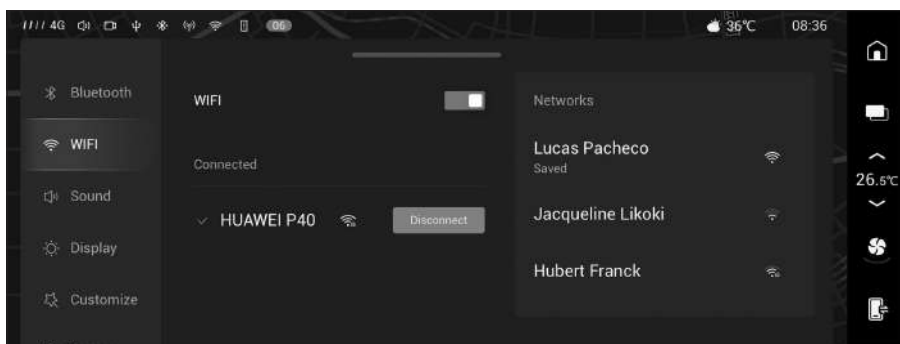

- > **【WIFI】** : Touch the WIFI switch of this system can turn on or off the Bluetooth.
- > **【Available network】** : You can display searched available network, and tap the network name to connect it.

i NOTICE

1. The communication equipment complies with NBTC standards or technical requirements.
2. The communication equipment has an electromagnetic field intensity that complies with the *Safety Standards for the Use of Radio Communication Equipment for Human Health* published by the National Telecommunications Commission.

Sound

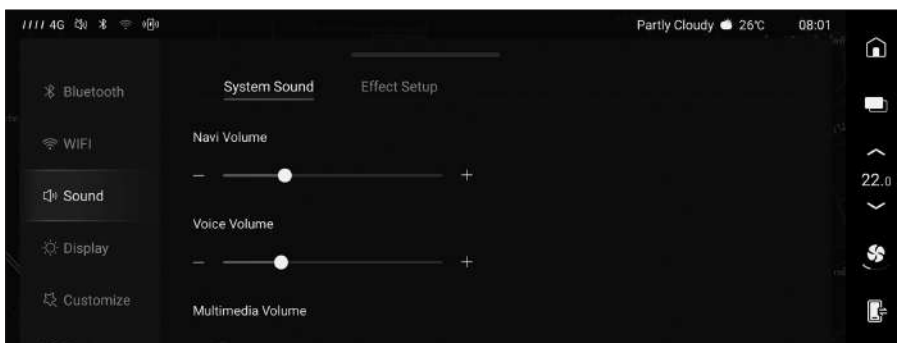

6D473B84D7CF

- › **【System Sound】** : It can set the navigation beep, voice sound, multimedia sound, calling voice, ring voice, reducing multimedia sound when navigation, vehicle alarm sound, complement for vehicle speed and so on.
- › **【Effect Setup】** : You can set DTS sound effects, balance, sound field adjustment and so on.

Display

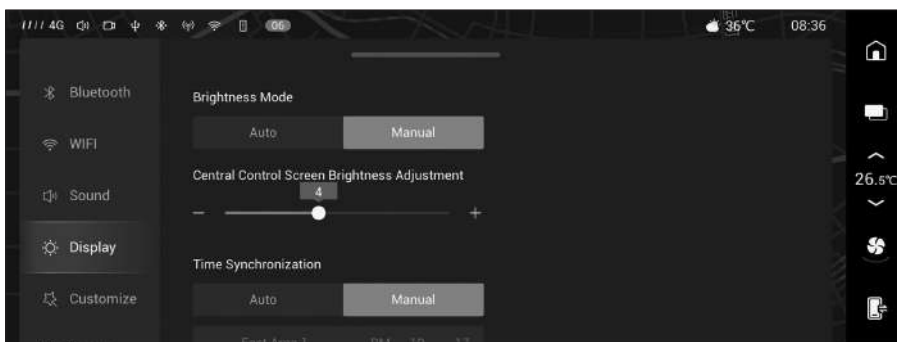

AB4BCDBDA5F8

It can set the brightness mode, brightness of the central control screen, time display form, driving video limitation, language, theme and unit setting.

Custom setup

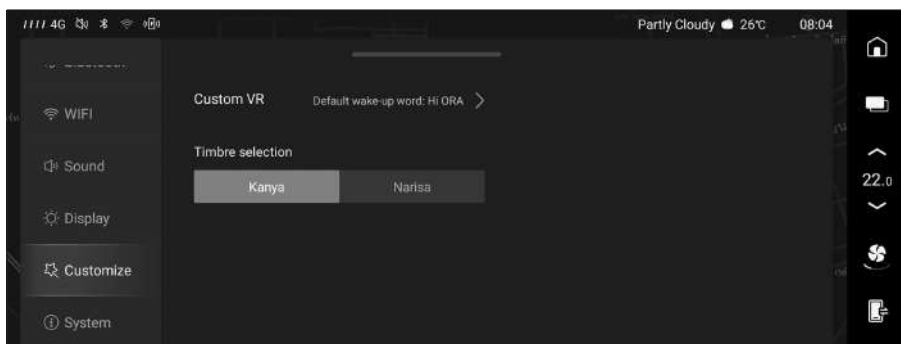

A7211AA18CC0

It can set the waking words of the voice assistant.

System

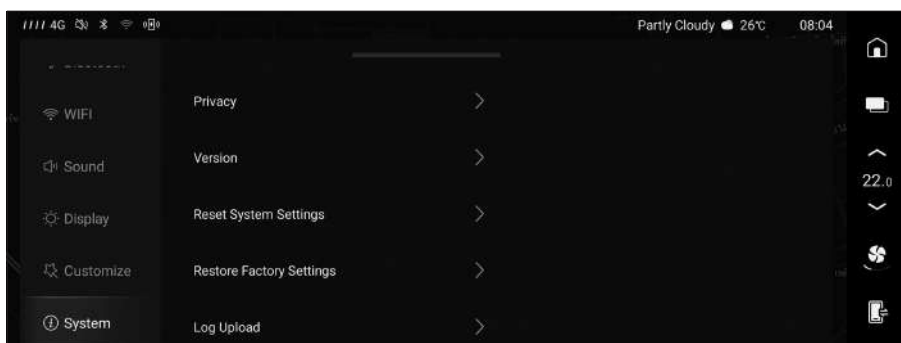

37CD266D8CCF

- › **【Privacy】** : System will collect, store personal and vehicle data for providing better vehicle network service. It can be turned on or off optionally.
- › **【Version】** : You can view and modify the name of the device, view the software version, update the system through WIFI/4G check and update, and update through the USB device.
- › **【Reset and recovery】** : You can reset the system and recover all the system settings.
- › **【Log upload】** : It can upload the log data.

i NOTICE

About upgrades:

- › To ensure safety during the upgrade process, please place the vehicle in a safe

3

Audiovisual system

environment.

- › In order to ensure successful upgrades, the vehicle must keep the power into ON mode (without lighting READY indicator) and apply the parking brake so that the vehicle keep static. At this time, the high-power devices such as air condition, vehicle lamp and loudspeaker should be close.
- › Please read the agreement and the notices on installation interface during upgrading process. If you want to know the specific content of this upgrade, you can click the update details to view.
- › During the upgrade process, all functions of the vehicle will be invalid, including following situations: the vehicle cannot be started, the air conditioner cannot be used, the door cannot be opened, the audio-visual entertainment function becomes invalid, all the fault lights on the instrument will light up, the active and passive safety functions becomes invalid. But after the upgrade is complete, all functions will be restored.
- › Do not change the vehicle state during installation process (Do not employ force to start the vehicle, and do not employ force to shut down the system).
- › When upgrading via WIFI, please keep the network signal in good condition, and do not disconnect the current network connection during the upgrade process.
- › It is normal if the screen becomes black or restarts during the process of updating host or screen. You can wait for a few minutes and the host will finish restarting, then the installation result will eject. Please don't change the vehicle state during this period.
- › Please check the final result after update is finished to ensure the vehicle is closed after all the softwares are installed successfully. If the update is failed or there is abnormal conditions during update progress, please contact the service provider.
- › After the upgrade is successful, the various updated system items, function, interface, operating methods, etc. may change, which is not as described in the manual. The update information will be included in the interface prompt during update progress.

Energy consumption assistant

In the menu interface, touch **【Energy consumption assistant】** button to switch to the energy consumption assistant interface.

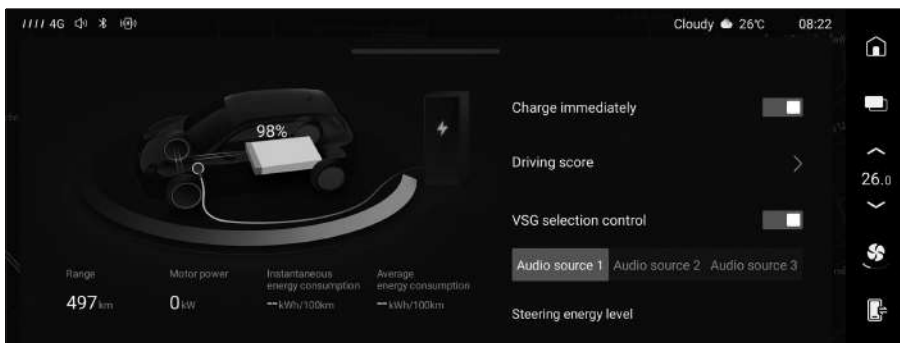

5B2D66F90684

You can check information including **【Range】**, **【Motor power】**, **【Instantaneous energy consumption】**, **【Average energy consumption】**, **【Driving score】** and so on. The detail instruction of the functions including **【Charge immediately】**, **【VSG selection control】**, **【Energy recovery level】**, **【Single-pedal switch】**, **【AC automatic restriction function】**, **【Gun heat preservation setting】**, **【ECO+ mode】** and **【Set the upper limit of charging】** can be found in other chapters of this manual.

Mobile interconnection

System introduction

The system can ensure the sharing of mobile phone applications with the on-board multimedia host, mainly including navigation, music, talkback, phone call, voice recognition, etc. This can ensure you have a safer and more convenient vehicle experience.

i NOTICE

- › The mobile phone interconnection is not supported in system versions below Android 5.0 and iOS 8.0.
- › Due to the difference between system and version compatibility, even the system version that is supported by the mobile phone may not support the mobile phone interconnection.

Connection method

1. Connect to the on-board USB1(with the  icon) interface through the mobile USB data cable.
2. After connect is successfully, the system turn to mobile interconnection interface automatically.

i NOTICE

- › Some mobile phones need to have USB debugging mode turned on for successful interconnection.
- › If the APP is not installed in the mobile phone, a QR code will be shown.

You can scan the QR code with your mobile phone to download the APP.

- › Some functions of mobile interconnection (such as call function) are available only when mobile phone Bluetooth and car Bluetooth are successfully connected.
- › When mobile interconnection function of mobile phone is enabled, the screen of mobile phone will be dimmed to save the power of mobile phone.

Exit method

Disconnect the USB cable to exit the mobile phone interconnection.

i NOTICE

- › To achieve a better customer experience, the apps will be constantly updated.
- › Some functions require information that is obtained from the Internet, and data traffic may occur in this process.

Comfort mode

Comfort mode combines windows, doors, seats and other settings to provide a comfortable rest place for the driver.

The comfort mode can be entered via **【Comfort mode】** on the interface of **【Vehicle Settings】** → **【Frequently】**.



After the comfort mode is activated, the system will automatically close windows, lock doors and adjust the seat settings.

Touch the OFF button **×** to exit the comfort mode.

Touch the **【Set】** button to switch to the setting interface of the comfort mode.

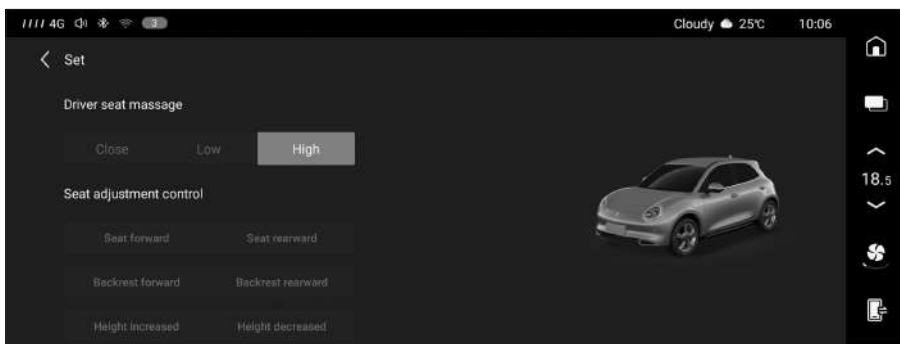

Touch the relevant button to carry out related setting for the driver's seat.

i NOTICE

After binding the comfort mode setting with the personal center account, the setting will be adjusted automatically when restarting the comfort mode.

Multimedia player - type II

Vehicle equipment

Please note that this manual contains all the standard equipment, country-specific equipment and special equipment for this model series. Thus, some equipment or features described in this manual may not be installed onto your vehicle or are only available in some markets. For the further configuration information, please refer to relevant sales information or consult with your distributor selling the vehicle to you.

Steering wheel button

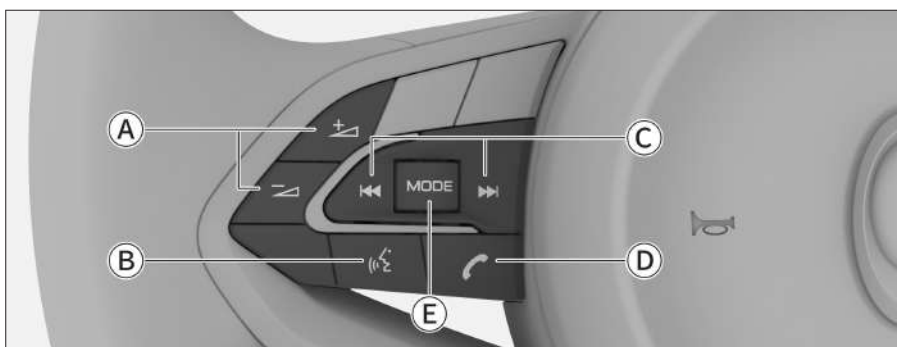

C44AF028E016

- Ⓐ Volume button
- Ⓑ Voice button
- Ⓒ Jump button
- Ⓓ Bluetooth telephony button
- Ⓔ Media switch button

Volume button

Press the volume increase button  to increase volume.

Press the volume reduction button  to decrease volume.

Voice button

After connecting and opening the Apple CarPlay or Android Auto, Press the voice button  to start or disable voice.

Jump button

Press the skip forward button  to switch to the previous song/station.

Press the skip backward button  to switch to the next song/station.

Bluetooth telephony button

Press the BT phone button  to switch to the Bluetooth call interface.

Media switch button

Press **【MODE】** button to switch to audio sources of media.

Power switch





- › Touch the button to enter mute mode. Touch button again to exit mute mode.
- › Touch and hold the button to enter screen standby mode, and touch the button for a long time to light the screen.
- › Tap and hold the screen more than 10 seconds, the system will be restarted.

External devices

USB interface

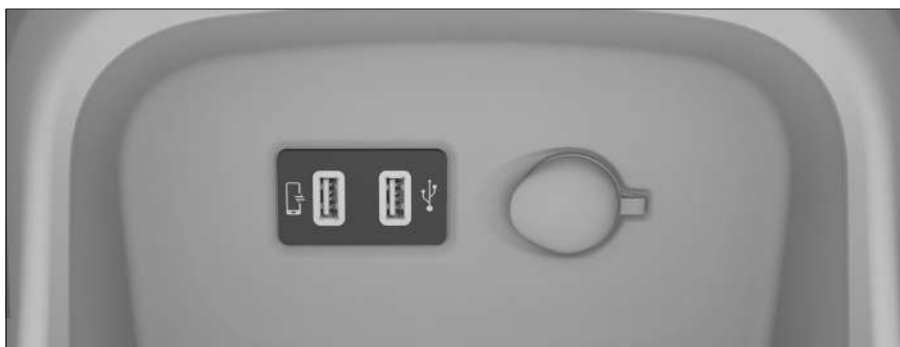
The vehicle has two USB port, and the position of the USB interface is as shown in the figure.



The icon  is USB1 port. The icon  is USB2 port. When input the USB device into USB port and play the multimedia, the display interface will show USB1 or USB2.

i NOTICE

- › Ensure a firm connection between the external device and the Input port.
- › Do not plug/unplug the device at will during playback, so as to avoid problems such as the system cannot identify the device.

Media specifications

This system supports the following media specifications:

Media	Specification
USB device	USB devices has a partition format of FAT32 and NTFS
Bluetooth audio	It supports A2DP BT audio device with BT 4.0+EDR and AVRCP versions 1.0 to 1.3.

File format

This system supports the following file formats:

File	Format
Audio	MP3、WMA、WAV
Video	ASF、MP4、MOV、MKV、AVI、3GP



i NOTICE

Even file formats supported by this system may cause non-playback due to file characteristics (such as file quality, bit rate, frame rate, resolution, compression quality, or corruption), playback environment and storage devices.

Multimedia display screen operation







You can complete basic functions such as selecting a target, scrolling the list, or moving an application by touching, sliding, and dragging on the multimedia display screen.

Gesture	Operation	Result
	Tap	Select or enable a function

Gesture	Operation	Result
	Double-tap	Zoom out the picture and the interconnection map on mobile phone
	Tap and drag	Scroll view or move between pages

Central display screen status bar

The status bar icons are displayed at the top of the central display screen to display the status of each function. The status bar icons will change in real time according to functional characteristics, signal strength, connection status, switch status, etc.

Icon	Function	Function status
	Mute	Mute mode on
	Sound	Sound mode on
	Bluetooth connection state	Connected devices
	USB	USB connection
	Wireless charging	Not charging
		Charging in progress
		Charging finished

Interface introduction

For your convenience, the common menu bar is displayed at the right side of most interface.

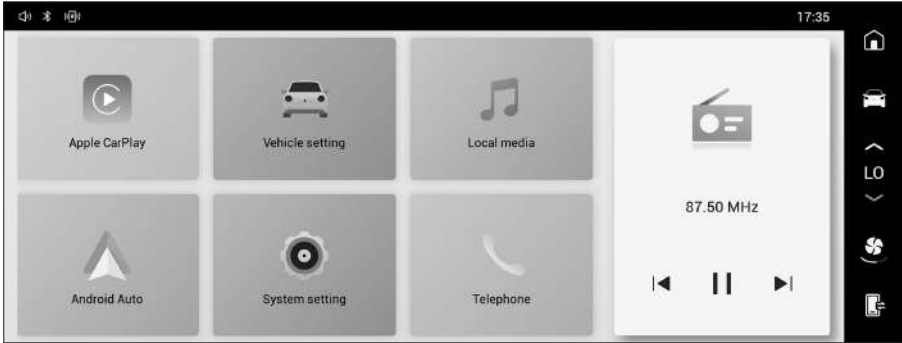

15EEF522B987

3

Audiovisual system

- › Touch the switch button to return to the main interface.
- › Touch the vehicle setting button on the homepage interface to enter the vehicle setting interface.
- › Touch the air condition button to enter the A/C setting interface
- › Touch mobile phone interconnection button to enter into the phone interconnection interface (the mobile phone interconnection should be connected first).

NOTICE

The icons and functions in the menu bar may be different due to different vehicle configurations or different system versions. Please refer to the actual vehicle display.

Shortcut panel

In most interfaces, sliding down from the top of the screen will call up the shortcut panel.



5F6735B36E92

Adjustment of volume and brightness

Touch the slider at the left side to adjust the corresponding volume and brightness. After connecting and turning on Apple CarPlay or Android Auto, touch Δ^x button to turn on or turn off the mute function of the mobile phone navigation .

Touch \square^x the mute button to enable or disable the mute function of the media.

Touch \odot the brightness adjustment button to turn on or turn off the automatic brightness adjustment function.

Shortcut switch

Touch the switch at the right side to switch, turn on or turn off the related function.

Apple CarPlay

System introduction

The system allows the audiovisual system to share mobile phone calls, navigation, music and other functions, which can provide you a safer and more convenient on-board experience.

i NOTICE

- › Due to the different operating and version compatibility issues of mobile phones, some iPhones may not support the Apple CarPlay function.
- › When an Apple CarPlay device is connected, the Bluetooth phone function is disabled. The Apple CarPlay phone function can be used at this time.

Connection method

Connect the iPhone to the on-board USB1 (with the \square icon) interface using a USB data cable.

After successfully connected, touch the C Apple CarPlay button at the right side of the interface to the Apple CarPlay interface by touching the Apple CarPlay button.

Exit method

Disconnect the USB cable to exit the Apple CarPlay function.

Android Auto

System introduction

The system allows the vehicle to share the functions such as mobile phone calls,

navigation and music, which can provide you a safer and more convenient on-board experience.

i NOTICE

- › If the Android phone is not installed with the Android Auto, please download from the Google Play application store and install it.
- › Due to the different operating and version compatibility issues of mobile phones, some Android phones may not support the Android Auto function.
- › After successfully connected, the system Bluetooth phone function is disabled. The Android Auto phone function can be used at this time.

3

Audiovisual system

Connection method

Connect the Android phone to the on-board USB1 (with the  icon) interface using a USB data cable.

After successfully connected,  the Android Auto button will be displayed at the right side of the interface. Touch this button to switch to the Android Auto interface.

Exit method

Disconnect the USB cable to exit Android Auto.

Local multimedia



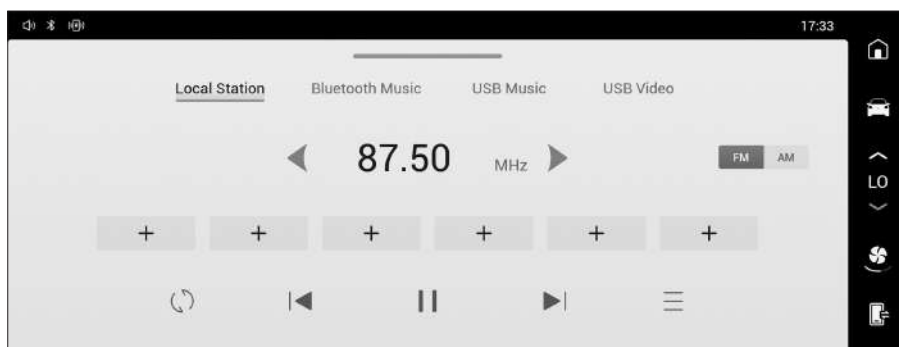



Touch the **【Local media】** button on the menu interface to switch to the local multimedia interface.



3532A034A469

【Local media】 : includes Local Station, Bluetooth Music, USB Music and USB Video.

- › Touch **+** the favourite button to save current playing radio. The saved radio FM will be displayed. Delete the saved radio by long pressing it.

- › Touch  the refresh button to scan the radio stations and refresh the list of radio stations.
- › Touch the  or  switch button to switch to valid radio.
- › Touch  the pause button to pause or play, and touch  the play button to resume the play.
- › Touch  the list button to switch to radio list interface which displays the updated radio list at current.
- › In order to play Bluetooth music, first go to **【System setting】** → **【Bluetooth】** interface to pair and connect the system Bluetooth with other Bluetooth devices, then the Bluetooth music can be played.

Insert the USB device which is used to store media documents into USB connector on vehicle to play USB Music and USB Video.

System setting

On the menu interface, touch **【System Setting】** button to switch to the system setting interface.

Bluetooth

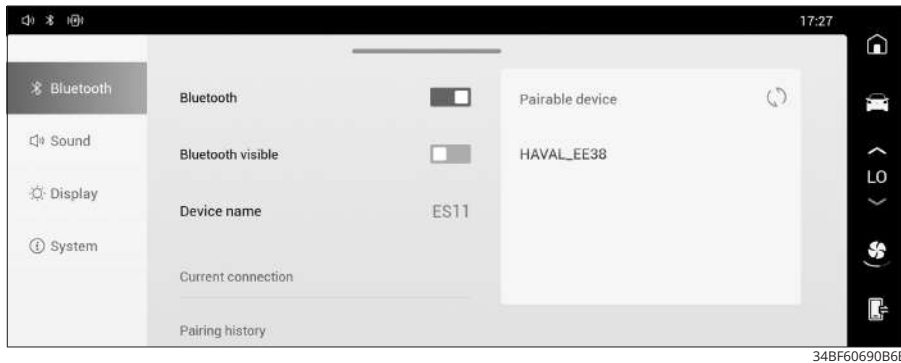

- › **【Bluetooth】** : Touch the Bluetooth switch of this system to turn on or turn off the Bluetooth.
- › **【Bluetooth visible】** : After turning on this function, other devices are allowed to detect and pair the Bluetooth of this system.
- › **【BT Name】** : It displays the name of the Bluetooth device, which can be customised.
- › **【Current connection】** : It displays the current pairing device. You can disconnect

or delete the paired device.

- › **【Pairing history】** : You can display other current pairing device, and you can disconnect or delete the paired device.
- › **【Pairable device】** : The sought Bluetooth device can be displayed. Touch the name of the searched Bluetooth device to initiate a pairing request. Touch ↻ the refresh button to search for Bluetooth devices again.

i NOTICE

- › This communication device is in compliance with the standards or technical requirements of NBTC.
- › The electromagnetic field intensity of this communication device is in compliance with the Safety Standard for People to Use Communication Device Healthily published by National Telecommunications Commission.

Sound

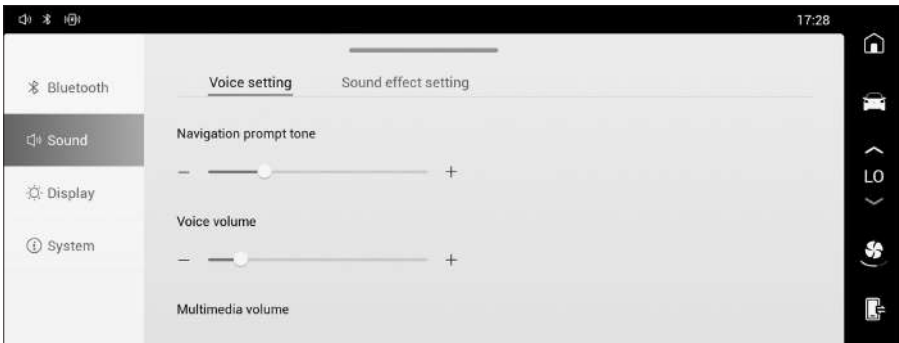

DBDE491ABA70

- › **【Voice setting】** : Navigation prompt tone, Voice volume, Multimedia volume, Call volume, Vehicle alarm tone and Speed volume compensation and other functions can be set.
- › **【Sound effect setting】** : DTS effect, Equalizer and Sound field and other functions can be set.

Display

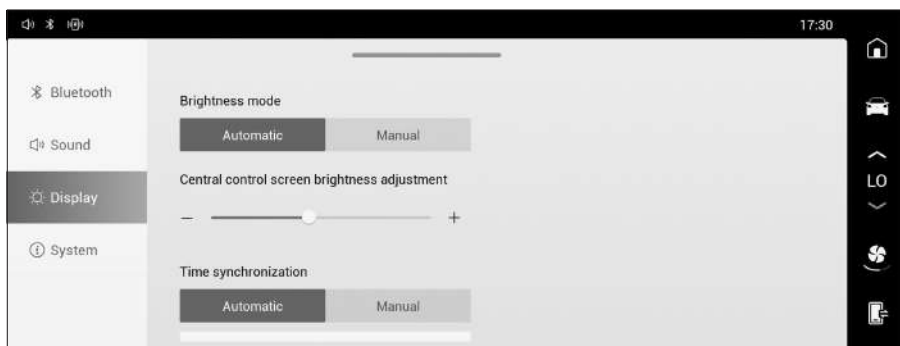

The Brightness mode, Central control screen brightness adjustment, Time synchronization, System, Driving video, Display mode and other functions can be set.

System

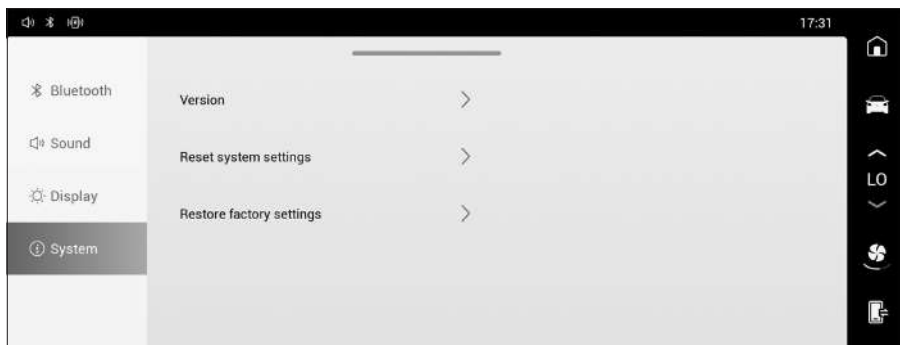

【Version】 : You can check the system name, software version and other information.

【Reset System Settings】 : The system settings can be reset.

【Restore factory settings】 : It can restore factory settings.

Energy consumption assistant

Touch **【Energy consumption】** button on the menu interface to switch to the consumption assistant interface.

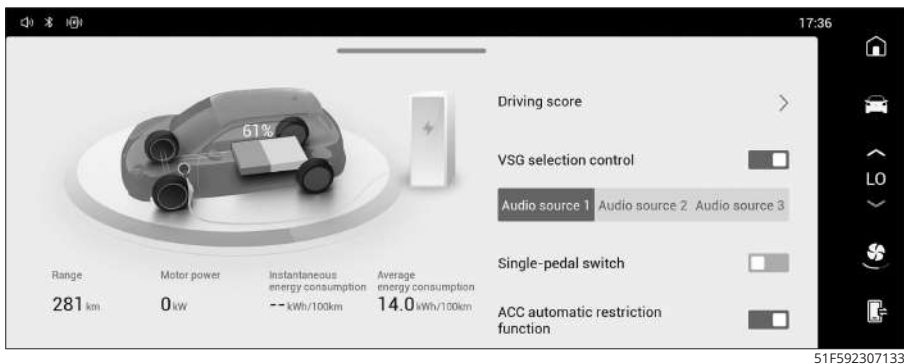

You can check **【Range】**、**【Motor power】**、**【Instantaneous energy consumption】**、**【Average energy consumption】**、**【Driving score】** and other information. For details about **【VSG selection control】**、**【Single-pedal switch】**、**【ACC automatic restriction function】**、**【Gun-inserting heat preservation setting】**、**【ECO+ mode】**、**【Set charging upper limit】** and other functions, please refer to the related chapters in this manual.

Contact

Telephone

Touch **【Telephone】** button to switch to the telephone interface. If other Bluetooth device is not connected, please go to **【System setting】** → **【Bluetooth】** interface to turn on and pair with Bluetooth.

After pairing with other bluetooth, functions such as making a call, answering a call, checking Call history, Address book, SMS and other functions can be realized.

i NOTICE

- › If you want to use the contact and call history functions, you should authorise access on the paired mobile phone first. Generally, an authorisation window will pop up on the mobile phone during the process of pairing.
- › When the paired Bluetooth device is deleted on the **【System Settings】** → **【Bluetooth】** interface, the contacts and call history already stored in the vehicle will be deleted simultaneously.
- › Message function is not supported by certain phones due to permission restrictions and system versions.



i NOTICE

- › This communication device conforms to standards or technical requirements of NBTC.
- › The electromagnetic field intensity of this communication device is in compliance with the *Safety Standard for People to Use Communication Device Healthily* published by National Telecommunications Commission.

4 Safety

Seat belt	208
Airbag	212
Child restraint system.....	219
Vehicle anti-theft system.....	225
Emergency cut-off system...	227
Event data recorder	228

Seat belt

Vehicle equipment

Please note that this manual contains all the standard equipment, country-specific equipment and special equipment for this model series. Thus, some equipment or features described in this manual may not be installed onto your vehicle or are only available in some markets. For further configuration information, please refer to relevant sales information or consult with your distributor selling the vehicle to you.

Tips for safety

4

Safety

- › The shoulder belt must not hang on the neck area, or pass under the armpit area.
- › The lap belt must be secured as firmly as possible around the lower part of the hip bone.
- › One person per safety belt. It is forbidden to share the same seat belt for more than one person (including children).

If two or more people use the same safety belt, in case of vehicle collision, the safety belt can not disperse the impact suffered, and there is a risk that two people may hit each other.

- › The seat belt should not be twisted or slack.
- › Do not wrap the seat belt around objects with sharp corners, or it may be damaged during an accident.
- › The use of a seat belt that has

undergone strong impact from an accident or which is otherwise damaged is strictly prohibited.

- › Please do not remove, disassemble or alter seat belts.
- › Do not use the seat belt with foreign objects in the buckle.
- › We suggest that when you use the seat belt, please keep your seat belt clean, oil and water-based materials such as soil, oil stain, water, beverage, food residue, shall not be glued to the seat belt so as to ensure that it can be pulled out and furled smoothly.
- › Please do not use organic substances, such as benzene or gasoline, to clean the seat belts, and do not bleach or dye them.
- › Child passenger(s) must be forbidden from playing with the seat belt.

The children passenger may hurt themselves inadvertently while playing with the seat belt. There is also the risk of death caused by the belt jam. In this case, if the locking tab of seat belt cannot be released, use a pair of scissors to cut the seat belt free.

- › The seat belt design is mainly based on adult size, so please install proper child restraint system for children.

When the seat belt is being used correctly, if the belt is in contact with the child's neck or jaw area or slack to the hip, please switch to a child seat instead.

If the child is old enough to use the seat belt, he (she) should wear the belt properly.

› Precautions for pregnant women.

We strongly suggest that you use the seat belt. You can also get effective advice by consulting with your doctor.

The recommended way of wearing the seat belt for pregnant women is fundamentally the same as for other passengers. However, such passengers should take note of the following:

1) The lap belt should be positioned as low as possible in the abdomen area, below the bulge of the belly.

2) The shoulder belt should run over the passenger's shoulder, over the chest area but avoiding the passenger's abdomen area.

If the seat belt is worn incorrectly, during emergency braking or collisions, the seat belt may tighten over the abdomen area, causing injury or even death to the pregnant mother and unborn child.

› We strongly recommend that passengers who are ill or disabled use the seat belt. You can also get effective advice by consulting with your doctor.

› When the seatbelts are not in use, it is important that they do not become twisted or jammed or rub on any sharp edges. The slot in the seat belt buckle must not be blocked with paper or other objects, as this can prevent

the latch plate from engaging properly.

Wear the seat belt properly

› Adjust seat backrest until it is vertical or near-vertical and provides adequate back support.

› The seat belt shall be neat.

› The shoulder belt should lie flat on the center of the shoulder and not on the neck or elsewhere away from the shoulder.

› The lap belt should be, as much as possible, fastened around the lower part of the hip bone.

⚠ WARNING

› During the drive, all passengers must fasten their seat belts in the correct fashion. Failure to do so can lead to severe injury or even death from collisions or emergency braking as passengers' bodies are not sufficiently bound to seats.

› At any time, all passengers should wear the seatbelt correctly on all journeys. Failure to do so can lead to severe injury or even death.

Pretensioner seat belt

When a collision occurs, the pretensioner can retract the seat belt in an instant to secure the passenger to the seat as much as possible.

The force limiter can maintain seat belt load at an acceptable level and reduce force exerted on the passenger's chest.

Working conditions

The pretensioner seat belt works when the vehicle receives a significant impact from the front.

It may not function when the following minor collisions occur.

- › When the vehicle hits a concrete wall square at a speed below 25km/h.
- › When the vehicle collides with an object with a small surface area, such as a fixed electrical pole or tree, at a speed lower than 35 km/h.

The pretensioner seat belt may not fully function when the vehicle is subjected to the following severe collision.

- › The vehicle flips over by 90° or 180°.
- › In the event of a collision from the side or from the rear.

⚠ WARNING

- › When using the pretensioner seat belt, please adjust the seat to the optimal driving position. Failure to do so will undermine seat belt performance, leading to an increased risk of severe bodily injury and death.
- › If you wish to install, remove or dismantle the pretensioner seat belt, be sure to contact service provider. If the pretensioner seat belt is not used correctly, it will not function as

normal. It may cause severe injury or even death in an accident.

- › The pretensioner seat belt cannot be deployed repeatedly.

After the pretensioner has been deployed during the first collision, you should not extend or retract the seat belt again when the second and subsequent collisions occur. Be sure to contact service provider for replacement.

- › When the pretensioner seat belt is deployed, there may be loud sounds and white smoke emanating from the device. This will not lead to a fire or cause harm to the human body.
- › When a pretensioner seat belt needs to be replaced and disposed of, please contact service provider. Inadvertent/accidental movements of the pretensioner seat belt can cause harm to the human body.

How to use the three-point seat belt

1. Hold the locking tab and pull the seat belt out of the retractor. Make sure that you do not twist the seat belt in the process. If you are unable to pull the seat belt out of the retractor, you will need to first pull hard at the seat belt and then release it. Doing so will trigger the retractor and allow you to pull out the seat belt smoothly.

2. Insert the lock tongue into the buckle until you hear a "click" sound.



51379E963370

3. Pull up the shoulder belt until the lap belt sits securely on the body. In this way, the pelvis is better secured and the risk of injury during moments of impact is reduced.
4. Check that the shoulder belt is sitting across the chest and on the center of the shoulder. Thus, any impact will be distributed across the upper skeleton.
5. Press unlock button on the buckle to retract seat belt. After the buckle has been released, hold on to the locking tab until the seat belt has been fully retracted. Take care that the locking tab does not knock into the passenger or any nearby objects.

Airbag

Vehicle equipment

Please note that this manual contains all the standard equipment, country-specific equipment and special equipment for this model series. Thus, some equipment or features described in this manual may not be installed onto your vehicle or are only available in some markets. For further configuration information, please refer to relevant sales information or consult with your distributor selling the vehicle to you.

Tips for safety

4

Safety

- › Airbags cannot be reused.

Once an airbag has been used, it will not work anymore in the second or subsequent collisions, so be sure to contact service provider for replacement.

- › The airbags are auxiliary devices to protect the passenger safety and should be used with the seat belts. In order to obtain the effect of airbags, the passengers must wear the seat belts correctly and maintain the correct posture.
- › Proper use of airbags can realize their safety effectiveness to the full. If it is used improperly, it may not play a security role, but may bring harm to passengers.
- › When the airbags are being deployed you will notice some loud sounds and smoke. This is normal and will not lead

to a fire. The smoke released, however, may cause breathing difficulty when inhaled by individuals suffering from asthma or other respiratory disease. At this moment, it is safer to flee out of the vehicle immediately. If you are unable to evacuate from the vehicle, open vehicle doors or windows to let fresh air in.

- › When any debris (or gas) released by airbags deployment comes in contact with the eyes or skin, clean such material off using water as soon as possible. Otherwise, individuals with skin hypersensitivity may experience a skin reaction.
- › Do not touch airbag components after the airbag has been deployed. Because its component parts will become very hot, it may cause burns and other major injuries.
- › Please do not use the airbag for any other purposes.
- › Please get in touch with service provider if you need to install radio equipment. Electromagnetic waves emitted by wireless equipment have a significant impact on the airbag control units.
- › It is forbidden to strike or squeeze the airbags and the position around it. Avoid the condition that the airbags cannot work normally during accident or the airbags are accidentally deployed in normal driving, which will

cause serious injuries to passengers or even death.

Airbag

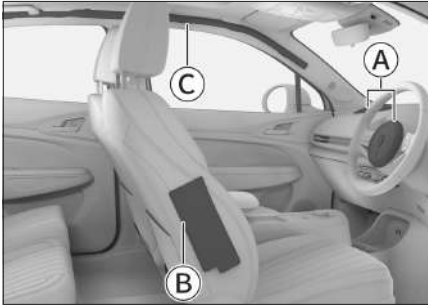

- Ⓐ Front airbag is used for:
 - Driver airbag
 - Front passenger airbag
- Ⓑ Side airbag
- Ⓒ Curtain airbags

Front airbag

General

The front airbag is located inside the steering wheel and instrument panel in front of the front passenger seat, with the airbag logo on the steering wheel and instrument panel. When the vehicle encounters a significant front impact, the seat belt will tighten. At the same time, the driver airbag and front passenger airbag will deploy in order to distribute and cushion any force directed towards the head and chest.

Working principle

When a head-on collision resulting in moderate or severe impact occurs, the

sudden deceleration of the vehicle will be noted by a sensor. At this time, the control module will immediately deploy the airbag.

Precautions

The airbag may deploy when the bottom of the vehicle encounters the following kinds of severe impact.

- › When the vehicle runs into the curb.
- › When the vehicle falls into, or runs over a deep pit or drain.
- › When the vehicle climbs over the steps and hits or falls on the road.

The airbag may deploy in the following situations. However, it will not be able to function to its full capabilities.

- › When the vehicle has rolled 90 or 180 degrees.

The airbag may not deploy when the vehicle encounters the following kinds of severe impact.

- › Head-on collision with cement concrete walls at a speed below 25 km/h.
- › Head-on collision with fixed poles, trees or other small objects at a speed below 35 km/h.

If the object impacted changes shape or moves, the force from the collision will be reduced. In this case, the airbag may not deploy.

- › When the vehicle collides into a truck from the back, the vehicle will run under the cargo box. As the impact force recognized by the sensor is weak, the

airbag may not explode.

The airbag may also not deploy depending on the angle and direction of collision, even when vehicle speed is relatively high.

- › Please do not allow your body to get too close to the steering wheel or to the lower part of the instrument panel.

When driving a vehicle normally, the driver shall stay away from the steering wheel as far as possible while maintaining the correct driving position.

The front seats should be as far from the instrument panel as possible.

All passengers should be belted up in the correct fashion for optimal protection.

- › Please do not sit on the edge of the seat or lean on the instrument panel while the vehicle is in motion.

This is because the front airbag deploys at a high speed and with great force. If the passenger is too close to the airbag at this point he or she may suffer severe injury or even death.

- › Please do not allow children to stand in front of the airbag.

When the front airbags deploy, it may cause severe injury or even death to child passengers. All children should be seated in the rear seats and be protected with the correct restraints.

- › Please adhere to the following rules; otherwise these items may cause severe injury to passengers during airbag deployment.

Please do not place objects on the instrument panel or lean umbrellas, etc. on it.

Please do not leave objects in the storage box exposed.

Please do not hang any objects on vehicle windows or on the inside rear-view mirror.

Please do not install any decorations on the steering wheel horn cover.

Please do not place luggage, pets, or other objects between the airbag and the driver or front passenger.

- › Please do not clean the inside of the vehicle with water or a cleaning solution.

The gas generator in airbag is a priming device. If it becomes damp, its normal operation will be affected or even cause serious injuries or death.

- › Please do not apply wax, stickers, or similar items to the airbag cover.

Failure to adhere to the advice can impede airbag deployment.

- › Do not damage airbag cover.

Otherwise, it will not work normally. Therefore, be sure not to open or damage the airbag cover.

- › Please do not dismantle, modify, or install equipment such as airbags,

instrument panel and steering wheel.

Improper operations can cause the airbag to malfunction or deploy by mistake, thereby causing severe injury or even death.

- › Do not modify the suspension.

If the vehicle is too high or if suspension stiffness is changed, the airbag may deploy by accident and cause injuries or even death.

- › Please consult with service provider for assistance when you need to install a fender panel and/or baffle at the front of the vehicle.

Modifications to the front of the vehicle can cause distortion to collision signals sent to the airbag sensor, thereby triggering accidental deployment of the airbag, which may cause serious injuries or even death.

- › Please be sure to consult with service provider for assistance when you need to make repairs to the front of the vehicle or the front cab.

Improper repairs can cause distortion to collision signals sent to the airbag sensor, thereby leading to airbag malfunctions, which may cause serious injuries or even death.

Front passenger airbag switch



4E0C48685E83

The front passenger side airbag switch is located on the side of the front passenger instrument panel.

Use a mechanical key to turn the front passenger airbag switch to OFF position to turn off the front passenger airbag. At this moment, the front passenger airbag OFF indicator  on the reading lamp becomes illuminated.

Use a mechanical key to turn the front passenger airbag switch to ON position to turn on the front passenger front airbag. At this moment, the front passenger airbag ON indicator  on the reading lamp becomes illuminated.

NOTICE

After inserting the mechanical key, you should push it to the inserting direction to turn normally.

WARNING

- › Be sure not to place a rear-facing child seat on the front passenger

seat while the front passenger airbag is operational. Otherwise, there will be a serious accident or even death.

- › If, under special circumstances, it is necessary to install a rear-facing child seat on the front passenger seat, please turn off the front passenger airbag. Otherwise, there will be a serious accident or even death.

In other conditions, you are advised not to turn the front passenger airbag lock to OFF, as the front passenger airbag would not be able to deploy if there was an accident.

Side airbags

General

Side airbags are located inside the seat backrest outside liner, and airbag identifications will be made on the seat backrest. Side airbags are the supplement of seat belt. In case of side collision, side airbag will reduce the damages to inside passengers and prevent subsequent collisions.

Operating principle

When the vehicle encounters impact from the side, the sensor will detect an acute change in vehicle speed and then send a signal to the control module. If airbag work condition is met, the side airbags will be deployed instantaneously.

When a side collision occurs, only the

side airbag of impact will deploy. If the impact occurs on the front passenger's side of the vehicle, even if there is no one in that seat, the front passenger airbag will still deploy.

Precautions

- › The side airbag may not deploy when the vehicle encounters mild impact such as what is described below.

Front collision.

Electronic control unit receives a weak signal of mild side impact.

Rear collision.

Rollover.

- › Do not place any object over side airbag. Otherwise, it will disturb the normal work of the side airbag.
- › Never attach any object around the side airbag deployment area. Failure to adhere to this can cause such objects to dislodge when the side airbags deploy.
- › Do not remove, repair or modify seat with side airbag and parts around the side airbag deployment area.

Warning label



This identification is located on the central pillar. It serves to remind you that the vehicle is equipped with side airbags and to pay attention to the relevant issues.

Curtain airbags

General

The curtain airbags are located on the roof lower edge; you can find airbag marks on pillar. The curtain airbags are supplements of seat belts. In case of side collision, curtain airbags will reduce the damages to interior passenger and prevent subsequent collisions.

Operating principle

When the vehicle encounters impact from the side, the sensor will detect an acute change in vehicle speed and then send a signal to the control module. If the curtain airbag work conditions are met, the curtain airbags on the collision side will initiate instantaneously.

Precautions

- › The curtain airbags may not deploy when the vehicle encounters mild impact such as what is described below:
 - Front collision.
 - Electronic control unit receives a weak signal of mild side impact.
 - Rear collision.
 - Rollover.
- › Please do not remain close to the vehicle doors, door pillars or roof rail, or kneel on a front passenger seat. Failure to adhere to the advice can cause passengers' heads to suffer a severe impact when the curtain airbag deploys, which may cause serious injuries or even death. Please be sure to pay attention to it when children are in.
- › Never attach any object around the curtain airbag deployment area. Failure to adhere to this can cause such objects to dislodge when the curtain airbag deploys.
- › Do not hang heavy or sharp objects on the coat hook.
 - Please do not use clothes hangers if you wish to hang your clothing, and opt for the coat hook directly instead. Failure to adhere to this can cause clothes hangers to dislodge when the curtain airbag deploys.
- › Do not remove, repair or modify parts around the curtain airbag deployment



area.

Do not modify roof, roof handrail, roof handrail bracket and side roof lamp.

4

Safety

Child restraint system

Vehicle equipment

Please note that this manual contains all the standard equipment, country-specific equipment and special equipment for this model series. Thus, some equipment or features described in this manual may not be installed onto your vehicle or are only available in some markets. For further configuration information, please refer to relevant sales information or consult with your distributor selling the vehicle to you.

Recommended child seat type

- › Rear-facing child seat, quality group 0/0+.
- › Forward-facing child seat, quality group I / II / III.
- › Cushioned child seat, quality group II / III.

Fixing point for child seat

Lower fixing point of child seat



24EC7743ECC3

There are 4 fixing points on the lower part of the child seat in the clearance between the rear seat backrest and the seat cushion.

Top tether strap fixing point for child seat



BE3CAC37BC48

There are 2 fixing points for the child seat top tether strap on the rear side of rear seat backrest.

! WARNING

Child restraint anchorages are designed to withstand only those loads imposed by correctly fitted child restraints. Under no circumstances are they to be used for adult seatbelts, harnesses, or for attaching other items or equipment to the vehicle.

Applicability information of child seat

Only child seats that meet ECE No. 44 specifications may be installed in the vehicle.

According to ECE No. 44 specifications, child seats can be categorized into five

groups.

- › Group 0: Maximum 10 kg (0~9 months).
- › Group 0+: Maximum 13 kg (0~2 years).
- › Group I: 9 to 18kg (9 months~4 years).
- › Group II: 15 to 25 kg (4 years~7 years).
- › Group III: 22 to 36kg (6 years~12 years).

Applicability information of child seat for different seat positions

Weight group	Seat position			
	Front passenger seat		Rear seats	
	Front passenger airbag ON	Front passenger airbag OFF	Rear-row external side	Rear-row center
Group 0	X	U	U	X
Group 0+	X	U	U	X
Group I	X	U	U	X
Group II	X	U	U	X
Group III	X	U	U	X

Note: The letters filled in the above table are defined as follows:

U-applicable to universal child restraint system certified under this mass group.

X-not applicable to the child restraint system under this mass group.

Please do not install a child seat on the front passenger seat.

This places the child passenger too close to the airbag. In the event of airbag deployment this can cause severe injury or even death to the child passenger.

If the child seat must be installed on a front passenger seat under special circumstances, please pay attention to the following points:

- › Please be sure to turn off the front passenger airbag switch, otherwise it will cause serious danger to children when the airbag deploys.(▷ Page 215)
- › When installing a child seat on the front passenger seat, please adjust the front passenger seat as back as possible.
- › Please do not install a rear-facing child seat on the front passenger seat.

Compatibility of vehicle ISOFIX positions with ISOFIX child seats

Weight group	Size model	Fixed module	ISOFIX position
			Rear-row external side
Portable bed	F	ISO/L1	X
	G	ISO/L2	X
Group 0	E	ISO/R1	IL

Weight group	Size model	Fixed module	ISOFIX position
			Rear-row external side
Group 0+	E	ISO/R1	IL
	D	ISO/R2	IL
	C	ISO/R3	IL
Group I	D	ISO/R2	IL
	C	ISO/R3	IL
	B	ISO/F2	IUF
	B1	ISO/F2X	IUF
	A	ISO/F3	IUF

Note: The letters filled in the above table are defined as follows:

IUF-applicable to general forward-facing ISOFIX child restraint system approved for the mass group;

IL-applicable to special ISOFIX child restraint system of the list. Such restraint systems may be special, restricted or semi-general.

X-not applicable to the ISOFIX child restraint system under this mass group and/or the size classification.

Warning label



This label, which is located on the front passenger's side sun visor, is used to alert you that your vehicle is equipped with front airbag, please note the relevant precautions.

⚠ WARNING

NEVER use a rearward facing child restraint on a seat protected by an ACTIVE AIRBAG in front of it, DEATH or SERIOUS INJURY to the CHILD can occur.

Installation method of child seat

Installation of child seat using child seat fixing device

The ISOFIX or LATCH is standard protective system designed for child seat. You can install child seats on either of the 2 side seats in the rear with ISOFIX or LATCH.

1. Move the front seat as far forwards as possible.

2. Adjust or remove the headrest from the seat where the child seat is to be installed.

i NOTICE

- › For a rear-mounted child seat, adjust the headrest to the lowest position or remove it.
- › For a front-mounted child seat, remove the headrest if it affects the fitting of the child seat back and the rear seat back.
- › If a raised seat cushion is used, it is forbidden to remove the headrest, and the top of the headrest should be adjusted to a position that is flush with or closest to the top of the child's head.

3. Slide the child seat locking mechanism into the lower fixing point to ensure that the two ISOFIX locking mechanisms are properly fixed.
4. Fasten the top tether strap at its corresponding fixing point. Don't curl over the top tether strap. When securing, you must make sure that the top tether strap passes through the bottom of the seat headrest.
5. Shake the child seat gently to make sure that it has been properly secured.

Use the seat belt to install the child seat

1. Move the front seat as far forwards as possible.

2. Adjust or remove the headrest from the seat where the child seat is to be installed.

i NOTICE

- › For a rear-mounted child seat, adjust the headrest to the lowest position or remove it.
- › For a front-mounted child seat, remove the headrest if it affects the fitting of the child seat back and the rear seat back.
- › If a raised seat cushion is used, it is forbidden to remove the headrest, and the top of the headrest should be adjusted to a position that is flush with or closest to the top of the child's head.

3. Pull out the shoulder belt, run the belt along the indicated route on the child seat and insert the lock pin into the buckle until you hear a "click" sound.
4. With your body weight pressing down on the child seat, allow the shoulder belt to retract and tighten. There must be no signs of slack to the shoulder belt.
5. If the child seat is not equipped with a seat belt attachment, you can purchase a locking clip to secure the seat belt.
6. Shake the child seat gently to make sure that it has been properly secured.

Precautions for installing child seats

- › If the rear seat backrests angle is adjustable, adjust it to the appropriate position, so that the cushion and backrest of the child seat can fit closely with rear seat.
- › If the child seat is not installed with ISOFIX, please use the seat belt to install it and then follow the installation instructions attached to the child seat.
- › Properly fasten the child seat inside the vehicle.

If you are unable to install the child seat correctly, in the event of emergency braking or accident, severe injury or even death may occur.

- › Do not place unsecured child seat protectors in the vehicle.

Because if you leave it inside the vehicle, it may come into contact with passengers or other objects in the event of emergency braking or severe impact, causing a severe injury or even death.

- › You should select an appropriate child seat based on your child's age and weight, and secure the child seat on the rear seat.

Accident statistics show that compared to child passengers seated in the front seat, child passengers are safer when they are seated in a rear seat and secured with the appropriate protective measures.

Carrying the child in your lap is not the same as securing the child in a child seat. In the event of an accident, the child may be thrown towards the windshield glass or crushed between you and the vehicle interior trim.

- › Even when the child has been seated in a child seat, take care that his or her head or body is not leaning against the door pillars or roof rail.

When the curtain airbag fully deploys, it can be very dangerous in this scenario as the deployment force may cause severe injury or even death to the child.

- › Depending on the different types of child seat, when installing or removing a child seat, please refer to the install instructions and precautions attached with the child seat.

- › If the child seat is equipped with a top tether strap, tight the top tether strap according to the installation instructions and precautions attached with the child seat.

Otherwise, it may cause severe injury or even death in the event of emergency braking or collision.

- › If the child seat is equipped with a top tether strap, the top tether strap must pass under the headrest.

Otherwise the child seat cannot be fixed securely; in the event of emergency braking or collision it may cause severe injury or even death.

- › Do not lower the headrest after fastening the child seat top tether strap to its fixing point.

Otherwise, it may come into contact with the top tether strap and loosen the strap as a result. In the event of emergency braking or collision, this can cause the child seat to dislodge, bringing severe injury or even death.

Vehicle anti-theft system

Vehicle equipment

Please note that this manual contains all the standard equipment, country-specific equipment and special equipment for this model series. Thus, some equipment or features described in this manual may not be installed onto your vehicle or are only available in some markets. For further configuration information, please refer to relevant sales information or consult with your distributor selling the vehicle to you.

About the system

The vehicle anti-theft system helps to keep your vehicle and valuables from being stolen. The vehicle anti-theft system will emit audible and visual alarm if someone tries to enter the vehicle by force.

WARNING

Do not attempt to modify the vehicle anti-theft system.

System activation

1. After the door is successfully locked by the button on the key, PEPS or the mechanical key, the turn signal lamp flashes once, and the vehicle enters the pre-alarm mode.
In pre-alarm mode, you can still operate the vehicle without triggering the anti-theft alarm.
2. After the pre-alarm mode lasts for

about 15 seconds, the vehicle will automatically enter the defense state and the vehicle anti-theft function will be activated.

CAUTION

Please check whether all the vehicle doors and back door are completely closed. Otherwise, the vehicle anti-theft system cannot be activated.

NOTICE

The center control button will fail in the anti-theft state of the vehicle.

Alarm trigger condition

When the vehicle anti-theft system is on, the following actions can trigger an alarm:

- › Use the mechanical key to open the vehicle doors.
- › When a side door or the back door is forced open.

Alarm cancellation

After triggering the anti-theft alarm of the vehicle, the alarm can be reset by the following operations:

- › Start the vehicle successfully.
- › With the power supply of the vehicle in LOCK mode, unlock the door or back door via a button on the key or PEPS.

System off

The vehicle doors and back door are unlocked via the key button or the PEPS.



The turn signal lamp flashes twice and the anti-theft function of the vehicle is off.

4

Safety

Vehicle equipment

Please note that this manual contains all the standard equipment, country-specific equipment and special equipment for this model series. Thus, some equipment or features described in this manual may not be installed onto your vehicle or are only available in some markets. For further configuration information, please refer to relevant sales information or consult with your distributor selling the vehicle to you.

Emergency cut-off system

In case that the following events occur in normal running of the vehicle, the system will automatically cut off the power supply of the high-voltage system to reduce the risk of electric leakage.

- › The airbag detonates in a severe crash.
- › The vehicle power system has severe fault.

If the above events occur, contact service provider promptly.

Event data recorder

Vehicle equipment

Please note that this manual contains all the standard equipment, country-specific equipment and special equipment for this model series. Thus, some equipment or features described in this manual may not be installed onto your vehicle or are only available in some markets. For further configuration information, please refer to relevant sales information or consult with your distributor selling the vehicle to you.

System introduction

The vehicle is equipped with the event data recorder (EDR).

The event data recorder (EDR) is mainly used to record data related to vehicle dynamic system and safety system when a vehicle collision happens in order to help understand the operation conditions of vehicle system. However, since collision severity and type vary, EDR may not record the data.

i NOTICE

EDR records data only when a vehicle meets a major collision. When the vehicle runs normally, EDR does not record data.

Data reading

Except the vehicle manufacturer, other parties (such as law enforcement agencies) can read the data recorded in EDR

after connecting the laptop with the on-board diagnostic interface to enter the EDR by using CANoe equipment.

The data reading equipment can be purchased from CANoe software vendors.

The data items recorded by EDR and their uses are as follows:

Data item	Applications
Braking state	Record the brake pedal status during collision
Speed during collision	Record the speed at the time of collision
Status of the seat belt lock body	Record the safety belt status during collision
Status of the airbag system warning lamp	Record whether the airbag failure warning lamp is on before collision

Data disclosure

Except for the following circumstances, the data recorded by EDR will not be disclosed to a third party:

- › With the consent of the car owner or lessee.
- › Use it in lawsuits according to the official requirements of the police, courts or government departments.

However, if necessary, the data recorded by EDR will be used for:

- › Research and development of vehicle



safety performance.

- › For research and development, the data can be disclosed to a third party without disclosing specific information about the owner and his vehicle.

5

Emergency

On-board tools.....	232
When the tyre is punctured or the tyre pressure is insufficient	233
In case of vehicle accident...	236
Jump start	238
Towing.....	240
Service and rescue	243

On-board tools

Vehicle equipment

Please note that this manual contains all the standard equipment, country-specific equipment and special equipment for this model series. Thus, some equipment or features described in this manual may not be installed onto your vehicle or are only available in some markets. For further configuration information, please refer to relevant sales information or consult with your distributor selling the vehicle to you.

Storage location for on-board tool kit

As the on-board tool kit is secured under the luggage area cover, you can notice it when opening the cover plate.

5

Emergency

CAUTION

- › The driver himself must be familiar with the placement and use of the on-board tool in order to cope with emergency.
- › You must return the on-board tool kit to their designated positions after use, and fix them securely. Random placement may cause accidents.

When the tyre is punctured or the tyre pressure is insufficient

Vehicle equipment

Please note that this manual contains all the standard equipment, country-specific equipment and special equipment for this model series. Thus, some equipment or features described in this manual may not be installed onto your vehicle or are only available in some markets. For further configuration information, please refer to relevant sales information or consult with your distributor selling the vehicle to you.

Inflator and tyre repair fluid

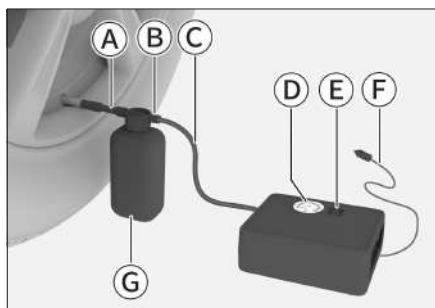

- (A) Outlet tube
- (B) Air inlet
- (C) Inflation tube
- (D) Barometer
- (E) Inflator switch
- (F) Power cable
- (G) Tyre repair liquid

In case of tyre leak caused by puncture of foreign matters, emergency maintenance can be carried out with inflator and tyre repair fluid.

i NOTICE

- › The inflator and tyre repair fluid are only suitable for sealed tyres with puncture on the tread.
- › The tyre repair fluid has limited ability to seal the puncture of the tyre wall. If the tyre has large fissures, cracks or similar damage, tyre repair fluid shall not be used to seal the tyre.
- › The tyre repair fluid tank must be replaced after use. It is recommended that it be replaced by professionals from service provider.

⚠ WARNING

- › If the tyre repair fluid has expired, please replace it and treat it as hazardous waste.
- › Eating the tyre repair fluid by mistake is harmful to health. It may cause allergic reaction even in the case of skin contact. In case of contact with skin, immediately wash the sealing liquid from skin with water or soapy water.
- › The tyre repair fluid must be stored out of reach of children.

Emergency tyre repair

1. If the tyre is repaired in a place where vehicles pass, please put a warning triangle at an appropriate position and turn on the hazard warning lamp.
If the tyre puncture is caused by nails or similar objects, leave the objects in the tyre. This helps to seal the puncture hole.
2. Make sure that the inflater switch is off (in position "0"), and then take out the power cord and inflation tube.
3. Unscrew the cover of the tyre repair fluid inlet, screw up the inflation tube onto the repair fluid inlet, and screw the tyre repair fluid outlet tube into the tyre air valve.
4. Plug the power cord into the 12 V outlet and start the vehicle.
5. Switch the inflater switch to the position "I" to start the inflater and inflate the tyre to 240~250 kPa.

WARNING

Do not stand beside the tyre when operating the inflater. If the tyre is cracked or uneven, the inflater must be turned off immediately.

CAUTION

- › The inflater shall not run for more than 10 minutes; otherwise, there is a risk of overheating.
- › If the tyre pressure is still lower than

180 kPa after inflation, it means that the tyre has a large hole, so please do not continue to inflate it. At this time, you are suggested to contact service provider.

6. Turn off the inflater, remove the power cord from the 12 V outlet, and remove the tyre repair fluid from the tyre valve.
7. Drive immediately (within 1 minute) at a speed of 20~60 km/h for about 5 km, so that the tyre repair fluid can seal the tyre evenly.
8. Connect the inflater and read the tyre pressure on the pressure gauge.
 - › If the tyre pressure is lower than 130 kPa, it means that the tyre is not completely sealed. At this time, do not continue driving and contact service provider.
 - › If the tyre pressure exceeds 130 kPa, the tyre shall be inflated to the pressure specified in the tyre pressure label.
9. Turn off the inflater, disconnect the inflation tube and the power cord, and install the dust cover of the tyre valve.

CAUTION

After the tyre is inflated, it is necessary to install the dust cover of the tyre valve to prevent the gravel and dust from damaging the tyre valve.

WARNING

After the tyre is repaired with inflater and tyre repair fluid, the driving speed shall not exceed 80 km/h and the driving distance shall not be more than 200 km. It is recommended that you repair or replace the damaged tyre as soon as possible, and inform the maintenance technician that the tyre contains tyre repair fluid.

Tyre inflation

When the tyre pressure is too low, you can use an inflater to inflate the tyre.

1. Make sure the inflater is turned off, and take out the power cord and inflation tube.
2. Screw the inflation tube into the tyre valve.
3. Plug the power cord into the 12 V outlet and start the vehicle.
4. Turn the inflater switch to position "I" to start the inflater.

CAUTION

The inflater shall not run for more than 10 minutes; otherwise, there is a risk of overheating.

5. Inflate the tyre to the pressure specified in the tyre pressure label.
6. Turn off the inflater, disconnect the inflation tube and the power cord, and install the dust cover of the tyre valve.

In case of vehicle accident

Vehicle equipment

Please note that this manual contains all the standard equipment, country-specific equipment and special equipment for this model series. Thus, some equipment or features described in this manual may not be installed onto your vehicle or are only available in some markets. For further configuration information, please refer to relevant sales information or consult with your distributor selling the vehicle to you.

Traffic accidents occur to vehicles

When the vehicle is forced to stop on road because of traffic accidents or vehicle failure, in order to warn other vehicles, please take the following measures:

- › Turn on the emergency flashers.
- › Please place the warning triangle behind your vehicle in accordance with local traffic laws and regulations.

WARNING

To reduce the risk of injury and death when a traffic accident occurs, please observe the following precautions:

- › If bare wires are detected inside or outside the car, do not touch them to avoid electric shock.
- › Do not touch the high-voltage components, orange high-voltage cables and their connectors inside the vehicle. Otherwise, serious injury or

death caused by electric shock may occur.

- › If there is a liquid leakage, or liquid is found flowing into the components or parts inside the vehicle, do not touch such liquid. It may be a liquid leaking from the power battery pack. If the skin or eyes are inadvertently exposed to the liquid, rinse with plenty of water and seek medical advice immediately to avoid further injury.
- › If you are not sure whether the vehicle is damaged or safe, stay away from the vehicle and contact service provider immediately and indicate that the accident vehicle is an electric one.
- › When an accident causes a fire on the vehicle, use a special fire extinguisher for electrical fires to extinguish the fire. Use of water or improper fire extinguishers may result in serious injury or death due to electric shock.

For the fire accident of vehicle:

If heavy smoke emits from the vehicle or a fire accident occurs, you shall pull over to a sparsely populated place immediately, switch the vehicle power supply to LOCK mode, and evacuate passengers away from the vehicle quickly. Under the condition of ensuring personal safety,

perform the following operations conditionally:

- › Call the police according to the on-site situation.
- › If you can confirm that the fire is small and does not involve a high-voltage system, you can try to use a vehicle fire extinguisher to extinguish the fire in time; if the fire is large or the origin of fire is near the power battery, immediately move away from the vehicle and stand to the upwind position. Do not use water to extinguish the fire by yourself to prevent the risk of electric shock.
- › Anyone inhales heavy smoke accidentally shall be transferred for medical attention as soon as possible.

WARNING

- › The burning of lithium batteries will produce high temperature and harmful gases, so please stay away from the burning vehicle as much as possible.
- › Please do not touch any liquid leaked from the power battery. In case of contact with skin or eyes accidentally, please rinse immediately with plenty of water and seek medical advice in time to avoid greater damage.
- › If firefighters use water to extinguish the fire, please do not touch the ground water to avoid the risk of electric shock.

- › Due to the possibility of reburning of the lithium battery, even if the open fire is extinguished, do not approach the vehicle rashly and note whether the vehicle still has heavy smoke or open fire.

Jump start

Vehicle equipment

Please note that this manual contains all the standard equipment, country-specific equipment and special equipment for this model series. Thus, some equipment or features described in this manual may not be installed onto your vehicle or are only available in some markets. For further configuration information, please refer to relevant sales information or consult with your distributor selling the vehicle to you.

Symptoms of a drained vehicle battery

- › The vehicle cannot be started.
- › Headlamps are darker than normal.
- › The horn cannot give a sound or the sound is weak.

How to jump start the vehicle

If you are unable to start the vehicle with depleted battery, you can jump to the battery of using another vehicle to start the vehicle.

The wire cross-section of cable is no less than 25 mm².

⚠ CAUTION

- › Batteries of some vehicles may not be used. Jump start can only be performed with a battery having a rated voltage of 12V.
- › You cannot start the vehicle by using

a trolley or trailer.

1. Connect the booster cables in the following order.

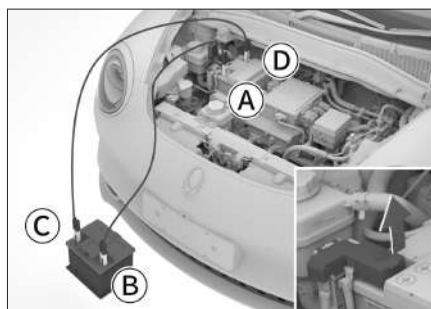

772D995CA907

- Ⓐ Positive terminal on charging battery of the drained vehicle ⊕
When connecting, open the protective cover on the positive terminal of the battery first.
- Ⓑ Positive terminal on charging battery of the rescue vehicle ⊕
- Ⓒ Negative terminal on charging battery of the rescue vehicle ⊖
- Ⓓ Negative terminal on charging battery of the drained vehicle ⊖

2. Recharge the battery.

Start the recovery vehicle and keep it for about 5 minutes to temporarily charge the depleted battery of the vehicle.

3. Start the vehicle with depleted battery.

If still unable to start the vehicle, check that the jumper cables have been connected correctly, and then allow the battery to recharge a little

more.

4. Remove the jumper cable.

Once the vehicle is started, remove the jumper cable in an order contrary to the connection.

⚠ WARNING

- › During charging or jump starting, gas may escape from the battery. There is a risk of explosion at this time. Keep the battery away from sparks, open flames and other flammable materials.
- › Battery fluid is corrosive, and it can cause serious injury to eyes and skin. In case of accidental contact, please rinse immediately with plenty of water and seek medical attention immediately.
- › When connecting or removing jumper cables, you cannot wind the cables with fans, belts and the like.
- › Ensure that all cables are connected correctly, and keep a certain distance between their ends to avoid contact between positive and negative poles.

⚠ CAUTION

If a battery is often lack of electricity, please get to service provider for inspections.

Towing

Vehicle equipment

Please note that this manual contains all the standard equipment, country-specific equipment and special equipment for this model series. Thus, some equipment or features described in this manual may not be installed onto your vehicle or are only available in some markets. For further configuration information, please refer to relevant sales information or consult with your distributor selling the vehicle to you.

Use a professional transport

Do not tow this car with wheels on land. When the vehicle is damaged, please transport it with platform vehicle and contact with service provider.

⚠ WARNING

- › You must comply with local regulations regarding trailer towing.
- › This vehicle can only use platform to transport. Do not transport it with its wheels on land. Otherwise, the vehicle may be seriously damaged.
- › Do not tow your vehicle with tow hook, tow rope or iron chains.

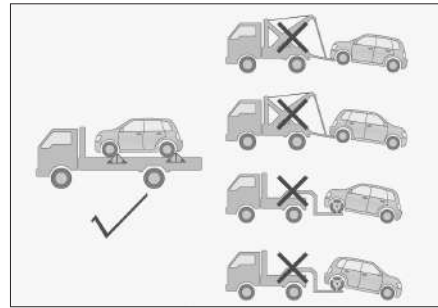

1F86B96D343A

When transport the vehicle, you must lock the vehicle firmly.

Push the vehicle

⚠ WARNING

Please do not push the vehicle over a long distance downhill to coast.

In order to let the vehicle far away from danger area, you can push the vehicle no more than 50 m with the maximum speed no more than 5 km/h.

It should meet the following conditions when pushing the vehicle:

1. Start the vehicle and switch the gear to N position.
If the vehicle will not start, switch the supply mode to ON and shift the gear to "N" position.
2. Turn on the hazard warning lamp and release the parking brake to push the vehicle.

When the vehicle gets stuck or bottoms out,

When driving in snow, mud and sand, the vehicle is easy to get stuck or bottom

out. Therefore, you shall drive carefully.

If the vehicle gets stuck, you can try the following operations:

1. Engage into N gear, apply the parking brake, and switch the vehicle power supply to LOCK mode.
2. Remove the mud, snow or sand around the stuck tires.
3. Place wood blocks, stones or other materials to help improve the tire adhesion.
4. It is recommended to select a suitable driving mode to restart the vehicle.
5. Release the parking brake. Be careful to accelerate and get the vehicle out of the pit.

⚠ WARNING

While freeing the vehicle, you should pay attention to the following:

- › Make sure that the surrounding area is clear and free from any other vehicles, objects, or persons.
- › The moment the vehicle gets out from the pit, it will suddenly rush forward or backward, so be careful.

When the vehicle gets stuck or bottoms out, please contact professional rescue teams or service provider if the vehicle cannot get out of the trap in the methods above. Dragging unprofessionally for rescue is prohibited.

⚠ WARNING

Please observe the following precautions during rescue. Otherwise, it will easily cause vehicle damage and even endanger personal safety.

1. When trailer hook is used to tow the vehicle, a recovery blanket must be tied in the middle of the tow rope to prevent the trailer hook or rope from breaking and rebounding, which may cause vehicle damage and even endanger personal safety.
2. It is forbidden to drag the vehicle from the side or vertically, with the best angle of trailer hook within the range of 5° up and down and 25° left and right.
3. It is forbidden to drag the vehicle during race start. The initial towing speed shall not exceed 5 km/h (start slowly until the tow rope is taut).
4. When the vehicle is to be dragged with a trailer hook, the drag/ towing force shall not exceed the weight of the vehicle.

Tow hook

Front tow hook

1. In the gap at the tow hook cover, pry down the cover using a flathead screwdriver wrapped by the cloth.



2. Screw the tow hook clockwise into the hole and tighten it to ensure that it is securely installed.



5

Emergency

Vehicle equipment

Please note that this manual contains all the standard equipment, country-specific equipment and special equipment for this model series. Thus, some equipment or features described in this manual may not be installed onto your vehicle or are only available in some markets. For further configuration information, please refer to relevant sales information or consult with your distributor selling the vehicle to you.

On-board phone

On-board phone buttons and indicator lights are located on the reading light panel.

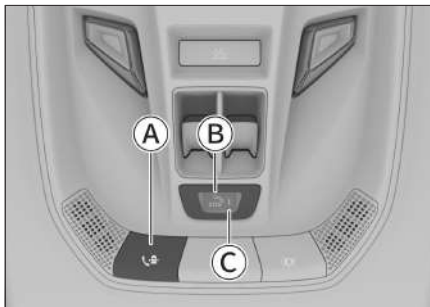

- (A) Manual service button (☎)
- (B) Emergency rescue button (🚑)
- (C) IOV function indicator light

Press the cover to open it to operate the emergency rescue button.

⚠ WARNING

When the emergency rescue button does not need to be operated, please

close its cover.

i NOTICE

1. The communication equipment complies with NBTC standards or technical requirements.
2. The communication equipment has an electromagnetic field intensity that complies with the *Safety Standards for the Use of Radio Communication Equipment for Human Health* published by the National Telecommunications Commission.

Manual services

Press and hold the ☎ manual service button to trigger a manual service call.

Through manual services, you can search for destinations and points of interest, inquire about information, book services, consult on car networking problems, request road rescue, etc.

During the manual service call, press and hold the ☎ manual service button to end the call.

Emergency rescue

Press and hold the 🚑 emergency rescue button to trigger an emergency rescue call. During the emergency rescue call, press and hold this button again to end the call.

In the event of a collision (when the airbag is deployed), an emergency rescue call will be triggered automatically, and

the call cannot be manually ended.

After an emergency rescue call is triggered, the rescue center will immediately accept the rescue request from the vehicle.

i NOTICE

Do not randomly and frequently trigger the emergency rescue calls.

⚠ CAUTION

The function of emergency rescue call is affected by various factors. Thus, the emergency rescue call may be unavailable in case of any of the following cases (including but not limited to):

- › If the vehicle networking system fails or is damaged, it will be impossible to trigger an emergency rescue call.
- › If the audio equipment is damaged, or the harness connected to the vehicle networking system and the audio equipment is damaged or connected falsely, it will be impossible to make normal rescue calls with the customer service.
- › If the airbag fails to deploy in a minor collision or abnormality, it will be impossible to automatically trigger the rescue call. In this case, you can trigger the emergency rescue call manually or make the call by other means.
- › If the emergency rescue button is damaged, the emergency rescue call

cannot be triggered manually.

- › If the mobile network signal (cell phone signal) is weak, interfered, or blocked, etc., it will be impossible to trigger an emergency rescue call.
- › In areas (such as underground parking lots, tunnels, and mountain areas) where the GPS equipment is damaged or the signal is weak, it may be impossible to locate the vehicle.
- › After the vehicle is powered off, it may be impossible to trigger an emergency rescue call.
- › The emergency rescue services may not be available due to riots, fires, floods, storms, explosions, wars, government actions, orders given by judicial administrative organs, social environment, and other force majeure factors.
- › The emergency rescue services may not be available if other software you have downloaded and installed or other websites you have visited contain viruses, Trojans or other malicious programs and threaten the security of your equipment and data.
- › Situations where other objective factors render the emergency rescue call unusable.

Car networking function indicator

Status of indicator light	Description
OFF	The car networking system has no network connection (for example, the SIM card used is not registered or cannot be connected to the network).
Orange lamp normally on	Disconnect the battery and re-connect it, indicating that the car networking system is starting.
Orange lamp flashing	During the starting of the car networking system, it is in a call state.
Green lamp normally on	The car networking system works normally and has normal network connection.
Green light flash	The car networking system is in a call state.
Red lamp normally on	The car networking system fails to pass the self-inspection and is in an error state.

WARNING

It is forbidden to modify the car networking system.

NOTICE

Please observe the following

suggestions during daily use:

- › Regularly check whether the car networking system is running normally. The indicator of the car networking system is green, indicating that the system is normal. If there is a fault, please go to the service station for inspection and maintenance in time.
- › It is recommended to replace the built-in battery of the car networking equipment once every 3 years at most. Please go to the service station to replace the battery in time.

6

Maintenance

Necessity of vehicle maintenance	248
Engine compartment	249
Parts replacement	255
Vehicle maintenance	259

Necessity of vehicle maintenance

Vehicle maintenance is a health diagnosis of the vehicle, which can reduce the trouble of repairing the vehicle.

The components and parts of vehicle will inevitably wear during use. To ensure safe driving conditions, it is necessary to repair and maintain the vehicle regularly to restore and maintain the vehicle performance.

Vehicle maintenance makes you drive more securely

During the maintenance process, you can carry out necessary preventive maintenance according to the use of the components and parts, so as to prevent problems before they occur and make you drive securely before the next maintenance.

Extend the service life of the vehicle and reduce the cost of using the vehicle

Components and parts such as brake linings and tyres, etc. are not permanently usable, which will gradually wear out while in use. Use of components and parts that exceed the wear limit is likely to cause vehicle breakdown and even lead to traffic accidents. Therefore, it is necessary for regular maintenance.

Vehicle equipment

Please note that this manual contains all the standard equipment, country-specific equipment and special equipment for this model series. Thus, some equipment or features described in this manual may not be installed onto your vehicle or are only available in some markets. For the further configuration information, please refer to relevant sales information or consult with your distributor selling the vehicle to you.

Tips for safety

WARNING

- › The engine compartment is a hazardous area of operation and must be handled with extreme caution!
- › To avoid personal injury, do not touch high-voltage components, cables and connectors.
- › Do not touch the radiator fan while the drive motor is hot, as the fan may suddenly start automatically. Long scarves, ties, and other articles of clothing may become tangled in revolving parts, resulting in serious injury.
- › Never carry out relevant inspection work when the vehicle is started, because rotating parts (such as radiator fans), high-voltage components, power systems, etc. may lead to other dangers.
- › When performing oil check and filling operations, observe the following precautions, otherwise it may cause burns, fire or electric shock:
 - Switch the power supply to LOCK mode.
 - Apply the parking brake.
 - Let the drive motor cool completely.
 - Keep children away from the engine compartment.
 - Do not allow water to come into contact with the engine compartment.
- › Observe the following precautions when performing electrical installation work. Failure to do so may result in fire:
 - Disconnect the negative terminal of the battery.
 - Do not smoke.
 - Do not operate near open flames.

⚠ CAUTION

When adding fluid, be careful not to misuse it. Otherwise it may cause serious functional defects or damages to vehicle components.

Fluid level

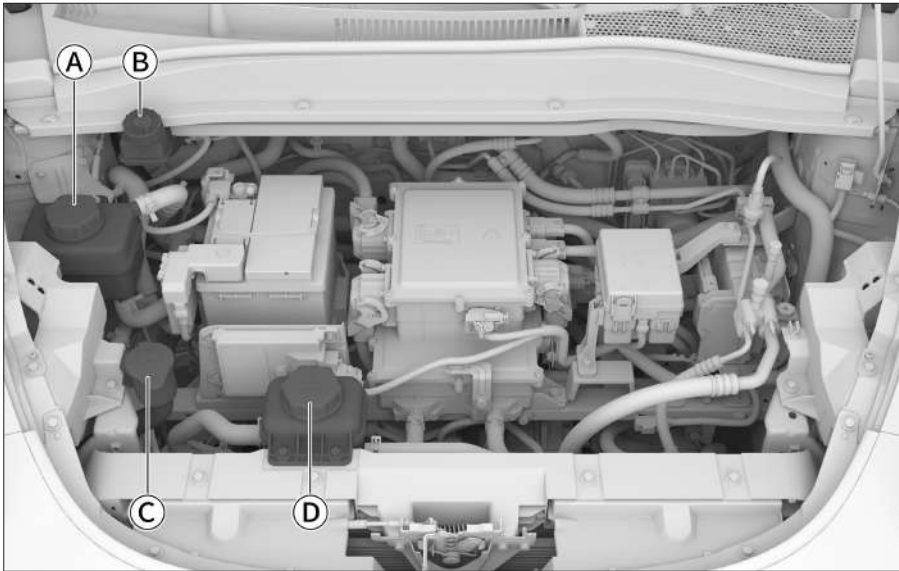

EBADFB27785A

6

Maintenance

- Ⓐ Engine coolant overflow tank for the heating system
- Ⓑ Brake fluid reservoir
- Ⓒ Windshield washer fluid reservoir
- Ⓓ Engine coolant overflow tank for power system

Brake fluid

Checks

The fluid level in the tank should be checked regularly.

Check that the fluid level in the tank is between the minimum and maximum marked levels.

If the brake fluid level is lower than the minimum level marked, top up with new brake fluid until the level is between the maximum and minimum levels marked. Also make sure that the braking system shows no signs of leakage.

Filling

Pry open the tank cover. Pour in the fluid slowly to prevent overflow. Any oil overflow must be removed immediately. Otherwise, the spilled oil may cause damage to the compartment components.

Please only use brake fluid that meets specifications.

WARNING

- › Insufficient brake fluid levels can compromise brake performance and increase the risk of an accident.
- › Brake fluid is harmful to the human body and corrosive. In case of accidental contact, rinse immediately with plenty of water. If you ingest it, go to a hospital immediately.

Coolant

Checks

The water level in the overflow tank should be checked regularly.

Check that the fluid level in the overflow tank is between the minimum and maximum marked levels.

If the coolant level is lower than the minimum level marked, top up with new coolant until the coolant level is between the maximum and minimum levels marked. Also make sure that the cooling system shows no signs of leakage.

Filling

After the engine compartment cools down, slowly open the cover to release the pressure.

If the coolant spills, you must wash it with water to prevent parts or paint from being damaged.

Please use only coolant that meets the specifications.

WARNING

- › The coolant contains ethylene glycol to lower its freezing point. Indiscriminate disposal may lead to water pollution.
- › Do not open the overflow tank cover when the engine compartment is at a high temperature. There may still be some pressure inside the cooling system. Opening it at this point may cause burns or other injuries when

heated coolant spurts out.

- › Please contact service provider if you need to replace the coolant.

Windshield washer fluid

Filling

Open the tank cover. Pour in washer fluid slowly to prevent overflow. Any oil overflow must be removed immediately. You should use high-quality washer fluid for better cleaning capabilities and for anti-freeze protection in cold season.

⚠ WARNING

Do not top up washing fluid when the engine compartment is at a high temperature, or when the drive motor is working. This is because the washing fluid contains alcohol. Spilling the fluid on the components in the engine compartment may lead to a risk of fire.

⚠ CAUTION

Please do not top up liquids such as soapy water into the tank in place of the washing fluid. Otherwise, the paint on vehicle body may be damaged.

Active intake grille

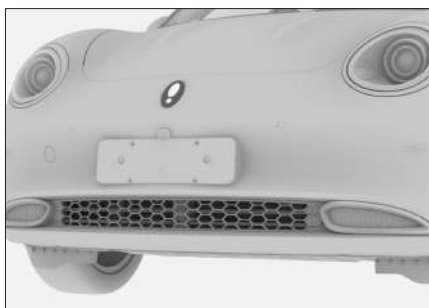

BA76B8D19E35

On the basis of giving priority to meet the heat dissipation requirement, the active intake grille can control the opening angle of the grille blade so as to reduce the resistance of high-speed driving, reduce the energy consumption and improve the comfort of the passengers.

The grille blade will be open automatically when the requirement of opening the cool system or air condition system is detected.

Keep clean of the active intake grille in daily life.

Battery

The vehicle is equipped with a maintenance-free battery.

When the battery shows low level, it is necessary to charge or replace the battery in time. Please head to service provider for service if you need to replace the battery.

Safety labels and identifiers

Engine compartment warning label

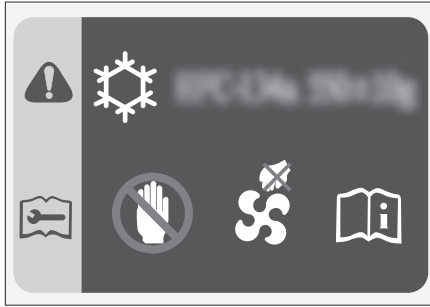

6FC9C3B803CD

This label is located on the front cover plate of the front bumper to prompt you:

- › The type and filling amount of air conditioning refrigerant.
- › The cooling fan may be started at any time. Do not put your hand into the fan shield. Otherwise, when the fan is started unexpectedly, serious personal injury may be caused.

Overflow tank warning label of the heating system

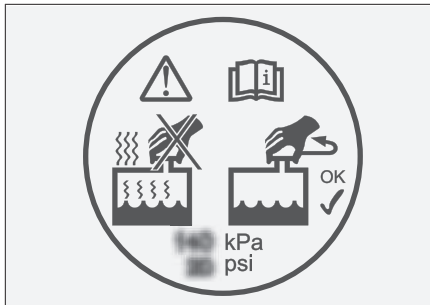

7292828C8D61

The identifier is located on the overflow

tank cover. It serves to remind you to refrain from opening the overflow tank cover when the heating system is activated or not fully deactivated. Otherwise, the hot liquid and steam will be forced out under pressure, resulting in burn.

Overflow tank warning label of power system



265F2549F1C8

The label is located on the overflow tank cover of the power system. It serves to remind you to refrain from opening the overflow tank cover when the drive motor is overheated. Otherwise, the hot liquid and steam will be forced out under pressure, causing burns.

Battery warning label



340CF5EC9B21

This label is located on the battery to

inform you of the following precautions before installing, removing, or inspecting the battery:

- › Children should be kept away from the battery.
- › The battery may produce flammable gases in the use or charging process, so it should be away from high-temperature heat source and open flame. Otherwise a fire or explosion is likely to occur.
- › The battery contains corrosive liquid.
- › Take necessary protective measures such as wearing goggles during operation.

Vehicle equipment

Please note that this manual contains all the standard equipment, country-specific equipment and special equipment for this model series. Thus, some equipment or features described in this manual may not be installed onto your vehicle or are only available in some markets. For further configuration information, please refer to relevant sales information or consult with your distributor selling the vehicle to you.

Fuse

If any electrical components do not work, the fuse may have been blown out. In this case, it is recommended that inspections should be carried out based on the following operations and the fuses should be replaced if necessary:

1. Turn off all electrical components.
2. Turn the power supply to the LOCK position, apply the parking brake and disconnect the negative terminal of the battery.
3. The fuses are located in the following positions:

> Located in the fuse box of the engine

compartment



3F97DEAA4115

Press and hold the pawl, and meanwhile pull up the fuse box cover to open the fuse box.

> Located in the instrument panel near the steering wheel

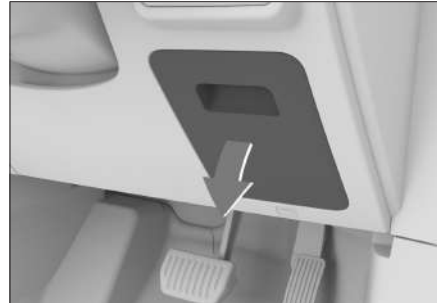

916FD09A4C26

Remove the box cover and you can see it.

⚠ CAUTION

- > Bringing water or other liquids into the fuse box is forbidden, as this may damage the electrical components.
- > When installing the fuse box cover, make sure it is properly located on the fuse box. Otherwise, penetration of moisture or dirt will affect the use of fuses.

- Use the safety clips in the vehicle to pull out the fuses. Find the fuse of the faulty electrical appliance according to the fuse label and check it.

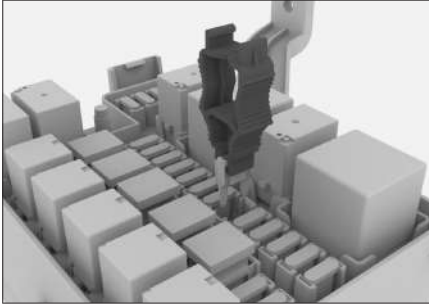

518A7B6272F2

⚠ CAUTION

- › The fuse clip and the spare fuse are located in the engine compartment fuse box.
- › Fuse labels are attached to the cover of the engine room fuse box and that of the instrument panel fuse box. With these labels, the relationship between fuses and electrical components can be determined.
- › Since there may be more than one fuse causing the failure, it needs to check all the fuses that may cause the failure before the failure disappears. If the failure cannot be eliminated in the end, please contact service provider for handling.

- Check the wire inside the fuse. If it is blown out, replace it with a spare fuse with the same amperage.

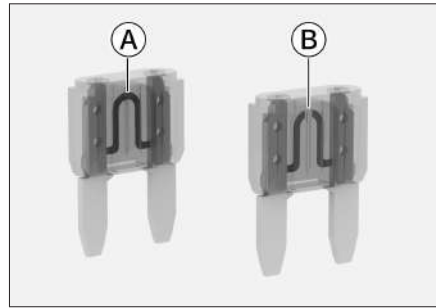

6DC672024A26

- Ⓐ Normal fuse
- Ⓑ Blown fuse

⚠ WARNING

For blowout fuses, do not try to repair or replace them with fuses with inconsistent colors or amperages; otherwise, a fire will occur due to cable overload.

- Check whether the electrical components return to normal operation.

⚠ CAUTION

If a spare fuse with the same amperage is blown out again in a short time or the electrical components do not return to normal operation, it indicates that the vehicle may have a serious electrical system failure. At this juncture, please contact service provider for assistance in a timely manner.

Wiper blade

Front wiper blade replacement

You should regularly check the wiper blade. Replace the wiper blade immediately if you discover the following conditions:

- › Cracks or hardened areas are found on wiper blades.
- › When using a wiper, leave streaks or scratch.

⚠ CAUTION

When lifting and putting back the wiper, you shall not pull the wiper blade directly to avoid deformation or even damage.

1. Switch the power to the LOCK mode, and pull up the wiper control combination switch vertically to the steering wheel and hold for about 3 seconds. Then the wiper will automatically reach the service position, as shown in the figure.



50A406D21264

2. Lift the wiper arm from the windshield.

⚠ CAUTION

- › To lift the wiper, be sure to bring the wiper to the service position. Otherwise, the wiper will be damaged.
- › Do not open the engine compartment cover while the wiper is lifted.

Doing so can cause damage to the engine compartment cover and the wiper.

3. Remove the wiper blade from the wiper arm.

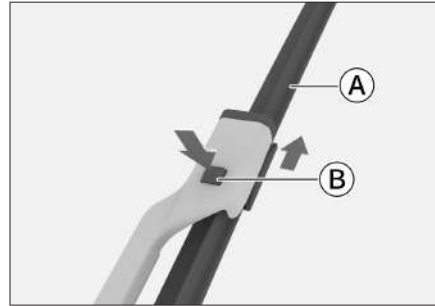

185700633595

- Ⓐ Wiper blade
- Ⓑ Flexible cleat

Press down on the flexible cleat and pull the wiper blade in the direction indicated at the same time until it separates from the wiper arm.

⚠ CAUTION

When the wiper blade is not installed, never place the wiper arm directly on the windshield as it is capable of scratching the windshield.

4. Install a new wiper blade and return the wiper back to the windshield.
5. Reset the wiper to the initial state.
If the power supply is turned to ON mode, the wiper will be automatically reset to initial state.

Bulbs

The front combination lamps on a new

vehicle have been calibrated at the factory. If you often carry heavy items in the vehicle, the front combination lamps may need to be re-calibrated. The calibration of the front combination lamps should be done at a service provider.

Bulb inspection

You should regularly check the condition of the exterior lights. Burnt-out bulbs will lower visibility and also the vehicle's ability to signal to other drivers in the dark. This means that vehicle safety will be severely compromised under such circumstances.

Replacing bulbs

Bulbs should be replaced by a professional.

Normally, you should not replace damaged bulbs yourself, and should allow a professional to perform this job. The primary reason is: before replacing the bulbs you must remove other parts from the vehicle, especially so for those bulbs that can only be removed from inside the engine compartment. Because of this, we recommended that you visit a service provider to replace the bulbs.

WARNING

- › The inside of the bulbs is pressurized, and there is a danger of injury as they may burst during replacement!
- › If the vehicle is equipped with a xenon lamp, do not turn on the

headlamp when replacing the xenon bulb. Otherwise, high voltage may cause serious bodily injury.

- › Modification of external lighting and signaling devices is prohibited.
- › It is forbidden to add external lighting and signaling components beyond what is in the compulsory standard specifications.

About lamps fogged

Under conditions such as driving or washing vehicle on a rainy day, there may be fog inside the lamp cover. This is caused by the temperature difference between the inner and outer air of the lamps and it is the same phenomenon with the window glass fogging on rainy days. It doesn't mean any problems in function. However, when a significant amount of water or water vapor accumulates inside the lamp cover, please contact service provider for assistance.

CAUTION

Do not use chemical solvents or strong cleaning agents to scrub the external lamp cover to avoid damage to the external lamp cover.

Vehicle equipment

Please note that this manual contains all the standard equipment, country-specific equipment and special equipment for this model series. Thus, some equipment or features described in this manual may not be installed onto your vehicle or are only available in some markets. For further configuration information, please refer to relevant sales information or consult with your distributor selling the vehicle to you.

Tyre maintenance

To ensure a safe drive, make sure that the tyres used suit your vehicle and that they possess a good tread and appropriate tyre pressure.

WARNING

- › Do not use the excessive wear tyres or tyres with insufficient tyre pressure; doing so may lead to an accident or injury.
- › You must abide by all manual instructions regarding tyre inflation and maintenance.
- › Burning tyres by individuals produces toxic gases. Please head to a service provider for service.

Tyre check

When checking tyre inflation state, you should also check that there is no external damage, embedded foreign objects

or excessive wear, etc.

If any of the following circumstances are found, you should replace the tyre as soon as possible:

- › There is damage and bulging in the tyre tread or side.
- › There is excessive wear to the tyre tread.

Tyre pressure

Maintaining appropriate tyre pressure levels can maximize vehicle handle ability, tyre tread life and drive comfort.

Uneven wear of under-inflated tyres also impacts the handling of the vehicle and fuel consumption, and may cause tyres to go flat due to overheating.

Over-inflated tyres can lead to an uncomfortable ride as well as damage to the tyre due to uneven road surfaces, as well as uneven wear to the tyres.

It is recommended that you check the tyre pressure regularly, including the spare tyre (if equipped).

Tyre pressure should be measured when the tyre is cold. If parking is more than 3 hours or driving distance is not more than 1.5 km, then the measurement will get more accurate data. When checking tyre pressure after the tyre has been warmed up (after a drive), the pressure reading will be 30 to 40 kPa higher than the cold-state reading. This is normal. Do not deflate the tyre to achieve recommended cold-state pressure levels at this point as this will lead to

insufficient tyre pressure levels.

i NOTICE

The tyre pressure in normal tyres can go down by 10 to 20 kPa every month. Please check regularly.

Tyre wear

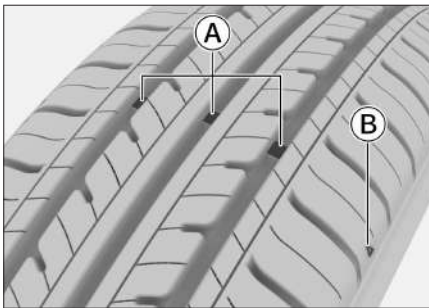

- Ⓐ Tyre wear mark
- Ⓑ Tyre wear mark position figure

i NOTICE

Tyre wear mark position figure is a schematic diagram, which is used for reference only. Please refer to the actual vehicle.

You must replace tyres as soon as possible once they have been worn down to the maximum tolerable limit.

If you continue to use tyres with shallow treads or where the tyre wear mark has appeared, it will lead to situations such as longer braking distances, difficulties in steering and cracked tyres and possibly accidents as a result.

If you find tyre wear uneven, or feel a

certain continuous vibration when driving, go to a service provider.

When installing new tyres, tyre balancing must be performed to ensure ride comfort and to prolong tyre use life.

Tyre rotation

In order to extend the life of the tyre and make tyre wear even, it is recommended that the tyres of the rear and front wheels should be exchanged on a regular basis.

The tyre rotation should be done by the professionals and it is recommended to be done by a service provider.

Wheel balance

Unbalanced wheels can affect vehicle manipulation performance and tyre life. Even under the normal use conditions, the wheels may lose their balance. Therefore, the wheels should be balanced according to the wheel balancing parameters.

Avoid tyre flatness

If the vehicle is parked in a high temperature environment for an extended period of time, a slight deformation of the tyre in the contact position with the ground may occur, which is called "Tyre flatness", which is normal. However, when the vehicle is running, the vehicle body and steering wheel may shake. As the mileage increases, the tyre will get hot and return to its original shape, and

the shake will gradually disappear.

When the vehicle is stationary for an extended period of time, the tyre flatness can be minimized by any of the following methods:

- › The tyre pressure can be increased (about 300 kPa), which cannot be used for normal driving. Before driving, the tyre pressure must be restored to the recommended tyre pressure.
- › Vehicles must be moved at least once every 30 days (15 days best) and the movement must be rotated at least 90°.

Sunroof maintenance

Daily maintenance frequency

The daily maintenance frequency depends on the driving condition and the use frequency of the sunroof.

If you are driving through sandy areas or areas with high rainfall levels, it is recommended that you increase the frequency of routine maintenance.

CAUTION

If the sunroof is not maintained on schedule, it can lead to sunroof leaks or abnormal noise. Adjust maintenance frequency depending on the conditions of use. For instance, in sandy zones or during seasons when there is higher usage, you should increase the frequency of routine maintenance.

Routine maintenance procedure

Dust and impurities may be concentrated in the sunroof seal strip, mechanical parts or rails, which may result in an abnormal sound or malfunction of the sunroof and also clogging the drainage system. Regularly open the sunroof, remove dust and impurities, and use clean cloth and water to wipe the sunroof seal strip surface, as well as regularly apply grease on the mechanical parts for maintenance.

Open up the sunroof and check that the sunroof does not show signs of being obstructed in the course of operation. If yes, please head to a service provider for services.

CAUTION

- › When the sunroof malfunctions, please head to a service provider as soon as possible for check and maintenance.
- › In cold icing conditions, do not try to force open the sunroof to prevent damage to the sunroof motor and sunroof seals. You must wait for the interior temperature to rise and for seal strips of sunroof and sunroof opening to defrost before you try to open the sunroof.
- › Open the sunroof after washing the vehicle in cold icing conditions. Use a piece of soft, dry cloth to wipe dry seal strips of sunroof before driving.

- › The sunroof must be closed fully before the vehicle enters a car wash facility. Do not allow water jets to be pointed directly at seal strips of sunroof. Keep off the water from vehicle due to the deformation of the seal strip under the pressure of the high pressure water column, as a result, it may damage the seal strip.
- › When driving on bumpy roads or in hilly areas, do not open the sunroof fully for extended periods of time as the vibrations may cause damage to internal sunroof components.
- › During the rainy season, step up checks for any sand or dust on seal strips of sunroof, and remove them in a timely manner to ensure good sealing performance of sunroof.

Exterior maintenance

Wash vehicle

A regular vehicle wash helps to protect its appearance. Dust and gravels can scratch the paint surface while fallen leaves and bird droppings can damage the finish of the vehicle body.

Wash your vehicle in a cool spot that is not under direct sunlight. If the vehicle has been parked under direct sunlight for some time, you must move the vehicle to a cool spot and wait for the exterior of the vehicle to cool down before cleaning.

Clean methods

1. Check that there are no fallen leaves, bird droppings, etc., on the vehicle body.
Clean these dirt with a rag or a scavenger, then rinse immediately with clean water so as not to damage the vehicle body surface finish.
2. Wash the vehicle thoroughly with water to remove surface dust.
Clean your vehicle with water, cleaning solution and a soft brush, sponge or soft cloth.
3. Fill a bucket with water. Add automobile detergent to prepare a solution. Start your cleaning from the roof and work downwards.
4. After washing and cleaning the entire vehicle, use leather or a soft towel to dry off the vehicle. Do not allow the vehicle to dry out naturally as this may cause the vehicle body to lose its luster or generate water stains.

⚠ CAUTION

- › Chemical solvent and strong cleaning solution can cause damage to the vehicle body paint as well as metal and plastic components of the vehicle.
- › After washing the vehicle or driving through flooded road, step on the brake pedal lightly to make sure that the brake works normally.
- › When washing the vehicle in cold seasons, do not flush the gaps in the keyholes or doors, etc. to prevent the

lock hole or seal strip from freezing.

- › When washing the vehicle, it is not allowed to open the charging port cover to flush the inside.

Waxing

Waxing is conducive to vehicle maintenance, and the vehicle must be thoroughly cleaned before waxing in order to ensure the effect of waxing.

At present, there is a wide range of car wax in the market, and the car wax performance is different, so you must be careful when selecting the wax. Otherwise, the wax will result in paint discoloration instead of protecting the vehicle body.

Under normal circumstances, the role and characteristics of car wax, the degree of vehicle age, paint color and driving environment and other factors should be taken into account. For details, please contact a service provider or professionals.

Repairing paint surfaces

Always check to see if there are any paint dropped off or scratches on the vehicle body surface. If such a phenomenon occurs, it should be repaired immediately to prevent corrosion of the metal in the damaged area.

Repair paint can only be used to repair small areas of dropped-off paint or scratches, large areas of dropped-off

paint should be repaired by professionals.

Liquid leakage check

Park your vehicle on a flat surface and leave it for a while. Check under the vehicle whether there is any liquid leakage. In case of the apparent leakage, please contact a service provider for service.

Interior maintenance

⚠ WARNING

Cleaners may contain harmful substances and the people may subject to a danger of injury if affected. When cleaning the internal vehicle, it is recommended to open the vehicle door or vehicle window. Only the cleaner specified for vehicle cleaning shall be used and the instructions on the package shall be noted.

⚠ CAUTION

Bringing water or other liquids into the vehicle electrical components is forbidden, as this may damage them.

Carpet

The dust on the carpet should often be vacuumed by a vacuum cleaner. Too much dust will accelerate the damage of the carpet.

Wash the carpet regularly with detergent, which can keep the carpet clean. Foam carpet cleaner should be used. To keep carpeting as dry as possible, do not

add water to the foaming cleaning solution.

Textile fabrics

The dust and dirt on the textile fabrics would often be vacuumed by a vacuum cleaner.

For general cleaning, use a clean soft cloth soaked with mild and neutral soapy water. To avoid watermarking after drying, wipe it with another clean, soft damp cloth and then dry in the air.

To remove stubborn stains, use a textile fabric cleaner. Please follow the detergent instructions to operate.

Leather

Dust and dirt should be vacuumed regularly by a vacuum cleaner, especially creases and seams.

Clean the leather with a soft cloth soaked with water and then polish it with another soft dry cloth. If you require further cleaning, you may use a special leather cleaner.

After wiping with a leather cleaner, follow up with a piece of soft and dry cloth to clean off any residue as quickly as possible. Never allow a leather cleaner be placed on any inside surface for extended periods of time. Certain leather cleaners can cause the resin or fibers in inside textiles to fade or break up.

Rubber parts

Affected by the environment, the rubber

parts may be covered with stains and tarnished on the surface. Thus the rubber parts should be cleaned regularly by the rubber curing agent, especially the worn rubber parts.

In order to avoid damage or noise, please make sure not to use a silicon-contained curing agent in the daily maintenance of rubber seals. Only water and suitable curing agent should be used to clean.

Plastic parts

NOTICE

Liquids containing alcohol or solvent (such as nitro diluent, cooling cleaner, fuel, perfume and cosmetics) may damage the surface of parts. Use microfiber soft cloth (slightly wet with water) to clean.

Plastic parts include but are not limited to the following parts:

Artificial leather surface, roof lining, vehicle lamp glass cover, cup holder roller shutter, vent assembly, black matte paint parts and inside paint parts.

Vehicle window

Clean the inside and outside of the window with a glass detergent and wipe all the glass and plastic surfaces with a soft cloth or paper towel.

CAUTION

If a heating wire is attached to the

inside of the rear vehicle window, excessive forceful wiping may cause it to shift or break. Therefore, lightly wipe it along the direction of the heating wire.

Seat belt

1. If a seat belt becomes dirty, please use neutral warm soapy water to scrub it. Do not use bleach, dyes or cleaning solvents that can reduce the durability of the seat belt.

Before driving, you should allow the seat belt to dry naturally in the air.

2. Too much dust on the seat belt guide ring can lead to slow contraction of the seat belt; neutral temperature soapy water can be used to scrub the inner side of the guide ring.

Anti-corrosion measures

Factors that affect the corrosion rate

- › The accumulation of dirt, dust, or snow in the lower part of the vehicle body can accelerate corrosion.
- › Damage to the coating or other protective layer, arising from sand attacking or minor accident, may quicken corrosion.
- › If the vehicle runs in areas where relative humidity is high or temperature is above freezing point, it may quicken corrosion.
- › There is much salt in the air and on the road of industrial pollution areas

and coastal regions, which may quicken the paint corrosion.

- › Rising temperature may quicken the corrosion of poorly ventilated parts.

Protect the vehicle from corrosion

- › Regularly use clean cold water and neutral vehicle detergent to wash the vehicle so as to keep it clean.
- › Regularly check whether the paint is damaged. If it is, repair it as soon as possible.
- › Regularly check the lower part of the vehicle body. If there is sand, dirt, snow, ice or other coverings, clean them with water as soon as possible.
- › Keep the door drain hole open so as to avoid water logging.
- › If insects, asphalt, cement or other similar objects are accumulated on the vehicle, clean them as soon as possible.
- › If you always drive on a deicing salt covered road, saline-alkali land, sea-side and other roads containing salt, please wash off the attachments at the bottom of the vehicle at least once a month.
- › If you drive regularly on sand road, please consider installing mud flap behind the wheels.

Long-term storage of the vehicle

The parking position of the vehicle

should help to prevent deterioration of the vehicle condition and facilitate the restarting of the vehicle. If possible, please park your vehicle indoor.

If you need to store the vehicle for an extended period (one month or longer), please take the following steps beforehand:

- › Clean and dry vehicle exterior thoroughly.
 - › Clean the inside of the vehicle to ensure it is clean and tidy.
 - › Release the parking brake, and use the wheel chock to hold against the tyres.
 - › Open vehicle windows on one side slightly (if the vehicle is to be parked indoors).
 - › Use a stowed towel or piece of cloth to cushion the wiper blade from the windshield glass.
 - › To reduce the risk of sticking, silicone lubricant should be applied on all door seals.
 - › Use a vehicle cover made of porous cotton to cover the vehicle. Because plastic materials such as non-porous materials will accumulate moisture, and is likely to damage the vehicle body paint.
 - › Disconnect the negative terminal of the battery.
 - › The vehicle shall be stored in a ventilated environment, without flammable and explosive materials around.
- › Make sure that the power battery level is above 50% (the power meter shows that the power level is above half).
 - › When the power battery is stored for less than 3 months, the environment temperature shall be between -20°C and 45°C; when stored for less than 6 months, the environment temperature shall be between 0°C and 45°C; when stored for more than 6 months, the environment temperature shall be between 0°C and 35°C.

i NOTICE

It is recommended to check the power battery level every month. If the "low battery indicator" in the combination instrument is illuminated, please charge the battery immediately.

7 Technical data

Vehicle identification.....268

Overall parameters269

Vehicle identification

Vehicle equipment

Please note that this manual contains all the standard equipment, country-specific equipment and special equipment for this model series. Thus, some equipment or features described in this manual may not be installed onto your vehicle or are only available in some markets. For further configuration information, please refer to relevant sales information or consult with your distributor selling the vehicle to you.

Vehicle identification number

The vehicle identification number (VIN) is the identity code of the vehicle and unique to every vehicle. It is engraved in the following locations:

- › The upper left side of the instrument panel.

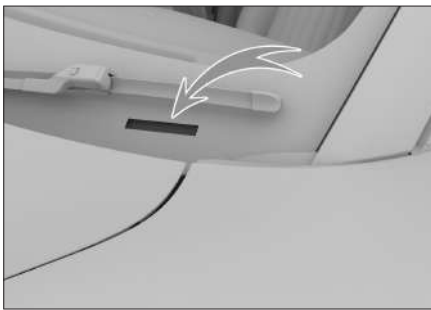

- › On front mounting beam of the front right seat.



- › On the certification label below the central pillar lock.

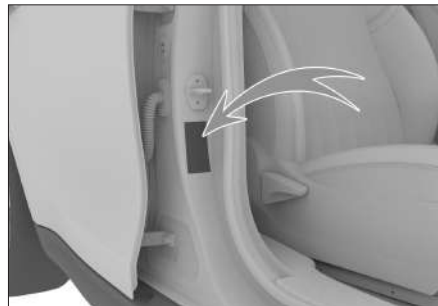

Number of drive motor

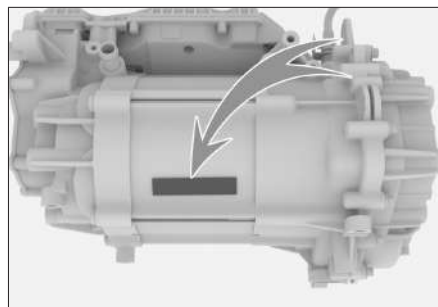

The drive motor number is printed on the motor housing, as shown in the figure.

Overall parameters

Basic parameters

For basic parameters such as the overall dimensions, quality, maximum speed, see the official vehicle documents attached to the vehicle.

CAUTION

Except specifically stated or separately listed parameters, all the parameters listed in this manual are applicable to the standard vehicles. For specially equipped vehicles and those vehicles produced for other countries, some of the parameters may be different. Parameters in the official vehicle documents attached to the vehicle shall always prevail.

Power parameters

Drive motor

Model	Type	Maximum output power [kW]	Peak torque [N·m]	Maximum gradeability [%]
TZ153XS000	Permanent magnet synchronous motor	105	210	25
TZ153XS001	Permanent magnet synchronous motor	126	250	25

CAUTION

When driving in the steep slope which exceeds the setting limit value, its motor load will exceed the load in flat road. At this time, the vehicle will come into limit speed status, even the motor will stop working so as to prevent from the damage to each electronic bridge system when driving in extreme road condition. When the fault is happened and the tortoise lamp is illuminated, do not be panic. Seek a safe place to stop the vehicle, and the vehicle power can be restored after several minutes. When the fault is happened but the tortoise lamp is not illuminated, or the vehicle power cannot restore within several minutes, please go to service provider to check and repair the vehicle.

Traction battery

Model	Type	Rated voltage [V]	Rated capacity [Ah]	Working temperature [°C]
PB365131A	Ferrous lithium phosphate battery	364.8	131	-20~55 (charging) -30~55 (discharging)
PE338187A	Ternary lithium ion battery	337.64	187	-20~55 (charging) -30~55 (discharging)

Tyre specifications

Item		Data
Specification	Standard tyre	205/55 R17 95W、215/50 R18 96V
Tyre pressure		Please refer to the tyre pressure label on the inside of the fuel tank door
Tyre chain	Specification	TPU polyurethane tyre chain: thickness lower than 6 mm.
	Installation location	Front wheels

Wheel parameters

Item		Data
Dynamic balance parameter	Unilateral [g]	≤8
	Bilateral sum [g]	≤15

7

Technical data

Item		Data	
Alignment parameters	Rear wheel	Rear wheel camber	$-90' \pm 30'$ (left and right difference $\leq 30'$)
		Rear wheel toe-in	$0^{\circ}7' \pm 15'$ (left and right difference $\leq 15'$)
	Front wheels	Kingpin backwards inclination	$4.15^{\circ} \pm 45'$ (left and right difference $\leq 45'$)
		Front-wheel camber	$-0^{\circ}30' \pm 45'$ (right-left deviation $\leq 45'$)
		Front wheel toe-in	$0^{\circ}6' \pm 5'$ (difference of $\leq 5'$ between left and right wheel)
		Kingpin inwards inclination	11.15° (for reference)

Braking parameters

Item		Data
Brake pedal	Free travel [mm]	4~7
Front brake pad (friction material)	Minimum thickness [mm]	2
Rear brake pad (friction material)	Minimum thickness [mm]	2
Front brake disk	Minimum thickness [mm]	20
Rear brake disk	Minimum thickness [mm]	10

Fluid parameters

Fluids type	Specification	Capacity [L] (reference value)
Transmission oil	Castrol BOT 352 B1 BEV	0.74 ± 0.02
Coolant (heating system of the air condition)	Ethylene-glycol based - No.35	2.1 ± 0.2
Coolant (power system)	Ethylene-glycol based - No.35	6.7 ± 0.2

Fluids type	Specification	Capacity [L] (reference value)
Brake fluid	DOT4 synthetic brake fluid	0.72±0.1
Windshield washer fluid	--	2.3±0.3

Seat parameters

Item		Data
Design position of seat sliding rail		Move 20 mm forward from the last position
Design angle of seat backrest	Front seats	25°
	Rear seats	25°
Common angle of seat backrest	Front seats	22°~25°
	Rear seats	25°

8

Index

Alphabetical index..... 274

Alphabetical index

A

- A/C system 66
 - Cleaning function of the seat compartment 72
- Active intake grille 252
- Airbag
 - Curtain airbags 217
 - Front airbag 213,215
 - Side airbags 216
- Anti-lock brake system 151

B

- Back door
 - Electric sensory back door 24
 - Emergency unlock 27
 - Manual back door 23
- Battery 252
- Battery safety switch 96
- Bottle holder 76
- Brake fluid 251
- Braking force assist system 152
- Braking parameters 271
- Break-in period 90

C

- Child restraint system
 - Fixing point for child seat 219
 - Recommended child seat type 219
- Child safety lock 28
- Coolant 251
- Cruise assist system 130
- Cruise control system 127
- Cup holder
 - Front seat cup holder 76

D

- Door lock
 - Locking and unlocking through the PEPS 20
 - Locking and unlocking with central control buttons 21
 - Locking and unlocking with key buttons 21
 - Locking and unlocking with the mechanical key 22
 - Locking during emergencies 22
 - Unlocking with the interior handle 21
- Drive motor number 268
- Driving mode 105

E

- Electronic braking force distribution system 152
- Electronic parking brake 99
- Electronic Power Steering System 152
- Electronic stabilization program 152
- Emergency cut-off system 227
- Emergency tyre repair 234
- Energy recovery 94
- Engine compartment 249
- Engine compartment layout 250
- Engine hood 37
- Event data recorder 228
- Exterior maintenance 262

F

- Fuse 255

H

- Headrest 46
- Heat preservation/ cooling preservation function of the plug 93
- HHC (Hill-start hold control) 152

Horn 55
How to jump start the vehicle 238

I

Inflator and tyre repair fluid 233
Inside rearview mirror
 Manual anti-glare inside rearview mirror 52
Instrument

 Virtual instrument 154

Interior maintenance 263

K

Key 16

L

Light control

 Daytime running lamps 58
 Emergency flasher 58
 Follow me home function 59
 Interior lamp 59
 Light control combination switch 56
 Light height adjustment 59
 Roof lamp 60

M

Mobile phone interconnection 192,199

O

One-pedal mode 108
Outside rearview mirror 52

P

Parking assist system
 Anti-collision radar 113
 Around view monitor 115
 Fully automatic integrated parking system 120
 Parking settings 123

Reverse camera 114
Reverse radar 113
Reversing assist 122
Power battery recovery 92
Power management system 168
Power parameters 269
Power socket 77
Power-steering mode 111
Pure electric vehicle 91

R

Rearview mirror
 Ground lighting setting of the rearview mirror 53

S

Seat
 Custom setup for seats 49
 Driver's seat 49
 Driver's seat memory 50
 Front manual seat 46
 Front power seat 48
 Rear seat adjustment 50
 Welcome function of driver's seat 48

Seat belt 209

Seat parameters 272

Single pedal mode 107

Steering wheel 55

Sunroof

 Opening and closing sunshade 34
 Opening and closing the sunroof 33

Sunroof maintenance 261

Sun visor 75

T

Traction control system 152
Transmission 102
Tyre inflation 235

Tyre maintenance 259
Tyre pressure monitoring system 125
Tyre specifications 270

V

Vanity mirror 75
Vehicle anti-theft system 225
Vehicle identification number 268
Vehicle power supply 97
Voice assistant 185

W

Wheel parameters 270
Window switch 30
Windshield washer fluid 252
Wiper control
 Automatic wiper 62
 Electric wipers 61
Wireless charging of mobile phone 73