



X P E N G

G3i User Manual



XPENG G3i is designed to be a smart EV different from ordinary vehicles. Before using it, please read through this manual to understand its basic information, operating instructions and related warnings & cautions. If you have any questions regarding the use of the vehicle, please contact your local authorized service center.

This manual was published in March 2022. Contents marked with "*" in the manual are for illustration purpose only. Actual features and functions of XPENG G3i may vary due to OTA update, so please note that:

Please pay special attention to the warnings and cautions in the manual to ensure proper operations and driving safety.

XPENG Inc. always reserves the right to change, supplement, or terminate the contents and technical specifications of this manual.



1. Notice to XPENG Owners.... 7

Safety Instructions..... 7

EV System Layout 8

Traction Battery 9

Charging Instructions 10

2. Pre-Use Preparation (Exterior Equipment) 17

Appearance Introduction 17

Bluetooth Key..... 18

Doors 20

Tailgate 23

Rear Trunk Cover 26

Front Hood 27

Exterior Rear-View Mirrors..... 28

Roof Rack Interface 30

Interior Introduction 32

Steering Wheel..... 34

Interior Rear-View Mirror..... 37

Mobile Phone Wireless Charging 38

Interior Door Handles..... 40

Windows 40

In-Vehicle Power Interface 42

Reflective Vest..... 44

Dashboard 45

Indicator Lights 47

Exterior Lights 51

Interior Reading Lights..... 55

Wipers and Washers..... 56

Low-Speed Warning Sound..... 58

3. Stable Driving..... 59

Vehicle Power On/Off..... 59



Table of Contents

Start the Vehicle	61
Gearshift	62
Driving Mode.....	64
Energy Regeneration.....	65
Interior Air Conditioner.....	67
Front Seats	69
Rear Seats	73
Ride with Children	75
Child Locks	84

4. Safe Driving85

Seat Belts	85
Seat Belts with Collision Warning	86
Airbags	91
Electronic Parking Brake (EPB).....	94
AutoHold.....	96
Electronic Stability Program (ESP)	97

Traction Control System (TCS)	97
Anti-Lock Braking System (ABS).....	98
Electronic Brakeforce Distribution (EBD)	98
Hydraulic Brake Assist (HBA).....	99
Emergency Brake Alarm	99
Hill Descent Control (HDC).....	100

5. Center Information Display (CID)..... 101

Interface Introduction.....	101
Bluetooth music	103
System Settings.....	104
Vehicle Settings.....	106

6. XPENG APP 110

Download and Use.....	110
-----------------------	-----



Car Control with Xpeng App 111

7. XPILOT Driving 114

Radars..... 114

Cameras..... 116

Xpilot Parking System..... 118

Parking Radars 119

Around View Monitor (AVM) 122

Forward Collision Mitigation..... 123

Lane Departure Assist 127

Emergency Lane Keeping (ELK) 130

Blind Spot Security 132

Speed Assist System (SAS)..... 134

Rear Cross Traffic Alert (RCTA)..... 137

Door Open Warning (DOW)..... 139

Intelligent Parking Assist 142

Intelligent Parking out Assist..... 146

Super Intelligent Parking Assist
(With Voice Control Intelligent
Parking Assist)..... 148

Adaptive Cruise Control (ACC) 149

Lane Centering Control (LCC)..... 157

XPILOT Intelligent Driving
Simulation Display System 162

8. Maintenance 164

Traction Battery Maintenance..... 164

Charging Port House Cleaning 164

Tire Maintenance..... 165

Use of Snow Chain 173

Exterior Cleaning..... 174

Interior Cleaning 177

Check Traction Battery Coolant 179

Check Motor coolant 180



Table of Contents

Check Heating Coolant	181	Suspensions.....	196
Check Brake Fluid	182	Braking System.....	196
Refill of Windshield Washer Fluid	183	Oil/Fluid Filling Volume.....	197
Replacement of Key Battery	184	Four-Wheel Alignment Parameters ..	197
Parts and Modification	185	Tire.....	198
		Microwave Window	199
		Event Data Recorder (EDR)	199

9. Vehicle Specifications 186

Vehicle Identification Number (VIN) .	186
Product Nameplate	187
OBD diagnosis interface	188
Drive Motor Model and Code.....	189
Labels	189
Exterior Dimensions	192
Weight.....	193
Overview Parameters	194
Steering Gear	194
Parameters of the Powertrain.....	195



1. Notice to XPENG Owners

1

Safety Instructions

With the focus on safety, XPENG is committed to creating a better mobility experience for customers. XPENG Owners should follow the safety instructions to drive carefully when getting familiar with the features of this vehicle.

Guidelines for Handling Traffic Accidents

If your vehicle has suffered severe damage in an accident, to ensure your personal safety, please follow the instructions below:

- Do not touch any High Voltage wiring harness or High Voltage component in the vehicle, or it will cause electrical injuries.
- Do not touch any leaked fluid.
- Do not attempt to inspect the vehicle by yourself.
- If you need to have the vehicle towed, contact your local authorized service center.
- When the vehicle has been damaged by flood, do not power it on again. Because short circuit may occur in the battery pack. To avoid personal safety risks or secondary damage to the vehicle, contact your local authorized service center as soon as possible to check the battery system and have the damaged battery assessed by professionals.
- If the vehicle smokes or catches fire, run far away from the vehicle and call the police as soon as possible (you should inform the police that the vehicle is a pure electric Vehicle). Contact your local authorized service center for further handling advice.

- When the battery system failure warning appears on the dashboard, pull over and park the vehicle safely, move to a safe distance from the vehicle and contact your local authorized service center.
- If anyone in the vehicle is injured, contact the first aid department in case is necessary.
- If the vehicle is involved in an accident such as a scratch on the bottom protection cover collision, the internal structure of the battery may be damaged, posing a serious safety hazard. Immediately contact your local authorized service center to check the battery system and have the damage assessed by authorized repairer.

Important Notes

In case of any of the following situations, please contact your local authorized service center:

- The vehicle has reached the scheduled mileage or service life interval for maintenance (refer to the Warranty and Maintenance Manual).
- The vehicle is damaged in a collision, flood, chassis scraping, or other accidents.
- One of the serious failure alarms is displayed on the dashboard, such as battery failure, battery overheating, motor and controller overheating, electric system failure, and charging port overheating.



1. Notice to XPENG Owners

EV System Layout

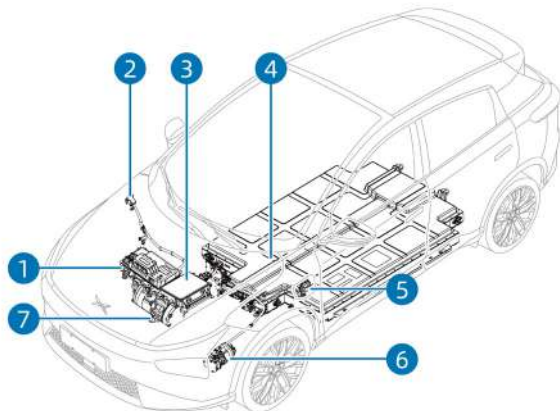

- 1 Intelligent power unit (IPU)
- 2 AC charging port [Refer to Page 11](#)
- 3 CCS/DC-DC converter
- 4 Traction battery [Refer to Page 9](#)
- 5 DC charging port [Refer to Page 12](#)
- 6 A/C compressor
- 7 Drive motor

Warning

- The orange wiring harnesses are HV ones. It is forbidden to touch or disassemble any HV wiring harnesses and related HV parts, otherwise there is a danger of electric shock!



Traction Battery

The traction battery is mounted on the chassis of the vehicle. Be careful with it during driving!

Warning

- The traction battery can generate a high rated voltage up to 381V, which may cause serious injury or even death to human body. Please beware of the high voltage danger!
- Only trained technicians are allowed to disassembling, inspecting, modifying, and repairing the traction battery and its circuits, as this may lead to electric shock injuries or even death due to improper operation.

Caution

- Be careful when driving over mud, potholes, curbs, high and wide speed bumps, sidewalk ramps and other special roads to avoid scratches or damage to the traction battery caused by chassis collisions.
- Be careful when driving through deep water to prevent short circuit, electric leakage or damage of the traction battery due to excessive contact with water.
- If you perceive that the chassis is scratched or bad smell come from the traction battery, please stop driving immediately and contact your local authorized service center as soon as possible.

Range

The range depends on the state of charge, the vehicle's mileage and service history, environment temperature, road conditions, driving habits (air conditioning, driving mode, energy regeneration level), and the vehicle's payload capacity, etc.

Traction Battery Environment Temperature

The performance of the traction battery is affected by the environment temperature. It is required to use the vehicle within the environment temperature range of -30°C to 55°C to maintain the good performance of the battery and extend its service life.

Caution

- Do not keep the vehicle exposed to high temperatures above 60°C or low temperatures below -40°C for more than 24h.

Traction Battery Recycling Instructions

If the traction battery needs to be replaced or scrapped, please contact your local authorized service center for recycling and disposal. Careless disposal of traction battery will cause pollution to the environment or safety accidents, and the car owner should be held responsible.



1. Notice to XPENG Owners

Charging Instructions

When the state of charge is less than 30% or the charging reminder light comes on, please charge the vehicle as soon as possible.

When the vehicle is parked, AC charging, AC discharging or DC charging can be carried out through the AC/DC charging port located on the left rear of the vehicle.

i Note

- If the power battery of the vehicle is lithium iron phosphate battery, it is recommended to charge the power to 100% by fast charging (DC charging) in the first three times after picking up the vehicle, which is conducive to the optimal performance of the power battery. In the subsequent car use process, charge the battery to 100% at least once every month (there is no limit on speed charge), which can improve the accuracy of mileage calculation.

Charging Display

During charging, the charging status is displayed on/by the following 4 devices:

1. Charging indicator light on exterior rear-view mirror



- Blue light on: ready to charge.
 - Green light flashing: charging.
 - Green light on: charging completed.
 - Red light flashing: charging fails.
2. Dashboard



<https://www.automotive-manuals.net>



1. Notice to XPENG Owners

1

The dashboard displays the charging status.

- ▶ After the vehicle is locked, the dashboard no longer displays the charging status.

3. CID

The CID displays charging information. After the vehicle is locked, the CID will no longer display charging information.

4. Mobile APP.

AC Charging

The long AC charging time is beneficial to battery life.



1. Press the AC charging port cover on the right side of the vehicle and fully open the AC charging port cover.

- ▶ This can only be done on the AC charging mode.

2. Take the charging gun off the AC charging pile and plug it into the AC charging port vertically.
 - ▶ Do not shake the charging gun when plugging it.

⚠ Caution

- Do not press the switch of the charging gun. Please plug the charging gun vertically until you hear a "click", indicating that the charging gun is plugged in place.

3. Scan the code on the charging pile with your mobile phone, generate a charging order as instructed, and activate the pile to start charging.
4. Observe the charging indicator lights. [Refer to Page 10.](#)
 - ▶ If the charging indicator light on the exterior rear-view mirror flashes in green, it indicates the vehicle is being charged.
5. After charging is completed, press the "Unlock" button on the smart key or tap the "Stop Charging" button on the CID to unlock the charging gun. Then, press the switch of the charging gun while unplugging the charging gun. Put it back to the specified position.

<https://www.automotive-manuals.net>



1. Notice to XPENG Owners

⚠ Caution

- If the charging gun cannot be unplugged after it is unlocked, please push the charging gun firmly in place again, press the unlock button on the key again or tap the "Stop Charging" button on the CID to unlock, and then unplug the charging gun again.

Emergency Unlocking



- If the charging gun still cannot be unplugged after several attempts to unlock, open the engine hood, find the pull lock in the right, and pull it to unlock. Then unplug the charging gun.

DC Charging



1. Press the DC charging port cover on the left side of the vehicle and fully open the DC charging port cover.
 - ▶ This can only be done when the vehicle is unlocked.
2. Take the charging gun from the DC charging pile and plug it vertically into the DC charging port.
 - ▶ Do not shake the charging gun when plugging.
3. Scan the code on the charging pile with your mobile phone, generate a charging order as instructed, and activate the pile to start charging.

<https://www.automotive-manuals.net>



1. Notice to XPENG Owners

1

4. Observe the charging indicator lights [Refer to Page 10.](#)
 - ▶ If the charging indicator light on the exterior rear-view mirror flashes in green, it indicates the vehicle is being charged.

Warning

- DC charging must be carried out in compliance with the relevant regulations of the charging station.
- The charging interface, communication protocol, and technical requirements should meet the latest national standards for charging piles. Please check if the DC charging pile is CCS2 standard compliant before charging.

Note

- The charging may be prolonged due to factors such as environment temperature and traction battery life.
- When charging at a low environment temperature, the system will heat the traction battery first, and then charge it when its temperature becomes normal. So the charging will take a slightly longer time than normal.

Note

- When the indicator light shows an abnormal charging warning, try to repeat the charging steps or restart the whole vehicle. If the abnormal charging warning persists, please contact your local authorized service center for troubleshooting.
- The A/C may not work well due to the limited power for A/C system during AC charging.
- Due to the differences among charging pile manufacturers in understanding the national charging standard, as well as the different maintenance levels of charging piles, there may be cases where the vehicle cannot be charged using a charging pile. In case of such situation, please try to plug the gun again or use another charging pile.



1. Notice to XPENG Owners

Precautions for Charging

- AC or DC charging can only be performed independently for a vehicle at any given time. The AC charging gun and the DC charging gun should not both be plugged in. If both guns are plugged in, please pull out both guns and then plug in either one to charge normally.
- Some DC charging piles are compatible with both electric buses and electric vehicles. When the vehicle is charged by such DC charging piles, an auxiliary power supply of 12V should be opted for.
- Please ensure the charging port, charging gun, charging plug, and other devices are dry before charging, and it is prohibited to charge when the charging devices or your hands are wet.
- The charging gun cable must be free of twist when charging.
- Charging is prohibited if the charging devices are corroded or damaged, including damages on the pins of the charging gun, as well as the deformed and cracked plastic body of the plug.
- In case of an emergency during charging, press the "Emergency Stop" button of the charging device to stop charging.
- It is recommended to stop charging the vehicle during thunderstorms, because lightning may cause damage to the charging devices.
- It is recommended to charge the vehicle with a charging pile in a shady and waterproof shelter, to avoid rain or snow from splashing into the charging port when unplugging the charging gun.
- When plugging/unplugging the charging gun, press the release switch of the charging gun to plug/unplug the charging gun vertically. Do not shake the charging gun during such actions.
- If the charging port continuously emits a strong and irritating smell during charging, stop charging immediately.
- It is strictly forbidden to allow minors to touch or use the charging devices.
- If there are foreign objects such as dust or large hard particles in the metal socket of the charging port, charging gun, or charging plug, clean such parts after powering off the whole vehicle and then perform charging.
- If you have an electronic device implanted in your body, such as a pacemaker, cardiovascular defibrillator, internal analgesic pump, insulin pump, or hearing aid, do not stay in the vehicle or enter the vehicle to take something while the vehicle is charging, as this may interfere with the function of your electronic device and result in personal injury or death.
- Do not disassemble or modify the charging port or charging cable.

<https://www.automotive-manuals.net>



1. Notice to XPENG Owners

1

AC Discharging

AC discharging allows the power stored in the battery to be output at 220V for external appliances to use.

Perform AC discharging as follows:

1. Open the AC charging port cover.



2. Connect the appliance to the adapter first, then plug the adapter into the charging port.
 - ▶ This function allows to connect external electrical appliances with the maximum power of 2.2 kW.
 - ▶ When the traction state of charge is less than 20%, this function will be automatically deactivated.
3. Tap the  icon in the CID status bar to enter the discharge function page.

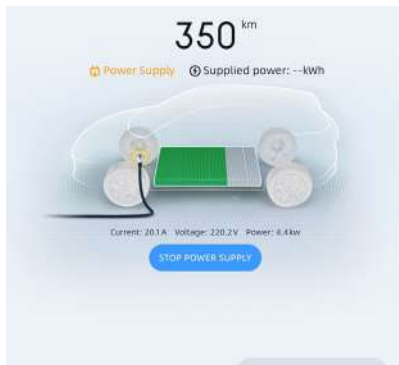

4. Confirm that the power supply circuit and electrical appliance are well connected, and tap the "Start Power Supply" button to enter the discharging mode; the current and voltage will be displayed in real time during discharging; you can stop discharging at any time.
 - You can custom the power supply limit, so that the discharging will automatically stop if the limit is reached.

<https://www.automotive-manuals.net>



1. Notice to XPENG Owners

Warning

- It is strictly forbidden to use this function in case of any damage of the appliance or the adapter.
- It is strictly forbidden to allow minors to touch or use the charging device. Keep minors away from the vehicle when this function is activated.
- In case of abnormal discharging, please deactivate this function immediately.
- It is strictly prohibited to touch the plug pins of electrical appliances and adapter jacks.
- It is strictly prohibited to connect counterfeit products, medical or health electronic devices to the vehicle.

<https://www.automotive-manuals.net>



2. Pre-Use Preparation (Exterior Equipment)

Appearance Introduction

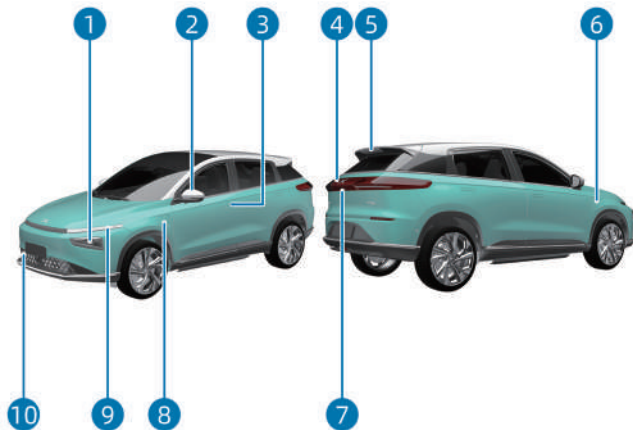

- 1 Front combination light assembly
Refer to Page 51.
- 2 Exterior rear-view mirror
Refer to Page 28.
- 3 Exterior door handle
- 4 Rear combination light assembly
Refer to Page 51.
- 5 High brake light
- 6 AC charging port Refer to Page 11.
- 7 Exterior tailgate button
Refer to Page 23.
- 8 DC charging port Refer to Page 12.
- 9 Daytime running Lights
- 10 Front tow hook



2. Pre-Use Preparation (Exterior Equipment)

Bluetooth Key

Bluetooth Car Control

Bluetooth key can be used to unlock the vehicle like the smart key. Even if there is no mobile network, it is still able to communicate with the vehicle via Bluetooth. In addition, it can also be used to control the vehicle parts (such as the trunk, windows, locks).

Compatibility Description

Mobile operating systems supported: Android 7.0 and iOS 9.0 or above. It is recommended to use phone models released after 2017.

Bluetooth protocol: To ensure a senseless unlocking/locking experience, Bluetooth 5.0 and above are recommended.

Creating a Key

Please tap "Create a Bluetooth key" on the Bluetooth car control interface or digital key management interface. This operation works only when the vehicle is connected to the network. Please follow the instructions: lock the vehicle → connect to network → pass the security authentication and generate an encrypted digital key.

Sharing the Key

The Bluetooth key can be remotely shared with up to 5 users. (method: Vehicle Control → Digital Key Management → Vehicle Authorization → Add Account). An authorized account will be granted the same key and basic vehicle control permissions after creating a Bluetooth key.

Description

1. Bluetooth key start
 - When you approach the vehicle with mobile phone, the vehicle will establish the connection if detecting the Bluetooth signal, and then the "Bluetooth Key Start" button on the Bluetooth Vehicle control interface will be activated.
2. Auto locking/unlocking
 - Based on the Bluetooth signal intensity of the mobile phone connected to the vehicle, locate the key and vehicle, and perform locking, unlocking or starting depending on the location.
 - The function is only available for calibrated models. For calibrated models, please tap "Bluetooth Key Settings → Auto Lock/Unlock → [i]".
 - Then the doors will auto unlock when approaching and lock when leaving. At the same time, your phone will vibrate to remind you. It is recommended to turn on the vibration function.

<https://www.automotive-manuals.net>



2. Pre-Use Preparation (Exterior Equipment)

i Note

- To use the Bluetooth key, be sure to keep the phone on and turn on Bluetooth. Please pay attention to the phone battery, some phones will disable Bluetooth when the battery is low.
- The Bluetooth connection range is usually within 20-30m, but there are differences in sensitivity due to the Bluetooth of the mobile phone, and obstacles between the bluetooth device and the car. If unlocking/locking fails, please open App to start/lock the vehicle through the Bluetooth key.

2

<https://www.automotive-manuals.net>



2. Pre-Use Preparation (Exterior Equipment)

Doors

Locking/Unlocking the Doors with Key

The valid range of the key remote is about 15m.

- Locking: press the button to lock the doors if the vehicle is powered off/on, the driver's seat is unoccupied and the gear is in P, with all doors (four doors, front compartment cover, and tailgate) closed.
- Unlocking: press the unlock button on the key to unlock the doors when the vehicle is powered off or on in a non-READY state.

Caution



- If the key battery is low, it will affect the keyless locking & unlocking doors and key remote control function, please replace the key battery in time.

Unlocking/Locking Feedback

You can set the vehicle unlocking/locking feedback effect by tapping " → Vehicle Settings → Remote Lock/Unlock Feedback" on CID.

- After the vehicle is successfully locked, 1 double flashing alert (set to flashing lights), or 1 double flashing alert and 1 horn beep (set to flashing lights + horn) or 1 double flashing alert and 1 outside sound beep (set to flashing lights + and dazzling sound).
- After the vehicle is successfully unlocked, 2 double flashing prompts (set to flashing lights), or 2 double flashing prompts and 2 horn beep (set to flashing lights + horn) or 2 double flashing prompts and 2 outside sound beep (set to flashing lights + and dazzling sound).

Smart Locking/Unlocking

Tap " → Vehicle Settings → Unlock When Approaching" and set to turn on/off the smart locking function through " → Vehicle Settings → Lock When Leaving" on CID to turn on/off the function. After the function is turned on:

- Unlock when approaching: when you approach the vehicle with the key, it will unlock automatically.
- Lock when leaving: when you walk away from the vehicle with the key, it will automatically lock.



2. Pre-Use Preparation (Exterior Equipment)

Emergency Unlocking

If the door cannot be opened electrically due to power loss of the 12V battery or of the car key battery, a mechanical key can be used to unlock the door.



Pull up the door handle and insert the mechanical key into the lock hole:

- Rotate the mechanical key counter-clockwise to lock the doors.
- When the left front door is unlocked and the four doors are closed, the locking operation can be performed using the mechanical key and the four doors are locked.
 - ▶ When the left front door is locked and the four doors are closed, the locking operation can be performed using the mechanical key and the four doors are not locked.
 - ▶ Rotate the mechanical key clockwise to unlock the doors.

Locking and Unlocking the Doors with the Door Lock Button



- Locking: With four doors closed, press the locking end of the door lock button to lock the doors.
- Unlocking: Press the unlocking end of the door lock button to unlock the doors.

2



2. Pre-Use Preparation (Exterior Equipment)

Collision Unlocking

In the event of a serious vehicle collision resulting in airbag deployment, the vehicle will unlock doors once and then unlock again 3s later.

Note

- The turn signal lights keep flashing when the doors are unlocked due to the collision, and stop flashing when the vehicle is powered off or the hazard warning light switch is pressed.

Driving Locking

With all doors closed and the left front door unlocked, this function is activated. In addition, when the vehicle speed exceeds 12 km/h during driving, all doors will be automatically locked.

Note

- This function can be activated/deactivated via " → Vehicle Settings → Lock on Drive" on CID.

Parking Auto Unlocking

With the driver's seat occupied, all doors closed and the left front door locked, the following operations will automatically unlock the doors when the vehicle is parked:

- With the gear in P, the driver wearing the seat belt unfastens the seat belt.
- When the driver is not wearing a seat belt and the gear is not in P, the gear is shifted to P.

Note

- This function can be activated/deactivated via " → Vehicle Settings → Lock → Unlock on Park" on CID.



2. Pre-Use Preparation (Exterior Equipment)

Tailgate

Tailgate Opening/Closing with Key Tailgate Button

- Opening: When the tailgate is closed, press the tailgate button of the key twice continuously within 1s to open the tailgate electrically.
- Closing: When the tailgate is open, press the tailgate button of the key twice continuously within 1s to close the tailgate electrically.
 - ▶ When the tailgate stops due to operation or anti-pinch function triggering during tailgate powering, press the tailgate button of the key twice continuously within 1s, the tailgate will execute the opposite powering action as before it stopped.

Opening with Exterior Tailgate Button

- Opening: Approach the tailgate with the key, press the exterior tailgate button, and the tailgate opens electrically.
 - ▶ When the vehicle is unlocked, there is no need to carry the key and the tailgate opens electrically by directly pressing the exterior button.
 - ▶ When the tailgate stops due to operation or anti-pinch function triggering during the tailgate powering, press the exterior tailgate button and the tailgate opens electrically.

Closing with Interior Tailgate Button



- Closing: Press the interior tailgate button to close the tailgate electrically.
 - ▶ During the powering action of the tailgate, press the interior tailgate button again and the tailgate will stop in its current position.
 - ▶ If the tailgate stops due to operation or anti-pinch function triggering during the tailgate powering, press the interior tailgate button to close the tailgate electrically.



2. Pre-Use Preparation (Exterior Equipment)

Opening/Closing on CID

Tap "🚗 → Quick Controls → Trunk" on the CID to enter the control interface:

- Opening: Tap the "Open" button and the tailgate will open electrically.
- Closing: Tap the "Close" button and the tailgate will close electrically.

i Note

- When the tailgate is opening/closing electrically, tap the "Pause" button and the tailgate will stop at the current position.
- If the tailgate stops due to button operation or anti-pinch function triggering during the electric movement of tailgate, tap the button and the tailgate will execute the electric action according to the tapped button command.

Tailgate Stop Mode

When the 12V battery voltage is lower than 9V or higher than 16V, the tailgate will start the stop mode and the electric function will be disabled, the tailgate can be opened in emergency [Refer to Page 25](#).

Tailgate Stop Mode Initialization

After the tailgate stop mode is started, if the 12V battery voltage is restored to normal, and the tailgate is fully closed, the tailgate can be opened electrically; if the tailgate is fully opened, the tailgate needs to be closed manually before the electric function can be restored.

Anti-Pinch Function

The anti-pinch function is provided for tailgate during electrical opening or closing:

- If the anti-pinch function is triggered during the power opening of the tailgate, which will stop opening immediately and the buzzer will sound 1 long beep.
- During the electrical closing of the tailgate, if the anti-pinch function is triggered, the tailgate immediately moves in the opposite direction for a distance and then stops, and the buzzer sounds for 1 long beep.

Initialization of Anti-Pinch Function

When the anti-pinch function is triggered 5 times in a row during the opening or closing of the tailgate, the power function is disabled and the tailgate needs to be closed manually before the power function can be restored.



2. Pre-Use Preparation (Exterior Equipment)

Tailgate Height Setting

When the tailgate is half open or fully open and stopped, press and hold (about 3s) the interior tailgate button until the buzzer beeps long and then release the button, the system remembers this height position successfully. The next time the tailgate is opened electrically, it will open to this setting height by default.

Emergency Opening

If the tailgate cannot be opened electrically, try emergency opening.



1. Open the trim lid.

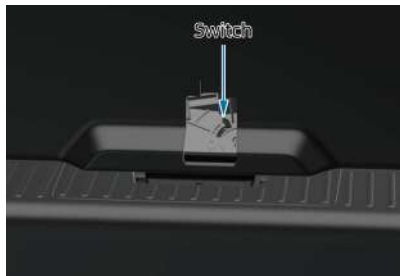

2. Toggle the unlock switch to up to unlock and open the tailgate.

i Note

- The tailgate beeps when the power opens, closes, stops, triggers anti-pinch or when the height setting is successful.
- To avoid overheating damage to the electrical components of tailgate, the vehicle is set up with a limit on continuous tailgate operation, so do not operate the tailgate frequently.



2. Pre-Use Preparation (Exterior Equipment)

Caution

- When opening or closing the tailgate electrically, be aware of any surrounding obstructions and ensure that the tailgate has sufficient room for movement.
- If the tailgate power function is disabled, try tailgate stop mode initialization ([Refer to Page 24.](#)) or anti-pinch initialization ([Refer to Page 24.](#)). If the tailgate power function is still not restored, please contact your local authorized service center for troubleshooting.

Rear Trunk Cover

1. Pull out the rear trunk cover.
2. Snap the ends of the rear trunk cover into the fixing slots on both sides of the trunk.

Warning

- After the cover is unfolded, it is forbidden to place any objects on the cover, otherwise the cover will be damaged or the objects will be thrown forward to injure the occupants in case of a collision.

Removal and Installation of Rear Trunk Cover

- Folding Rear Seat backrests [Refer to Page 73.](#)
- Shrink either end of the cover to remove it.
- To install, snap one end of the cover into the fixing slot first, shrink the other end and snap it into the fixing slot.



2. Pre-Use Preparation (Exterior Equipment)

Front Hood

Opening



1. Pull the front hood handle on the lower left side of the dashboard twice continuously, the front hood unlocks and pops up slightly.



2. Lift the front hood and take out the support bar to support it in the restricted position.

Closing

Remove the support bar and secure it in its original place, lower the front hood until it is close to the vehicle, then release it to drop and lock with its own weight.

Check to make sure that the front hood is securely locked after closing.



2. Pre-Use Preparation (Exterior Equipment)

Exterior Rear-View Mirrors

Power Adjustment

The exterior rear-view mirrors can only be adjusted after the vehicle is powered on.



1. Rotate the exterior rear-view mirror switch to select the left or right exterior rear-view mirror.
 - ▶ Rotate counterclockwise to select the left side.
 - ▶ Rotate clockwise to select the right side.
 - ▶ After adjusting the exterior rear-view mirror, the outside mirror switch shall be restored to the middle identification position.



2. Push the outside mirror switch front/rear/left/right and adjust the exterior rear-view mirror lens to the proper position.

Caution

- When adjusting to the leftmost, rightmost, topmost, bottommost, stop adjusting if the lens will no longer move, otherwise it is very easy to damage the rear-view mirror.
- It is prohibited to adjust the rear-view mirrors while driving. Please pay attention to driving safety.



2. Pre-Use Preparation (Exterior Equipment)

2

Reverse Auto-Tilt Function*

- When the vehicle gear is shifted to R for more than 0.5s, the right exterior rear-view mirror will automatically tilt to a certain angle to assist reversing.

i Note

- The auto-reversing down function is only available for right exterior rear-view mirror.

Memory Function of Exterior Rear-View Mirrors*

This function is used to memorize different mirror positions based on users' setting.

Auto Folding of Exterior Rear-View Mirrors

- Folding: The exterior rear-view mirrors fold automatically when the vehicle is locked.
- Unfolding: The exterior rear-view mirrors unfold automatically when the vehicle is unlocked.

Folding the Exterior Rear-View Mirrors with the CID

Tap "🚗 → Quick Controls → Rear-View Mirrors" on the CID to enter the rear-view mirrors control interface:

- Tap the "Fold" button to fold the exterior rear-view mirrors.
- Tap the "Unfold" button to unfold the exterior rear-view mirrors.

The exterior rear-view mirrors may be in a forward or rearward folding position due to accidental crash or artificial pushing, but they can be recovered to normal positions by following the instructions below.

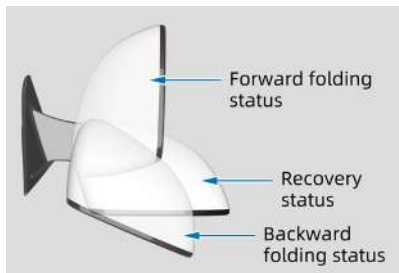

- Tap "Unfold" on the CID and wait for the exterior rear-view mirror to complete its action.
- Manually push the rear-view mirrors to the "Recovery status" position.

i Note

- If you need to reset manually, before resetting, please check the folding surface for foreign objects such as ice or snow first, and then clear the foreign objects, otherwise the folding structure of the exterior rear-view mirrors may be damaged.



2. Pre-Use Preparation (Exterior Equipment)

Exterior Rear-View Mirror Heating



- After the vehicle is power on, tap the  button to activate the function of defrosting & defogging the rear window and the exterior rear-view mirror heating function; tap again to deactivate it.

i Note

- After activating the function of defrosting & defogging the rear window and the exterior rear-view mirror heating function, which will keep working for 14 min and then will be automatically turned off, if you do not deactivate it manually.
- If the 12V battery voltage falls below 9V during the heating process, the system will automatically turn off the heating function.

! Caution

- When the vehicle is not started, it is forbidden to use this function for a long time, or the 12V battery may be unable to start the vehicle due to low voltage.
- Do not touch the exterior rear-view mirrors with your hands when this function is activated.

Roof Rack Interface

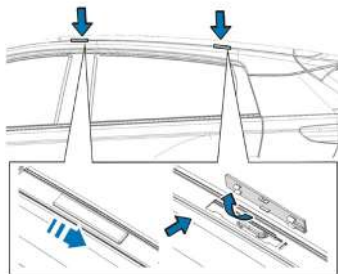

The roof rack interface can be used to install optional roof rack. If using the roof rack, follow the instructions and safety warnings provided in this section and the instruction manual of the roof rack.

- Make sure the roof rack is securely mounted.
- To properly load different types of cargo such as skis, bikes, please use the appropriate accessories. Ensure that the accessories are installed correctly and securely in accordance with their instruction manuals. Do not load cargo directly onto the top sheet metal, or the cargo will damage the top sheet metal.



2. Pre-Use Preparation (Exterior Equipment)

- The total weight of the roof rack and cargo must not exceed the rated load of the roof (50 kg). In addition, the gross weight of the fully loaded vehicle, including driver, passengers, cargo and roof load, shall not exceed the maximum gross vehicle mass listed in the "Vehicle Specification" section of this manual.
- When loading cargo on the roof, place the heaviest items underneath and distribute the cargo as evenly as possible.
- Do not carry oversized items that may hang onto the bumper or the side of the vehicle and obstruct the view.
- Attach the front and rear ends of long items (e.g., board, and surfboard) to the front and rear of the vehicle. Protect the body paint of the vehicle from being scratched by the rope pulled down.
- Check the roof rack regularly to ensure it is securely mounted without any damage.
- For the vehicle equipped with a roof rack interface, make sure that the interface is covered with a lid when it is not used.

Warning

- Rough driving or failure to secure the cargo properly may cause the cargo to fall off the vehicle and hit other objects, causing personal injury or property damage.
- Secure the cargo firmly and avoid rough driving (e.g., sharp turns, turning too fast and sudden braking). Check the cargo regularly to ensure it is securely fastened.
- Bulky, heavy, long or flat items may affect the aerodynamics or wind protection of the vehicle and reduce the controllability of the vehicle, leading to accidents and personal injury. When carrying such items, drive carefully by reducing to a safe speed.



2. Pre-Use Preparation (Interior Equipment)

Interior Introduction

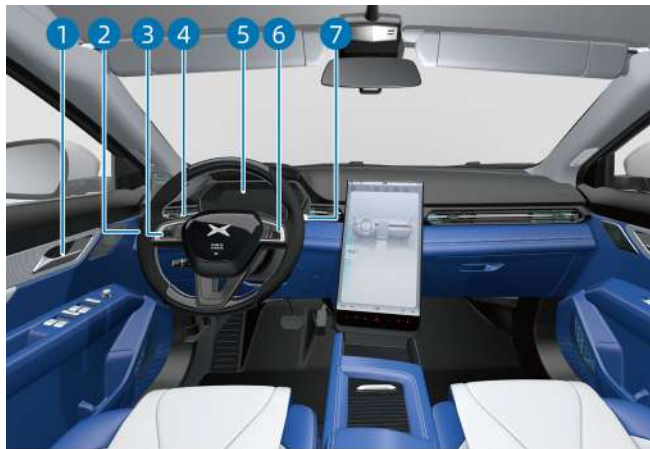

- 1 Interior door handles [Refer to Page 40.](#)
- 2 Electronic parking brake (EPB) switch
[Refer to Page 94.](#)
 - Emergency power-off switch "Vehicle Power Off" [on page 59](#)
 - Manual adjustment roller for headlight height [Refer to Page 53.](#)
- 3 Left steering wheel buttons
[Refer to Page 35.](#)
- 4 Combination switch:
 - Light control switch
[Refer to Page 51.](#)
 - Wiper control switch
[Refer to Page 56.](#)
- 5 Dashboard [Refer to Page 45.](#)
 - indicator lights [Refer to Page 47.](#)
- 6 Right steering wheel buttons
[Refer to Page 36.](#)
- 7 Gear switch "Gears" [on page 62](#)



2. Pre-Use Preparation (Interior Equipment)

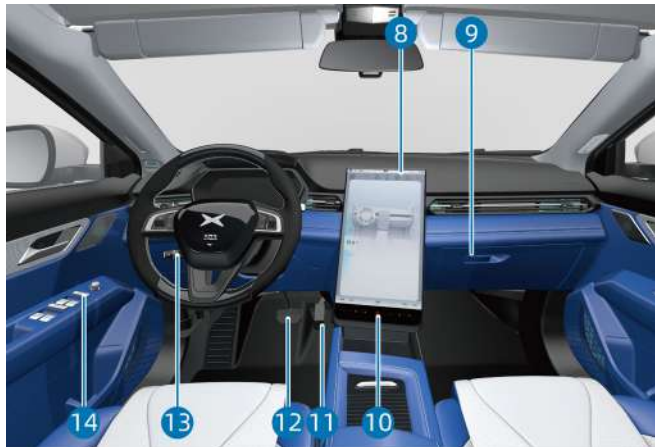

- 8 CID
- 9 Glove box
- 10 Hazard warning light switch
Refer to Page 54.
- 11 Accelerator pedal
- 12 Brake pedal
- 13 Cruise switch:
 - Adaptive Cruise Control (ACC) System
- 14 Driver's power window switch
 - Exterior rear-view mirror adjustment switch Refer to Page 28.
 - Door lock button Refer to Page 21.



2. Pre-Use Preparation (Interior Equipment)

Steering Wheel

Steering Wheel Position Adjustment



The steering wheel handle is in the locked position by factory default.

1. When the vehicle is stationary, pull the steering wheel handle downward to unlock the steering wheel.
2. Move the steering wheel up and down to the proper position.
3. Pull the steering wheel handle upward to lock the steering wheel.

Steering Wheel Assist

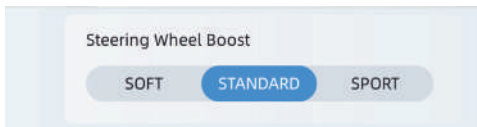

- Enter the steering wheel assist mode selection interface through CID "🚗 → Driving → Steering Wheel Boost", and tap to select the corresponding mode:
 - SOFT: Reduce the force required to turn the steering wheel, which is suitable for driving in cities.
 - STANDARD: Respond and react to situations most effectively.
 - SPORT: Increase the force required to turn the steering wheel, to increase responsiveness of driving at higher speed.

Warning

- It is forbidden to adjust the steering wheel or set up the steering wheel boost mode while driving.



2. Pre-Use Preparation (Interior Equipment)

Left Steering Wheel Buttons



1 Previous track button

- When listening to local or satellite radio and there are multiple preset radio stations, press this button to play the previous radio station from the current radio station.
- When multiple preset radio stations are not available, press this button to go to the last available frequency.
- When listening to an Internet radio station, a connected Bluetooth audio file, or a connected USB audio file, press this button to turn to the previous radio station or the previous song.

2 Next track button

- When listening to local or satellite radio and there are multiple preset radio stations, press this button to play the next radio station from the current radio station.
- When multiple preset radio stations are not available, press this button to go to the next available frequency.
- When listening to an Internet radio station, a connected Bluetooth audio file, or a connected USB audio file, press this button to turn to the next radio station or the next song.

3 Left scroll wheel and confirmation button

- Scroll up or down to adjust the media volume.
- Press the scroll wheel, the media will pause.
- Long press the scroll wheel to display the options available on the left side of the dashboard, then scroll the wheel through the options, and press the scroll wheel to select.

4 Custom button

- Press the custom button to quickly call the custom function.

i Note

- The custom button function can be set via the CID "🚗 → Vehicle Settings → Custom Button".



2. Pre-Use Preparation (Interior Equipment)

Right Steering Wheel Buttons



- 1** Voice button
 - Press the button to enable voice control.
- 2** Return button
 - Press the button to exit the menu or return to the previous menu level.
- 3** Right scroll wheel and confirmation button
 - Long press the scroll wheel to display the options available on the right side of the dashboard, then scroll the wheel through the options, and press the scroll wheel to select.
 - When the menu is displayed on the right side of the dashboard, scroll the wheel to navigate through the options, and press the scroll wheel to select.

- When the menu is not displayed on the right side of the dashboard, scroll the wheel to adjust the control function you selected.
 - When a double selection pop-up window appears on the dashboard, press the scroll wheel to select the corresponding option.
- 4** Menu button
- Press the menu button to enter the menu function, scroll the wheel to navigate, then press the scroll wheel to enter the function settings.
 - Blowing mode: Scroll the wheel to adjust the A/C blowing mode.
 - Media source: Scroll the wheel to control which media player is played.
 - Screen brightness: Scroll the wheel to adjust the display brightness or press the scroll wheel to restore the default value.
 - Wind power: Scroll the wheel to adjust the air speed of the A/C system.
 - Temperature: Scroll the wheel to adjust the temperature or press the scroll wheel to turn the temperature control off and on.

i Note

- The menu button content can be set via the CID "  → Vehicle Settings → Dashboard Menu Content".



2. Pre-Use Preparation (Interior Equipment)

Interior Rear-View Mirror

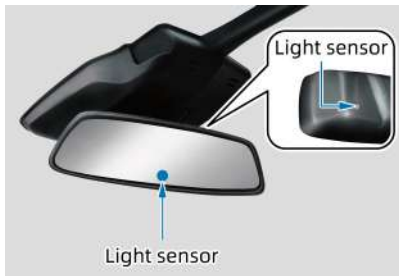

It can automatically reduce the light coming from the rear based on the light sensor, thereby optimizing rear visibility for driver.

- ▶ Be careful not to cover the light sensor on the interior rear-view mirror, and keep the surface clean.



2. Pre-Use Preparation (Interior Equipment)

Mobile Phone Wireless Charging

Based on electromagnetic induction, this function is used to charge mobile phones without cables.

Charging Operation and Status Query



The effective range for wireless charging is in the front storage box, with the central area marked by the "arrow". When charging, please place your phone face up and flat in the induction area. The phone screen will display a charging icon or the CID displays the corresponding status icon to indicate successful charging.

Wireless Charging



Mobile device wireless charging

Wireless devices will not be charged when turned off

The wireless charging for mobile phones is turned on by default. If you need to manually turn it on/off, the steps are as follows:

- Set it off or on via the CID "🚗 → Vehicle Settings → Mobile device wireless charging".



2. Pre-Use Preparation (Interior Equipment)

Caution

- The wireless charging function is only available for "Qi" certified phones, and may cause accidents if using non-certified products.
- Only one phone can be charged wirelessly at a time, with the maximum charging power of 15W.
- On bumpy roads, this function may work intermittently. If the phone charging stops due to deviation from the induction area, you need to move the phone back to the induction area.
- This function is achieved through the wireless connection between vehicle and mobile phone. Therefore, charging may fail in case of either vehicle or phone fault.
- The phone may stop charging due to overheating, please wait until it cools down to continue charging.
- The wireless charging function will pause for about 2-3s during vehicle starting or when the vehicle reaches 40km/h for the first time, the charging will become normal after the authentication between vehicle and key is completed.

Warning

- The wireless charging function has a heating effect on metal. Please check your phone back and the induction area for metallic foreign bodies before charging, otherwise it may cause damage to the metallic foreign bodies due to heating, and even cause a safety accident. Metallic foreign bodies in this context refer to other objects with metallic content, including but not limited to chips and magnetic stripe cards.
- Do not spill water in the front storage box, or it may enter the wireless charging module and cause damage to the electronic components.
- The external wireless charging coil may cause accidents. Please use it with caution.
- Please do not leave your cell phone charging in the vehicle when the driver is not in the vehicle, or it may cause safety hazards.
- Please do not place heavy objects on the induction area, or it may damage the wireless charging module.
- If the charging function does not work properly, stop using it and contact your local authorized service center for troubleshooting.



2. Pre-Use Preparation (Interior Equipment)

Interior Door Handles



- When a door is unlocked, pull the interior door handle and push it outward to open the door.
- When a door is locked, pull the interior door handle once to unlock the door.

i Note

- Pull the interior door handle once to unlock four doors.

Windows

After the vehicle is powered on, you can open or close the windows through the master window switch, passenger window switches and the CID.

Master Window Switch



- 1 Left front door window switch
- 2 Right front door window switch
- 3 Passenger window lift lock switch
- 4 Left back door window switch
- 5 Right back door window switch



2. Pre-Use Preparation (Interior Equipment)

Passenger Window Switch



The left rear door, right front door and right rear door are equipped with a passenger window switch with 2 levels of operation:

1. One-touch lift: short press the switch, the window will automatically roll up to the fully open position; gently pull the switch, the window will automatically roll up to the fully closed position.
 2. Partial lift: to partially roll down the window, gently press and hold the switch, and release it when the window rolls down to the desired position; to roll up the window, gently pull the switch, and release it when the window rolls up to the desired position.
- If the window is open, when the lock button of the remote key is pressed, the door locks and the window automatically rises to the fully closed position.

Turning On/Off with CID

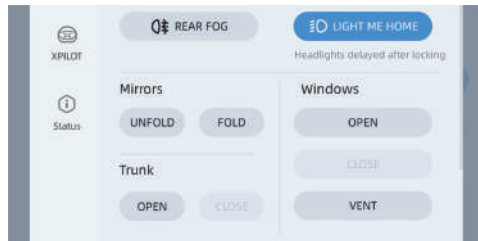

Tap "🚗 → Quick Controls → Windows" on the CID to enter the window control interface:

- Ventilation: tap the "VENT" button to roll down the four windows to the ventilation position.
- To open all windows: tap the "OPEN ALL" button, and the four windows will automatically roll down to the fully open position.
- To close all windows: tap the "CLOSE ALL" button, and the four windows will automatically roll up to the fully closed position.



2. Pre-Use Preparation (Interior Equipment)

i Note

- During the process of auto up or auto down, if the glass lift switch is gently pressed or pulled up again, the corresponding window will stop at the current position; if the glass lift is pressed or pulled up again, the corresponding window will perform the opposite action.

! Caution

- If you find that the window anti-pinch function does not work (no automatic window up function), please go to the local authorized service center for service.

! Warning

- Before closing the window, the driver must ensure that all passengers (especially children) do not stick any part of their body out of the window, otherwise there is a risk of pinching!
- When there is a child in the vehicle, to ensure safety, it is necessary to lock the passenger window switch to prevent the child from operating the window and getting pinched.

In-Vehicle Power Interface

Front USB Interface



- Slide the cover plate backward to use the front USB interface.
 - ▶ USB power interface: After the vehicle is powered on, passengers can charge their devices by connecting USB cables.
 - ▶ USB media source interface: for software upgrade service, charging, microphone, etc.



2. Pre-Use Preparation (Interior Equipment)

Rear USB Power Port



- After the vehicle is powered on, passengers can charge their devices by connecting USB cables.
 - ▶ The USB power connector outputs a maximum current of 2.1A under normal conditions.

⚠ Caution

- To protect the vehicle's electrical system, never connect a power generating device to the USB port.
- The moment the vehicle is powered on and off, unplug your device from the USB port to avoid it from being damaged by voltage fluctuations.
- It is prohibited to use the USB ports when the vehicle is unoccupied. Improper use of the USB port may cause fire.
- It is prohibited to use high-power electrical equipment.
- The operation and use by children is prohibited.

2



2. Pre-Use Preparation (Interior Equipment)

Front-Row 12V Power Port

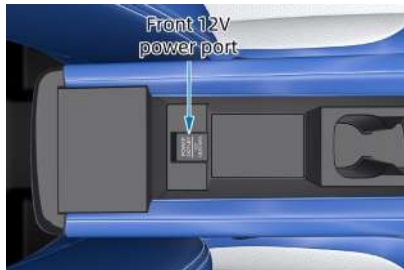

- Open the storage box cover upward to use front 12V power port.
 - ▶ The maximum available power is up to 180W.

Reflective Vest



- The reflective vest is located in the glove box. It is necessary to wear it as required when dealing with emergencies.



2. Pre-Use Preparation (Interior Equipment)

Dashboard

The dashboard displays information on the status of the vehicle's systems, functions, and charging status, etc. During daily driving, pay attention to your dashboard to learn the vehicle status in real time.

All pictures shown below are for illustration purpose only and shall be subject to the real vehicle. The actual dashboard display may vary due to changes in settings, function usage, vehicle configuration, software version, etc.





2. Pre-Use Preparation (Interior Equipment)

1 Left dashboard display area:

- Long press the left scroll wheel of the steering wheel to set the content of the display area.

2 Vehicle display:

- It will display when the vehicle is on and normally using adaptive cruise control, forward collision warning, and other functions.

3 Indicator lights:

- Indicator lights located in different positions on the dashboard can reflect the status of the vehicle's system functions [Refer to Page 47](#).

4 Gear indicator light:

- Highlights the corresponding gear according to the current gear of the vehicle [Refer to Page 62](#).

5 Vehicle speed:

- Displays the current driving speed.

6 Right dashboard display area:

- Press the menu button on the right side of the steering wheel and the area displays the menu setting items.
- Long press the scroll wheel on the right side of the steering wheel to set the area display content.

7 Time/Temperature:

- It displays the current time and temperature outside the vehicle.

8 Battery indicator light/range:

- Displays the percentage of the traction battery and the estimated range.

Note

- The beeps and brightness of the dashboard can be adjusted through the CID system settings.
- The display area on the right side of the dashboard can be set via the CID " → Vehicle Settings → Dashboard Menu".



2. Pre-Use Preparation (Interior Equipment)

Indicator Lights

2



Some indicator lights will come on when the vehicle is powered on and go off after system self-inspection. Some indicator lights are on to indicate the current status of the vehicle system functions, not for system faults.

If you are unsure when an indicator light is on during daily driving, contact your local authorized service center for advice.



Door open indicator light



Right turn signal and hazard warning indicator light

READY

READY indicator light



Airbag fault indicator light



2. Pre-Use Preparation (Interior Equipment)

 Economy mode indicator light

 Sport mode indicator light

 Rear fog light indicator light

 Position light indicator light

 High beam indicator light

 Low beam indicator light

 Left turn signal and hazard warning indicator light

 AutoHold ON indicator light

 AutoHold fault indicator light

 Unfastened driver's seat belt warning indicator light

 Unfastened front passenger's seat belt warning indicator light

 Unfastened rear left seat belt warning indicator light

 Unfastened rear middle seat belt warning indicator light

 Unfastened rear right seat belt warning indicator light

 EPB status indicator light

 EPB fault indicator light

 Electric Power Steering (EPS) indicator light

 12V battery charging system indicator light



2. Pre-Use Preparation (Interior Equipment)

2



Braking system fault indicator light



Charging gun connected indicator light



ESP indicator light



Electric system fault indicator light



ESP OFF indicator light



Motor and IPU overheat indicator light



ABS indicator light



Traction battery high temperature indicator light



HDC on indicator light



Traction battery low temperature indicator light



HDC fault indicator light



Traction battery fault indicator light



Tire Pressure Monitoring System (TPMS) indicator light



Traction battery cutoff indicator light



Low battery indicator light



Blind Spot Security system fault indicator light



Vehicle Control Unit (VCU) power limited indicator light



Forward Collision Mitigation (FCM) System Fault indicator light



2. Pre-Use Preparation (Interior Equipment)



ACC ON indicator light



ACC Ready indicator light



ACC exit delay indicator light



ACC fault indicator light



Lane Departure Warning fault indicator light



Coolant temperature overhigh indicator light



FCM System OFF indicator light



Lane Centering Control (LCC) available indicator light



Lane Centering Control (LCC) activated indicator light



LCC exit delay indicator light



Lane Centering Control (LCC) fault indicator light



Smart system fault indicator light



Main warning light



Schedule charging indicator light



2. Pre-Use Preparation (Interior Equipment)

Exterior Lights

Equipped with automatic sensing headlights, this vehicle can automatically turn on/off the position light and the high beam by detecting the ambient light condition with the light sensors. You can also control the lights manually with the CID, switch, etc.

Control with CID

Tap "🚗 → Quick Controls" on the CID to enter the light control interface, and tap light buttons to control corresponding lights.



- 1 Turn off all exterior lights
 - Tap this button to turn off all exterior lights; tap light buttons to turn on corresponding lights.
- 2 Position light
 - Tap this button to turn on/off position lights, license plate lights, etc.

- 3 Low beam
 - When the position lights are not on, tap this button to turn on/off the position lights, low beam, etc.
- 4 Automatic control
 - Tap this button to activate/deactivate the automatic control.

⚠ Caution

- The automatic control function may be limited by the external environment. If it does not work properly, please turn on the lights manually in time if necessary.

- 5 Light Me Home function
 - Tap to deactivate the Light Me Home function.
 - With this function activated, when you park the vehicle in a dark environment, the high beam and position light will be on for 30s and then go off after the vehicle is powered off. Within 30s, if you execute the locking and setting operation, the high beam and position lights will be on for 10s and then go out.
- 6 Rear fog lights
 - When the low beam is on, tap this button to turn on/off the rear fog lights.
 - When the position lights are off, the rear fog lights will go off.



2. Pre-Use Preparation (Interior Equipment)

Daytime Running Lights

- When the vehicle is in READY state, the vehicle gear is not in P gear and the close light and turn signal are off, the daytime running light is on. If the turn signal is turned on, the daytime running light on the corresponding side is temporarily off, and will be re-lit after the turn signal is turned off.

High Beam



- With the low beam on, flip the combination switch forward/backward to turn on/off the high beam;

- Continuously flip the switch backward and release it, the high beam will flash to alert the preceding vehicle or give a sign.

Note

- When the high beam is malfunctioning, the dashboard will display the message "Please check high beam".

Caution

- High beam can dazzle the driver of oncoming car, so please use it properly.

Turning Assistance Light

When turning the steering wheel to turn, it will light up the corresponding side turning assistance lamp separately to assist the moving vehicle to illuminate the blind area of the curved road, and after the steering wheel returns to the center, the single-side turning assistance light turns off.



2. Pre-Use Preparation (Interior Equipment)

Manual Adjustment of Headlight Height



- Turn the roller to adjust the headlight height among 0, 1, 2, 3 gears.

Please refer to the table below for the appropriate roller position for the vehicle driving and load conditions



Conditions	Roller Position
Driver only	0
Driver and one front passenger only	
A total of five people in the front and rear seats	1
A total of five people in the front and rear seats with luggage in the trunk (within the maximum permissible axle weight and maximum permissible vehicle weight limits)	2
Driver only, with luggage in the trunk (within the maximum permissible axle weight and maximum permissible vehicle weight limits)	3



2. Pre-Use Preparation (Interior Equipment)

Turning Signal Lights



- Flip the combination switch down or up to turn on the turn signal lights. Then the corresponding  or  indicator light on the dashboard will flash with "da-da" sound.
- Flip the combination switch back to the center position or turn the steering wheel back to turn off the turn signal lights.

Lane Change Flashing

To indicate a lane change, quickly flip the combination switch up or down and release it. Then the corresponding turn signal light will flash 3 times.

Hazard Warning Light



- Press the hazard warning light switch at the CID bottom to turn on the hazard warning light. Then all turn signal lights will flash. Press the switch again to turn the hazard warning light off.

Note

- The hazard warning light can be switched on whether the vehicle is powered on or off.



2. Pre-Use Preparation (Interior Equipment)

Interior Reading Lights

This vehicle is equipped with front and rear interior reading lights.



- When the interior reading light is off, press the interior reading light and the corresponding interior reading light lights up. Press again to turn off the corresponding interior reading light.
 - ▶ The front interior reading light illuminates when either of the front doors is open. The front interior reading lights go out when the doors are closed.
 - ▶ The rear interior reading light illuminates when either rear door is opened. The rear interior reading light goes out when the doors are closed.



2. Pre-Use Preparation (Interior Equipment)

Wipers and Washers



After the vehicle is powered on, rotate the wiper switch to select:

- OFF: turn off wiping.
- INT: intermittent wiping.
- LO: continuous low-speed wiping.
- HI: continuous high-speed wiping.



After the vehicle is powered on, flip the washer switch to select:

-  : washing with water.
- OFF: turn off washing.
 - ▶ The washer switch will automatically return to the default position when released.
- MIST: wiping with mist.



2. Pre-Use Preparation (Interior Equipment)

2

Intermittent wiping

- Turn the wiper switch to the "INT" position to activate intermittent wiping.
 - ▶ The intermittent low speed wiping time can be set via "🚗 → Vehicle Settings → Wiper INT Speed" on CID.

Continuous Low-Speed Wiping

- Turn the wiper switch to the "LO" position to activate continuous low-speed wiping.

Continuous High-Speed Wiping

- Turn the wiper switch to the "HI" position to activate the continuous high-speed wiping.

Washing with Water

- Flip the washer switch to the "🚿" position, and the washers will start spraying water. The wiper starts to wipe if it keeps for a long time.
 - ▶ If the wiper switch is at "OFF", the wiper wipes at low speed. After releasing the washing switch, the washer stops spraying water. After the wiper wipes at low speed completes the current cycle, the wiper will stop at low speed for 3 cycles.
 - ▶ If the wiper switch at the "LO" or "HI" position, release the washer switch, the washers will stop spraying water, and the wipers will keep working at a low or high speed.

Wiping with Mist

- Flip the washer switch to the "MIST" position and release it immediately, the wipers will wipe for one stroke.
- Flip the washer switch to the "MIST" position and hold it, the wipers will keep working. Release the switch, the wipers will stop working.



Caution

- When there is ice or a lot of snow on the front windshield, it is recommended to remove it manually before starting the wipers, otherwise it will damage the wiper motor.



2. Pre-Use Preparation (Interior Equipment)

Low-Speed Warning Sound

G3i is a pure electric vehicle, which makes low noise during driving. To alert pedestrians to the presence of the vehicle, low-speed warning sound is provided.

When the driving speed is < 30 km/h, the vehicle will make the warning sound.



Vehicle Power On/Off

Vehicle Power On

1. Provided that the driver seat is unoccupied, the vehicle will be powered on when the driver door is closed and then opened.
2. Provided that the vehicle is power-off and the key is placed in the vehicle, the vehicle will be powered on when you step on the brake pedal.

Vehicle Power Off



1. After the vehicle is powered on, press down the emergency power-off switch for approximately 5s to trigger activation and enter the forced power-off process.
 - ▶ If it has been in an idle state, the whole vehicle will be powered off after you long press for 5s.
 - ▶ If the speed is > 3 km/h within 5s, a pop-up window will appear on the dashboard that "You have triggered the emergency power-off function and the system is about to power off. Please confirm". Then you need to confirm whether the vehicle is powered off through the control button on the steering wheel. The left roller corresponds to "Cancel", while the right one corresponds to "Confirm". If you do not tap "Confirm" or "Cancel" during the pop-up time, the vehicle will not be powered off by default.



3. Stable Driving

Note

- If the vehicle is in a non-READY state, do not step on the brake pedal while pressing down the emergency power-off switch to power off.
2. With the vehicle powered on or in the READY state in P gear, the driver seat unoccupied and all doors (including the front hood and tailgate) closed, the vehicle will be powered off through the following operations:
 - ▶ Remote locking by key.
 3. After the vehicle is parked and all doors are closed, the vehicle will actively power off after 1 hour.
 - ▶ On the 10-minute countdown, a pop-up window will be displayed on the CID to inform the customer. The customer can tap to cancel and restart the 1-hour countdown after cancellation.
 - ▶ Tap " → Vehicle Setting → Auto Power Down" on the CID to set the switch on/off.



Start the Vehicle

1. Get into the vehicle with key.
2. Step on the brake pedal and shift to Gear R or D to start the vehicle.

i Note

- After the vehicle is started, the dashboard will beep with the "READY" indicator on.
- When the vehicle cannot be started during charging, the dashboard will display "Gun connected, gearshift disabled".
- If you fail to step on the brake pedal to start the vehicle, the dashboard will display "Please apply the brake before gearshift".

Emergency Vehicle Start

If the dashboard displays "Please replace the key battery", it indicates that the key power is low. You can try to hold the key tight (as shown below) and then step on the brake pedal and shift to Gear R or D to start the vehicle.



i Note

- When the key battery is low, replace it as soon as possible.



3. Stable Driving

Gearshift

Press the brake pedal and flick the shift lever up or down. When the gear indicator comes on, it indicates the gear has been shifted successfully.

Gears



The vehicle is equipped with the following gears:

- R: Reverse gear
- N: Neutral gear
- D: Drive gear
- P: Park gear

R: Reverse gear

When the vehicle is in an idle state, step on the brake pedal while move the shift lever upward to the second gear. Then the indicator of gear "R" on the dashboard will come on, and the gear will be shifted to R.

N: Neutral gear

The vehicle gear can be shifted to N through the following operations, with the gear "N" indicator highlighted on the dashboard:

- With the gear in D, pivot the shift lever up or down to the first gear and hold for 1s.
- With the gear in R, pivot the shift lever up or down to the first gear and hold for 1s.
- With the gear in P, press the brake pedal and push the shift lever up or down to first gear for 1s.

D: Drive gear

When the vehicle is in an idle state, step on the brake pedal while pushing down the shift lever to the second gear. Then the indicator of gear "D" on the dashboard will come on and the gear will be shifted to D.



P: Park gear



When the vehicle is in an idle state, step on the brake pedal while pressing the Gear 'P' button of shift lever. Then the indicator of gear "P" on the dashboard will come on and the gear will be shifted to P.

- ▶ When the vehicle is powered off, the gear will be automatically shifted to gear P.
- ▶ When the charging gun is connected to the vehicle for charging, the gear will be automatically shifted to P.
- ▶ With the gear in D or R and vehicle speed < 3 km/h, when the driver neither fastens the seat belt nor steps on the brake pedal and accelerator pedal, the gear will be automatically shifted to P after the driver's door is opened.

Caution

- Certain conditions need to be satisfied to shift gears. If you shift the gear with the conditions unsatisfied, the dashboard will show "In charging, unable to shift gears", "Please apply the brake before shifting gears", or "Please slow down first and then shift gears", etc. Operate according to the prompts to satisfy the gearshift conditions.
- If you are unable to shift gears normally, contact your local authorized service center for troubleshooting.
- Before you leave the vehicle or leave it on a ramp, make sure you have engaged the Gear P to prevent the vehicle from moving gratuitously.



3. Stable Driving

Driving Mode

The vehicle is available in four driving modes: "Standard, Sport, Eco,Stable Drive Mode".

Selections can be made through the drop-down menu screen:

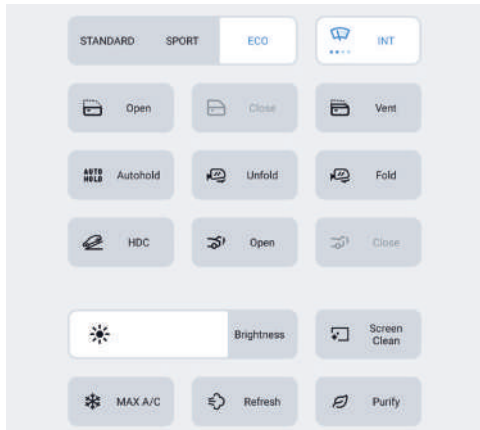

- Select a preferred driving mode by tapping on the drop-down menu screen that slides down from the top of the CID.

Select via the CID screen:

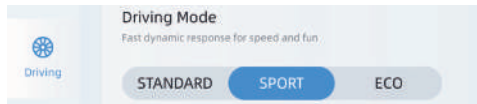

- Tap "🚗 → Driving" button to enter the driving experience interface, and then tap to select the preferred driving mode:
 - STANDARD: Moderate dynamic response with more comfortable driving & riding experience.
 - SPORT: Faster dynamic response with more driving pleasure and maximum acceleration.
 - ECO: Smooth dynamic response and longer endurance mileage can be obtained.
-
- Stable Drive Mode: Smoother power output and weaker energy recovery.





Energy Regeneration

The energy regeneration is a strategy intended to have the motor brake to regenerate electrical energy when the vehicle is coasting or braking and then charge the traction battery, thereby increasing the range.

Energy Regeneration When Coasting

With the accelerator pedal and brake pedal released, the vehicle can regenerate energy during coasting.

Energy Regeneration When Braking

Depress the brake pedal to regenerate energy during braking.

Energy Regeneration Intensity Checking



The energy recovery intensity can be viewed via the Energy Meter on the dashboard.

- ▶ Long press on the roller of the steering wheel to view the energy meter.

Factors Affecting Energy Regeneration

The amount of energy fed back to the traction battery through energy regeneration brake depends on the following factors:

1. Current status of the traction battery:
 - The traction battery is fully charged.
 - The traction battery is hot.
 - The traction battery is cool.
2. Energy regeneration setting:

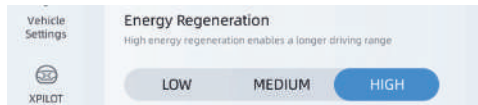

- Enter the driving experience interface via "🚗 → Driving" on the CID, and tap to select the energy regeneration level.
- Then the energy regeneration brake will adjust the amount of energy regenerated according to the set level.



3. Stable Driving

3. Energy Regeneration Mode:

- Different energy regeneration modes have different energy regeneration intensities, among which the high energy regeneration mode has the largest energy regeneration intensity.

Note

- If the energy regeneration brake significantly reduces driving speed (e.g., when driving on a steep slope), the brake light will come on to remind the driver behind that you are slowing down.

Caution

- The deceleration realized by energy regeneration brake cannot replace the braking required for safety, and the driver shall apply the brake in time according to the actual situation.





Interior Air Conditioner



- 1 Turn off the switch on the A/C interface
- 2 A/C instructions inlet
- 3 Interior PM 2.5 sensor data display area.
- 4 Top control bar
 - 🌿: Purification for PM 2.5.
 - ❄️: MAX A/C mode.
 - 🔄: REFRESH mode.
- 5 Air outlet mode visual display area
- 6 Temperature regulation
 - Slide up and down to set the A/C temperature.
 - After tapping the "Synchronize" button, the right side temperature is synchronized with the left side temperature setting.
- 7 Air volume adjustment
 - Slide the slider left and right to adjust the air volume.
- 8 Air outlet mode
 - Tap to select the air outlet mode, the mode is displayed in area 8.
- 9 Bottom control bar
 - A/C: Tap to turn on/off the A/C cooling.



3. Stable Driving

- AUTO: Tap to enter the air conditioning automatic control mode.
- : Tap to turn on/off the A/C system.
- : Tap to switch between recirculation mode and fresh air mode.
- ECO: Tap this button to enter the economy A/C mode.
- 10 Tap to pop up the A/C control interface
- 11 Seat heating and ventilation function*

MAX A/C Mode

- It is suitable for getting into the vehicle in hot summer to greatly cool down the interior; this mode achieves the whole process with just one tap, improving driving concentration and travel safety.

Turn on MAX A/C mode

- Tap the MAX A/C icon or say "Hi, XPENG, turn on MAX A/C" to turn on the MAX A/C function. After the function is turned on, the system will automatically adjust the temperature, air volume, and fan speed, etc. of the air conditioner to cool down the interior quickly.

Exit MAX A/C mode

- You can also exit this function by tapping MAX A/C key below A/C interface or say "Hi, XPENG, exit MAX A/C mode" to exit this mode and then the air conditioner will automatically lower the temperature and wind speed.

- Starting any one of defrost mode, AUTO mode, PM 2.5 mode will automatically exit the MAX A/C mode.
- In the case that the temperature in the cabin is less than 25°C, the MAX A/C mode will automatically exit after 1 min of starting.
- After the function is enabled, some Settings such as manually adjusting the temperature will exit the extreme cooling mode.

REFRESH Mode

- This mode can effectively remove formaldehyde and odors from the car by intelligently setting the functions of the A/C, such as internal and external circulation, air volume.

Turn on the REFRESH mode

- Tap the REFRESH icon to turn on this mode.

Exit REFRESH mode

- Tap the REFRESH icon to turn off the mode.
- Regulate the air volume and blowing mode to exit the mode.
- Switch to other smart modes.

Cooling/Heating

- Adjust the temperature to cool or heat by sliding the slider.



Front Seats

Proper Driving Position

Whether the driver seats properly has a direct impact on driver fatigue and driving safety.

To improve safety and reduce the risk of injury or death in an accident, the driver should perform the following operations:



1. Sit upright with your feet on the floor.
2. Make sure you can easily reach the pedals, hold the steering wheel with your hands with your arms slightly bent, and keep your chest at least 25 cm away from the center of the airbag cover shell.

3. Place the middle part of the seat belt between your neck and shoulder. Tighten the lap portion of the seatbelt around the hip joint (not the abdomen).

i Note

- When measuring the seat cushion depth, slide the seat to the middle of the rail, and adjust the seat backrest to normal angle (24°).



3. Stable Driving

Front seats come with multi-direction electric adjustment function.



Adjust the driver's seat through the switch:

- 1 Move the seat forward/backward.
- 2 Adjust the seat height.
- 3 Adjust the backrest.
- 4 Adjust the lumbar support*.





Adjust the front passenger's seat through the switch:

- 1 Move the seat forward/backward.
- 2 Adjust the seat height.
- 3 Adjust the backrest.

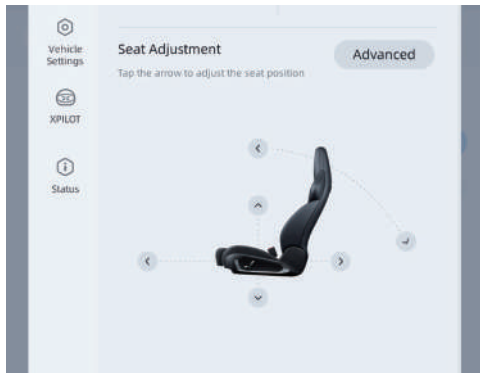

Adjusting the Front Seats with the CID



Tap "  → Quick Controls" on the CID to enter the seat control interface:

- Tap the "Smart Adjustment" button, the system enters the smart adjustment interface.
- Tap the corresponding buttons to adjust the backrest, seat height, and move the seat forward/backward.

Caution

- Be careful when adjusting the seat to avoid the seat movement from hurting other occupants.
- Do not put your fingers or other body parts under the seat as they may get pinched by the seat.
- Never place a foot mat thicker than 10 mm or other foreign objects (such as drink bottles, charcoal bags) under the front seat, they may get caught between the seat and the rail and hinder the seat adjustment and locking, thus damaging the seat. It is recommended to use the foot mats officially certified by XPENG.
- Do not adjust the front seats during driving, as you will deviate from the correct seating position while adjusting, which may cause personal injury or death.
- Do not adjust the seat with the seat belt on, or it may lead to personal injury of other occupants and failure of protection if the seat belt is unfastened.
- Do not modify or remove the front seats by yourself.



3. Stable Driving

Welcome Mode



- Tap "🚗 → Vehicle Settings → Driver Seat Easy Entry" on the CID to turn on/off the welcome mode.

i Note

- When the welcome mode function is on, the seat will automatically be adjusted to the welcome position.

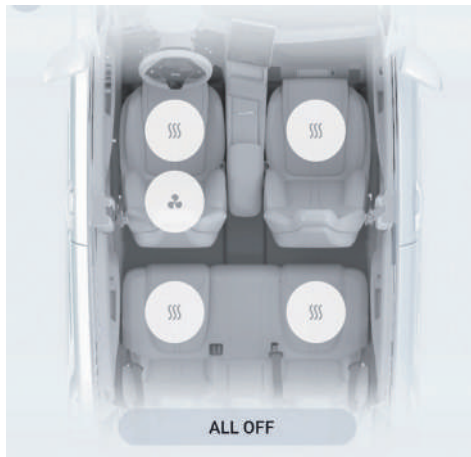
Seat Ventilation/Heating*



- Once the vehicle is powered on, tap  to access the A/C control interface. Tap the  button to enter seat ventilation and heating functions interface.



- Tap or button to turn on the heating for the corresponding side seat, and the heating intensity will change by one level with each tap of the button.
- Tap the button to turn on the driver's seat ventilation or heating function, and the ventilation intensity will change by one level with each tap of the or button.
- Tap the "ALL OFF" button to deactivate all seat ventilation and heating functions.

Note

- The seat ventilation/heating function is at the max level of 3 by default when turned on, and each tap of the button will decrease the intensity by 1 level and turn on the corresponding level indicator.

Rear Seats

The rear seats in this vehicle are detachable, and can be folded forward independently.

Fold Rear Seats



1. Press the seat backrest switch.
2. Fold forward the backrest.
 - ▶ To restore the backrest, lift the backrest upward and push back until it is firmly locked.



3. Stable Driving

Caution

- When folding the backrest, remove objects from the rear seats, so as not to obstruct the seat backrest folding effect.
- After restoring the seat backrest, check that it is securely locked.



Ride with Children

Instructions for Ride with Children

For the protection of children, install an appropriate child safety seat according to the child's age, weight and height, following strictly the instructions provided by the child safety seat manufacturer.

Sun Visor Label

See the following label mounted on the sun visor.

i Note

- The images shown below are for reference only, please refer to the actual vehicle.



! Warning

- Child is prohibited from sitting in the front passenger seat.
- Do not place rear-facing child seat on this seat with airbag. Death or serious injury can occur.



3. Stable Driving

Child Safety Seat Information

Mass Group		Front Passenger Seat	Rear Middle Seat	Rear Seats on Both Sides
Group 0	10 kg	x	x	U
Group 0+	13 kg	x	x	U
Group I	9-18 kg	x	x	U/UF
Group II	15-25 kg	x	x	U/UF
Group III	22-36 kg	x	x	U/UF

Notes:

- U: "Universal" child safety seats are suitable for this mass group.
- UF: Forward-facing "universal" child safety seats are suitable for this mass group.
- X: A seat that is not suitable for installing a child safety seat for this mass group.



Child Safety Seat Dimension Types

Dimension Type	Meaning
A	Full height forward-facing child restraint system for toddlers
B	Reduced height forward-facing child restraint system for toddlers
B1	Reduced height forward-facing child restraint system for toddlers
C	Full-size rear-facing child restraint system for toddlers
D	Reduced-size rear-facing child restraint system for toddlers
E	Rear-facing child restraint systems for infants
F	Left-facing child restraint system (portable bed)
G	Right-facing child restraint system (portable bed)



3. Stable Driving

Child Safety Seats Fixed by ISOFIX

Mass Group		Dimension Type	Fixture	Front Passenger Seat	Rear Middle Seat	Rear Seats on Both Sides
Portable crib		F	L1	x	x	x
		G	L2	x	x	x
Group 0	10 kg	E	R1	x	x	IL
Group 0+	13 kg	E	R1	x	x	IL
		D	R2	x	x	IL
		C	R3	x	x	IL
Group I	9~18 kg	D	R2	x	x	IL
		C	R3	x	x	IL
		B	F2	x	x	IUF
		B1	F2X	x	x	IUF
		A	F3	x	x	IUF

Notes:

IL: A seat that is suitable for installing a "vehicle-specific, restricted or semi-universal" ISOFIX child safety seat.

IUF: A seat that is suitable for installing an universal ISOFIX forward-facing child safety seat for this mass group.

X: A seat that is not suitable for installing an ISOFIX child safety seat.

ISOFIX: international standard for attachment points for child safety seats in passenger cars.



For Tall Children

If a child is too tall to use a child safety seat, but too short to safely use a standard seat belt, you can purchase and properly use a child's raised seat cushion that meets the relevant regulations or standards. Use a child's raised seat cushion to increase the child sitting height, so that the shoulder belt stays right in the middle of the child's shoulder and the crotch belt is lowered to the crotch.

Child Safety Seat Installation

There are two general methods of installing child safety seats:

1. Seatbelt fixed child safety seats:
 - This kind of seats should be secured with the vehicle's seat belts.
2. ISOFIX fixed child safety seats:
 - This kind of seats can be secured to the anchor bars built into the rear seats of the vehicle.

Installing a Seatbelt Fixed Child Safety Seat



1. Place the child safety seat on both rear seats and pull out the seat belt completely. Fasten and buckle the seat belt according to the child safety seat manufacturer's instructions.
2. Retract the seat belt, push the child safety seat firmly into the seat while tightening the seatbelt.
3. If the child safety seat has an upper tether, attach the tether to the seat backrest.



3. Stable Driving

ISOFIX Anchor Points



The ISOFIX anchor points are located between the backrests and cushions of rear seats on both sides. The exact location of each anchor point is marked as above (as shown in the figure).

- ▶ The anchor points are located directly below the child safety seat identification button.



The ISOFIX anchor points are located behind the rear seat backrests on both sides. The exact location of each anchor point is marked as above (as shown in the figure).

- ▶ The anchor points are located directly below the child safety seat identification button.



Checking the Child Safety Seat

After installing the child safety seat, check the seat for looseness:

1. Secure the child safety seat by the seat belt path and try to slide the seat from side to side, and from front to back.
2. If the seat can move more than 2.5 cm, indicating that it is too loose, fasten the seat belt or reconnect the ISOFIX fixed child safety seat.
3. If you cannot fasten the seat, try another seat position or replace the seat.

Warning

- Even if a child safety seat or raised seat is used, do not allow the child to sit in the front passenger seat and never place a rear-facing child safety seat in a seat with an activated airbag, or it will pose a serious risk of injury or death.
- Never use a forward-facing child safety seat until the child weighs more than 9 kg and can sit in the vehicle independently. Children under two years of age do not have a fully developed spine and neck and should avoid frontal impact injuries.

Warning

- Infants and toddlers should never be allowed to sit on parents' laps. All children should be restrained in appropriate child safety seats at all times.
- To ensure a safe ride for your child, be sure to follow all instructions detailed in this manual, as well as those provided by the child safety seat manufacturer.
- Do not use extensions for belts of seats installed with child safety seats or raised seats.
- For a tall child, ensure that the child's head is supported and that the child seat belt is properly adjusted and secured. The shoulder part of the seat belt must be fastened away from the face and neck, and the lap section must also be fastened away from the abdomen.
- Never tie two child safety seats to one anchor point, as one anchorage may not be firm enough to secure both seats in the event of a collision.
- Child restraint anchorages are designed to withstand only those loads imposed by correctly fitted child restraints. Under no circumstances, shall the child protection device be used for adult seat belts, wiring harnesses or the installation of other items or equipment.



3. Stable Driving

Installing an ISOFIX Child Safety Seat



The child safety seats can only be installed in the rear seats on both sides.



1. Place a child safety seat in the rear seat.
2. Insert the lower anchor bracket of the child safety seat into the ISOFIX anchor points according to the child seat manufacturer's instructions.



3. Stable Driving



3

3. If the child seat is equipped with upper tethering, it is recommended to choose the configuration of the double side upper tethering and that shall be tied well.
- ▶ If the seat is equipped with a single-sided upper strap, wrap the strap around the inner side of the headrest, attach the hook and loop to the anchor points and tighten the tether.

- ▶ If the seat is equipped with a double-sided upper strap, wrap the strap around both sides of the headrest, attach the hook and loop to the anchor points and tighten the tether.

Warning

- Always check safety belt and tethers for damage and wear.
- Do not leave children alone in the car even if they have been put in child safety seats.
- Never use a child safety seat that has been in a car accident, modified, or damaged. Have the seat checked or replaced in accordance with the child seat manufacturer's instructions.



3. Stable Driving

Child Locks

This vehicle is equipped with the electronic childproof locks on the rear side doors, which can prevent children from accidentally opening the rear doors through the inner door handles, reducing the risk of accidents.



- Locking: Insert the mechanical key and turn counterclockwise to lock the child lock.
 - ▶ It is recommended to lock the child locks when the child is sitting in the rear seat.
- Closing: Insert the mechanical key and turn clockwise to open the child lock.

Warning

- The use of child locks can prevent children in the car from unintentionally opening the rear doors, reducing the risk of accidents in the car.
- When the child lock is locked, the car internal handle can not open the rear door, then you shall open the rear door from outside; do not pull the car internal handle too hard to avoid damage.
- Do not leave child/children alone in the vehicle.



Seat Belts

Advantage of Wearing Seat Belts Properly

Properly wearing seat belts can restrain the driver and passengers in restricted positions, and reduce the risk of injury during a vehicle collision.

After a collision, seat belts assist other safety systems to absorb the energy generated by the collision at the same time, slowing down the inertia of forward motion of driver and passengers and preventing them from being thrown forward, meanwhile assure them the best protection by the airbags and minimize the injury impact.

Caution

- The driver and passengers must wear seat belts properly, otherwise they will be thrown out forward in an accident, which will not only injure themselves but also endanger others in the vehicle.

Seat Belt Pretensioners

In the event of a severe front or side collision, the pretensioners will operate simultaneously with the airbags. The pretensioners automatically tighten the seat belt straps to reduce slackness in the leg and diagonal sections of the seat belts, so as to reduce the forward lean of driver and passengers.



If the pretensioners and airbags are not activated at the time of collision, it doesn't indicate that they are faulty, but indicates that the intensity or type of collision is not enough to activate them.

Warning

- Once a seat belt pretensioner has been activated, it must be replaced. After an accident, airbags, seat belt pretensioners, and other related components must be sent for inspection and replaced if necessary.



4. Safe Driving

Seat Belts with Collision Warning

Seat belts have the following functions:

1. Gap elimination: When the vehicle is ready and the driver has fastened the seat belt, the seat belt will automatically retract, eliminate the gap between the driver and seat belt strap for the optimum comfort.
2. Auto retraction: When the driver unbuckles the seat belt, the seat belt will retract smoothly until it is fully retrieved.
3. Level 2 collision pre-warning: When the seat belt receives a FCM warning signal during driving, the seat belt will vibrate to alert the driver.
4. Level 3 collision pre-tensioning: When the seat belt receives a FCM collision pre-tensioning signal during driving, the electric seat belt will retract automatically, restrain the driver on the seatback and reduce the risk of injury or death.

Turning On/Off the Driver's Seat Belt Vibration Warning



Safety Belt Vibration Warning

Seat belt automatically tightens when XPilot Driving is active and the vehicle is straddling a lane

- Tap "🚗" → Vehicle Settings → Safety Belt Vibration Warning" on the CID to turn on/off this function. After this function is turned off, the seat belt gap elimination and auto retraction functions still work.



Warning

- Do not modify or repair the seat belt by yourself, please have it inspected or repaired in your local service center.
- After a collision or similar situation, the seat belts shall be promptly replaced after being subjected to a strong impact. Replacement is also a must if a seat belt has any sign of wear or damage.
- Although seat belts can alert you of a hazard, or avoid or mitigate injury to you in the event of danger, you still need to drive carefully to avoid the hazard.



Checking the Seat Belts

To confirm that each seat belt is functioning properly, the following three inspection items shall be conducted:

1. Check the seat belt, buckle and other devices for damage, modification, bleach, stain or dirt.
2. Fasten the seat belt and pull it out quickly at the closest point to the buckle. The buckle should remain securely locked.
3. Unbuckle the seat belt and retract it to the greatest extent. Check the seat belt for excessive looseness and wear.
4. Pull out the seat belt halfway. Hold the latch and pull the belt forward quickly. The internal locking mechanism should be automatically locked to prevent excessive rewinding.

If any seat belt fails any of the above test, please contact your local authorized service center immediately.

Fastening the Seat Belt



1. Slowly pull out the seat belt, and place it around the entire pelvis, chest, and collarbone, keeping it between the neck and shoulder.
2. Insert the latch into the buckle until it clicks, to ensure that it is locked into place.
3. Pull the seat belt hard to check if it is fastened.
4. Tighten the seat belt towards the reel.



4. Safe Driving

Unfastening the Seat Belt



1. Hold the seat belt latch.
2. Press the button on the belt buckle.
3. Continue to hold the seat belt latch until the seat belt is slowly retracted.

Use of Seat Belt by the Pregnant

Wearing a seatbelt properly can effectively reduce injuries to a pregnant woman and her fetus in the event of a collision or sudden stop.



A pregnant woman should the fasten the crotch/shoulder belt properly. The shoulder belt should pass over the chest from a suitable position. The crotch belt shall pass over the crotch as low as possible, and fit under the "bulging" abdomen. The seat belt must be flat without pressure on the lower body of the pregnant woman.

Please consult your doctor for better advice.



Use of Seat Belt by the Disabled

The disabled should also wear seat belts properly during riding. Please consult your doctor for better advice.

Seat Belt Indicator Lights

1. Unfastened driver's seat belt warning indicator light
2. Unfastened front passenger's seat belt warning indicator light
3. Unfastened rear left seat belt warning indicator light
4. Unfastened rear middle seat belt warning indicator light
5. Unfastened rear right seat belt warning indicator light

If the front passenger forgets to wear seat belt, the corresponding seat belt indicator light on the dashboard will flash with an intermittent beep.

If any rear passenger forgets to wear seat belt, the corresponding seat belt indicator light on the dashboard will flash. (This function is disabled by default.)

- Tap " → Vehicle Settings → Seats & Belts → Unfastened Rear-Seat Belt Reminder" on the CID to turn on/off this function.

If all passengers have fastened their seat belts but the indicator light is still flashing, re-buckle the seat belts to ensure that they are properly locked.

Seat Belt Precautions

Caution

- Everyone in the vehicle shall wear the seat belt properly during driving, or there is a high risk of injury or death in the event of an accident.
- Do not press the seat belt against fragile or sharp objects (e.g. pens, keys, glasses, etc.), or the pressure from the seat belt on these objects may cause injury.
- When wearing the seat belt, it must fit the body and not be distorted. The shoulder belt must pass over the middle of the passenger's shoulder and must be attached to the upper body of the passenger and fasten the body tightly. The crotch belt shall be around the hip as low as possible. If necessary, pull it down slightly, and adjust its looseness by pulling in the retraction direction.
- One seat belt is for one person only. It is prohibited to use one seat belt together with child by holding him/her on lap.
- In case of any sign of wear, cracking or other damages to the seat belt, please contact your local service center for replacement.



4. Safe Driving

Caution

- Avoid exposing the seat belt to any chemicals, liquids, etc. If any seat belt fails to retract or be removed from the buckle, please contact your local service center for troubleshooting as soon as possible.
- Do not add any non-official accessory to the seat belt, including but not limited to the following products: additional latches, strap restrictors, buckle extension connectors, etc., as they may reduce or even disable the seat belt's normal protection.
- Any seat belt shall be fully retracted without dangling if unused. If any seat belt cannot be retracted completely, please contact your local service center immediately for troubleshooting.
- Do not remove, install, modify or disassemble the seat belts, seat belt retractors, or seat belt anchors by yourself.



Airbags

Airbag Positions

The airbags are located in the areas shown in the figure below. The airbag warning message is attached to the sunvisor and the B pillar of the driver's door.

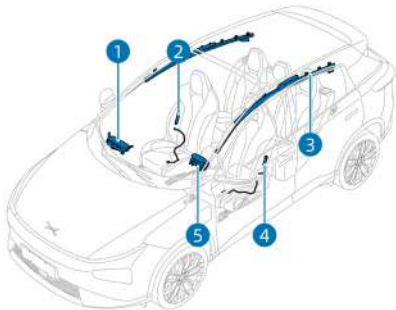

- 1 Front passenger's airbag
- 2 Front passenger's side airbag
- 3 Curtain airbag
- 4 Driver's side airbag
- 5 Driver's front airbag

Note

- Airbags are not substitutes for seat belts. Seat belts can reduce the risk of serious injury or death in the event of an accident, whether the airbag is triggered or not. Therefore, be sure to fasten seat belts properly. Airbags can only provide protection when triggered, and they will not be triggered in all types of accidents.

Auxiliary Protection System Indicator Light

The  indicator light will come on when the vehicle is powered on and go off after system self-inspection. If the indicator light does not go off after the system self-inspection or goes off and then comes on again or stays on, it indicates the airbag system is faulty. Please contact your local service center for troubleshooting as soon as possible.



4. Safe Driving

How Do Airbags Work

The airbag deployment does not depend on the driving speed, but on the collision strength by the collision sensors. The airbag may not deploy when the impact force of the collision is absorbed or dispersed into the vehicle body; However, the airbag may deploy depending on the collision conditions at the time of the accident. Therefore, the airbags' deployment should not be judged based on the vehicle's damage degree.

The airbags may deploy in the following situations:

- When crossing a deep pit, the car front hits the ground.
- The vehicle hits a projection, kerb, etc.
- The car front hits the ground when driving down a steep hill.

The airbags may not deploy in the following situations:

- The vehicle hits a concrete post, tree or other long, thin object.
- The vehicle tailgates into the underside of a truck, etc.
- The vehicle is rear-ended by other vehicles.
- The vehicle overturns or rolls sideways.
- The vehicle collides with a wall or vehicle in a non-front way.

The airbags deploy instantly and forcefully with a loud bang. The deployed airbags and seat belts can restrain the occupants' movement to reduce the risk of injury.

Impact of the Airbag Deployment

When deploying, the airbags will release a fine powder that will irritate the skin and should be thoroughly cleaned up.

After deployment, the airbags will retract to provide the occupants with a progressive shock-absorbing effect, avoiding that the driver's forward vision from being obstructed.

If the airbags have deployed or the vehicle has been involved in an accident, contact your local authorized service center promptly to have the airbags, seat belts, and other related components checked.



Warning

- Do not use seat covers, which would limit the deployment of the side airbags in the event of an accident and reduce the accuracy of the occupant detection system.
- Airbag deployment with considerable speed and force may result in personal injury. To prevent injury, ensure that all the occupants in the vehicle fasten seat belts properly.
- Do not place a rear-facing child seat on the seat with a front airbag or allow a child to sit on the seat. Otherwise, death or serious injury to the child can occur when the airbag deploys.



Warning

- Passengers must not lean their heads against the doors. Otherwise they be injured by the curtain airbags (when deployed).
- Passengers must not place their feet, knees or any other part of their body over or near the airbags. This may prevent the airbags from deploying properly or may cause fractures or other injuries if the airbags deploy.
- Do not place any object above or near the front airbags, the sides of the front seats, above the canopy on the vehicle side, on the airbag covers, and in any other positions that may interfere with the airbag deployment. As these items can cause serious injury if the vehicle is involved in a violent collision that causes the airbags to deploy.
- After deployment, the airbag components may become hot. Please do not touch them with your hands. Wait for them to cool completely, and contact your local authorized service center for replacement.
- Do not attempt to refit airbag components, wiring and software, otherwise the airbag system may not work properly and cannot provide the necessary protection for the driver and passengers as well as may fail or accidentally be activated in the event of an accident, increasing the risk of injury.

Warning

- Do not modify the airbag cover or add any parts near it.



4. Safe Driving

Electronic Parking Brake (EPB)

Auto Turning On/Off EPB

- On: When the vehicle is stationary, shift into gear P, then the EPB will be automatically turned on and the EPB indicator light on the dashboard will light up.
- Off: When the vehicle is stationary on a flat road (road gradient smaller than 3%), close the door, fasten the seat belt, and shift into gear R or D, then the EPB will be automatically turned off, and the EPB switch indicator light as well as the EPB indicator light on the dashboard will go out.

When the vehicle is stationary on an uneven road (road gradient greater than 3%), close the door, fasten the seat belt, shift into gear R or D, and press the accelerator pedal hard, the EPB will be automatically turned off, and the EPB switch indicator light as well as the EPB indicator light on the dashboard will go out.

Manually Turning On/Off EPB



- On: When the vehicle is stationary, lift up the EPB switch or shift into gear P, the (P) indicator light on the dashboard will light up, indicating that the EPB is successfully on.
- Off: When the vehicle is stationary, press the brake pedal and press the EPB switch, the (P) indicator light on the dashboard will go out, indicating that the EPB is successfully off. The EPB cannot be turned off by pressing the EPB switch when the vehicle is in gear P.



Note

- The system will make a running voice when the EPB is turned on/off, which is a normal phenomenon.
- After the EPB is on, if the vehicle cannot be powered on and the EPB cannot be turned off due to a dead 12V battery, try to turn off it by jumper power connection or contact your local authorized service center.

Caution

- If the EPB cannot be turned off automatically when the gear is shifted into P after the vehicle stops or when the gear is shifted to R or D after the vehicle starts, try to turn on/off the EPB manually. If the EPB cannot be turned on/off manually, contact your local authorized service center immediately for troubleshooting.
- Do not drive the vehicle with the EPB on, otherwise the EPB may be damaged.

Dynamic Parking Brake



- If a sudden emergency such as braking failure occurs during driving, lift the EPB switch to turn on dynamic parking brake. Then the vehicle will decelerate at a certain speed until it is braked to the stationary state or the EPB switch is released.
 - ▶ The dashboard will display "Dynamic Braking".

Caution

- When ESP fails, the dynamic parking brake is applied using the EPB. As the EPB only acts on the rear wheels, it is recommended not to use the dynamic parking brake in non-emergency situations, otherwise it can easily cause an accident and shorten the life of the EPB.



4. Safe Driving

AutoHold

When you need to park your vehicle temporarily, press the brake pedal deeply after the vehicle stops, and the (A) indicator light on the dashboard will light up. At this time, you do not need to continue pressing the brake pedal as the AutoHold will automatically apply the braking to keep the vehicle stopped. When you press the accelerator pedal and start driving, the AutoHold will automatically disable the braking.



- After the vehicle is READY, tap "🚗 → XPILOT → AutoHold" on the CID to turn on/off this function.

i Note

- To trigger the AutoHold, the driver door must be closed, the seat belt is fastened and gear is in D, R or N.

! Warning

- The AutoHold cannot exceed the laws of kinematics, so please enable the parking brake according to the road conditions.



Electronic Stability Program (ESP)

ESP identifies the vehicle's driving condition (e.g. in the event of understeer, oversteer or driving wheel slipping) through the sensor, and allows targeted braking intervention or driving torque limitation to effectively reduce the risk of sideslip or drift to ensure the vehicle's driving stability.

Turning On/Off with CID



- Tap "🚗 → XPiLOT → Electronic Stability Program" on the CID to turn on/off this function.

i Note

- When the vehicle is powered on, the ESP is automatically turned on by default.
- The ESP will limit the power output when the vehicle is slipping (starting or accelerating rapidly on the snow and ice-covered road or muddy road, etc.), so the ESP should be temporarily turned off when the vehicle gets stuck in the mud. After the vehicle gets out of the mud, turn it on again.

! Warning

- ESP cannot prevent the accidents caused by dangerous driving or high-speed emergency steering.
- If the ESP fails, contact your local authorized service center for troubleshooting as soon as possible.

Traction Control System (TCS)

When the vehicle is starting or accelerating rapidly on a slippery road surface like snow and ice, the wheels will slip. At this time, the TCS will control the brake pressure and the vehicle's torque output to minimize wheel slipping.



4. Safe Driving

Anti-Lock Braking System (ABS)

ABS prevents wheel lock when you apply the maximum braking force. It can improve the steering control performance of the vehicle in case of emergency braking under most road conditions.

In case of emergency braking, the ABS continuously monitors the speed of each wheel and adjusts the brake pressure according to the lock condition.

You may sense a brake pedal vibration at this point, which indicates that the ABS is working. At this time, there is no need to panic, just drive according to road conditions.

When the ABS fails, the basic braking function still works normally, but the braking distance will increase.

Emergency Braking

In an emergency, fully step on the brake pedal and maintain steady pressure. The ABS changes the brake pressure applied to each wheel according to the available traction, preventing wheel lock and ensuring safe stopping.

Warning

- The driver shall always maintain a safe distance from the vehicle in front of him/her and be aware of the hazards while driving. Although the ABS can improve the braking distances, it can neither go beyond the laws of physics nor prevent the hazards caused by tire slipping (e.g., when there is a layer of water between the road and the tires to prevent the tires from directly contacting the road).

Electronic Brakeforce Distribution (EBD)

EBD is a part of ABS. It balances the distribution of brake force between the front and rear wheels during regular braking of the vehicle, depending on the load on the vehicle.

EBD will distribute the force generated by the braking system to the four wheels appropriately according to the adhesion condition between each wheel and the ground, so that the braking force can get the optimum efficiency, significantly shortening the braking distance and maintaining the vehicle stability while braking, so as to improve the driving safety.



Hydraulic Brake Assist (HBA)

In case of an emergency, press the brake pedal quickly and hold it, HBA will generate a higher brake pressure than normal braking, and the braking system will generate the pressure required for maximum deceleration of the vehicle in the shortest possible time, thereby obtaining the shortest braking distance.

Warning

- HBA can improve driving safety, but it cannot go beyond the laws of kinematics. Please adjust the vehicle speed according to the road conditions and traffic regulations.

Emergency Brake Alarm



- Tap " → XPIOLT → Emergency Brake Alarm" on the CID to turn on/off this function.
- When the emergency brake alarm is on and the vehicle speed is higher than 80 km/h during emergency braking, the emergency brake light will light up to remind the drivers behind you to prevent rear-end collision.



4. Safe Driving

Hill Descent Control (HDC)

HDC is a cruising feature that helps the driver go downhill at a constant speed, relieve the driver's foot fatigue from pressing the brake pedal all the way downhill.

Turning On/Off in CID



- Tap "🚗 → XPiLOT → Hill Descent Control" on the CID to turn on/off this function.
- Vehicle speed for enabling HDC: $8 < V < 38$ km/h. However, the HDC will be turned off to allow the driver to take over the vehicle if the brake is applied and the accelerator is pressed during HDC operation. When the vehicle speed exceeds 64 km/h, the HDC will be turned off completely and turn-on is prohibited.

Note

- HDC works on ramps with a gradient $\leq 50\%$.
- Conditions for enabling HDC: Speed < 34 km/h, both the braking disc temperature and the ESP system are normal.

Caution

- HDC can actively keep the vehicle descending at a constant speed, but can't work beyond the laws of kinematics. For safety reasons, the driver should apply the brakes in a timely manner according to the actual situation of the vehicle to avoid accidents caused by the rapid descent.



5. Center Information Display (CID)

Interface Introduction



1 Map

- Tap to enter the Map & Navigation App.
- The following services are provided:
 - ▶ Intelligent route planning and precise navigation (navigation / path finding / route radar...).
 - ▶ Congestion and charging station prompts.
 - ▶ Enter your destination on the interface for navigation, or wake up "Hi, XPENG" to plan your journey.
 - ▶ More scenario-based mobility experiences (upgraded continuously)

2 Spotify

- Tap to enter the Spotify interface.
- You can play, collect and search online music, and log in your Spotify account.

3 Music. Refer to Page 103.

- Tap to enter the Bluetooth Music interface.
- You can listen to music via Bluetooth connected devices and online music websites.

4 DAB+

- Tap to enter the DAB+ interface.



5. Center Information Display (CID)

5 Bluetooth Phone

- Tap to enter the Bluetooth Phone interface.
- Follow the instructions on the interface to connect, sync call logs and contacts, and use all the in-car Bluetooth functions after connecting the phone.

6 System Settings [Refer to Page 104.](#)

- Tap to enter the System Setting interface.
- On this interface, you can set and adjust the display, sound, network, upgrade, etc.

7 My Apps

- Tap to enter the My Apps interface.

8 Vehicle Control [Refer to Page 106.](#)

- Tap to enter the Vehicle Control interface.

9 Intelligent Parking Assist

- Tap to enter the Intelligent Parking Assist interface.

10 A/C control [Refer to Page 67.](#)

- Tap to enter the A/C control interface.

11 Front defrost and defog

- Tap to turn on/off the front defrosting and defogging.

12 Rear defrost & defog and exterior rear-view mirror heating

- Tap to turn on/off rear windshield defrosting & defogging and exterior rear-view mirror heating.

Note

- Features may vary depending on vehicle configuration.



5. Center Information Display (CID)

Bluetooth music



1. Bluetooth connection portal
 - The device name will be displayed when the device is successfully connected via Bluetooth.
2. Sound effect setting portal
3. Name of the song and singer information
 - When Bluetooth is not connected, here will display the Bluetooth connection entry.
4. Music Control
 - The buttons are Previous, Play/Pause, and Next from left to right.
5. Online music website portal

5



5. Center Information Display (CID)

System Settings



1 Bluetooth connection settings

When the Bluetooth is turned on, the system will automatically search for nearby Bluetooth devices and display the available devices under the lists of "My Devices" and "New Devices Available".

Select the device name for Bluetooth pairing in the device list, and confirm the pairing request on the phone to complete the Bluetooth connection.

Once the connection between the car's Bluetooth and the phone is established, phone and audio channels are automatically established. When the "Bluetooth Music" and "Bluetooth Phone" turn blue on the Bluetooth interface, it indicates that the vehicle is ready to make phone calls and play Bluetooth music.

- Bluetooth switch: Tap the switch to turn on/off Bluetooth.
- Bluetooth device list: Bluetooth device lists include two lists, "My Devices" and "New Devices Available". "My Devices" displays the device that has been connected or is connecting, while the "New Devices Available" displays the nearby available devices. You can establish new connection here.



5. Center Information Display (CID)

2 Wi-Fi settings

- Turn on the WLAN switch, then the system will automatically search for nearby Wi-Fi hotspots.
- Tap an available Wi-Fi hotspot and enter the correct password to complete the Wi-Fi connection.
- Ignore: Tap on the connected Wi-Fi, a box will pop up. Tap "Ignore", the system will ignore the Wi-Fi and will not automatically connect to this network next time.

Caution

- Some Apps may be downloaded automatically via Wi-Fi, so please pay attention to the data usage when using your phone as the hotspot.

3 Sound settings

- Media/voice/navigation volume settings: You can adjust the volume settings of each item on the CID, while the voice control only works for "media volume". For example, if you say "Hi, XPENG, turn the volume up to the maximum", only the media volume is adjusted.
- Sound effect settings: Tap to enter the Sound Effect Settings interface.
- Smart sound control: You can turn on/off the smart sound control on the CID only.

4 Screen display settings

- Brightness settings: Manually adjust the CID and dashboard brightness by setting the brightness bar on the CID. The auto adjustment is turned off during manual adjustment.
- Theme setting: Day/night mode. After setting the auto mode, day/night mode will be switched intelligently according to the surrounding environment brightness.
- Font settings: Switch between delicate/clear mode.
- Time format: Select between "24-HOUR" and "12-HOUR".

5 Privacy

- Maps service: Tap the switch to turn on/off this service.
- Voice assist service: Tap the switch to turn on/off this service.
- View Privacy Policy.
- Reset to defaults.

5. Center Information Display (CID)



Vehicle Settings



Once the vehicle is powered on, tap  to enter the "Vehicle Control" interface.

1 Quick Controls

- Tap to enter the "Quick Controls" interface. Then you can set the vehicle lights, rear-view mirrors, seats, wipers. For detailed operations, refer to [the accordingly subsystem function description](#).

2 Lights

Tap to enter the "Lights" interface. For detailed operations, refer to [the accordingly subsystem function description](#).

3 Driving

- Tap to enter the "Driving" interface. Then you can set the driving mode, energy regeneration mode, and steering wheel. For detailed operations, refer to [the accordingly subsystem function description](#).

4 Vehicle Settings

- Tap to enter the "Vehicle Settings" interface. Then you can set the wiper INT, door lock, instrument and custom X button. For detailed operations, refer to [the accordingly subsystem function description](#).

5 XPiLOT

- Tap to enter the "XPiLOT" interface. For detailed operations, refer to [the accordingly subsystem function description](#).

6 Status

- Tap to enter the "Status" interface to check the tire pressure, mileage and other status information.



5. Center Information Display (CID)

System Update

The vehicle supports updates via the CID to provide your vehicle with the latest functions, and XPENG suggests you to install the new software version available as soon as possible.

- Any data consumption generated by the system update will be borne by XPENG, so that users will not pay the data cost arising from the system update.
- When the vehicle is connected to the network, it will automatically receive the update package. Please make sure the vehicle is connected to the Internet.
- Please contact your local authorized service center for any additional questions.

Entering the Update Interface

- Tap the  button on the status bar to enter the "System Update" interface.

No New Version Available



- It will indicate that it is the latest version when no new version is available. Tap "LEARN MORE" to view the current software instruction of your vehicle.



5. Center Information Display (CID)

New Version Available

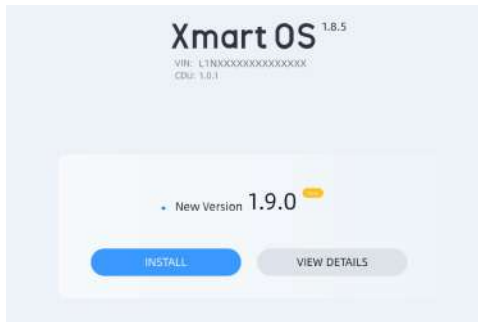

- The message box will prompt a new version when a new version is available for update.
- Tap "VIEW DETAILS" to view the update instructions when a new version is available on the "System Update" interface.

Update Operation

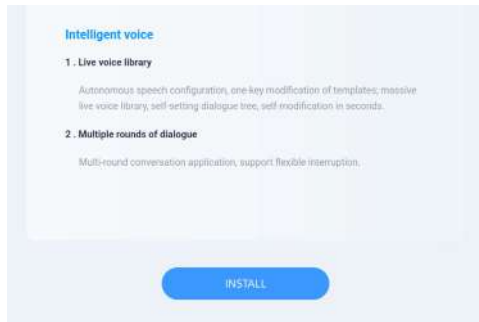

- When a new software version can be upgraded, tap "VIEW Upgrade to New Version" to enter the version description interface, and tap "Upgrade to New Version" to enter the upgrade scheduling interface.



5. Center Information Display (CID)



- Select the update time, tap "Set for this time", and the system will be updated when it reaches the set time and the vehicle is locked.

Precautions for Update

- Please make sure the vehicle is parked in a safe area and reserve sufficient time for the update to complete as the vehicle cannot be used during the update process.
- The vehicle cannot be charged during the update process. Please arrange the update time reasonably.
- If the update fails, do not use the vehicle. Tap "Retry" for update. Please contact your local authorized service center after multiple failed attempts.



6. XPENG APP

Download and Use

The Xpeng App is the smart interconnected solution for vehicle usage scenarios. Here, you can not only control your vehicle anytime and anywhere, enjoy the charging services and owner services that save money and trouble, but also get the firsthand official information and activities, participate in community interaction, making your car life more relaxed and fun.

Download the App on Your Phone

You can get the Xpeng App from the following ways:

1. iOS: Open the App Store and search “Xpeng” to download and install.
2. Android: Open Google Play and search for “Xpeng” to download and install.
3. Visit the official website of Xpeng Motors (<https://heypeng.com/>) to get the installation package.

Account Registration and Login

When a new user registers, the system will automatically create an Xpeng account with their mobile phone number. You can register or log in by choosing one of the following methods:

1. Email Registration: With an available email address, you can register easily with a verification code.
2. Password Login: Support using email or phone number with a password for quick login.
3. Linked Accounts One Click Registration/Login: With a Google or other linked account, you can register or log in with only one click.



Account Modification and Cancellation

- If you want to change the mobile phone number bound to your Xpeng account, you can go to the “My-Settings-Change Phone” in the app to change it.
- If you wish to cancel your Xpeng account, please call our customer service hotline at +47-80017060. Upon cancellation of your account, we will stop providing you with products or services and delete your personal information as required by law.

Car Control with Xpeng App

The App’s car controls include remote control and Bluetooth control. The software interface may vary due to iterative optimization of the version, subject to the actual display of the device.

Remote Vehicle Control

The remote control mode supports real-time viewing of the vehicle’s current mileage range and other functions including but not limited to: unlocking/locking the doors (not starting the vehicle), window ventilation, switching the air conditioner and adjusting the temperature, turning the air conditioner rapid mode on or off, high temperature sterilization, air conditioner cleaning, flashing lights and horn.



6. XPENG APP

1. Vehicle status

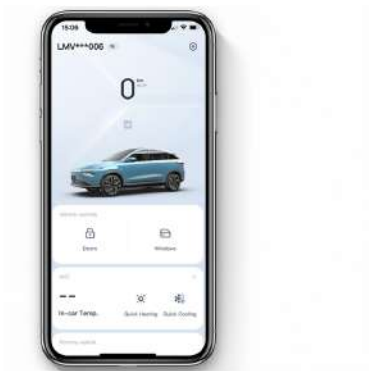

- Window control: Click the “Window” button to use the one-touch ventilation function to ventilate the interior and exterior of the vehicle, or close the windows.

- Door locking control: Click the “Lock” button to lock the doors.
- Door unlocking control: Click the “Unlock” button to unlock the doors. (Please note: the vehicle cannot be started when the doors are only unlocked remotely using the 4G network)



1. AC control



In the remote vehicle control mode, after clicking the “turn on A/C” button and turning on any mode, you can check the temperature of the vehicle in real time or select other functions, including adjusting the temperature, quick heating, quick cooling, scheduled turning on, etc.

- Quick mode: including “Quick Heating” and “Quick Cooling”, helping you to turn on the maximum heating/cooling mode of the air conditioner with one click, making smart travel more comfortable.

- Scheduled turning on: After setting the timer remotely, the air conditioner will turn on at the specified time; Scheduled turning on also supports setting the frequency of the timer.

2. Find my vehicle

The location of the vehicle can be confirmed by sounding the horn and flashing the lights.

- Flashing lights: When the button is clicked, the vehicle flashes its lights.
- Honk: When the button is clicked, the vehicle honks.



7. XPiLOT Driving

Radars

XPENG G3i is equipped with two types of radars, i.e., ultrasonic radars and millimeter-wave radars.

- The ultrasonic sensors detect information for the intelligent parking assist system.
- Millimeter-wave detects information for the XPilot Safety and the XPilot Driving.

The radars are only used for detecting objects around the vehicle to provide detection information for relevant systems.

Mounting Positions of Radars



Radar Maintenance

- To ensure radars work properly, they must be kept clean without ice, snow, water, dust, and other foreign objects attached.
- When a foreign object is attached to the radar surface, wipe it with a soft cloth or clean it with low-pressure water. Do not flush the radars with a high-pressure water gun, and do not clean them with abrasive or sharp objects.



Caution

- To avoid affecting the radars' performance, it is strictly forbidden to paint the body, bumpers or embed surrounds.
- If any radar is damaged, please contact your local authorized service center for replacement or repair.



Warning

- Radars cannot work properly in all driving situations or traffic, weather and road conditions, so please drive carefully and always pay attention to driving safety.
- It is not allowed to install license plate frame or other objects around the front and rear license plates in order to minimize interference with radars and cameras.
- The license plates should be maintained and serviced regularly to prevent warping and deformation that may cause the radars and cameras to work improperly. If any radar or camera works improperly, please contact your authorized service center as soon as possible.

Restrictions and Errors

When a radar is not working properly, functions based on the radar's detection information may work improperly. Meanwhile, radars have limited detection ranges and cannot detect targets beyond the ranges.

The radar performance may be affected by the poor ambient condition or the abnormal state of the target detected.

The following conditions may cause radars' detection failure, delay or error:

- Poor weather conditions (e.g. heavy rain, snow, and dense fog).
- The radar surface is attached with foreign objects such as ice, snow, water, and dust.
- The objects detected by the radar is attached with substance that absorbs sound waves, such as snowflakes, foam, and cotton objects, or there are objects that may cause false reflection of sound waves near the vehicle.
- Vehicle bumping or shaking caused by uneven roads or other factors.
- Metal objects hanging from high places or by the roadside.
- The objects detected are too small.
- There is interference from acoustic sound sources with the same frequency around.

The above examples, warnings and constraints do not cover all the conditions that may affect the proper operation of the radars.



7. XPiLOT Driving

Cameras

This vehicle is equipped with 2 types of cameras: AVM cameras (4 cameras, front, rear, left, and right ones), and in-vehicle front view camera.

- The in-car front view camera detects information for the XPilot Safety and the XPilot Driving.
- AVM cameras provide detection information for the XPilot Safety and the intelligent parking assist system.

These cameras perform target recognition in visual form, providing recognition information for relevant functions after identifying the target within visual range.

Mounting Positions of Cameras



Camera Maintenance

- To ensure cameras work properly, they must be kept clean without ice, snow, water, dust, and other foreign objects attached.
- To ensure the camera works properly, keep the windshield in front of the camera clean, and there must be no objects between the camera and the windshield.
- When a foreign object is attached to the camera surface, wipe it with a soft cloth or clean it with water (low water pressure). Do not flush the cameras with a high-pressure water gun, and do not clean them with abrasive or sharp objects.

Warning

- If any camera is damaged, please contact your local authorized service center for replacement or repair.
- Cameras cannot work properly in all driving situations or traffic, weather and road conditions, so please drive carefully and always pay attention to driving safety.



Restrictions and Errors

When a camera is not working properly, functions based on the camera's detection information may work improperly. Meanwhile, cameras have limited detection ranges and cannot detect targets beyond the ranges.

The camera performance may be affected by the poor ambient condition, while obscuring may disable the camera.

The following conditions may cause cameras' detection failure, delay or error:

- Poor lighting conditions or poor visibility (due to heavy rain, heavy snow, dense fog, etc.)
- Weather conditions (heavy rain, snow, fog, extremely hot or cold temperatures) interfere with the camera operation.
- The camera is facing the direction of a light source, or the illumination intensity is insufficient.
- The camera surface is attached with foreign objects such as ice, snow, water, and dust.
- Dramatic changes in light (e.g. entering and leaving a tunnel).
- Vehicle bumping or shaking caused by uneven roads.
- The camera view is obscured.

- Deformed or damaged windshields result in changes of camera positions or angles, and changes in the windshield color may also affect the cameras.

The above examples, warnings and constraints do not cover all the conditions that may affect the proper operation of cameras.



7. XPILOT Driving

Xpilot Parking System

The parking system assists the driver in observing and sensing the surroundings during low-speed driving or parking, providing visual and audible warnings or alerts to the driver when there are obstacles that impede driving or parking.

The Xpilot parking system can assist the driver in:

- Detecting obstacles around the vehicle.
- Providing vehicle backup footage or panoramic image.
- Providing the distance between the vehicle and the obstacle.

XPilot parking related information:

- Parking radars (front, rear, and side) [Refer to Page 119](#).
- Around View Monitor (AVM). [Refer to Page 122](#).



Warning

- The parking system only provides parking and low-speed driving assist for the driver and cannot replace the driver's control of the vehicle. It has some degree of limitation, please drive carefully and park safely.
- The parking system does not work properly in all weather, road and traffic conditions.



Parking Radars

Parking radars include the front, rear, and side ones.

Parking radars can detect obstacles ahead when the vehicle is moving forward at a low speed and warn the driver when the vehicle is approaching the obstacle to assist in avoiding the risk of collision.

When the vehicle is backing up, the parking radars will detect the surrounding of the vehicle, no matter the obstacle is in front or behind. As long as the obstacle is close to the vehicle, the parking radars will send warning messages to the driver to ensure the safety of backing up.

Warning Messages Include:

1. Visual warnings

As the distance between this vehicle and an obstacle decreases, the warnings are displayed as follows:

Dashboard display





7. XPILOT Driving

CID display

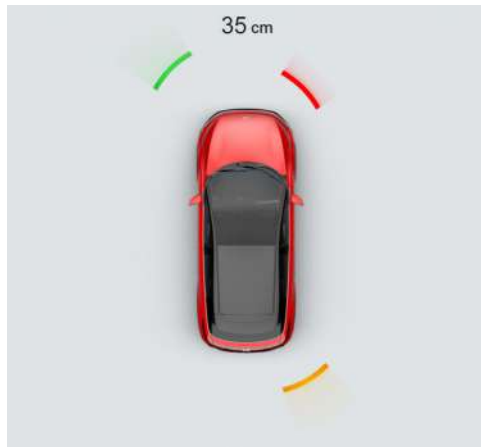

- Green area indicates that the vehicle is close to an obstacle.
- Yellow area indicates the risk of collision.
- Red area indicates an imminent collision.

2. Audible warning: buzzer alert.

As the distance between the vehicle and an obstacle decreases, the frequency of the alert sound will gradually increase and continue when the vehicle is about to collide with the obstacle.

Mounting Positions of Parking Radars



- When the gear is shifted into D or N, ultrasonic sensors 1, 2, 3, 4, 9, 10 will activate to detect obstacles in front of the vehicle.
- When the gear is shifted into R, all ultrasonic sensors will be activated to detect obstacles around the vehicle.



Warning

- During the operation of the intelligent parking assist system, the audible warning from the parking radars will be diminished, but there will still be necessary warning messages. The driver should pay attention to the warnings issued by the parking radars and apply the brake if necessary.
- The parking radars will turn off the warning when the vehicle is going too fast.
- The parking radars only send warning messages when detecting an obstacle, so they may not send any warning messages or send delayed/unnecessary warning messages. Solely relying on the parking radars to alert the risk of a potential collision may result in serious personal injury or death.
- Do not wait for the warning messages from the parking radars. You need to brake as appropriate to ensure the driving safety.

Restrictions and Errors:

Though the parking radars can detect various obstacles such as vehicles, bikes or pedestrians, they may send unnecessary, untimely or invalid warnings or missed warnings for any of the following conditions:

- Radars are restricted (For radar restrictions, [Refer to Page 115.](#))
- The warning from the parking radars may be delayed when the vehicle is approaching an obstacle at a very fast speed.
- The parking radars will still alert when the obstacle is too soft (such as a drawn-up weeds) to damage the vehicle.



7. XPILOT Driving

Around View Monitor (AVM)

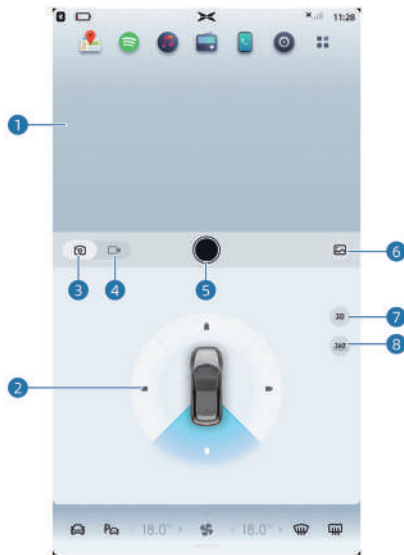

- Tap to enter the My Apps interface, and then tap to enter the Camera interface:

- 1 Image display area: displays the image acquired by the camera.
- 2 View angle switch button: Tap front, back, left, right to switch camera view, and the image display area will display the corresponding image according to the camera selected.
- 3 Photo mode button: Tap to select the photo mode.
- 4 Photo mode button: Tap to select the photo mode.
- 5 Photo/video:
 - Tap to take a photo if in the photo mode.
 - Tap to start or end recording if in the video mode.
- 6 Album: Tap to enter the album to view the photos or videos taken by the AVM parking cameras or the roof camera.
- 7 2D/3D view switch button: Tap to switch 2D/3D view mode.
- 8 Transparent chassis: Tap the 360 icon, and the CID will display the transparent chassis view to allow visualizing the environment around the vehicle.



Forward Collision Mitigation

Forward Collision Migration includes two active safety assistance features, Forward Collision Warning (FCW) and Automatic Emergency Braking (AEB), which prevent vehicle collisions or reduce the speed of a vehicle collision and are used to improve the safety of drivers and passengers.

In the event of a forward collision risk, FCW will warn the driver visually, acoustically, and tactilely until the driver applies the brakes within a reasonable time or the risk of collision has been removed. Otherwise, the vehicle will assist in applying the brakes.

Forward Collision Mitigation may apply short and sharp braking for different collision risks, which is not a normal driving style for most drivers and therefore causes them to feel uncomfortable.

If the risk of a collision increases further, the Advanced Emergency Braking (AEB) will intervene to apply the brakes, regardless of whether the driver has taken the brakes or not.

After Forward Collision Mitigation successfully avoids a collision, the vehicle will remain stationary for a short period of time and the driver should take proactive action as soon as possible.

Warning Messages:

1. Text warning: FCW/EBA has been enabled.
2. Visual warning in case of emergency.



3. Audible warning: dashboard speaker warning.
4. Tactile warning: Seat belt tightened.

7. XPILOT Driving



Turning On/Off with CID



- After the vehicle is Ready, the Forward Collision Migration is on by default. Tap "🚗 → XPILOT → Forward Collision Mitigation" on the CID to turn on/off this function.
- When the function is turned off, both FCW and AEB will be turned off at the same time.
- When the Forward Collision Migration functions fail, the dashboard's XPILOT system fault indicator light will come on. Please contact your local authorized service center.

Warning

- Before using the Forward Collision Mitigation, please refer to this section for guidelines and limitations on the use of the feature.
- Forward Collision Mitigation is an assistance function that does not work in all driving situations, traffic, weather, and road conditions and is not a substitute for focused driving and accurate judgment. The driver should bear all the responsibility for driving safety. Always observe road conditions during driving and never solely rely on Forward Collision Migration to warn of or avoid a possible collision. Many factors can degrade or affect the performance of the Forward Collision Mitigation, resulting in unnecessary, ineffective, or inaccurate warnings, brake interventions, or omissions. Solely relying on the Forward Collision Mitigation to warn of or avoid collisions may result in serious personal injury or death.
- As the monitoring scope of the cameras and radar sensors related to the Forward Collision Migration is limited, road conditions and weather conditions may adversely affect the area that can be monitored by Forward Collision Migration, so be sure to drive with caution.
- When the vehicle gives visual, audible and tactile warnings, it is your responsibility to take immediate action to avoid putting the vehicle in further danger and never solely rely on the intervention of AEB.



Warning

- AEB is not designed to prevent collisions. It is only able to minimize the impact of a frontal collision by trying to reduce the driving speed. Solely relying on the AEB to avoid a collision may result in serious personal injury or death.
- Forward Collision Migration may issue a warning or take braking in situations where there is no risk of collision. Stay focused and keep your eyes on the area in front of your vehicle at all times to anticipate if you need to take any action.
- It is strongly recommended that the Forward Collision Migration feature not be turned off. Otherwise the vehicle will not be able to warn or assist in applying the brakes when a collision is likely to occur.
- Forward Collision Migration only applies to the prevention of frontal collisions and will not work when the vehicle is in gear R.
- If traffic conditions or external influences prevent the cameras and radars from correctly detecting other road users such as pedestrians, cyclists, and vehicles, warning and braking intervention may be delayed or not applied at all.

Warning

- For stationary or slow-moving vehicles and pedestrians, FCW operates only when the driving speed is between 30 km/h and 85 km/h. For moving targets, FCW operates only when the driving speed is between 30 km/h and 150 km/h.
- For stationary or slow-moving vehicles and pedestrians, AEB operates only when the driving speed is between 5 km/h and 50 km/h. For moving targets, AEB operates only when the driving speed is between 5 km/h and 150 km/h.
- During AEB intervention of the vehicle braking, if the driver depresses the accelerator pedal, the AEB may be interrupted.

Restrictions and Errors:

FCW cannot always detect other road users such as vehicles, cyclists or pedestrians. Unnecessary, untimely, invalid or missed warnings can occur for any of the following conditions:

- The vehicle is driven on a road with large curves or in poor road conditions.
- When there are other vehicles suddenly moving fast or to the front of the vehicle, the Forward Collision Migration cannot issue warning/apply brake in time.



7. XPILOT Driving

- Poor lighting conditions or poor visibility (due to heavy rain, heavy snow, dense fog, etc.)
- Strong light (such as oncoming headlight or direct sunlight) obstructs the camera's view.
- Windshield blocks the view of the camera (water spray, dust or sticker blocking, etc.)
- Radars are restricted (For radar restrictions, [Refer to Page 115.](#))
- Cameras are restricted (For camera restrictions, [Refer to Page 117.](#))
- When the vehicle is driving beyond a certain speed, AEB cannot completely avoid a collision after it detects a pedestrian.
- AEB does not work on vehicles in reverse.

The above warnings and restrictions do not cover all the situations that may prevent the proper operation of the Forward Collision Mitigation. These functions may also fail to deliver the desired effect for many other reasons. It is the driver's responsibility to remain alert and aware of the area next to the vehicle in order to anticipate whether early action is required to avoid a collision.



Lane Departure Assist

Lane Departure Assist includes two active safety assistance features, Lane Departure Warning (LDW) and Lane Keeping Assist (LKA), designed to help drivers in similar scenarios such as highways and expressways, when the vehicle unconsciously drifts out of its lane, to provide early warning alerts or assist in correcting the vehicle's position in an attempt to keep the vehicle in its current lane, thereby improving the safety of the driver and passengers.

Lane Departure Warning (LDW)

LDW is enabled when the vehicle speed is greater than or equal to 60 km/h and the road markings are clearly visible. LDW will warn the driver through visual, audible and tactile warnings when the vehicle may drift out of the lane unconsciously until the driver corrects the vehicle position within a reasonable time, LDW is an active alert function and does not correct the vehicle back into the lane, please correct the vehicle position in time when the LDW warning is issued.

Lane Keeping Assist (LKA)

When the deviation continues, the LKA will intervene to correct the deviation in an attempt to keep the vehicle within the lane. Although LKA is an active assist feature, it is not always active and the system will fail to complete a deviation correction when the degree of lane departure exceeds the correction capability of LKA. So do not solely rely on the LKA capability to correct for lane departures. The driver must always maintain control of the vehicle.

Warning Messages:



1. Visual warning: The lane line in the deviating direction will be displayed in red or blue on the dashboard.
2. Audible warning: speaker warning.
3. Tactile warning: seat belt vibration (applied in LDW).

7. XPILOT Driving



Turning On/Off with CID



- After the vehicle is Ready, the Lane Departure Assist switch status defaults to the last operating status. Tap "🚗 → XPILOT → Lane Departure Assist" to switch among "OFF", "Warning", or "Correct".
- Selecting the "OFF" option means that the Lane Departure Assist is turned off, and the LDW and LKA are both turned off.
- Selecting the "Warning" option means that the LDW is turned on, but the LKA is still turned off.
- Selecting the "Correct" means that the Lane Keeping Assist (LKA) is turned on.
- If the Lane Departure Assist is malfunctioned and the Lane Departure Assist switch is off, there will be a prompt that "Function malfunctioning, unable to enable" once you tap the "Warning" or "Correct". Please contact your local authorized service center as soon as possible.

Warning

- Lane Departure Assist is only an assistance feature, and not a substitute for direct visual inspection. Do not rely on warning of accidental departure from lane boundaries. It is the driver's responsibility to remain alert, watch the lane of travel and always be aware of other traffic participants, otherwise serious personal injury or death may occur.
- When the vehicle gives visual, audible and tactile warnings, it is your responsibility to take immediate action to avoid putting the vehicle in further danger and never solely rely on the intervention of LKA.
- Lane Departure Assist will not warn or intervene when the turn signal indicator is on or when the driver has obvious steering intentions (e.g., turning the steering wheel quickly, braking, accelerating with hard press, and turning on the hazard warning lights).
- The Lane Departure Assist doesn't work in all driving situations, traffic, weather, and road conditions. The driver shall always be ultimately responsible for ensuring safe driving and obeying the applicable laws and road traffic rules.



Warning

- Lane Departure Assist is an assistance function that does not work in all driving situations, traffic, weather, and road conditions and is not a substitute for focused driving and accurate judgment. The driver should bear all the responsibility for driving safety. Always observe road conditions during driving and never solely rely on Lane Departure Assist to warn of or avoid a possible collision. Many factors can degrade or affect the performance of the Lane Departure Assist, resulting in unnecessary, ineffective, or inaccurate warnings, brake interventions, or omissions. Solely relying on the Lane Departure Assist to warn of and avoid a collision may result in serious personal injury or death.

Restrictions and Errors:

Lane Departure Assist cannot clearly detect the lane lines at all times. You may receive a useless or invalid warning, or the Lane Departure Assist cannot effectively correct the departure, when:

- Poor lighting conditions or poor visibility (due to heavy rain, heavy snow, dense fog, etc.)
- Strong light (such as oncoming headlight or direct sunlight) obstructs the camera's view.
- Preceding vehicle blocks the view of the camera.

- Windshield blocks the view of the camera (water spray, dust or sticker blocking, etc.)
- Excessive wear of lane lines, overlapping old and new marker lines, temporary adjustments or rapid changes due to road construction (e.g., lane bifurcating, crossings or merger).
- Objects or landscape features project on lane, forming large shadows.
- Significant lateral airflow or strong winds can affect the performance of Lane Departure Assist which is not suitable for such weather conditions.

The Lane Departure Assist may miss warnings or intervene the departure, or give false warnings and intervene the departure incorrectly when:

- Cameras are restricted (For camera restrictions, [Refer to Page 117](#)).
- Weather conditions (heavy rain, snow, fog, extremely hot or cold temperatures) interfere with the camera operation.

The above warnings and restrictions do not cover all the situations that may interfere with the Lane Departure Assist. These functions may also fail to deliver the desired effect for many other reasons. It is the driver's responsibility to remain alert and aware of the area next to the vehicle in order to anticipate whether early action is required to avoid a collision.



7. XPILOT Driving

Emergency Lane Keeping (ELK)

ELK actively and briefly controls the steering wheel to avoid or mitigate injury from a side collision when the vehicle has a tendency to drift out of its lane or has already drifted out of its lane, thereby potentially triggering the risk of a side collision.

In some cases, where there is a potential risk of a side collision even if the vehicle has not drifted out of its lane, ELK actively and briefly controls the steering wheel to avoid or mitigate injury from a side collision.

ELK is enabled when the vehicle speed is greater than or equal to 60km/h and the road markings are clearly visible. In the event of a potential side collision hazard, ELK will warn the driver visually, audibly and tactilely, while actively and briefly controlling the steering wheel to avoid or mitigate injuries from a side collision. ELK is an active safety assistance feature and does not replace the driver for all lateral hazards.

Warning Messages:



1. Visual warning: The lane line in the deviating direction will be displayed in red or blue on the dashboard.
2. Audible warning: speaker warning.
3. Tactile warning: seat belt vibration.



Turning On/Off with CID



- After the vehicle is Ready, the ELK is off by default. Tap "🚗 → XPILOT → Emergency Lane Keeping" on the CID to turn on/off this function.

Warning

- ELK is an assistance function that does not work in all driving situations, traffic, weather, and road conditions and is not a substitute for focused driving and accurate judgment. The driver should bear all the responsibility for driving safety. Always observe road conditions during driving and never solely rely on ELK to warn of or avoid a possible collision. Many factors can degrade or affect the performance of the ELK, resulting in unnecessary, ineffective, or inaccurate warnings, brake interventions, or omissions. Solely relying on the ELK to warn of and avoid a collision may result in serious personal injury or death.
- When the vehicle gives visual, audible and tactile warnings, it is your responsibility to take immediate action to avoid putting the vehicle in further danger and never solely rely on the intervention of ELK.

Lane Departure Assist restrictions and errors also apply to ELK. Please refer to Lane Departure Assist Restrictions and Errors [Refer to Page 129](#).



7. XPILOT Driving

Blind Spot Security

Blind Spot Security contains two active safety assistance functions, i.e., Blind Spot Detection (BSD) and Lane Change Alert (LCA), which are designed to warn the driver about another vehicle diagonally behind and to the side of the vehicle, thus providing assistance in multi-lane co-directional traffic conditions.

BSD provides warnings to the driver about vehicles in the blind spot, while LCA provides warnings to the driver about fast approaching vehicles in the immediate left and right lanes.

Schematic of Detection Areas

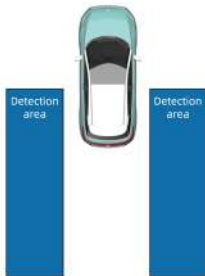

Warning Messages



When Blind Spot Security is in the warning state, the driver shall avoid making lane changes, and if the driver turns on the turn signal indicator on the warning side at this time, the blind zone warning light of exterior rear-view mirror on that side will flash to send warning signal.



Turning On/Off with CID



- When the vehicle is Ready, the Blind Spot Security switch status defaults to the last operating status. Tap "  → XPILLOT → Blind Spot Security" on the CID to turn on/off this function.
- If the Blind Spot Security fails and the switch is displayed in gray and inoperable, please contact your local authorized service center.

Warning

- In the case of a sharp turn, the Blind Spot Security will not work.
- The Blind Spot Security does not work when reversing.
- Blind Spot Security is a driving assist feature and does not work in all situations.

Warning

- Blind Spot Security is not a substitute for safe driving and the functions of interior and exterior rear-view mirrors.
- Once the Blind Spot Security is enabled, it does not mean that the driver can do nothing and be relax. It is always the driver's responsibility to change lanes in a safe manner.

Restrictions and Errors:

The Blind Spot Security does not always work in all situations. Unnecessary, untimely, invalid or missed warnings can occur for any of the following conditions:

- Radars are restricted (For radar restrictions, [Refer to Page 115.](#))
- The presence of bulky, moving metal objects at the blind spot.

The above warnings and restrictions do not cover all situations that may interfere with the Blind Spot Security. There are varieties of factors that can lead to the failure of Blind Spot Security. In order to avoid collisions, the driver needs to remain alert during driving and always keep an eye on the road, so as to change lanes when it is safe to do so.



7. XPILOT Driving

Speed Assist System (SAS)

Speed Assist System (SAS) includes two active safety assistance features, Speed Limit Information Function (SLF) and Speed Limit Assist (SLA), designed to alert the driver to current road speed limit information or to assist the driver in adjusting the cruise speed.

When SAS is unable to determine the road speed limit (for example, there is no speed limit sign and vehicle location information at the current location, or the camera does not recognize the speed limit sign), the dashboard will not display the speed limit sign or speeding alerts.

Speed Information Function (SLF)

Within the visual range of the vision sensors ahead, the system can display the recognized speed limit information on the dashboard, and visually warn the driver when the speed exceeds the speed limit. The system does not actively adjust the speed at this point and the driver should actively control the speed.

Speed Limit Assist (SLA)

When the Adaptive Cruise Control (ACC) function is enabled, when the SLA switch is on, if the system recognizes that the cruise speed exceeds the speed limit requirement, it will actively prompt the driver to confirm whether the speed needs to be adjusted, and after the driver confirms, the system will assist the driver in adjusting the cruise speed.

Speed Limit Warning (Speeding Warning)



- When the SAS determines the road has speed limit, the dashboard will display the speed limit value.
- When the driving speed exceeds the speed limit, the speed limit value on the dashboard will flash to remind the driver of speeding.



Turning On/Off with CID

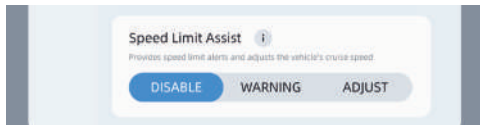

- After the vehicle is Ready, the SAS switch status defaults to the last operating status. Tap "🚗" → XPILOT → Speed Limit Assist" on the CID to switch among "DISABLE", "WARNING" or "ADJUST".
- Selecting the "DISABLE" option means that the SAS is turned off, and the SLIF and SLA are both turned off.
- Selecting the "WARNING" option means that the SLIF is turned on, but the SLA is still turned off.
- If the SAS fails and the SAS switch is "DISABLE" by default and inoperable, please contact your local authorized service center.

Warning

- Never solely rely on SAS to determine the appropriate speed limit or driving speed; you should always drive within a safe speed range, depending on traffic and road conditions.
- SLIF is designed to only prompt speed limit information and speeding warning and does not actively intervene and adjust the speed of the vehicle. The driver needs to adjust the speed of the vehicle according to the road speed limit requirements.
- SLA is based on sensor-perceived speed limit signs to enforce the assisted speed limit. Since the sensors do not always correctly identify speed limit signs, do not excessively rely on SLA to adjust the cruise speed. It is the driver's responsibility to always control the vehicle at a reasonable speed.
- The cameras may misidentify the current road speed limit and make an incorrect display on the dashboard and make a speed limit request, so the driver is required to maintain constant attention and control of the vehicle.



7. XPILOT Driving

Restrictions and Errors:

SAS may not be fully functional or may provide inaccurate information in the following situations:

- Cameras are restricted (For camera restrictions, [Refer to Page 117](#)).
- Recent changes in road or speed limits, such as construction, controls, etc.
- Speed limit signs are in poor condition: broken, faded, blurred or not placed or set as required.

The above warnings and restrictions do not cover all of the conditions that may affect Speed Limit Assist. There are a variety of factors that can cause traffic sign recognition to fail to provide information or provide incorrect information, and drivers need to stay aware of road conditions.



Rear Cross Traffic Alert (RCTA)

RCTA is a driver assistance feature that is used to warn the driver of oncoming traffic on either side when reversing.

Schematic of Detection Areas



The RCTA is a supplement to the Blind Spot Security and is primarily used to detect vehicles. Under favorable conditions, smaller objects, such as riders, can also be detected.

Warning Message



RCTA is enabled only when reversing. If the vehicle detects an object approaching from the side of behind, as with the Blind Spot Security at blind spot, the blind spot warning light on the exterior rear-view mirror on the warning side will flash, while the CID will emit a warning sound.



7. XPILOT Driving

Turning On/Off with CID



- After the vehicle is Ready, the RCTA switch status defaults to the last operating status. Tap "🚗 → XPILOT → Rear Cross Traffic Alert" on the CID to turn on/off this function.
- If the RCTA function fails and the RCTA switch is displayed in gray and inoperable, please contact your local authorized service center.

Warning

- RCTA is a driving assist feature and does not work in all situations.
- RCTA is not a substitute for safe driving and the functions of interior and exterior rear-view mirrors.
- The use of RCTA in no way means that the driver can do nothing and be relax. It is always the driver's responsibility to reverse in a safe manner.

Restrictions and Errors:

The RCTA does not always work in all situations. Unnecessary, untimely, invalid or missed warnings can occur for any of the following conditions:

- Radars are restricted (For radar restrictions, [Refer to Page 115.](#))
- The presence of bulky, moving metal objects at the blind spot.
- The objects detected move too fast.

The above warnings and restrictions do not cover all situations that may interfere with the RCTA. There are a number of factors that can cause failure of RCTA. To avoid a collision, drivers need to be alert when driving vehicles and always keep an eye on the road so that they can reverse when it is safe.



Door Open Warning (DOW)

When the vehicle is stationary, the Door Open Warning (DOW) can detect targets such as vehicles, riders or pedestrians approaching the vehicle from the rear through the side and rear sensors. When the DOW detects a target approaching and the driver or the passenger opens the door, it will issue a warning alert, aiming to alert the driver and the passenger to avoid the danger of scraping with the target when opening the door at this time.

Schematic Illustration of Detection Area



Warning Message



When a target approaches the stationary vehicle, the DOW will illuminate the warning indicator, at which point the driver or the passenger should avoid opening the door and confirm that it is safe to open the door first. If the driver or the passenger opens the door on the warning side at this time, the warning indicator will flash, accompanied by a warning sound, to alert the driver or the passenger to be careful and be safe.

7. XPILOT Driving



Turning On/Off with CID



- After the vehicle is in Ready mode, the DOW switch status defaults to the last operating status. Tap "🚗 → XPILOT → Door Open Warning" on the CID to turn on/off this function.
- If the DOW fails and the DOW switch is displayed in gray and inoperable, please contact your local authorized service center.

Warning

- The DOW is only active when this vehicle is stationary, it will not work when the vehicle is moving.
- Even when this vehicle is stationary, the DOW does not work in all situations and cannot replace the visual observation of the driver and passengers, as well as the role of the interior and exterior rear-view mirrors, so do not rely excessively on the DOW.
- The DOW aims to remind the driver and passengers to pay attention to the safety of the opening environment when opening the door, limited by the performance of the sensor and the complexity of the traffic environment, there is a possibility of unnecessary warning or no warning, so actively observe the opening environment before getting out of the car is the most effective measure and responsibility of the driver and passengers to ensure personal safety.



Restrictions and Errors

Door Open Warning (DOW) does not always work in all situations. Unnecessary, untimely, invalid, or missed warnings can occur for any of the following conditions:

- Radars are restricted (For radar restrictions, [Refer to Page 115.](#)).
- The presence of bulky, moving metal objects in the detection area.
- Targets are small or static.
- The target is going too fast or has a turning behavior, e.g., the target vehicle changes lanes to directly behind the vehicle, or another vehicle suddenly changes lanes to appear in the detection area directly behind the vehicle.
- There are other vehicles and riders directly behind the vehicle.
- The vehicle stops in locations around corners or next to walls.

The above warnings and restrictions do not cover all situations that may interfere with the DOW. There are many factors that can cause the DOW to malfunction. To avoid the risk of scratching when opening the door, please remember to observe whether the door opening environment is safe and suitable.



7. XPILOT Driving

Intelligent Parking Assist

Please perform intelligent parking assist as per the following steps to park the vehicle into the designated parking space.



1. Drive slowly at a speed lower than 24 km/h, and observe the dashboard until a parking space icon is displayed on the dashboard.

i Note

- Only when an appropriate parking space is found, and the vehicle position and the surroundings meet the intelligent parking assist system requirements will the parking icon show up.
- During the search for a parking space, please keep your vehicle within a 1-2 m lateral distance from the parking space.

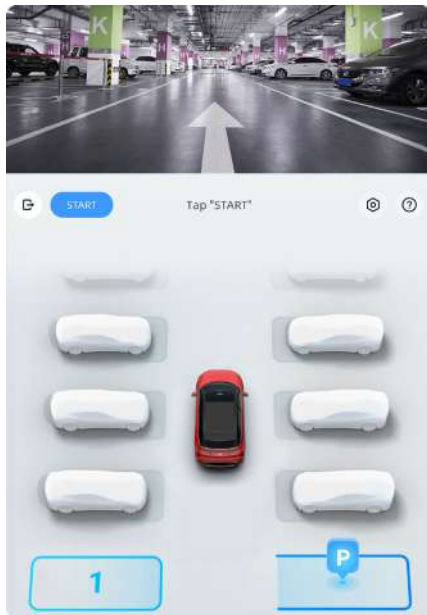



2. Stop the vehicle, keep the status of braking, check and confirm whether the parking space is appropriate and safe. If the parking space is appropriate for parking, shift to gear R, and the intelligent parking assist interface will be displayed on the CID at this time.
3. Tap the "Start" button on the Intelligent Parking Assist interface, the vehicle will start to enter the parking space. The driver needs to keep observing the surroundings to make sure the intelligent parking assist process is safe.
4. "Intelligent Parking Assist Completed" will be displayed on the CID after parking.

i Note

- During intelligent parking assist, when you apply the brake pedal, the intelligent parking assist will be suspended, and when you tap "Continue", parking will be resumed.

Intelligent Parking Assist supports vertical and parallel parking spaces. For the parking space without parking space line, there shall be other vehicles or large objects on the left and the right sides of a vertical parking space (on the front and the back sides of a parallel parking space). If the parking space has clear parking space line and good illumination, the intelligent parking assist system can detect the parking space even if there are no reference objects on both sides of the parking space.

Canceling Intelligent Parking Assist

The intelligent parking assist will cancel when:

- The driver turns the steering wheel manually or applies the brake to shift gear when parking is in progress
- Parking can be canceled by tapping the "Exit" button on the parking screen before parking starts.
- Parking paused for more than 30 seconds without resuming.
- The intelligent parking assist pauses for more than twice due to operations of opening the door, applying the accelerator pedal or brake pedal.

Warning

- The performance of the intelligent parking assist system depends on the environmental detection and identification ability of the ultrasonic sensor and the around view cameras.
- The intelligent parking assist system may not always be able to detect parking spaces and the objects in the parking routes, so the driver must check the environment and make sure the environment is appropriate and safe.
- Despite the fact that intelligent parking assist system is able to avoid obstacles and suspend automatically, the driver needs to be ready at any time to avoid vehicles, pedestrians and objects due to the restrictions of the sensor.



7. XPiLOT Driving

Warning

- Enabling the intelligent parking assist system at a narrow place will restrict the sensors' ability to detect the obstacle positions precisely, which will increase the risk of damage to the vehicle or surrounding objects.
- The obstacles at the height of or above the exterior rear-view mirror cannot be detected completely and effectively, so it is necessary to keep observing the environment and make sure it is safe and appropriate during parking.

Restrictions and Errors

The intelligent parking assist may not function as expected when:

- The vehicle is on a slope.
 - Poor lighting conditions or poor visibility (due to heavy rain, heavy snow, dense fog, etc.)
 - Curbs are not made of stone, or are undetectable, and if parked improperly, the vehicle's tires and rims can be damaged by the curb.
 - One or more ultrasonic sensors, surround view cameras are defaced or obstructed (e.g. sludge or snow and ice).
 - Weather conditions (heavy rain, snow, fog, extremely hot or cold temperatures) interfere with the sensor operation.
- Radars are restricted (For radar restrictions, [Refer to Page 115.](#))
 - Cameras are restricted (For camera restrictions, [Refer to Page 117.](#))
 - Uneven road surface, or pits or bulges in the parking space.
 - The intelligent parking assist system does not always recognize all parking spaces, e.g., parking markings are blurred, broken, confusing or covered.
 - The intelligent parking assist system may incorrectly identify parking spaces, such as gaps between objects such as flower beds and trees.
 - Interference lines near the parking space, such as old parking space line marks that have not been completely removed, tire marks, no parking markings, etc.
 - The sensor cannot recognize road surfaces where height differences exist, so do not use it at locations such as cliff edges, high platforms, or sidewalks facing the street.
 - The sensors have a limited ability and range to recognize obstacle and they cannot recognize obstacles that are overhanging, low objects (such as parking lock, limit pole) smaller in size, and smaller in width. When there is a similar object in the parking environment, be sure to watch for it and be prepared to step in and take over the vehicle at any time to avoid a collision.
 - The system may not recognize and support parking spaces in corners of walls or corners of streets.



- There are hollowed out objects near or in the parking space (such as bicycle wheels, drainage outlets, etc.).
- Cylindrical and prismatic columns near the parking space
- Do not use it when snow chains or spare wheels are in use.
- Do not use the intelligent parking assist system if the loaded object is protruding from the vehicle.
- Do not use the intelligent parking assist system if either of the right or left exterior rear-view mirror or surround view camera is damaged or in an abnormal position.
- The intelligent parking assist system may not always be available when parking on narrow streets, or narrow parking spaces as the necessary maneuvering space may not exist.
- The system cannot determine and exclude prohibited or dedicated parking spaces.
- Use approved tires with normal tire pressure to avoid the tire pressure warning system, and avoid using tires that are in alarm condition to ensure the normal functionality of the intelligent parking assist system.
- Modifying a vehicle or having a vehicle serviced at a non-local authorized service center may result in the intelligent parking assist being affected and susceptible to scrapes/collisions during the parking process.
- Many unforeseen circumstances can affect the ability of the intelligent parking assist system to park the vehicle into a parking space. Be sure to keep in mind that the intelligent parking assist system may not be able to

manoeuvre the vehicle properly for various reasons. Be aware that even when intelligent parking assist is in progress, always be ready to take over the controls of the vehicle immediately.

- The intelligent parking assist system is only a driving aid, not a consistently and correctly fully automated function, and does not achieve full autopilot capability, so the driver must maintain focus on observing and making reasonable judgment of the vehicle and environment.

The above examples, warnings, and restrictions do not cover all situations that affect the proper functioning of intelligent parking assist, and the driver must remain focused and fully responsible for safe parking at all times while using it and its related features.



7. XPILOT Driving

Intelligent Parking out Assist



After the intelligent parking assist has finished parking, Intelligent Parking Out Assist can be used after restarting the vehicle as long as the vehicle has not been moved. Just shift the vehicle into R or tap **P** at the bottom of the CID to enable it.

1. Observe the area in front of the vehicle for suitability and safety.



2. After confirming the safety condition, keep the brake pedal applied, shift the gear to R and tap the "START" button on the Intelligent Parking Assist interface.
3. The vehicle will start to exit the parking space. The driver needs to keep observing the surroundings to make sure the process is safe.

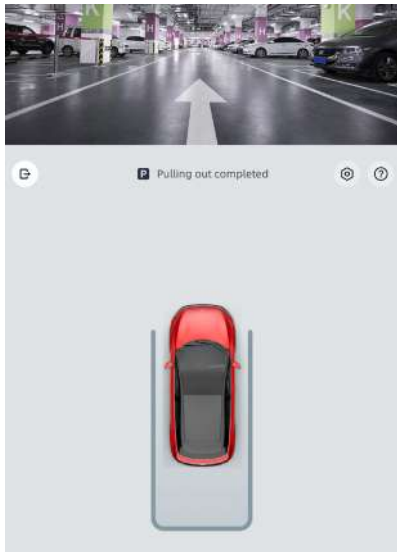

- "Pulling out completed" will be displayed on the CID after exiting the parking space.

Resuming Intelligent Parking Out

During intelligent parking out, when the brake pedal or accelerator pedal is applied, the intelligent parking out will be suspended, and tap the "Continue" button to resume.

Canceling Intelligent Parking Out

The intelligent parking out cancels when:

- The intelligent parking out will cancel automatically if the driver turns the steering wheel manually or applies the brake to shift gear when the intelligent parking out is in progress.
- The intelligent parking out can be canceled by tapping the "Exit" button on the parking interface before the process starts.
- The intelligent parking out paused for more than 30s without resuming.
- The intelligent parking out pauses for more than twice due to operations of opening the door, applying the accelerator pedal or brake pedal.

The cancellation operations, warnings and restrictions for the intelligent parking assist also apply to the intelligent parking out. Please refer to the warnings and restrictions for intelligent parking assist [Refer to Page 143](#).



7. XPILOT Driving

Super Intelligent Parking Assist (With Voice Control Intelligent Parking Assist)

The Super Intelligent Parking Assist is an enhanced Intelligent Parking Assist system. In the Super Intelligent Parking Assist mode, parking space identification will be visual in a real-time manner. Unavailable parking spaces will be displayed in special forms, and available parking spaces that are passed by within certain range will be memorized and displayed on the CID, so that the driver can choose one to park.

In the Super Intelligent Parking Assist mode, the interface of intelligent parking assist will always be present, unless it is turned off actively by the driver.

When approaching the commonly used parking space, please operate as per the following steps for enabling Super Intelligent Parking Assist, so as to park the vehicle at the commonly used parking space:

1. Tap the **P** button on the bottom left corner of the CID to enter the Super Intelligent Parking Assist mode, no matter the vehicle is moving or stopped.
2. When the voice conversation system is activated, input "I want to park" by voice.
3. When the intelligent parking assist detects available parking spaces, and the vehicle is stopped safely, the driver can choose the target parking space and tap "Start" for Intelligent Parking Assist.

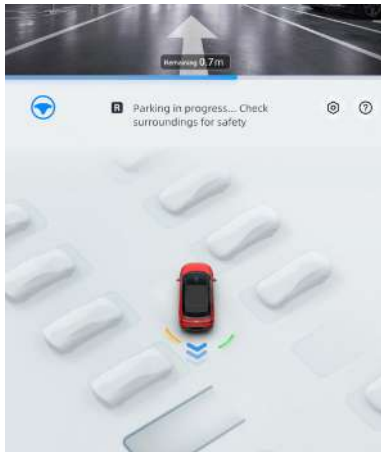

The warnings and restrictions for the intelligent parking assist also apply to Super Intelligent Parking Assist, see Warnings and Restrictions for intelligent parking Assist [Refer to Page 143](#).



Adaptive Cruise Control (ACC)

ACC is a driving assist function that can help improve comfort of driving. If it's unblocked ahead, ACC will keep the vehicle driving forward at the present maximum cruise speed. If a preceding vehicle is detected ahead, ACC will slow down the vehicle as needed and keep a distance with them based on time selected, until a proper cruise speed is reached.

When ACC is activated, the driver still needs to observe the road conditions ahead and apply brake when it is necessary.

Applicable scenario: The Adaptive Cruise Control (ACC) is mainly used for driving on dry, straight roads such as expressways, and shall not be used on city streets.

Adaptive Cruise Control (ACC) Operations



When the vehicle is in the Ready mode, it cannot enter ACC by toggling the lever upward/downward. Unless vehicles are detected ahead, ACC can be activated only when the driving speed exceeds 15 km/h. If a preceding vehicle is detected, ACC can be activated at any driving speed, even at 0 km/h, with at least 2 m from the preceding vehicle.

The minimum cruise speed is 30 km/h, and the maximum one is 120 km/h. The driver is obliged to set safe cruise speeds according to the road conditions and speed limits.



- If a gray indicator  is displayed on the dashboard, it means that ACC can be used, but it has not been activated.



- In this state, enable the Adaptive Cruise Control (ACC) by toggling the cruise control handle for once in the  direction.
- When ACC is activated, the indicator on the dashboard turns blue .



7. XPILOT Driving

When ACC is enabled, it is not necessary for you to control the accelerator pedal. Instead, ACC can have the control. If no vehicle is detected in front, ACC will keep the set speed. If a vehicle is detected in front, ACC will accelerate or decelerate as required, and keep the vehicle-following distance set by you while traveling at the set speed.

In addition, ACC will adjust the speed properly when entering and leaving a curve.

You can accelerate at any time when driving at the set speed in ACC status. However, when you release the accelerator pedal, the vehicle will return to the set speed.

When following a vehicle, ACC is available during low-speed driving. When the vehicle in front stops, ACC will control the vehicle to stop, too. When the vehicle moves again, ACC will restore work at the current set speed.

However, ACC will enter hold mode rather than resume in the following cases, and the dashboard will display a message to remind you to restore cruise control:

- The stop duration reaches 90 s
- The ultrasonic sensor detects that there is a close obstacle or pedestrian in front of the vehicle.
- The vehicle suddenly cannot detect the preceding vehicle.

If you want to restore ACC, please depress the accelerator pedal or pull the cruise control handle towards yourself.



- When driving at the set speed, the set cruise speed can be adjusted by pulling the cruise control handle in directions 4 or 5 and releasing the handle.

When ACC actively decelerates to keep the selected distance from the preceding vehicle, the brake light will light up to remind other road users that you are decelerating. When ACC controls the vehicle to accelerate, the accelerator pedal will not move.



7. XPiLOT Driving

Drivers Need to Respond to Requests to Take Over the Vehicle in a Timely Manner

When Adaptive Cruise Control (ACC) requires the driver to take over the vehicle, a takeover request alert is sent to the driver via the dashboard LCD display, along with a takeover alert warning tone.

When the dashboard LCD display shows the request words such as "Take Over Immediately", the driver should take over the vehicle immediately to control the vehicle speed and avoid the danger.

Caution

- If the driver has detected a hazard, do not wait for a takeover request to be issued before taking over the vehicle; take over the vehicle immediately.

Adjusting the Vehicle-Following Distance



- If you want to keep a certain distance from the vehicle in front, you can rotate cruise control handle **1** to choose one setting from the setup menu. Every setting is corresponding to a time-based distance, which represents the time required for the vehicle to reach the rear of the vehicle in front from current position.
- The system will memorize the driver's following distance settings. Each time the vehicle is Ready again, the following distance set last time will be adopted by default.



- When the cruise control handle is turned, the dashboard displays the current setting.



7. XPILOT Driving

Adjusting the Maximum Cruise Speed



Please pull the cruise control handle in direction ④ (accelerate upwards) or ⑤ (decelerate downwards), and release the handle when the set speed required is displayed if you want to change the set speed during ACC.

- Release the handle after flicking it in direction ④/⑤ once in short bursts to accelerate/decelerate in a single movement.
- Perform continuous acceleration/deceleration by holding the handle in the full up/down position.
- You can also update maximum cruise speed by flicking the cruise control handle in direction ② while pressing the accelerator pedal.

⚠ Caution

- If the vehicle does not detect a vehicle ahead that is traveling at a lower speed than the set speed, it may take several seconds to reach a new cruise speed.

Cancellation and Resuming of ACC



- You can cancel ACC manually by pulling the cruise control handle shortly in direction ③ or pressing the brake pedal. The speedometer icon on the dashboard turns gray or disappears, indicating that ACC is not controlling the speed of the vehicle.



7. XPILOT Driving



- To restore the previously set speed: release the cruise control handle after flicking it in directions 4 or 5.



- To resume cruise at the current driving speed: flick the cruise control handle once in direction 2.

Caution

- When ACC is canceled, the energy regeneration braking will slow the vehicle down in the same way as taking your feet off the accelerator pedal for deceleration when there is no ACC.



7. XPILOT Driving

Warning

- The Adaptive Cruise Control (ACC) is a driving assistance function that cannot handle all traffic, weather and road conditions.
- Please read all chapters about ACC in the Owner's Manual to understand its restrictions. Drivers should be fully aware of the restrictions and limitations before using the function.
- Adaptive Cruise Control (ACC) is designed for driving comfort and convenience and is not a collision warning or avoidance system. The driver must maintain constant control of the vehicle and always assume full responsibility for the safety of driving the vehicle. The driver is responsible for being alert at all times and driving safely and taking control of the vehicle. Do not rely on ACC to slow down the car completely. Always observe the road ahead and be prepared to take corrective action at any time, as over-reliance can lead to serious injury or death.
- Although ACC can detect pedestrians and riders, it is important not to reduce speed or control following distance excessively in response to this, always observe the road ahead and be prepared to take corrective action at any time, as over-reliance can lead to serious injury or death.
- Do not use ACC on city roads or in changing road conditions.

Warning

- Do not use Adaptive Cruise Control (ACC) on winding roads, roads with sharp bends, icy or slippery roads or under weather conditions when driving in even speed is unsuitable (such as heavy rain, snow, fog, etc.). ACC cannot adjust the driving speed based on the road and driving conditions.
- If there's a vehicle suddenly moving quickly or moving to ahead of your vehicle in a close distance, or the vehicle ahead slows down sharply, Adaptive Cruise Control (ACC) may not be able to brake or slow down in time.
- ACC can occasionally cause the vehicle to brake when braking is not required or when you did not intend to brake. This may be caused by following the preceding vehicle too closely, or detecting there's a vehicle or object in an adjacent lane (especially on a curve).
- It is the driver's responsibility to determine and maintain a safe vehicle-following distance at all times. Never rely solely on the ACC to maintain accurate or suitable vehicle-following distance.
- Never rely solely on the ACC to sufficiently reduce the vehicle speed to avoid a collision. Always observe the road ahead and be prepared to take corrective action at any time.
- ACC cannot automatically decelerate when the accelerator pedal is applied.



Warning

- There are walls, barriers, guardrails, bridge piers, tunnels and other road sections where the sensors may be disturbed causing the ACC to work abnormally. The driver needs to stay focused on driving on these or similar road sections and take over the vehicle in time when the ACC works abnormally.
- ACC cannot detect stationary vehicles or slow moving objects when the vehicle is traveling at a high speed; especially when a vehicle ahead departs your lane and leaves a stationary vehicle or object ahead, ACC cannot detect all objects and may not be able to brake/slow down. Always be aware of the road ahead and be prepared to take prompt corrective action. Over-reliance on ACC to avoid collision can lead to serious personal injury or death. In addition, ACC may react to vehicles or objects that do not exist or are not present in the current lane, causing the vehicle to slow down unnecessarily or inappropriately.

Warning

- ACC may not provide adequate speed control due to limited braking ability and being on a hill, may also misjudge the distance between you and the preceding vehicle and increase the speed while descending, causing the vehicle to exceed the set speed or the road speed limit. Relying on the ACC to slow the vehicle sufficiently to avoid a collision may result in serious personal injury or death. Always observe the road ahead and be prepared to take corrective action as required.

Restrictions

ACC may be canceled or unavailable when:

1. Brake pedal is applied.
2. Driving speed exceeds 125 km/h.
3. The vehicle is shifted into another gear.
4. A door is opened.
5. Front engine cover is opened
6. The radar is obscured. Radar may be obscured by mud, ice, snow, etc.
7. The camera is blocked or blind Obscuration caused by mud, water stains, ice and snow, or blindness caused by light or dimness.



7. XPILOT Driving

8. Anti-lock Braking System (ABS) is activated.
9. Electronic Parking Brake (EPB) is applied.
10. Traction Control System (TCS) is activated.
11. Emergency Braking Assist (EBA) is activated.
12. Airbag ejects.
13. Tire pressures are abnormal.
14. Hill Descent Control (HDC) is enabled.
15. The system is malfunctioning or in need of repair.

When ACC cannot be used or canceled, the vehicle no longer travels steadily at the set speed and no longer maintains the specified distance with the preceding vehicle.

- Unexpected cancellations may occur at any time for unknown reasons. Always observe the road ahead and be prepared to take immediate actions. Drivers are always responsible for keeping the vehicle under control.

ACC is particularly unsuitable for the following situations.

- Roads with sharp turns, or poor road conditions such as slippery or icy roads.
- ACC cannot detect pedestrians.
- ACC cannot detect vehicles or objects on the other side of the ramp.
- The vehicle in front is equipped with an object that protrudes beyond its body.
- Construction, accident and other road sections.
- The ACC cannot identify the vehicle that travels in opposite direction.
- Radars are restricted (For radar restrictions, [Refer to Page 115.](#))
- Radars are obscured (by dust, cover, etc.), or the weather conditions are poor (e.g. heavy rain, heavy snow, dense fog).

The above examples, warnings, and constraints do not cover all the conditions that can affect the proper operation of the ACC.



Lane Centering Control (LCC)

The Lane Centering Control (LCC) is a comfortable assisted driving function, including Traffic Jam Assist (TJA) below 60 km/h and Intelligent Cruise Assist (ICA) above 60 km/h.

The LCC is not available until the Adaptive Cruise Control (ACC) has been activated. When the LCC is activated, it can assist the driver in controlling the steering wheel and keeping the vehicle in the center of the current lane at all times.



The LCC is suitable for highways and dry roads with clear lane lines. Disable this function on city streets, and keep your hands on the steering wheel at all times and take over the steering wheel if necessary when enabled.

Lane Centering Control (LCC) Operations:



- Flick the cruise control handle twice along ② to turn on the LCC (the LCC can be turned on only when ACC is available but not yet activated or when ACC is activated).



- If a gray steering wheel icon  appears on the dashboard, it means that the LCC is available, but not activated. Automatically activated when certain conditions are met (e.g. lane line detected, steering light turned off, etc.)
- Upon successful activation of the LCC, the steering wheel icon on the dashboard will turn blue  with a function entry tone.

At this time, the LCC can assist the driver in controlling the steering wheel and the vehicle speed remains controlled by the Adaptive Cruise Control (ACC).



7. XPILOT Driving

Turning On/Off with CID

Turning on the Lane Centering Control switch for the first time requires you to study relevant knowledge and pass an assisted driving test.



- After the vehicle is in Ready mode, the LCC switch is at the last operating status by default. When the vehicle is shifted in gear P, tap "🚗 → XPILOT → Lane Centering Control" to turn on/off LCC.

You Need to Timely Respond to the Take-Over Request of the Steering Wheel

When the LCC detects that you are not holding the steering wheel, it will send you a take-over request through the dashboard signaling "Please hold on the steering wheel", and at the same time, a take-over alert warning tone will sound.

When the dashboard displays "Please hold on the steering wheel", "Take over immediately" and other requests, at this time, you should immediately hold and take over the steering wheel if necessary to avoid danger. When the LCC detects your hand on the steering wheel, it will stop giving the takeover alert. If you ignore this takeover alert and do not take over the steering wheel in time, this will result in that the LCC exits and is not available again in this driving cycle. Only after the vehicle is Ready again, the LCC can be enabled again.



Caution

- If the driver has detected a hazard, do not wait for a takeover request to be issued before taking over the vehicle; take over the vehicle immediately.



Warning

- Please read all chapters about LCC in the Owner's Manual to understand its restrictions. Drivers should be fully aware of the restrictions and limitations before using the function.
- LCC is an assisted driving function and is not fully autopilot, you still need to keep your hands on the steering wheel at all times when LCC is activated so that you can take over the vehicle in the event of potential risk. The driver must maintain the continuous control of the vehicle and assume full responsibility for the safety of driving the vehicle.
- The LCC is designed for driving comfort and convenience, it cannot handle unexpected and dangerous situations, so the driver is responsible for remaining alert at all times, driving safely and taking control of the vehicle. Never rely on LCC to respond to unexpected emergency. Always observe the road ahead and be prepared to take corrective actions at any time. Otherwise serious injury or death could occur.
- LCC is not suitable for all traffic, weather, and road conditions. Do not enable the LCC in adverse weather (e.g. rain, snow, fog), or on roads where pedestrians or cyclists may pass through.

Warning

- Please use LCC carefully on congested roads. The behavior of other vehicles (e.g., other vehicles adding to the front of the vehicle or crossing in front of the vehicle, vehicles leaving the lane in front of the vehicle, etc.) may cause LCC to be disturbed and make a wrong turn causing the vehicle to cut off or even collide with other vehicles, so it is the driver's responsibility to intervene and avoid collision with other vehicles in time.
- Never use LCC when the vehicle is in bad condition, such as: abnormal four-wheel alignment, abnormal tire pressure, etc.
- Do not use LCC on city roads or in changing road conditions.
- When the LCC cannot be used or is canceled, the system cannot assist the driver to keep the vehicle in the center of the current lane.
- The LCC will occasionally assist the vehicle in steering when assistance is not needed or when you do not intend to adjust the direction. This may be caused by unclear or irregular lane lines or by other lines or objects on the surface of the lane that resemble lane lines, in which case you should take over the vehicle in time.



7. XPILOT Driving

Warning

- LCC may not work properly at traffic intersections and may perform unintended steering control causing unanticipated hazards, such as: cuts or even collisions with other vehicles at the intersection. Do not use the LCC at traffic intersections.
- When there is a sharp change in the direction of the lane lines ahead, such as lane merging or a sudden increase or decrease in lane width, LCC may fail and you will need to take over the vehicle in advance as you approach these sections and never rely on LCC to cope with these operating conditions.
- Guardrail, barrier or curb on one side of the road may interfere with the sensor causing the LCC to work abnormally, and the driver should take over the vehicle at this time.
- It is important that you put your hands on the steering wheel when driving through a curve and take over the vehicle in time if the LCC fails.
- Road sections where lane lines are blurred, disappearing or covered, and when vehicles ahead turn or when a vehicle crosses in front of the vehicle, it may cause the LCC to turn abnormally.

Warning

- When the lane line disappears or is disconnected, the driver should take over the vehicle in time to avoid unanticipated hazards caused by LCC failure or anomalies at this time.
- Never use the LCC at roadway junctions or diversions.
- If the driver fails to drive attentively, LCC may exit.
- LCC may work abnormally when another vehicle drives into the front of the current lane in close proximity, in which case, the driver needs to take over control in time.
- LCC may unexpectedly be exited at any time for unknown reasons. Always observe the road ahead and be prepared to take immediate actions. Drivers are always responsible for keeping the vehicle under control.
- Do not use the LCC on twisting roads, roads with sharp curves, bumps, icy or slippery roads. The LCC cannot provide stable assistance control over the steering wheel consistently in these poor road conditions.



Restrictions

The LCC may be disabled or unavailable when:

1. Adaptive Cruise Control (ACC) exits or fails to be activated
[Refer to Page 149.](#)
2. Brake pedal is applied.
3. Steering wheel is turned manually.
4. Driving speed exceeds 125 km/h.
5. Lane conditions are not met.
6. The vehicle is shifted into another gear.
7. The driver's seat belt is unbuckled.
8. A door is opened.
9. The radar is obscured. Radar may be obscured by mud, ice, snow, etc.
10. The camera is blocked or blind. Obscuration caused by mud, water stains, ice and snow, or blindness caused by light or dimness.
11. Tire pressure detection system alarms.
12. Hill Descent Control (HDC) is enabled.
13. Wipers are in LO or HI.
14. The system is malfunctioning or in need of repair.
15. Road conditions are not met.

LCC should not be used in the following cases:

- Roads with sharp turns, spliced roads or poor road conditions such as bumpy, slippery, or icy roads.
- Sloping roads, or uphill or downhill sections
- The driving lane is too wide or too narrow.
- Roads where pedestrians or riders may pass through
- Poor lighting conditions or poor visibility (due to heavy rain, heavy snow, dense fog, etc.)
- Strong light (such as oncoming headlight or direct sunlight) obstructs the camera's view.
- Preceding vehicle blocks the view of the camera, or the lane line.
- Windshield blocks the view of the camera (water spray, dust or sticker blocking, etc.)
- Excessive wear, coverage, and disappearance of lane lines, overlapping of old and new lane lines, temporary adjustments, or rapid changes due to road construction (e.g., lane bifurcating, crossing, or merging).
- Objects or landscape features project on lane, forming large shadows.
- Road surfaces with text or traffic signs.
- Sections with guide lines.
- Warning cones, signs or other objects are placed on the road surface.



7. XPILOT Driving

- Presence of large vehicles such as trucks, buses, etc. to the side or ahead.
- The use of LCC on construction roads is prohibited.
- Radars are restricted (For radar restrictions, [Refer to Page 115.](#)).
- Cameras are restricted (For camera restrictions, [Refer to Page 117.](#)).
- Radars or cameras obscured (by dust, cover, etc.), or the weather conditions are poor (e.g. heavy rain, heavy snow, dense fog).
- Significant lateral airflow or strong winds can affect the performance of LCC, which is not suitable for such weather conditions.

The above examples, warnings, and constraints do not cover all the conditions that can affect the proper operation of the LCC.

XPILOT Intelligent Driving Simulation Display System



XPILOT Intelligent Driving Simulation Display System is part of the XPILOT and displays the vehicle's real-time detected external environment, including lane lines, and other traffic participants, through the dashboard.

Restrictions and Errors

The XPILOT Simulation Display System does not always detect all objects, vehicles, riders, or pedestrians, nor does it accurately display the full condition of the surroundings, and there is a possibility of display errors, such as:

- The vehicle is driven on a road with large curves or in poor road conditions.
- Windshield blocks the view of the camera (water spray, dust or sticker blocking, etc.)
- Cameras are restricted (for camera restrictions [Refer to Page 117.](#)).



- Display an object of one type incorrectly as a simulation of an object of another type.
- Display an object with a wrong simulation of direction and distance.

Warning

- XPILOT Simulation Display System is an assisting function that does not work under all driving situations, traffic, weather, and road conditions and is not a substitute for focused driving and accurate judgment, nor is it a substitute for the driver's observation of the road environment and other traffic participants. Always observe road conditions when driving; reliance on the XPILOT Simulation Display System can cause serious personal injury or death.
- The monitoring range of the camera and radar sensors associated with the XPILOT Simulation Display System is limited. Road conditions and weather conditions may adversely affect the area that can be monitored by the XPILOT Simulation Display System, so be sure to drive with caution. Always drive with caution.

All of the foregoing warnings and restrictions do not cover the situations that may prevent the XPILOT Intelligent Driving Simulation Display System from functioning properly, and these features may not function as intended for many other reasons, and it is the driver's responsibility to remain alert and aware of the area next to the vehicle in order to drive safely.



8. Maintenance

It is recommended that you keep an eye on your vehicle's condition regularly to keep it at an optimal state.

Traction Battery Maintenance

The traction battery will slowly self-discharge even when the vehicle is not in use. When the state of charge (SOC) is low, parking the vehicle for a long time will shorten the lifecycle and performance of the power battery and affect the range of the vehicle. Therefore when the vehicle is parked for a long period of time, it is recommended to check the remaining range, which should be kept between 30% and 60%, and if the power is deficient, please arrange for charging immediately before leaving it idle.

Refer to the table of the relationship between battery left and parking times to ensure that there is enough battery left.

Range or SOC	30%	50%	60%
Number of Days Parked	≤ 90 days	≤ 150 days	≤ 180 days

It is recommended that the battery be checked by powering on every 3 months. If the battery shows low remaining range or low SOC, it needs to be recharged in time, otherwise, the performance of the traction battery will be reduced due to low voltage.

Traction battery life can also be affected by ambient temperature. A low ambient temperature may reduce the range or increase the charging time.

Note

- The recommended working environment temperature for charging is 0-45°C. When the working environment temperature is lower than 0°C, the charging time will be prolonged.
- Parking for a long period of time in a high temperature or cold environment will accelerate the degeneration of traction battery. It is recommended to park in a cool, dry, and ventilated place, avoid heat sources (such as heating pipes) and low-lying areas, and stay away from flammable and explosive materials and corrosive substances.
- Avoid wading your vehicle through water for a long distance or a long period of time.
- Do not fully discharge the traction battery.

Charging Port House Cleaning

Under normal circumstances, use a high-pressure pneumatic gun and a brush to clean it every week. If no such tools are available, you can use a dust-free cloth or cotton swab to clean the charging stand and the charging gun. Under abnormal circumstances (e.g., if the charging port cover is not fastened), use the above methods to clean the stand in time.

Warning

- It is strictly forbidden to use sharp objects such as screwdrivers and tweezers to touch the charging gun pins and charging stand sockets to avoid damage to the latter.



Tire Maintenance

Inspection and Maintenance of Tires

Check the tread and side walls regularly for any signs of deformation (bulging), cuts, or wear.

Tire Wear

Sufficient tread depth is critical to tire performance. Tires with a tread depth of less than 3 mm are more likely to slip on wet condition and should not be used. Tires with a tread depth of less than 4 mm do not perform well in snow and slush and should not be used during winter.

To reduce tire wear and extend the life of your tires, please maintain the tires based on your driving habits and road conditions.

- Avoid accelerating violently.
- Avoid turning sharply and braking hard
- Slow down when driving over potholes, curbs, or similar sections of the road.
- It is recommended to rotate the tires after every 5,000-8,000 km.

Replacement of Tires and Wheels

Tires will deteriorate over time due to UV rays, extreme temperatures, high loads, and environmental conditions. They may also have normal wear during normal acceleration, braking, and turning. It is recommended that tires be replaced every three years or 40,000 km (whichever comes first), or earlier if necessary (e.g. if the tire tread wears down to the wear mark, if a foreign object scratches or punctures the surface of the tire).

Caution

- For your safety, only use tires and hubs that match the original specifications. If the tires do not match the original specifications, the operation of the Tire Pressure Monitoring System (TPMS) may be affected.

Warning

- Do not modify the wheel and tire pressure monitoring device, which may reduce the safety of the vehicle's operation.



8. Maintenance

Seasonal Tire Types

Summer tires

Summer tires are suitable for extremely dry or wet roads, but not for winter. Winter tires are recommended when driving in cold weather or on icy roads.

All-season Tires

These tires are designed to provide sufficient traction in all seasons of the year, but may not provide the traction comparable to winter tires on icy and snowy roads. All-season tires are identified by "ALL SEASON" and/or "M+S" (mud and snow) on the sidewall of tires.

Winter tires

Winter tires improve traction on icy and snowy roads. When installing winter tires, be sure to install a complete set of four tires at the same time. All winter tires must have the same diameter, brand, construction and tread pattern on four wheels. Please contact your local authorized service center for winter tire recommendation.

When driving a vehicle fitted with winter tires, you may experience increased road noise, reduced tread life, and reduced traction on dry roads.

Warning

- Do not drive the vehicle if the tires are damaged, excessively worn, or have incorrect air pressure. Check the tires regularly for wear and tear to make sure there are no cuts or bulges.
- Upon a tire replacement or repair, check the wheel alignment and perform the wheel dynamic balance again.
- If you find uneven and excessive tire wear, visit your local authorized service center as soon as possible to check wheel balancing and wheel alignment.
- Insufficient tire pressure is the most common cause of tire failure, which can cause overheating, cracking, tread delaminating, or tire breakage that may lead to unexpected accident (e.g. loss control of the vehicle) and injury.
- It will also shorten the endurance range of the vehicle as well as the tread life of the tires.
- Do not use any tire sealant (except the type provided in the vehicle's tire repair kit). Other types of tire sealants may cause failure to the tire pressure sensor.



Tire Pressure Monitoring System (TPMS)

TPMS can monitor the tire pressure and temperature in real time, and give an alarm with the data information of tire pressure and temperature on the dashboard to remind the user to maintain reasonable tire pressure. If the dashboard gives a tire pressure alarm, please stop and check the tires as soon as possible and inflate them to the proper pressure.

Calibrating TPMS with the CID

After the tire is replaced or the tire position is exchanged, the TPMS needs to be recalibrated.

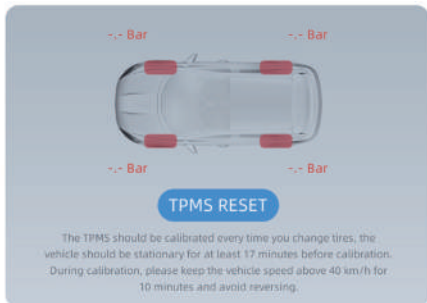

Tire Pressure Calibration Procedure:

1. The vehicle needs to be stationary for 17 min before performing the tire pressure calibration.
2. Tap "🚗 → Status" on the CID to enter the tire pressure calibration interface, and tap the "TPMS RESET" button to start calibrating the tire pressure.
3. When the vehicle has run at a speed over 40 km/h for 10 min, the TPMS calibration will be finished.

Temporary tire repair

The vehicle is not equipped with a spare tire but accompanied by a tire repair kit.

The tire repair kit includes an inflatable pump and a can of tire sealant (sufficient for one tire). When injected into the tire, the tire sealant will be effective when the biggest puncture on the tire that does not exceed 6 mm in size for a temporary repair.





8. Maintenance

Caution

- Where tire puncture is greater than 6 mm, or in case of severe tread damage, sidewall damage, tire tear, or falling off from the rim hub, please contact your local authorized service center.

Warning

- The tire repair kit is only enough to be used for a single tire temporary repair only, and the damaged tire must be repaired or replaced as soon as possible.
- If the tire has been temporarily repaired with tire sealant, its running speed shall not exceed 80km/h.
- Please read and follow all warnings and prompts on the tire repair kit.
- If any one of tires is flat, do not continue driving, or you may cause a serious injury.

Tire Sealant

The tire sealant supplied with the tire repair kit is specially designed for XPENG vehicles, and it will not damage the tire pressure sensor. Therefore, it can only be substituted with tire sealant of the same type and capacity. Tire sealant is available in your local authorized service center.

The validity period is printed on the tire sealant can. If the validity period has expired, the tire sealant may lose its expected effect. Be sure to buy a new can of tire sealant.

Warning

- Do not use tire sealants purchased from other channels, otherwise it may cause failure to the tire pressure sensor.
- Be sure to read and follow the safety and operation instructions for the tire sealant.
- Prevent children from touching the tire sealant.
- If the eyes come into contact with the tire sealant, rinse them with water immediately and seek medical attention.
- In case of accidental ingestion of the tire sealant, seek medical attention immediately;
- In case of accidental inhalation of the tire sealant, breathe fresh air immediately to avoid breathing disturbance and seek medical attention immediately.



Injecting tire sealant and air into the tires

Temporarily repair small tire punctures (less than 6 mm) by following these steps:



1. Take out the tire repair kit from the trunk.
2. Take out the inflatable pump and tire sealant from the tire repair kit.

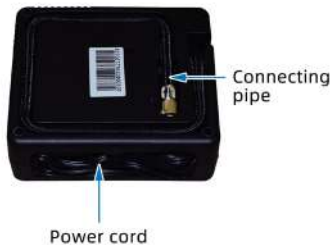

3. Take out the connecting pipe from the back of the inflatable pump and the power cord from the side





8. Maintenance

4. Connect the inflatable pump hose to the inlet valve joint of the tire sealant can and tighten it.



5. Install the tire sealant can to the inflatable pump.



6. Install the connecting pipe of tire sealant can to the tire valve and tighten it.
7. Connect the power cord of the inflatable pump to the 12 V power supply in the vehicle storage box.

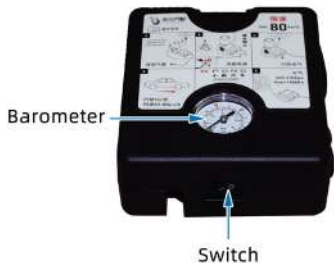

8. Press the switch and the inflatable pump starts to inflate the tire.
 - ▶ Observe the pressure gauge, until the tire pressure reaches the standard pressure and then stop inflating.
9. Switch off the inflatable pump and disconnect the connecting pipe from the tire valve. Wipe off excess tire sealant from the tire valve and wheel.
10. Drive immediately for 8km to distribute the sealant around the entire tire, and keep the speed under 80km/h.
11. Stop the car, and check the tire pressure. Inflate with an inflatable pump if necessary

Caution

- Please repair or replace the tire as soon as possible.
- After using the tire repair sealant, you should buy a new one in time.
- Keep the speed under 80km/h.

Inflation only



1. Take out the tire repair kit from the trunk.
2. Take out the inflatable pump from the tire repair kit.



8. Maintenance

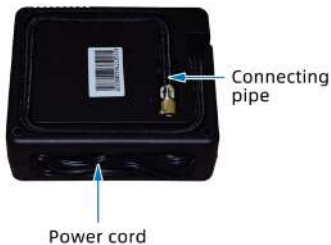

3. Take out the connecting pipe from the back of the inflatable pump and the power cord from the side

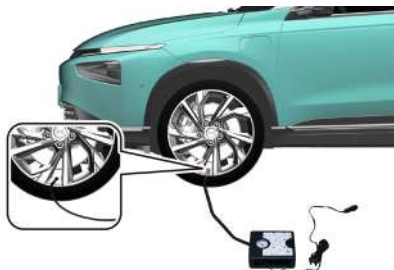

4. Install the connecting pipe of the inflatable pump to the tire valve and tighten it.
5. Connect the power cord of the inflatable pump to the 12 V power supply in the vehicle storage box.

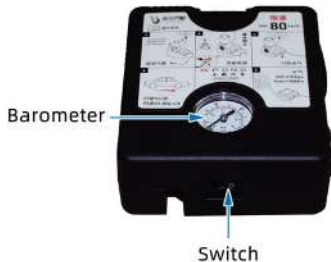

6. Press the switch and the inflatable pump starts to inflate the tire.
 - ▶ Observe the pressure gauge, until the tire pressure reaches the standard pressure and then stop inflating.
7. Switch off the inflation pump.



Use of Snow Chain

When you drive the vehicle in a severe environment such as snowy or icy roads in winter, use snow chains to increase tire friction and reduce side-slip. For the use of snow chains, the following suggestions must be followed:

- When driving in deep snow, it is necessary to install snow chains on the tires. To install snow chains, you must choose an equivalent of a size and type that matches the specifications of the tires on your vehicle.
- Emergency braking on snowy and icy condition can cause the vehicle to skid. Maintain a proper safe distance from the vehicle in front of you and press the brake pedal lightly, noting that the snow chains installed on the tires can provide some friction, but cannot prevent the occurrence of sideslip.

Caution

- Snow chains installed on your tires can ensure that you can drive in a balanced manner in all types of weather. It should be borne in mind that the vehicle may not have enough traction after installing the chains. Drive carefully, even when the road conditions are good. Do not exceed the speed limit of the tire snow chains, or exceed 50km/h, subjected to the lower.
- If snow chains are fitted to the tires, the size and type of chains should comply with the standard tires on the vehicle, otherwise the safety and handling of driving the vehicle will be adversely affected.
- Snow chains need to be installed in pairs on the front tires.
- Do not use snow chains on dry ground, and remove the chains when you drive to a snow-free road.
- After installing the snow chains as close as possible to the tires and driving 0.5-1.0 km, tighten the chains again.



8. Maintenance

Exterior Cleaning

Washing your vehicle frequently will help protect the appearance of your vehicle. Keep the vehicle in a cool place away from direct sunlight when washing. If the vehicle is left in the sun for an extended period of time, it is recommended that you wait until the exterior of the body has cooled before washing it.

When using an automatic car washer, be sure to follow the instructions of the car wash operator.

When in high pressure car wash, rinse the glass directly, do not rinse the window edges from the outside.

After washing the vehicle in cold winter, dry the water in the grooves around the door handle to avoid freezing and stopping the door handles from being opened electrically.

To prevent damage to the paintwork, remove corrosive substances (bird droppings, resins, insects, asphalt spots, paving salt, industrial dust, etc.) immediately and do not wait until the next washing time.

When cleaning the exterior of the body, follow the steps below

1. Preparations before cleaning
 - Close the doors, back trunk and check that the charging port is fully closed.
2. Rinse thoroughly
 - Before washing, rinse off the dirt and grit from the body with a hose. Please rinse areas prone to dust, silt, or paving salt (e.g. wheel arches and panel joints).
3. Hand washing
 - Add quality neutral vehicle cleaners to cold or lukewarm water, dampen a soft cloth and hand wash the exterior of the body.
4. Rinse with water
 - After washing, rinse with water to prevent any residual soap from drying out on the surface.
5. Dry with a soft cloth



Notes for exterior cleaning

Caution

- Do not use windshield washer liquid. Doing so can interfere with wiper friction and create a chattering noise.
- Do not use hot water or detergents.
- Do not rinse under a hot sun.
- If a pressure washer is used, maintain a distance of 30cm between nozzle and surface of body. Keep the nozzle moving and do not concentrate the water jet on any one area. Spray water towards the charging port is strictly prohibited.
- Do not spray water from the hose directly toward the windows, door seals, or through the wheel hub holes into the brake parts.
- Avoid using cotton flannel or coarse cloths, such as car washing gloves.
- Do not use chemical tire cleaners as they may damage the finished wheel surface.
- Avoid using pressure washer to clean rear view camera and parking sensor. Do not use sharp or rough objects to clean the sensor or camera lens. Doing so may scratch or damage its surface.

Cleaning, Caring of External Plastic Parts

- It can usually be cleaned with water as well as a soft cloth or a soft brush.

Window and Mirror Cleaning

- Clean the window glass and mirrors with an alcohol-based glass cleaner, then dry the glass surface with a clean, lint-free soft cloth or faux antelope skin.
- After maintaining the body surface, any wax left on the glass should be removed with a special cleaner and cleaning cloth to avoid scratching the wiper blades.
- You can remove snow from windows and mirrors with a small brush.
- Use a de-icing spray to remove ice buildup, or you can use a de-icing shovel, but extra care is needed to avoid damaging parts, and you must also scrape the ice in the same direction when using it.



8. Maintenance

Caution

- Do not remove the ice or snow on the windshield and mirrors with warm or hot water, otherwise the glass may burst into shatters.
- If there are residues of rubber, grease, and silicone type substances on the glass, they must be removed with a special window cleaner or silicone cleaner.

Seal Maintenance

- When maintaining the seals, use a soft cloth to remove the dust and dirt from the surface. Periodically coat the rubber seal with a special protectant.

Wiper Blade Cleaning

- Regularly inspect and clean the edges of the wiper blades for rubber cracks, splits, and roughness. If damaged, please contact your local authorized service center for replacement.
- Contaminants on the wiper blades may reduce the effectiveness of the wiper blades. Contaminants include ice, car wash spray wax, cleaning fluids containing bacteria and/or water repellents, bird droppings, tree sap, and other organic materials. Please follow the instructions below for cleaning.

- Clean the windshield with a non-abrasive glass cleaner.
 - Lift the wiper arm from the windshield slightly so you can get close to the wiper blade, then wipe the wiper blade clean with isopropyl alcohol (rubbing) or wiper cleaning fluid.
- If the wiper blades are still ineffective after cleaning, they may need to be replaced.

Caution

- Care should be taken when lowering the wiper arm to prevent it from momentarily dropping on and hitting the windshield.
- Wiper blades are coated with a layer of graphite for smooth wiping without scraping noises. Cleaning agents containing solvents, hard sponges, and sharp objects can damage the graphite layer. A broken graphite layer will result in increased wiper scraping noises and wiper blade should be replaced timely.
- Always check that the wiper blades are not frozen to the windshield before using the wipers in winter or cold weather. If so, de-ice first before using, otherwise, the wiper blades and wiper motor may be damaged.



Interior Cleaning

Check and clean the interior frequently to keep the interior looking neat and new and prevent premature wear and tear.

Interior Glass

- It is strictly prohibited to scratch and use any abrasive cleaning solution on the glass or mirror surface. Otherwise, the reflective surface of the mirror and the rear window heating element may be damaged.

Dashboard and Plastic Surfaces

- Polishing of the dashboard surface is strictly prohibited. Polished surfaces tend to reflect light and may interfere with driving visibility.

Cleaning the Seats

- Wipe the stain as soon as possible with a soft cloth dampened with warm water and neutral soap. Wipe gently in a circular motion, then dry with a soft lint-free cloth.

Seat Belt

- Pull out the seat belts and wipe them clean. Do not use any type of detergent or chemical cleaner. Pull out the seat belt and allow it to dry naturally.

Carpet

- Avoid using carpets that are too wet. For heavily soiled areas, use a diluted automotive interior cleaner.

CID and Dashboard

- Clean the CID and dashboard with a special clean lint-free soft cloth. Never use cleaning agents (such as glass cleaner), wet rags or dry rags with static electricity (such as a freshly cleaned ultra-fine micro fiber).
- Wiping the CID after enabling cleaning mode. This way, you will not accidentally activate the buttons and change the settings. Tap "System Settings → Display → Clean Screen" on the CID, then the display becomes darker and dust and smudges are more easily visible.

Chrome-Plated Surfaces and Metal Surfaces

- Polishes, abrasive cleaners, or hard cloths can damage the chrome-plated surface and the finish of the metal surface.

Foot Mats

- To extend the life of your vehicle carpet and for easy cleaning, please use genuine foot mats approved by XPENG. Clean the foot mats regularly and make sure they are properly installed. If the foot mats are excessively worn, please replace them promptly.



Interior Cleaning Precautions

Caution

- To avoid interfering with the pedals, make sure the driver's foot mat is properly secured. No other foot mats on top of it. Foot mats should always be placed on the carpeted surface of the vehicle
- The use of solvents (including alcohol), bleach, citrus cleaners, naphtha, silicone-based products, or additives can damage the interior.
- Static charged substances can cause damage to the CID and dashboard.
- If you notice any damage to the airbags or seat belts, contact your local authorized service center as soon as possible.
- Do not allow any water, cleaning agents, or fabrics to enter the safety belt unit.



Check Traction Battery Coolant

The cooling system is filled with coolant when the vehicle leaves the factory and the coolant level should be checked during the specified maintenance period.



Check the level markings on the side of the coolant reservoir:

- ▶ MAX: Upper limit marker
- ▶ MIN: Lower limit marker

The coolant level should be between the MIN mark and the MAX mark. If it is below the MIN mark, add coolant approved by XPENG promptly.

Refill the coolant

Unscrew the reservoir cap and fill it with coolant.

- ▶ To maximize the performance and life of the traction battery, a specific type of coolant should be selected accordingly for the cooling system (with different freezing points depending on the lowest temperature in the location).
- ▶ After adding coolant, promptly check the system for leaks at your local authorized service center.



8. Maintenance

Check Motor coolant

The motor cooling system is filled with coolant when the vehicle leaves the factory and the coolant level should be checked during the specified maintenance period.



Check the level markings on the side of the coolant reservoir:

- ▶ MAX: Upper limit marker
- ▶ MIN: Lower limit marker

The coolant level should be between the MIN mark and the MAX mark. If it is below the MIN mark, add coolant approved by XPENG promptly.

Refill the coolant

Unscrew the reservoir cap and fill it with coolant.

- ▶ To maximize the performance and life of the motor, a specific type of coolant should be selected accordingly for the cooling system (with different freezing points depending on the lowest temperature in the location).
- ▶ After adding coolant, promptly check the system for leaks at your local authorized service center.



Check Heating Coolant

The heating system is filled with coolant when the vehicle leaves the factory and the coolant level should be checked during the specified maintenance period.



Check the level markings on the side of the coolant reservoir:

- ▶ MAX: Upper limit marker
- ▶ MIN: Lower limit marker

The coolant level should be between the MIN mark and the MAX mark. If it is below the MIN mark, add coolant approved by XPENG promptly.

Refill the coolant

Unscrew the reservoir cap and fill it with coolant.

- ▶ To maximize the performance and life of heating system, a specific type of coolant should be selected accordingly for the cooling system (with different freezing points depending on the lowest temperature in the location).
- ▶ After adding coolant, promptly check the system for leaks at your local authorized service center.



8. Maintenance

Check Brake Fluid

If the fluid level in the brake fluid reservoir falls below the recommended level, the brake indicator on the dashboard will light on as an alarm. If the alarm is set during driving, pull over immediately if it is safe to do so, and contact your local authorized service center as soon as possible.

Warning

- If you notice a loose brake pedal or significant loss of brake fluid, contact your local authorized service center as soon as possible. Driving under these conditions may result in longer braking distances or complete braking failure.



Check the level markings on the side of the brake fluid reservoir:

- ▶ MAX: Upper limit marker
- ▶ MIN: Lower limit marker

The brake fluid level should be between the MIN mark and the MAX mark. If it is below the MIN mark, add the brake fluid approved by XPENG promptly.

Refill of Brake Liquid

1. Clean the reservoir cap first to prevent dust from entering the reservoir.
2. Unscrew and remove the reservoir cap.
3. Fill with brake fluid complied with DOT4 specification until the brake fluid approaches the maximum (MAX) mark.

Warning

- Use only new brake fluid contained in a gas-tight closed bottle. Do not use brake fluid that has been used or in an open container. Brake fluid can absorb moisture, which will reduce braking performance.
- Brake fluid is highly toxic. Containers must be kept sealed and out of reach of children. In case of accidental ingestion, seek immediate medical attention.
- Brake fluid can damage painted surfaces. Absorb brake fluid spills immediately with an absorbent cloth and wash with a cleaner-water mixture.



Refill of Windshield Washer Fluid

Check the washer fluid regularly and add washer fluid to the reservoir if the level of washing liquid is found to be too low.

Regularly check the system, and check whether nozzles are clogged and whether the jetting is working properly.

Refill of Windshield Washer Fluid



1. Clean the reservoir cap first to prevent dust from entering the reservoir.
2. Open the fluid reservoir.
3. Fill with washer fluid until you see the level almost reaches the fill port.

Warning

- Do not allow windshield washer fluid to spill onto the body panels. The spill should be wiped immediately and the spill area washed with water.
- For temperatures below 4°C, use a washer fluid containing antifreeze. Avoiding fail to spray washer fluid because of freezing.



8. Maintenance

Replacement of Key Battery



1. Press the switch and remove the tailcap to the right.



2. At the arrow position, move lightly in opposite directions from the top and bottom to pry open a snap, then use a thin blade to slide back along the pried seam and pry open the left side snap of the key cover.



3. At the arrow position, move lightly in opposite directions from the top and bottom to pry open a snap.



4. At the arrow position, move lightly in opposite directions from the top and bottom to pry open a snap, then use a thin blade to slide back along the pried seam and pry open the right side snap of the key cover. The key case is opened.



- Remove the key battery.
 - Battery type: CR2032. It could be of either Panasonic or Maxell brands.
- Install in the reverse order.
 - Install with the key battery "+" (positive) terminal facing up.

Caution

- If the key battery is low, it will affect the key remote control function, please replace the key battery in time.

Parts and Modification

- Only parts manufactured or approved by XPENG are allowed to be used. XPENG conducts rigorous testing of components to ensure their suitability, safety, and reliability. These parts can only be purchased from a local authorized service center, installed by a XPENG professional, and the vehicle can be modified according to the advice of a XPENG expert.
- Do not modify your vehicle with parts that are not approved by the original manufacturer of XPENG, as this may affect the operation, safety, and durability of your vehicle, as well as potentially violating local government regulations.
- Do not modify the vehicle suspension, braking, and other systems, which may adversely affect the driving safety of the vehicle.
- Changes to electronic components and their software and wiring can affect their function and the proper functioning of other associated components, especially for safety-related vehicle systems, thus affecting the safety of the vehicle's operation and increasing the risk of accidents or injuries. Therefore, do not modify the wiring, electronic components, and their software.
- In addition, vehicle damage and performance problems caused by replacement, installation, or modification using parts that are not manufactured or approved by XPENG are not covered by warranty.



9. Vehicle Specifications

Vehicle Identification Number (VIN)

The VIN code is a legal identification mark of the vehicle for the registration of the owner and should not be scratched, removed, covered, hidden, altered, or painted.

You can find the VIN code at the following locations:



1. Applied to the bottom left side of the dashboard and can be seen through the windshield.

Under the front passenger seat



2. Engraved under the front passenger seat.

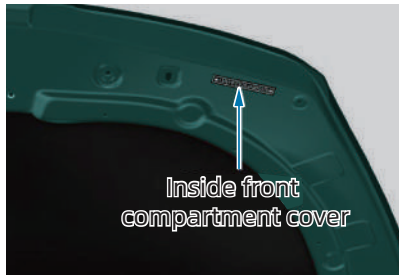

3. Applied to the inside of the front compartment cover.



9. Vehicle Specifications

Product Nameplate



4. Applied to the inside of the left rear door.



The product nameplate is located on the B-pillar of the front passenger side door and can be seen when the front passenger side door is opened.



9. Vehicle Specifications

Zhaoqing Xiaopeng Investment of New Energy Co., Ltd. e49*2018/858*10005 LMXXXXXXXXXXXXXXXXXX		
	2110	kg
	XXXX	kg
1-	1097	kg
2-	1050	kg

Vehicle information is presented on the product nameplate.

OBD diagnosis interface



The OBD interface for reading the electronic VIN code is located on the lower left rear of the dashboard and allows you to read the electronic VIN number and other information through an original factory diagnostic device or an official authorized diagnostic device (WDI-2 produced by DSA-CHINA ELECTRONIC TECHNOLOGY CO.,LTD. and X431 PRO3S or X431 PRO5+ made by LAUNCH TECH CO.,LTD.)



9. Vehicle Specifications

Drive Motor Model and Code

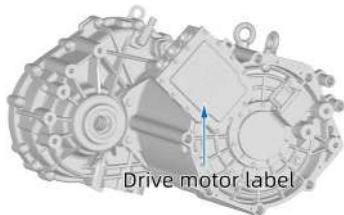

The model and code of drive motor can be found on the label of the drive motor.

Drive motor shell



The model and code of drive motor can be found on the shell of the drive motor.

Labels

Label Positions

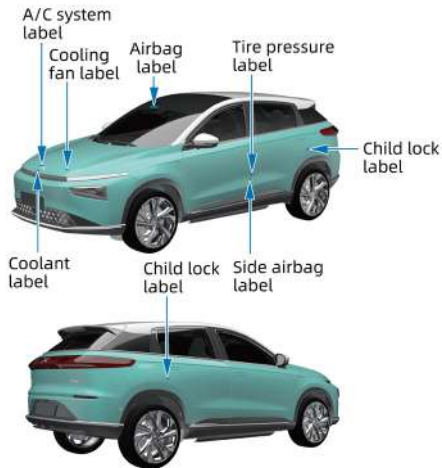



9. Vehicle Specifications

Label Information

冷轮胎充气气压 COLD TIRE INFLATION PRESSURE		
轮胎 Tire	型号 Size	气压 Pressure
前 Front	215/55 R17	250kPa
	215/50 R18	
后 Rear	215/55 R17	250kPa
	215/50 R18	

1. Tire pressure label.



2. Side airbag label.



3. Cooling fan label.



9. Vehicle Specifications



4. Child Locks labels

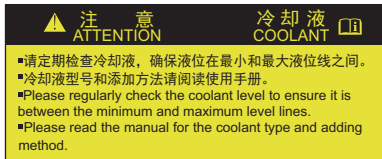

5. Coolant label.

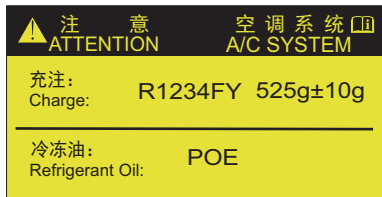

6. Air conditioning system label.



7. Airbag label.



9. Vehicle Specifications

Exterior Dimensions

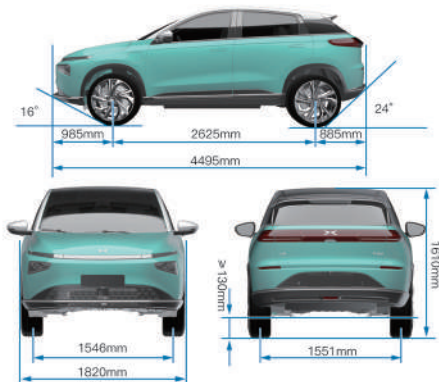

Item		Parameter
Exterior Dimensions	Length	4495 mm
	Width	1820 mm
	Height	1610 mm
Track	Front Track	1546 mm
	Rear Track	1551 mm
Wheelbase		2625 mm
Front Overhang		985 mm
Rear Overhang		885 mm
Min. Ground Clearance (Full Load)		≥130 mm
Approach Angle (Full Load) (full load)		16 °
Departure Angle (Full Load) (full load)		24 °

Note: Exterior rear-view mirrors (one for the left side and one for the right side) are not included in exterior width.



9. Vehicle Specifications

Weight

Item		Parameter		Unit
		11A5A1	11A5B1	
Kerb Weight	total	1660		kg
	Axle 1	970		
	Axle 2	690		
Loaded Vehicle Weight (with a driver)	total	1735		
	Axle 1	1009		
	Axle 2	726		
Gross vehicle weight rating	total	2110		
	Axle 1	1088		
	Axle 2	1022		
Gross vehicle weight Design	Axle 1	1097		
	Axle 2	1050		

Note: Tolerance ranges $\pm 3\%$ for mass, excluding maximum total mass.

9. Vehicle Specifications



Overview Parameters

Item	11A5A1	11A5B1	Unit
Number of Occupants	5		Persons
Minimum turning diameter	≤10.7		m
Maximum Speed	170		km/h
Maximum Gradient	≥30		%
Range	420	408	km
Charging time	Supercharge	≥35	min
	Charge	≥5.5	h

Note: The charging time is the time taken to charge the power battery from 30% to 80% at an ambient temperature of 25°C.

Steering Gear

Item	Parameter		Unit
Type	Electric power steering (EPS-C)		/
Maximum steering angle of front wheels (inside/outside)	Interior	36.45±5	°
	Exterior	31.06±5	°



9. Vehicle Specifications

Parameters of the Powertrain

Item		11A5A1	11A5B1	Unit
Type of Drive		Front engine and front-wheel drive layout		/
Rated Voltage		381		V
Traction battery	Rated Capacity	174		Ah
	Rated Energy	66.2		kWh
	Mass	388		kg
Drive motor	Rated Power	68		kW
	Rated Torque	144		N.m
	Rated Speed	4500		rpm
	Peak Power	145		kW
	Peak torque	300		N.m
	Peak Speed	12000		rpm
Final Drive	Model	BW31-03/1T25K1		/
	Number of Gears	1		/
	Final Drive Ratio	8.28		/

9. Vehicle Specifications



Suspensions

Front suspension type:	MacPherson independent suspension
Rear suspension type:	Semi-independent suspension of torsion beam

Braking System

Item		Parameter	Unit
Type		Hydraulic braking	/
Type of assist		Vacuum assistance	/
Brake pedal	Travel	60 (power-on with assisted power)	mm
		35 (power-off without assisted power)	
Free travel		10~15	mm
Wear limit of brake pad for front wheel (excluding the backing plate for brake pad)		1.7	mm
Wear limit of brake pad for rear wheel (excluding the backing plate for brake pad)		2	mm
Parking brake		Electronic Parking Brake (EPB)	/
Brake liquid replacement period		24 months or 40,000 km (whichever is earlier)	



9. Vehicle Specifications

Oil/Fluid Filling Volume

Name	Model	Filling volume
Transmission gear oil	DEXRON VI	1.4 L
Traction Battery coolant	Ethylene glycol aqueous solution (with different freezing points depending on the minimum temperature at your location)	6.48±0.5 L
Motor coolant	Ethylene glycol aqueous solution (with different freezing points depending on the minimum temperature at your location)	3.37±0.5 L
AC refrigerant	R1234FY	525±10 g
Brake fluid	DOT-4	0.6 L
Windshield washer liquid	TEEC-40°C	1.5 L
Coolant for air conditioning system	Ethylene glycol aqueous solution (with different freezing points depending on the minimum temperature at your location)	1.9±0.5 L

Four-Wheel Alignment Parameters

Item	Value
Front wheel camber angle	0°±30'
Kingpin inclination angle	12°38'±1°
Kingpin caster angle	5°±1°
Rear wheel camber angle	-1°30'±45'
Front wheel toe-in	6'±6'
Rear wheel toe-in	14'±14'

9. Vehicle Specifications



Tire

Item		11A5A1	11A5B1	Unit
Specifications		215/55 R17	215/50 R18	/
Pressure	Front tire	250	250	kPa
	Rear tire	250	250	
Rims	Rims	17×7J	18×7J	/
Wheel dynamic balancing	Front tires interior	≤ 8	≤ 8	g
	Front tires exterior	≤ 8	≤ 8	
	Rear tires interior	≤ 8	≤ 8	
	Rear tires exterior	≤ 8	≤ 8	



9. Vehicle Specifications

Microwave Window

The preferred microwave window is on the front windshield, as shown in the illustration. Please keep the front windshield clean so as to ensure the best results and minimize interference with the driving view.

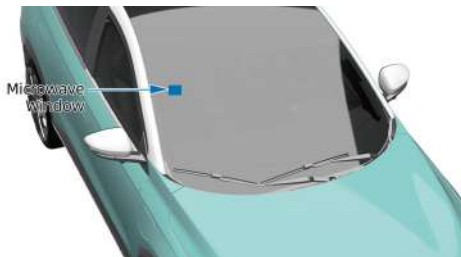

Warning

- The location of the microwave window shall not be shielded.
- The necessary markings required by traffic regulations shall be pasted around the microwave window.

Event Data Recorder (EDR)

This vehicle is equipped with an event data recorder (EDR).

The EDR can automatically record information on vehicle operation and vehicle safety system status for a period of time before and after a vehicle event, such as.

- Speed
- Brake pedal switch ON/OFF
- VIN
- Longitudinal acceleration

By collecting and analyzing the vehicle status data recorded by the EDR, it can help to understand the situation before and after the event.

Data Use Statement

The data recorded by EDR may be used by XPENG for troubleshooting, product development, and quality improvement. XPENG will not disclose data from EDR to third parties except for the following.

- Consent from the owner.
- Compliance with the requirements of the administrative and judicial authorities.
- The requirements of laws and regulations.

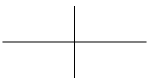
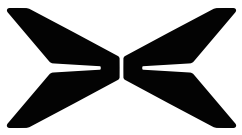

NO.202210U01