Contents	1
General Information	11
Precautions	11
General Precautions.....	11
Hazardous substances.....	11
Synthetic rubber	11
Lubricants.....	11
Preventive measures.....	11
Safety Precautions	11
Lift.....	11
Hydraulic braking system	11
Covers and plugs of cooling system.....	12
Environmental Precautions	12
Overview	12
Discharge into the atmosphere	12
Electrical Precautions.....	13
Overview	13
Equipment	13
Polarity	13
Check of the circuit.....	13
Plug and harness	13
Disconnection of the battery	13
Charging of the battery.....	13
Rules	13
Lubrication of electrical plugs.....	13
Safety guidance for high-voltage operation.....	13
High-voltage maintenance.....	13
Warning labels.....	14
protective measures	14
System Description	15
Network integrity check	15
Integrity check of high-speed CAN network (powertrain).....	15
Description of diagnosis process.....	16
Description of diagnosis procedures	16
Description of fault diagnosis codes.....	16
General checks	16
Detection tools.....	16
Possible causes of fault.....	16
Description of circuit diagram	16
Troubleshooting procedures.....	16
Diagnostic system check - vehicles.....	16
Diagnostic system check.....	17
Basic method for line detection	17
High voltage maintenance operation requirements.....	22
Notes for high voltage maintenance:.....	23
High voltage discharge operation of the control module:	24

Contents

Insulation resistance measurement.....	24
Insulation resistance measurement example: driving motor insulation resistance measurement. ...	25
ESC	27
DTC Summary List (ESC)	27
C0031-08、 C00A0-00、 C0032-00、 C00A1-00	29
C0034-08、 C00A2-00、 C0035-00、 C00A3-00	34
C0037-08、 C00A4-00、 C0038-00、 C00A5-00	39
C003A-08、 C00A6-00、 C003B-00、 C00A7-00.....	44
C0020-04、 C006B-06、 C1099-04	49
C1212-08、 C1020-01、 C1010-08.....	54
C0045-10、 C0044-60、 C00A8-00、 C00A9-00、 C00AA-00、 C00AB-00、 C00AC-00、 C0196-04、 C1000-04、 C0040-08、 C0061-08、 C0062-08、 C0063-08、 C0072-04.....	59
C1900-04、 C1901-04.....	65
C104C-04.....	70
U0001-04、 U0126-87、 U0104-04、 U0140-87、 U0155-87、 U0164-00、 U0422-81、 U0423-81、 U0428-81、 U0104-08、 U0401-81、 U0164-08、 U0007-00、 U0005-00、 C1001-04、 U0100-87	75
BCM	81
DTC Summary list(BCM)	81
U3003-16、 U3003-17.....	84
U1001-11、 U1F62-87、 U1F63-87	89
U0073-88.....	94
U0073-87	98
U0121-87	102
U0155-87	106
U0151-87	110
U0101-87	114
U0152-87	118
U0153-87	122
U0154-87	126
B1001-11、 B1002-12、	130
B1003-13、 B1003-11	137
B1004-13、 B1004-11	142
B1005-13、 B1005-11	147
B1006-13、 B1006-12	152
B1007-13、 B1007-11、 B1008-13、 B1008-11	158
B1009-13、 B1009-12	163
B100A-13、 B100A-12	168
B100C-12.....	174
B100D-12.....	179
B100E-12.....	184
B1010-12	189
B1011-12	195
B1012-12、 B1013-12、 B1014-1E、 B1014-12.....	202
B1500-13、 B1502-55	209
B1506-87、 B1506-62、 B1501-29、 B162F-42、 B1022-04.....	214

B1507-08、 U0423-62、 U0424-62	216
U1532-00、 U1533-00、 U1534-00、 U1535-00、 U1536-00	220
U1537-00、 U1538-00、 U1539-00、 U153A-00、 U153B-00、 U153C-00.....	225
B1401-77.....	230
B1205-94.....	235
B1162-11、 B1162-13、 B1162-1E	240
U0156-87.....	246
B1166-11、 B1167-11、 B1168-12.....	250
B1169-11、 B1169-13、 B1120-1E	256
B1206-94.....	262
B1170-11、 B1170-12、 B1175-11、 B1175-12	267
B1172-1E	273
B1173-11、 B1173-1E	281
B1176-11、 B1176-12.....	286
AVAS	291
DTC Summary List (AVAS)	291
U1562-17、 U1563-16	292
B1570-31.....	297
U0294-87、 U0121-87、 U0073-88.....	302
BMS(CN)	307
DTC Summary list(BMS)	307
Notes for high voltage maintenance:.....	307
P0561-00.....	312
P0562-F1、 P0563-F1	316
P0A0A-00、 P0A0B-00、 P0A0C-00、 P0A0D-00.....	321
P0A7D-F0、 P0A80-F0、 P0C30-F0、 P1DF6-F0、 P1DF6-F1.....	326
P0AA1-00、 P0AA2-00、 P0ADB-00、 P0ADC-00、 P0AD9-00、 P0ADA-00	329
P0AA4-00、 P0AA5-00、 P0ADF-00、 P0AE0-00、 P0ADD-00、 P0ADE-00.....	333
P0AA6-F1、 P0AA6-F0、 P0AA7-00、 P0AA8-F0、 P0AA8-F1、 P0AA9-00.....	337
P0AC1-00、 P0AC3-00、 P0AC4-00.....	342
P0AE3-00、 P1B0A-F0、 P1B0A-F1、 P1B09-F0、 P0AE6-F0、 P0AE6-F1、 P0AE6-F2、 P0AE7-00、 P1B09-F1.....	346
P0AF7-00、 P0AFA-F0、 P0AFB-F0.....	351
P0D94-00	357
P0DAD-00、 P0DCA-00、 P0DE6-F0、 P0DE6-F1、 P0DE6-F2、 P0DE6-F3、 P0DE7-F0、 P0DE7-F1、 P0DE7-F2、 P0DE7-F3、 P1B02-00、 P1B11-F0、 C0111-96、 C0112-96、 P1B11-F1、 C1001-04、 P1E00-F0、 P1B44-00、 P1B48-00.....	362
P1B19-00	368
P1B2E-00.....	373
P1B37-00、 P1B38-00、 P1B51-00	377
P1B43-00	381
P1D45-F0、 P1D45-F1、 P1D45-F2、 P1E01-F0、 P1E01-F1、 P1E01-F2、 P1E02-F0、 P1E03-F0 385	
P1DF3-F1、 P1DF3-F0.....	389
P1DF2-F1.....	397
P1DF7-00、 P1DF7-F0、 P1DF7-F1、 P1DF7-F2、 P1DF8-F0、 P1DF8-F1、 P1DF8-F2、 P1DF9-F0、 P1DF9-F1、 P1DF9-F2.....	405

Contents

U1007-00、 U0073-87、 U0074-88、 U0111-87、 U0112-87、 U1001-00、 U1009-00、 U1013-00	410
P1B23-00、 P1B1F-F0、 P1B1F-F1、 P1B1F-F2、 P1B20-00.....	417
P1B25-F0、 P1B25-F1、 P1B25-F2、 P1B24-00.....	423
CDU	429
DTC Summary list(CDU)	429
Notes for high voltage maintenance:	429
P0D27-00、 P0D28-00、 P0D2A-00.....	432
P0D28-F0、 P0D27-F0.....	438
P1F0A-F0、 P0D21-F0、 P1F0C-00、 P1F10-00	442
P1F20-00、 P1F21-00、 P1F22-00.....	447
P1F23-00、 P1F24-00.....	452
P1F25-00、 P1F26-00、 P1F27-00.....	456
P0E57-00、 P1AE3-16、 P1AE5-00	461
P1AD1-17、 P1AD0-16、 P0D33-00、 P1AD2-12	466
P0562-F0、 P1F28-00、 P0562-00、 P0563-00.....	471
P1F01-00	476
P1F02-00	480
P1F1C-00.....	484
P1F03-00	488
P1F04-00	492
P1F12-00	496
P1F13-00	500
P1AE0-00.....	504
P1AE1-00.....	508
P1F06-00	512
P1F14-00	516
P1F15-00	520
P1F05-00	524
P1F07-00、 P1F08-00、 P1F06-F0、 P0EA6-F0	528
P1F0D-00.....	534
P1F16-00	537
P1F17-00	542
P1F18-00	547
P1F19-00	552
P1F1A-00、 P1F1E-00	557
P1F1B-00.....	562
P1F1D-00.....	567
P1F09-00、 P1F11-00、 U0111-87、 U0294-87、 U0073-88.....	571
P1F0E-00.....	578
EPS	583
DTC Summary list (EPS)	583
U3003-17、 U3003-16.....	585
C1624-16、 C1624-17.....	590
C1614-4B、 C1668-00	595
C1BAC-00、 C1608-49、 C1606-96	598

C1606-97.....	601
C1BC0-02.....	604
C1604-96、 C1604-96、 C1604-96、 C1604-96、 C1604-96	607
C0051-29、 C0051-29、 C0051-29、 C0051-29、 C0051-29、 C0051-54	610
C1B8F-4B.....	613
C1BB1-55.....	616
C1606-54.....	619
C1608-97.....	622
C1608-00.....	625
C1606-00.....	628
C1608-12.....	631
U0073-88、 U1261-87、 U1261-81、 U1262-87、 U1262-81	634
U1269-87、 U1269-81、 U1269-83、 U1269-82.....	638
FICM	643
DTC Summary List (FICM) - left	643
U1562-17、 U1563-16	645
U2020-47.....	649
U1500-00.....	653
B1A1D-87.....	656
U0100-87.....	661
U0127-87.....	666
U0073-88.....	671
U010F-87	676
U0155-87.....	681
U0140-87.....	686
U0126-87.....	691
U1031-87.....	696
U0121-87.....	701
U0101-87.....	706
B1A10-12、 B1A10-11、 B1A10-13、 B1A10-19.....	711
U0237-87.....	715
U0236-87.....	720
B1A20-11、 B1A20-12、 B1A20-1A、 B1A20-1B.....	725
B1A21-11、 B1A21-12、 B1A21-1A、 B1A21-1B	730
B1A22-11、 B1A22-12、 B1A22-1A、 B1A22-1B.....	735
B1A23-11、 B1A23-12、 B1A23-1A、 B1A23-1B	740
B1A27-01	745
B1A24-01	749
B1A26-01	756
B1A25-12、 B1A25-11、 B1A25-13、 B1A28-12、 B1A28-11、 B1A28-13.....	763
B1A4E-71、 B1A50-11、 B1A4C-71、 B1A4D-71 、 B1A39-71、 B1A3A-71.....	769
B1AA0-12、 B1AA0-11、 B1A50-15.....	774
B1A3E-71、 B1A3F-71、 B1A01-71、 B1A02-71、 B1A05-71、 B1A06-71、 B1A07-71、 B1A08-71、 B1A4B-71	780
B1AE4-12、 B1AE9-12、 B1AE9-11	787
DTC Summary List (FICM)-Right	793

Contents

B1117-16、 B1117-17	794
U0073-88	798
B13B7-11	803
B13B9-11、 B13B9-14	807
B1A1B-87	813
B1A1A-87	818
U0140-87	823
U0141-87	828
U0254-87	833
U0255-87	838
U0257-87	843
U0266-87	848
U0267-87	853
GWM	859
DTC Summary list (GWM)	859
U1562-17、 U1563-16	860
U0073-88	865
U0074-88	869
U0075-88	873
U0076-88	877
U0140-87	881
U0100-87	885
U0101-87	889
U0155-87	893
U0151-87	897
U0116-87	901
U0118-87	905
U0119-87	909
U0125-87	913
U0126-87	917
U0132-87	921
U0133-87	925
U2001-41、 U2002-42、 B162F-42	929
HCM	935
DTC Summary List (HCM)	935
B1602-1C	936
B1603-1C	941
B1604-1C	947
B1606-1C	954
B1608-1C、 B1611-1C	961
B1612-1C、 B1613-1C、 B1614-1C	966
U3003-17、 U3003-16	970
U0120-87	975
U0155-87	979
U0315-87	983
U0140-87	987

U0073-88.....	991
IPK	995
DTC Summary list (IPK)	995
0x9117-16、 0x9117-17	996
0xC140-87	1001
0xC122-87	1005
0xC123-87	1009
0xC127-87	1013
0xC126-87	1017
0xC073-87	1021
0xD005-87	1025
0xC210-00	1029
0xC132-87	1033
0xC136-87	1037
0xC137-87	1041
0xC138-87	1045
PEU	1049
DTC Summary list(PEU)	1049
Notes for high voltage maintenance:.....	1049
P0A44-37	1052
P0C79-F0、 P1A60-16、 P0C79-17.....	1056
P0C01-F0、 P0C01-19	1060
P0563-A3、 P0562-A2	1064
P0A3C-F0.....	1069
P0A2F-98	1072
U0073-88、 U0293-87、 U0111-87	1075
P0BFD-00.....	1079
P0BE6-1C	1083
P0AEE-1C、 P0A2B-1C、 P0A2F-F0、 P0AEE-F0	1087
P0D2E-1C	1090
P0A3F-01	1094
P1A69-22、 P1AB4-63	1100
P0A3C-98.....	1104
P1ABF-05.....	1107
P1A7B-98.....	1110
P0C17-54	1113
P0C79-A3、 P1A60-F0	1119
P0A44-F0、 P0A44-F1、 P1A92-F0.....	1123
P1AF0-00	1127
SRS	1131
DTC Summary list (SRS)	1131
U0073-88.....	1134
U0153-87.....	1138
U0154-87.....	1142
U0155-87.....	1146

Contents

U0156-87	1150
U1562-17、 U1563-16	1154
B0001-11、 B0001-12、 B0001-1A、 B0001-1B、 B0001-56	1158
B0010-11、 B0010-12、 B0010-1A、 B0010-1B、 B0010-56	1163
B0090-49、 B0090-87、 B0090-86、 B0091-56、	1168
B0095-49、 B0095-87、 B0095-86、 B0095-56	1173
B0091-49、 B0091-87、 B0091-86、 B0091-56	1178
B0096-49、 B0096-87、 B0096-86、 B0096-56	1183
B193A-14、 B193A-12	1188
B0020-11、 B0020-12、 B0020-1A、 B0020-1B、 B0020-56	1192
B0028-11、 B0028-12、 B0028-1A、 B0028-1B、 B0028-56	1197
B0021-11、 B0021-12、 B0021-1A、 B0021-1B、 B0021-56	1202
B0029-11、 B0029-12、 B0029-1A、 B0029-1B、 B0029-56	1207
B0050-12	1212
B0052-12	1217
B0053-12	1222
B0054-12	1227
B0055-12	1232
B193F-49、 B193F-09、 B193F-96、 B193F-00、 B193F-00	1237
SCU	1241
DTC Summary list (SCU)	1241
B1117-17、 B1117-16	1242
P1002-1C	1247
U2001-42	1252
U0151-87	1257
U0101-00	1261
U0073-00	1265
TIM	1269
DTC Summary list (TIM)	1269
U1562-17、 U1563-16	1270
U0073-88	1274
U0140-87	1278
B100D-11	1282
B100E-11	1287
B1002-11	1292
B1001-11	1297
B1007-11	1302
B1006-11	1307
B1000-11	1312
EVCC	1317
DTC Summary list (EVCC)	1317
P1FF0、 P1FF1、 P1FF8	1318
P1FF2、 P1FF3、 P1FF5	1323
P1FF4、 P1FF6	1327
P1FF7、 U2003、 U2000	1331

U1563、 U1562.....	1335
U0078、 U1111.....	1340
VCU	1345
DTC Summary list(VCU)	1345
P0641-00、 P0651-00、 P0697-00.....	1348
P0563-00、 P0562-00.....	1353
P057D-00、 P057C-00、 P057B-00、 P0571-00.....	1358
P0558-00、 P0557-00、 P0556-00、 P1C70-00.....	1366
P258D-00、 P258C-00、 P258A-00.....	1371
P2123-00、 P2122-00、 P2128-00、 P2127-00、 P2135-00、 P2136-00、 P2138-00.....	1377
P1C00-00、 P1C01-00、 P1C03-00.....	1385
P0692-00、 P0691-00、 P0480-00.....	1391
P0A07-00、 P0A06-00、 P0A05-00.....	1397
P1C10-00、 P1C11-00、 P1C12-00、 P1C13-00.....	1403
P0687-00、 P0686-00、 P0688-00.....	1409
P1C2000、 P1C2100.....	1413
U0121-87、 U0151-87、 U0140-87、 U0298-87、 U0291-87、 U0110-87、 U0111-87、 U019B-87、 U1113-87、 U0164-87、 U0155-87、 U0073-88、 U0074-88.....	1416
P1C97-00.....	1422
P1CB1-00.....	1427
P1C22-00、 P1CB2-00.....	1430
P1CB3-00、 P1CB5-00、 P1CB6-00、 P1CB7-00.....	1433
P1CB8-00.....	1436
P1CB9-00.....	1439
P1CC0-00.....	1442
P1CC1-00.....	1445
P1CC2-00、 P1CC3-00.....	1448
P1CC4-00、 P1CC5-00、 P1CC6-00、 P1CEA-00.....	1451
P1CC7-00、 P1CC8-00、 P1CC9-00.....	1454
P1CE0-00、 P1CE1-00.....	1457
P1CE5-00、 P1CE6-00、 P1CE9-00.....	1460

Precautions

General Precautions

Hazardous substances

Modern vehicles involve a lot of materials and liquids, and if they are not handled properly, the human body and the environment may be endangered.

Warning: *Many liquids and other substances used on modern vehicles are toxic and cannot be broken down in any case. Therefore, they must be kept as far away from the skin as possible. These liquids and substances include acids, antifreezes, asbestos, brake fluids, fuels, windshield washer fluid additives, lubricants, refrigerants and all kinds of adhesives.*

Warning: *It is necessary to carefully read the instructions printed on the labels and posted on the parts and implement strictly. These instructions contain information that is useful for health and safety of individuals. This information must not be overlooked.*

Synthetic rubber

Many O-rings, seals, hoses, elastic pipes and other similar items appear to be made of natural rubber, but in fact of a synthetic rubber called fluorine rubber. These substances are safe and will not cause injury under normal use conditions. However, when destroyed by burning or high temperatures, these substances may be broken down, and produce a highly corrosive fluorinated acid.

When exposed to the skin, these fluorinated acids may cause severe burns. If they are exposed to the skin accidentally, the following measures should be taken:

- Quickly remove the contaminated clothing.
- Rinse the damaged skin with plenty of cold water or lime water for 15-60 minutes.
- Seek immediate medical assistance.

If the substance is burning or overheated, it must be handled with care, wearing protective clothing (seamless industrial gloves, protective aprons, etc.).

The gloves should be cleaned and handled immediately after use.

Lubricants

Avoid excessive exposure to the used lubricants, and strictly follow health-related protective measures.

Warning: *Avoid excessive skin contact with the used engine oil. The used engine oil may contain toxic contaminants that may cause skin cancer or other severe skin inflammation.*

Warning: *Avoid excessive skin contact with mineral oil. The mineral oil may take away the natural fat on the skin, leading to dry skin, pain and dermatitis.*

Preventive measures

Attention should be paid to the following measures at any time:

- Wear protective clothing if the conditions permit, including sealed gloves.
- Avoid prolonged and repeated exposure to the engine oil, especially the used engine oil.
- Do not put the rags stained with engine oil in the pockets.
- Avoid the clothes being contaminated by the engine oil (especially the intimates).
- Fully clean the clothes on a regular basis. Properly dispose of the contaminated clothing and stained shoes.
- Deal with open wounds in the first place.
- Use protective cream before work every time to avoid the skin being contaminated by the engine oil.
- Wash the skin with soap and water to ensure that the engine oil is cleaned up (any skin cleanser and nail brush will be useful).
- Apply moisturizer after washing. Prepare some lanolin, so that it can be used to make up for the loss of natural oil on the skin after washing.
- Do not wash the skin with petroleum/gasoline, kerosene, diesel, engine oil, thinner or solvent.
- Remove the oil stain before handling the parts if possible.
- If the skin is damaged accidentally, find a doctor immediately and deal with it as advised by the doctor.
- If the operation may cause harm to the eye, wear protective glasses (e.g. goggles or masks). Arrange the eye cleaning device adjacent to the work area.

Safety Precautions

Lift

Caution: *It is advised to use a lift when working at the bottom of the vehicle. Use wedges to fix the wheel and use the parking brake.*

Always use the recommended lifting point.

Ensure that the lift has sufficient weight-bearing capacity.

Ensure that the lift is in the horizontal position upon lifting or supporting.

Use the handbrake and wedges to fix the wheel.

Warning: *Do not work under a vehicle that is simply supported by a jack. Support the vehicle on a secure support.*

Do not leave tools, lifting equipment, spilled oil, etc. in the work area or around it. Keep the work area clean and tidy.

Hydraulic braking system

Hydraulic braking system: The following steps should be followed when operating on the braking system:

General Information

- Use two wrenches to loosen or tighten the brake pipe or pipe plug.
- Ensure that the hose is bent naturally without distortion.
- Secure the brake pipe with a clamp to ensure that the pipe will not come into contact with potential wear.
- Keep the brake fluid containers clean.
- Do not put the brake fluid in an unsealed container, otherwise it may absorb the moisture in the air to reduce the ignition point, and thus easily cause danger during use.
- Do not allow mineral oil to contaminate the brake fluid, or put the unused brake fluid in a container that has been filled with mineral oil.
- Do not use the brake fluid removed from the system.
- Always use clean brake fluid or recommended substitutes to clean the hydraulic parts.
- After the brake pipe and hose are disconnected, install appropriate end cover or plug immediately to prevent ingress of dust.
- Use properly threaded brake plugs only.
- When dealing with the hydraulic parts, keep them absolutely clean.

Covers and plugs of cooling system

When the engine still has waste heat, especially when it is overheated, special care must be taken if the cover of expansion tank, cooling fluid discharge pipe or vent screw is to be removed. To avoid possible burns, the engine should be removed after cooling.

Environmental Precautions

Overview

The information provided in this chapter helps to reduce the impact of shop work on the environment.

Discharge into the atmosphere

Harmful gases and smogs may be discharged from a lot of work in the workshop, causing global warming, thinner ozone layer and/or presence of photochemical smogs on the ground. Therefore, it is required to study the working mode in the workshop, so as to control the output of gases and smogs to the minimum, and reduce the impact on the environment.

Exhaust

The operation of automotive engine is an indispensable part of the shop work and should be conducted in a ventilated environment. However, it is required to carefully consider operation time of the engine and parking position of the vehicle at any time in order to control the output of harmful gases, and reduce the inconvenience caused to life of the surrounding residents.

Solvents

Some cleaners we use are solvents, and in case of improper use or poorly sealed container, the liquid component may evaporate into the air. The solvent containers should be stored in a sealed state if not in use, and the solvents should be used in an appropriate amount. Suitable substitutes can be used to replace some common solvents. Similarly, many paints are also solvents, a minimum amount of which should therefore be used as appropriate upon spraying in order to reduce volatilization of the solvent.

Refrigerant

To discharge or replace the refrigerant in the air conditioning system, appropriate equipment must be used.

Engine

Always follow the following steps:

- Reduce unnecessary operation of the engine.
- Reduce the number of tests and check the discharge location of flue gas.

Thinner

- Cover the solvent vessels.
- Minimize the usage.
- Consider using other material to replace it.
- Reduce liquid splash during painting.

Gas

- Use appropriate equipment to collect the refrigerant.
- Do not burn the waste on the spot.

Electrical Precautions

Overview

The following instructions are intended to guarantee safety of the operator, and also prevent the electrical and electronic elements on the vehicle from being damaged. If necessary, refer to the specific precautions in this manual.

Equipment

Before testing of the vehicle, ensure that relevant test equipment is operating normally and that the harnesses or plugs are in good condition. Especially, check wires and plugs of the operating equipment.

Polarity

Do not reverse polarity of the battery, and always ensure correct polarity upon testing.

Check of the circuit

Use insulated pliers to disconnect the live circuit, and do not allow exposed wires to come into contact with any part, especially the engine control module.

Plug and harness

For electrical parts and plugs, the engine compartment is a very harsh operating environment:

- Before disconnecting and connecting the test equipment, ensure that the electrical parts are dry and oil free.
- Ensure that the disconnected multiple plugs and sensors are not stained with oil, cooling fluid or other solutions. Contamination may impair the working performance or cause catastrophic fault.
- Do not forcibly separate the plug using a tool or by pulling the harness.
- Ensure that the locking mechanism is unlocked and in the correct position for reconnection before disconnecting the plug.
- Ensure that all protective devices (covers, insulating materials, etc.) are in good condition and, once damaged, replace them immediately.

If the component is subject to fault:

- Turn off the ignition switch and disconnect negative terminal of the battery.
- Remove the component and secure the disconnected harness.
- Keep the greasy hands away from the electrical connection area when replacing the component. Push the plug in place until it is locked.

Disconnection of the battery

Turn off the alarm system and all electrical equipment before disconnecting the battery.

Caution: To avoid damage to the electrical elements, it is required to disconnect the battery when operating on electrical system of the vehicle. First disconnect it and finally connect to the grounding stud.

Caution: Ensure that the battery wire is connected correctly, without potential hazard.

Charging of the battery

Always ensure that the battery charging area is well ventilated, especially note to keep away from open flames and sparks.

Rules

Turn off the ignition system, and then reconnect or disconnect other systems in order to prevent damage to the electronic elements due to the surge caused by disconnection of the "live" connection.

Ensure that the hands and machined surfaces are clean and free of oil, swarf, etc. Grease and dust may cause leakage (short circuit) or open circuit.

The plugs cannot be removed or installed forcibly, especially internal plugs. The damaged circuit may cause short circuit and open circuit.

Contact the vehicle body to release the static electricity before the test and upon the staged test. The static electricity on the operator may cause damage to some electronic elements.

When dealing with printed circuit boards, it is only allowed to carefully hold edges of the printed circuit board; it is important to note that some electronic elements are susceptible to the static electricity of human body.

Lubrication of electrical plugs

During production of the vehicle, some plugs under the hood and body are coated with a special grease to prevent corrosion. If they may be damaged during maintenance, repair or replacement, they should be reapplied with such grease.

Safety guidance for high-voltage operation

High-voltage maintenance

Warning: Electrical work is prohibited during the maintenance of electric vehicles. The normal operation process is as follows:

- 1 Turn the key switch OFF
- 2 Disconnect the negative cable of the low voltage battery
- 3 Wear insulation protection tools, such as insulation gloves, shoves and goggles.
- 4 Lift the vehicle.
- 5 Disconnect the low voltage control plug of driving battery, and then disconnect the total negative and total positive connecting cables of the power battery successively.

General Information

- 6 If the power battery has a maintenance switch, remove the maintenance switch first and then disconnect the power battery wiring harness.
- 7 Check and discharge the disconnected high-voltage cable using a tool. Ensure that there is no power before performing any other operations.
- 8 Wear insulation tools and wrap the high voltage connection terminals of power batteries with insulation tape to prevent them from being touched during maintenance.

Caution: *During maintenance, wrap the female end of high voltage parts with insulation tape to prevent high voltage electric shock or short circuit.*

Caution: *Must wear high voltage insulation groves during maintenance.*

Caution: *It is forbidden to work high voltage components on line.*

Caution: *All high voltage wires on the vehicle are orange.*

Warning labels

The upper parts of the high voltage will have the label in diagram.

protective measures

- Anti high voltage gloves

Insulated rubber gloves for electrical work

- Safety eye shield

Anti alkaline type, prevent electrolyte overflow

- High voltage insulating shoes

It is mainly used as an auxiliary safety appliance in electrical operation of high voltage power equipment, and can be used as a basic safety appliance at the port below 1kV.

- Fire extinguisher

Batteries use carbon dioxide fire extinguishers.

It is possible to use small amounts of water to extinguish a fire, but it is possible to use large amounts and continuously.

- Absorbent towel

After the overflow of electrolyte is neutralized, an absorbent towel is used to absorb the excess electrolyte.

- Rubberized fabric

Use insulation tape to cover all high voltage wires or terminals.

After the plug is removed, cover the plug slot with insulation tape.

- Maintenance work table

Caution: *A working table with an insulating rubber cover must be used*

Make sure that you have a clear understanding of all basic maintenance safety procedures and that you wear appropriate clothing and use safe equipment. When performing any maintenance task, special attention should be paid to the following:

Before maintenance begins, read all operation instruments and verify that you have the appropriate tools, parts for replacement or repair, and the skills required to perform the task safely and comprehensively.

In hammering, drilling, grinding or working around the pressurized air or liquids and springs or other components, you always wear appropriate protective eye -wear, goggles or eye shields. You should also wear eye protection if other repairs can cause eye injuries.

If necessary, use other protective equipment, such as gloves or safety shoes.

Pay attention to the safety of yourself and others when lifting a vehicle. When using a lift machine or jack to lift a vehicle, ensure the vehicle is safety supported. Be sure to use jack supports.

When welding, be sure to wear an approved welding helmet, gloves and safety boots to protect yourself.

When painting, wear an approved protection mask, goggles to avoid exposure to paint and harmful chemicals. Spray paint only in a well-ventilated oven.

System Description

If the circuit is tested to be normal, replace the control module.

Network integrity check

Integrity check of high-speed CAN network (powertrain)

Note: Please confirm the following:

- Control module and local Internet device equipped for the vehicle.
 - Position of the control module on serial data circuit of the high-speed CAN (powertrain).
 - Control module B+, ignition, grounding, communication enabling and serial data circuit terminals.
- 1 Confirm that there is no fault diagnosis code between other modules before diagnosis. In case of any fault diagnosis code, make diagnosis for it first.
 - 2 Set the ignition switch to the OFF position and disconnect the wire to negative terminal of the battery.
 - 3 Test the resistance between the diagnostic interface terminals PT-CAN H (6) and PT-CAN L (14) according to the following conditions;
 - Condition A: Measure the resistance when all plugs are connected, and check whether it is $60\pm 5\Omega$.
 - Condition B: Measure the resistance when the plug of terminating resistor is not disconnected, and check whether it is $120\pm 5\Omega$.
 - Condition C: Measure the resistance when the plug of terminating resistor is disconnected, and check whether it is infinite.
 - 4 If the above resistance values do not comply with the standard ones, disconnect the harness plug on the control modules that cannot communicate.
 - 5 Test whether the resistance between the grounding circuit terminal of each control module and the ground is less than 10Ω .
If it is beyond the specified value range, test whether the grounding circuit is open or the resistance is too large.
 - 6 Connect the wire to the negative terminal of the battery, set the ignition switch to the ON position, and confirm that the test lamp between the B + circuit terminal and the ground of each control module is on or use the multimeter to directly measure the B + circuit terminal voltage.
If the test lamp is not on, test whether B+ circuit is shorted to ground or open or the resistance is too large.
If the voltage is lower or higher than the battery voltage, test whether B+ circuit is shorted to ground or open or the resistance is too large.
If the circuit fuse is blown, test whether the control circuit of the control module is shorted to ground.

Description of diagnosis process

- 1 Understand and confirm the problem reported by the customer: The first part of this step is to understand the customer's conditions as much as possible. Ask the customer about the working conditions when the fault occurs and the occurrence frequency, as well as the maintenance history. To confirm the problem reported by the customer, the technical staff must be familiar with the normal working conditions of the system.
- 2 The vehicle driving conditions meet the design requirements: It is the case during normal operation of the vehicle. The situation described by the customer may be normal. Compare it with a similar vehicle in normal operation under the same conditions as described by the customer. Explain to the customer the findings and operation of the system.
- 3 Preliminary check: Conduct comprehensive visual inspection. Check the maintenance history. Detect whether there is any abnormal sound or smell. Collect the fault diagnosis code information for effective repair.
- 4 Perform diagnostic system check - vehicles to confirm whether the system is working normally. This will allow the technical staff to make a systematic diagnosis scheme and determine what type of diagnosis to perform. Refer to the "diagnostic system check - vehicles".
- 5 Check and refer to relevant technical service information.
- 6 Diagnosis type:
 - a Current fault diagnosis code: Make diagnosis according to the specified fault diagnosis code for effective repair. Refer to the "Summary List of Diagnostic Trouble Codes (DTC)".
 - b Symptom - No fault diagnosis code: Select the appropriate symptom diagnosis procedures.
 - c Intermittent fault diagnosis code: Intermittent fault is a fault that is discontinuous and hard to reproduce and occurs only if the conditions are met. Generally, intermittent faults are caused by fault of electrical plugs, harnesses and components, electromagnetic/radio frequency interference, driving conditions or aftermarket equipment.
- 7 Find root cause of the fault, repair it and test the repair conditions: find the root cause of the fault, repair it and test whether it is correct. Confirm that the fault diagnosis code or symptom has been eliminated, which may require road test of the vehicle.
- 8 Recheck the problem reported by the customer: Recheck it if the technical staff fails to find crux of the problem. Reconfirm the problem reported by the customer. The problem may be an intermittent fault, or a normal case.
- 9 Confirm that the problem reported by the customer has been solved, and clear relevant fault code.

Description of diagnosis procedures

Below is a brief description of the steps included in the diagnosis procedures.

Description of fault diagnosis codes

Describe the fault diagnosis codes diagnosed in this step. If appropriate, write out the number of fault diagnosis code with symptom description and the fault description.

General checks

Describe the general checks before diagnosis, including the following information:

- Check of battery voltage;
- Check of vehicle fuse;
- Check of all plugs of the vehicle for looseness or terminals for corrosion;
- Check of vehicle for intermittent fault.

Detection tools

Detection tools to be used in the diagnosis procedures.

Possible causes of fault

The possible causes of fault is to list all the factors that cause the fault diagnosis code, so that the technical staff can narrow the maintenance range during maintenance to repair the vehicle quickly and effectively.

Description of circuit diagram

The description of circuit diagram determines how the circuit work normally.

Troubleshooting procedures

The troubleshooting procedures are to be implemented step-by-step in positively numbered test sequence, which allows the technical staff to implement the test procedures in sequence until a fault is detected. If satisfactory result is achieved for the numbered test procedure, it is allowed to proceed to the next numbered test procedure according to the normal flow. If not, the inspection and maintenance opinions after the test will determine what action to take.

Diagnostic system check - vehicles

The implementation of the diagnosis procedures in this manual is based on the assumption that the following aspects of functions meet the design provisions.

- The 12V battery is fully charged, and the cable is clean and secure.
- The fuse is not blown.
- The grounding circuit in the area reported by the customer is clean, secure and in the correct position.
- All connections/harness plugs in the fault area are fully in place.

- There is no aftermarket equipment that may affect operation of the system.
- The fault diagnosis instrument is powered on.

Diagnostic system check

- 1 Confirm the problem reported by the customer - Understand and confirm the problem reported by the customer. Check the visible system parts for obvious damage or fault that causes the fault.
- 2 Check the maintenance communication log - Check relevant maintenance communication log, recall/regional operation and preliminary information.
- 3 Mechanical system fault - Confirm that this symptom is not caused solely by a mechanical fault.
- 4 Vehicle power-on test - Set the ignition switch to the ON position, and confirm that the vehicle is powered on.
- 5 Control module communication and fault diagnosis code check - Use the fault diagnosis code to confirm that at least one control module communicates with the fault diagnosis code.
- 6 Control module internal performance fault - Confirm that no control module internal hardware performance fault diagnosis code is set currently.
- 7 Control module communication test - Confirm that the vehicle has a control module that does not communicate and that control modules of all equipment should communicate.
- 8 8Communication and power mode fault - Confirm that no control module power mode or communication fault diagnosis code is set currently.
- 9 Engine start and operation test - Confirm that the engine is started and operating.
- 10 10Other fault diagnosis codes - Confirm that no other fault diagnosis code is set.
- 11 Discharge-related inspection/maintenance test fault - If inspection and maintenance test are required for the local area, confirm that the problem reported by the customer is not related to the inspection/maintenance test.
- 12 Symptom diagnosis - Diagnose other problems reported by the customer.

Basic method for line detection

The basic method for line detection includes the following basic detection information. Use this information in conjunction with the diagnosis procedures to identify the cause of the electrical faults.

- Measure the voltage
- Measure the voltage drop
- Measure the frequency

- Detect the grounding and low level reference voltage circuits
- Detect the open circuit
- Detect the grounding short circuit
- Detect the power short circuit
- Detect the intermittent fault or poor contact

Measure the voltage

The following procedures are used to measure the voltage at the selected point in the circuit.

- 1 Disconnect the electrical harness plugs on the circuit under test if necessary.
- 2 Enable the circuit under test and/or system. The method is as follows:
 - a Set the ignition switch to the ON position when the engine is shut down.
 - b Start the engine.
 - c Switch on the circuit and/or system via the "pushed output" function of the fault diagnosis instrument.
 - d Turn on switch of the circuit under test and/or system.
- 3 Select V (AC) (alternating voltage) or V (DC) (direct voltage) position on the digital multimeter.
- 4 Connect positive wire of the digital multimeter to testing point of the circuit.
- 5 Connect negative wire of the digital multimeter to a well-grounded point.
- 6 The voltage measurement at that point will be displayed on the digital multimeter.

Measure the voltage drop

The following procedures are used to determine the voltage difference between two points.

- 1 Set the digital multimeter to the V (DC) position.
- 2 Connect positive wire of the digital multimeter to a testing point of the circuit.
- 3 Connect negative wire of the digital multimeter to another testing point of the circuit.
- 4 Power on the circuit.
- 5 The voltage difference between the two points will be displayed on the digital multimeter.

Measure the frequency

Use an oscilloscope or other special frequency meter to measure the frequency. Only the measuring method using a digital multimeter is described below.

General Information

Confirm the signal frequency in the following procedure.

- 1 Power on the circuit.
- 2 Set the digital multimeter at V(AC)(AC voltage).
- 3 Connect the positive wire of digital multimeter to the circuit to be tested.
- 4 Connect negative wire of the digital multimeter to a well-grounded point.
- 5 Set the digital multimeter to Hz (hertz).
- 6 Display the measured frequency value on the digital multimeter.

Detect the grounding and low level reference voltage circuits

The conductivity test on the grounding and low-level reference voltage circuit may be affected by many vehicle conditions when the digital multimeter is used. In case of failure to meet these conditions, the test on the good grounding or low-level reference voltage circuit may be failed. Thus, the diagnosis may be delayed and the components may be replaced incorrectly.

During test, the flowing of any electric current through grounding or low-level reference voltage circuit may result in the deviation of conductivity readings on the digital multimeter or higher readings than that when no current flows. During the grounding or low-level reference voltage circuit conductivity test, it has a higher failure possibility in the negative terminal of vehicle battery than that in any other grounding reference points. The optimal grounding test point is control module casing (proposed that it is metal and grounded), gatepost latch (proposed that it is connected with metal), the area below the metal frame of instrument panel, cylinder block of engine or vehicle body grounding stud (other than the joint of negative cable of battery).

The typical digital multimeter grounding or low level reference circuit conductivity reading should be 100Ω when the ignition switch is ON, but reduced between 15Ω and 25Ω when it is OFF. The reading reduces below 10Ω after 30 ~ 40s and below 5Ω after 60s. It reduces below 0.3Ω once the vehicle enters into dormant state (3~10min generally)

The following conditions may be met to ensure effective conductivity readings of grounding or low-level reference voltage circuit.

- Place the ignition switch into OFF position
- Pull out the key from ignition switch
- Switch the holding accessories power off (open and close the cab door after the ignition switch is turned off)
- Set the charging rate of battery charger to 2A or below
- Keep the fault diagnostic apparatus no communication with any vehicle control module
- Close all doors

- Turn off the headlamp
- Turn off delay lamp
- Shut down the heating, ventilation and air conditioning systems
- Any accessory that can work when the ignition switch is turned off
- Wait for 60s (after all the following conditions are satisfied)

Detect the open circuit

Test whether the circuit has good conductivity in the following procedure.

Use digital multimeter

- 1 Place the digital multimeter in the position of Ω (Ohm).
- 2 Disconnect the power feeder of doubtful circuit (e.g., fuse and control module).
- 3 Disconnect load.
- 4 Select "MIN MAX" on the digital multimeter.
- 5 Connect a wire of the digital multimeter to one end of circuit to be tested.
- 6 Connect another wire of digital multimeter to the other end of circuit to be tested.
- 7 The very small or zero resistance on the digital multimeter indicates good circuit conductivity.

Detect the grounding short circuit

Test whether there is short circuit to ground in the following procedure.

Take example of digital multimeter:

- 1 Dismantle the power feeder of doubtful circuit (e.g., fuse and control module).
- 2 Disconnect load.
- 3 Place the digital multimeter in the position of Ω (Ohm).
- 4 Connect a wire of the digital multimeter to one end of circuit to be tested.
- 5 Connect another wire of digital multimeter to good ground.
- 6 There is short circuit to ground if the resistance displayed on the digital multimeter is not infinite.

When the fuse supplies power to multiple loads:

- 1 Look up the system diagram to find out the broken fuse.
- 2 Disconnect the first plug or switch between fuse and each load.

- 3 Connect the digital multimeter with two terminals of fuse (ensure the fuse has power).
- 4 The voltage displayed on the digital multimeter indicates that there is short circuit on the line till the first plug or switch.
- 5 Turn off the plugs or switches one by one until the digital multimeter displays voltage, and then find out short circuit.

Detect the power short circuit

Test whether there is short circuit to voltage in the following procedure.

- 1 Dismantle the power feeder of doubtful circuit (e.g., fuse and control module).
- 2 Disconnect load.
- 3 Set the digital multimeter to the V (DC) position.
- 4 Connect the positive wire of digital multimeter to one end of circuit to be tested.
- 5 Connect negative wire of the digital multimeter to a well-grounded point.
- 6 Place the ignition switch to “On” position, and keep all accessories working.
- 7 There is short circuit to voltage if the voltage is higher than 1V.

Detect the intermittent fault or poor contact

- 1 Conditions resulting in intermittent fault

Many intermittent short circuits and faults are caused by harness/plug movement due to vibration, engine torque, bump/uneven road. If the fault seems to be related to vibration, the harness needs to be operated to represent the fault that the customer has reported. Operate the circuit as below:

- Shake the harness.
- Disconnect and reconnect the plug.
- Extrude the mechanical connection part of plug.
- Pull the harness or wire to judge whether the wire in the insulation layer is separated/broken.
- Reset the harness or wire.

Operate purposefully. For example, when the fault diagnosis instrument is connected, shake the wire to find out the faults related to control module input signal. Observe the corresponding component data through “Real-time display”.

It is also available to connect or disconnect through “Force output” of fault diagnosis instrument. Move relevant plug and harness. Observe the components. Keep the engine operating. Move relevant plug and harness. Monitor the engine. If the data, component/system or engine are influenced by the movement of harness or plug, check the harness or plug. If necessary, repair.

The vehicle may be loaded to represent faults. The heavy objects, floor type jack, jack support or vehicle frame may be required. Operate the suspension or frame in above method to represent faults. It is effective to find out the faults related to very short harness in the method. The very short harness may result in opening of plug on the harness, thus causing poor contact. During test, set the digital multimeter in the “(Maximum/Maximum peak value)” mode, and then connect to the doubtful circuit to obtain ideal results.

General Information

It is also effective by viewing, smelling and listening during circuit operation.

Sometimes, the fault cannot reappear only through circuit operation. In the case, expose the doubtful circuit in other conditions in addition to harness operation. Such conditions include high humidity and extremely high or low temperature. The following describes how to expose the circuit in such conditions.

- High temperature

For the faults related to overheat, simulate the fault conditions with heat gun. Heat up the doubtful position or part with heat gun.

Operate the harness in the high temperature condition. Meanwhile, monitor the fault diagnosis instrument or digital multimeter to find out fault.

Test vehicle on the road in the normal operating temperature to reach high temperature. In case of no heat gun, strengthen diagnosis in the method. However, it is inconvenient to operate the harness and other components in the method.

- Low temperature

Based on the fault property, park the vehicle in a cool place and then put a fan in front of vehicle to achieve expected results.

After the vehicle, component or harness is cooled sufficiently, operate the harness or component to represent the fault.

2 Test of intermittent fault and poor contact

A fault that does not appear currently but is recorded in the fault diagnosis code history may be subject to intermittent fault. The intermittent fault may be the reason for customer requiring repair, but its symptoms cannot appear again.

Many intermittent faults are caused by electrical connection or wire fault. Inspect the following items:

- Whether the wire in the insulation layer is broken.
- Whether the positive and negative terminals of plug are contacted poorly.
- The poor contact of terminal and wire includes poor crimping, poor welding quality, crimping on the wire insulation layer rather than wire, corrosive contact, etc.
- The piercing or damage of insulation layer will make moisture entering wire, thus resulting in corrosion. The conductor in the insulation layer is corrosive, which can hardly be seen from outside. Inspect whether there are expansive and hardened wires in the doubtful circuit.
- The wire clamping and broken notch or insulation layer will result in intermittent open or short circuit (because the exposed parts contact other harnesses or parts of vehicle).
- The wire may contact heat or exhaust components.
- Represent fault to verify the faults that the customer has reported.

- Learn about the test procedures of intermittent open circuit, excessive resistance, short circuit to ground and short circuit to voltage.

- a Inspect whether the terminal suffers from fretting wear

Some intermittent faults may be caused by wire terminal contact abrasion. The contact abrasion is formed from oxidative wear debris of insulated aggregate during slight movement between electrical plug. The resistance at the plug is increased when the oxidative wear debris is stored to certain extent. The contact abrasion may occur even the contact surface moves for 10-100 micrometers. For a piece of paper that has the thickness about 100 micrometers, the contact corrosion movement is too small to be seen. The vibration, expansion and contraction are main causes for contact abrasion movement. The vehicle vibration and great temperature fluctuation can also result in contact abrasion movement. The surfaces of tin, copper, nickel and iron can easily suffer from contact abrasion. It is difficult to see the contact abrasion. However, it seems to be small and black stain on the contact surface of terminal. To solve the corrosion problem, disconnect the doubtful plug and coat lubricant (insulation grease) on both sides of plug terminal. Reconnect the plug and sweep redundant lubricant. It is available to improve the additional resistance of terminal contact caused by contact abrasion.

- b Inspect whether the terminal is well contacted.

Before replacing the doubtful component, test the contact of terminals on the component plug and inline plug. Inspect matched terminals to ensure good contact. The negative and positive terminals of plug may be poorly contacted due to pollution or deformation. The poor connection of two halves of plug may result in pollution. It may also be polluted if the plug sealing parts are missed or damaged, the plug is damaged or the terminal is exposed in the damp or dusty environment. The plugs under the engine hood or at the bottom of vehicle body are most likely to be polluted, thus causing the terminal corrosion and short circuit or intermittent short circuit. The poor connection and the repeated disassembly and assembly of two halves of plug may also lead to terminal deformation. The deformation (generally on the contact projecting tongue of mother plug) will result in the poor contact of terminal, thereby causing short circuit or intermittent short circuit.

- c Inspect whether the terminal in the electrical center of bus is well contacted.

Test the terminal contact in the following procedure:

- Separate the two halves of plug.
- Visually inspect whether the two halves are polluted. The pollution will result in white or green rust inside the plug casing or between terminals. It may result in great resistance, intermittent contact or short circuit. In case of pollution under the engine hood or at the bottom of vehicle body, replace the whole part: terminal, sealing part and plug body.
- Confirm whether the retentivity of doubtful terminal is obviously different from that of good terminal with equivalent positive terminals/terminated wires. Replace doubtful negative terminal.

Test the terminal contact in the following procedure:

- Dismantle doubtful components.
- Visually inspect whether both sides of plug are polluted. Never contact any side of plug which may be polluted by skin grease.
- Visually inspect whether the terminal supporting surface at the flat wire side suffers from separation, crack or other defaults that may result in poor contact. Visually inspect the plug at the component side to ensure all terminals are consistent without damage or deformation.
- Insert corresponding adapter into the harness plug of flat wire to test the doubtful circuit.

d Voltage and grounding of control module/component

The poor contact of power or grounding may result in many different symptoms.

- Test the power supply voltage circuits of all control modules. Many vehicles are designed with several circuits to supply power to a control module. The separate power supply voltage circuit in other components of the system also needs to be tested. Inspect the module/component plug, fuse connection and any intermediate connection between power supply voltage and module/component. The test lamp or digital multimeter can display whether the voltage exists or not, but cannot be used to test whether the circuit can supply maximum current. Operate components to test the capacity of circuit supplying sufficient current.
- Test all control module grounding and system grounding circuits. The control module may have several grounding circuit. Other components in the system perhaps have separate grounding, which may also need test. Confirm all grounding points are clean and firmly connected. If possible, inspect the connections on components and star plugs. Operate components to test the capacity of circuit supplying sufficient current.

e Temperature sensitivity

- The intermittent fault may occur when the component/connection reaches normal operating temperature. The fault may only occur when the component/connection is operating in the cold or hot state.
- Inspect whether the data are related to the following conditions if the intermittent fault is relevant to heat:

- (1) Over high ambient temperature.
 - (2) Heat from the area below engine hood/engine.
 - (3) Heat generated due to poor contact or great electrical load.
 - (4) Vehicle overload, such as tow vehicle, etc.
- Inspect whether the data are related to the following conditions if the intermittent fault occurs in the cold state:
 - (1) Over low ambient temperature - the connecting part or component may be frozen in the extremely low temperature. Inspect whether water enters.
 - (2) The fault only occurs during cold start.
 - (3) The fault disappears once the vehicle engine becomes warm.
 - (4) The information from customer assists in confirming whether the fault is related to temperature.

f Electromagnetic interference and electrical noise

Some electrical components/circuits are sensitive to electromagnetic interference or other types of electrical noises. Inspect whether the following conditions exist:

- Improper harness wiring and too close to high voltage/current devices (e.g., secondary ignition component, motor, generator, etc.) - these components will cause electrical noise in the circuit and influence the normal operation of circuit.
- Electrical system interference due to the fault of electromagnetic valve or switch driven by relay and control module - these conditions may result in strong surge. Generally, the fault occurs when the failed component is operating.
- Incorrect installation of non-original components that are installed after sales (e.g., vehicle lamps, interphone, amplifier, motor, remote control starter, alarm system, onboard phone, etc.) - these accessories may result in interference during work but have no fault after work.
- Test whether the diode spanned on the clutch of air condition compressor and other diodes suffer from short circuit. Some relays may be set with clamping diodes.
- The generator may bring AC noise into electrical system.

g Incorrect control module

Reprogram the control module only in several cases:

- The new control module is installed during maintenance.
- The control modules from other vehicles are installed.
- The upgrade software/calibration document is released for the vehicle.

General Information

- Confirm the control module is installed with correct calibration or configuration document. In case of incorrect program, reprogram the control module with the latest software/calibration document.

High voltage maintenance operation requirements

SAIC electric vehicle power system is powered by high-voltage battery pack.

Therefore, in the maintenance operation should always do “safety first, protection first awareness of prevention. Wear the necessary insulation safety tools, use the discharge tool to discharge, use the measuring tool to measure the voltage, and ensure that there is no electricity before performing the operation.

Please strictly follow the instructions in the manual, and check the protective tools before use (for example, no damage, normal operation, etc.) :

1 Insulated gloves/leather gloves

Grade of insulation gloves (above 1000V/300A)

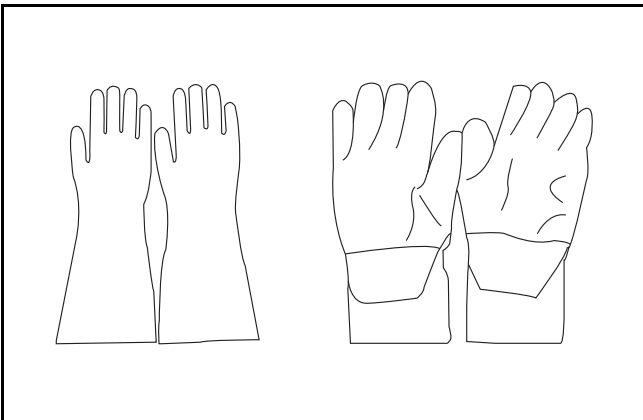

2 Insulation cap/insulation shoes

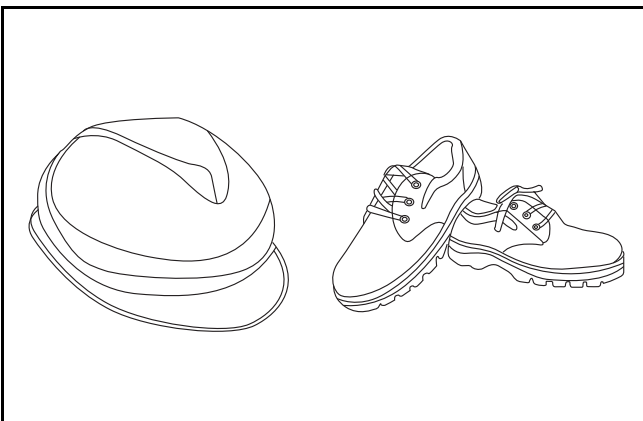

3 Sign label/barrier

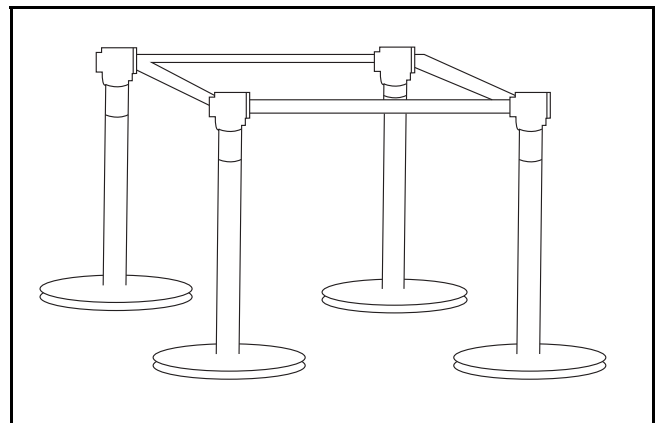
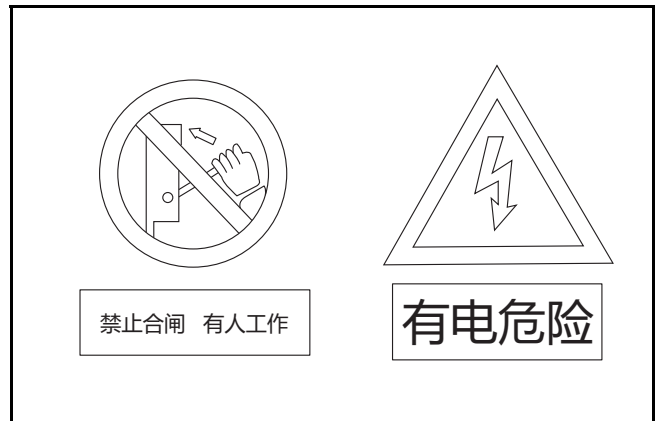

4 Eye shield

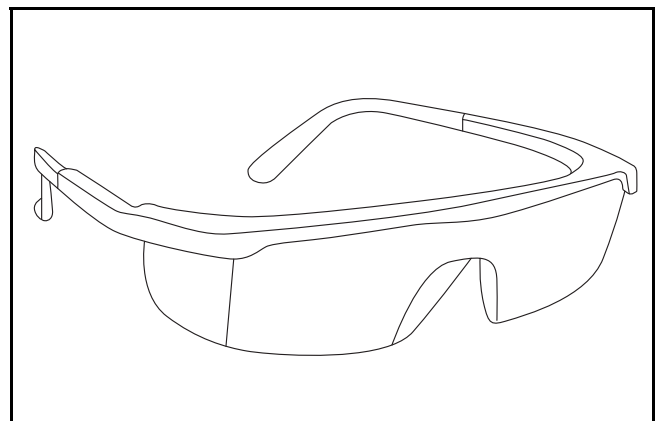

5 Insulation mat



6 Insulation tool

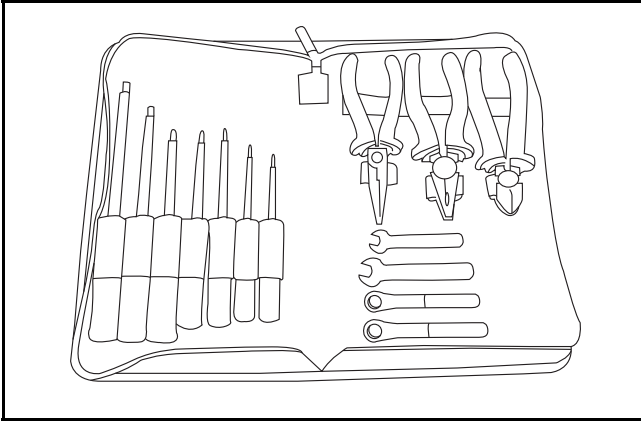

7 Discharge tooling

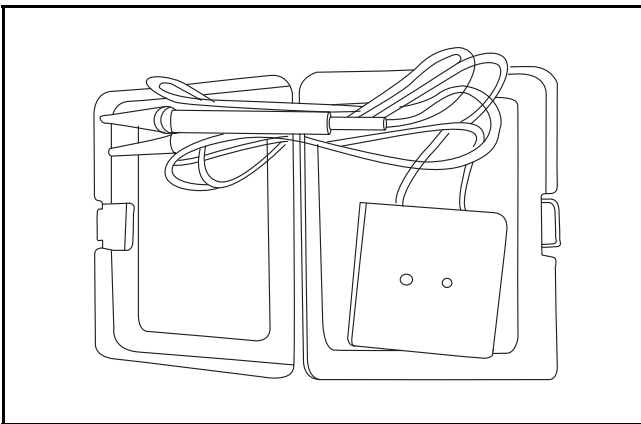

Notes for high voltage maintenance:

On the premise of wearing and preparing protective equipment in strict accordance with the requirements of high-voltage maintenance operations, the following points should also be paid attention to:

- 1 The orange wire harness in the cabin is a high-voltage wire harness. Do not touch it without discharge treatment or wearing insulation tools.
- 2 In all maintenance operations involving vehicle electrical and high-voltage wiring harness areas, the high-voltage wiring harness plugs connected with power batteries should be disconnected, and the high-voltage wiring harness and electrical discharge operation.
- 3 Maintenance personnel shall place insulating objects (such as insulation sticks) beside them, and be equipped with safety supervision personnel to avoid inadvertent electric shock.
- 4 Turn off the ignition switch and do not perform other operations within 3 minutes of disconnecting the negative electrode of the battery.
- 5 After the power failure, keep the key of the vehicle and forbid others to operate it.
- 6 If the power battery has a maintenance switch, remove the maintenance switch first and then disconnect the power battery wiring harness.
- 7 For the power battery harness plug, disconnect the low-voltage control harness first and then the high-voltage connection harness (the red harness is positive and the black harness is negative).
- 8 Discharge the wiring harness connecting the positive and negative high voltage terminals of the battery box.
- 9 Discharge high voltage electrical appliances and wire harness terminals. Use a multimeter to measure the voltage at both ends and check that the voltage is zero before performing related operations.
- 10 The disassembled and disconnected connectors of high-voltage electrical appliances shall be sealed with black tape to prevent sundries from entering.
- 11 The wiring harness connectors should be kept dry. If cooling water and oil are accidentally spilled into the high-voltage wiring harness or electrical interior, they should be cleaned and dried with compressed air. And use Megohm meter to measure the insulation resistance of high-voltage electrical appliances or wiring harness to meet the standard before installation.
- 12 Before opening the cover of the engine room of the electric vehicle, the key should be turned to the OFF gear; It is strictly prohibited to touch the devices marked with high pressure danger warning signs in the cabin of the electric vehicle directly; Spraying water or washing is prohibited in the engine room of the vehicle; Do not open the front hatch cover in the rain to prevent electrical leakage.

General Information

High voltage discharge operation of the control module:

Caution: The discharge operation applies only to the HV system module and cable. Do not discharge the power battery. Otherwise, excessive discharge may damage the power battery. If you must discharge a power battery, check with the manufacturer and use the specified discharge device as required by the manufacturer.

- 1 Wear and prepare protective equipment in strict accordance with high voltage maintenance operation requirements.
- 2 Disconnect the negative cable of the low voltage battery.

Caution: Do not perform related operations within 3 minutes after negative cable of the battery is disconnected.

- 3 Lift the vehicle.
- 4 Remove maintenance switch. (if equipped)
- 5 Disconnect the power battery low-voltage control harness.
- 6 Disconnect the power battery high-voltage wiring harness.
- 7 Disconnect the high voltage cable from the high voltage module.
- 8 Use a discharge tool to connect the high voltage module/high voltage cable to only the discharge tool.

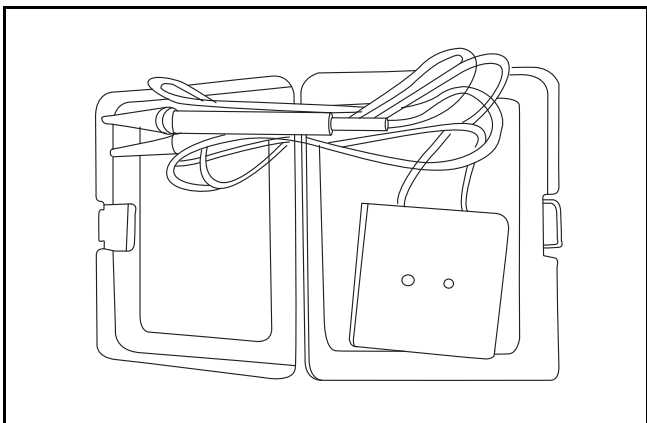

- 9 Use a multimeter to measure the voltage at both ends and check that the voltage is zero before performing related operations.

Insulation resistance measurement.

Usage of megohm meter

Megohm meter (1000V)

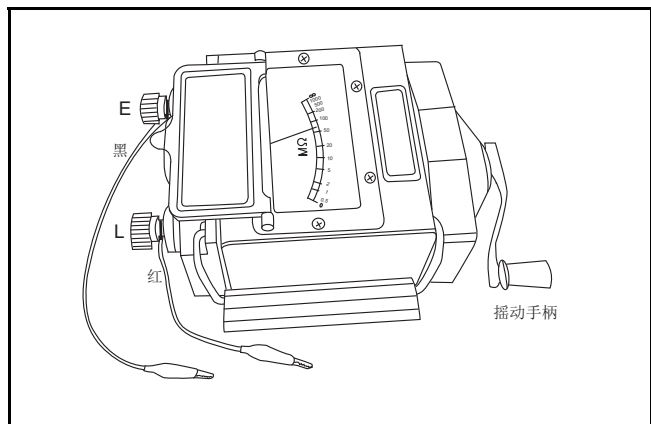

- 1 Check that the pointer should be in the center position (20MΩ) when the megohm meter is at rest normally.
- 2 Connect the red wire of the measuring harness to the L (line) end and the black wire to the E (ground) terminal.
- 3 Measure the megohm meter. When L (line) and E (ground) measuring clamp are in isolation insulation, slowly shake the megohm meter handle clockwise, the pointer should be deflected ∞ position. When the L(line) end is directly connected to the E(ground) end of the measuring clamp, slowly shake the megohm meter handle clockwise, the pointer should be deflect at 0 MΩ position.
- 4 Place the megohm meter horizontally, connect the L(line) end of the measuring clamp to the core, and connect E(ground) to the wire harness insulation layer or the outer shell of the electrical appliance. Shake the handle clockwise to increase the speed to about 120 revolutions per minute, read the stable value of the megohm meter pointer.
- 5 After the measurement is completed, remove the L and E wire harness measuring clips on the measured object in turn.
- 6 When the megohm pointer returns to the middle position, remove the connecting wire harness of the megohm meter and restore the tool.

**Insulation resistance measurement example:
driving motor insulation resistance measurement.**

- 1 Disconnect the harness plug driving motor high-voltage.

Warning: *Warning: wear insulation tools in strict accordance with high-voltage operation requirements, and check and discharge the disconnected wire harness.*

- 2 Disconnect the cable plug of driving motor (U-/V-/W-phase).
- 3 The insulation resistance values of U,V and W phase cable plug terminals and drive motor housing were measured by megohm meter.

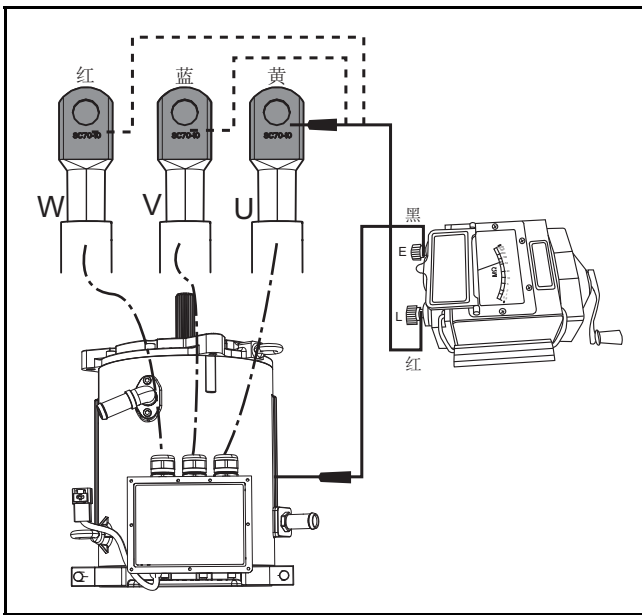

Insulation standard: resistance value $\geq 20M\Omega$

Caution: *Note: if the motor is severely damp $\leq 2 M\Omega$, the motor should be dried and measured again to meet the standard before use.*

DTC Summary List (ESC)

DTC	English descriptions	Reference page
C0031-08	Left Front Wheel Speed Sensor multi Failures	C0031-08 , C00A0-00 , C0032-00 , C00A1-00
C00A0-00	Wheel-speed sensor, front left: short to GND	
C0032-00	Wheel-speed sensor, front left: open	
C00A1-00	Wheel-speed sensor, front left: short to UBATT	
C0034-08	Right Front Wheel Speed Sensor multi Failures	C0034-08 , C00A2-00 , C0035-00 , C00A3-00
C00A2-00	Wheel-speed sensor, front right: short to GND	
C0035-00	Wheel-speed sensor, front right: open	
C00A3-00	Wheel-speed sensor, front right: short to UBATT	
C0037-08	Left Rear Wheel Speed Sensor multi Failures	C0037-08 , C00A4-00 , C0038-00 , C00A5-00
C00A4-00	Wheel-speed sensor, rear left: short to GND	
C0038-00	Wheel-speed sensor, rear left: open	
C00A5-00	Wheel-speed sensor, rear left: short to UBATT	
C003A-08	Right Rear Wheel Speed Sensor multi Failures	C003A-08 , C00A6-00 , C003B-00 , C00A7-00
C00A6-00	Wheel-speed sensor, rear right: short to GND	
C003B-00	Wheel-speed sensor, rear right: open	
C00A7-00	Wheel-speed sensor, rear right: short to UBATT	
C0020-04	Return Pump	C0020-04 , C006B-06 , C1099-04
C006B-06	ABS/ESP implausible control (control time too long, etc.)	
C1099-04	Wheel speed sensor general failure	
C0072-08	Valve general failure	
C1212-08	Variant Coding Error	C1212-08 , C1020-01 , C1010-08
C1020-01	ECU Hardware Error	
C1010-08	ECU Software Error	

ESC

DTC	English descriptions	Reference page
C0045-10	Pressure sensor fault(line)	C0045-10 , C0044-60 , C00A8-00 , C00A9-00 , C00AA-00 , C00AB-00 , C00AC-00 , C0196-04 , C1000-04 , C0040-08 , C0061-08 , C0062-08 , C0063-08 , C0072-04
C0044-60	Pressure sensor fault (Signal)	
C00A8-00	IIS (Integrated Inertial Sensor) not calibrated or failed	
C00A9-00	Wheel-speed sensor, front left: general error	
C00AA-00	Wheel-speed sensor, front right:general error	
C00AB-00	Wheel-speed sensor, rear left:general error	
C00AC-00	Wheel-speed sensor, rear right:general error	
C0196-04	IIS (Integrated Inertial Sensor) fault: hardware failure, temperature, range, internal fault	
C1000-04	ECU error (general system problem)	
C0040-08	BLS fault: Plausibility	
C0061-08	Lateral acceleration signal failure	
C0062-08	Longitudinal acceleration signal failure	
C0063-08	Yaw rate signal failure	
C0072-04	Brake Disc Over heat	
C1900-04	ECU Voltage supply: high voltage	C1900-04 , C1901-04
C1901-04	ECU Voltage supply: low voltage	
C104C-04	PATA switch failure	C104C-04
C108C-08	Reverse Gear Switch signal permanent High/Low	
C0051-54	SAS Sensor Calibration Error	
C0460-08	SAS fault: Signal	
U0001-04	CAN Bus Off	U0001-04 , U0126-87 , U0104-04 , U0140-87 , U0155-87 , U0164-00 , U0422-81 , U0423-81 , U0428-81 , U0104-08 , U0401-81 , U0164-08 , U0007-00 , U0005-00 , C1001-04 , U0100-87
U0126-87	Lost communication with SAS	
U0104-04	Lost communication with DAS(Applicable for ACC node)	
U0140-87	Lost Communication With BCM	
U0155-87	Lost Communication With IPK	
U0164-00	Lost Communication With HVAC	
U0422-81	Invalid Data Received From BCM	
U0423-81	Invalid Data Received From IPK	
U0428-81	Invalid Data Received From SAS	
U0104-08	Invalid Data Received From DAS(Applicable for ACC node)	
U0401-81	Invalid Data Received from EMS	
U0164-08	Invalid Data Received from HVAC	
U0007-00	CAN Bus under voltage	
U0005-00	CAN Bus overvoltage	
C1001-04	CAN hardware error	

C0031-08、 C00A0-00、 C0032-00、 C00A1-00

Description of fault diagnosis codes
C0031-08: Left Front Wheel Speed Sensor multi Failures
C00A0-00: Wheel-speed sensor, front left:short to GND
C0032-00: Wheel-speed sensor, front left:open
C00A1-00: Wheel-speed sensor, front left:short to UBATT
Detection tools
1 Multimeter and diagnostic apparatus
Possible causes
<ul style="list-style-type: none"> • Circuit,terminal and adapting piece fault • ESC module fault • Front left wheel-speed sensor fault
Conditions for fault code operation
Turn the ignition switch to ON position.
Conditions for fault code setting
C0031-08
C00A0-00
C0032-00
C00A1-00
To set the effect of a fault code condition
1
2
Circuit diagram descriptions
The ESC module monitors the front left wheel-speed sensor via low level reference circuit and signal circuit.

Circuit diagram

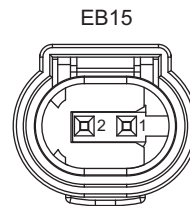
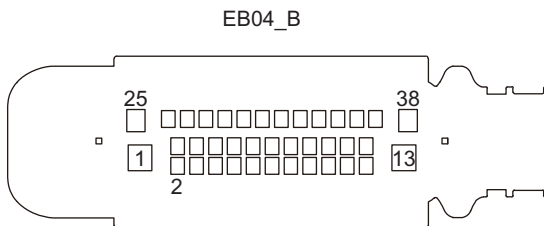
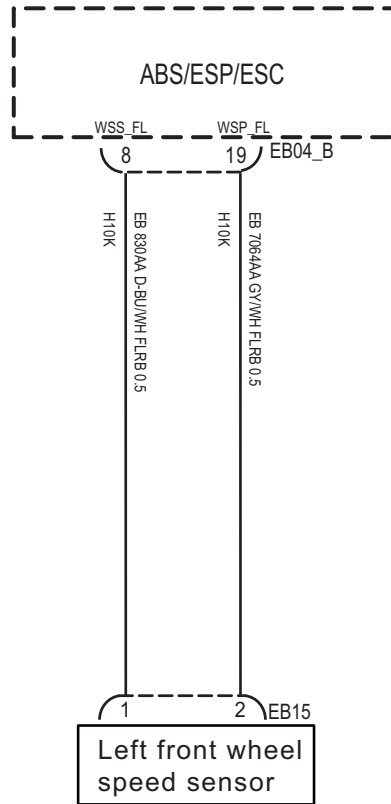

EK891025

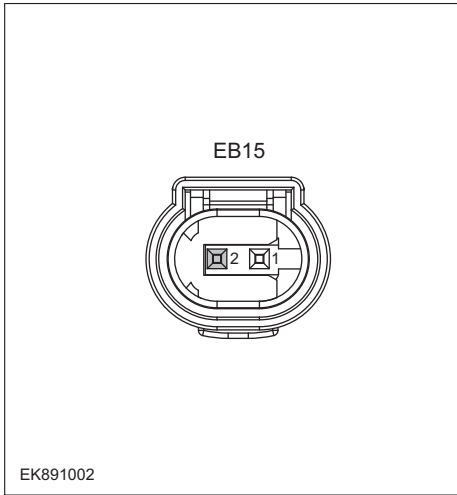
Troubleshooting steps	
Step 1	General inspection.
	<ol style="list-style-type: none"> 1 Check fuse for damage. 2 Check battery capacity. 3 Check the harness plug of front left wheel-speed sensor and ESC module for damage, poor contact, aging and looseness. 4 Check whether the result is normal or not?
NO → Repair or replace the faulted parts.	
YES ↓	
Step 2	Check fault codes.
	<ol style="list-style-type: none"> 1 Connect the fault diagnosis instrument to the diagnosis interface. 2 Turn the ignition switch to ON position. 3 Check the ESC module with a diagnostic apparatus. 4 Is there any other fault code except for C0031-08/C00A0-00/C0032-00/C00A1-00?
YES → Refer to: DTC Summary List (ESC) .	
NO ↓	
Step 3	Check the power supply circuit of front left wheel-speed sensor circuit.
	<ol style="list-style-type: none"> 1 Turn the ignition switch to OFF. 2 Disconnect the harness plug EB15 of front left wheel-speed sensor.. 3 Turn the ignition switch to ON. 4 Measure the voltage between the harness terminal of front left wheel-speed sensor and ground. Measuring circuit: voltage between terminal 2 on plug EB15 and ground. Standard value:4.8~5.2V 5 Check whether the result is normal or not?
NO → Repair or replace the faulted parts.	
YES ↓	

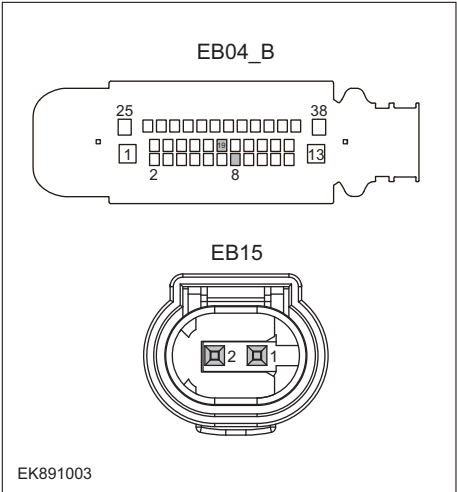
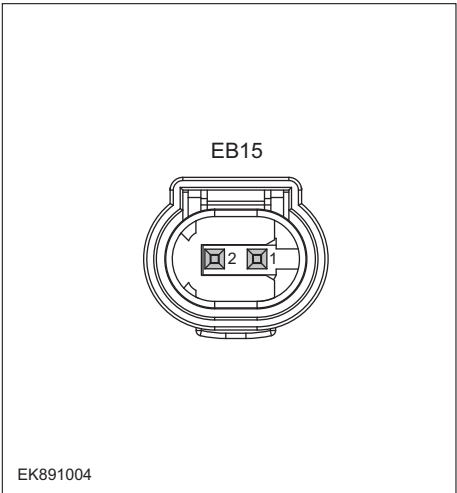
Step 4	Check the circuit of front left wheel-speed sensor (open circuit).
	<ol style="list-style-type: none"> 1 Turn the ignition switch to OFF. 2 Disconnect the harness plug EB04_B of ESC module.. 3 Measure the resistance between harness terminal pf front left wheel-speed sensor and of ESC module. Measuring circuit: resistance between terminal 1 on plug EB15 and terminal 8 on plug EB04_B. Measuring circuit: resistance between terminal 2 on plug EB15 and terminal 19 on plug EB04_B. Standard value: $\approx 0\Omega$ 4 Check whether the result is normal or not?
NO → Repair or replace the faulted parts.	
YES ↓	
Step 5	Check the circuit of front left wheel-speed sensor (short circuit).
	<ol style="list-style-type: none"> 1 Turn the ignition switch to OFF. 2 Check the resistance between the harness plug of front left wheel-speed sensor and ground. Measuring circuit: resistance between terminal 1 on plug EB15 and ground. Measuring circuit: resistance between terminal 2 on plug EB15 and ground. Standard value: ∞ 3 Check the voltage between the harness plug of front left wheel-speed sensor and ground. Measuring circuit: voltage between terminal 1 on plug EB15 and ground. Measuring circuit: voltage between terminal 2 on plug EB15 and ground. Standard value: $\approx 0V$ 4 Check whether the result is normal or not?
NO → Repair or replace the faulted parts.	
YES ↓	

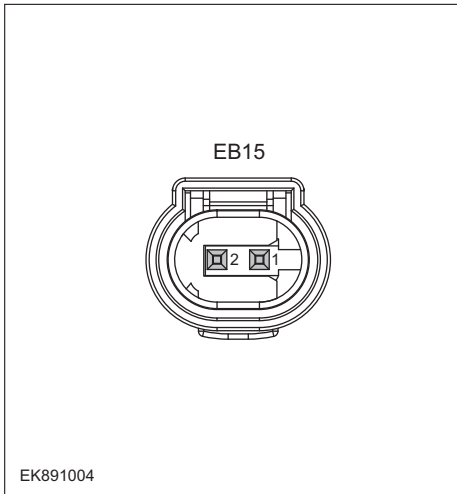
Step 6	Check the front left wheel-speed sensor (parts).
	<ol style="list-style-type: none"> 1 Measure the resistance of front left wheel-speed sensor terminal directly. Measuring circuit: resistance between terminal 1 and terminal 2 on plug EB15. Standard value: 2 Measure the resistance between the terminal of front left wheel-speed sensor and the housing. Measuring circuit: resistance between terminal 1 on plug EB15 and the housing. Measuring circuit: resistance between terminal 2 on plug EB15 and the housing. Standard value: ∞ 3 Check whether the result is normal or not?
NO → Replace the front left wheel-speed sensor.	
YES ↓	
Step 7	Check if ESC module is normal.
	<ol style="list-style-type: none"> 1 Turn the ignition switch to OFF. 2 Disconnect and check the harness plug EB04_B of ESC module. 3 Check and repair. <ul style="list-style-type: none"> • Corrosion(install new adapting piece or terminal-cleaning module and pin). • Pin damaged or bent-install new terminal/pin. • Fly out of pins-install new pins as needed. 4 Reconnect the air conditioning control module plug and all other previously disconnected plug. Make sure the pin is properly positioned and fixed. 5 Run the system and determine if the problem persists?
YES → Replacing the ESC module.	
NO ↓	
At this point the system is functioning normally. The problem may be caused by module connections. Address the root cause of any connector or pin problems,	
Next Step ↓	
Diagnosis end.	

C0034-08、 C00A2-00、 C0035-00、 C00A3-00

Description of fault diagnosis codes
C0034-08: Right Front Wheel Speed Sensor multi Failures
C00A2-00: Wheel-speed sensor, front right:short to GND
C0035-00: Wheel-speed sensor, front right:open
C00A3-00: Wheel-speed sensor, front right:short to UBATT
Detection tools
1 Multimeter and diagnostic apparatus
Possible causes
<ul style="list-style-type: none"> • Circuit,terminal and adapting piece fault • ESC module fault • Front right wheel-speed sensor fault
Conditions for fault code operation
Turn the ignition switch to ON position.
Conditions for fault code setting
C0034-08
C00A2-00
C0035-00
C00A3-00
To set the effect of a fault code condition
1
2
Description of circuit diagram
The ESC module monitors the front right wheel-speed sensor via low level reference circuit and signal circuit.

Circuit diagram

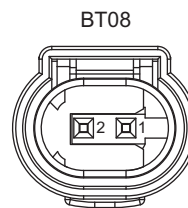
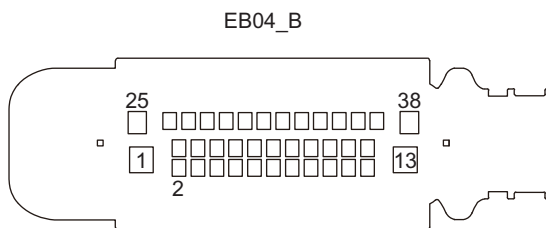
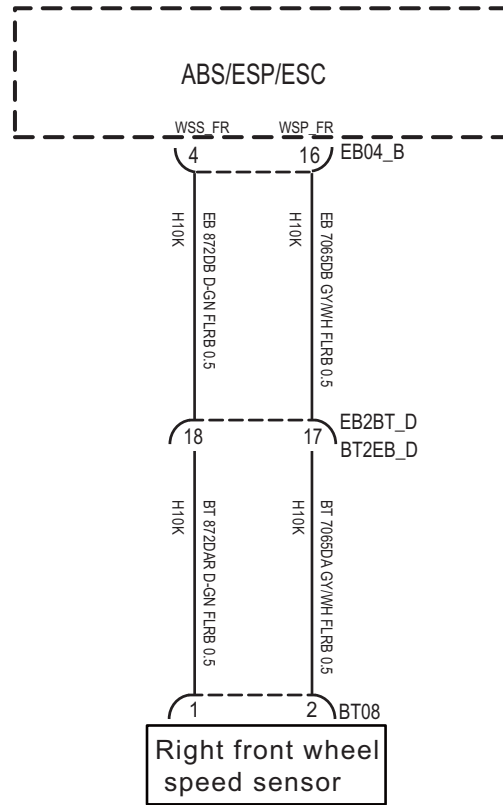

EK891026

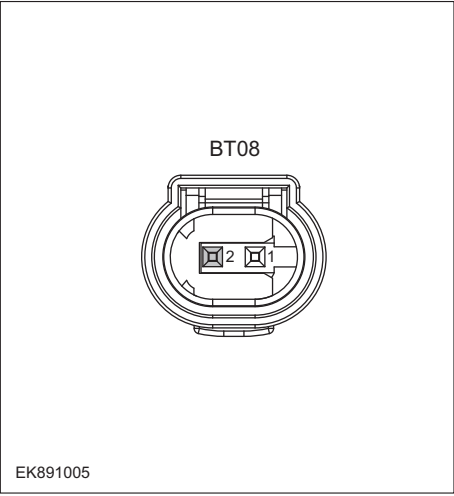
Troubleshooting steps	
Step 1	General inspection.
	<ol style="list-style-type: none"> 1 Check fuse for damage. 2 Check battery capacity. 3 Check if there is any damage, bad contact, aging and looseness phenomenon on harness plug of front right wheel-speed sensor and ESC module. 4 Check whether the result is normal or not?
<p>NO → Repair or replace the faulted parts.</p>	
<p>YES ↓</p>	
Step 2	Check fault codes.
	<ol style="list-style-type: none"> 1 Connect the fault diagnosis instrument to the diagnosis interface. 2 Turn the ignition switch to ON position. 3 Check the ESC module with a diagnostic apparatus. 4 Is there any other fault code except for C0034-08/C00A2-00/C0035-00/C00A3-00?
<p>YES → Refer to: DTC Summary List (ESC).</p>	
<p>NO ↓</p>	
Step 3	Check the power supply circuit of front right wheel-speed sensor..
	<ol style="list-style-type: none"> 1 Turn the ignition switch to OFF. 2 Disconnect the harness plug BT08 of front right wheel-speed sensor.. 3 Turn the ignition switch to ON. 4 Measure the resistance between harness terminal of front right wheel-speed sensor and ground. Measuring circuit: voltage between terminal 2 on plug BT08 and ground. Standard value:4.8~5.2V 5 Check whether the result is normal or not?
<p>NO → Repair or replace the faulted parts.</p>	
<p>YES ↓</p>	

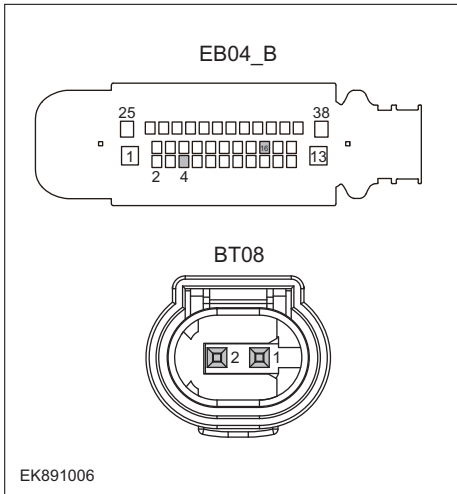
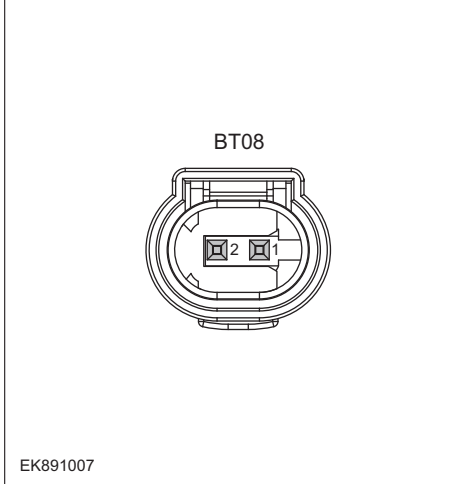
Step 4	Check the front right wheel-speed sensor (open-circuit).
	<ol style="list-style-type: none"> 1 Turn the ignition switch to OFF. 2 Disconnect the harness plug EB04_B of ESC module.. 3 Measure the resistance between plug terminal of front right wheel-speed sensor and ESC module. Measuring circuit: resistance between terminal 1 on plug BT08 and terminal 4 on plug EB04_B. Measuring circuit: resistance between terminal 2 on plug BT08 and terminal 16 on plug EB04_B. Standard value: $\approx 0\Omega$ 4 Check whether the result is normal or not?
NO → Repair or replace the faulted parts.	
YES ↓	
Step 5	Check the front right wheel-speed sensor circuit. (short-circuit).
	<ol style="list-style-type: none"> 1 Turn the ignition switch to OFF. 2 Measure the resistance between plug terminal of front right wheel-speed sensor and ground. Measuring circuit: resistance between terminal 1 on plug BT08 and ground. Measuring circuit: resistance between terminal 2 on plug BT08 and ground. Standard value: ∞ 3 Measure the voltage between the harness plug of front right wheel-speed sensor and ground. Measuring circuit: voltage between terminal 1 on plug BT08 and ground. Measuring circuit: voltage between terminal 2 on plug BT08 and ground. Standard value: $\approx 0V$ 4 Check whether the result is normal or not?
NO → Repair or replace the faulted parts.	
YES ↓	

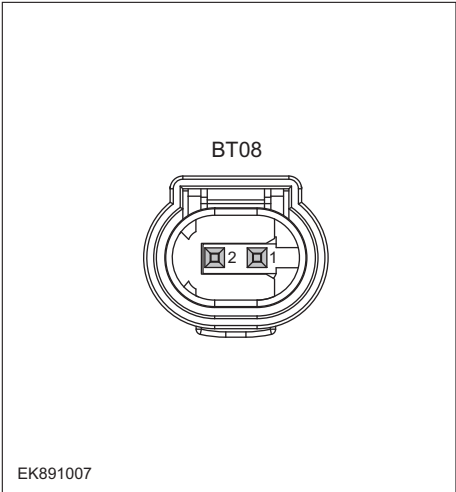
Step 6	Check the front right wheel-speed sensor (parts).
	<ol style="list-style-type: none"> 1 Measure the resistance of front right wheel-speed sensor directly. Measuring circuit: resistance between terminal 1 and terminal 2 on plug BT08. Standard value: 2 Measure the resistance between front right wheel-speed sensor and the housing, Measuring circuit: resistance between terminal 1 on plug BT08 and the housing. Measuring circuit: resistance between terminal 2 on plug BT08 and the housing. Standard value: ∞ 3 Check whether the result is normal or not?
<p>NO → Replace the front right wheel-speed sensor.</p>	
<p>YES ↓</p>	
Step 7	Check if ESC module is normal.
	<ol style="list-style-type: none"> 1 Turn the ignition switch to OFF. 2 Disconnect and check the harness plug EB04_B of ESC module. 3 Check and repair. <ul style="list-style-type: none"> • Corrosion(install new adapting piece or terminal-cleaning module and pin). • Pin damaged or bent-install new terminal/pin. • Fly out of pins-install new pins as needed. 4 Reconnect the air conditioning control module plug and all other previously disconnected plug. Make sure the pin is properly positioned and fixed. 5 Run the system and determine if the problem persists?
<p>YES → Replacing the ESC module.</p>	
<p>NO ↓</p>	
<p>At this point the system is functioning normally. The problem may be caused by module connections. Address the root cause of any connector or pin problems,</p>	
<p>Next Step ↓</p>	
<p>Diagnosis end.</p>	

C0037-08、 C00A4-00、 C0038-00、 C00A5-00

Description of fault diagnosis codes
C0037-08: Left Rear Wheel Speed Sensor multi Failures
C00A4-00: Wheel-speed sensor, front left:short to GND
C0038-00: Wheel-speed sensor, rear left:open
C00A5-00: Wheel-speed sensor, rear left:short to UBATT
Detection tools
1 Multimeter and diagnostic apparatus
Possible causes
<ul style="list-style-type: none"> • Circuit,terminal and adapting piece fault • ESC module fault • Rear left wheel-speed sensor fault.
Conditions for fault code operation
Turn the ignition switch to ON position.
Conditions for fault code setting
C0037-08
C00A4-00
C0038-00
C00A5-00
To set the effect of a fault code condition
1
2
Description of circuit diagram
The ESC module monitors the rear left wheel-speed sensor via low level reference circuit and signal circuit.

Circuit diagram

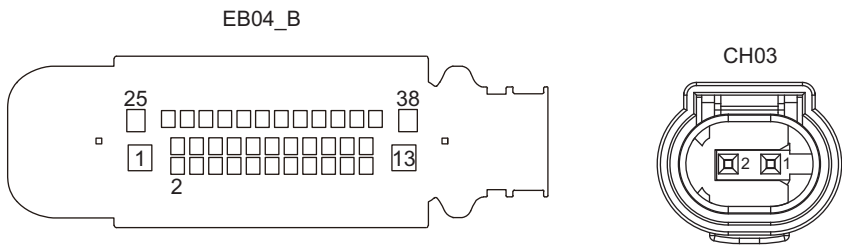
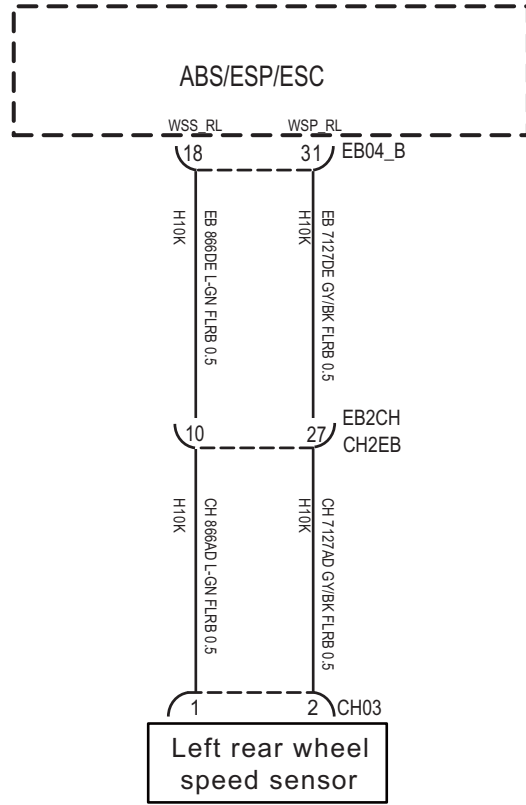

EK891028

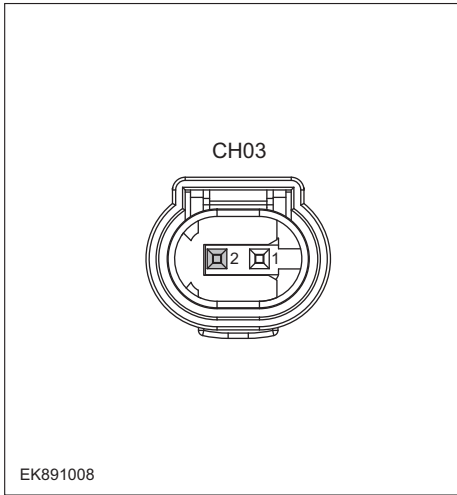
Troubleshooting steps	
Step 1	General inspection.
	<ol style="list-style-type: none"> 1 Check fuse for damage. 2 Check battery capacity. 3 Check the harness plugs of the rear left wheel-speed sensor and the harness plug of ESC module for damage, poor contact, aging and looseness. 4 Check whether the result is normal or not?
NO → Repair or replace the faulted parts.	
YES ↓	
Step 2	Check fault codes.
	<ol style="list-style-type: none"> 1 Connect the fault diagnosis instrument to the diagnosis interface. 2 Turn the ignition switch to ON position. 3 Check the ESC module with a diagnostic apparatus. 4 Is there any other fault code except for C0037-08/C00A4-00/C0038-00/C00A5-00?
YES → Refer to: DTC Summary List (ESC) .	
NO ↓	
Step 3	Check the power supply circuit of rear left wheel-speed sensor.
	<ol style="list-style-type: none"> 1 Turn the ignition switch to OFF. 2 Disconnect the harness plug CH03 of rear left wheel-speed sensor.. 3 Turn the ignition switch to ON. 4 Measure the voltage between the harness terminal of rear left wheel-speed sensor and ground. Measuring circuit: voltage between terminal 2 on plug CH03 and ground. Standard value:4.8~5.2V 5 Check whether the result is normal or not?
NO → Repair or replace the faulted parts.	
YES ↓	

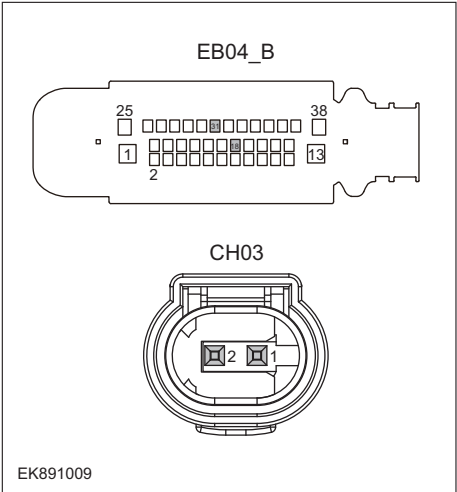
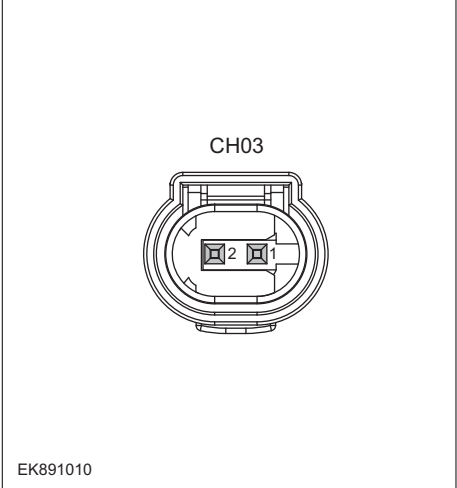
Step 4	Check the rear left wheel-speed sensor circuit (open-circuit).
	<ol style="list-style-type: none"> 1 Turn the ignition switch to OFF. 2 Disconnect the harness plug EB04_B of ESC module.. 3 Measure the resistance between harness terminal of rear left wheel-speed sensor and ESC module. Measuring circuit: resistance between terminal 1 on plug CH03 and terminal 18 on plug EB04_B. Measuring circuit: resistance between terminal 2 on plug CH03 and terminal 31 on plug EB04_B. Standard value: $\approx 0\Omega$ 4 Check whether the result is normal or not?
NO → Repair or replace the faulted parts.	
YES ↓	
Step 5	Check the rear left wheel-speed sensor circuit (short-circuit).
	<ol style="list-style-type: none"> 1 Turn the ignition switch to OFF. 2 Measure the resistance between plug terminal of rear left wheel-speed and ground. Measuring circuit: resistance between terminal 1 on plug CH03 and ground. Measuring circuit: resistance between terminal 2 on plug CH03 and ground. Standard value: ∞ 3 Measure the voltage between rear left wheel-speed sensor and ground. Measuring circuit: voltage between terminal 1 on plug CH03 and ground. Measuring circuit: voltage between terminal 2 on plug CH03 and ground. Standard value: $\approx 0V$ 4 Check whether the result is normal or not?
NO → Repair or replace the faulted parts.	
YES ↓	

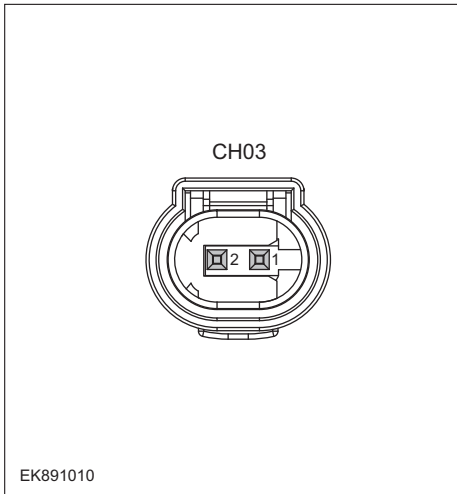
Step 6	Check the rear left wheel-speed sensor (parts).
	<ol style="list-style-type: none"> 1 Measure the resistance of rear left wheel-speed sensor terminal directly. Measuring circuit: resistance between terminal 1 and terminal 2 on plug CH03. Standard value: 2 Measure the resistance between the rear left wheel-speed sensor terminal and the housing. Measuring circuit: resistance between terminal 1 on plug CH03 and the housing. Measuring circuit: resistance between terminal 2 on plug CH03 and the housing. Standard value: ∞ 3 Check whether the result is normal or not?
<p>NO → Replace the rear left wheel-speed sensor.</p>	
<p>YES ↓</p>	
Step 7	Check if ESC module is normal.
	<ol style="list-style-type: none"> 1 Turn the ignition switch to OFF. 2 Disconnect and check the harness plug EB04_B of ESC module. 3 Check and repair. <ul style="list-style-type: none"> • Corrosion(install new adapting piece or terminal-cleaning module and pin). • Pin damaged or bent-install new terminal/pin. • Fly out of pins-install new pins as needed. 4 Reconnect the air conditioning control module plug and all other previously disconnected plug. Make sure the pin is properly positioned and fixed. 5 Run the system and determine if the problem persists?
<p>YES → Replacing the ESC module.</p>	
<p>NO ↓</p>	
<p>At this point the system is functioning normally. The problem may be caused by module connections. Address the root cause of any connector or pin problems,</p>	
<p>Next Step ↓</p>	
<p>Diagnosis end.</p>	

ESC

C003A-08、 C00A6-00、 C003B-00、 C00A7-00

Description of fault diagnosis codes
C003A-08: Right Rear Wheel Speed Sensor multi Failures
C00A6-00: Wheel-speed sensor, rear right:short to GND
C003B-00: Wheel-speed sensor, rear right:open
C00A7-00: Wheel-speed sensor, rear right:short to UBATT
Detection tools
1 Multimeter and diagnostic apparatus
Possible causes
<ul style="list-style-type: none">• Circuit,terminal and adapting piece fault• ESC module fault• Rear right wheel-speed sensor fault
Conditions for fault code operation
Turn the ignition switch to ON position.
Conditions for fault code setting
C003A-08
C00A6-00
C003B-00
C00A7-00
To set the effect of a fault code condition
1
2
Description of circuit diagram
The ESC module monitors the rear right wheel-speed sensor via low level reference circuit and signal circuit.

Circuit diagram

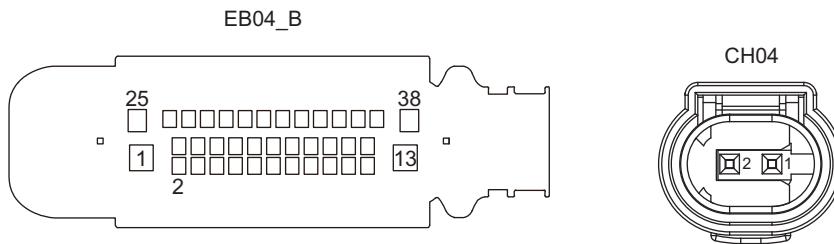
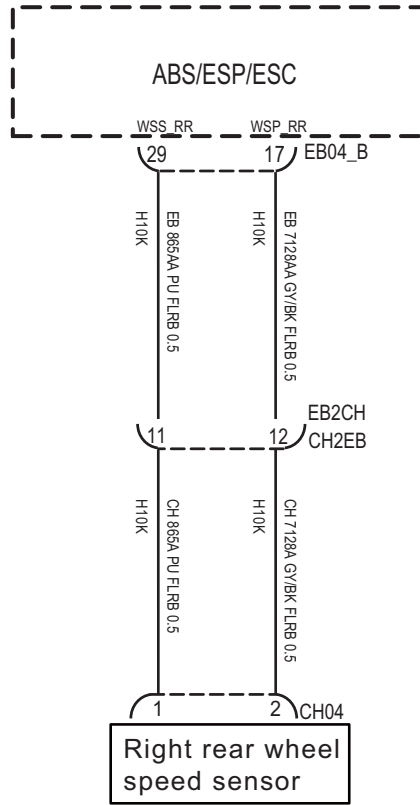

EK891027

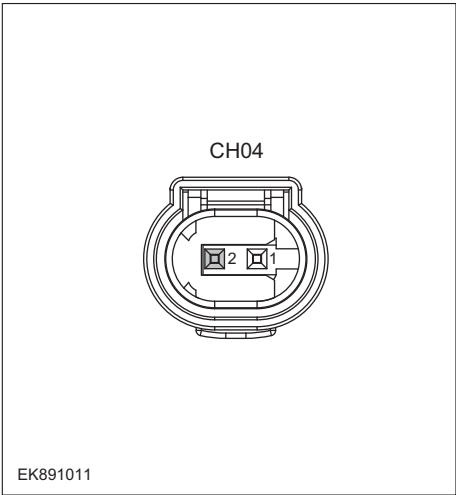
Troubleshooting steps	
Step 1	General inspection.
	<ol style="list-style-type: none"> 1 Check fuse for damage. 2 Check battery capacity. 3 Check the harness plug of rear right wheel-speed sensor and ESC module for damage, poor contact, aging and looseness. 4 Check whether the result is normal or not?
NO → Repair or replace the faulted parts.	
YES ↓	
Step 2	Check fault codes.
	<ol style="list-style-type: none"> 1 Connect the fault diagnosis instrument to the diagnosis interface. 2 Turn the ignition switch to ON position. 3 Check the ESC module with a diagnostic apparatus. 4 Is there any other fault code except for C003A-08/C00A6-00/C003B-00/C00A7-00?
YES → Refer to: DTC Summary List (ESC) .	
NO ↓	
Step 3	Check the power supply circuit of rear right wheel-speed sensor circuit.
	<ol style="list-style-type: none"> 1 Turn the ignition switch to OFF. 2 Disconnect the harness plug CH04 of rear right wheel-speed sensor. 3 Turn the ignition switch to ON. 4 Measure the voltage between harness terminal on rear right wheel-speed sensor and ground. Measuring circuit: voltage between terminal 2 on plug CH04 and ground. Standard value:4.8~5.2V 5 Check whether the result is normal or not?
NO → Repair or replace the faulted parts.	
YES ↓	

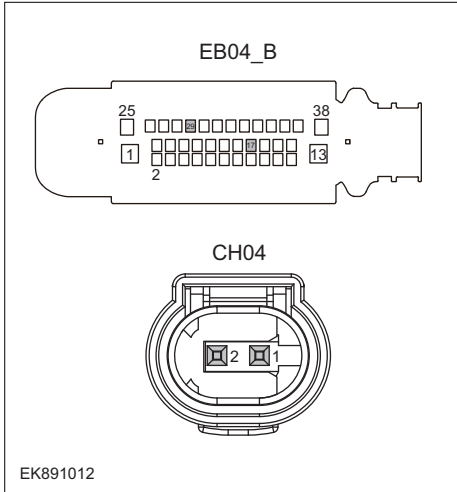
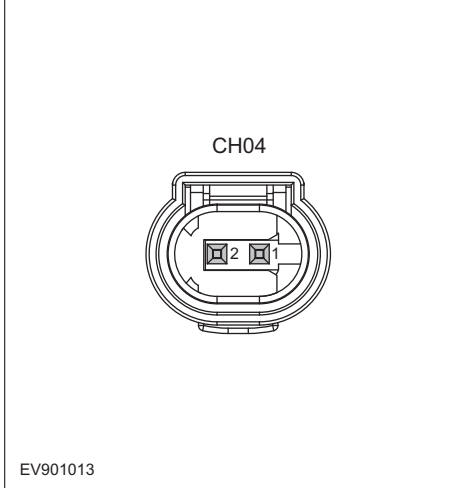
<p>Step 4</p>	<p>Check the power supply circuit of rear right wheel-speed sensor (open circuit)</p>
	<ol style="list-style-type: none"> 1 Turn the ignition switch to OFF. 2 Disconnect the harness plug EB04_B of ESC module.. 3 Measure the resistance between plug terminals on rear right wheel-speed sensor and ESC module. Measuring circuit: resistance between terminal 1 on plug CH04 and terminal 29 on plug EB04_B. Measuring circuit: resistance between terminal 2 on plug CH04 and terminal 17 on plug EB04_B. Standard value: $\approx 0\Omega$ 4 Check whether the result is normal or not?
<p>NO → Repair or replace the faulted parts.</p>	
<p>YES ↓</p>	
<p>Step 5</p>	<p>Check the power supply circuit of rear right wheel-speed sensor (short circuit)</p>
	<ol style="list-style-type: none"> 1 Turn the ignition switch to OFF. 2 Measure the resistance between harness plug on rear right wheel-speed sensor and ground. Measuring circuit: resistance between terminal 1 on plug CH04 and ground. Measuring circuit: resistance between terminal 2 on plug CH04 and ground. Standard value: ∞ 3 Measure the voltage between harness plug on rear right wheel-speed sensor and ground. Measuring circuit: voltage between terminal 1 on plug CH04 and ground. Measuring circuit: voltage between terminal 2 on plug CH04 and ground. Standard value: $\approx 0V$ 4 Check whether the result is normal or not?
<p>NO → Repair or replace the faulted parts.</p>	
<p>YES ↓</p>	

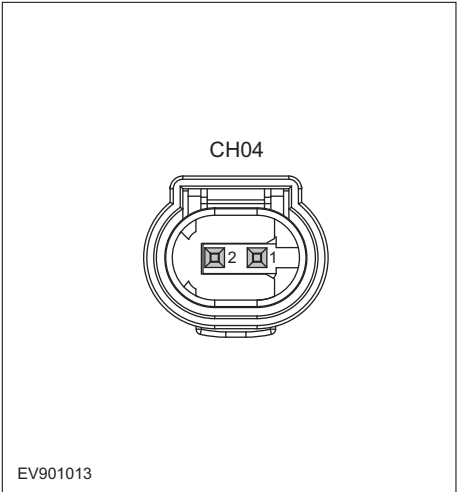
Step 6	Check the rear right wheel-speed sensor (parts).
	<ol style="list-style-type: none"> 1 Measure the resistance of rear right wheel-speed sensor directly. Measuring circuit: resistance between terminal 1 and terminal 2 on plug CH04. Standard value: 2 Measure the resistance between the rear right wheel-speed sensor and the housing. Measuring circuit: resistance between terminal 1 on plug CH04 and the housing. Measuring circuit: resistance between terminal 2 on plug CH04 and the housing. Standard value: ∞ 3 Check whether the result is normal or not?
<p>NO → Replace the rear right wheel-speed sensor.</p>	
<p>YES ↓</p>	
Step 7	Check if ESC module is normal.
	<ol style="list-style-type: none"> 1 Turn the ignition switch to OFF. 2 Disconnect and check the harness plug EB04_B of ESC module. 3 Check and repair. <ul style="list-style-type: none"> • Corrosion(install new adapting piece or terminal-cleaning module and pin). • Pin damaged or bent-install new terminal/pin. • Fly out of pins-install new pins as needed. 4 Reconnect the air conditioning control module plug and all other previously disconnected plug. Make sure the pin is properly positioned and fixed. 5 Run the system and determine if the problem persists?
<p>YES → Replacing the ESC module.</p>	
<p>NO ↓</p>	
<p>At this point the system is functioning normally. The problem may be caused by module connections. Address the root cause of any connector or pin problems,</p>	
<p>Next Step ↓</p>	
<p>Diagnosis end.</p>	

C0020-04、 C006B-06、 C1099-04

Description of fault diagnosis codes
C0020-04: Return Pump
C006B-06: ABS/ESP implausible control (control time too long, etc.)
C1099-04: Wheel speed sensor general failure
Detection tools
1 Multimeter and diagnostic apparatus
Possible causes
<ul style="list-style-type: none"> • Circuit, terminal and adapting piece fault • Battery • ESC module • Charging system • Insurance fuse
Conditions for fault code operation
Turn the ignition switch to ON position.
Conditions for fault code setting
C0020-04
C006B-06
C1099-04
To set the effect of a fault code condition
Description of circuit diagram
The ESC module will continuously monitor whether the sensor and actuator are in normal range. Meanwhile, it will check the connector for virtual connection, short circuit, open circuit and the connection rationality with other signals. In case of any fault, the body control module will save the fault code and enable the safety mode.

Circuit diagram

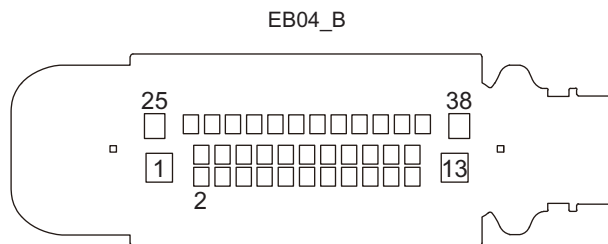
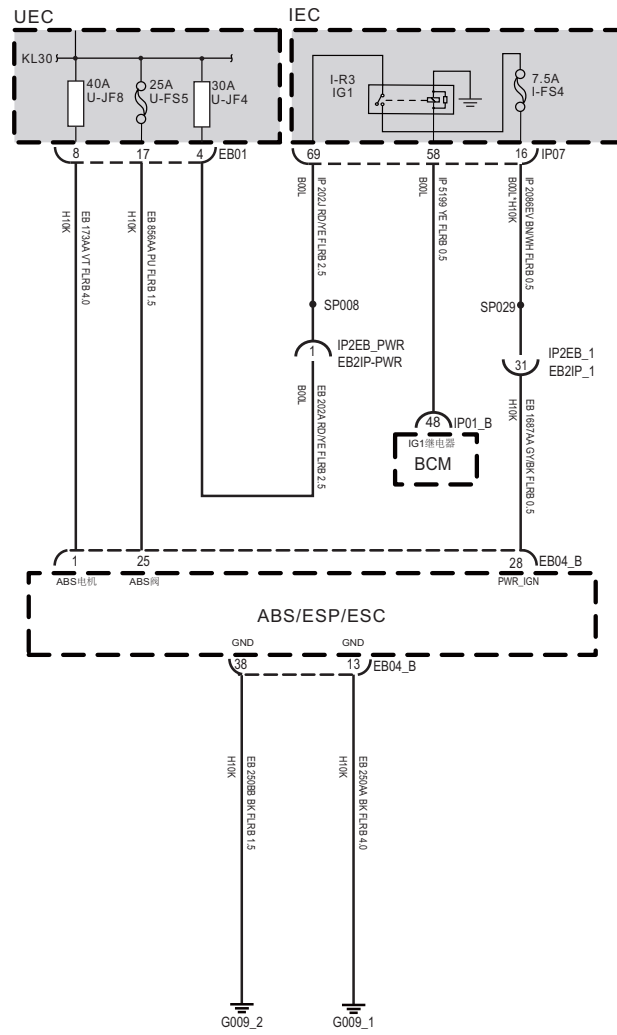

EK891029

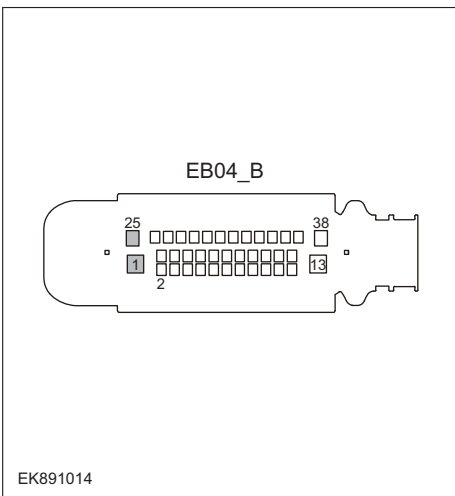
Troubleshooting steps	
Step 1	General inspection.
	<ol style="list-style-type: none"> 1 Check fuses U-JF8/U-SF5/I-FS4 for damage. 2 Check battery capacity. 3 Check the harness plug of ESC for damage, poor contact, aging and looseness. 4 Check whether the result is normal or not?
	NO → Repair or replace the faulted parts.
YES ↓	
Step 2	Check fault codes.
	<ol style="list-style-type: none"> 1 Connect the fault diagnosis instrument to the diagnosis interface. 2 Turn the ignition switch to ON position. 3 Check the ESC module with a diagnostic apparatus. 4 Is there any other fault code except for C0020-04/C006B-06/C1099-04?
	YES → Refer to: DTC Summary List (ESC) .
NO ↓	
Step 3	Check the battery voltage of ESC module.
 <p style="text-align: center;">EB04_B</p> <p style="text-align: left;">EK891014</p>	<ol style="list-style-type: none"> 1 Turn the ignition switch to OFF. 2 Disconnect the harness plug EB04_B of ESC module.. 3 Measure the voltage between <p>Measuring circuit: voltage between terminal 1 on plug EB04_B and ground.</p> <p>Measuring circuit: voltage between terminal 25 on plug EB04_B and ground.</p> <p>Standard value:10~14V</p> 4 Check whether the result is normal or not?
	NO → Repair or replace the faulted parts.
YES ↓	

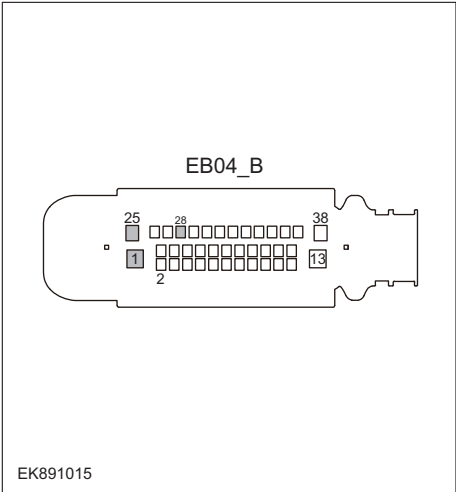
Step 4	Check the power voltage when the ESC module is started or operating
	<ol style="list-style-type: none"> 1 Turn the ignition switch to ON. 2 Measure the voltage between <p>Measuring circuit: voltage between terminal 1 on plug EB04_B and ground.</p> <p>Measuring circuit: voltage between terminal 25 on plug EB04_B and ground.</p> <p>Measuring circuit: voltage between terminal 28 on plug EB04_B and ground.</p> <p>Standard value:10~14V</p> 3 Check whether the result is normal or not?

NO → Repair or replace the faulted parts.

YES ↓

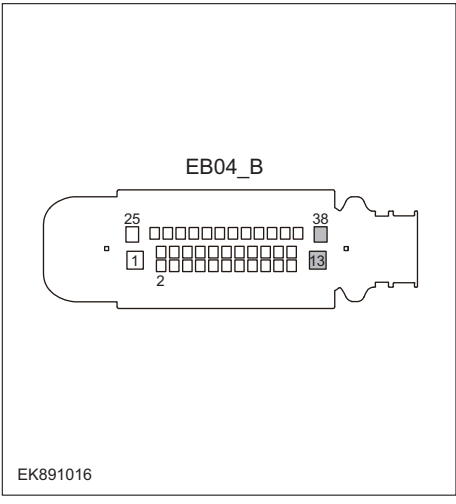
Step 5	Test whether the grounding circuit of ESC module is open.
	<ol style="list-style-type: none"> 1 Turn the ignition switch to OFF. 2 Disconnect the harness plug EB04_B of ESC module.. 3 Measure the resistance between harness plug of ESC module and ground. <p>Measuring circuit: resistance between terminal 13 on plug EB04_B and ground.</p> <p>Measuring circuit: resistance between terminal 38 on plug EB04_B and ground.</p> <p>Standard value: < 1Ω</p> 4 Test whether the resistance is less than 1Ω?

NO → Repair or replace the faulted parts.

YES ↓

Step 6	Check if ESC module is normal.
	<ol style="list-style-type: none"> 1 Turn the ignition switch to OFF. 2 Disconnect and check the harness plug EB04_B of ESC module. 3 Check and repair. <ul style="list-style-type: none"> • Corrosion(install new adapting piece or terminal-cleaning module and pin). • Pin damaged or bent-install new terminal/pin. • Fly out of pins-install new pins as needed. 4 Reconnect the air conditioning control module plug and all other previously disconnected plug. Make sure the pin is properly positioned and fixed. 5 Run the system and determine if the problem persists?
	YES → Replacing the ESC module.
NO ↓	
At this point the system is functioning normally. The problem may be caused by module connections. Address the root cause of any connector or pin problems,	
Next Step ↓	
Diagnosis end.	

ESC

C1212-08、 C1020-01、 C1010-08

Description of fault diagnosis codes	
C1212-08: Variant Coding Error	
C1020-01: ECU Hardware Error	
C1010-08: ECU Software Error	
Detection tools	
1	Multimeter and diagnostic apparatus
Possible causes	
<ul style="list-style-type: none">• Circuit,terminal and adapting piece fault• Battery• ESC module• Charging system• Insurance fuse	
Conditions for fault code operation	
Turn the ignition switch to ON position.	
Conditions for fault code setting	
C1212-08	
C1020-01	
C1010-08	
To set the effect of a fault code condition	
Description of circuit diagram	
The ESC module will continuously monitor whether the sensor and actuator are in normal range. Meanwhile,it will check the connector for virtual connection, short circuit, open circuit and the connection rationality with other signals. In case of any fault, the body control module will save the fault code and enable the safety mode.	

Circuit diagram

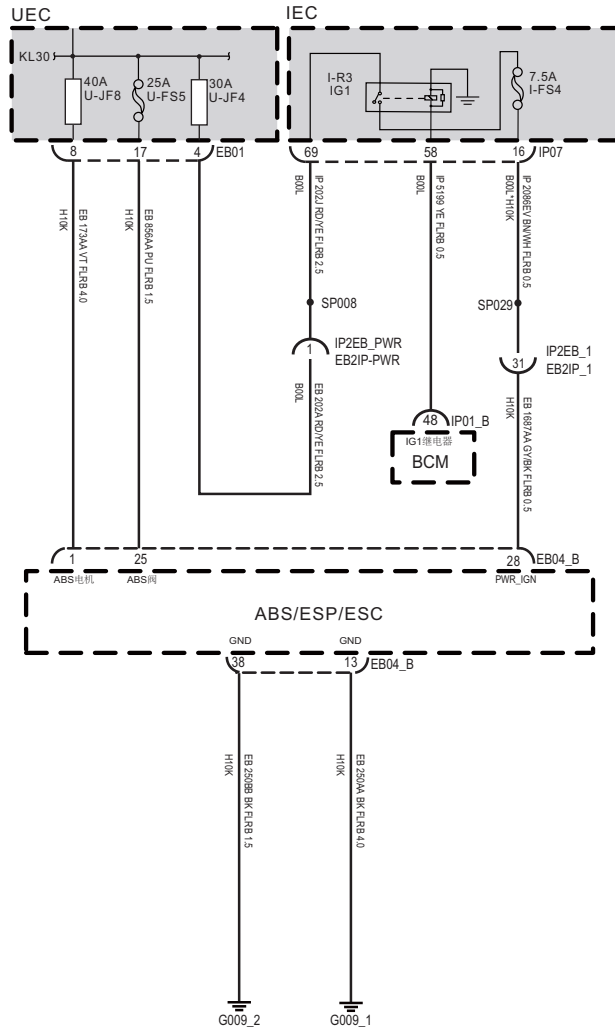

EB04_B

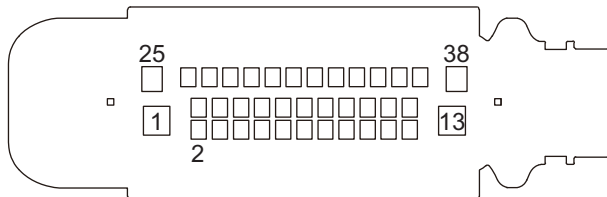

EK891029

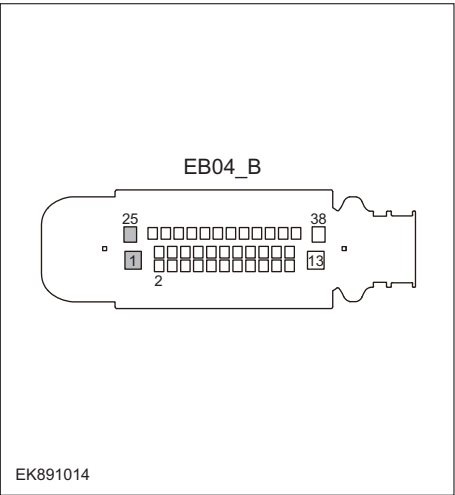
Troubleshooting steps	
Step 1	General inspection.
	<ol style="list-style-type: none"> 1 Check fuses U-JF8/U-SF5/I-FS4 for damage. 2 Check battery capacity. 3 Check the harness plug of ESC for damage, poor contact, aging and looseness. 4 Check whether the result is normal or not?
NO → Repair or replace the faulted parts.	
YES ↓	
Step 2	Check fault codes.
	<ol style="list-style-type: none"> 1 Connect the fault diagnosis instrument to the diagnosis interface. 2 Turn the ignition switch to ON position. 3 Check the ESC module with a diagnostic apparatus. 4 Is there any other fault code except for C1212-08、C1020-01、C1010-08?
YES → Refer to: DTC Summary List (ESC) .	
NO ↓	
Step 3	Check the battery voltage of ESC module.
	<ol style="list-style-type: none"> 1 Turn the ignition switch to OFF. 2 Disconnect the harness plug EB04_B of ESC module.. 3 Measure the voltage between Measuring circuit: voltage between terminal 1 on plug EB04_B and ground. Measuring circuit: voltage between terminal 25 on plug EB04_B and ground. Standard value:10~14V 4 Check whether the result is normal or not?
NO → Repair or replace the faulted parts.	
YES ↓	

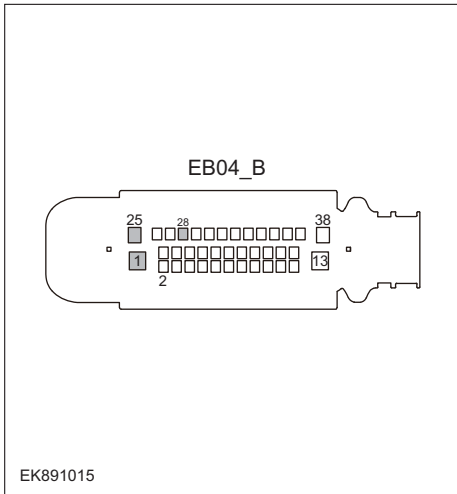
Step 4	Check the power voltage when the ESC module is started or operating
	<ol style="list-style-type: none"> 1 Turn the ignition switch to ON. 2 Measure the voltage between Measuring circuit: voltage between terminal 1 on plug EB04_B and ground. Measuring circuit: voltage between terminal 25 on plug EB04_B and ground. Measuring circuit: voltage between terminal 28 on plug EB04_B and ground. Standard value:10~14V 3 Check whether the result is normal or not?

NO → Repair or replace the faulted parts.

YES ↓

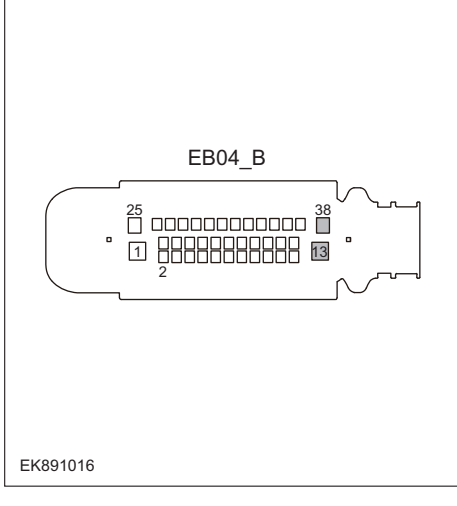
Step 5	Test whether the grounding circuit of ESC module is open.
	<ol style="list-style-type: none"> 1 Turn the ignition switch to OFF. 2 Disconnect the harness plug EB04_B of ESC module.. 3 Measure the resistance between harness plug of ESC module and ground. Measuring circuit: resistance between terminal 13 on plug EB04_B and ground. Measuring circuit: resistance between terminal 38 on plug EB04_B and ground. Standard value: < 1Ω 4 Test whether the resistance is less than 1Ω?

NO → Repair or replace the faulted parts.

YES ↓

ESC

Step 6	Check if ESC module is normal.
	<ol style="list-style-type: none"> 1 Turn the ignition switch to OFF. 2 Disconnect and check the harness plug EB04_B of ESC module. 3 Check and repair. <ul style="list-style-type: none"> • Corrosion(install new adapting piece or terminal-cleaning module and pin). • Pin damaged or bent-install new terminal/pin. 4 Fly out of pins-install new pins as needed. 5 Reconnect the air conditioning control module plug and all other previously disconnected plug. Make sure the pin is properly positioned and fixed. 6 Run the system and determine if the problem persists?
	YES → Replacing the ESC module.
NO ↓	
At this point the system is functioning normally. The problem may be caused by module connections. Address the root cause of any connector or pin problems,	
Next Step ↓	
Diagnosis end.	

C0045-10、C0044-60、C00A8-00、C00A9-00、C00AA-00、C00AB-00、C00AC-00、C0196-04、C1000-04、C0040-08、C0061-08、C0062-08、C0063-08、C0072-04

Description of fault diagnosis codes
C0045-10: Pressure sensor fault. (line)
C0044-60: Pressure sensor fault. (signal)
C00A8-00: IIS (Integrated Inertial Sensor) not calibrated or failed
C00A9-00: Wheel-speed sensor, front left:general error
C00AA-00: Wheel-speed sensor, front right:general error
C00AB-00: Wheel-speed sensor, front left:general error
C00AC-00: Wheel-speed sensor, rear right:general error
C0196-04: IIS (Integrated Inertial Sensor) fault: hardware failure, temperature, range, internal fault
C1000-04: ECU error (general system problem)
C0040-08: BLS fault:Plausibility
C0061-08: Lateral acceleration signal failure
C0062-08: Longitudinal acceleration signal failure
C0063-08: Yaw rate signal failure
C0072-04: Brake Disc Over heat
Detection tools
1 Multimeter and diagnostic apparatus
Possible causes
<ul style="list-style-type: none"> • Circuit,terminal and adapting piece fault • ESC module
Conditions for fault code operation
Turn the ignition switch to ON position.
Conditions for fault code setting
C0045-10
C0044-60
C00A8-00
C00A9-00
C00AA-00

ESC

C00AB-00
C00AC-00
C0196-04
C1000-04
C0040-08
C0061-08
C0062-08
C0063-08
C0072-04
To set the effect of a fault code condition
Description of circuit diagram
The ESC module will continuously monitor whether the sensor and actuator are in normal range. Meanwhile, it will check the connector for virtual connection, short circuit, open circuit and the connection rationality with other signals. In case of any fault, the body control module will save the fault code and enable the safety mode.

Circuit diagram

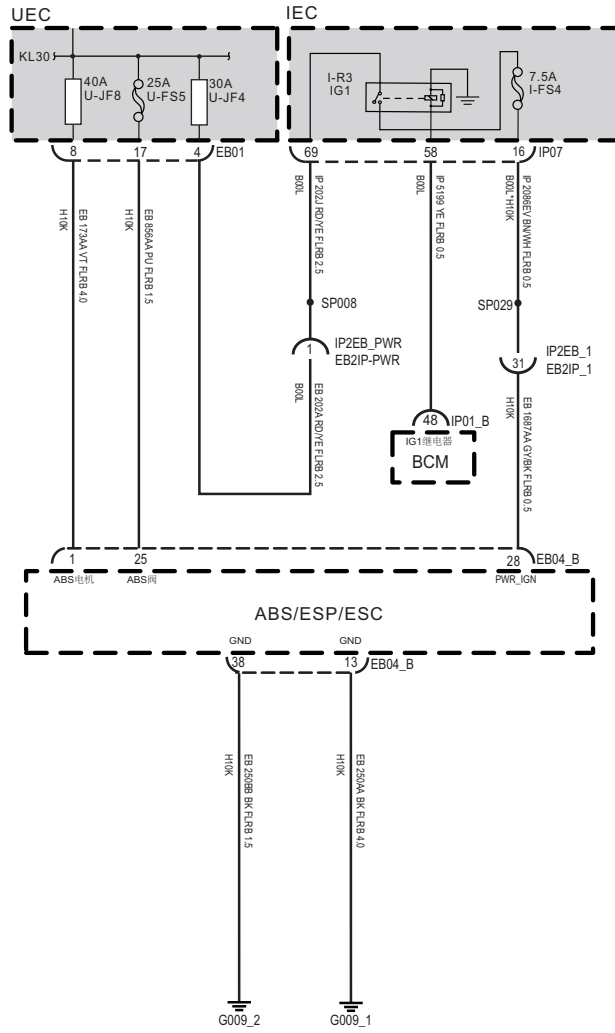

EB04_B

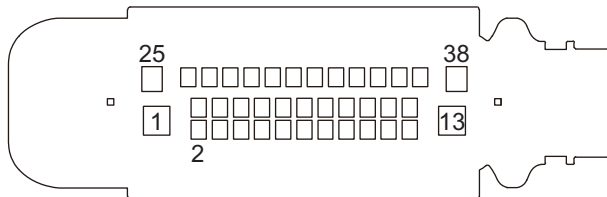

EK891029

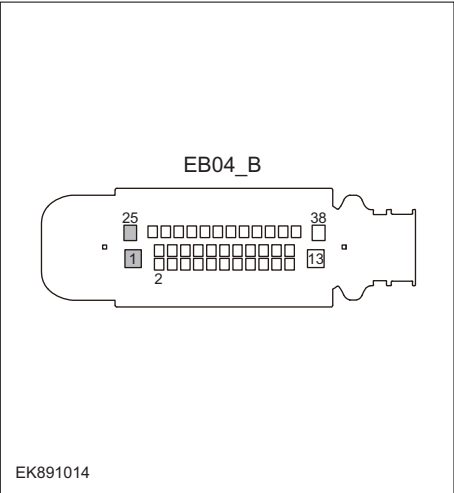
Troubleshooting steps	
Step 1	General inspection.
	<ol style="list-style-type: none"> 1 Check fuses U-JF8/U-FS5/I-FS4 for damage. 2 Check battery capacity. 3 Check the harness plug of ESC for damage, poor contact, aging and looseness. 4 Check whether the result is normal or not?
NO → Repair or replace the faulted parts.	
YES ↓	
Step 2	Check fault codes.
	<ol style="list-style-type: none"> 1 Connect the fault diagnosis instrument to the diagnosis interface. 2 Turn the ignition switch to ON position. 3 Check the ESC module with a diagnostic apparatus. 4 Is there any other fault code except for C0045-10, C0044-60, C00A8-00, C00A9-00, C00AA-00, C00AB-00, C00AC-00, C0196-04, C1000-04, C0040-08, C0061-08, C0062-08, C0063-08, C0072-04?
YES → Refer to: DTC Summary List (ESC) .	
NO ↓	
Step 3	Check the battery voltage of ESC module.
	<ol style="list-style-type: none"> 1 Turn the ignition switch to OFF. 2 Disconnect the harness plug EB04_B of ESC module.. 3 Measure the voltage between Measuring circuit: voltage between terminal 1 on plug EB04_B and ground. Measuring circuit: voltage between terminal 25 on plug EB04_B and ground. Standard value:10~14V 4 Check whether the result is normal or not?
NO → Repair or replace the faulted parts.	
YES ↓	

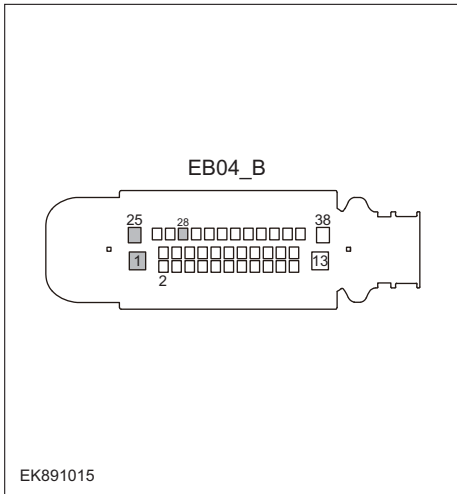
Step 4	Check the power voltage when the ESC module is started or operating
	<ol style="list-style-type: none"> 1 Turn the ignition switch to ON. 2 Measure the voltage between Measuring circuit: voltage between terminal 1 on plug EB04_B and ground. Measuring circuit: voltage between terminal 25 on plug EB04_B and ground. Measuring circuit: voltage between terminal 28 on plug EB04_B and ground. Standard value:10~14V 3 Check whether the result is normal or not?

NO → Repair or replace the faulted parts.

YES ↓

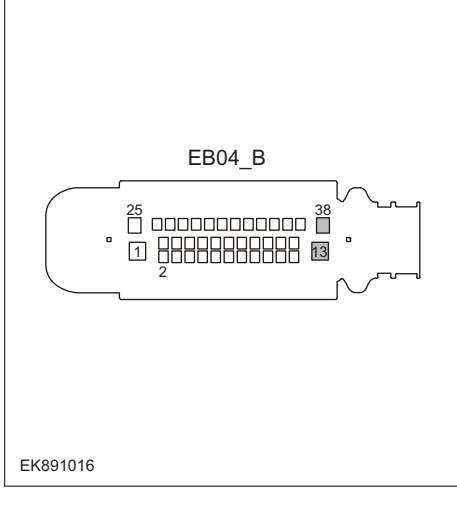
Step 5	Test whether the grounding circuit of ESC module is open.
	<ol style="list-style-type: none"> 1 Turn the ignition switch to OFF. 2 Disconnect the harness plug EB04_B of ESC module.. 3 Measure the resistance between harness plug of ESC module and ground. Measuring circuit: resistance between terminal 13 on plug EB04_B and ground. Measuring circuit: resistance between terminal 38 on plug EB04_B and ground. Standard value: < 1Ω 4 Test whether the resistance is less than 1Ω?

NO → Repair or replace the faulted parts.

YES ↓

ESC

Step 6	Check if ESC module is normal.
	<ol style="list-style-type: none">1 Turn the ignition switch to OFF.2 Disconnect and check the harness plug EB04_B of ESC module.3 Check and repair.<ul style="list-style-type: none">• Corrosion(install new adapting piece or terminal-cleaning module and pin).• Pin damaged or bent-install new terminal/pin.4 Fly out of pins-install new pins as needed.5 Reconnect the air conditioning control module plug and all other previously disconnected plug. Make sure the pin is properly positioned and fixed.6 Run the system and determine if the problem persists?
	YES → Replacing the ESC module.
NO ↓	
At this point the system is functioning normally. The problem may be caused by module connections. Address the root cause of any connector or pin problems,	
Next Step ↓	
Diagnosis end.	

C1900-04、 C1901-04

Description of fault diagnosis codes
C1900-04: ECU Voltage supply: high voltage
C1901-04: ECU Voltage supply: low voltage
Detection tools
1 Multimeter and diagnostic apparatus
Possible causes
<ul style="list-style-type: none"> • Circuit,terminal and adapting piece fault • Battery • ESC module • Charging system • Insurance fuse
Conditions for fault code operation
Turn the ignition switch to ON position.
Conditions for fault code setting
C1900-04
C1901-04
To set the effect of a fault code condition
Description of circuit diagram
The ESC module will continuously monitor whether the sensor and actuator are in normal range. Meanwhile,it will check the connector for virtual connection, short circuit, open circuit and the connection rationality with other signals. In case of any fault, the body control module will save the fault code and enable the safety mode.

Circuit diagram

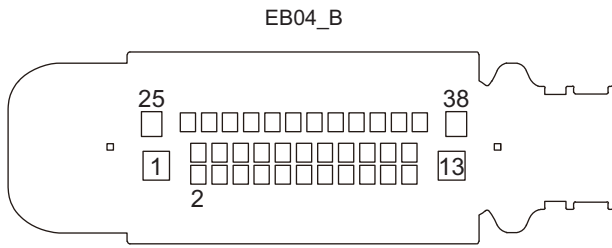
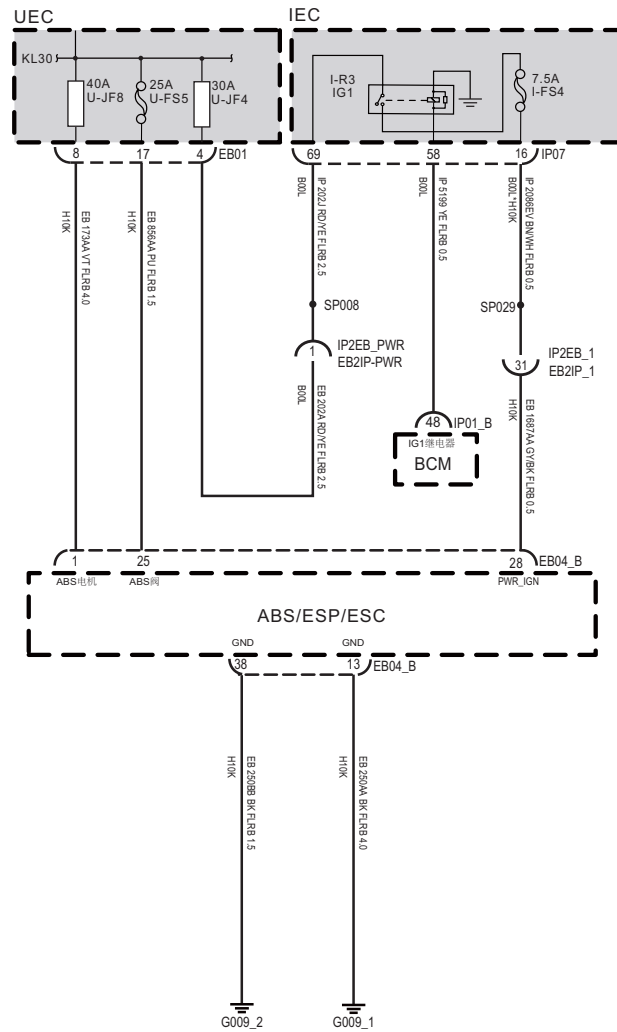

EK891029

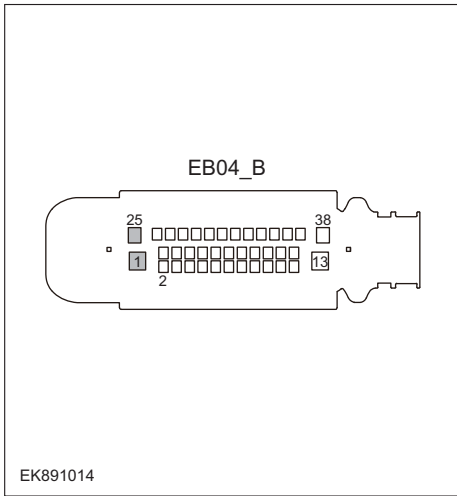
Troubleshooting steps	
Step 1	General inspection.
	<ol style="list-style-type: none"> 1 Check fuses U-JF8/U-FS5/I-FS4 for damage. 2 Check battery capacity. 3 Check the harness plug of ESC for damage, poor contact, aging and looseness. 4 Check whether the result is normal or not?
	NO → Repair or replace the faulted parts.
YES ↓	
Step 2	Check fault codes.
	<ol style="list-style-type: none"> 1 Connect the fault diagnosis instrument to the diagnosis interface. 2 Turn the ignition switch to ON position. 3 Check the ESC module with a diagnostic apparatus. 4 If there is any fault code except for C1900-04,C1901-04?
	YES → Refer to: DTC Summary List (ESC) .
NO ↓	
Step 3	Check the battery voltage of ESC module.
	<ol style="list-style-type: none"> 1 Turn the ignition switch to OFF. 2 Disconnect the harness plug EB04_B of ESC module.. 3 Measure the voltage between <p>Measuring circuit: voltage between terminal 1 on plug EB04_B and ground.</p> <p>Measuring circuit: voltage between terminal 25 on plug EB04_B and ground.</p> <p>Standard value:10~14V</p> 4 Check whether the result is normal or not?
	NO → Repair or replace the faulted parts.
YES ↓	

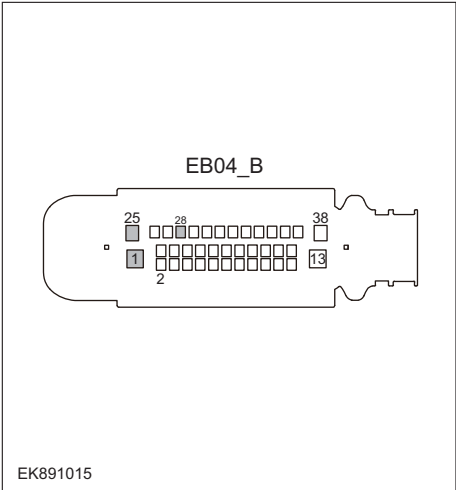
Step 4	Check the power voltage when the ESC module is started or operating
	<ol style="list-style-type: none"> 1 Turn the ignition switch to ON. 2 Measure the voltage between <p>Measuring circuit: voltage between terminal 1 on plug EB04_B and ground.</p> <p>Measuring circuit: voltage between terminal 25 on plug EB04_B and ground.</p> <p>Measuring circuit: voltage between terminal 28 on plug EB04_B and ground.</p> <p>Standard value:10~14V</p> 3 Check whether the result is normal or not?

NO → Repair or replace the faulted parts.

YES ↓

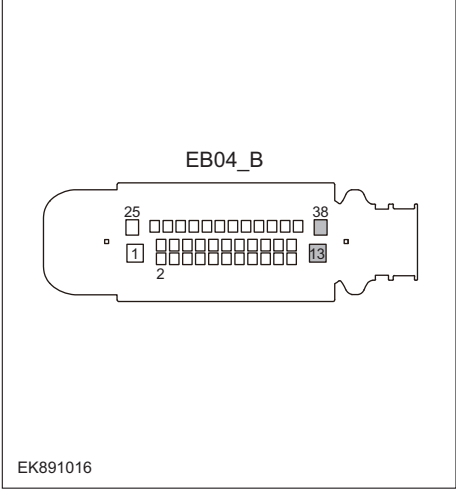
Step 5	Test whether the grounding circuit of ESC module is open.
	<ol style="list-style-type: none"> 1 Turn the ignition switch to OFF. 2 Disconnect the harness plug EB04_B of ESC module.. 3 Measure the resistance between harness plug of ESC module and ground. <p>Measuring circuit: resistance between terminal 13 on plug EB04_B and ground.</p> <p>Measuring circuit: resistance between terminal 38 on plug EB04_B and ground.</p> <p>Standard value: < 1Ω</p> 4 Test whether the resistance is less than 1Ω?

NO → Repair or replace the faulted parts.

YES ↓

Step 6	Check if ESC module is normal.
	<ol style="list-style-type: none"> 1 Turn the ignition switch to OFF. 2 Disconnect and check the harness plug EB04_B of ESC module. 3 Check and repair. <ul style="list-style-type: none"> • Corrosion(install new adapting piece or terminal-cleaning module and pin). • Pin damaged or bent-install new terminal/pin. 4 Fly out of pins-install new pins as needed. 5 Reconnect the air conditioning control module plug and all other previously disconnected plug. Make sure the pin is properly positioned and fixed. 6 Run the system and determine if the problem persists?
	YES → Replacing the ESC module.
NO ↓	
At this point the system is functioning normally. The problem may be caused by module connections. Address the root cause of any connector or pin problems,	
Next Step ↓	
Diagnosis end.	

C104C-04

Description of fault diagnosis codes
C104C-04: PATA switch failure
Detection tools
1 Multimeter and diagnostic apparatus
Possible causes
<ul style="list-style-type: none"> • Circuit, terminal and adapting piece fault • ESC module fault • Central control switch fault
Conditions for fault code operation
Turn the ignition switch to ON position.
Conditions for fault code setting
C104C-04
To set the effect of a fault code condition
1
2
Description of circuit diagram
The ESC module monitors the central control switch via low level reference circuit and signal circuit. The central control switch realizes relevant functions by sending the operation signal to the ESC module.

Circuit diagram

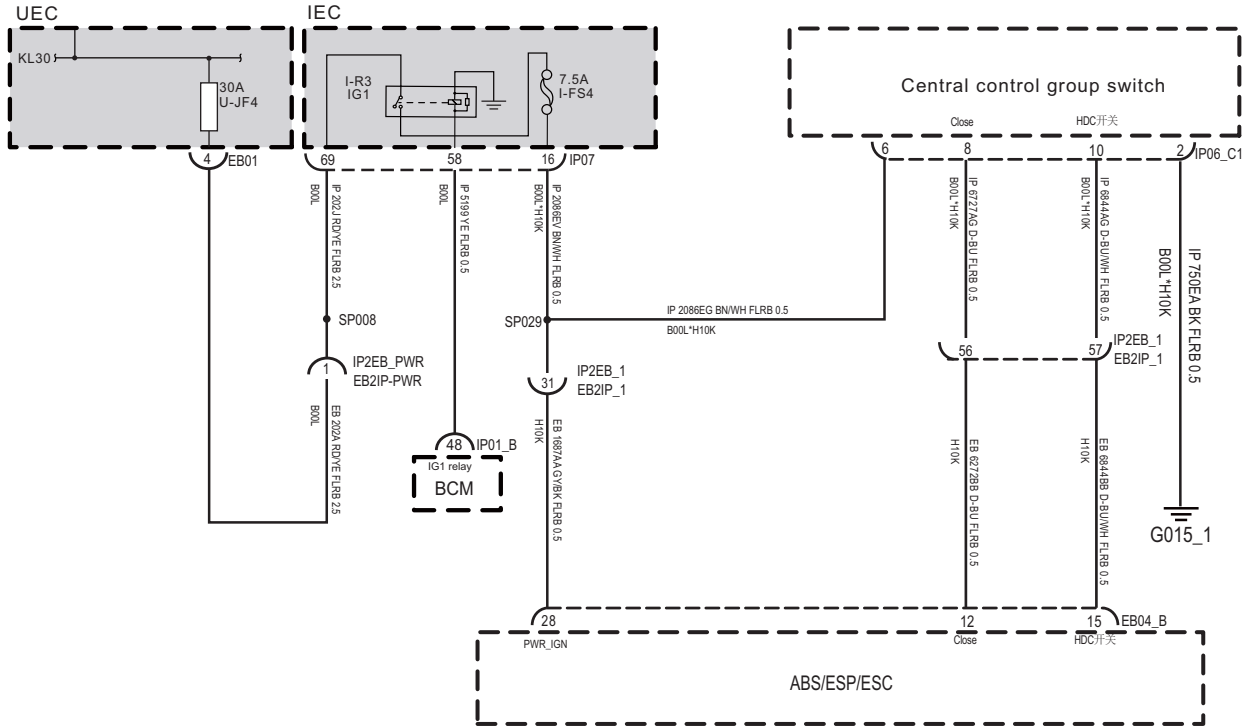

EB04_B

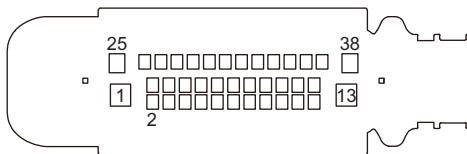

IP06_C1

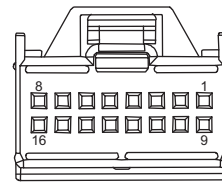

EK891017

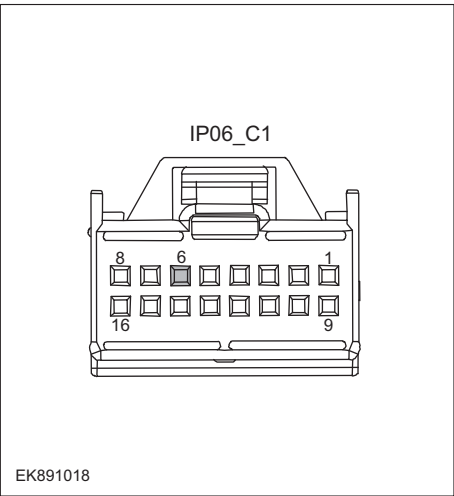
Troubleshooting steps	
Step 1	General inspection.
	<ol style="list-style-type: none"> 1 Check the fuse for damage. 2 Check battery capacity. 3 Check the harness plug of central control switch , ESC for damage, poor contact, aging and looseness. 4 Check whether the result is normal or not?
	NO → Repair or replace the faulted parts.
YES ↓	
Step 2	Check fault codes.
	<ol style="list-style-type: none"> 1 Connect the fault diagnosis instrument to the diagnosis interface. 2 Turn the ignition switch to ON position. 3 Check the ESC module with a diagnostic apparatus. 4 Is there any other fault code except for C104C-04?
	YES → Refer to: DTC Summary List (ESC) .
NO ↓	
Step 3	Check the power supply circuit of central control switch circuit.
	<ol style="list-style-type: none"> 1 Turn the ignition switch to OFF. 2 Disconnect the harness plug IP06_C1 of central control switch. 3 Turn the ignition switch to ON. 4 Measure the voltage between the harness terminal of central control switch and ground. Measuring circuit: voltage between terminal 6 on plug IP06_C1 and ground. Standard value:10~14V 5 Check whether the result is normal or not?
	NO → Repair or replace the faulted parts.
YES ↓	

Step 4 Check the circuit of central control switch circuit (open circuit)

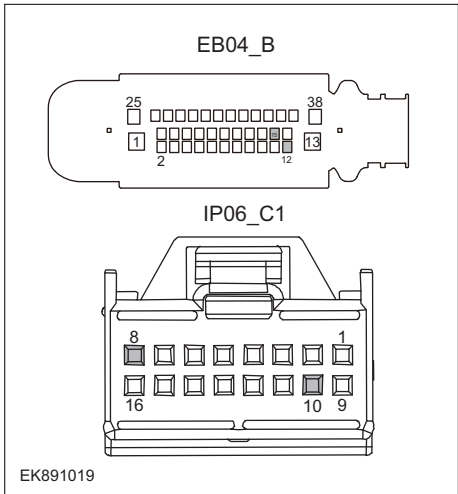

- 1 Turn the ignition switch to OFF.
- 2 Disconnect the harness plug EB04_B of ESC module..
- 3 Measure the resistance between harness terminals on central control switch and ESC module.

Measuring circuit: resistance between terminal 8 on plug IP06_C1 and terminal 12 on plug EB04_B.

Measuring circuit: resistance between terminal 10 on plug IP06_C1 and terminal 15 on plug EB04_B.

Standard value: $\approx 0\Omega$
- 4 Check whether the result is normal or not?

NO → Repair or replace the faulted parts.

YES ↓

Step 5 Check the circuit of central control switch circuit (short circuit)

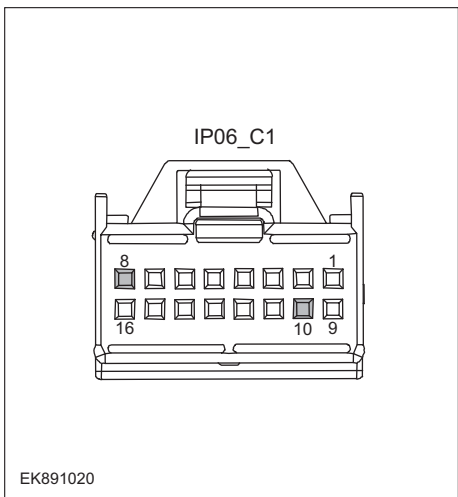

- 1 Turn the ignition switch to OFF.
- 2 Measure the resistance between the harness terminal of central control switch and ground.

Measuring circuit: resistance between terminal 8 on plug IP06_C1 and ground.

Measuring circuit: resistance between terminal 10 on plug IP06_C1 and ground.

Standard value: ∞
- 3 Measure the voltage between the harness terminal of central control switch and ground.

Measuring circuit: voltage between terminal 8 on plug IP06_C1 and ground.

Measuring circuit: voltage between terminal 10 on plug IP06_C1 and ground.

Standard value: $\approx 0V$
- 4 Check whether the result is normal or not?

NO → Repair or replace the faulted parts.

YES ↓

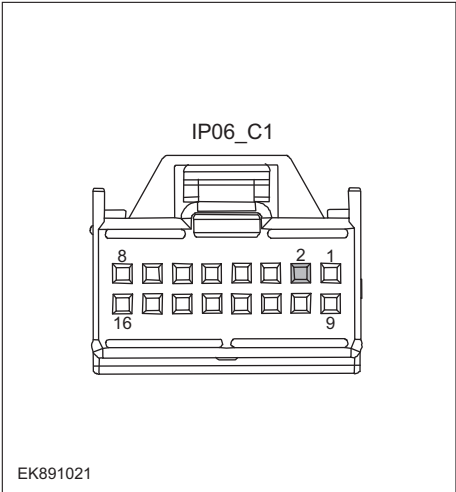
Step 6	Check whether the grounding circuit of central control switch circuit is open.
	<ol style="list-style-type: none"> 1 Turn the ignition switch to OFF. 2 Measure the resistance between the harness terminal of central control switch and ground. Measuring circuit: resistance between terminal 2 on plug IP06_C1 and ground. Standard value: < 1Ω 3 Test whether the resistance is less than 1Ω?
NO → Repair the central control switch.	
YES ↓	
Step 7	Check if ESC module is normal.
	<ol style="list-style-type: none"> 1 Turn the ignition switch to OFF. 2 Disconnect and check the harness plug EB04_B of ESC module. 3 Check and repair. <ul style="list-style-type: none"> • Corrosion(install new adapting piece or terminal-cleaning module and pin). • Pin damaged or bent-install new terminal/pin. • Fly out of pins-install new pins as needed. 4 Reconnect the air conditioning control module plug and all other previously disconnected plug. Make sure the pin is properly positioned and fixed. 5 Run the system and determine if the problem persists?
YES → Replace the air conditioning control module.	
NO ↓	
At this point the system is functioning normally. The problem may be caused by module connections. Address the root cause of any connector or pin problems,	
Next Step ↓	
Diagnosis end.	

U0001-04、U0126-87、U0104-04、U0140-87、U0155-87、U0164-00、U0422-81、U0423-81、U0428-81、U0104-08、U0401-81、U0164-08、U0007-00、U0005-00、C1001-04、U0100-87

Description of fault diagnosis codes
U0001-04: CAN Bus off
U0126-87: Lost communication with SAS
U0104-04: Lost communication with DAS(Applicable for ACC node)
U0140-87: Lost communication with BCM
U0155-87: Lost communication with IPK
U0164-00: Lost communication with HVAC
U0422-81: Invalid Data Received From BCM
U0423-81: Invalid Data Received From IPK
U0428-81: Invalid Data Received From SAS
U0104-08: Invalid Data Received From DAS(Applicable for ACC node)
U0401-81: Invalid Data Received From EMS
U0164-08: Invalid Data Received From HVAC
U0007-00: CAN Bus under voltage
U0005-00: CAN Bus over voltage
C1001-04: CAN Hardware Error
U0100-87: Lost communication with EMS
Detection tools
1 Multimeter and diagnostic apparatus
Possible causes
<ul style="list-style-type: none"> • Circuit,terminal and adapting piece fault • ESC module
Conditions for fault code operation
Turn the ignition switch to ON position.
Conditions for fault code setting
U0001-04
U0126-87
U0104-04
U0140-87

ESC

U0155-87
U0164-00
U0422-81
U0423-81
U0428-81
U0104-08
U0401-81
U0164-08
U0007-00
U0005-00
C1001-04
U0100-87
To set the effect of a fault code condition
Description of circuit diagram
The device is connected to serial data circuit, which is used to monitor the communication situation of serial data during normal operation of vehicle. The devices will exchange the operation information and commands mutually. The device has programming information required to be exchanged on the serial data circuit. The receiver device will also monitor such information; in addition, there are some regular information indication transmitter devices available.

Circuit diagram

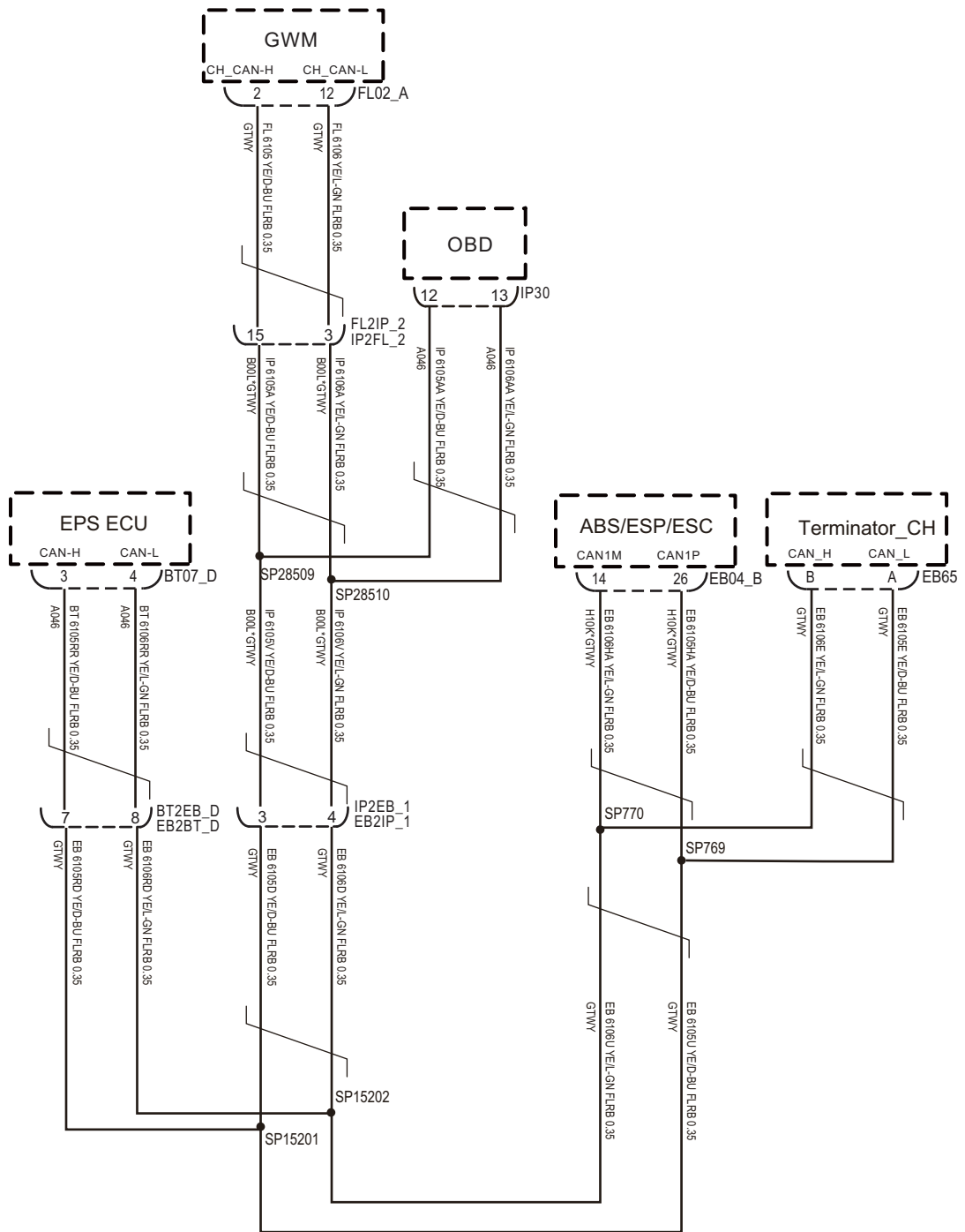

EK891022

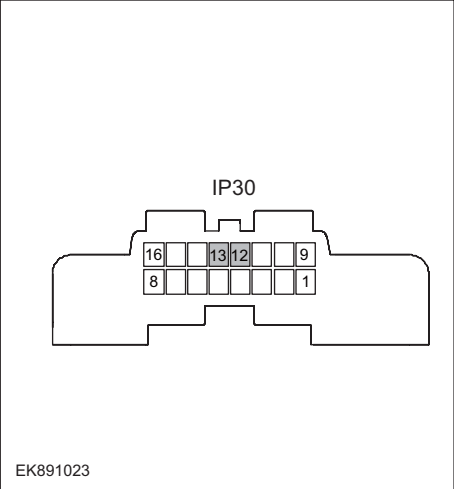
Troubleshooting steps	
Step 1	General inspection.
	<ol style="list-style-type: none"> 1 Check the fuse for damage. 2 Check battery capacity. 3 Check the harness plug of ESC for damage, poor contact, aging and looseness. 4 Check whether the result is normal or not?
	NO → Repair or replace the faulted parts.
YES ↓	
Step 2	Check fault codes.
	<ol style="list-style-type: none"> 1 Connect the fault diagnosis instrument to the diagnosis interface. 2 Turn the ignition switch to ON position. 3 Check the ESC module with a diagnostic apparatus. 4 Is there any other fault code except for U0001-04、U0126-87、U0104-04、U0140-87、U0155-87、U0164-00、U0422-81、U0423-81、U0428-81、U0104-08、U0401-81、U0164-08、U0007-00、U0005-00、C1001-04、U0100-87?
	YES → Refer to: DTC Summary List (ESC) .
NO ↓	
Step 3	Inspection for CAN communication network completeness.
	<ol style="list-style-type: none"> 1 Turn the ignition switch to OFF. 2 Measure the resistance between the harness terminals of diagnose interface. Measuring circuit: resistance between terminal 12 and terminal 13 on plug IP30. Standard value: $\approx 60\Omega$ 3 Check whether the result is normal or not?
	NO → Repair or replace the faulted parts.
YES ↓	

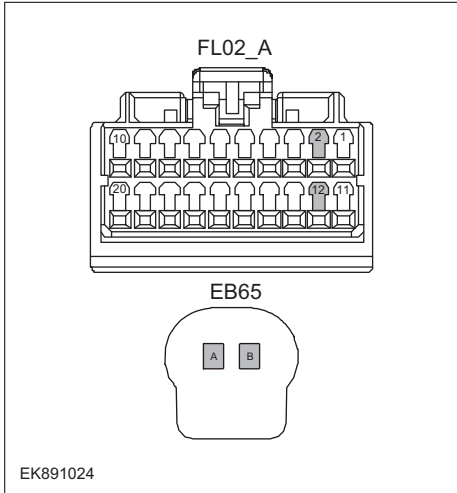
Step 4	Check the terminating resistance of network gateway module and CH resistor.
	<ol style="list-style-type: none"> 1 Turn the ignition switch to OFF. 2 Disconnect the harness plug FL02_A of network gateway module. 3 Measure the resistance between harness terminals on network gateway module. Measuring circuit: resistance between terminal 2 and terminal 12 on plug FL02_A. Standard value: 110~130Ω 4 Connect the harness plug FL02_A of network gateway module. 5 Disconnect the harness plug EB65 of CH CAN resistor. 6 Measure the resistance between the harness terminals of CH CAN resistor. Measuring circuit: resistance between terminal A and terminal B on plug EB65. Standard value: 110~130Ω 7 Check whether the result is normal or not?
<p>NO → Replacing the ESC module.</p>	
<p>YES ↓</p>	
Step 5	Check if ESC module is normal.
	<ol style="list-style-type: none"> 1 Turn the ignition switch to OFF. 2 Disconnect and check the harness plug EB04_B of ESC module. 3 Check and repair. <ul style="list-style-type: none"> • Corrosion(install new adapting piece or terminal-cleaning module and pin). • Pin damaged or bent-install new terminal/pin. • Fly out of pins-install new pins as needed. 4 Reconnect the air conditioning control module plug and all other previously disconnected plug. Make sure the pin is properly positioned and fixed. 5 Run the system and determine if the problem persists?
<p>YES → Replace the air conditioning control module.</p>	
<p>NO ↓</p>	
<p>At this point the system is functioning normally. The problem may be caused by module connections. Address the root cause of any connector or pin problems,</p>	
<p>Next Step ↓</p>	
<p>Diagnosis end.</p>	

DTC Summary list(BCM)

DTC	英文描述	参考页
U3003-16	BCM Voltage below the Low_Threshold	U3003-16、 U3003-17
U3003-17	BCM Voltage above the High_Threshold	
U1001-11	LIN Short to Ground	U1001-11、 U1F62-87、 U1F63-87
U1F62-87	LIN Message CETC_Motor_RLSTime out	
U1F63-87	LIN Messag RLS_NorRunning_DiagTime out	
U0073-88	CAN bus off	U0073-88
U0073-87	CAN ABS Communication time out	U0073-87
U0121-87	CAN EMS Communication time out	U0121-87
U0155-87	CAN IPK Communication time out	U0155-87
U0151-87	CAN SRS Communication time out	U0151-87
U0101-87	CAN TCU Communication time out	U0101-87
U0152-87	CAN ESP Communication time out	U0152-87
U0153-87	CAN FICM Communication time out	U0153-87
U0154-87	CAN SAS Communication time out	U0154-87
B1001-11	Roof lamp HSD output short to GND	B1001-11、 B1002-12、
B1002-12	Roof lamp LSD output short to battery	
B1003-13	Reverse lamp output open	B1003-13、 B1003-11
B1003-11	Reverse lamp output short to GND	
B1004-13	Brake lamp output open	B1004-13、 B1004-11
B1004-11	Brake lamp output short to GND	
B1005-13	Trunk lamp output open	B1005-13、 B1005-11
B1005-11	Trunk lamp output short to GND	
B1006-13	Daytime lamp output open	B1006-13、 B1006-12
B1006-12	Daytime lamp output short to Battery	
B1007-13	Turn lamp left output open	B1007-13、 B1007-11、 B1008-13、 B1008-11
B1007-11	Turn lamp left output short to GND	
B1008-13	Turn lamp right output open	
B1008-11	Turn lamp right output short to GND OFF	
B1009-13	Rear fog lamp output open	B1009-13、 B1009-12
B1009-12	Rear fog lamp output short to Battery	
B100A-13	Position lamp output open	B100A-13、 B100A-12
B100A-12	Position lamp output short to Battery	
B100C-12	Dipped beam relay output short to battery	B100C-12
B100D-12	Main beam relay output short to battery	B100D-12

BCM

DTC	英文描述	参考页
B100E-12	Front fog relay output short to battery	B100E-12
B1010-12	Horn relay output short to battery	B1010-12
B1011-12	Mirror and HRW relay output short to battery	B1011-12
B1012-12	Front wiper power relay output short to battery	B1012-12 、 B1013-12 、 B1014-1E 、 B1014-12
B1013-12	Front wiper speed relay output short to battery	
B1014-1E	Front wiper intermittent input out of range	
B1014-12	Front wiper SW short to battery	
B1502-51	IMMONotSaveAnyKeyInformation	B1500-13 、 B1502-55
B1500-13	IMMO Antenna Failure, Antenna Open or Short Circuit	
B1503-51	Not Programed	Program the BCM module using a diagnostic instrument and clear the fault code
B1504-51	Not Programed	
B1505-55	Not Programed	
B1506-87	No ECM Challenge Rx: No challenge received within 2seconds of KL.15	B1506-87 、 B1506-62 、 B1501-29 、 B162F-42 、 B1022-04
B1506-62	ECM Authentication Failure	
B1501-29	Key Authentication Failure F	
B162F-42	EEPROM(NVM) Error	
B1022-04	System internal failure	
B1507-08	Basestation Communication Error	B1507-08 、 U0423-62 、 U0424-62
U0423-62	Signal compare failure Odometer	
U0424-62	Signal compare failure VIN not equal with IPK's	
U1532-00	ASIC_Error LIN signal: ASIC_Error =1	U1532-00 、 U1533-00 、 U1534-00 、 U1535-00 、 U1536-00
U1533-00	Rain Channel A Error LIN signal: Rain Channel A Error=1	
U1534-00	Rain Channel B Error LIN signal: Rain Channel B Error=1	
U1535-00	Ambient Light Error LIN signal: Ambient Light Error =1	
U1536-00	Solar Sensor Error LIN signal: Solar Sensor Error =1	
U1537-00	RLS Auto Config Error LIN signal: RLS Auto Config Error=1	U1537-00 、 U1538-00 、 U1539-00 、 U153A-00 、 U153B-00 、 U153C-00
U1538-00	RLS's Far(Ambient-D) Light Works Fault LIN signal: Err_Ambient_D=7 for 5 times	
U1539-00	RLS Powerup is more than High-Voltage LIN signal: Err_PORup=1 for 5 times	
U153A-00	RLS Powerup is less than Low-Voltage LIN signal: Err_PORup=2 for 5 times	
U153B-00	RLS's Wiper always Stops at the Park Position LIN signal: Err_Wiper_Status=3 for 5 times	
U153C-00	RLS's Wiper always doesn't Stop at the Park Position LIN signal: Err_Wiper_Status=8 for 5 times	
B1401-77	Front wiper stall	B1401-77
B1205-94	HAZARD_SW Sticky	B1205-94

DTC	英文描述	参考页
B1162-11	SSW Circuit short to ground	B1162-11 、 B1162-13 、 B1162-1E
B1162-13	SSW Circuit open circuit	
B1162-1E	SSW Circuit resistance out of range	
U0156-87	Missing message	U0156-87
B1166-11	Circuit short to ground	B1166-11 、 B1167-11 、 B1168-12
B1167-11	Circuit short to ground	
B1168-12	Circuit short to battery	
B1169-11	Gear Shift input Circuit short to ground	B1169-11 、 B1169-13 、 B1120-1E
B1169-13	Gear Shift input Circuit open circuit	
B1169-1E	Gear Shift input resistance out of range	
B1206-94	The overtaking light switch is sticky	B1206-94
B1170-11	Brake SW input Circuit short to ground	B1170-11 、 B1170-12 、 B1175-11 、 B1175-12
B1170-12	Brake SW input short to battery	
B1175-12	5V short to battery (J2-05, Medium low, low configuration)	
B1176-11	5V short to ground (J1-46, Medium low, low configuration)	
B1172-1E	MLS SW out of range	B1172-1E
B1173-11	Dimmer SW input Circuit short to ground	B1173-11 、 B1173-1E
B1173-1E	Dimmer SW input out of range	
B1175-11	5V_VCC_OUTPUT short to ground (J2-05, Medium low, low configuration)	B1176-11 、 B1176-12
B1176-12	5V short to battery (J1-46, Medium low, low configuration)	

U3003-16、 U3003-17

Fault diagnosis code
U3003-16: threshold BCM Voltage Low
U3003-17: threshold BCM Voltage High
Detection tools
1 Multimeter and diagnostic apparatus
Possible causes
<ul style="list-style-type: none"> • Circuit,terminal and adapting piece fault • Battery • BCM • Charging system • Insurance fuse
Conditions for fault code operation
Turn the ignition switch to ON position.
Conditions for fault code setting
U3003-16
U3003-17
To set the effect of a fault code condition
Description of circuit diagram
The body control module will continuously monitor whether the sensor and actuator are in normal range. Meanwhile,it will check the connector for virtual connection, short circuit, open circuit and the connection rationality with other signals. In case of any fault, the body control module will save the fault code and enable the safety mode.

Circuit diagram

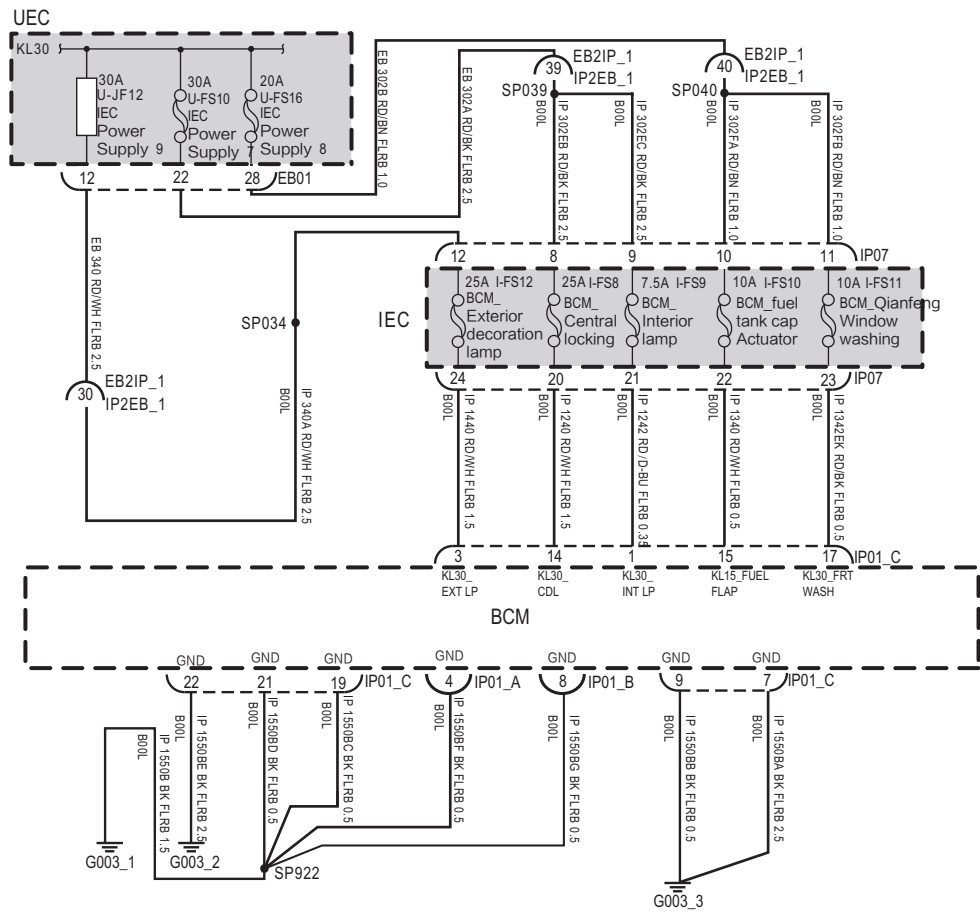

IP01_A

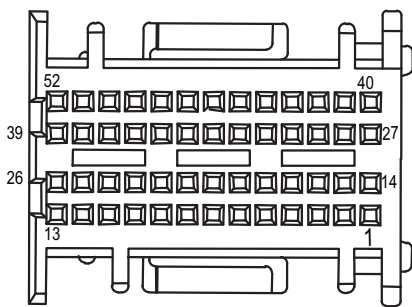

IP01_B

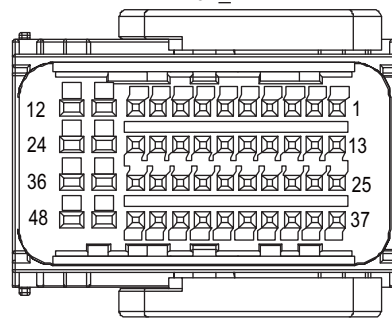

IP01_C

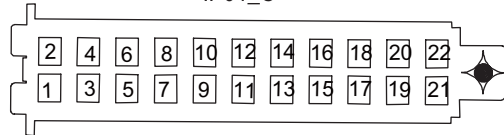

EK890001

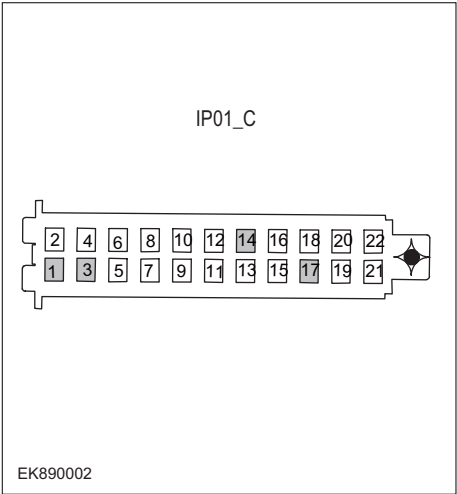
Troubleshooting steps	
Steps1	General inspection.
	<ol style="list-style-type: none"> 1 Check fuses U-JF12、 U-FS10、 U-FS16 for damage 2 Check battery capacity. 3 Check the harness plug of air conditioning control module for damage, poor contact, aging and looseness. 4 Check whether the result is normal or not?
NO → Repair or replace the faulted parts.	
YES ↓	
Steps2	Check fault codes.
	<ol style="list-style-type: none"> 1 Connect the fault diagnosis instrument to the diagnosis interface. 2 Turn the ignition switch to ON position. 3 Diagnosticsing BCM using a diagnostics. 4 If there is any fault code except for U3003-16、 U3003-17?
YES → Refer to: DTC Summary list(BCM)	
NO ↓	
Steps3	Check the power voltage of BCM battery.
	<ol style="list-style-type: none"> 1 Turn the ignition switch to OFF. 2 Disconnect the BCM harness plug IP01_C. 3 Measure the voltage between the BCM harness terminals and ground. Measuring circuit: IP01_C voltage between plug 1 and ground. Measuring circuit: IP01_C voltage between plug 3 and ground. Measuring circuit: IP01_C voltage between plug 14 and ground. Measuring circuit: IP01_C voltage between plug 17 and ground. Standard value:10~14V 4 Check whether the result is normal or not?
NO → Repair or replace the faulted parts.	
YES ↓	

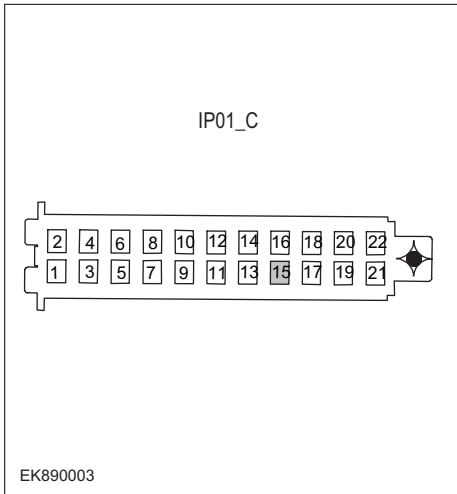
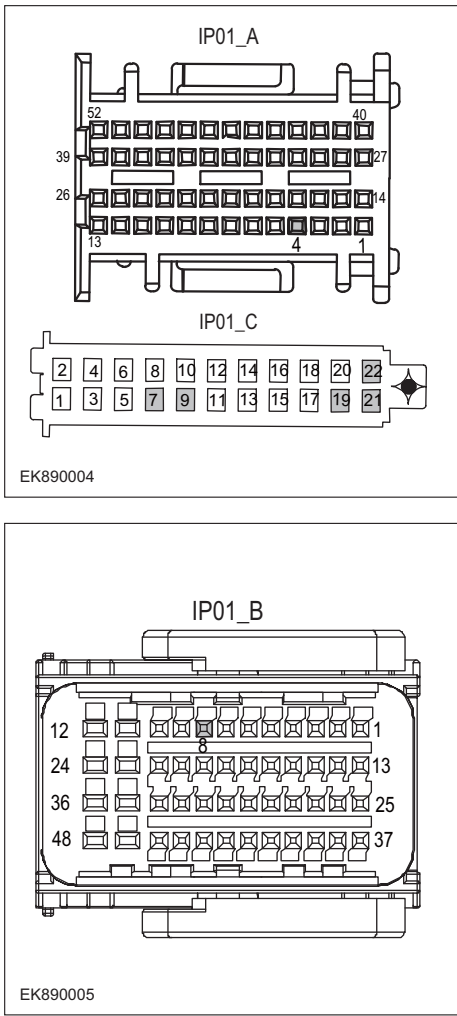
Steps4	Check the supply voltage in the BCM start-up or operating condition.
	<ol style="list-style-type: none"> 1 Turn the ignition switch to ON. 2 Measure the voltage between the IP01_C harness terminal and ground. Measuring circuit: voltage between terminal 15 on plug IP01_C and ground. Standard value:10~14V 3 Check whether the result is normal or not?
NO → Repair or replace the faulted parts.	
YES ↓	
Steps5	Check if the BCM grounding circuit is open.
	<ol style="list-style-type: none"> 1 Turn the ignition switch to OFF. 2 Measure the resistance between the harness terminal of BCM and ground. 3 Measure the resistance between the BCM harness plug and ground. Measuring circuit: resistance between terminal 22 of IP01_C plug and ground. Measuring circuit: resistance between terminal 21 of IP01_C plug and ground. Measuring circuit: resistance between No.19 terminal of IP01_C plug and ground. Measuring circuit: resistance between terminal 4 of IP01_A plug and ground. Measuring circuit: resistance between No.8 terminal of IP01_B plug and ground. Measuring circuit: resistance between No.9 terminal of IP01_C plug and ground. Measuring circuit: resistance between terminal 7 of IP01_C plug and ground. Standard value:< 1Ω 4 Test whether the resistance is less than 1Ω?
NO → Repair or replace the faulted parts.	
YES ↓	

BCM

Steps6	Test whether BCM is norm.
	<ol style="list-style-type: none"> 1 Turn the ignition switch to OFF. 2 Disconnect and check the connectors IP01_A, IP01_B and IIP01_C of BCM harness. 3 Check and repair. <ul style="list-style-type: none"> • Corrosion(install new adapting piece or terminal-cleaning module and pin). • Pin damaged or bent-install new terminal/pin. • Fly out of pins-install new pins as needed. 4 Reconnect the BCM plug and all other previously disconnected plug. Make sure the pin is properly positioned and fixed. 5 Run the system and determine if the problem persists?
	YES → Replace the BCM.
NO ↓	
At this point the system is functioning normally. The problem may be caused by module connections. Address the root cause of any connector or pin problems,	
Next Step ↓	
Diagnosis end.	

U1001-11、 U1F62-87、 U1F63-87

Fault diagnosis code
U1001-11: LIN Short to Ground
U1F62-87: LIN Message CETC_Motor_RLSTime out
U1F63-87: LIN Messag RLS_NorRunning_DiagTime out
Detection tools
1 Multimeter and diagnostic apparatus
Possible causes
<ul style="list-style-type: none"> • Line, terminal or connector failure • BCM • PEPS • IMMO • Fuse failure
Conditions for fault code operation
Turn the ignition switch to ON position.
Conditions for fault code setting
U1001-11
U1F62-87
U1F63-87
To set the effect of a fault code condition
1
2
Description of circuit diagram

Circuit diagram

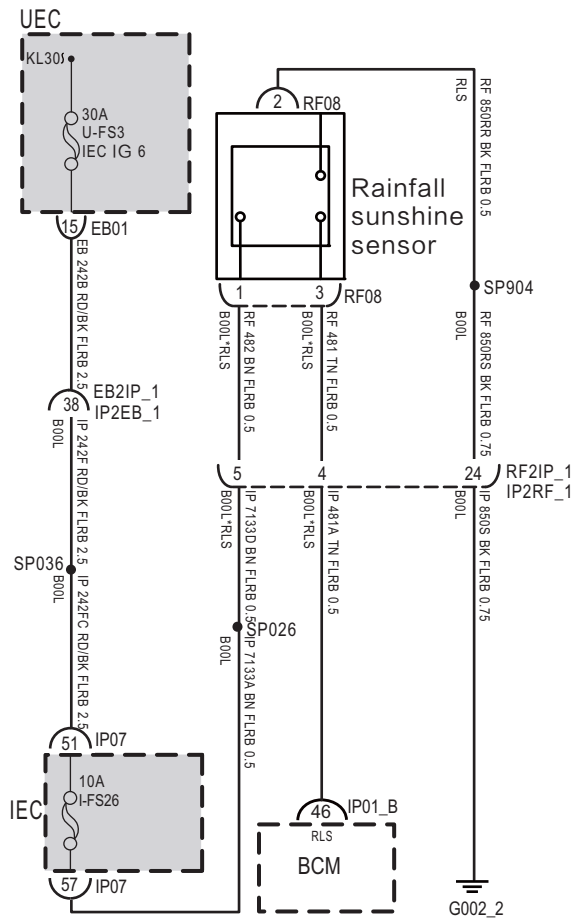

IP01_B

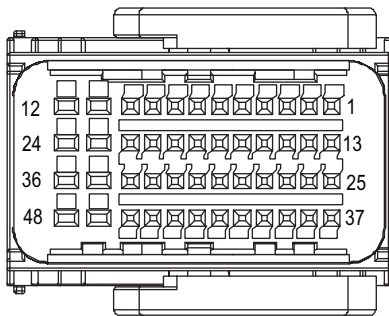

RF08

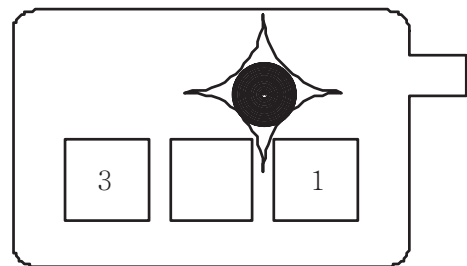

EK890062

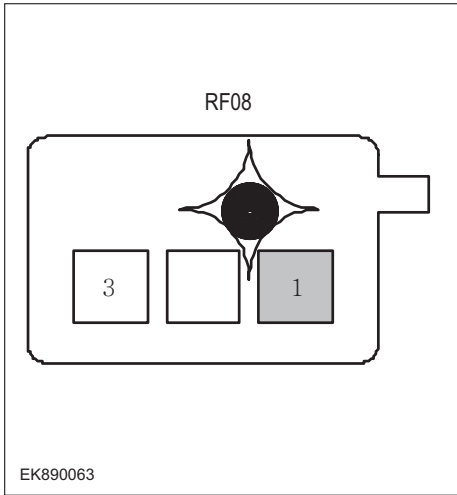
Troubleshooting steps	
Steps1	General inspection.
	<ol style="list-style-type: none"> 1 Check fuses U-FS3、 I-FS26 for damage 2 Check battery capacity. 3 Check the harness plug of air conditioning control module for damage, poor contact, aging and looseness. 4 Check whether the result is normal or not?
	NO → Repair or replace the faulted parts.
YES ↓	
Steps2	Check fault codes.
	<ol style="list-style-type: none"> 1 Connect the fault diagnosis instrument to the diagnosis interface. 2 Turn the ignition switch to ON position. 3 Diagnosticing BCM using a diagnostics. 4 If there is any fault code except for U1001-11、 U1F62-87、 U1F63-87?
	YES → Refer to: DTC Summary list(BCM)
NO ↓	
Steps3	Check the power supply voltage of rainfall sunshine sensor.
	<ol style="list-style-type: none"> 1 Turn the ignition switch to OFF. 2 Disconnect the rain sunshine sensor harness plug RF08. 3 Measure the voltage between the rain sunshine sensor harness terminal and ground. Measuring circuit: voltage between terminal 1 of RF08 plug and ground. Standard value:10~14V 4 Check whether the result is normal or not?
	NO → Repair or replace the faulted parts.
YES ↓	

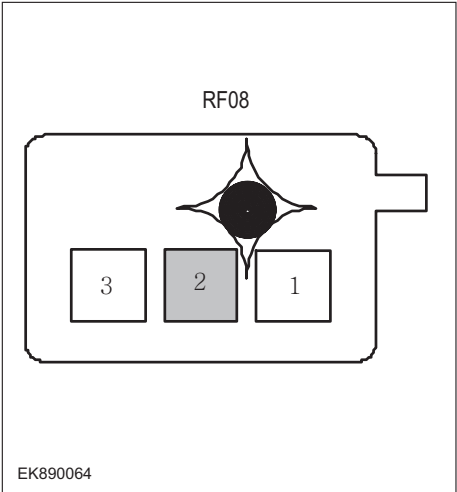
Steps4	Check the rain sunshine sensor ground circuit for an open circuit.
	<ol style="list-style-type: none"> 1 Turn the ignition switch to OFF. 2 Disconnect the harness plug RF08 of the sunshine sensor. 3 Measure the resistance between harness plug of sunshine sensor and ground. Measure the resistance between harness plug of sunshine sensor and ground. Standard value:< 1Ω 4 Test whether the resistance is less than 1Ω?

NO → Repair or replace the faulted parts.

YES ↓

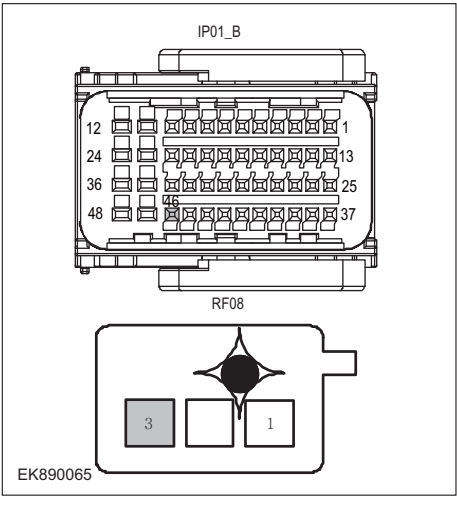
Steps5	Check the circuit between BCM and sunshine rain sensor.
	<ol style="list-style-type: none"> 1 Turn the ignition switch to OFF. 2 Disconnect BCM harness plug IP01 _ b. 3 Disconnect the harness plug RF08 of the sunshine rain sensor. 4 Measure the resistance between BCM harness plug and sunshine rain sensor harness plug. Measuring circuit: resistance between No.46 terminal of IP01_B plug and No.3 terminal of RF08 plug. Standard value:< 1Ω 5 Test whether the resistance is less than 1Ω?

NO → Repair or replace the faulted parts.

YES ↓

Steps6	Replace the sunshine rain sensor in good condition.
	<ol style="list-style-type: none"> 1 Replace the sunshine rain sensor in good condition. 2 Reconnect all disconnected harness terminals. 3 Connect the fault diagnosis instrument to the diagnosis interface. 4 Turn the ignition switch to ON position. 5 Read the BCM Diagnostic Trouble Code (DTC) with a scan tool. 6 Clear the BCM diagnostic trouble code (DTC). 7 Turn the ignition switch to OFF. 8 Wait at least 15 seconds to allow the module to shut down correctly. 9 Turn the ignition switch to ON again. 10 Read the DTC again. 11 Does the fault code still exist?
NO → Replace the sunshine rainfall sensor.	
YES ↓	
Steps7	Test whether BCM is norm.
	<ol style="list-style-type: none"> 1 Turn the ignition switch to OFF. 2 Disconnect and check the harness plug IP01_A、IP01_B、IP01_C of BCM. 3 Check and repair. <ul style="list-style-type: none"> • Corrosion(install new adapting piece or terminal-cleaning module and pin). • Pin damaged or bent-install new terminal/pin. • Fly out of pins-install new pins as needed. 4 Reconnect the BCM plug and all other previously disconnected plug. Make sure the pin is properly positioned and fixed. 5 Run the system and determine if the problem persists?
YES → Replace the BCM.	
NO ↓	
At this point the system is functioning normally. The problem may be caused by module connections. Address the root cause of any connector or pin problems,	
Next Step ↓	
Diagnosis end.	

U0073-88

Fault diagnosis code
U0073-88: CAN bus off
Detection tools
1 Multimeter and diagnostic apparatus
Possible causes
<ul style="list-style-type: none"> • Lines, terminals or connectors • BCM
Conditions for fault code operation
Turn the ignition switch to ON position.
Conditions for fault code setting
U0073-88
To set the effect of a fault code condition
Description of circuit diagram
The device is connected to serial data circuit, which is used to monitor the communication situation of serial data during normal operation of vehicle. The devices will exchange the operation information and commands mutually. The device has programming information required to be exchanged on the serial data circuit. The receiver device will also monitor such information; in addition, there are some regular information indication transmitter devices available.

Circuit diagram

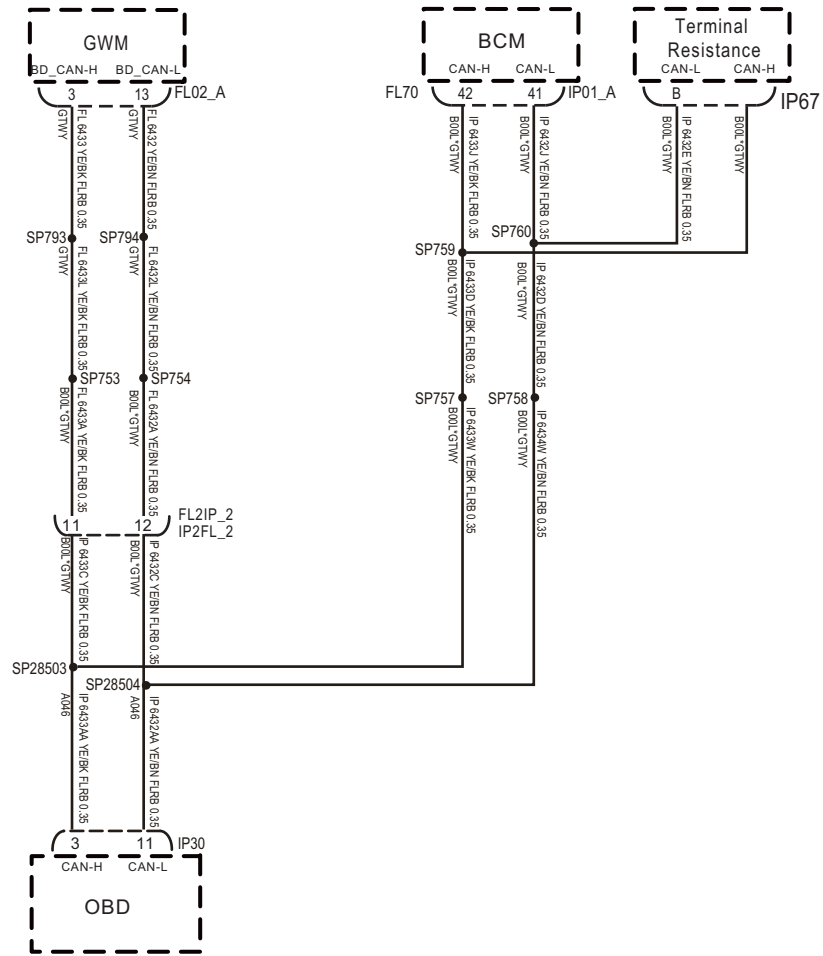

IP01_A

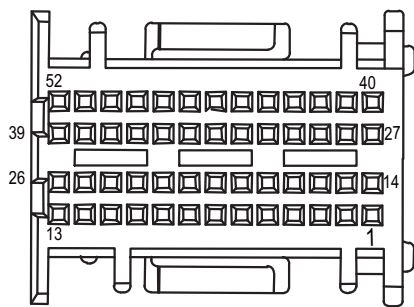

IP67

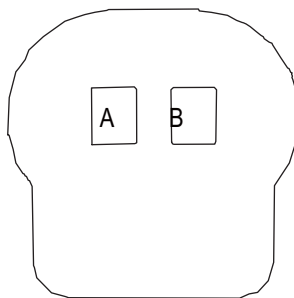

FL02_A

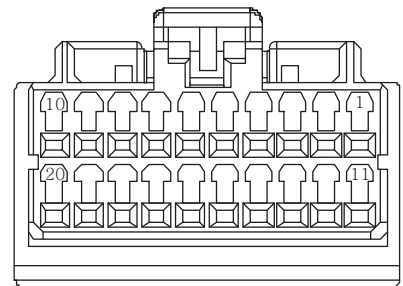

IP30

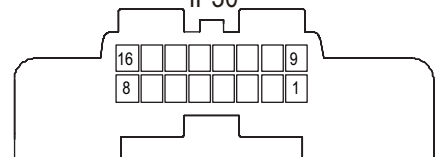

EK890006

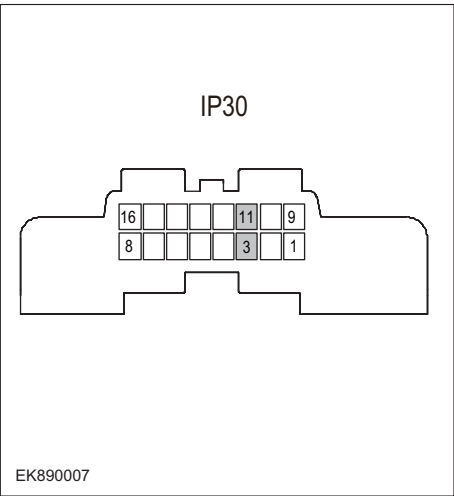
Troubleshooting steps	
Steps1	General inspection.
	<ol style="list-style-type: none"> 1 Check whether the fuse is damaged. 2 Check battery capacity. 3 Check the BCM harness plug for damage, poor contact, aging and looseness. 4 Check whether the result is normal or not?
NO → Repair or replace the faulted parts.	
YES ↓	
Steps2	Check fault codes.
	<ol style="list-style-type: none"> 1 Connect the fault diagnosis instrument to the diagnosis interface. 2 Turn the ignition switch to ON position. 3 Diagnose BCM with diagnostic instrument. 4 If there is any fault code except for U0073-88 之?
YES → Refer to: DTC Summary list(BCM)	
NO ↓	
Steps3	Inspection for CAN communication network completeness.
	<ol style="list-style-type: none"> 1 Turn the ignition switch to OFF. 2 Measure the resistance between the harness terminals of diagnose interface. Measuring circuit: the resistance between terminal 3 and 11 on plug IP28. Standard value: $\approx 60\Omega$ 3 Check whether the result is normal or not?
NO → Repair or replace the faulted parts.	
YES ↓	

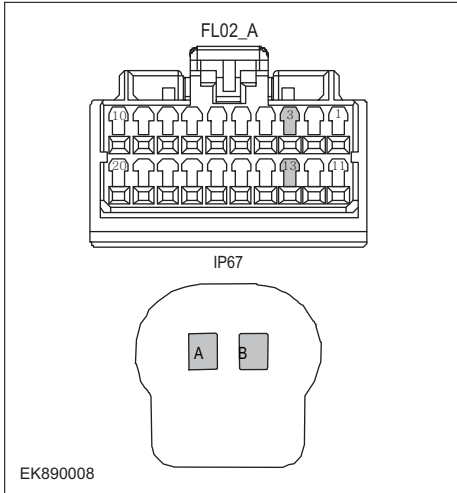
Steps4	Check the terminal resistance of gateway module and BD resistor.
	<ol style="list-style-type: none"> 1 Turn the ignition switch to OFF. 2 Disconnect the gateway module harness plug FL02_A. 3 Measure the resistance between the gateway module harness terminals. Measuring circuit: resistance between terminal 3 and terminal 13 of FL02_A plug. Standard value:110~130Ω 4 Connect the gateway module harness plug FL02_A. 5 Disconnect BD resistor harness plug IP67. 6 Measure the resistance between BD resistor harness terminals. Measuring circuit: resistance between terminal A and terminal B of IP67 plug. Standard value:110~130Ω 7 Check whether the result is normal or not?
<p>NO → Repair or replace the faulted parts.</p>	
<p>YES ↓</p>	
Steps5	Check whether BCM is abnormal.
	<ol style="list-style-type: none"> 1 Turn the ignition switch to OFF. 2 Disconnect and check the connectors IP01_A, IP01_B and IP01_C of BCM harness. 3 Check and repair. <ul style="list-style-type: none"> • Corrosion(install new adapting piece or terminal-cleaning module and pin). • Pin damaged or bent-install new terminal/pin. • Fly out of pins-install new pins as needed. 4 Reconnect the BCM plug and all other previously disconnected plugs. Make sure that the pins are properly positioned and fixed. 5 Run the system and determine if the problem persists?
<p>YES → Replace BCM.</p>	
<p>NO ↓</p>	
<p>At this point the system is functioning normally. The problem may be caused by module connections. Address the root cause of any connector or pin problems,</p>	
<p>Next Step ↓</p>	
<p>Diagnosis end.</p>	

U0073-87

Fault diagnosis code
U0073-87: CAN ABS Communication time out
Detection tools
1 Multimeter and diagnostic apparatus
Possible causes
<ul style="list-style-type: none"> • Lines, terminals or connectors • BCM
Conditions for fault code operation
Turn the ignition switch to ON position.
Conditions for fault code setting
U0073-87
To set the effect of a fault code condition
Description of circuit diagram
The device is connected to serial data circuit, which is used to monitor the communication situation of serial data during normal operation of vehicle. The devices will exchange the operation information and commands mutually. The device has programming information required to be exchanged on the serial data circuit. The receiver device will also monitor such information; in addition, there are some regular information indication transmitter devices available.

Circuit diagram

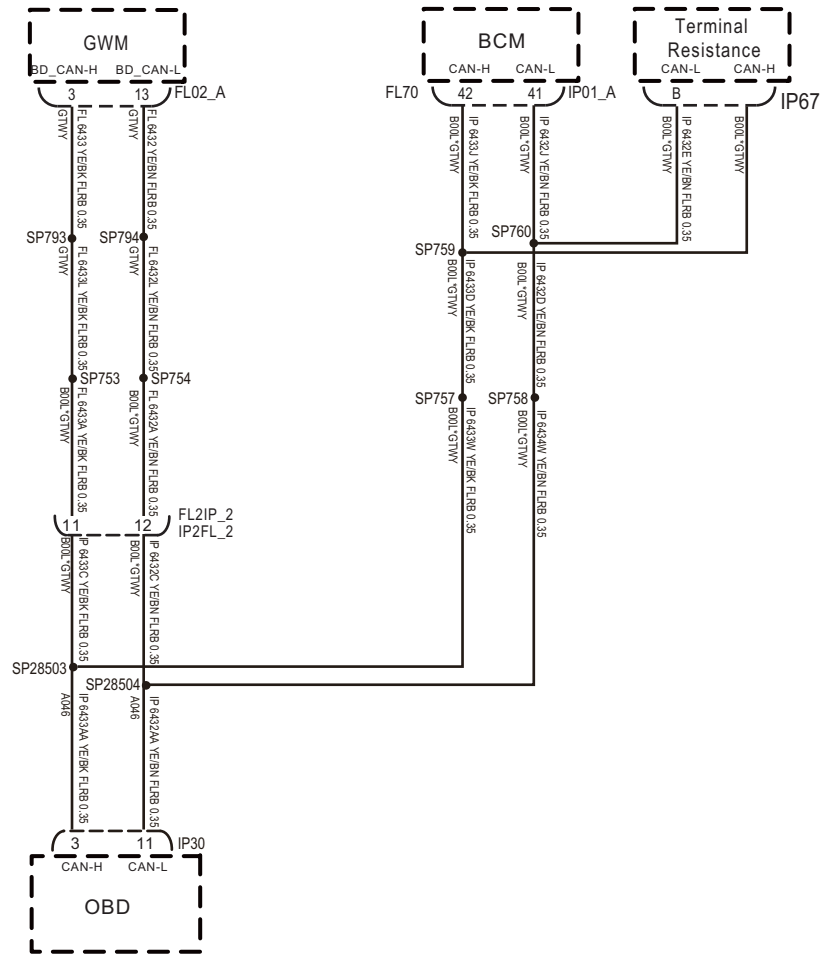

IP01_A

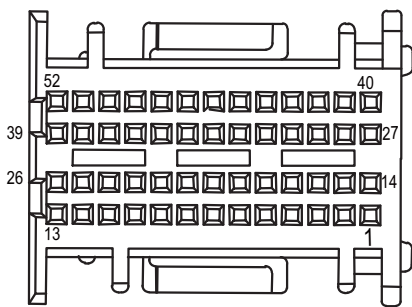

IP67

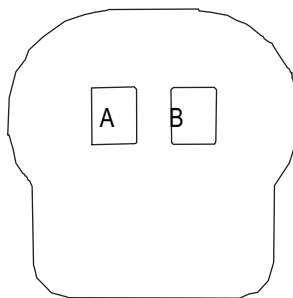

FL02_A

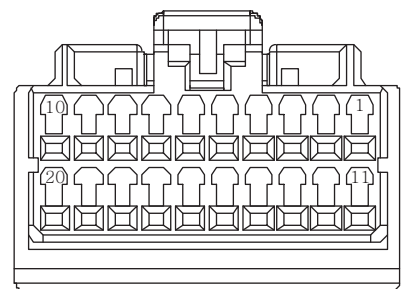

IP30

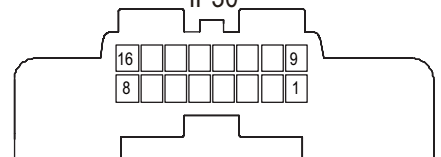

EK890006

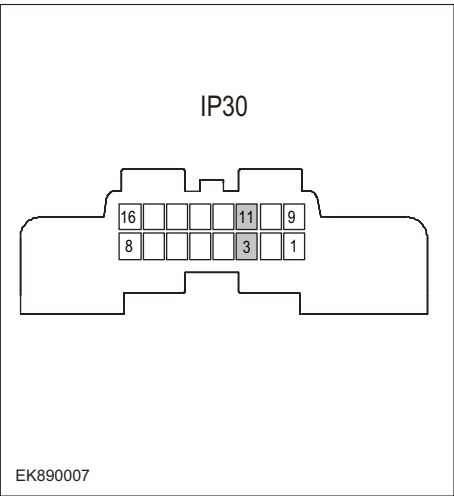
Troubleshooting steps	
Steps1	General inspection.
	<ol style="list-style-type: none"> 1 Check whether the fuse is damaged. 2 Check battery capacity. 3 Check the BCM harness plug for damage, poor contact, aging and looseness. 4 Check whether the result is normal or not?
NO → Repair or replace the faulted parts.	
YES ↓	
Steps2	Check fault codes.
	<ol style="list-style-type: none"> 1 Connect the fault diagnosis instrument to the diagnosis interface. 2 Turn the ignition switch to ON position. 3 Diagnose BCM with diagnostic instrument. 4 If there is any fault code except for U0073-87?
YES → Refer to: DTC Summary list(BCM)	
NO ↓	
Steps3	Inspection for CAN communication network completeness.
	<ol style="list-style-type: none"> 1 Turn the ignition switch to OFF. 2 Measure the resistance between the harness terminals of diagnose interface. Measuring circuit: the resistance between terminal 3 and 11 on plug IP28. Standard value: $\approx 60\Omega$ 3 Check whether the result is normal or not?
NO → Repair or replace the faulted parts.	
YES ↓	

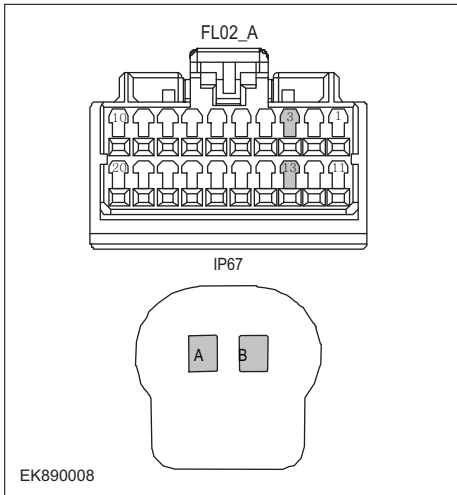
Steps4	Check the terminal resistance of gateway module and BD resistor.
	<ol style="list-style-type: none"> 1 Turn the ignition switch to OFF. 2 Disconnect the gateway module harness plug FL02_A. 3 Measure the resistance between the gateway module harness terminals. Measuring circuit: resistance between terminal 3 and terminal 13 of FL02_A plug. Standard value:110~130Ω 4 Connect the gateway module harness plug FL02_A. 5 Disconnect BD resistor harness plug IP67. 6 Measure the resistance between BD resistor harness terminals. Measuring circuit: resistance between terminal A and terminal B of IP67 plug. Standard value:110~130Ω 7 Check whether the result is normal or not?
<p>NO → Repair or replace the faulted parts.</p>	
<p>YES ↓</p>	
Steps5	Check whether BCM is abnormal.
	<ol style="list-style-type: none"> 1 Turn the ignition switch to OFF. 2 Disconnect and check the connectors IP01_A, IP01_B and IP01_C of BCM harness. 3 Check and repair. <ul style="list-style-type: none"> • Corrosion(install new adapting piece or terminal-cleaning module and pin). • Pin damaged or bent-install new terminal/pin. • Fly out of pins-install new pins as needed. 4 Reconnect the BCM plug and all other previously disconnected plugs. Make sure that the pins are properly positioned and fixed. 5 Run the system and determine if the problem persists?
<p>YES → Replace BCM.</p>	
<p>NO ↓</p>	
<p>At this point the system is functioning normally. The problem may be caused by module connections. Address the root cause of any connector or pin problems,</p>	
<p>Next Step ↓</p>	
<p>Diagnosis end.</p>	

U0121-87

Fault diagnosis code
U0121-87: CAN EMS Communication time out
Detection tools
1 Multimeter and diagnostic apparatus
Possible causes
<ul style="list-style-type: none"> • Lines, terminals or connectors • BCM
Conditions for fault code operation
Turn the ignition switch to ON position.
Conditions for fault code setting
U0121-87
To set the effect of a fault code condition
Description of circuit diagram
The device is connected to serial data circuit, which is used to monitor the communication situation of serial data during normal operation of vehicle. The devices will exchange the operation information and commands mutually. The device has programming information required to be exchanged on the serial data circuit. The receiver device will also monitor such information; in addition, there are some regular information indication transmitter devices available.

Circuit diagram

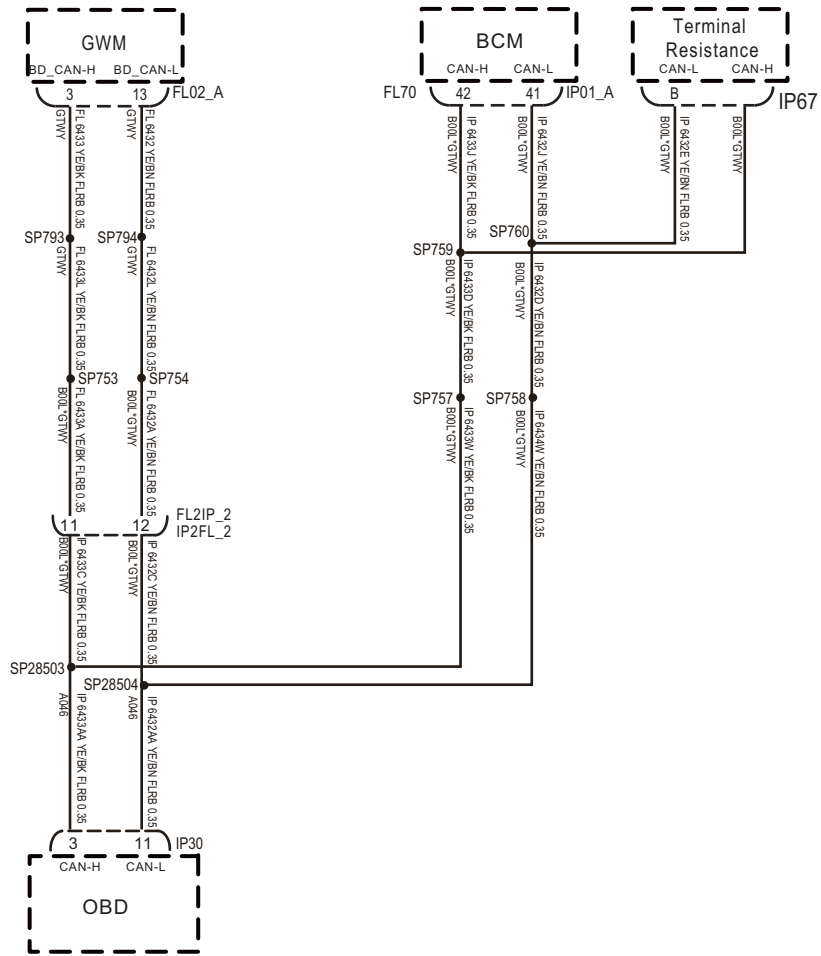

IP01_A

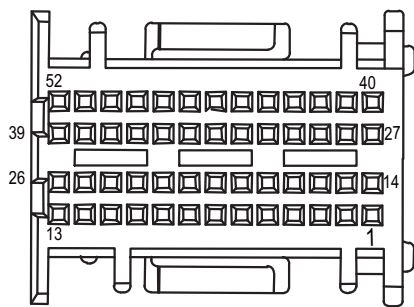

IP67

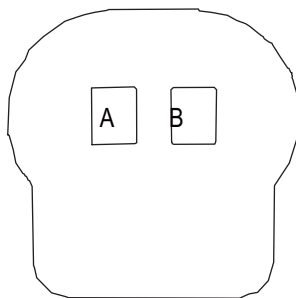

FL02_A

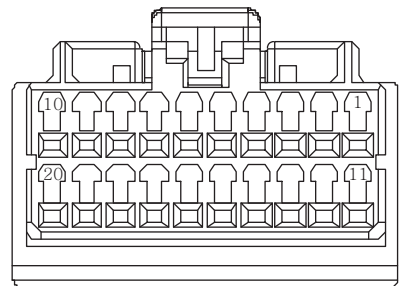

IP30

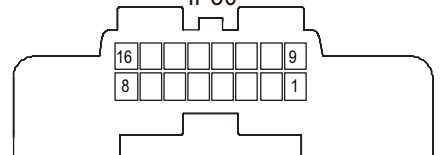

EK890006

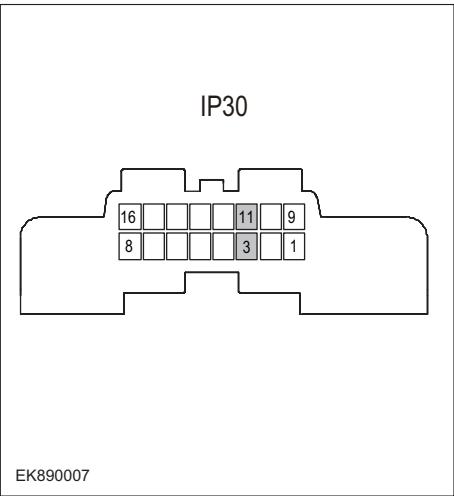
Troubleshooting steps	
Steps1	General inspection.
	<ol style="list-style-type: none"> 1 Check whether the fuse is damaged. 2 Check battery capacity. 3 Check the BCM harness plug for damage, poor contact, aging and looseness. 4 Check whether the result is normal or not?
NO → Repair or replace the faulted parts.	
YES ↓	
Steps2	Check fault codes.
	<ol style="list-style-type: none"> 1 Connect the fault diagnosis instrument to the diagnosis interface. 2 Turn the ignition switch to ON position. 3 Diagnose BCM with diagnostic instrument. 4 If there is any fault code except for U0121-87?
YES → Refer to: DTC Summary list(BCM)	
NO ↓	
Steps3	Inspection for CAN communication network completeness.
	<ol style="list-style-type: none"> 1 Turn the ignition switch to OFF. 2 Measure the resistance between the harness terminals of diagnose interface. Measuring circuit: the resistance between terminal 3 and 11 on plug IP28. Standard value: $\approx 60\Omega$ 3 Check whether the result is normal or not?
NO → Repair or replace the faulted parts.	
YES ↓	

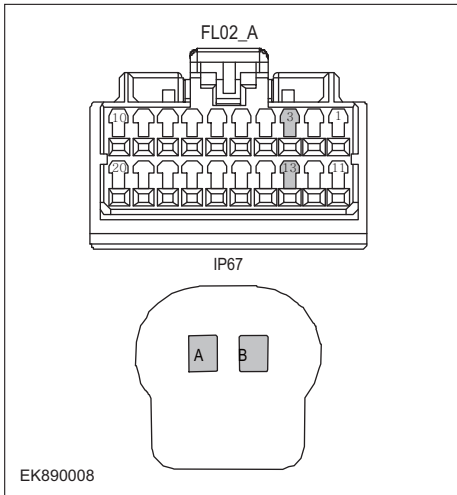
Steps4	Check the terminal resistance of gateway module and BD resistor.
	<ol style="list-style-type: none"> 1 Turn the ignition switch to OFF. 2 Disconnect the gateway module harness plug FL02_A. 3 Measure the resistance between the gateway module harness terminals. Measuring circuit: resistance between terminal 3 and terminal 13 of FL02_A plug. Standard value:110~130Ω 4 Connect the gateway module harness plug FL02_A. 5 Disconnect BD resistor harness plug IP67. 6 Measure the resistance between BD resistor harness terminals. Measuring circuit: resistance between terminal A and terminal B of IP67 plug. Standard value:110~130Ω 7 Check whether the result is normal or not?
<p>NO → Repair or replace the faulted parts.</p>	
<p>YES ↓</p>	
Steps5	Check whether BCM is abnormal.
	<ol style="list-style-type: none"> 1 Turn the ignition switch to OFF. 2 Disconnect and check the connectors IP01_A, IP01_B and IP01_C of BCM harness. 3 Check and repair. <ul style="list-style-type: none"> • Corrosion(install new adapting piece or terminal-cleaning module and pin). • Pin damaged or bent-install new terminal/pin. • Fly out of pins-install new pins as needed. 4 Reconnect the BCM plug and all other previously disconnected plugs. Make sure that the pins are properly positioned and fixed. 5 Run the system and determine if the problem persists?
<p>YES → Replace BCM.</p>	
<p>NO ↓</p>	
<p>At this point the system is functioning normally. The problem may be caused by module connections. Address the root cause of any connector or pin problems,</p>	
<p>Next Step ↓</p>	
<p>Diagnosis end.</p>	

U0155-87

Fault diagnosis code
U0155-87: CAN IPK Communication time out
Detection tools
1 Multimeter and diagnostic apparatus
Possible causes
<ul style="list-style-type: none"> • Lines, terminals or connectors • BCM
Conditions for fault code operation
Turn the ignition switch to ON position.
Conditions for fault code setting
U0155-87
To set the effect of a fault code condition
Description of circuit diagram
The device is connected to serial data circuit, which is used to monitor the communication situation of serial data during normal operation of vehicle. The devices will exchange the operation information and commands mutually. The device has programming information required to be exchanged on the serial data circuit. The receiver device will also monitor such information; in addition, there are some regular information indication transmitter devices available.

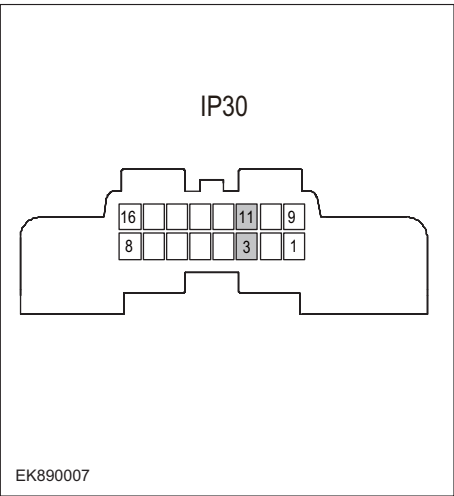
Troubleshooting steps	
Steps1	General inspection.
	<ol style="list-style-type: none"> 1 Check whether the fuse is damaged. 2 Check battery capacity. 3 Check the BCM harness plug for damage, poor contact, aging and looseness. 4 Check whether the result is normal or not?
NO → Repair or replace the faulted parts.	
YES ↓	
Steps2	Check fault codes.
	<ol style="list-style-type: none"> 1 Connect the fault diagnosis instrument to the diagnosis interface. 2 Turn the ignition switch to ON position. 3 Diagnose BCM with diagnostic instrument. 4 If there is any fault code except for U0155-87?
YES → Refer to: DTC Summary list(BCM)	
NO ↓	
Steps3	Inspection for CAN communication network completeness.
	<ol style="list-style-type: none"> 1 Turn the ignition switch to OFF. 2 Measure the resistance between the harness terminals of diagnose interface. Measuring circuit: the resistance between terminal 3 and 11 on plug IP28. Standard value: ≈ 60Ω 3 Check whether the result is normal or not?
NO → Repair or replace the faulted parts.	
YES ↓	

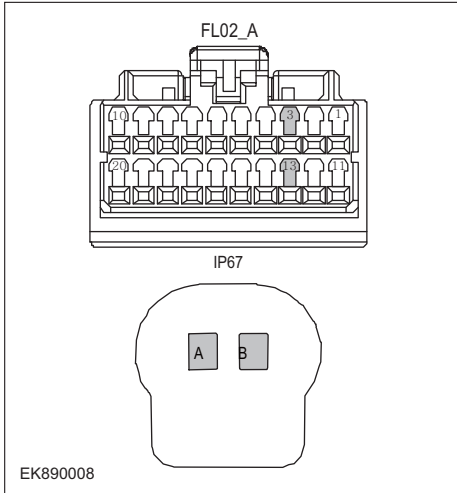
Steps4	Check the terminal resistance of gateway module and BD resistor.
	<ol style="list-style-type: none"> 1 Turn the ignition switch to OFF. 2 Disconnect the gateway module harness plug FL02_A. 3 Measure the resistance between the gateway module harness terminals. Measuring circuit: resistance between terminal 3 and terminal 13 of FL02_A plug. Standard value:110~130Ω 4 Connect the gateway module harness plug FL02_A. 5 Disconnect BD resistor harness plug IP67. 6 Measure the resistance between BD resistor harness terminals. Measuring circuit: resistance between terminal A and terminal B of IP67 plug. Standard value:110~130Ω 7 Check whether the result is normal or not?
<p>NO → Repair or replace the faulted parts.</p>	
<p>YES ↓</p>	
Steps5	Check whether BCM is abnormal.
	<ol style="list-style-type: none"> 1 Turn the ignition switch to OFF. 2 Disconnect and check the connectors IP01_A, IP01_B and IP01_C of BCM harness. 3 Check and repair. <ul style="list-style-type: none"> • Corrosion(install new adapting piece or terminal-cleaning module and pin). • Pin damaged or bent-install new terminal/pin. • Fly out of pins-install new pins as needed. 4 Reconnect the BCM plug and all other previously disconnected plugs. Make sure that the pins are properly positioned and fixed. 5 Run the system and determine if the problem persists?
<p>YES → Replace BCM.</p>	
<p>NO ↓</p>	
<p>At this point the system is functioning normally. The problem may be caused by module connections. Address the root cause of any connector or pin problems,</p>	
<p>Next Step ↓</p>	
<p>Diagnosis end.</p>	

U0151-87

Fault diagnosis code
U0151-87: CAN SRS Communication time out
Detection tools
1 Multimeter and diagnostic apparatus
Possible causes
<ul style="list-style-type: none"> • Lines, terminals or connectors • BCM
Conditions for fault code operation
Turn the ignition switch to ON position.
Conditions for fault code setting
U0151-87
To set the effect of a fault code condition
Description of circuit diagram
The device is connected to serial data circuit, which is used to monitor the communication situation of serial data during normal operation of vehicle. The devices will exchange the operation information and commands mutually. The device has programming information required to be exchanged on the serial data circuit. The receiver device will also monitor such information; in addition, there are some regular information indication transmitter devices available.

Circuit diagram

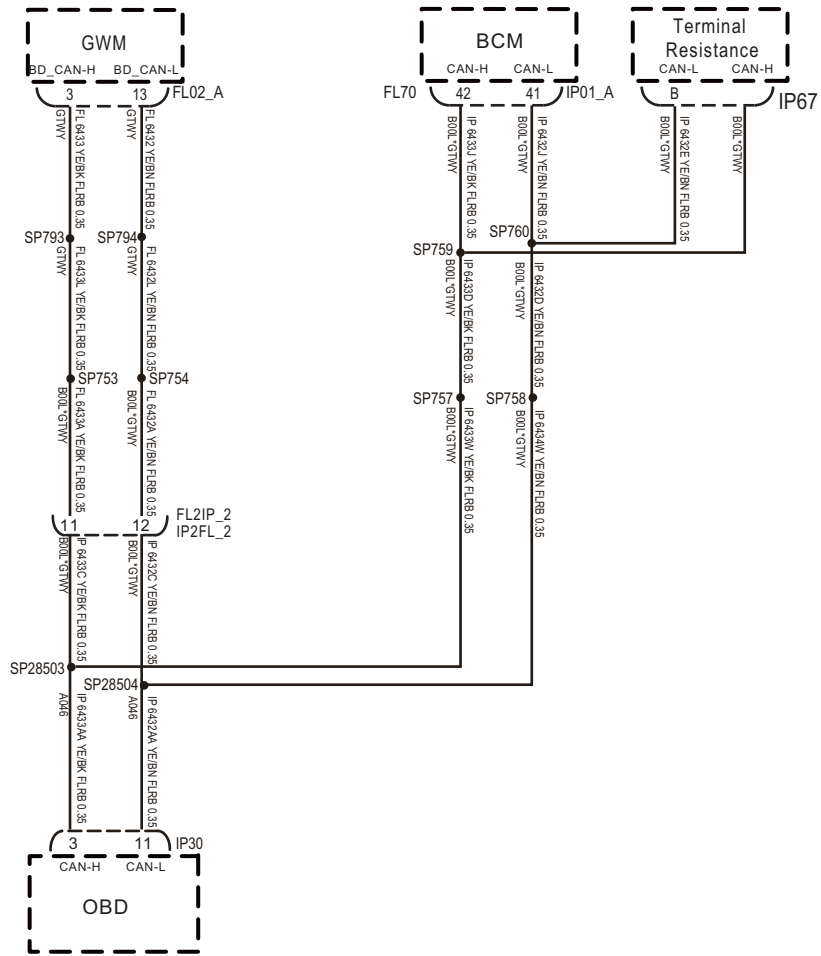

IP01_A

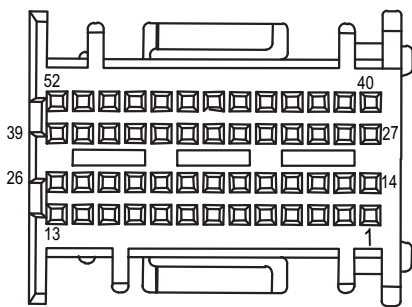

IP67

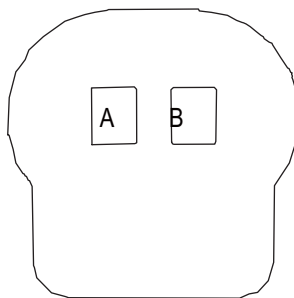

FL02_A

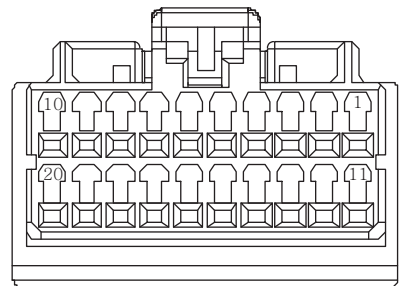

IP30

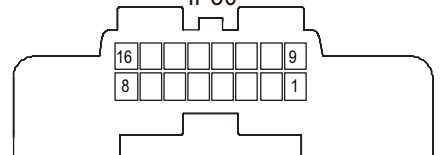

EK890006

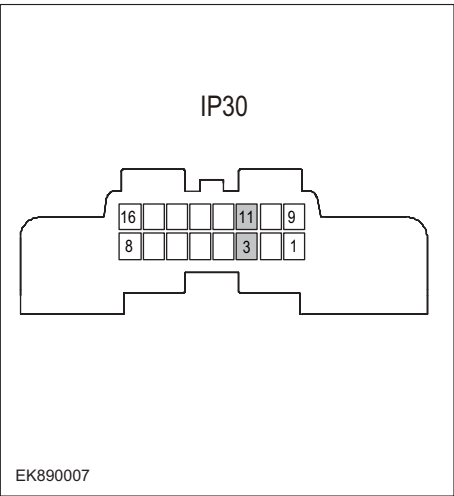
Troubleshooting steps	
Steps1	General inspection.
	<ol style="list-style-type: none"> 1 Check whether the fuse is damaged. 2 Check battery capacity. 3 Check the BCM harness plug for damage, poor contact, aging and looseness. 4 Check whether the result is normal or not?
NO → Repair or replace the faulted parts.	
YES ↓	
Steps2	Check fault codes.
	<ol style="list-style-type: none"> 1 Connect the fault diagnosis instrument to the diagnosis interface. 2 Turn the ignition switch to ON position. 3 Diagnose BCM with diagnostic instrument. 4 If there is any fault code except for U0151-87?
YES → Refer to: DTC Summary list(BCM)	
NO ↓	
Steps3	Inspection for CAN communication network completeness.
	<ol style="list-style-type: none"> 1 Turn the ignition switch to OFF. 2 Measure the resistance between the harness terminals of diagnose interface. Measuring circuit: the resistance between terminal 3 and 11 on plug IP28. Standard value: $\approx 60\Omega$ 3 Check whether the result is normal or not?
NO → Repair or replace the faulted parts.	
YES ↓	

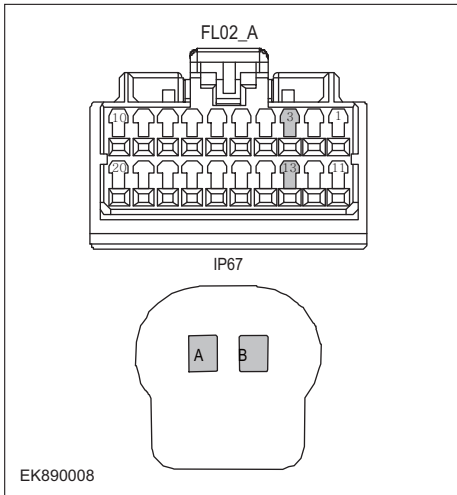
Steps4	Check the terminal resistance of gateway module and BD resistor.
	<ol style="list-style-type: none"> 1 Turn the ignition switch to OFF. 2 Disconnect the gateway module harness plug FL02_A. 3 Measure the resistance between the gateway module harness terminals. Measuring circuit: resistance between terminal 3 and terminal 13 of FL02_A plug. Standard value:110~130Ω 4 Connect the gateway module harness plug FL02_A. 5 Disconnect BD resistor harness plug IP67. 6 Measure the resistance between BD resistor harness terminals. Measuring circuit: resistance between terminal A and terminal B of IP67 plug. Standard value:110~130Ω 7 Check whether the result is normal or not?
<p>NO → Repair or replace the faulted parts.</p>	
<p>YES ↓</p>	
Steps5	Check whether BCM is abnormal.
	<ol style="list-style-type: none"> 1 Turn the ignition switch to OFF. 2 Disconnect and check the connectors IP01_A, IP01_B and IP01_C of BCM harness. 3 Check and repair. <ul style="list-style-type: none"> • Corrosion(install new adapting piece or terminal-cleaning module and pin). • Pin damaged or bent-install new terminal/pin. • Fly out of pins-install new pins as needed. 4 Reconnect the BCM plug and all other previously disconnected plugs. Make sure that the pins are properly positioned and fixed. 5 Run the system and determine if the problem persists?
<p>YES → Replace BCM.</p>	
<p>NO ↓</p>	
<p>At this point the system is functioning normally. The problem may be caused by module connections. Address the root cause of any connector or pin problems,</p>	
<p>Next Step ↓</p>	
<p>Diagnosis end.</p>	

U0101-87

Fault diagnosis code
U0101-87: CAN TCU Communication time out
Detection tools
1 Multimeter and diagnostic apparatus
Possible causes
<ul style="list-style-type: none"> • Lines, terminals or connectors • BCM
Conditions for fault code operation
Turn the ignition switch to ON position.
Conditions for fault code setting
U0101-87
To set the effect of a fault code condition
Description of circuit diagram
The device is connected to serial data circuit, which is used to monitor the communication situation of serial data during normal operation of vehicle. The devices will exchange the operation information and commands mutually. The device has programming information required to be exchanged on the serial data circuit. The receiver device will also monitor such information; in addition, there are some regular information indication transmitter devices available.

Circuit diagram

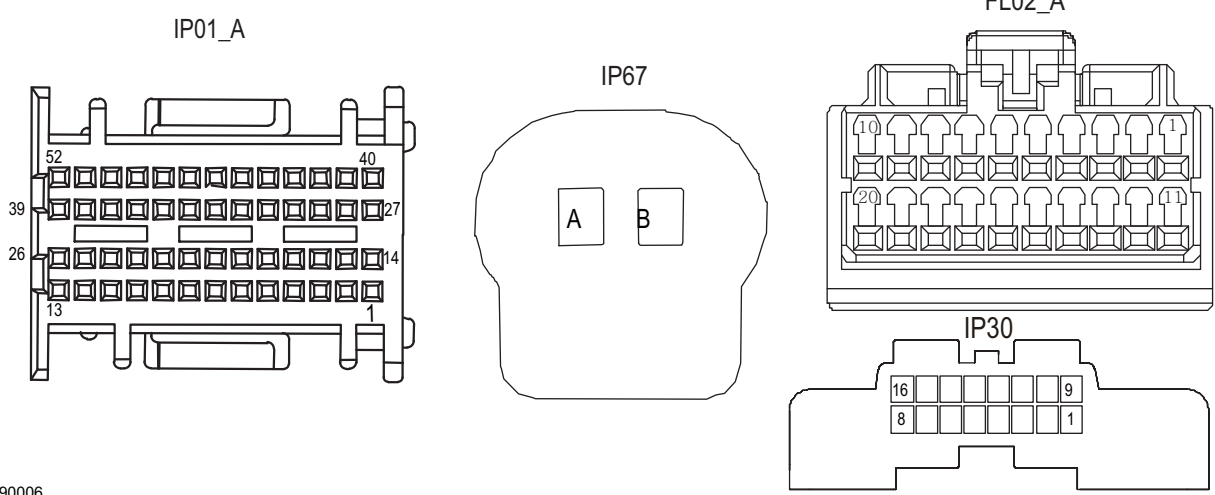
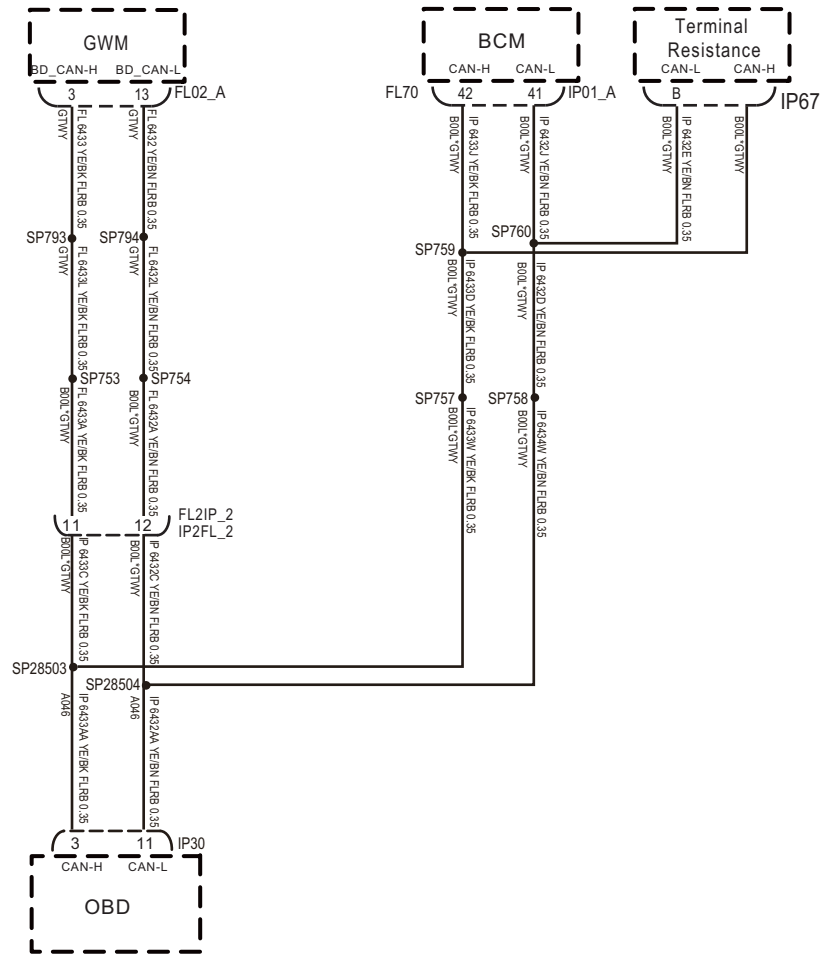

EK890006

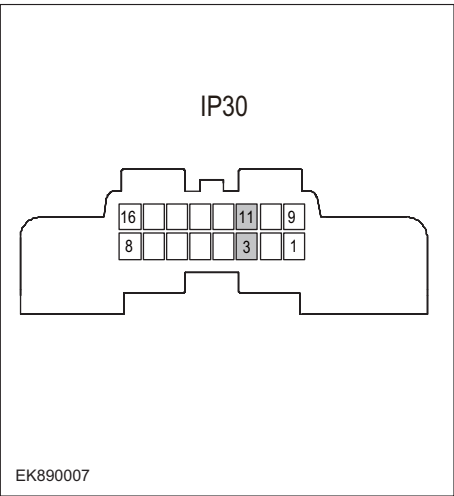
Troubleshooting steps	
Steps1	General inspection.
	<ol style="list-style-type: none"> 1 Check whether the fuse is damaged. 2 Check battery capacity. 3 Check the BCM harness plug for damage, poor contact, aging and looseness. 4 Check whether the result is normal or not?
NO → Repair or replace the faulted parts.	
YES ↓	
Steps2	Check fault codes.
	<ol style="list-style-type: none"> 1 Connect the fault diagnosis instrument to the diagnosis interface. 2 Turn the ignition switch to ON position. 3 Diagnose BCM with diagnostic instrument. 4 If there is any fault code except for U0101-87?
YES → Refer to: DTC Summary list(BCM)	
NO ↓	
Steps3	Inspection for CAN communication network completeness.
	<ol style="list-style-type: none"> 1 Turn the ignition switch to OFF. 2 Measure the resistance between the harness terminals of diagnose interface. Measuring circuit: the resistance between terminal 3 and 11 on plug IP28. Standard value: $\approx 60\Omega$ 3 Check whether the result is normal or not?
NO → Repair or replace the faulted parts.	
YES ↓	

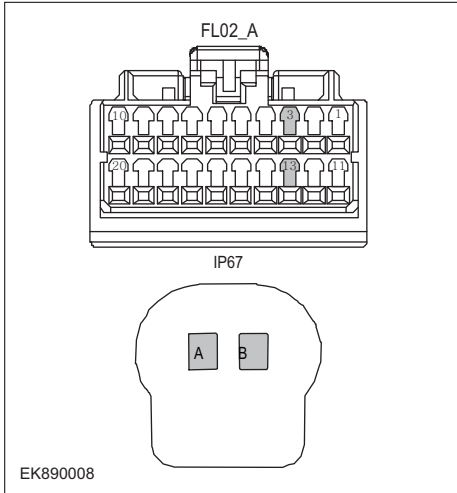
Steps4	Check the terminal resistance of gateway module and BD resistor.
	<ol style="list-style-type: none"> 1 Turn the ignition switch to OFF. 2 Disconnect the gateway module harness plug FL02_A. 3 Measure the resistance between the gateway module harness terminals. Measuring circuit: resistance between terminal 3 and terminal 13 of FL02_A plug. Standard value:110~130Ω 4 Connect the gateway module harness plug FL02_A. 5 Disconnect BD resistor harness plug IP67. 6 Measure the resistance between BD resistor harness terminals. Measuring circuit: resistance between terminal A and terminal B of IP67 plug. Standard value:110~130Ω 7 Check whether the result is normal or not?
<p>NO → Repair or replace the faulted parts.</p>	
<p>YES ↓</p>	
Steps5	Check whether BCM is abnormal.
	<ol style="list-style-type: none"> 1 Turn the ignition switch to OFF. 2 Disconnect and check the connectors IP01_A, IP01_B and IP01_C of BCM harness. 3 Check and repair. <ul style="list-style-type: none"> • Corrosion(install new adapting piece or terminal-cleaning module and pin). • Pin damaged or bent-install new terminal/pin. • Fly out of pins-install new pins as needed. 4 Reconnect the BCM plug and all other previously disconnected plugs. Make sure that the pins are properly positioned and fixed. 5 Run the system and determine if the problem persists?
<p>YES → Replace BCM.</p>	
<p>NO ↓</p>	
<p>At this point the system is functioning normally. The problem may be caused by module connections. Address the root cause of any connector or pin problems,</p>	
<p>Next Step ↓</p>	
<p>Diagnosis end.</p>	

U0152-87

Fault diagnosis code
U0152-87: CAN ESP Communication time out
Detection tools
1 Multimeter and diagnostic apparatus
Possible causes
<ul style="list-style-type: none"> • Lines, terminals or connectors • BCM
Conditions for fault code operation
Turn the ignition switch to ON position.
Conditions for fault code setting
U0152-87
To set the effect of a fault code condition
Description of circuit diagram
The device is connected to serial data circuit, which is used to monitor the communication situation of serial data during normal operation of vehicle. The devices will exchange the operation information and commands mutually. The device has programming information required to be exchanged on the serial data circuit. The receiver device will also monitor such information; in addition, there are some regular information indication transmitter devices available.

Circuit diagram

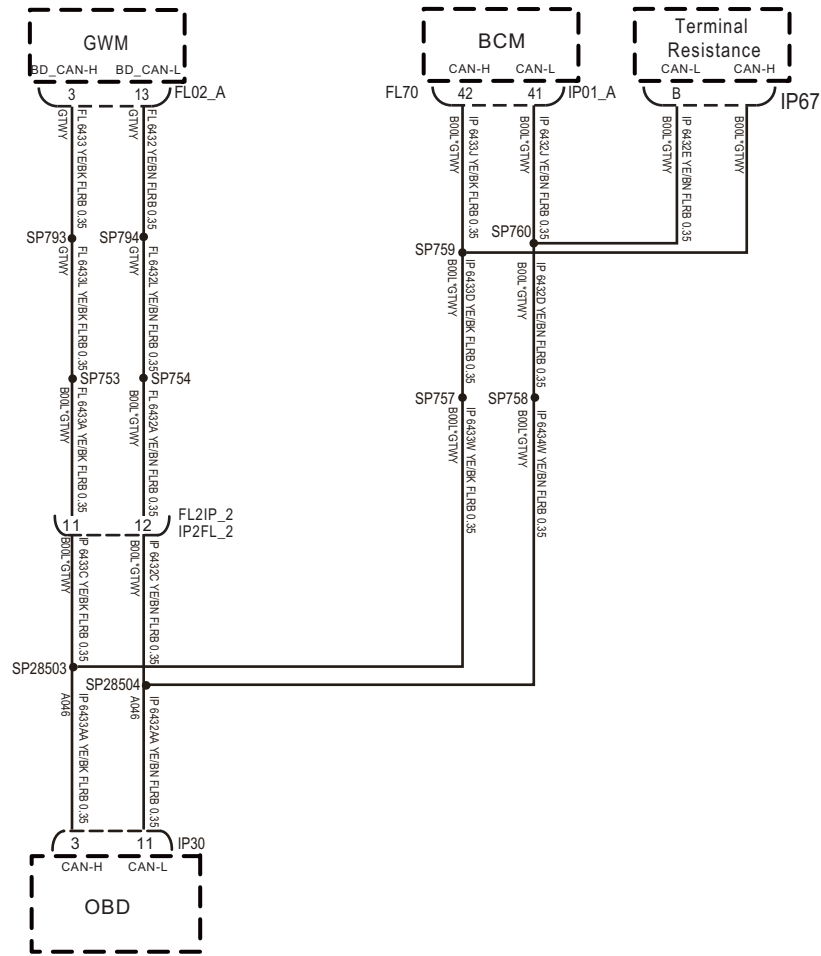

IP01_A

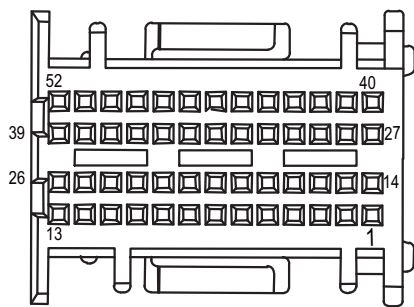

IP67

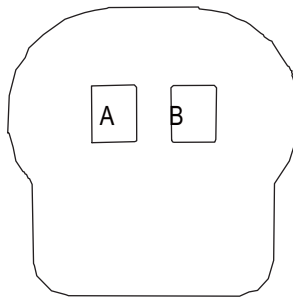

FL02_A

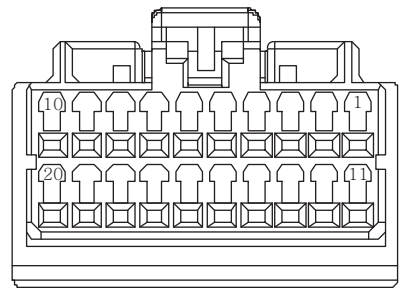

IP30

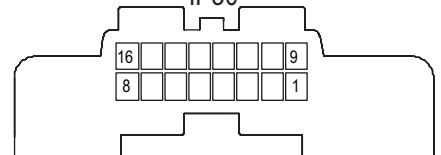

EK890006

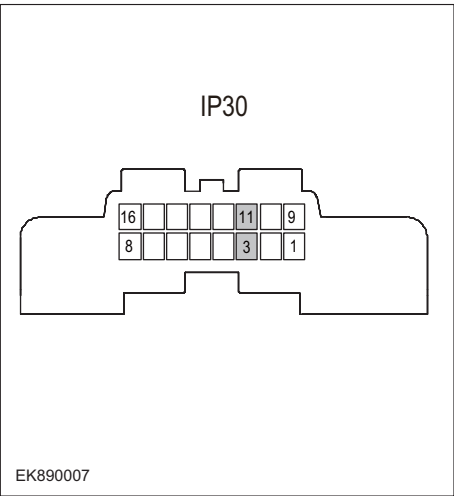
Troubleshooting steps	
Steps1	General inspection.
	<ol style="list-style-type: none"> 1 Check whether the fuse is damaged. 2 Check battery capacity. 3 Check the BCM harness plug for damage, poor contact, aging and looseness. 4 Check whether the result is normal or not?
NO → Repair or replace the faulted parts.	
YES ↓	
Steps2	Check fault codes.
	<ol style="list-style-type: none"> 1 Connect the fault diagnosis instrument to the diagnosis interface. 2 Turn the ignition switch to ON position. 3 Diagnose BCM with diagnostic instrument. 4 If there is any fault code except for U0152-87?
YES → Refer to: DTC Summary list(BCM)	
NO ↓	
Steps3	Inspection for CAN communication network completeness.
	<ol style="list-style-type: none"> 1 Turn the ignition switch to OFF. 2 Measure the resistance between the harness terminals of diagnose interface. Measuring circuit: the resistance between terminal 3 and 11 on plug IP28. Standard value: $\approx 60\Omega$ 3 Check whether the result is normal or not?
NO → Repair or replace the faulted parts.	
YES ↓	

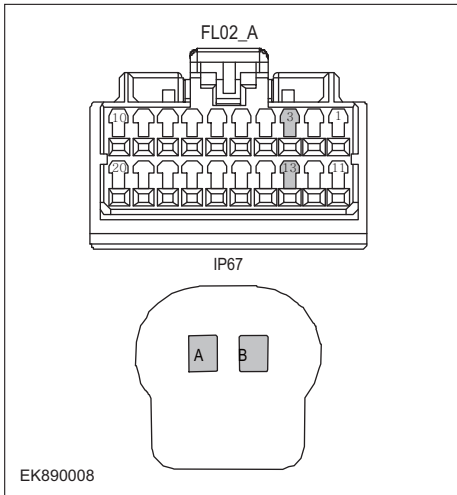
Steps4	Check the terminal resistance of gateway module and BD resistor.
	<ol style="list-style-type: none"> 1 Turn the ignition switch to OFF. 2 Disconnect the gateway module harness plug FL02_A. 3 Measure the resistance between the gateway module harness terminals. Measuring circuit: resistance between terminal 3 and terminal 13 of FL02_A plug. Standard value:110~130Ω 4 Connect the gateway module harness plug FL02_A. 5 Disconnect BD resistor harness plug IP67. 6 Measure the resistance between BD resistor harness terminals. Measuring circuit: resistance between terminal A and terminal B of IP67 plug. Standard value:110~130Ω 7 Check whether the result is normal or not?
<p>NO → Repair or replace the faulted parts.</p>	
<p>YES ↓</p>	
Steps5	Check whether BCM is abnormal.
	<ol style="list-style-type: none"> 1 Turn the ignition switch to OFF. 2 Disconnect and check the connectors IP01_A, IP01_B and IP01_C of BCM harness. 3 Check and repair. <ul style="list-style-type: none"> • Corrosion(install new adapting piece or terminal-cleaning module and pin). • Pin damaged or bent-install new terminal/pin. • Fly out of pins-install new pins as needed. 4 Reconnect the BCM plug and all other previously disconnected plugs. Make sure that the pins are properly positioned and fixed. 5 Run the system and determine if the problem persists?
<p>YES → Replace BCM.</p>	
<p>NO ↓</p>	
<p>At this point the system is functioning normally. The problem may be caused by module connections. Address the root cause of any connector or pin problems,</p>	
<p>Next Step ↓</p>	
<p>Diagnosis end.</p>	

U0153-87

Fault diagnosis code
U0153-87: CAN FICM Communication time out
Detection tools
1 Multimeter and diagnostic apparatus
Possible causes
<ul style="list-style-type: none"> • Lines, terminals or connectors • BCM
Conditions for fault code operation
Turn the ignition switch to ON position.
Conditions for fault code setting
U0153-87
To set the effect of a fault code condition
Description of circuit diagram
The device is connected to serial data circuit, which is used to monitor the communication situation of serial data during normal operation of vehicle. The devices will exchange the operation information and commands mutually. The device has programming information required to be exchanged on the serial data circuit. The receiver device will also monitor such information; in addition, there are some regular information indication transmitter devices available.

Circuit diagram

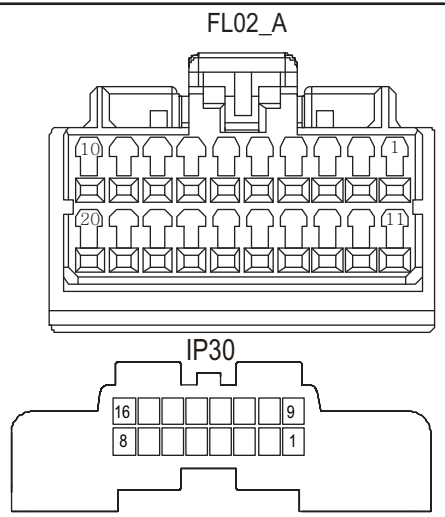
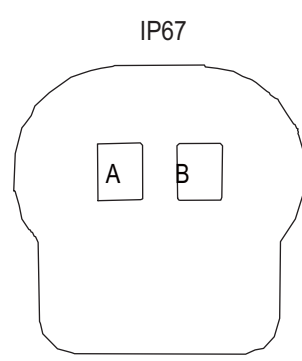
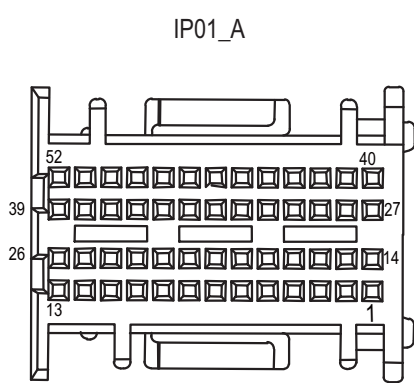
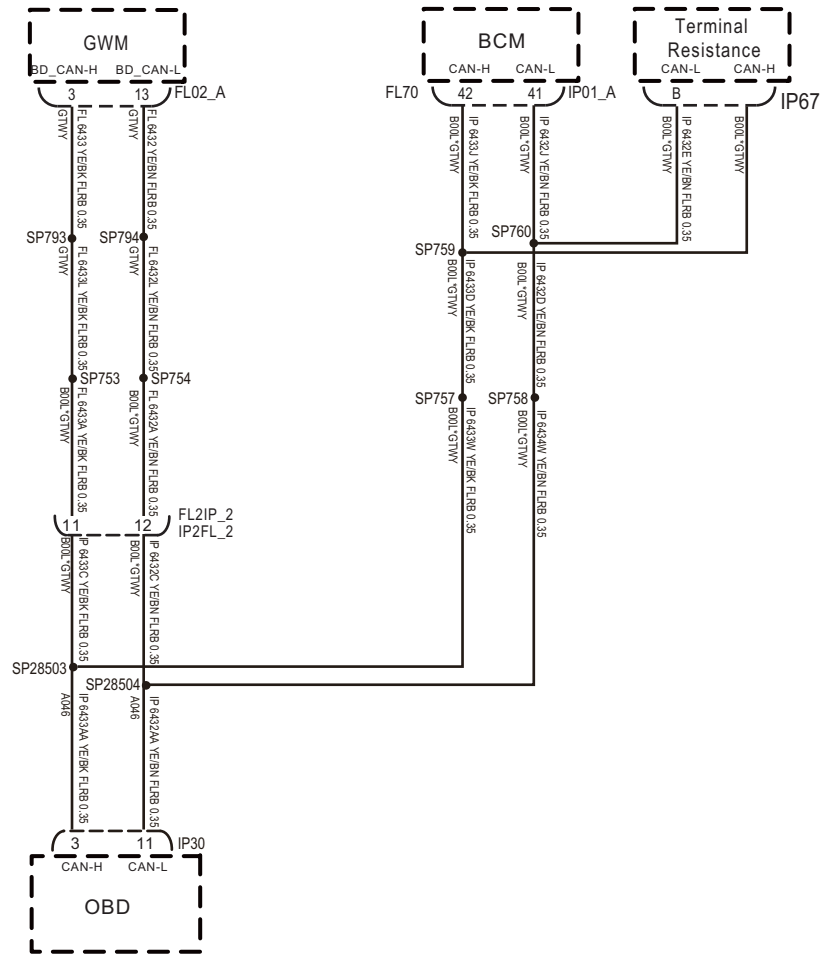

EK890006

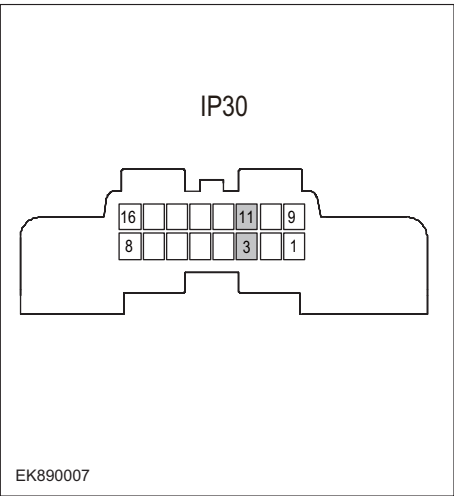
Troubleshooting steps	
Steps1	General inspection.
	<ol style="list-style-type: none"> 1 Check whether the fuse is damaged. 2 Check battery capacity. 3 Check the BCM harness plug for damage, poor contact, aging and looseness. 4 Check whether the result is normal or not?
NO → Repair or replace the faulted parts.	
YES ↓	
Steps2	Check fault codes.
	<ol style="list-style-type: none"> 1 Connect the fault diagnosis instrument to the diagnosis interface. 2 Turn the ignition switch to ON position. 3 Diagnose BCM with diagnostic instrument. 4 If there is any fault code except for U0153-87?
YES → Refer to: DTC Summary list(BCM)	
NO ↓	
Steps3	Inspection for CAN communication network completeness.
	<ol style="list-style-type: none"> 1 Turn the ignition switch to OFF. 2 Measure the resistance between the harness terminals of diagnose interface. Measuring circuit: the resistance between terminal 3 and 11 on plug IP28. Standard value: $\approx 60\Omega$ 3 Check whether the result is normal or not?
NO → Repair or replace the faulted parts.	
YES ↓	

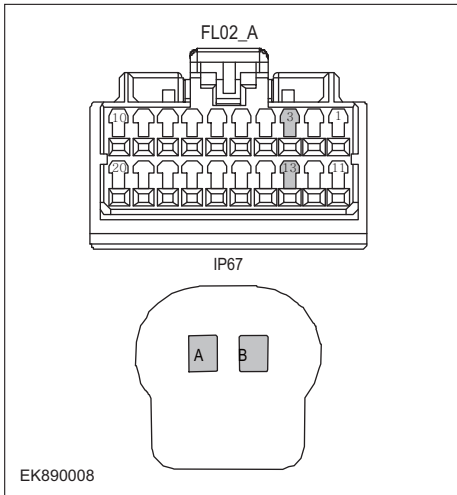
Steps4	Check the terminal resistance of gateway module and BD resistor.
	<ol style="list-style-type: none"> 1 Turn the ignition switch to OFF. 2 Disconnect the gateway module harness plug FL02_A. 3 Measure the resistance between the gateway module harness terminals. Measuring circuit: resistance between terminal 3 and terminal 13 of FL02_A plug. Standard value:110~130Ω 4 Connect the gateway module harness plug FL02_A. 5 Disconnect BD resistor harness plug IP67. 6 Measure the resistance between BD resistor harness terminals. Measuring circuit: resistance between terminal A and terminal B of IP67 plug. Standard value:110~130Ω 7 Check whether the result is normal or not?
<p>NO → Repair or replace the faulted parts.</p>	
<p>YES ↓</p>	
Steps5	Check whether BCM is abnormal.
	<ol style="list-style-type: none"> 1 Turn the ignition switch to OFF. 2 Disconnect and check the connectors IP01_A, IP01_B and IP01_C of BCM harness. 3 Check and repair. <ul style="list-style-type: none"> • Corrosion(install new adapting piece or terminal-cleaning module and pin). • Pin damaged or bent-install new terminal/pin. • Fly out of pins-install new pins as needed. 4 Reconnect the BCM plug and all other previously disconnected plugs. Make sure that the pins are properly positioned and fixed. 5 Run the system and determine if the problem persists?
<p>YES → Replace BCM.</p>	
<p>NO ↓</p>	
<p>At this point the system is functioning normally. The problem may be caused by module connections. Address the root cause of any connector or pin problems,</p>	
<p>Next Step ↓</p>	
<p>Diagnosis end.</p>	

U0154-87

Fault diagnosis code
U0154-87: CAN SAS Communication time out
Detection tools
1 Multimeter and diagnostic apparatus
Possible causes
<ul style="list-style-type: none"> • Lines, terminals or connectors • BCM
Conditions for fault code operation
Turn the ignition switch to ON position.
Conditions for fault code setting
U0154-87
To set the effect of a fault code condition
Description of circuit diagram
The device is connected to serial data circuit, which is used to monitor the communication situation of serial data during normal operation of vehicle. The devices will exchange the operation information and commands mutually. The device has programming information required to be exchanged on the serial data circuit. The receiver device will also monitor such information; in addition, there are some regular information indication transmitter devices available.

Circuit diagram

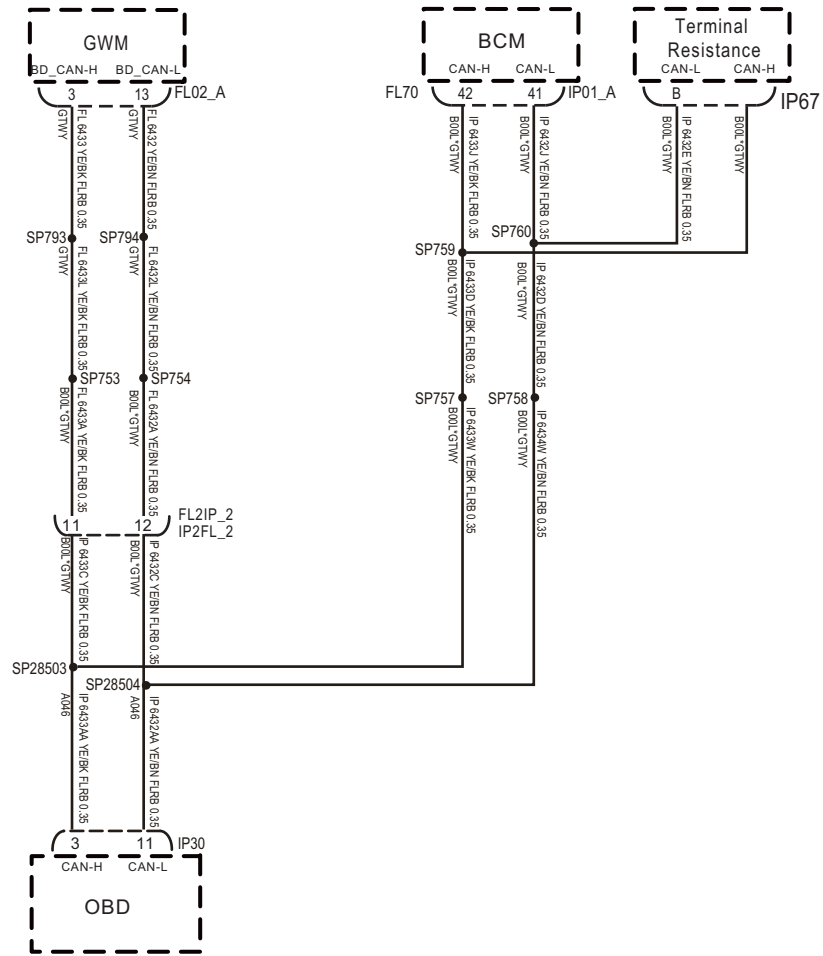

IP01_A

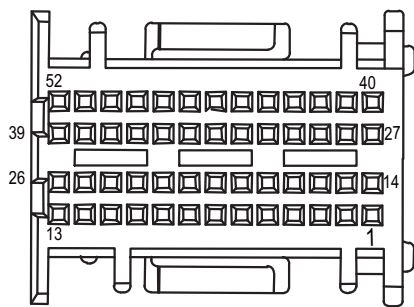

IP67

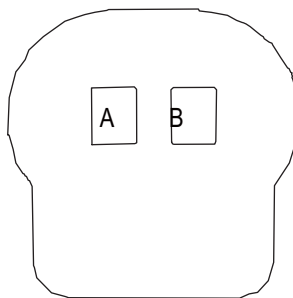

FL02_A

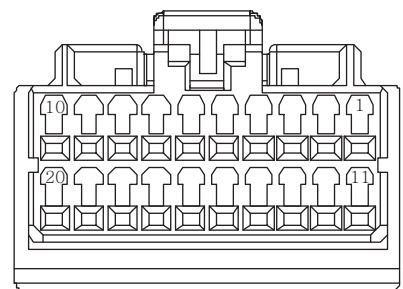

IP30

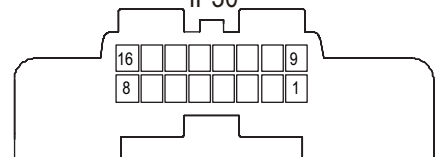

EK890006

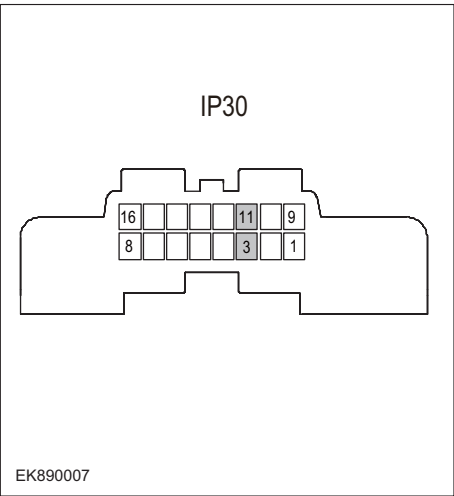
Troubleshooting steps	
Steps1	General inspection.
	<ol style="list-style-type: none"> 1 Check whether the fuse is damaged. 2 Check battery capacity. 3 Check the BCM harness plug for damage, poor contact, aging and looseness. 4 Check whether the result is normal or not?
NO → Repair or replace the faulted parts.	
YES ↓	
Steps2	Check fault codes.
	<ol style="list-style-type: none"> 1 Connect the fault diagnosis instrument to the diagnosis interface. 2 Turn the ignition switch to ON position. 3 Diagnose BCM with diagnostic instrument. 4 If there is any fault code except for U0154-87?
YES → Refer to: DTC Summary list(BCM)	
NO ↓	
Steps3	Inspection for CAN communication network completeness.
	<ol style="list-style-type: none"> 1 Turn the ignition switch to OFF. 2 Measure the resistance between the harness terminals of diagnose interface. Measuring circuit: the resistance between terminal 3 and 11 on plug IP28. Standard value: $\approx 60\Omega$ 3 Check whether the result is normal or not?
NO → Repair or replace the faulted parts.	
YES ↓	

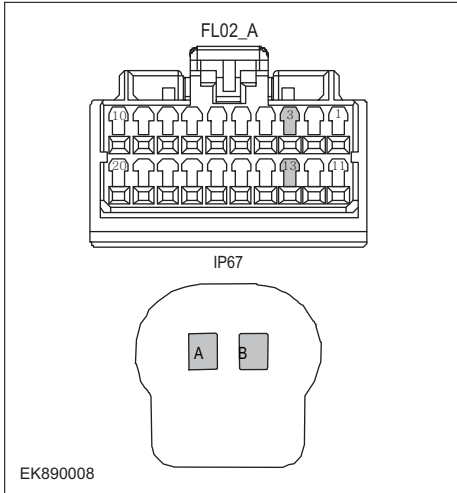
Steps4	Check the terminal resistance of gateway module and BD resistor.
	<ol style="list-style-type: none"> 1 Turn the ignition switch to OFF. 2 Disconnect the gateway module harness plug FL02_A. 3 Measure the resistance between the gateway module harness terminals. Measuring circuit: resistance between terminal 3 and terminal 13 of FL02_A plug. Standard value:110~130Ω 4 Connect the gateway module harness plug FL02_A. 5 Disconnect BD resistor harness plug IP67. 6 Measure the resistance between BD resistor harness terminals. Measuring circuit: resistance between terminal A and terminal B of IP67 plug. Standard value:110~130Ω 7 Check whether the result is normal or not?
<p>NO → Repair or replace the faulted parts.</p>	
<p>YES ↓</p>	
Steps5	Check whether BCM is abnormal.
	<ol style="list-style-type: none"> 1 Turn the ignition switch to OFF. 2 Disconnect and check the connectors IP01_A, IP01_B and IP01_C of BCM harness. 3 Check and repair. <ul style="list-style-type: none"> • Corrosion(install new adapting piece or terminal-cleaning module and pin). • Pin damaged or bent-install new terminal/pin. • Fly out of pins-install new pins as needed. 4 Reconnect the BCM plug and all other previously disconnected plugs. Make sure that the pins are properly positioned and fixed. 5 Run the system and determine if the problem persists?
<p>YES → Replace BCM.</p>	
<p>NO ↓</p>	
<p>At this point the system is functioning normally. The problem may be caused by module connections. Address the root cause of any connector or pin problems,</p>	
<p>Next Step ↓</p>	
<p>Diagnosis end.</p>	

B1001-11、 B1002-12、

Fault diagnosis code
B1001-11: Roof lamp HSD output short to GND
B1002-12: Roof lamp LSD output short to battery
Detection tools
1 Multimeter and diagnostic apparatus
Possible causes
<ul style="list-style-type: none"> • Lines, terminals or connectors • BCM • Fuse failure
Conditions for fault code operation
Turn the ignition switch to ON position.
Conditions for fault code setting
B1001-11
B1002-12
To set the effect of a fault code condition
1
2
Description of circuit diagram

Circuit diagram

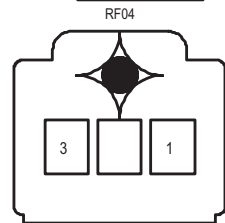
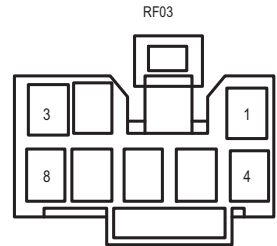
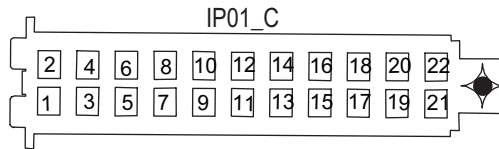
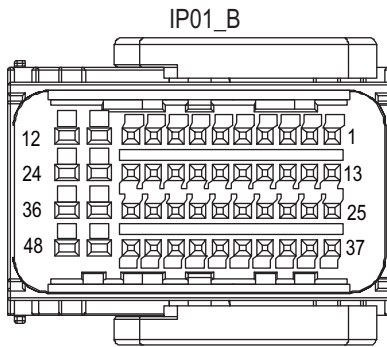
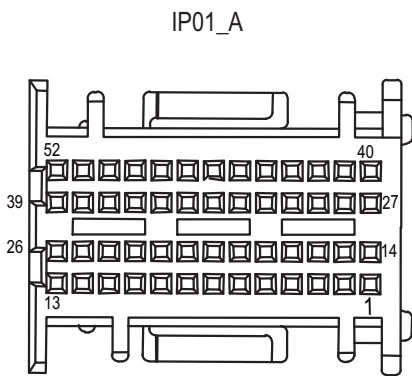
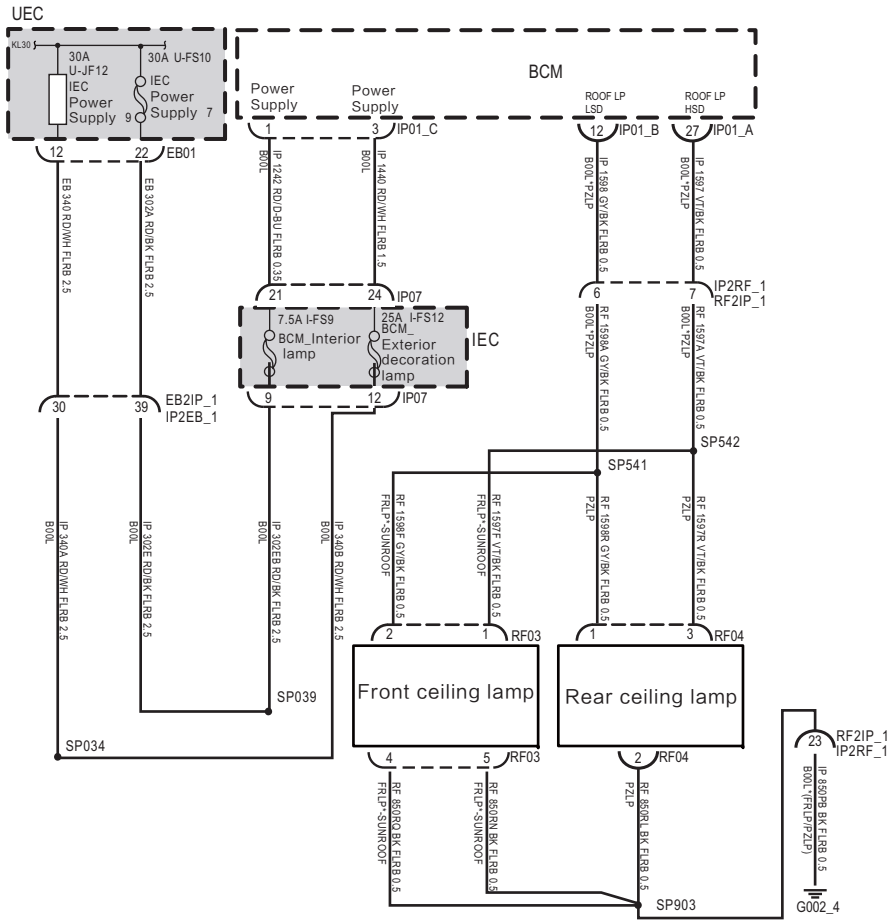

EK890009

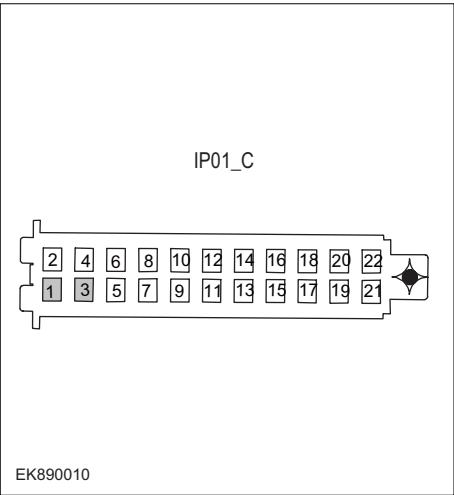
Troubleshooting steps	
Steps1	General inspection.
	<ol style="list-style-type: none"> 1 Check fuseU-JF12、 U-FS10、 I-FS9、 I-FS12 for damage. 2 Check battery capacity. 3 Check the harness plug of air conditioning control module for damage, poor contact, aging and looseness. 4 Check whether the result is normal or not?
NO → Repair or replace the faulted parts.	
YES ↓	
Steps2	Check fault codes.
	<ol style="list-style-type: none"> 1 Connect the fault diagnosis instrument to the diagnosis interface. 2 Turn the ignition switch to ON position. 3 Diagnosticsing BCM using a diagnostics. 4 If there is any fault code except for B1001-11、 B1002-12?
YES → Refer to: DTC Summary list(BCM)	
NO ↓	
Steps3	Check the internal lamp power supply voltage of BCM.
	<ol style="list-style-type: none"> 1 Turn the ignition switch to OFF. 2 Disconnect plug IP01_C of BCM harness. 3 Measure the voltage between BCM harness terminal and ground. Measuring circuit: voltage between terminal 1 of IP01_C plug and ground. Measuring circuit: voltage between terminal 3 of IP01_C plug and ground. Standard value:10~14V 4 Check whether the result is normal or not?
NO → Repair or replace the faulted parts.	
YES ↓	

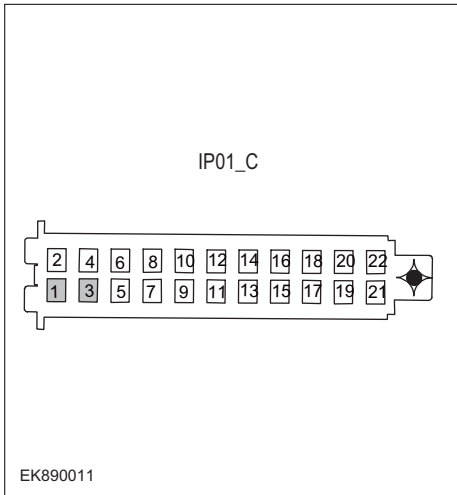
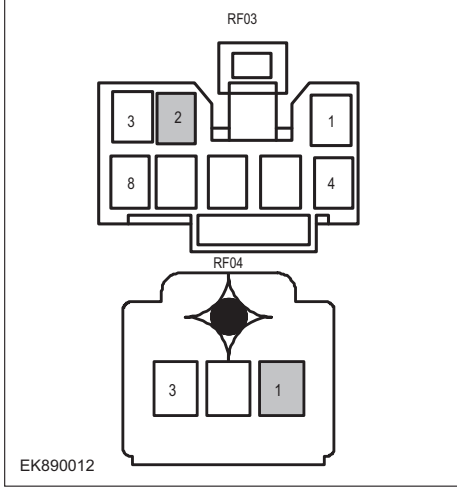
Steps4	Check the power supply voltage of the internal lamp when BCM is started or running.
 <p style="text-align: center;">IP01_C</p> <p style="text-align: left;">EK890011</p>	<ol style="list-style-type: none"> 1 Turn the ignition switch to ON. 2 Measure the voltage between BCM harness terminal and ground. Measuring circuit: voltage between terminal 1 of IP01_C plug and ground. Measuring circuit: voltage between terminal 3 of IP01_C plug and ground. Standard value:10~14V 3 Check whether the result is normal or not?
NO → Repair or replace the faulted parts.	
YES ↓	
Steps5	Check the power supply voltage of the rear dome lamp.
 <p style="text-align: center;">RF03</p> <p style="text-align: center;">RF04</p> <p style="text-align: left;">EK890012</p>	<ol style="list-style-type: none"> 1 Turn the ignition switch to OFF. 2 Connect plug IP01_C of BCM harness. 3 Disconnect the rear ceiling lamp harness plugs RF03 and RF04. 4 Measure the voltage between the rear dome lamp harness terminal and ground. Measuring circuit: voltage between terminal 2 of RF03 plug and ground. Measuring circuit: voltage between terminal 1 of RF04 plug and ground. Standard value:10~14V 5 Check whether the result is normal or not?
NO → Repair or replace the faulted parts.	
YES ↓	

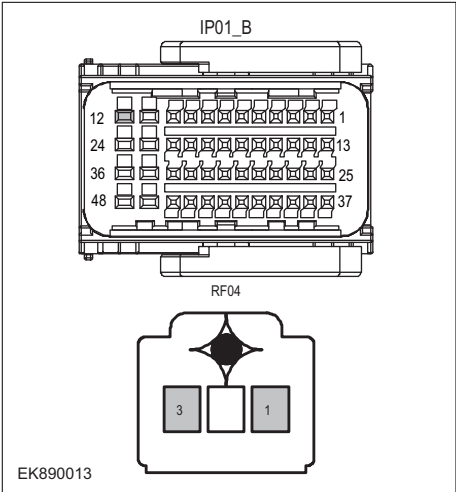
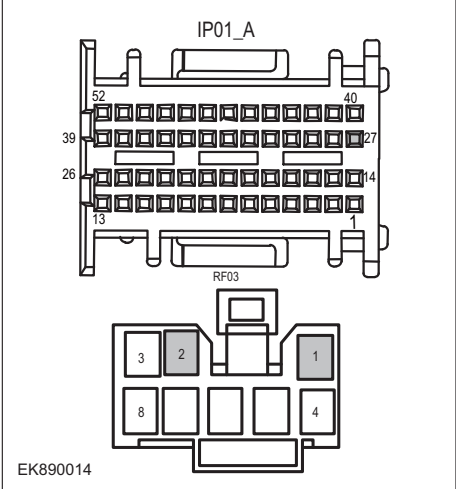
<p>Steps6</p>	<p>Check the rear dome lamp circuit (open circuit).</p>
<div style="text-align: center;">  <p>EK890013</p> </div> <div style="text-align: center; margin-top: 20px;">  <p>EK890014</p> </div>	<ol style="list-style-type: none"> 1 Turn the ignition switch to OFF. 2 Disconnect plug IP01_C of BCM harness. 3 Measure the resistance between the front dome lamp harness terminal and the BCM harness terminal. <ul style="list-style-type: none"> Measuring circuit: resistance between terminal 1 of RF04 plug and terminal 12 of IP01_B plug. Measuring circuit: resistance between terminal 3 of RF04 plug and terminal 27 of IP01_A plug. Measuring circuit: resistance between terminal 2 of RF03 plug and terminal 12 of IP01_B plug. Measuring circuit: resistance between terminal 1 of RF03 plug and terminal 27 of IP01_A plug. <p>Standard value: $\approx 0\Omega$</p> 4 Check whether the result is normal or not?
	<p>NO → Repair or replace the faulted parts.</p>
<p>YES ↓</p>	

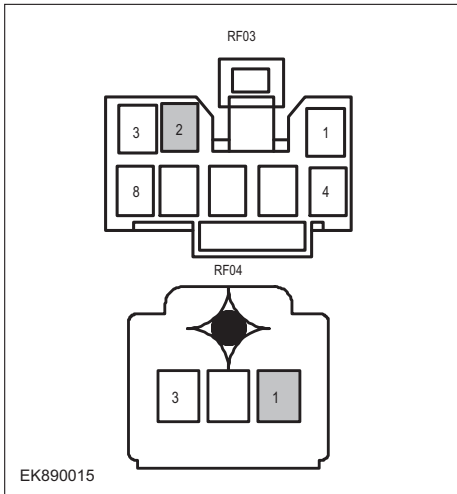
Steps7	Check rear dome lamp circuit (short circuit).
 <p>EK890015</p>	<ol style="list-style-type: none"> 1 Turn the ignition switch to OFF. 2 Connect plug IP01_C of BCM harness. 3 Measure the resistance between rear dome lamp harness plug and ground. Measuring circuit: resistance between terminal 1 of RF04 plug and ground. Measuring circuit: resistance between terminal 2 of RF03 plug and ground. Standard value:infinite 4 Measure the voltage between the rear dome lamp harness plug and ground. Measuring circuit: resistance between terminal 1 of RF04 plug and ground. Measuring circuit: resistance between terminal 2 of RF03 plug and ground. Standard value: ≈ 0V 5 Check whether the result is normal or not? <p>NO → Repair or replace the faulted parts.</p>

YES ↓

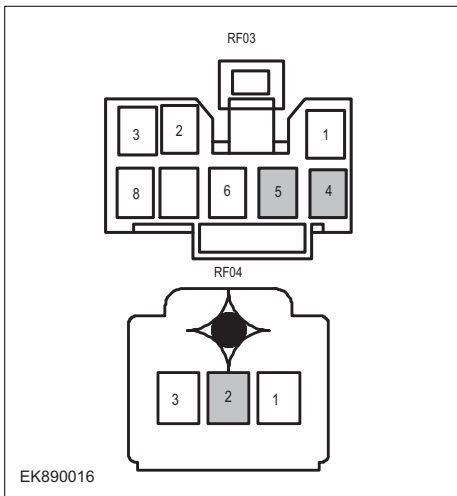
Steps8	Check the rear dome light ground circuit for an open circuit.
 <p>EK890016</p>	<ol style="list-style-type: none"> 1 Turn the ignition switch to OFF. 2 Measure the resistance between rear dome lamp harness plug and ground. Measuring circuit: resistance between terminal 2 of RF04 plug and ground. Measuring circuit: resistance between terminal 4 of RF03 plug and ground. Measuring circuit: resistance between terminal 5 of RF03 plug and ground. Standard value:< 1Ω 3 Test whether the resistance is less than 1Ω? <p>NO → Repair or replace the faulted parts.</p>

YES ↓

BCM

Steps9	Test whether BCM is norm.
	<ol style="list-style-type: none"> 1 Turn the ignition switch to OFF. 2 Disconnect and check the harness plug IP01_A、IP01_B、 IP01_C of BCM. 3 Check and repair. <ul style="list-style-type: none"> • Corrosion(install new adapting piece or terminal-cleaning module and pin). • Pin damaged or bent-install new terminal/pin. • Fly out of pins-install new pins as needed. 4 Reconnect the BCM plug and all other previously disconnected plug. Make sure the pin is properly positioned and fixed. 5 Run the system and determine if the problem persists?
	YES → Replace the BCM.
NO ↓	
At this point the system is functioning normally. The problem may be caused by module connections. Address the root cause of any connector or pin problems,	
Next Step ↓	
Diagnosis end.	

B1003-13、 B1003-11

Fault diagnosis code
B1003-13: Reverse lamp output open
B1003-11: Reverse lamp output short to GND
Detection tools
1 Multimeter and diagnostic apparatus
Possible causes
<ul style="list-style-type: none"> • Lines, terminals or connectors • Storage battery • BCM • Charging system • Fuse
Conditions for fault code operation
Turn the ignition switch to ON position.
Conditions for fault code setting
B1003-13
B1003-11
To set the effect of a fault code condition
Description of circuit diagram
The body control module will continuously monitor whether the sensor and actuator are in normal range. Meanwhile, it will check the connector for virtual connection, short circuit, open circuit and the connection rationality with other signals. In case of any fault, the body control module will save the fault code and enable the safety mode.

Circuit diagram

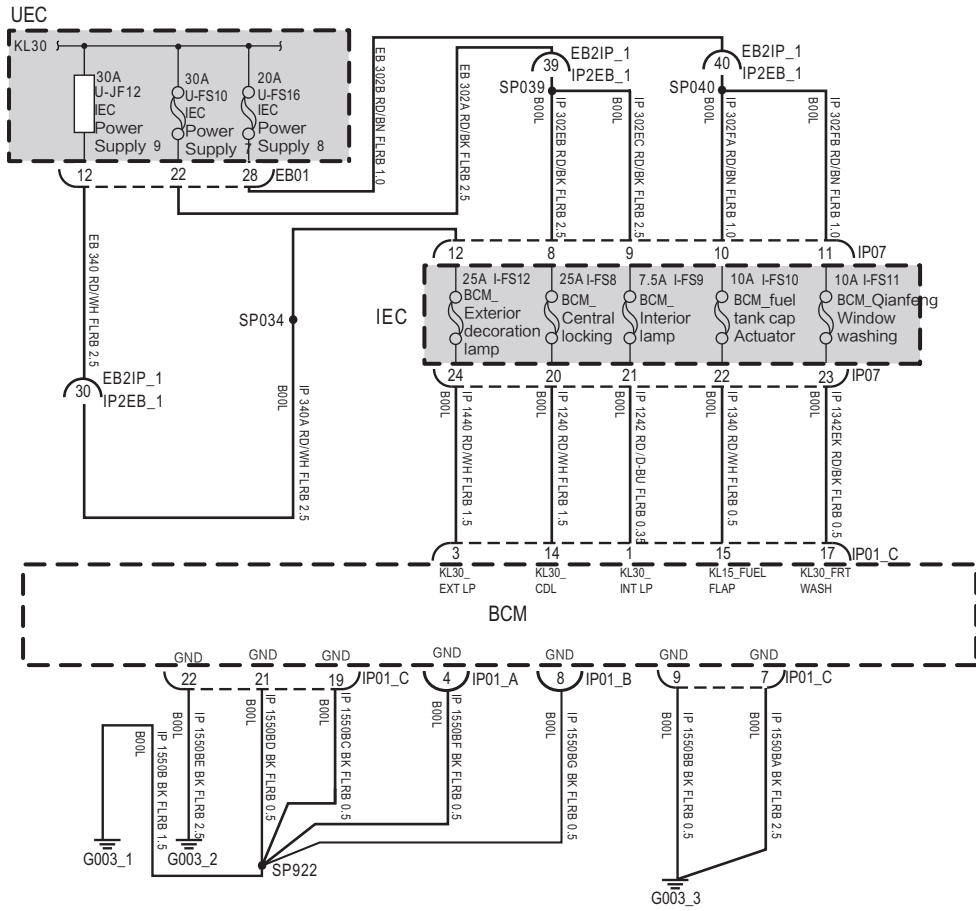

IP01_A

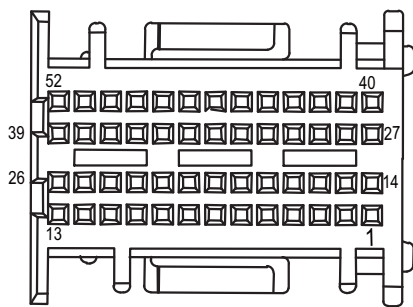

IP01_B

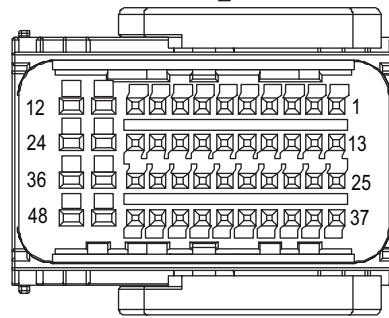

IP01_C

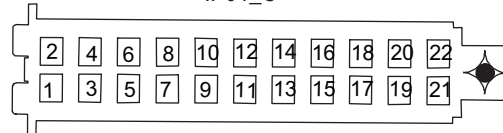

EK890001

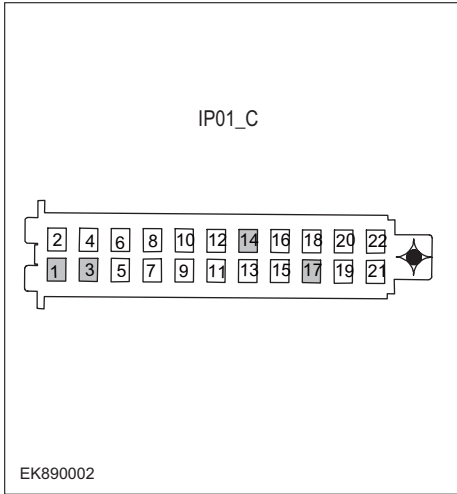
Troubleshooting steps	
Steps1	General inspection.
	<ol style="list-style-type: none"> 1 Check fuseU-JF12、 U-FS10、 U-FS16 for damage. 2 Check battery capacity. 3 Check the harness plug of air conditioning control module for damage, poor contact, aging and looseness. 4 Check whether the result is normal or not?
	NO → Repair or replace the faulted parts.
YES ↓	
Steps2	Check fault codes.
	<ol style="list-style-type: none"> 1 Connect the fault diagnosis instrument to the diagnosis interface. 2 Turn the ignition switch to ON position. 3 Diagnosticsing BCM using a diagnostics. 4 If there is any fault code except for B1003-13、 B1003-11?
	YES → Refer to: DTC Summary list(BCM)
NO ↓	
Steps3	Check the supply voltage of BCM battery.
	<ol style="list-style-type: none"> 1 Turn the ignition switch to OFF. 2 Disconnect plug IP01_C of BCM harness. 3 Measure the voltage between BCM harness terminal and ground. <p>Measuring circuit: voltage between terminal 1 of IP01_C plug and ground.</p> <p>Measuring circuit: voltage between terminal 3 of IP01_C plug and ground.</p> <p>Measuring circuit: voltage between terminal 14 of IP01_C plug and ground.</p> <p>Measuring circuit: voltage between terminal 17 of IP01_C plug and ground.</p> <p>Standard value:10~14V</p> 4 Check whether the result is normal or not?
	NO → Repair or replace the faulted parts.
YES ↓	

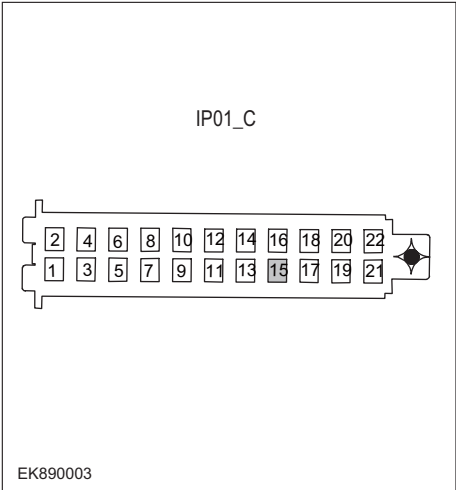
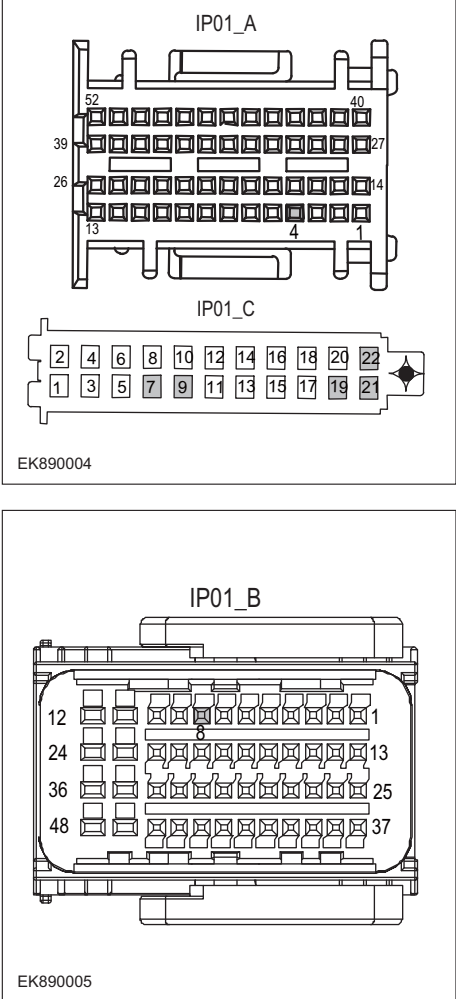
Steps4	Check the power supply voltage when BCM is started or running.
 <p>IP01_C</p> <p>EK890003</p>	<ol style="list-style-type: none"> 1 Turn the ignition switch to ON. 2 Measure the voltage between IP01_C harness terminal and ground. Measuring circuit: voltage between terminal 15 of IP01_C plug and ground. Standard value:10~14V 3 Check whether the result is normal or not?
NO → Repair or replace the faulted parts.	
YES ↓	
Steps5	Check BCM ground circuit for open circuit.
 <p>IP01_A</p> <p>IP01_C</p> <p>IP01_B</p> <p>EK890004</p> <p>EK890005</p>	<ol style="list-style-type: none"> 1 Turn the ignition switch to OFF. 2 Disconnect the connectors IP01_A, IP01_B and IP01_C of BCM harness. 3 Measure the resistance between BCM harness plug and ground. Measuring circuit: resistance between terminal 22 of IP01_C plug and ground. Measuring circuit: resistance between terminal 21 of IP01_C plug and ground. Measuring circuit: resistance between No.19 terminal of IP01_C plug and ground. Measuring circuit: resistance between terminal 4 of IP01_A plug and ground. Measuring circuit: resistance between No.8 terminal of IP01_B plug and ground. Measuring circuit: resistance between No.9 terminal of IP01_C plug and ground. Measuring circuit: resistance between terminal 7 of IP01_C plug and ground. Standard value:< 1Ω 4 Test whether the resistance is less than 1Ω?
NO → Repair or replace the faulted parts.	
YES ↓	

Steps6	Test whether BCM is norm.
	<ol style="list-style-type: none"> 1 Turn the ignition switch to OFF. 2 Disconnect and check the connectors IP01_A, IP01_B and IIP01_C of BCM harness. 3 Check and repair. <ul style="list-style-type: none"> • Corrosion(install new adapting piece or terminal-cleaning module and pin). • Pin damaged or bent-install new terminal/pin. • Fly out of pins-install new pins as needed. 4 Reconnect the BCM plug and all other previously disconnected plug. Make sure the pin is properly positioned and fixed. 5 Run the system and determine if the problem persists?
	YES → Replace the BCM.
NO ↓	
At this point the system is functioning normally. The problem may be caused by module connections. Address the root cause of any connector or pin problems,	
Next Step ↓	
Diagnosis end.	

B1004-13、 B1004-11

Fault diagnosis code
B1004-13: Brake lamp output open
B1004-11: Brake lamp output short to GND
Detection tools
1 Multimeter and diagnostic apparatus
Possible causes
<ul style="list-style-type: none"> • Lines, terminals or connectors • BCM • Brake light failure • Fuse failure
Conditions for fault code operation
Turn the ignition switch to ON position.
Conditions for fault code setting
B1004-13
B1004-11
To set the effect of a fault code condition
1
2
Description of circuit diagram

Circuit diagram

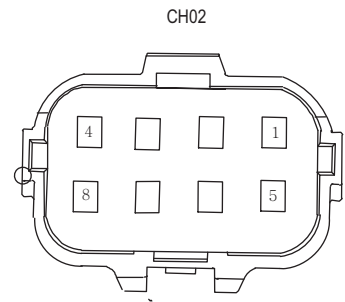
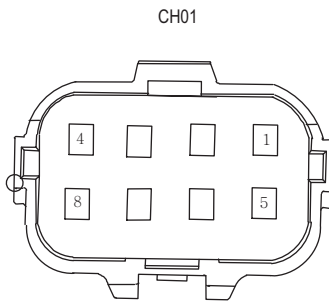
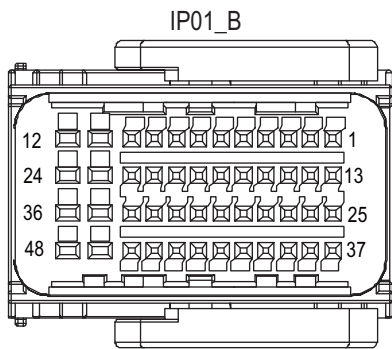
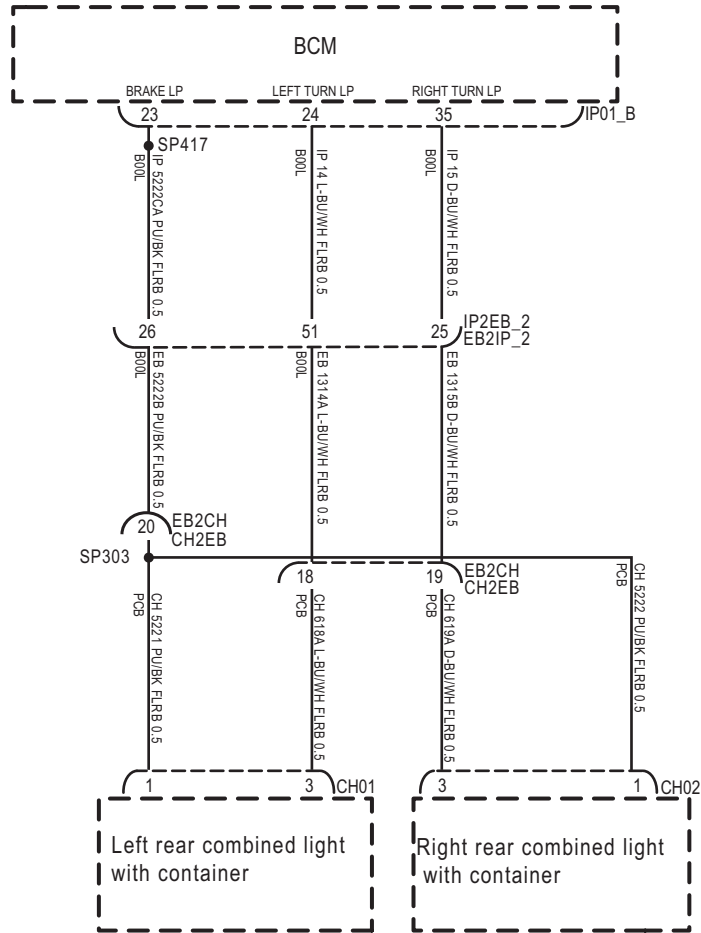

EK890017

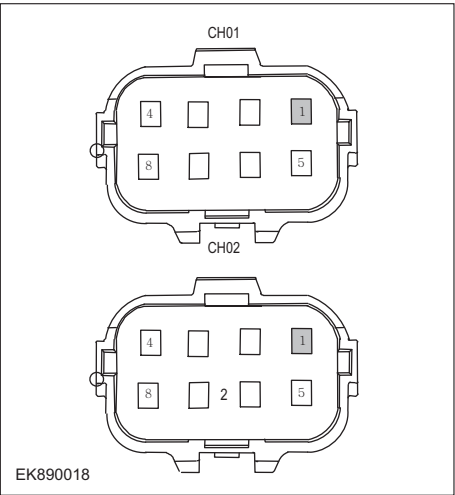
Troubleshooting steps	
Steps1	General inspection.
	<ol style="list-style-type: none"> 1 Check whether the fuse is damaged. 2 Check battery capacity. 3 Check the harness plug of air conditioning control module for damage, poor contact, aging and looseness. 4 Check whether the result is normal or not?
	NO → Repair or replace the faulted parts.
YES ↓	
Steps2	Check fault codes.
	<ol style="list-style-type: none"> 1 Connect the fault diagnosis instrument to the diagnosis interface. 2 Turn the ignition switch to ON position. 3 Diagnosticsing BCM using a diagnostics. 4 If there is any fault code except for B1004-13、 B1004-11?
	YES → Refer to: DTC Summary list(BCM)
NO ↓	
Steps3	Check the power supply of the brake light in the starting or running state.
	<ol style="list-style-type: none"> 1 Turn the ignition switch to OFF. 2 Disconnect the left brake light harness plug CH01. 3 Disconnect the right brake light harness plug CH02. 4 Turn the ignition switch to ON. 5 Measure the voltage between stop lamp harness terminal and ground. Measuring circuit: voltage between terminal 1 of CH01 plug and ground. 測 Measuring circuit: the voltage between terminal 1 of CH02 plug and ground. Standard value:10~14V 6 Check whether the result is normal or not?
	NO → Repair or replace the faulted parts.
YES ↓	

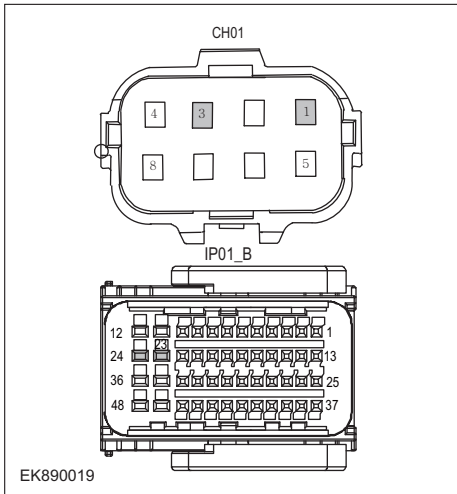
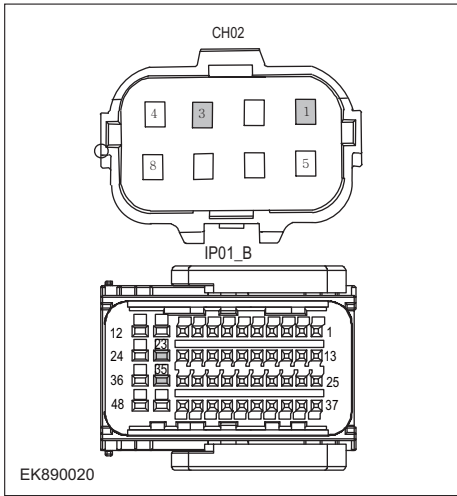
<p>Steps6</p>	<p>Check the circuit between stop lamp and BCM (open circuit).</p>
 	<ol style="list-style-type: none"> 1 Turn the ignition switch to OFF. 2 Disconnect the BCM harness plug IP01 _ b. 3 Measure the resistance between stop lamp harness terminal and BCM harness terminal. <ul style="list-style-type: none"> Measuring circuit: resistance between No.1 terminal of CH01 plug and No.23 terminal of IP01_B plug. Measuring circuit: resistance between No.3 terminal of CH01 plug and No.24 terminal of IP01_B plug. Measuring circuit: resistance between No.3 terminal of CH02 plug and No.35 terminal of IP01_B plug. Measuring circuit: resistance between terminal 1 of CH02 plug and terminal 23 of IP01_B plug. <p>Standard value: $\approx 0\Omega$</p> 4 Check whether the result is normal or not?
	<p>NO → Repair or replace the faulted parts.</p>
<p>YES ↓</p>	

BCM

Steps8	Test whether BCM is norm.
	<ol style="list-style-type: none"> 1 Turn the ignition switch to OFF. 2 Disconnect and check the connectors IP01_A, IP01_B and IIP01_C of BCM harness. 3 Check and repair. <ul style="list-style-type: none"> • Corrosion(install new adapting piece or terminal-cleaning module and pin). • Pin damaged or bent-install new terminal/pin. • Fly out of pins-install new pins as needed. 4 Reconnect the BCM plug and all other previously disconnected plug. Make sure the pin is properly positioned and fixed. 5 Run the system and determine if the problem persists?
	YES → Replace the BCM.
NO ↓	
At this point the system is functioning normally. The problem may be caused by module connections. Address the root cause of any connector or pin problems,	
Next Step ↓	
Diagnosis end.	

B1005-13、 B1005-11

Fault diagnosis code
B1005-13: Trunk lamp output open
B1005-11: Trunk lamp output short to GND
Detection tools
1 Multimeter and diagnostic apparatus
Possible causes
<ul style="list-style-type: none"> • Lines, terminals or connectors • Storage battery • BCM • Charging system • Fuse
Conditions for fault code operation
Turn the ignition switch to ON position.
Conditions for fault code setting
B1005-13
B1005-11
To set the effect of a fault code condition
Description of circuit diagram
The body control module will continuously monitor whether the sensor and actuator are in normal range. Meanwhile, it will check the connector for virtual connection, short circuit, open circuit and the connection rationality with other signals. In case of any fault, the body control module will save the fault code and enable the safety mode.

Circuit diagram

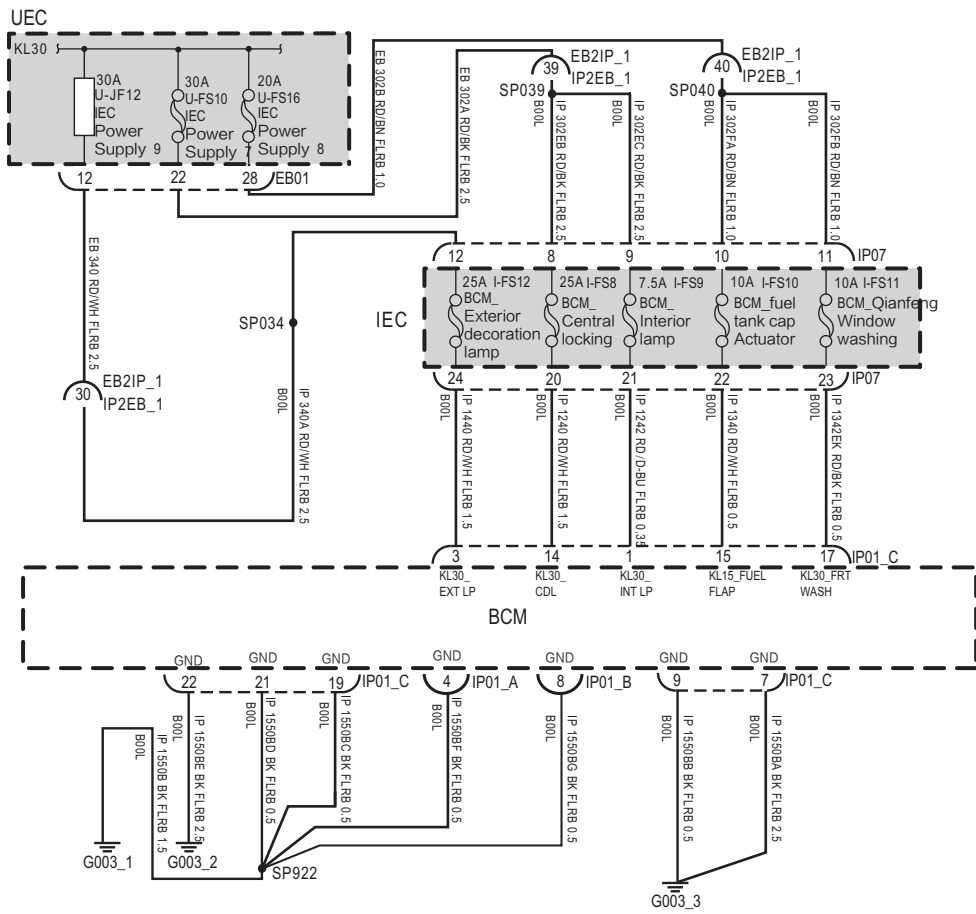

IP01_A

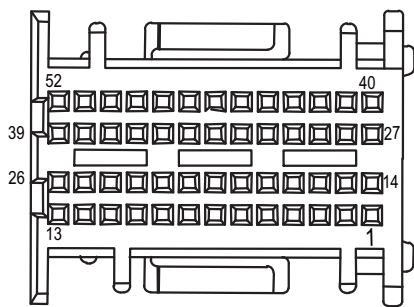

IP01_B

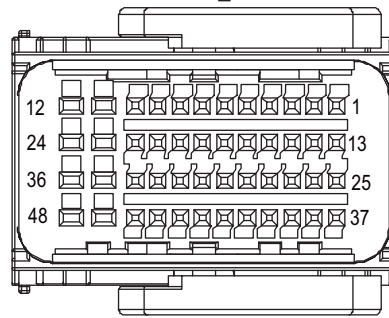

IP01_C

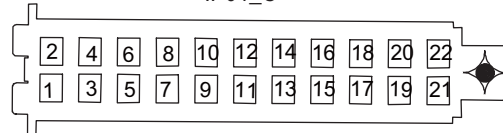

EK890001

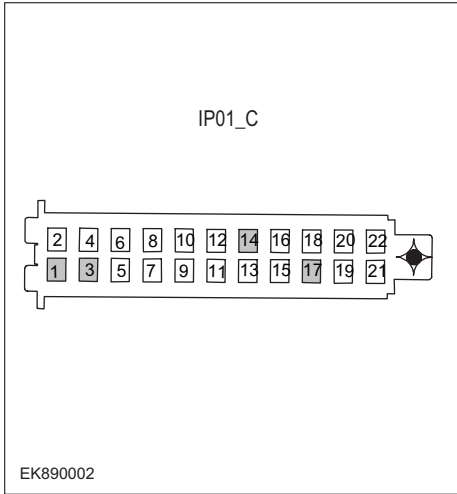
Troubleshooting steps	
Steps1	General inspection.
	<ol style="list-style-type: none"> 1 Check fuseU-JF12、 U-FS10、 U-FS16 for damage. 2 Check battery capacity. 3 Check the harness plug of air conditioning control module for damage, poor contact, aging and looseness. 4 Check whether the result is normal or not?
	NO → Repair or replace the faulted parts.
YES ↓	
Steps2	Check fault codes.
	<ol style="list-style-type: none"> 1 Connect the fault diagnosis instrument to the diagnosis interface. 2 Turn the ignition switch to ON position. 3 Diagnosticsing BCM using a diagnostics. 4 If there is any fault code except for B1005-13、 B1005-11?
	YES → Refer to: DTC Summary list(BCM)
NO ↓	
Steps3	Check the supply voltage of BCM battery.
	<ol style="list-style-type: none"> 1 Turn the ignition switch to OFF. 2 Disconnect plug IP01_C of BCM harness. 3 Measure the voltage between BCM harness terminal and ground. <p>Measuring circuit: voltage between terminal 1 of IP01_C plug and ground.</p> <p>Measuring circuit: voltage between terminal 3 of IP01_C plug and ground.</p> <p>Measuring circuit: voltage between terminal 14 of IP01_C plug and ground.</p> <p>Measuring circuit: voltage between terminal 17 of IP01_C plug and ground.</p> <p>Standard value:10~14V</p> 4 Check whether the result is normal or not?
	NO → Repair or replace the faulted parts.
YES ↓	

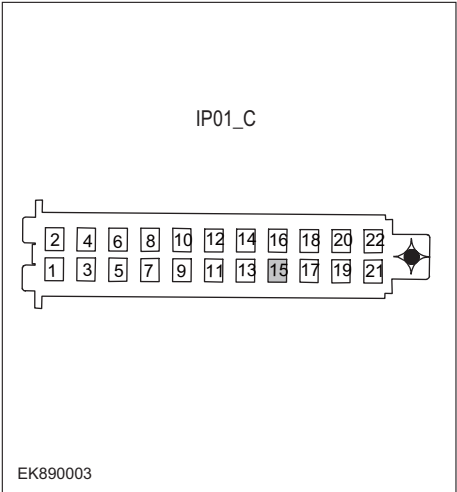
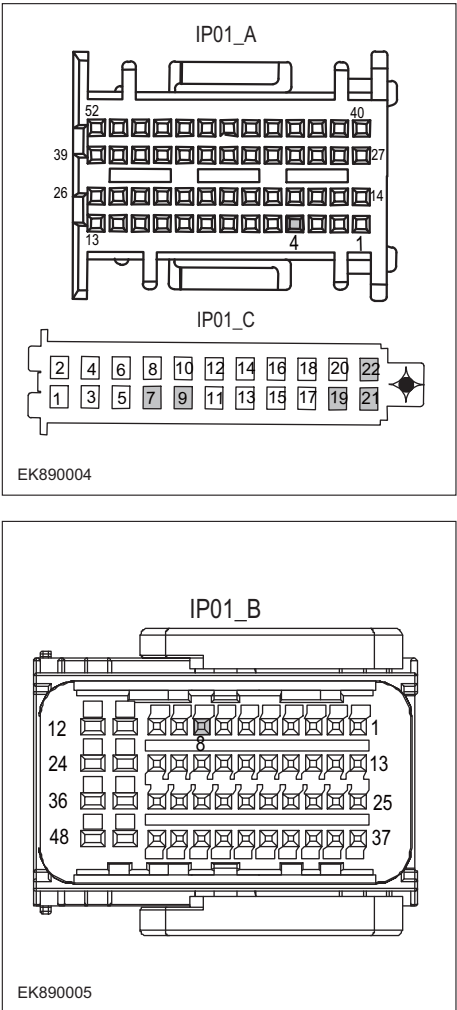
Steps4	Check the power supply voltage when BCM is started or running.
	<ol style="list-style-type: none"> 1 Turn the ignition switch to ON. 2 Measure the voltage between IP01_C harness terminal and ground. Measuring circuit: voltage between terminal 15 of IP01_C plug and ground. Standard value:10~14V 3 Check whether the result is normal or not?
NO → Repair or replace the faulted parts.	
YES ↓	
Steps5	Check BCM ground circuit for open circuit.
	<ol style="list-style-type: none"> 1 Turn the ignition switch to OFF. 2 Disconnect the connectors IP01_A, IP01_B and IP01_C of BCM harness. 3 Measure the resistance between BCM harness plug and ground. Measuring circuit: resistance between terminal 22 of IP01_C plug and ground. Measuring circuit: resistance between terminal 21 of IP01_C plug and ground. Measuring circuit: resistance between No.19 terminal of IP01_C plug and ground. Measuring circuit: resistance between terminal 4 of IP01_A plug and ground. Measuring circuit: resistance between No.8 terminal of IP01_B plug and ground. Measuring circuit: resistance between No.9 terminal of IP01_C plug and ground. Measuring circuit: resistance between terminal 7 of IP01_C plug and ground. Standard value:< 1Ω 4 Test whether the resistance is less than 1Ω?
NO → Repair or replace the faulted parts.	
YES ↓	

Steps6	Test whether BCM is norm.
	<ol style="list-style-type: none"> 1 Turn the ignition switch to OFF. 2 Disconnect and check the connectors IP01_A, IP01_B and IIP01_C of BCM harness. 3 Check and repair. <ul style="list-style-type: none"> • Corrosion(install new adapting piece or terminal-cleaning module and pin). • Pin damaged or bent-install new terminal/pin. • Fly out of pins-install new pins as needed. 4 Reconnect the BCM plug and all other previously disconnected plug. Make sure the pin is properly positioned and fixed. 5 Run the system and determine if the problem persists?
	YES → Replace the BCM.
NO ↓	
At this point the system is functioning normally. The problem may be caused by module connections. Address the root cause of any connector or pin problems,	
Next Step ↓	
Diagnosis end.	

B1006-13、 B1006-12

Fault diagnosis code
B1006-13: Daytime lamp output open
B1006-12: Daytime lamp output short to Battery
Detection tools
1 Multimeter and diagnostic apparatus
Possible causes
<ul style="list-style-type: none"> • Lines, terminals or connectors • BCM • Daylight failure • Fuse failure • Relay failure
Conditions for fault code operation
Turn the ignition switch to ON position.
Conditions for fault code setting
B1006-13
B1006-12
To set the effect of a fault code condition
1
2
Description of circuit diagram

Circuit diagram

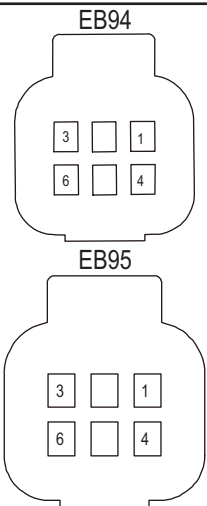
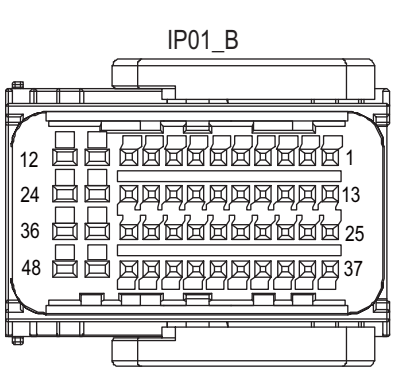
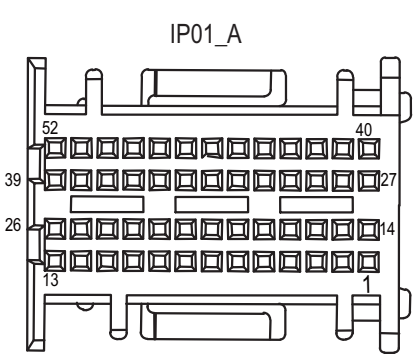
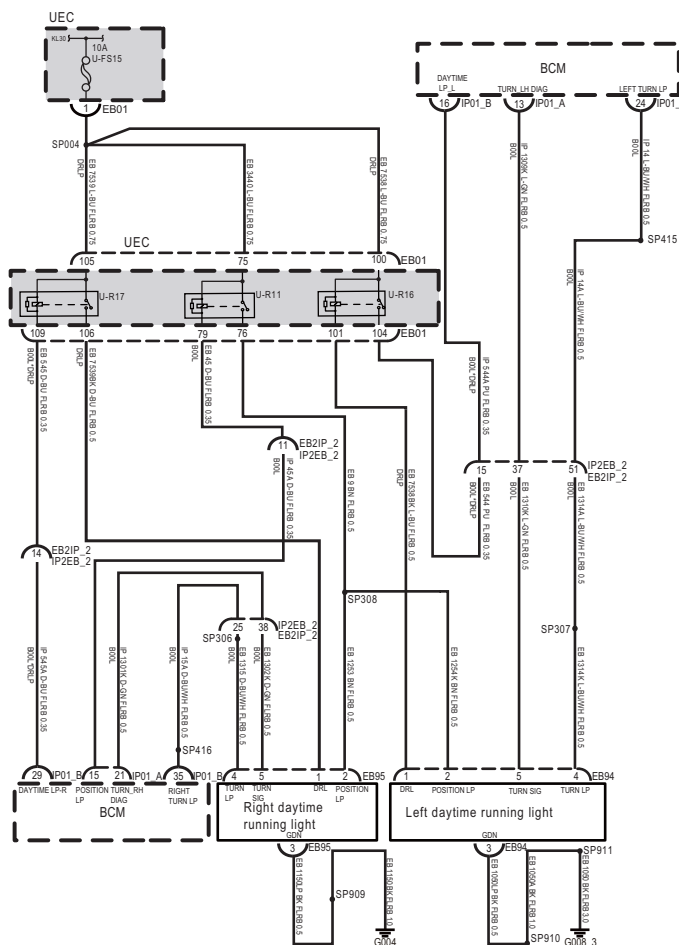

EK890021

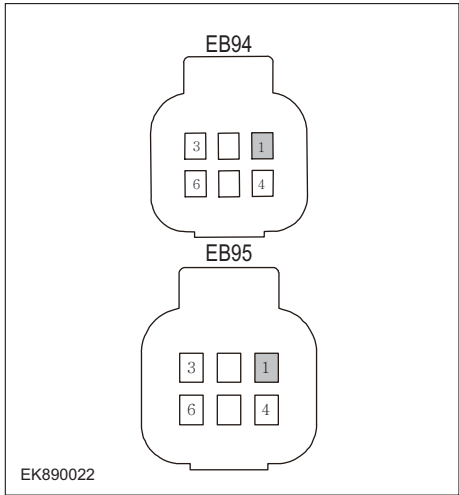
Troubleshooting steps	
Steps1	General inspection.
	<ol style="list-style-type: none"> 1 Check fuseU-FS15 for damage. 2 Check relayU-R17、 U-R16 for damage. 3 Check battery capacity. 4 Check the harness plug of air conditioning control module for damage, poor contact, aging and looseness. 5 Check whether the result is normal or not?
NO → Repair or replace the faulted parts.	
YES ↓	
Steps2	Check fault codes.
	<ol style="list-style-type: none"> 1 Connect the fault diagnosis instrument to the diagnosis interface. 2 Turn the ignition switch to ON position. 3 Diagnostocsing BCM using a diagnostics. 4 If there is any fault code except for B1006-13、 B1006-12?
YES → Refer to: DTC Summary list(BCM)	
NO ↓	
Steps3	Check the power supply of daytime running lights in starting or running state.
 <p>EK890022</p>	<ol style="list-style-type: none"> 1 Turn the ignition switch to OFF. 2 Disconnect the left daytime running lamp harness plug EB94. 3 Disconnect the right daytime running lamp harness plug EB95. 4 Turn the ignition switch to ON. 5 Turn on the daytime running lights. 6 Measure the voltage between the harness terminal of daytime running lamp and ground. Measuring circuit: voltage between No.1 terminal of EB94 plug and ground. Measuring circuit: voltage between terminal 1 of EB95 plug and ground. Standard value:10~14V 7 Check whether the result is normal or not?
NO → Repair or replace the faulted parts.	
YES ↓	

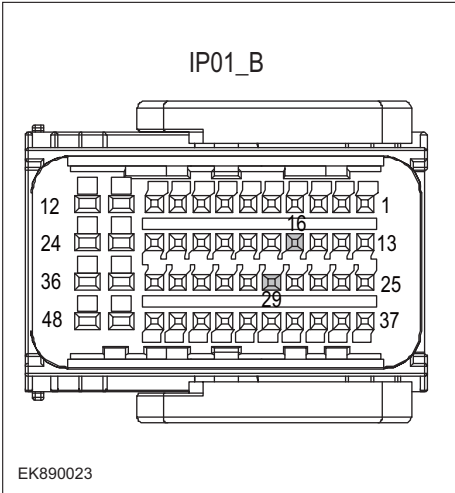
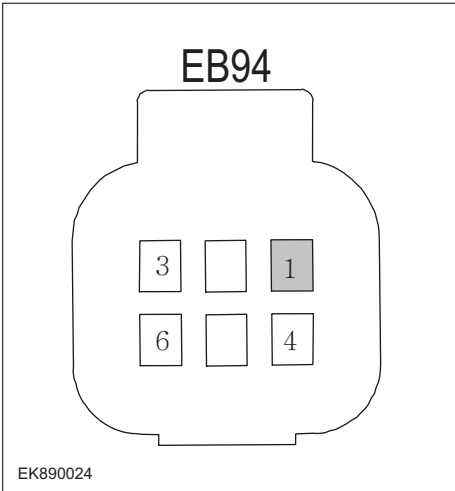
Steps4	Check the circuit between daytime running lamp relay and BCM (open circuit).
	<ol style="list-style-type: none"> 1 Turn the ignition switch to OFF. 2 Disconnect BCM harness plug IP01 _ b. 3 Disconnect the wiring harness plug EB01 of UEC auxiliary fuse box. 4 Measure the resistance between UEC fuse box harness terminal and BCM harness terminal. Measuring circuit: resistance between terminal 109 of EB01 plug and terminal 29 of IP01_B plug. Measuring circuit: resistance between terminal 104 of EB01 plug and terminal 16 of IP01_B plug. Standard value: $\approx 0\Omega$ 5 Check whether the result is normal or not?
NO → Repair or replace the faulted parts.	
YES ↓	
Steps5	Check the circuit (open circuit) between the left daytime running lamp relay and the daytime running lamp.
	<ol style="list-style-type: none"> 1 Measure the resistance between UEC fuse box harness terminal and daytime running lamp harness terminal. Measuring circuit: resistance between terminal 101 of EB01 plug and terminal 1 of EB94 plug. Standard value: $\approx 0\Omega$ 2 Check whether the result is normal or not?
NO → Repair or replace the faulted parts.	
YES ↓	

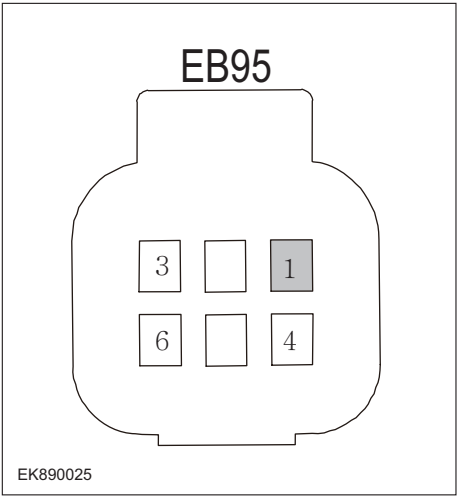
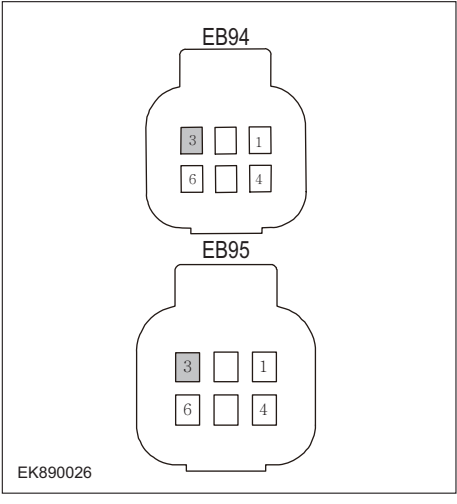
Steps6	Check the circuit (open circuit) between the right daytime running lamp relay and the daytime running lamp.
 <p>EB95</p> <p>EK890025</p>	<ol style="list-style-type: none"> 1 Measure the resistance between UEC fuse box harness terminal and daytime running lamp harness terminal. Measuring circuit: resistance between terminal 106 of EB01 plug and terminal 1 of EB95 plug. Standard value: $\approx 0\Omega$ 2 Check whether the result is normal or not?
<p>NO → Repair or replace the faulted parts.</p>	
<p>YES ↓</p>	
Steps7	Check the ground circuit of daytime running lamp for an open circuit.
 <p>EB94</p> <p>EB95</p> <p>EK890026</p>	<ol style="list-style-type: none"> 1 Turn the ignition switch to OFF. 2 Measure the resistance between harness plug of daytime running lamp and ground. Measuring circuit: resistance between terminal 3 of EB94 plug and ground. Measuring circuit: resistance between terminal 3 of EB95 plug and ground. Standard value: $< 1\Omega$ 3 Test whether the resistance is less than 1Ω?
<p>NO → Repair or replace the faulted parts.</p>	
<p>YES ↓</p>	

Steps8	Test whether BCM is norm.
	<ol style="list-style-type: none"> 1 Turn the ignition switch to OFF. 2 Disconnect and check the harness plug IP01_A、IP01_B、 IP01_C of BCM. 3 Check and repair. <ul style="list-style-type: none"> • Corrosion(install new adapting piece or terminal-cleaning module and pin). • Pin damaged or bent-install new terminal/pin. • Fly out of pins-install new pins as needed. 4 Reconnect the BCM plug and all other previously disconnected plug. Make sure the pin is properly positioned and fixed. 5 Run the system and determine if the problem persists?
	YES → Replace the BCM.
NO ↓	
At this point the system is functioning normally. The problem may be caused by module connections. Address the root cause of any connector or pin problems,	
Next Step ↓	
Diagnosis end.	

B1007-13、 B1007-11、 B1008-13、 B1008-11

Fault diagnosis code
B1007-13: Turn lamp left output open
B1007-11: Turn lamp left output short to GND
B1008-13: Turn lamp right output open
B1008-11: Turn lamp right output short to GND OFF
Detection tools
1 Multimeter and diagnostic apparatus
Possible causes
<ul style="list-style-type: none"> • Lines, terminals or connectors • BCM • Left Front Turn Signal Malfunction • Fuse failure
Conditions for fault code operation
Turn the ignition switch to ON position.
Conditions for fault code setting
B1007-13
B1007-11
B1008-13
B1008-11
To set the effect of a fault code condition
1
2
Description of circuit diagram

Circuit diagram

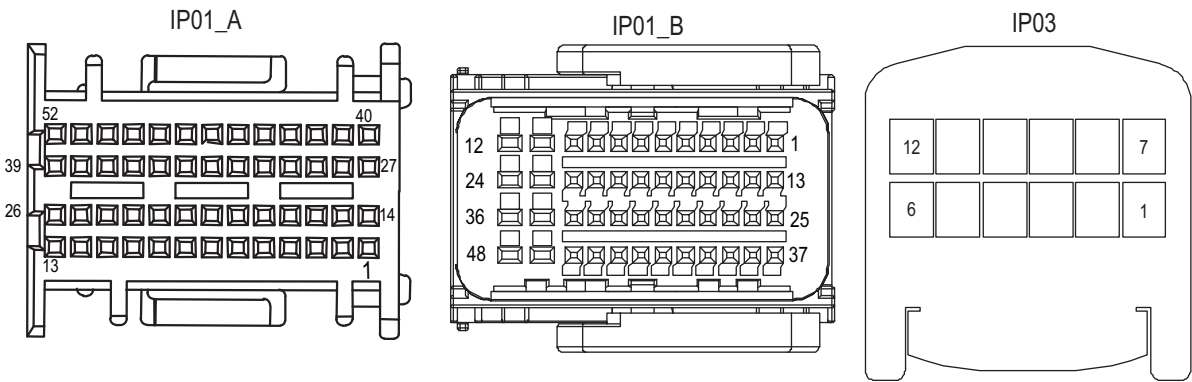
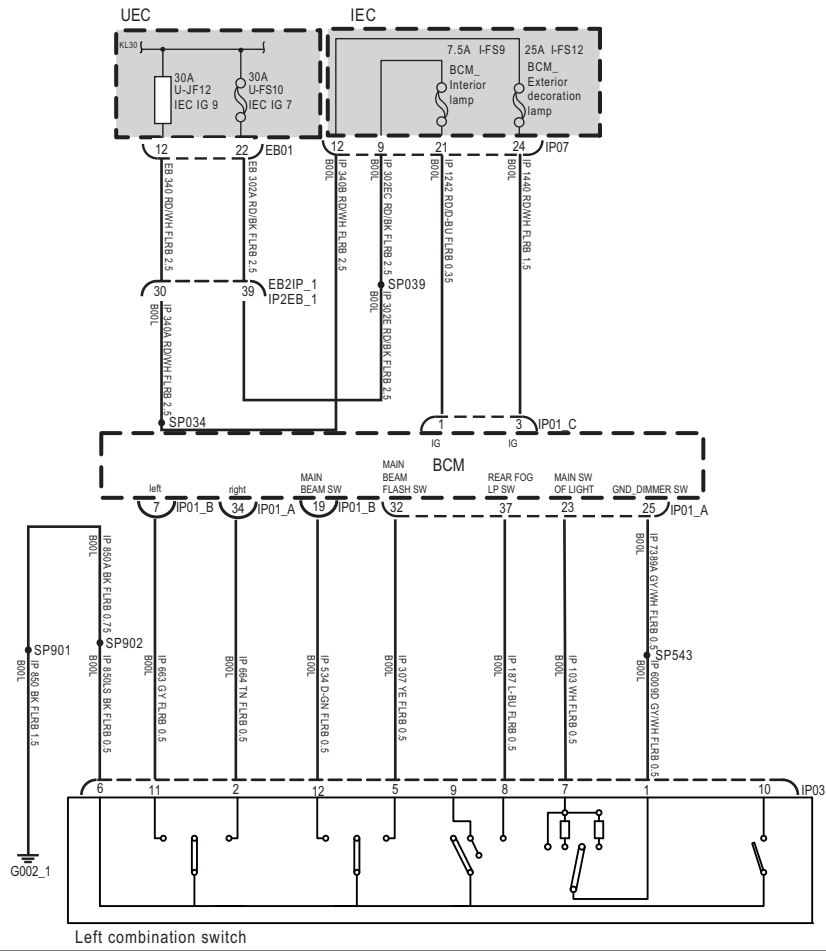

EK890027

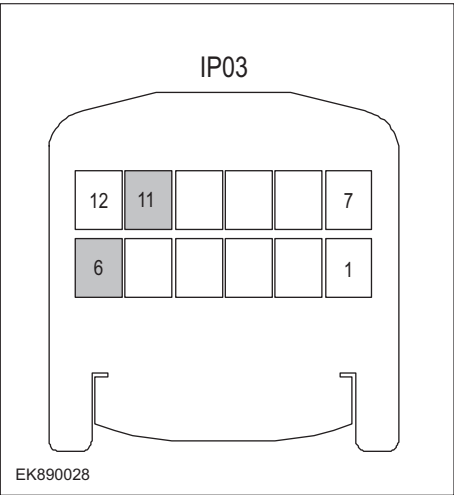
Troubleshooting steps	
Steps1	General inspection.
	<ol style="list-style-type: none"> 1 Check fuse U-JF12、 U-FS10、 I-FS9、 I-FS12 for damage. 2 Check battery capacity. 3 Check the harness plug of air conditioning control module for damage, poor contact, aging and looseness. 4 Check whether the result is normal or not?
NO → Repair or replace the faulted parts.	
YES ↓	
Steps2	Check fault codes.
	<ol style="list-style-type: none"> 1 Connect the fault diagnosis instrument to the diagnosis interface. 2 Turn the ignition switch to ON position. 3 Diagnosticsing BCM using a diagnostics. 4 If there is any fault code except for B1007-13、 B1007-11、 B1008-13、 B1008-11?
YES → Refer to: DTC Summary list(BCM)	
NO ↓	
Steps3	Check the combination light switch (turn signal switch) (component inspection).
	<ol style="list-style-type: none"> 1 Turn the ignition switch to OFF. 2 Disconnect the combination light switch harness plug IP03. 3 Set the combination light switch to the "left turn signal" position, and measure the resistance between the combination light switch terminals (combination switch terminal). Measuring circuit: resistance between terminal 11 of IP03 plug and terminal 6 of IP03 plug. Standard value: ≈ 0Ω 4 Check whether the result is normal or not?
NO → Please replace the combination light switch.	
YES ↓	

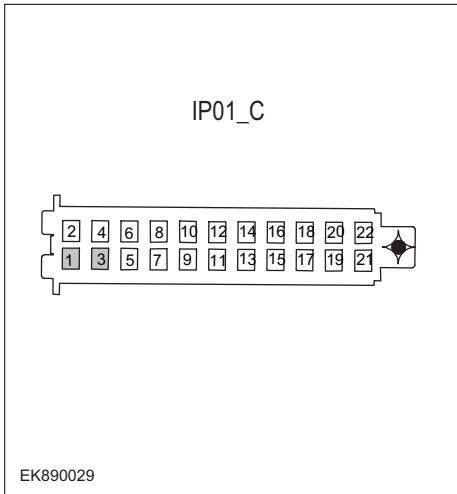
Steps4	Check the power supply of the turn signal in the starting or running state.
 <p style="text-align: center;">IP01_C</p> <p style="text-align: left; font-size: small;">EK890029</p>	<ol style="list-style-type: none"> 1 Turn the ignition switch to OFF. 2 Disconnect plug IP01_C of BCM harness. 3 Turn the ignition switch to ON. 4 Measure the voltage between the turn signal harness terminal and ground. Measuring circuit: voltage between terminal 1 of IP01_C plug and ground. Measuring circuit: voltage between terminal 3 of IP01_C plug and ground. Standard value:10~14V 5 Check whether the result is normal or not?

NO → Repair or replace the faulted parts.

YES ↓

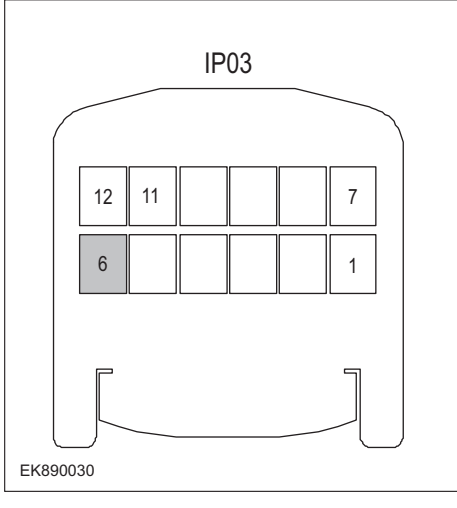
Steps5	検 Check the turn signal grounding circuit for an open circuit.
 <p style="text-align: center;">IP03</p> <p style="text-align: left; font-size: small;">EK890030</p>	<ol style="list-style-type: none"> 1 Turn the ignition switch to OFF. 2 Measure the resistance between left front turn signal harness plug and ground. Measuring circuit: resistance between terminal 6 of IP03 plug and ground. Standard value:< 1Ω 3 Test whether the resistance is less than 1Ω?

NO → Repair or replace the faulted parts.

YES ↓

BCM

Steps6	Test whether BCM is norm.
	<ol style="list-style-type: none"> 1 Turn the ignition switch to OFF. 2 Disconnect and check the harness plug IP01_A、IP01_B、 IP01_C of BCM. 3 Check and repair. <ul style="list-style-type: none"> • Corrosion(install new adapting piece or terminal-cleaning module and pin). • Pin damaged or bent-install new terminal/pin. • Fly out of pins-install new pins as needed. 4 Reconnect the BCM plug and all other previously disconnected plug. Make sure the pin is properly positioned and fixed. 5 Run the system and determine if the problem persists?
	YES → Replace the BCM.
NO ↓	
At this point the system is functioning normally. The problem may be caused by module connections. Address the root cause of any connector or pin problems,	
Next Step ↓	
Diagnosis end.	

B1009-13、 B1009-12

Fault diagnosis code
B1009-13: Rear fog lamp output open
B1009-12: Rear fog lamp output short to Battery
Detection tools
1 Multimeter and diagnostic apparatus
Possible causes
<ul style="list-style-type: none"> • Lines, terminals or connectors • BCM • Rear fog lamp failure • Fuse failure
Conditions for fault code operation
Turn the ignition switch to ON position.
Conditions for fault code setting
B1009-13
B1009-12
To set the effect of a fault code condition
1
2
Description of circuit diagram

Circuit diagram

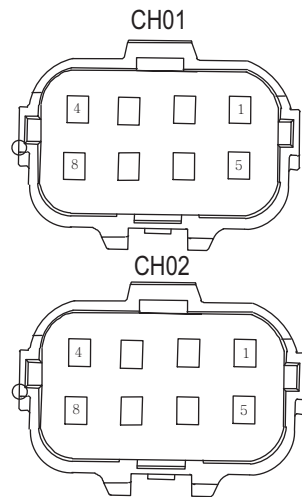
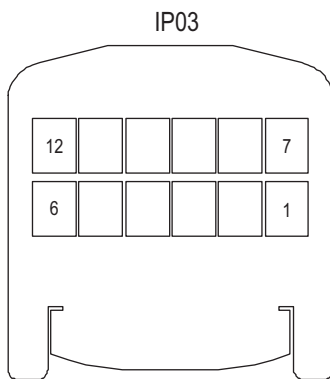
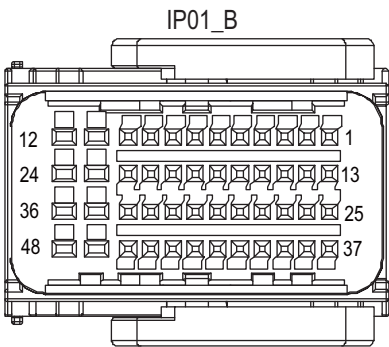
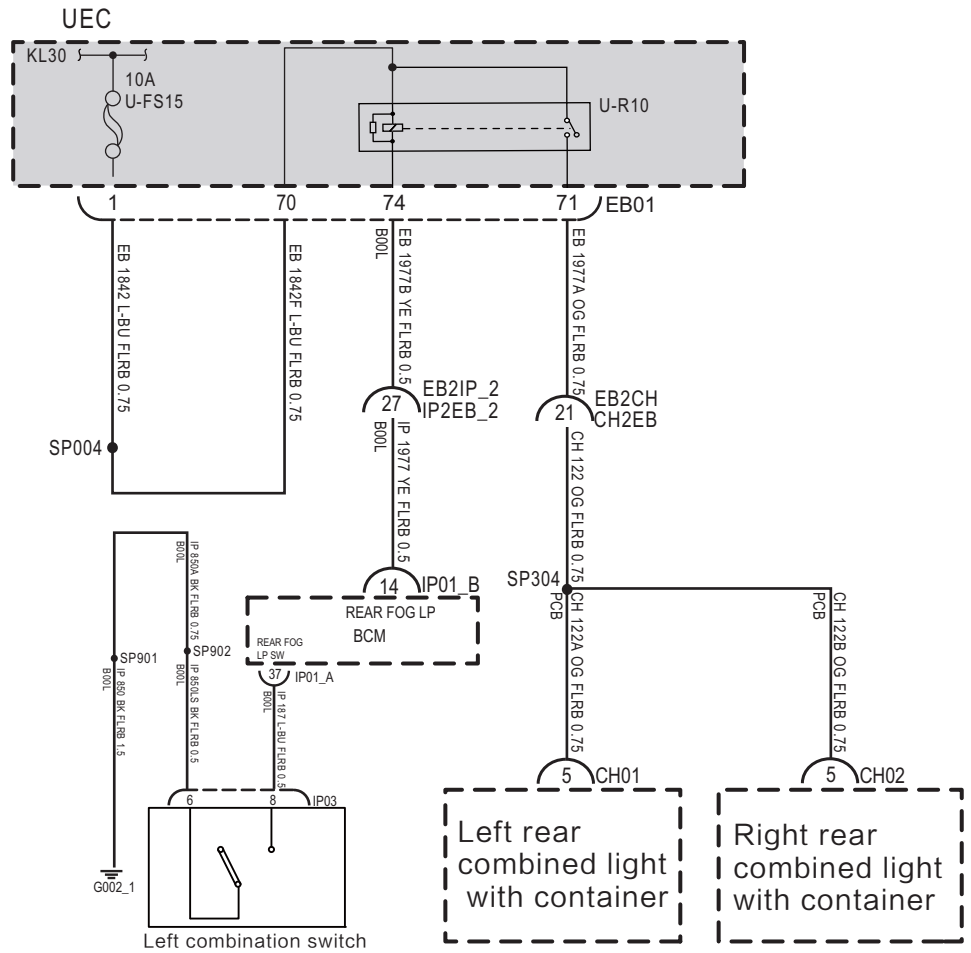

EK890031

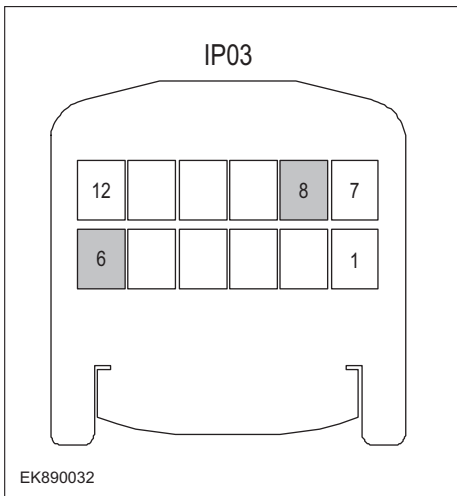
Troubleshooting steps	
Steps1	General inspection.
	<ol style="list-style-type: none"> 1 Check fuseU-FS15 for damage. 2 Check relayU-R10 是否损坏 3 Check battery capacity. 4 Check the harness plug of air conditioning control module for damage, poor contact, aging and looseness. 5 Check whether the result is normal or not?
	NO → Repair or replace the faulted parts.
YES ↓	
Steps2	Check fault codes.
	<ol style="list-style-type: none"> 1 Connect the fault diagnosis instrument to the diagnosis interface. 2 Turn the ignition switch to ON position. 3 Diagnosticing BCM using a diagnostics. 4 If there is any fault code except for B1009-13 、 B1009-12?
	YES → Refer to: DTC Summary list(BCM)
NO ↓	
Steps3	Check combination light switch (fog light switch) (component inspection).
	<ol style="list-style-type: none"> 1 Turn the ignition switch to OFF. 2 Set the combination light switch to the "rear fog light" position and measure the resistance between the combination light switch terminals (combination switch terminal). Measuring circuit: resistance between No.6 terminal of IP03 plug and No.8 terminal of IP03 plug. Standard value: ≈ 0Ω 3 Check whether the result is normal or not?
	NO → Please replace the combination light switch.
YES ↓	

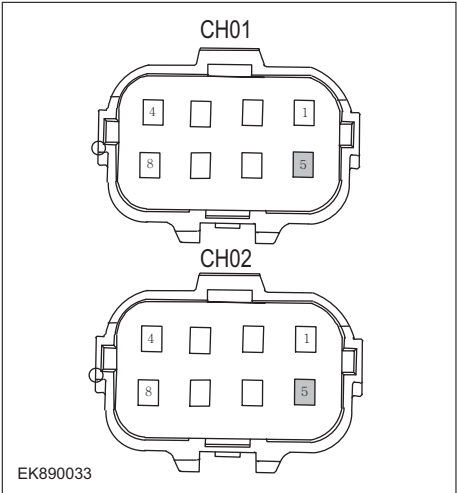
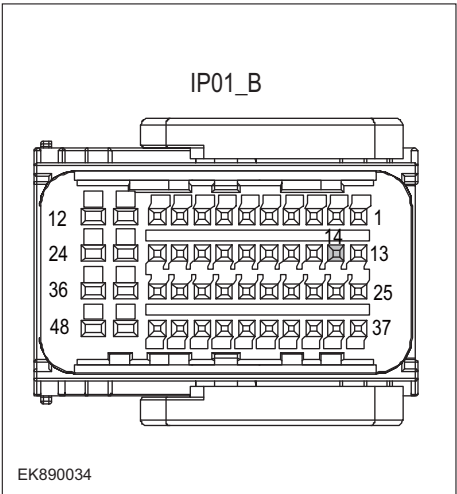
Steps4	Check the power supply of the rear fog lamp in the starting or running state.
	<ol style="list-style-type: none"> 1 Turn the ignition switch to OFF. 2 Disconnect the left rear fog lamp harness plug CH01. 3 Disconnect the right rear fog lamp harness plug CH02. 4 Turn the ignition switch to ON. 5 Measure the voltage between the rear fog lamp harness terminal and ground. Measuring circuit: voltage between terminal 5 of CH01 plug and ground. Measuring circuit: voltage between terminal 5 of CH02 plug and ground. Standard value:10~14V 6 Check whether the result is normal or not?
<p>NO → Repair or replace the faulted parts.</p>	
<p>YES ↓</p>	
Steps5	Check the circuit between UEC and BCM (open circuit).
	<ol style="list-style-type: none"> 1 Turn the ignition switch to OFF. 2 Disconnect BCM harness plug IP01 _ b. 3 Measure the resistance between the rear fog lamp harness terminal and BCM harness terminal. Measuring circuit: resistance between terminal 74 of EB01 plug and terminal 14 of IP01_B plug. Standard value: ≈ 0Ω 4 Check whether the result is normal or not?
<p>NO → Repair or replace the faulted parts.</p>	
<p>YES ↓</p>	

Steps6	Test whether BCM is norm.
	<ol style="list-style-type: none"> 1 Turn the ignition switch to OFF. 2 Disconnect and check the harness plug IP01_A、IP01_B、 IP01_C of BCM. 3 Check and repair. <ul style="list-style-type: none"> • Corrosion(install new adapting piece or terminal-cleaning module and pin). • Pin damaged or bent-install new terminal/pin. • Fly out of pins-install new pins as needed. 4 Reconnect the BCM plug and all other previously disconnected plug. Make sure the pin is properly positioned and fixed. 5 Run the system and determine if the problem persists?
	YES → Replace the BCM.
NO ↓	
At this point the system is functioning normally. The problem may be caused by module connections. Address the root cause of any connector or pin problems,	
Next Step ↓	
Diagnosis end.	

B100A-13、 B100A-12

Fault diagnosis code
B100A-13: Position lamp output open
B100A-12: Position lamp output short to Battery
Detection tools
1 Multimeter and diagnostic apparatus
Possible causes
<ul style="list-style-type: none"> • Lines, terminals or connectors • BCM • Position lamp fault • Fuse failure
Conditions for fault code operation
Turn the ignition switch to ON position.
Conditions for fault code setting
B100A-13
B100A-12
To set the effect of a fault code condition
1
2
Description of circuit diagram

Circuit diagram

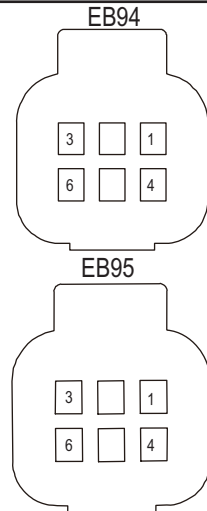
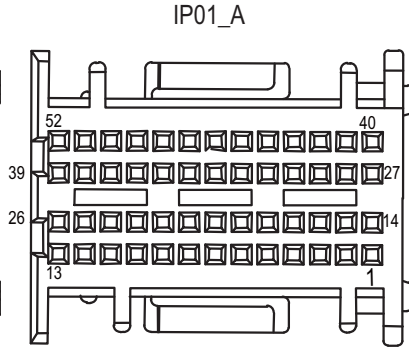
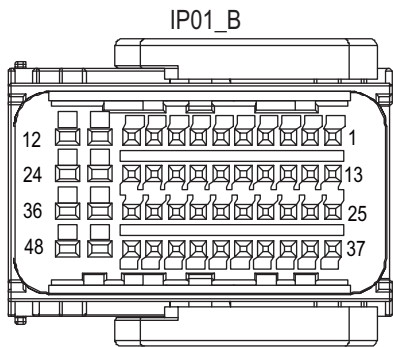
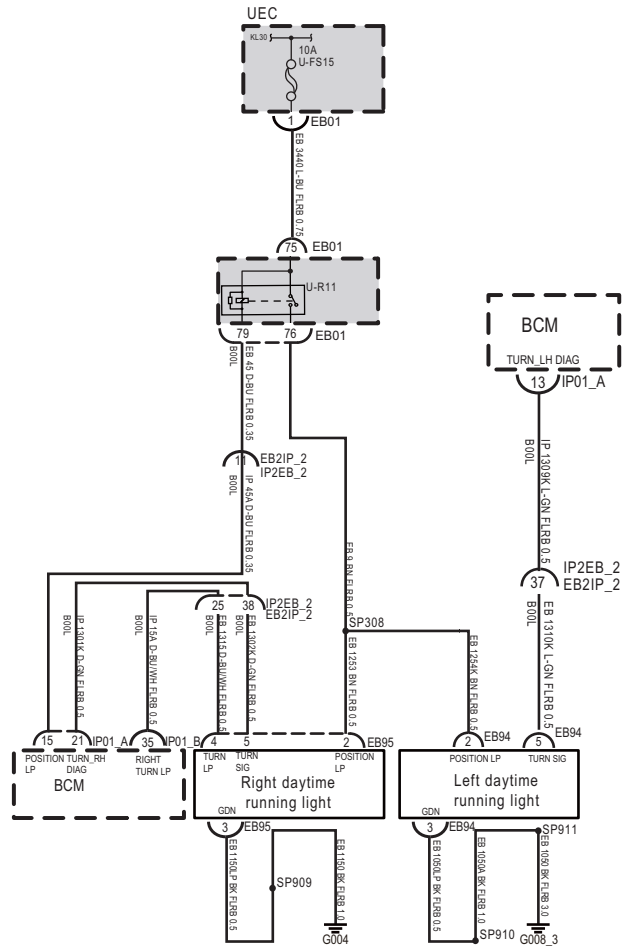

EK890035

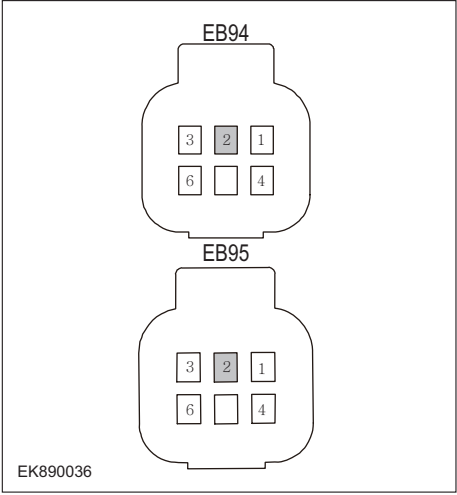
Troubleshooting steps	
Steps1	General inspection.
	<ol style="list-style-type: none"> 1 Check fuseU-FS15 for damage. 2 Check relayU-R11 for damage. 3 Check battery capacity. 4 Check the harness plug of air conditioning control module for damage, poor contact, aging and looseness. 5 Check whether the result is normal or not?
NO → Repair or replace the faulted parts.	
YES ↓	
Steps2	Check fault codes.
	<ol style="list-style-type: none"> 1 Connect the fault diagnosis instrument to the diagnosis interface. 2 Turn the ignition switch to ON position. 3 Diagnosticsing BCM using a diagnostics. 4 If there is any fault code except for B100A-13、 B100A-12?
YES → Refer to: DTC Summary list(BCM)	
NO ↓	
Steps4	Check the position lamp power supply in the starting or running state.
	<ol style="list-style-type: none"> 1 Turn the ignition switch to OFF. 2 Disconnect the left front position lamp harness plug EB94. 3 Disconnect the right front position lamp harness plug EB95. 4 Turn the ignition switch to ON. 5 Measure the voltage between position lamp harness terminal and ground. Measuring circuit: voltage between terminal 2 of EB94 plug and ground. Measuring circuit: voltage between terminal 2 of EB95 plug and ground. Standard value:10~14V 6 Check whether the result is normal or not?
NO → Repair or replace the faulted parts.	
YES ↓	

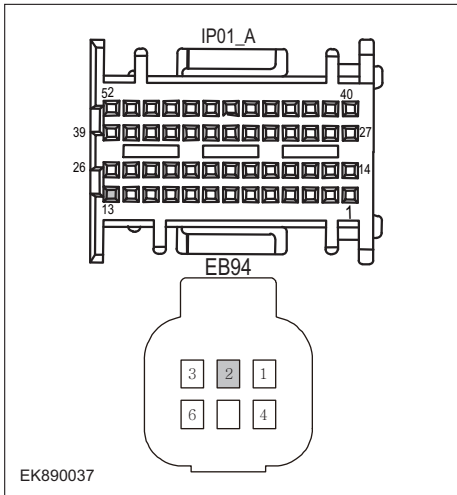
Steps5	Check the circuit between left position lamp and BCM (open circuit).
 <p>EK890037</p>	<ol style="list-style-type: none"> 1 Turn the ignition switch to OFF. 2 Disconnect the plug IP01_A of BCM harness. 3 Measure the resistance between left position lamp harness terminal and BCM harness terminal. Measuring circuit: resistance between terminal 2 of EB94 plug and terminal 13 of IP01_A plug. Standard value: $\approx 0\Omega$ 4 Check whether the result is normal or not?

NO → Repair or replace the faulted parts.

YES ↓

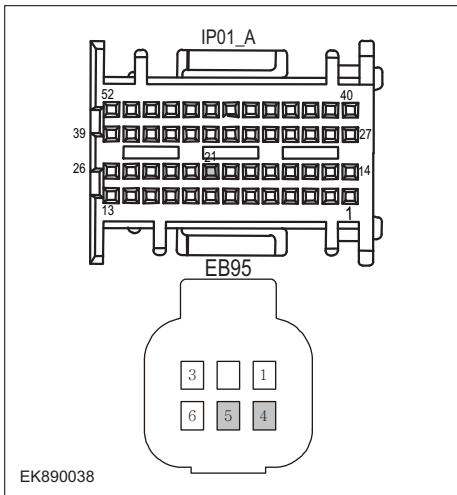
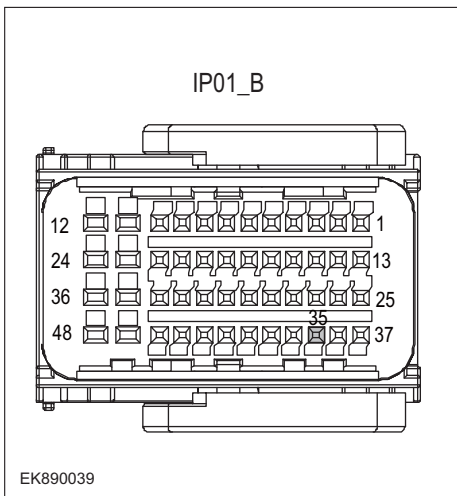
Steps6	Check the circuit between right position lamp and BCM (open circuit).
 <p>EK890038</p>  <p>EK890039</p>	<ol style="list-style-type: none"> 1 Turn the ignition switch to OFF. 2 Disconnect the BCM harness plugs IP01_A and IP01_b. 3 Measure the resistance between the right position lamp harness terminal and the BCM harness terminal. Measuring circuit: resistance between terminal 5 of EB95 plug and terminal 21 of IP01_A plug. Measuring circuit: resistance between terminal 4 of EB95 plug and terminal 35 of IP01_B plug. Standard value: $\approx 0\Omega$ 4 Check whether the result is normal or not?

NO → Repair or replace the faulted parts.

YES ↓

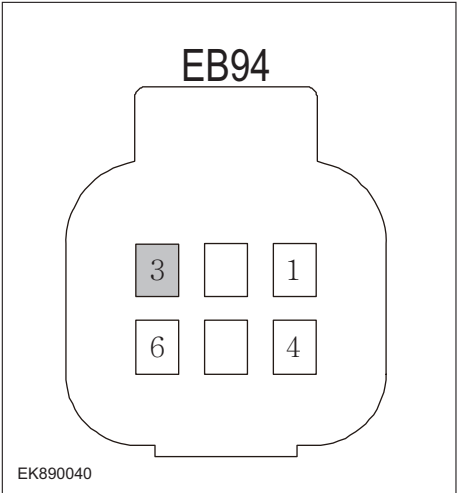
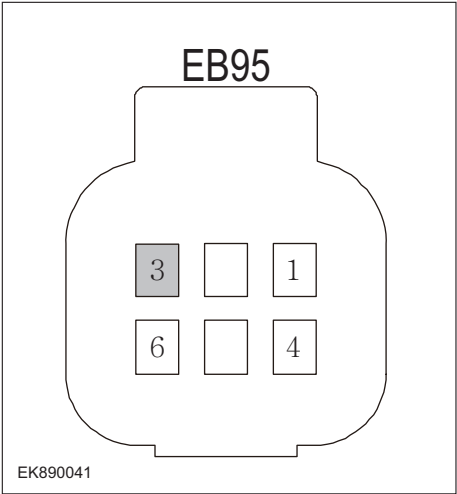
Steps9	Check the circuit between left position lamp and BCM (open circuit).
 <p>EB94</p> <p>EK890040</p>	<ol style="list-style-type: none"> 1 Turn the ignition switch to OFF. 2 Measure the resistance between left position lamp harness plug and ground. Measuring circuit: resistance between terminal 3 of EP94 plug and ground. Standard value:< 1Ω 3 Test whether the resistance is less than 1Ω?
<p>NO → Repair or replace the faulted parts.</p>	
<p>YES ↓</p>	
Steps9	Check the circuit between right position lamp and BCM (open circuit).
 <p>EB95</p> <p>EK890041</p>	<ol style="list-style-type: none"> 1 Turn the ignition switch to OFF. 2 Measure the resistance between plug of right position lamp harness and ground. Measuring circuit: resistance between terminal 3 of EP95 plug and ground. Standard value:< 1Ω 3 Test whether the resistance is less than 1Ω?
<p>NO → Repair or replace the faulted parts.</p>	
<p>YES ↓</p>	

Steps14	Test whether BCM is norm.
	<ol style="list-style-type: none"> 1 Turn the ignition switch to OFF. 2 Disconnect and check the harness plug IP01_A、IP01_B、 IP01_C of BCM. 3 Check and repair. <ul style="list-style-type: none"> • Corrosion(install new adapting piece or terminal-cleaning module and pin). • Pin damaged or bent-install new terminal/pin. • Fly out of pins-install new pins as needed. 4 Reconnect the BCM plug and all other previously disconnected plug. Make sure the pin is properly positioned and fixed. 5 Run the system and determine if the problem persists?
	YES → Replace the BCM.
NO ↓	
At this point the system is functioning normally. The problem may be caused by module connections. Address the root cause of any connector or pin problems,	
Next Step ↓	
Diagnosis end.	

B100C-12

Fault diagnosis code
B100C-12: Dipped beam relay output short to battery
Detection tools
1 Multimeter and diagnostic apparatus
Possible causes
<ul style="list-style-type: none">• Lines, terminals or connectors• BCM• Position lamp fault• Fuse failure
Conditions for fault code operation
Turn the ignition switch to ON position.
Conditions for fault code setting
B100C-12
To set the effect of a fault code condition
1
2
Description of circuit diagram

Circuit diagram

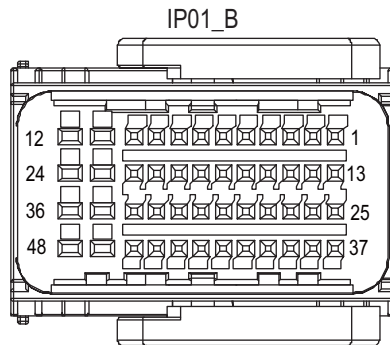
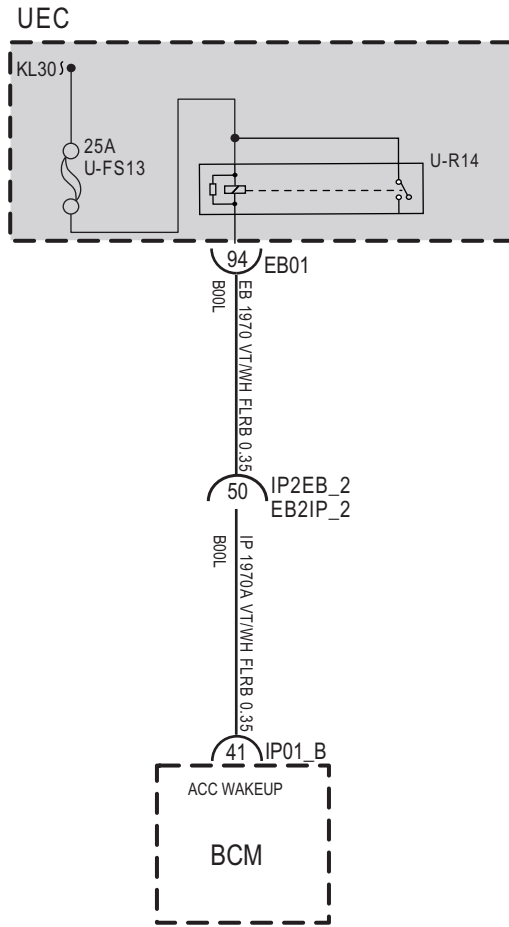

EK890042

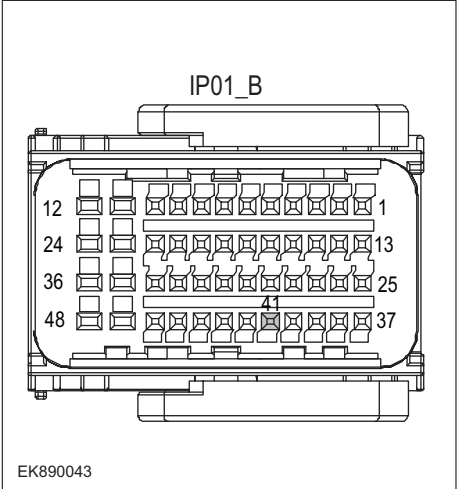
Troubleshooting steps	
Steps1	General inspection.
	<ol style="list-style-type: none"> 1 Check fuseU-FS13 for damage. 2 Check relayU-R14 for damage. 3 Check battery capacity. 4 Check the harness plug of air conditioning control module for damage, poor contact, aging and looseness. 5 Check whether the result is normal or not?
<p>NO → Repair or replace the faulted parts.</p>	
<p>YES ↓</p>	
Steps2	Check fault codes.
	<ol style="list-style-type: none"> 1 Connect the fault diagnosis instrument to the diagnosis interface. 2 Turn the ignition switch to ON position. 3 Diagnosticsing BCM using a diagnostics. 4 If there is any fault code except for B100C-12?
<p>YES → Refer to: DTC Summary list(BCM)</p>	
<p>NO ↓</p>	
Steps3	Check whether the BCM power supply circuit is normal.
	<ol style="list-style-type: none"> 1 Turn the ignition switch to OFF. 2 Disconnect BCM harness plug IP01 _ b. 3 Turn the ignition switch to ON. 4 Measure the voltage between position lamp harness terminal and ground. Measuring circuit: voltage between terminal 41 of IP01_B plug and ground. Standard value:10~14V 5 Check whether the result is normal or not?
<p>NO → Repair or replace the faulted parts.</p>	
<p>YES ↓</p>	

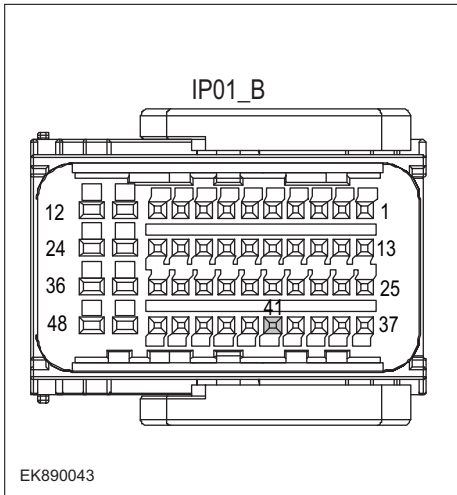
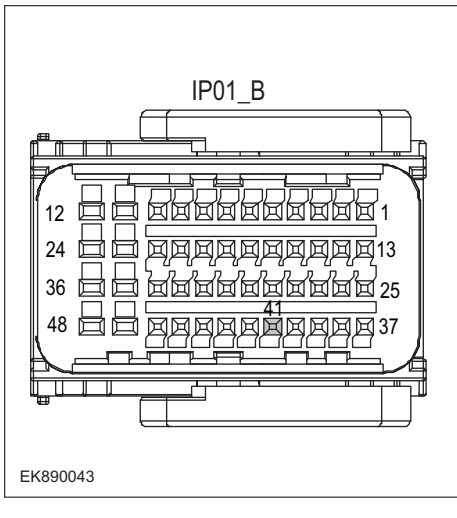
Steps4	Check the circuit between UEC and BCM (open circuit).
 <p>EK890043</p>	<ol style="list-style-type: none"> 1 Turn the ignition switch to OFF. 2 Disconnect plug EB01 of UEC harness. 3 Disconnect BCM harness plug IP01 _ b. 4 Measure the resistance between UEC terminal and BCM harness terminal. <p>Measuring circuit: resistance between terminal 94 of EB01 plug and terminal 41 of IP01_B plug.</p> <p>Standard value: $\approx 0\Omega$</p> <ol style="list-style-type: none"> 5 Check whether the result is normal or not?
<p>NO → Repair or replace the faulted parts.</p>	
<p>YES ↓</p>	
Steps5	Check UEC and BCM circuits (short circuit).
 <p>EK890043</p>	<ol style="list-style-type: none"> 1 Turn the ignition switch to OFF. 2 Measure the resistance between BCM harness plug and ground. <p>Measuring circuit: resistance between terminal 41 of IP01_B plug and ground.</p> <p>Standard value: $< 1\Omega$</p> <ol style="list-style-type: none"> 3 Test whether the resistance is less than 1Ω?
<p>NO → Repair or replace the faulted parts.</p>	
<p>YES ↓</p>	

BCM

Steps6	Test whether BCM is norm.
	<ol style="list-style-type: none"> 1 Turn the ignition switch to OFF. 2 Disconnect and check the harness plug IP01_A、IP01_B、IP01_C of BCM. 3 Check and repair. <ul style="list-style-type: none"> • Corrosion(install new adapting piece or terminal-cleaning module and pin). • Pin damaged or bent-install new terminal/pin. • Fly out of pins-install new pins as needed. 4 Reconnect the BCM plug and all other previously disconnected plug. Make sure the pin is properly positioned and fixed. 5 Run the system and determine if the problem persists?
	YES → Replace the BCM.
NO ↓	
At this point the system is functioning normally. The problem may be caused by module connections. Address the root cause of any connector or pin problems,	
Next Step ↓	
Diagnosis end.	

B100D-12

Fault diagnosis code
B100D-12: Main beam relay output short to battery
Detection tools
1 Multimeter and diagnostic apparatus
Possible causes
<ul style="list-style-type: none">• Lines, terminals or connectors• BCM• Position lamp fault• Fuse failure
Conditions for fault code operation
Turn the ignition switch to ON position.
Conditions for fault code setting
B100D-12
To set the effect of a fault code condition
1
2
Description of circuit diagram

Circuit diagram

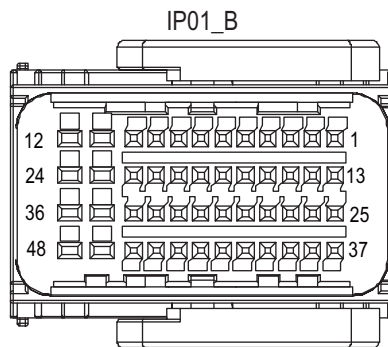
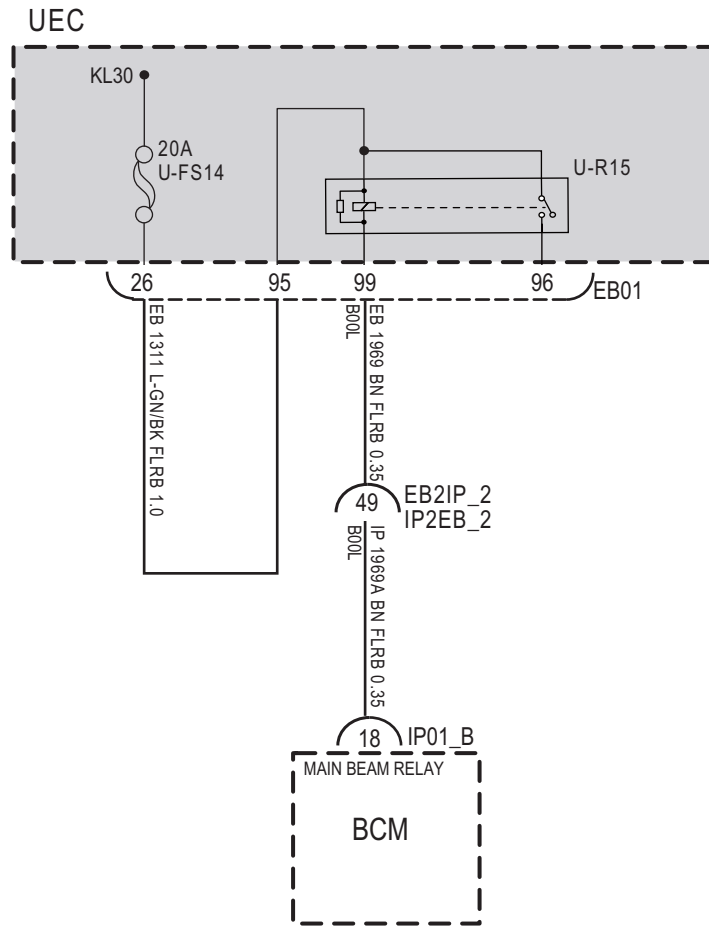

EK890044

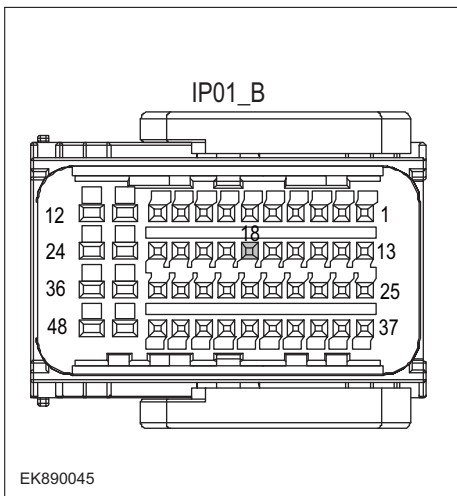
Troubleshooting steps	
Steps1	General inspection.
	<ol style="list-style-type: none"> 1 Check fuseU-FS14 for damage. 2 Check relayU-R15 for damage. 3 Check battery capacity. 4 Check the harness plug of air conditioning control module for damage, poor contact, aging and looseness. 5 Check whether the result is normal or not?
	NO → Repair or replace the faulted parts.
YES ↓	
Steps2	Check fault codes.
	<ol style="list-style-type: none"> 1 Connect the fault diagnosis instrument to the diagnosis interface. 2 Turn the ignition switch to ON position. 3 Diagnosticing BCM using a diagnostics. 4 If there is any fault code except for B100D-12?
	YES → Refer to: DTC Summary list(BCM)
NO ↓	
Steps3	Check whether the BCM power supply circuit is normal.
	<ol style="list-style-type: none"> 1 Turn the ignition switch to OFF. 2 Disconnect BCM harness plug IP01 _ b. 3 Turn the ignition switch to ON. 4 Measure the voltage between position lamp harness terminal and ground. Measuring circuit: the voltage between the 18th terminal of IP01_B plug and the ground. Standard value:10~14V 5 Check whether the result is normal or not?
	NO → Repair or replace the faulted parts.
YES ↓	

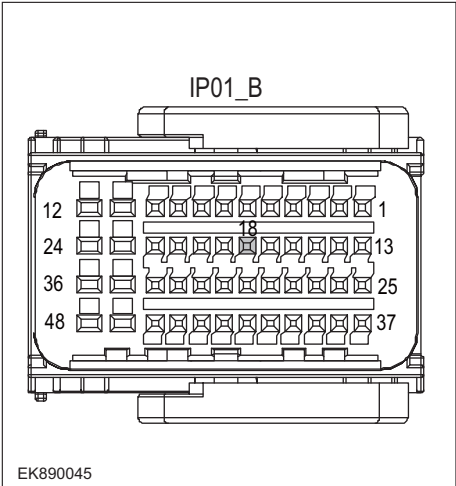
Steps4	Check the circuit between UEC and BCM (open circuit).
 <p>EK890045</p>	<ol style="list-style-type: none"> 1 Turn the ignition switch to OFF. 2 Disconnect plug EB01 of UEC harness. 3 Disconnect BCM harness plug IP01 _ b. 4 Measure the resistance between UEC terminal and BCM harness terminal. <p>Measuring circuit: resistance between terminal 99 of EB01 plug and terminal 18 of IP01_B plug.</p> <p>Standard value: $\approx 0\Omega$</p> <ol style="list-style-type: none"> 5 Check whether the result is normal or not?

NO → Repair or replace the faulted parts.

YES ↓

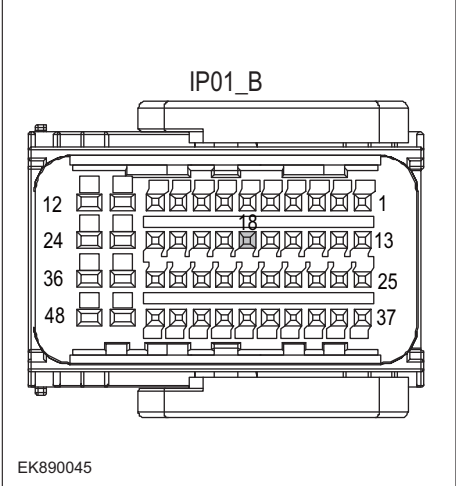
Steps5	Check UEC and BCM circuits (short circuit).
 <p>EK890045</p>	<ol style="list-style-type: none"> 1 Turn the ignition switch to OFF. 2 Measure the resistance between BCM harness plug and ground. <p>Measuring circuit: resistance between terminal 18 of IP01_B plug and ground.</p> <p>Standard value: $< 1\Omega$</p> <ol style="list-style-type: none"> 3 Test whether the resistance is less than 1Ω?

NO → Repair or replace the faulted parts.

YES ↓

Steps6	Test whether BCM is norm.
	<ol style="list-style-type: none"> 1 Turn the ignition switch to OFF. 2 Disconnect and check the harness plug IP01_A、IP01_B、 IP01_C of BCM. 3 Check and repair. <ul style="list-style-type: none"> • Corrosion(install new adapting piece or terminal-cleaning module and pin). • Pin damaged or bent-install new terminal/pin. • Fly out of pins-install new pins as needed. 4 Reconnect the BCM plug and all other previously disconnected plug. Make sure the pin is properly positioned and fixed. 5 Run the system and determine if the problem persists?
	YES → Replace the BCM.
NO ↓	
At this point the system is functioning normally. The problem may be caused by module connections. Address the root cause of any connector or pin problems,	
Next Step ↓	
Diagnosis end.	

B100E-12

Fault diagnosis code
B100E-12: Front fog relay output short to battery
Detection tools
1 Multimeter and diagnostic apparatus
Possible causes
<ul style="list-style-type: none"> • Lines, terminals or connectors • BCM • Rear fog lamp failure • Fuse failure
Conditions for fault code operation
Turn the ignition switch to ON position.
Conditions for fault code setting
B100E-12
To set the effect of a fault code condition
1
2
Description of circuit diagram

Circuit diagram

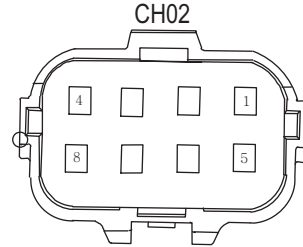
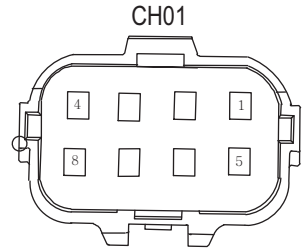
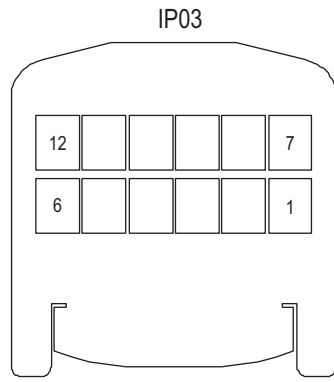
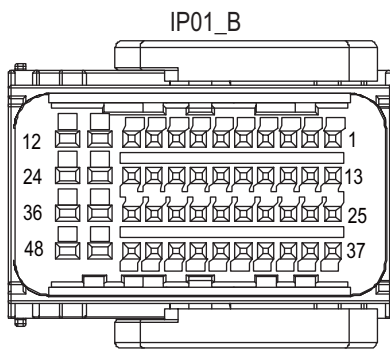
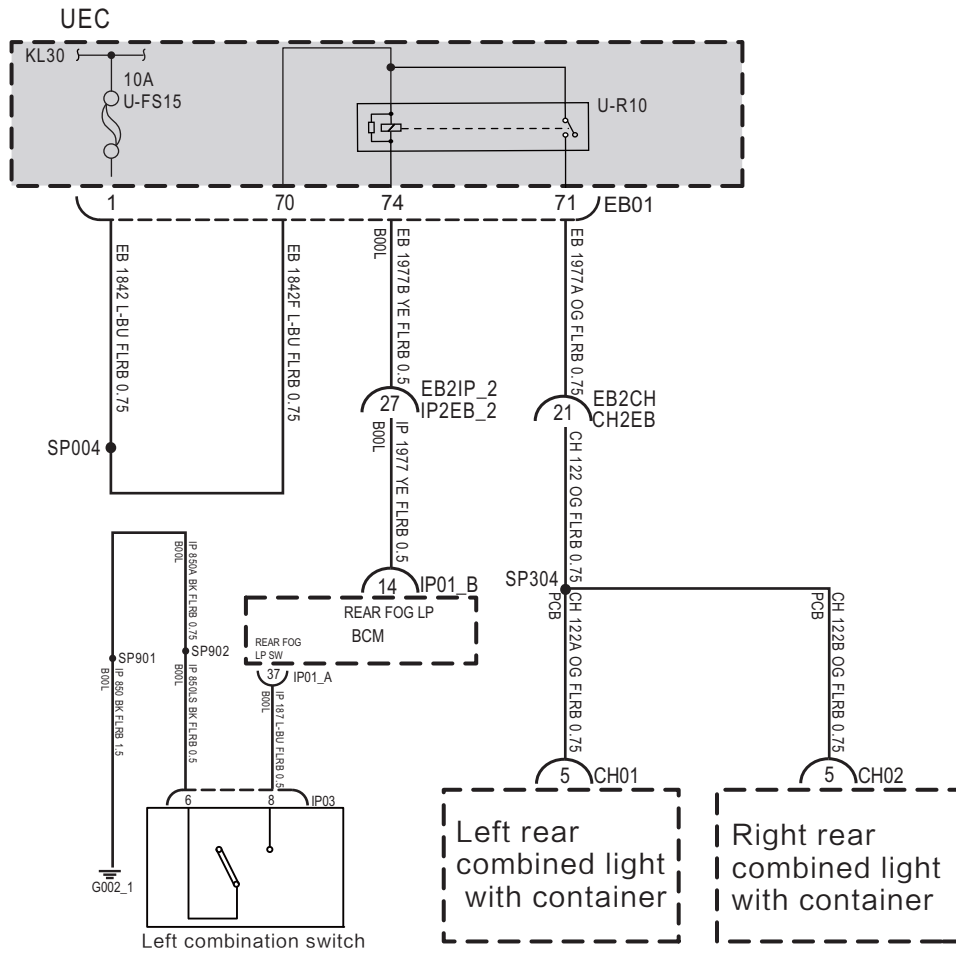

EK890031

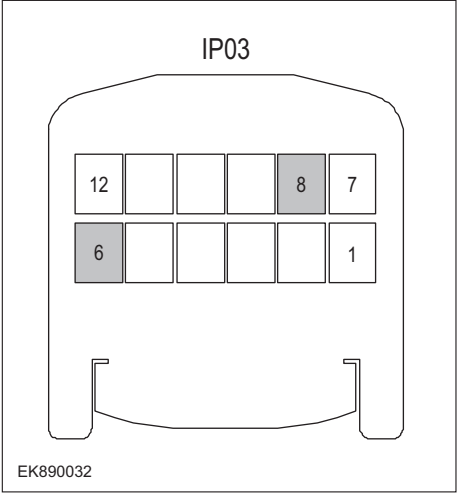
Troubleshooting steps	
Steps1	General inspection.
	<ol style="list-style-type: none"> 1 Check fuseU-FS15 for damage. 2 Check relayU-R10 是否损坏 3 Check battery capacity. 4 Check the harness plug of air conditioning control module for damage, poor contact, aging and looseness. 5 Check whether the result is normal or not?
<p>NO → Repair or replace the faulted parts.</p>	
<p>YES ↓</p>	
Steps2	Check fault codes.
	<ol style="list-style-type: none"> 1 Connect the fault diagnosis instrument to the diagnosis interface. 2 Turn the ignition switch to ON position. 3 Diagnosticsing BCM using a diagnostics. 4 If there is any fault code except for B100E-12?
<p>YES → Refer to: DTC Summary list(BCM)</p>	
<p>NO ↓</p>	
Steps3	Check combination light switch (fog light switch) (component inspection).
	<ol style="list-style-type: none"> 1 Turn the ignition switch to OFF. 2 Set the combination light switch to the "fog light" position, and measure the resistance between the combination light switch terminals (combination switch terminal). Measuring circuit: resistance between No.6 terminal of IP03 plug and No.8 terminal of IP03 plug. Standard value: ≈ 0Ω 3 Check whether the result is normal or not?
<p>NO → Please replace the combination light switch.</p>	
<p>YES ↓</p>	

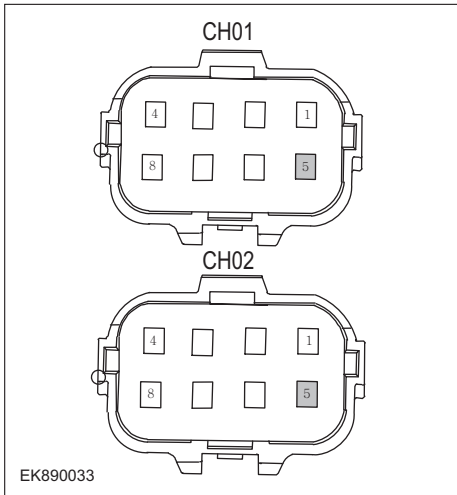
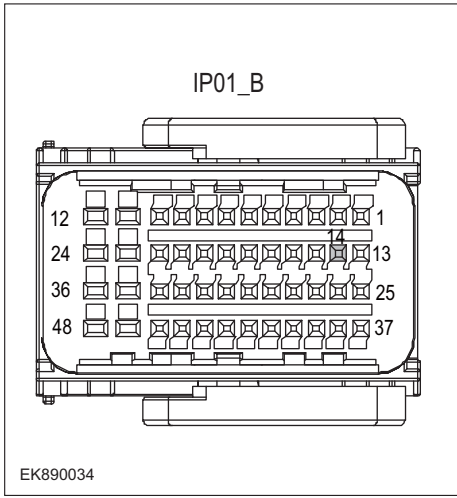
Steps4	Check the power supply of the rear fog lamp in the starting or running state.
	<ol style="list-style-type: none"> 1 Turn the ignition switch to OFF. 2 Disconnect the left rear fog lamp harness plug CH01. 3 Disconnect the right rear fog lamp harness plug CH02. 4 Turn the ignition switch to ON. 5 Measure the voltage between the rear fog lamp harness terminal and ground. Measuring circuit: voltage between terminal 5 of CH01 plug and ground. Measuring circuit: voltage between terminal 5 of CH02 plug and ground. Standard value:10~14V 6 Check whether the result is normal or not?
<p>NO → Repair or replace the faulted parts.</p>	
<p>YES ↓</p>	
Steps5	Check the circuit between UEC and BCM (open circuit).
	<ol style="list-style-type: none"> 1 Turn the ignition switch to OFF. 2 Disconnect BCM harness plug IP01 _ b. 3 Measure the resistance between the rear fog lamp harness terminal and BCM harness terminal. Measuring circuit: resistance between terminal 74 of EB01 plug and terminal 14 of IP01_B plug. Standard value: ≈ 0Ω 4 Check whether the result is normal or not?
<p>NO → Repair or replace the faulted parts.</p>	
<p>YES ↓</p>	

BCM

Steps6	Test whether BCM is norm.
	<ol style="list-style-type: none"> 1 Turn the ignition switch to OFF. 2 Disconnect and check the harness plug IP01_A、IP01_B、 IP01_C of BCM. 3 Check and repair. <ul style="list-style-type: none"> • Corrosion(install new adapting piece or terminal-cleaning module and pin). • Pin damaged or bent-install new terminal/pin. • Fly out of pins-install new pins as needed. 4 Reconnect the BCM plug and all other previously disconnected plug. Make sure the pin is properly positioned and fixed. 5 Run the system and determine if the problem persists?
	YES → Replace the BCM.
NO ↓	
At this point the system is functioning normally. The problem may be caused by module connections. Address the root cause of any connector or pin problems,	
Next Step ↓	
Diagnosis end.	

B1010-12

Fault diagnosis code
B1010-12: Horn relay output short to battery
Detection tools
1 Multimeter and diagnostic apparatus
Possible causes
<ul style="list-style-type: none">• Lines, terminals or connectors• BCM• Relay failure• Fuse failure
Conditions for fault code operation
Turn the ignition switch to ON position.
Conditions for fault code setting
B1010-12
To set the effect of a fault code condition
1
2
Description of circuit diagram

Circuit diagram

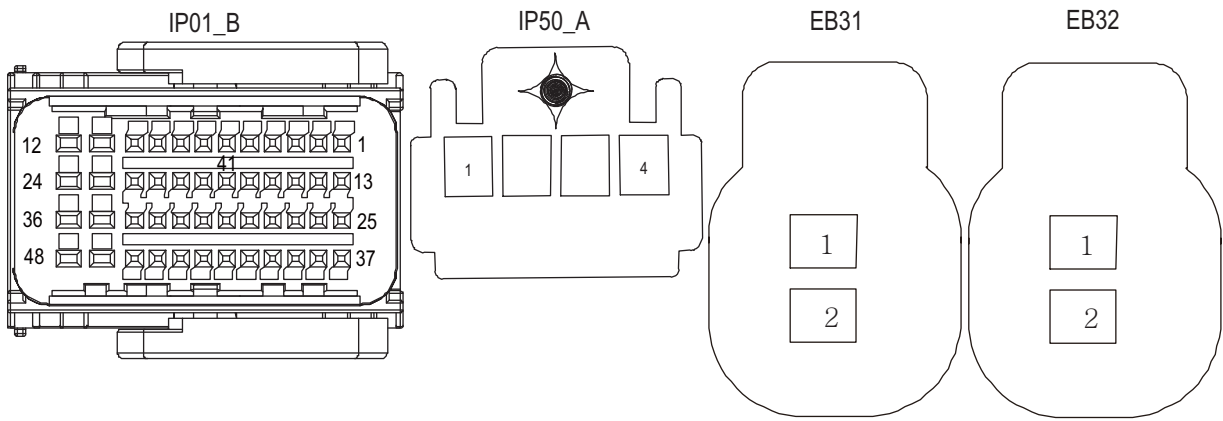
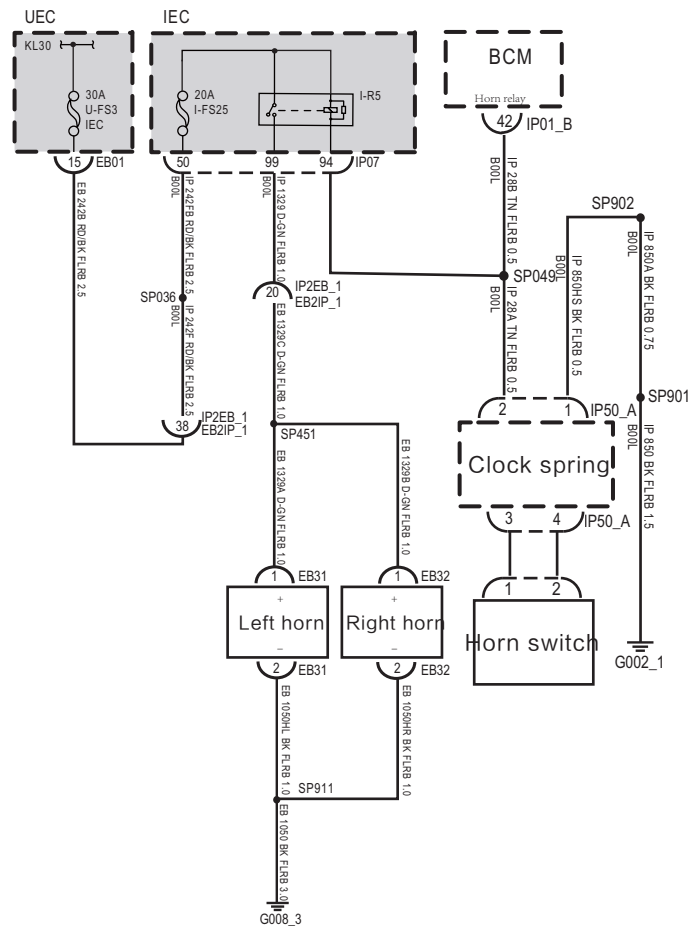

EK890046

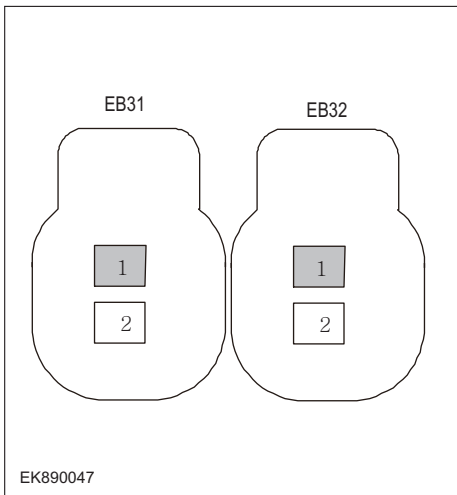
Troubleshooting steps	
Steps1	General inspection.
	<ol style="list-style-type: none"> 1 Check fuseU-FS3、 I-FS25 for damage. 2 Check relayI-R5 for damage. 3 Check battery capacity. 1 Check the horn and BCM harness plug for damage, poor contact, aging and looseness. 2 Check whether the result is normal or not?
	NO → Repair or replace the faulted parts.
YES ↓	
Steps2	Check fault codes.
	<ol style="list-style-type: none"> 1 Connect the fault diagnosis instrument to the diagnosis interface. 2 Turn the ignition switch to ON position. 3 Diagnose BCM with diagnostic instrument. 4 If there is any fault code except for B1010-12?
	YES → Refer to: DTC Summary list(BCM)
NO ↓	
Steps3	Horn power supply in starting or running state.
	<ol style="list-style-type: none"> 1 Turn the ignition switch to OFF. 2 Disconnect the left front horn harness plug EB31. 3 Disconnect the plug EB32 of the right front horn harness. 4 Turn the ignition switch to ON. 5 Press the horn switch. 6 Measure the voltage between the horn harness terminal and ground. Measuring circuit: voltage between terminal 1 of EB31 plug and ground. Measuring circuit: voltage between No.1 terminal of EB32 plug and ground. Standard value:10~14V 7 Check whether the result is normal or not?
	NO → Repair or replace the faulted parts.
YES ↓	

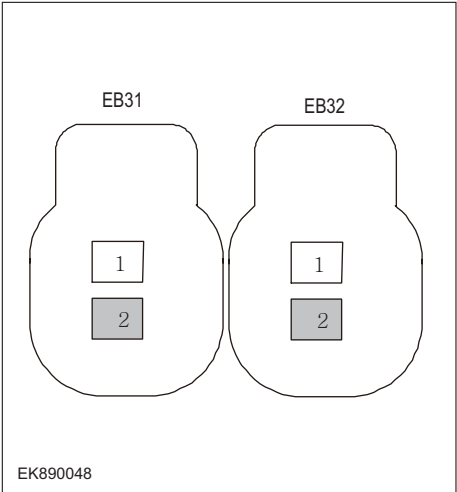
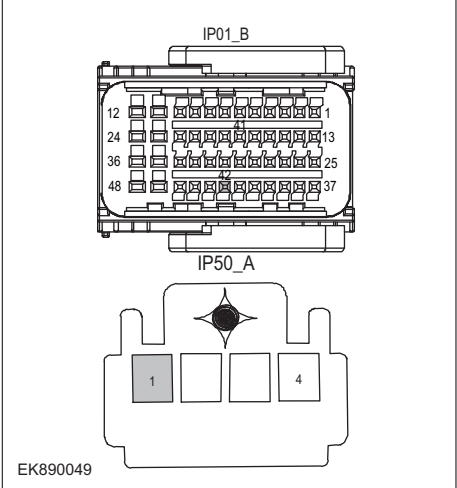
Steps4	Check the horn ground circuit for an open circuit.
	<ol style="list-style-type: none"> 1 Turn the ignition switch to OFF. 2 Measure the resistance between horn harness plug and ground. Measuring circuit: resistance between terminal 2 of EB31 plug and ground. Measuring circuit: resistance between terminal 2 of EB32 plug and ground. Standard value:< 1Ω 3 Test whether the resistance is less than 1Ω?
NO → Repair or replace the faulted parts.	
YES ↓	
Steps5	Check horn control circuit (short circuit).
	<ol style="list-style-type: none"> 1 Disconnect BCM harness plug IP01 _ b. 2 Disconnect the clock spring harness plug IP50 _ A. 3 Measure the resistance between BCM harness plug and ground. Measuring circuit: resistance between terminal 42 of IP01_B plug and ground. Standard value:infinite 4 Measure the voltage between BCM harness plug and ground. Measuring circuit: voltage between terminal 42 of IP01_B plug and ground. Standard value: ≈ 0V 5 Measure the resistance between clock spring harness plug and ground. Measuring circuit: resistance between terminal 1 of IP50_A plug and ground. Standard value:infinite 6 Measure the voltage between clock spring harness plug and ground. Measuring circuit: voltage between terminal 1 of IP50_A plug and ground. Standard value: ≈ 0V 7 Check whether the result is normal or not?
NO → Repair or replace the faulted parts.	
YES ↓	

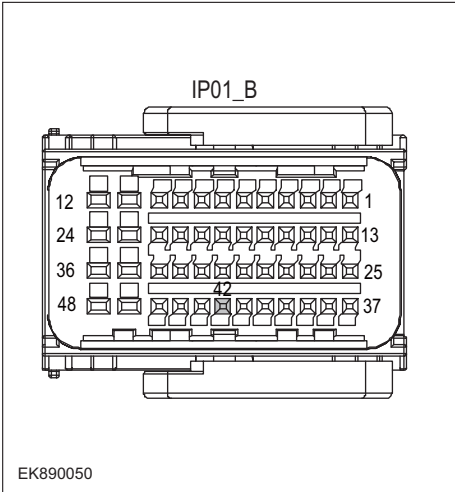
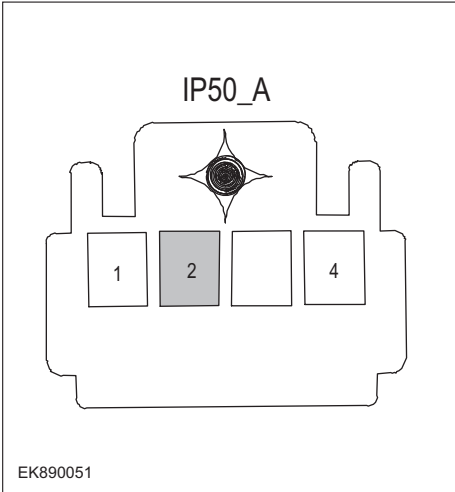
Steps6	Check horn control circuit (open circuit).
<div style="text-align: center;">  <p>EK890050</p> </div> <div style="text-align: center; margin-top: 20px;">  <p>EK890051</p> </div>	<ol style="list-style-type: none"> 1 Turn the ignition switch to OFF. 2 Disconnect the harness plug IP07 of IEC auxiliary fuse box. 3 Measure the resistance between IEC auxiliary fuse box harness terminal and BCM harness terminal. Measuring circuit: resistance between terminal 94 of IP07 plug and terminal 42 of IP09_B plug. Standard value: $\approx 0\Omega$ 4 Measure the resistance between IEC auxiliary fuse box harness terminal and clock spring module harness terminal. Measuring circuit: resistance between terminal 94 of IP07 plug and terminal 2 of IP50_A plug. Standard value: $\approx 0\Omega$ 5 Check whether the result is normal or not?
<p>NO → Repair or replace the faulted parts.</p>	
<p>YES ↓</p>	

Steps7	Replace the horn relay in good condition.	
	<ol style="list-style-type: none"> 1 Replace the horn relay in good condition. 2 Reconnect all disconnected harness terminals. 3 Connect the fault diagnosis instrument to the diagnosis interface. 4 Turn the ignition switch to ON position. 5 Read the BCM Diagnostic Trouble Code (DTC) with a scan tool. 6 Clear the BCM diagnostic trouble code (DTC). 7 Turn the ignition switch to OFF. 8 Wait at least 15 seconds to allow the module to shut down correctly. 9 Turn the ignition switch to ON again. 10 Read the DTC again. 11 Does the fault code still exist? 	
		NO → Replace the relay.
YES ↓		
Steps8	Check whether BCM is abnormal.	
	<ol style="list-style-type: none"> 1 Turn the ignition switch to OFF. 2 Disconnect and check the connectors IP01_A, IP01_B and IP01_C of BCM harness. 3 Check and repair. <ul style="list-style-type: none"> • Corrosion(install new adapting piece or terminal-cleaning module and pin). • Pin damaged or bent-install new terminal/pin. • Fly out of pins-install new pins as needed. 4 Reconnect the BCM plug and all other previously disconnected plugs. Make sure that the pins are properly positioned and fixed. 5 Run the system and determine if the problem persists? 	
		YES → Replace BCM.
NO ↓		
At this point the system is functioning normally. The problem may be caused by module connections. Address the root cause of any connector or pin problems,		
Next Step ↓		
Diagnosis end.		

B1011-12

Fault diagnosis code
B1011-12: Mirror and HRW relay output short to battery
Detection tools
1 Multimeter and diagnostic apparatus
Possible causes
<ul style="list-style-type: none">• Lines, terminals or connectors• BCM• Exterior rearview mirror failure• Fuse failure
Conditions for fault code operation
Turn the ignition switch to ON position.
Conditions for fault code setting
B1011-12
To set the effect of a fault code condition
1
2
Description of circuit diagram

Circuit diagram

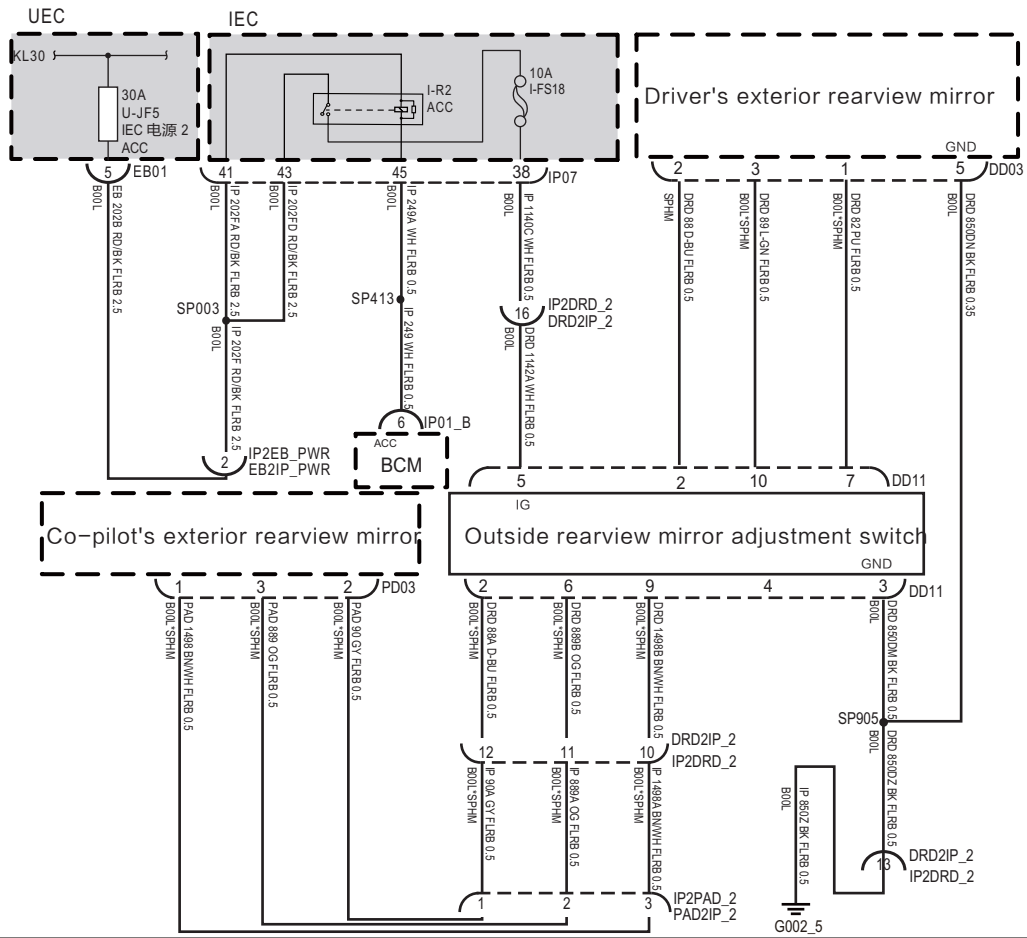

EK890052

Troubleshooting steps	
Steps1	General inspection.
	<ol style="list-style-type: none"> 1 Check fuseU-FS2、 I-FS18 for damage. 2 Check battery capacity. 1 Check the exterior rearview mirror, dimmer switch and BCM harness plug for damage, poor contact, aging and looseness. 2 Check whether the result is normal or not?
	NO → Repair or replace the faulted parts.
YES ↓	
Steps2	Check fault codes.
	<ol style="list-style-type: none"> 1 Connect the fault diagnosis instrument to the diagnosis interface. 2 Turn the ignition switch to ON position. 3 Diagnose BCM with diagnostic instrument. 4 If there is any fault code except for B1011-12?
	YES → Refer to: DTC Summary list(BCM)
NO ↓	
Steps3	Check the power supply of the exterior rearview mirror and the dimmer switch in the starting or running state.
	<ol style="list-style-type: none"> 1 Turn the ignition switch to OFF. 2 Disconnect the wiring harness plug DD11 of the exterior rearview mirror and dimmer switch. 3 Turn the ignition switch to ON. 4 Measure the voltage between the harness terminals of the exterior rearview mirror and the dimmer switch and ground. Measuring circuit: The voltage between terminal 5 of plug DD11 and the grounding. Standard value:10~14V 5 Check whether the result is normal or not?
	NO → Repair or replace the faulted parts.
YES ↓	

Steps4	Check the ground circuit of the exterior rearview mirror and dimmer switch for an open.	
	<ol style="list-style-type: none"> 1 Turn the ignition switch to OFF. 2 Measure the resistance between the outside rearview mirror and dimmer switch harness plug and ground. Measuring circuit: resistance between terminal 3 of DD11 plug and ground. Standard value:< 1Ω 3 Test whether the resistance is less than 1Ω? 	
		NO → Repair or replace the faulted parts.
YES ↓		
Steps5	Check driver's exterior mirror circuit (open circuit).	
	<ol style="list-style-type: none"> 1 Turn the ignition switch to OFF. 2 Disconnect the driver's side exterior mirror harness plug DD03. 3 Measure the resistance between the driver's side exterior mirror harness terminal and the exterior mirror and dimmer switch harness terminal. Measuring circuit: resistance between terminal 1 of DD03 plug and terminal 7 of DD11 plug. Measuring circuit: resistance between terminal 3 of DD03 plug and terminal 10 of DD11 plug. Measuring circuit: resistance between terminal 2 of DD03 plug and terminal 2 of DD11 plug. Standard value: ≈ 0Ω 4 Check whether the result is normal or not? 	
		NO → Repair or replace the faulted parts.
YES ↓		

Steps6	Check front passenger's exterior mirror circuit (open circuit).
	<ol style="list-style-type: none"> 1 Turn the ignition switch to OFF. 2 Disconnect the front passenger's exterior mirror harness plug PD03. 3 Measure the resistance between the front passenger's exterior mirror harness terminal and the exterior mirror and dimmer switch harness terminal. Measuring circuit: resistance between No.1 terminal of PD03 plug and No.9 terminal of DD11 plug. Measuring circuit: resistance between No.3 terminal of PD03 plug and No.6 terminal of DD11 plug. Measuring circuit: resistance between terminal 2 of PD03 plug and terminal 2 of DD11 plug. Standard value: $\approx 0\Omega$ 4 Check whether the result is normal or not?
	NO → Repair or replace the faulted parts.
YES ↓	
Steps7	Check driver's exterior mirror circuit (short circuit).
	<ol style="list-style-type: none"> 1 Turn the ignition switch to OFF. 2 Connect the external rearview mirror and dimmer switch harness plug DD11. 3 Measure the resistance between the driver's side exterior mirror harness plug and ground. Measuring circuit: resistance between terminal 1 of DD03 plug and ground. Measuring circuit: resistance between terminal 2 of DD03 plug and ground. Measuring circuit: resistance between terminal 3 of DD03 plug and ground. Standard value: infinite 4 Measure the voltage between the driver's outside rearview mirror harness plug and ground. Measuring circuit: voltage between terminal 1 of DD03 plug and ground. Measuring circuit: voltage between terminal 2 of DD03 plug and ground. Measuring circuit: voltage between terminal 3 of DD03 plug and ground. Standard value: $\approx 0V$ 5 Check whether the result is normal or not?
	NO → Repair or replace the faulted parts.
YES ↓	

Steps8	Check front passenger's exterior mirror circuit (short circuit).
	<ol style="list-style-type: none"> 1 Turn the ignition switch to OFF. 2 Connect the external rearview mirror and dimmer switch harness plug DD11. 3 Measure the resistance between front passenger's exterior mirror harness plug and ground. Measuring circuit: resistance between No.1 terminal of PD03 plug and ground. Measuring circuit: resistance between terminal 2 of PD03 plug and ground. Measuring circuit: resistance between terminal 3 of PD03 plug and ground. Standard value: infinite 4 Measure the voltage between the driver's outside rearview mirror harness plug and ground. Measuring circuit: voltage between terminal 1 of PD03 plug and ground. Measuring circuit: voltage between terminal 2 of PD03 plug and ground. Measuring circuit: voltage between terminal 3 of PD03 plug and ground. Standard value: ≈ 0V 5 Check whether the result is normal or not?
	NO → Repair or replace the faulted parts.
YES ↓	

Steps9	Replace the exterior rearview mirror in good condition.
	<ol style="list-style-type: none"> 1 Replace the exterior rearview mirror in good condition. 2 Reconnect all disconnected harness terminals. 3 Connect the fault diagnosis instrument to the diagnosis interface. 4 Turn the ignition switch to ON position. 5 Read the BCM Diagnostic Trouble Code (DTC) with a scan tool. 6 Clear the BCM diagnostic trouble code (DTC). 7 Turn the ignition switch to OFF. 8 Wait at least 15 seconds to allow the module to shut down correctly. 9 Turn the ignition switch to ON again. 10 Read the DTC again. 11 Does the fault code still exist?
NO → Replace the exterior rearview mirror.	
YES ↓	
Steps5	Check whether BCM is abnormal.
	<ol style="list-style-type: none"> 1 Turn the ignition switch to OFF. 2 Disconnect and check the connectors IP01_A, IP01_B and IP01_C of BCM harness. 3 Check and repair. <ul style="list-style-type: none"> • Corrosion(install new adapting piece or terminal-cleaning module and pin). • Pin damaged or bent-install new terminal/pin. • Fly out of pins-install new pins as needed. 4 Reconnect the BCM plug and all other previously disconnected plugs. Make sure that the pins are properly positioned and fixed. 5 Run the system and determine if the problem persists?
YES → Replace BCM.	
NO ↓	
At this point the system is functioning normally. The problem may be caused by module connections. Address the root cause of any connector or pin problems,	
Next Step ↓	
Diagnosis end.	

B1012-12、 B1013-12、 B1014-1E、 B1014-12

Fault diagnosis code
B1012-12: Front wiper power relay output short to battery
B1013-12: Front wiper speed relay output short to battery
B1014-1E: Front wiper intermittent input out of range
B1014-12: Front wiper SW short to battery
Detection tools
1 Multimeter and diagnostic apparatus
Possible causes
<ul style="list-style-type: none"> • Lines, terminals or connectors • BCM • Front wiper combination switch failure. • Front wiper motor failure • Fuse failure
Conditions for fault code operation
Turn the ignition switch to ON position.
Conditions for fault code setting
B1012-12
B1013-12
B1014-1E
B1014-12
To set the effect of a fault code condition
1
2
Description of circuit diagram

Circuit diagram

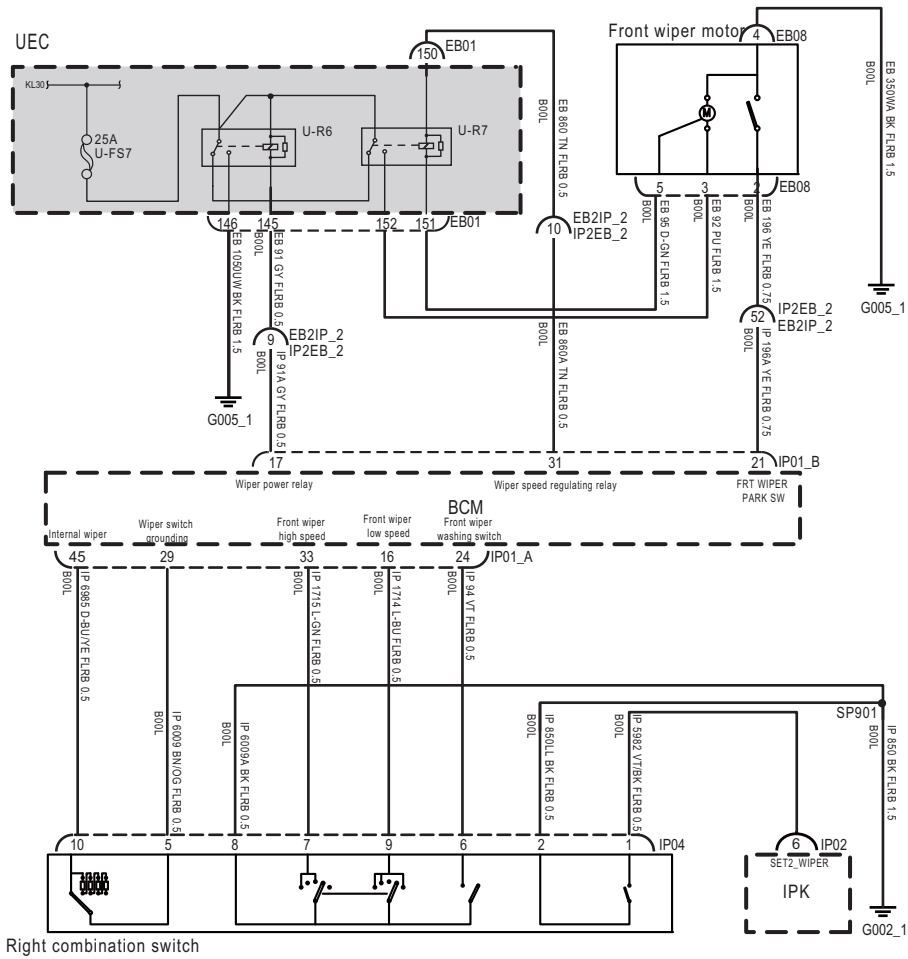

Right combination switch

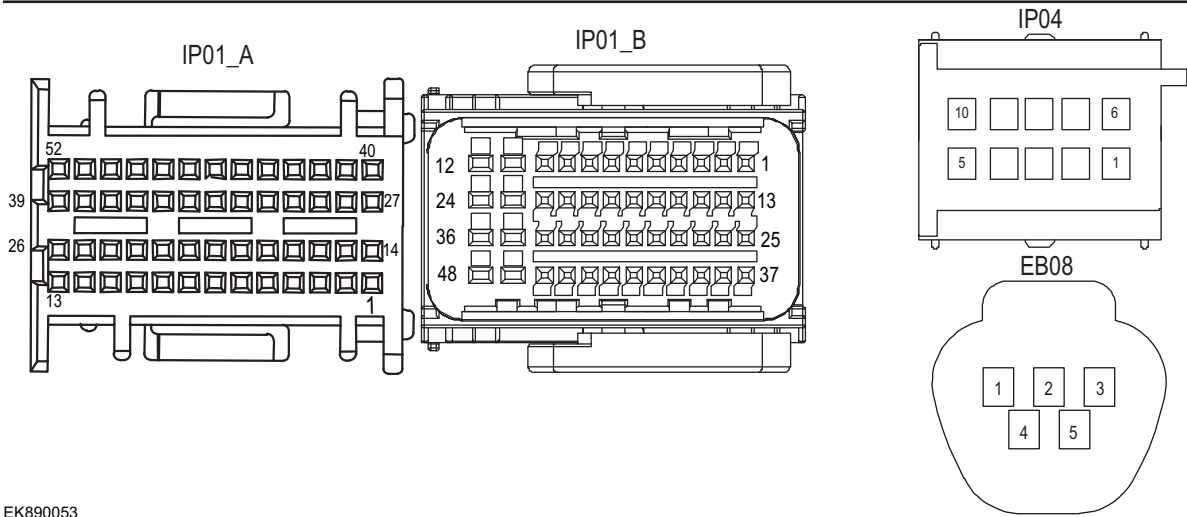

EK890053

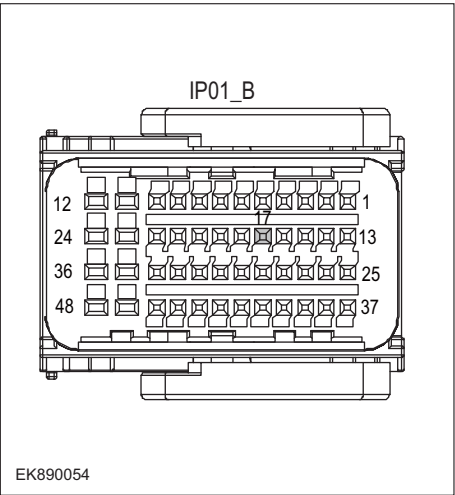
Troubleshooting steps	
Steps1	General inspection.
	<ol style="list-style-type: none"> 1 Check fuseU-FS7 for damage. 2 Check battery capacity. 3 Check the front wiper and BCM harness plugs for damage, poor contact, aging, and looseness. 4 Check whether the result is normal or not?
NO → Repair or replace the faulted parts.	
YES ↓	
Steps2	Check fault codes.
	<ol style="list-style-type: none"> 1 Connect the fault diagnosis instrument to the diagnosis interface. 2 Turn the ignition switch to ON position. 3 Diagnose BCM with diagnostic instrument. 4 If there is any fault code except for B1012-12、B1013-12、B1014-1E、 B1014-12?
YES → Refer to: DTC Summary list(BCM)	
NO ↓	
Steps3	Check the wiper power supply battery power supply voltage of BCM.
	<ol style="list-style-type: none"> 1 Turn the ignition switch to OFF. 2 Disconnect BCM harness plug IP01 _ B. 3 Measure the voltage between BCM harness terminal and ground. Measuring circuit: voltage between terminal 17 of IP01_B plug and ground. Standard value:10~14V 4 Check whether the result is normal or not?
NO → Repair or replace the faulted parts.	
YES ↓	

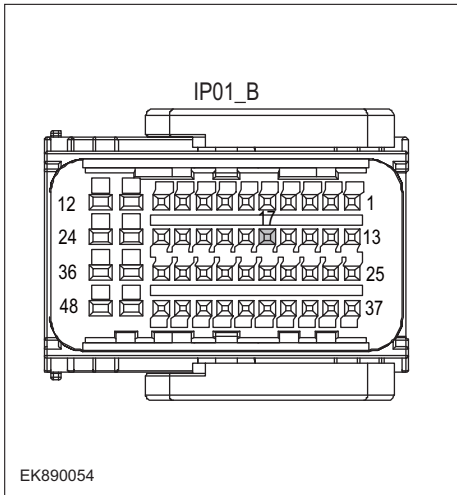
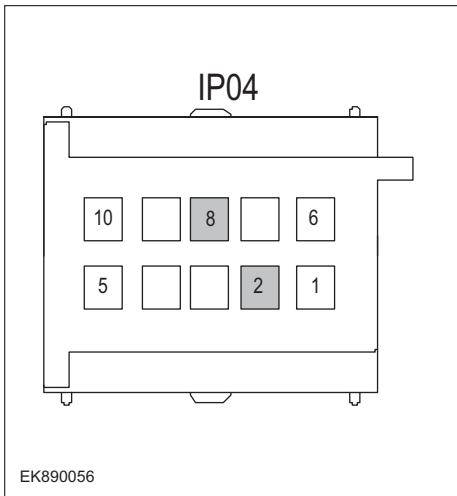
Steps4	Check the power supply voltage of BCM wiper power supply when it is started or running.
	<ol style="list-style-type: none"> 1 Turn the ignition switch to ON. 2 Measure the voltage between BCM harness terminal and ground. Measuring circuit: voltage between terminal 17 of IP01_B plug and ground. Standard value:10~14V 3 Check whether the result is normal or not?
NO → Repair or replace the faulted parts.	
YES ↓	
Steps5	Check the BCM wiper ground circuit for an open circuit.
	<ol style="list-style-type: none"> 1 Turn the ignition switch to OFF. 2 Measure the resistance between right combination switch harness plug and ground. Measuring circuit: resistance between terminal 2 of IP04 plug and ground. Measuring circuit: resistance between No.8 terminal of IP04 plug and ground. Standard value:< 1Ω 3 Test whether the resistance is less than 1Ω?
NO → Repair or replace the faulted parts.	
YES ↓	

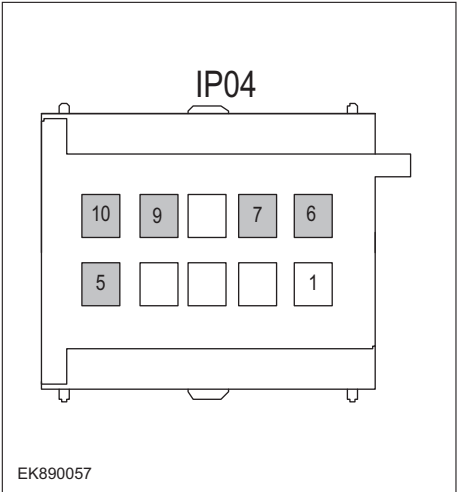
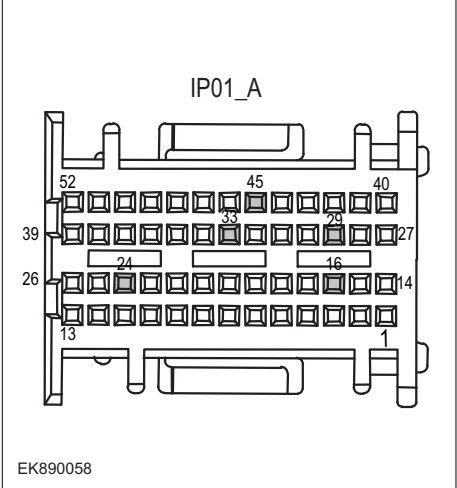
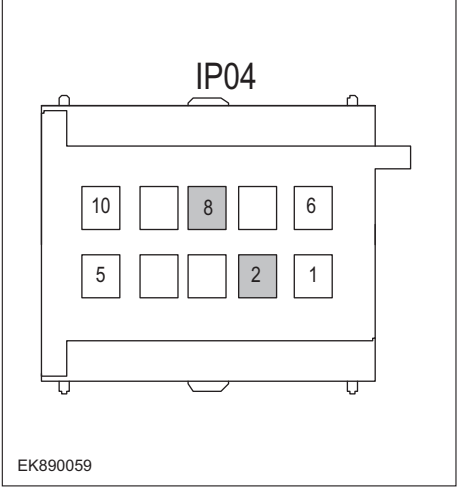
Steps6	Check circuit (open circuit) between front wiper combination switch and BCM.
 <p>EK890057</p>  <p>EK890058</p>	<ol style="list-style-type: none"> 1 Turn the ignition switch to OFF. 2 Disconnect the plug IP01_A of BCM harness. 3 Disconnect the front wiper combination switch harness plug IP04. 4 Measure the resistance between the front wiper combination switch harness terminal and BCM harness terminal. <ul style="list-style-type: none"> Measuring circuit: resistance between terminal 5 of IP04 plug and terminal 29 of IP01_A plug. Measuring circuit: resistance between terminal 6 of IP04 plug and terminal 24 of IP01_A plug. Measuring circuit: resistance between terminal 7 of IP04 plug and terminal 33 of IP01_A plug. Measuring circuit: resistance between No.9 terminal of IP04 plug and No.16 terminal of IP01_A plug. Measuring circuit: resistance between terminal 10 of IP04 plug and terminal 45 of IP01_A plug. <p>Standard value: $\approx 0\Omega$</p> <ol style="list-style-type: none"> 5 Check whether the result is normal or not?
NO → Repair or replace the faulted parts.	
YES ↓	
Steps7	Check the ground circuit of the front wiper combination switch for an open circuit.
 <p>EK890059</p>	<ol style="list-style-type: none"> 1 Turn the ignition switch to OFF. 2 Measure the resistance between front wiper combination switch harness plug and ground. <ul style="list-style-type: none"> Measuring circuit: resistance between terminal 2 of IP04 plug and ground. Measuring circuit: resistance between No.8 terminal of IP04 plug and ground. <p>Standard value: $< 1\Omega$</p> 3 Test whether the resistance is less than 1Ω?
NO → Repair or replace the faulted parts.	
YES ↓	

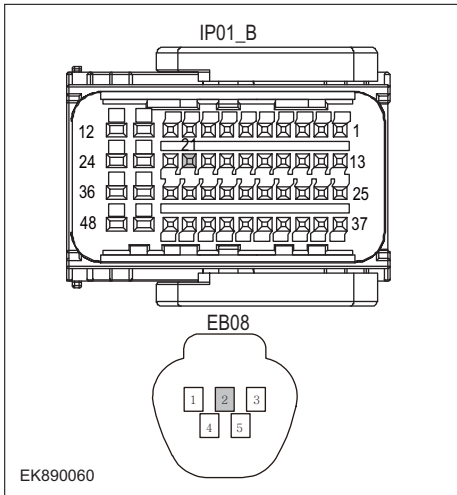
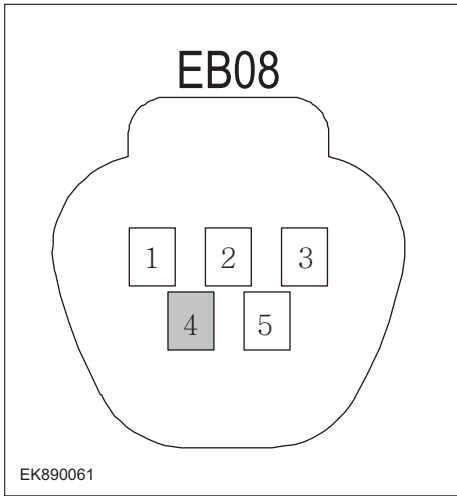
Steps8	Check the circuit between front wiper motor and BCM (open circuit).
 <p>EK890060</p>	<ol style="list-style-type: none"> 1 Turn the ignition switch to OFF. 2 Disconnect BCM harness plug IP01 _ B. 3 Disconnect the front wiper motor harness plug EB08. 4 Measure the resistance between the front wiper combination switch harness terminal and BCM harness terminal. Measuring circuit: resistance between terminal 2 of EB08 plug and terminal 21 of IP01_B plug. Standard value: $\approx 0\Omega$ 5 Check whether the result is normal or not?
NO → Repair or replace the faulted parts.	
YES ↓	
Steps9	Check the ground circuit of the front wiper motor for an open.
 <p>EK890061</p>	<ol style="list-style-type: none"> 1 Turn the ignition switch to OFF. 2 Measure the resistance between front wiper harness plug and ground. Measuring circuit: resistance between terminal 4 of EB08 plug and ground. Standard value: $< 1\Omega$ 3 Test whether the resistance is less than 1Ω?
NO → Repair or replace the faulted parts.	
YES ↓	

BCM

Steps10	Check whether BCM is abnormal.
	<ol style="list-style-type: none"> 1 Turn the ignition switch to OFF. 2 Disconnect and check the connectors IP01_A, IP01_B and IP01_C of BCM harness. 3 Check and repair. <ul style="list-style-type: none"> • Corrosion(install new adapting piece or terminal-cleaning module and pin). • Pin damaged or bent-install new terminal/pin. • Fly out of pins-install new pins as needed. 4 Reconnect the BCM plug and all other previously disconnected plugs. Make sure that the pins are properly positioned and fixed. 5 Run the system and determine if the problem persists?
	YES → Replace BCM.
NO ↓	
At this point the system is functioning normally. The problem may be caused by module connections. Address the root cause of any connector or pin problems,	
Next Step ↓	
Diagnosis end.	

B1500-13、 B1502-55

Fault diagnosis code
B1502-51: IMMONotSaveAnyKeyInformation
B1500-13: IMMO Antenna Failure, Antenna Open or Short Circuit
Detection tools
1 Multimeter and diagnostic apparatus
Possible causes
<ul style="list-style-type: none"> • Lines, terminals or connectors • BCM • PEPS • IMMO • Fuse failure
Conditions for fault code operation
Turn the ignition switch to ON position.
Conditions for fault code setting
B1500-13
B1502-51
To set the effect of a fault code condition
1
2
Description of circuit diagram

Circuit diagram

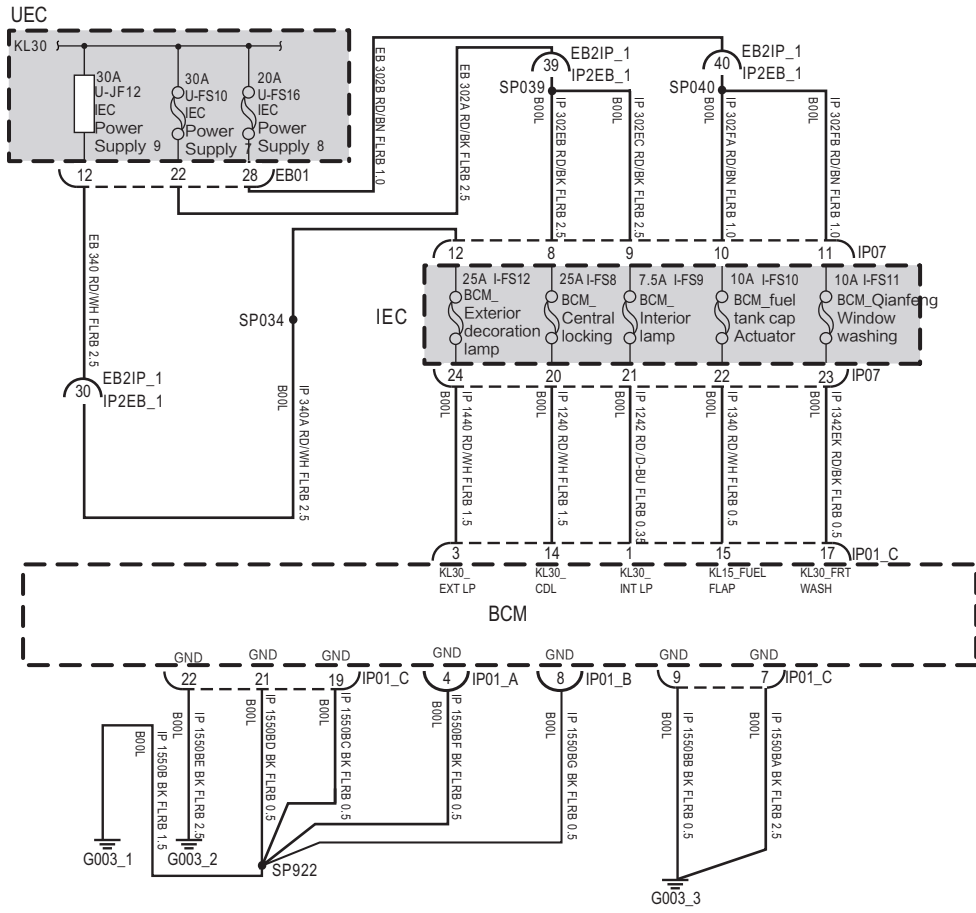

IP01_A

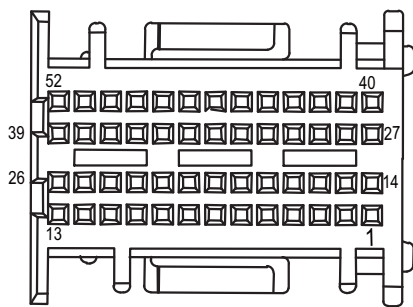

IP01_B

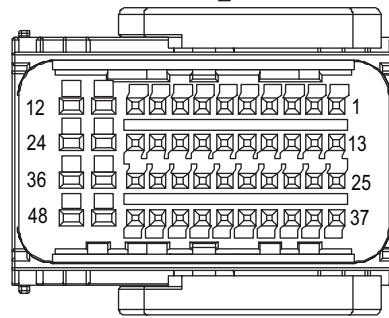

IP01_C

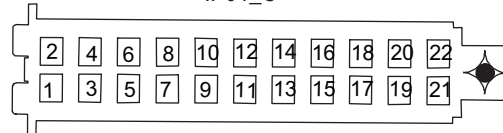

EK890001

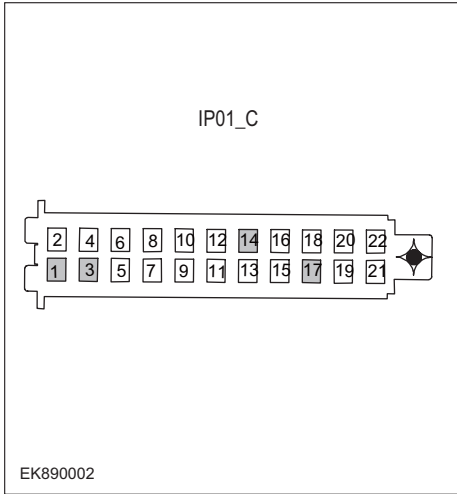
Troubleshooting steps	
Steps1	General inspection.
	<ol style="list-style-type: none"> 1 Check fuseU-JF12、 U-FS10、 U-FS16 for damage. 2 Check battery capacity. 3 Check the harness plug of air conditioning control module for damage, poor contact, aging and looseness. 4 Check whether the result is normal or not?
	NO → Repair or replace the faulted parts.
YES ↓	
Steps2	Check fault codes.
	<ol style="list-style-type: none"> 1 Connect the fault diagnosis instrument to the diagnosis interface. 2 Turn the ignition switch to ON position. 3 Diagnosticsing BCM using a diagnostics. 4 If there is any fault code except for B1500-13、 B1502-55?
	YES → Refer to: DTC Summary list(BCM)
NO ↓	
Steps3	Check the supply voltage of BCM battery.
	<ol style="list-style-type: none"> 1 Turn the ignition switch to OFF. 2 Disconnect plug IP01_C of BCM harness. 3 Measure the voltage between BCM harness terminal and ground. Measuring circuit: voltage between terminal 1 of IP01_C plug and ground. Measuring circuit: voltage between terminal 3 of IP01_C plug and ground. Measuring circuit: voltage between terminal 14 of IP01_C plug and ground. Measuring circuit: voltage between terminal 17 of IP01_C plug and ground. Standard value:10~14V 4 Check whether the result is normal or not?
	NO → Repair or replace the faulted parts.
YES ↓	

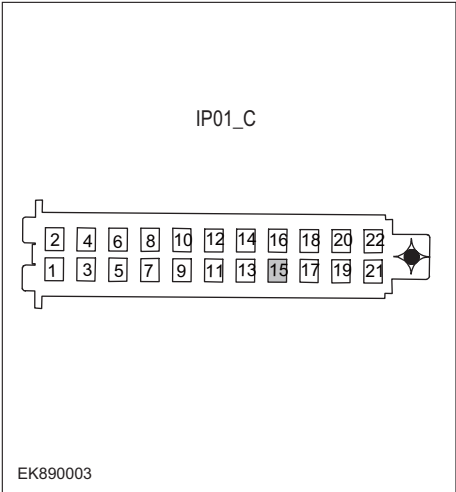
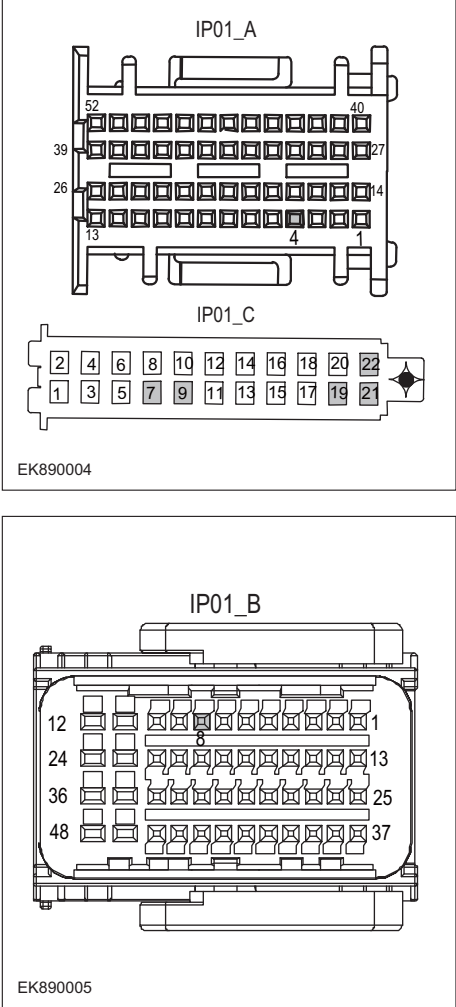
Steps4	Check the power supply voltage when BCM is started or running.
	<ol style="list-style-type: none"> 1 Turn the ignition switch to ON. 2 Measure the voltage between IP01_C harness terminal and ground. Measuring circuit: voltage between terminal 15 of IP01_C plug and ground. Standard value:10~14V 3 Check whether the result is normal or not?
NO → Repair or replace the faulted parts.	
YES ↓	
Steps5	Check BCM ground circuit for open circuit.
	<ol style="list-style-type: none"> 1 Turn the ignition switch to OFF. 2 Disconnect the connectors IP01_A, IP01_B and IP01_C of BCM harness. 3 Measure the resistance between BCM harness plug and ground. Measuring circuit: resistance between terminal 22 of IP01_C plug and ground. Measuring circuit: resistance between terminal 21 of IP01_C plug and ground. Measuring circuit: resistance between No.19 terminal of IP01_C plug and ground. Measuring circuit: resistance between terminal 4 of IP01_A plug and ground. Measuring circuit: resistance between No.8 terminal of IP01_B plug and ground. Measuring circuit: resistance between No.9 terminal of IP01_C plug and ground. Measuring circuit: resistance between terminal 7 of IP01_C plug and ground. Standard value:< 1Ω 4 Test whether the resistance is less than 1Ω?
NO → Repair or replace the faulted parts.	
YES ↓	

Steps6	Test whether BCM is norm.
	<ol style="list-style-type: none"> 1 Turn the ignition switch to OFF. 2 Disconnect and check the connectors IP01_A, IP01_B and IIP01_C of BCM harness. 3 Check and repair. <ul style="list-style-type: none"> • Corrosion(install new adapting piece or terminal-cleaning module and pin). • Pin damaged or bent-install new terminal/pin. • Fly out of pins-install new pins as needed. 4 Reconnect the BCM plug and all other previously disconnected plug. Make sure the pin is properly positioned and fixed. 5 Run the system and determine if the problem persists?
	YES → Replace the BCM.
NO ↓	
At this point the system is functioning normally. The problem may be caused by module connections. Address the root cause of any connector or pin problems,	
Next Step ↓	
Diagnosis end.	

BCM

B1506-87、 B1506-62、 B1501-29、 B162F-42、 B1022-04

Fault diagnosis code
B1506-87: No ECM Challenge Rx: No challenge received within 2seconds of KL.15
B1506-62: ECM Authentication Failure
B1501-29: Key Authentication Failure F
B162F-42: EEPROM(NVM) Error
B1022-04: System internal failure
Detection tools
1 Multimeter and diagnostic apparatus
Possible causes
<ul style="list-style-type: none">• BCM• PEPS• Ignition key failure
Conditions for fault code operation
Turn the ignition switch to ON position.
Conditions for fault code setting
B1506-87
B1506-62
B1501-29
B162F-42
B1022-04
To set the effect of a fault code condition
1
2

Troubleshooting steps	
Steps1	General inspection.
	<ol style="list-style-type: none"> 1 Check battery capacity. 2 Check whether the ignition key battery is fully charged. 3 Check the harness plug of air conditioning control module for damage, poor contact, aging and looseness. 4 Check whether the result is normal or not?
	NO → Repair or replace the faulted parts.
YES ↓	
Steps2	Check fault codes.
	<ol style="list-style-type: none"> 1 Connect the fault diagnosis instrument to the diagnosis interface. 2 Turn the ignition switch to ON position. 3 Diagnosticsing BCM using a diagnostics. 4 If there is any fault code except for B1506-87、 B1506-62、 B1501-29、 B162F-42、 B1022-04?
	YES → Refer to: DTC Summary list(BCM)
NO ↓	
Steps3	Perform initialization.
	<ol style="list-style-type: none"> 1 Turn the ignition switch to OFF. 2 Connect the fault diagnosis instrument to the diagnosis interface. 3 Turn the ignition switch to ON. 4 Initialize the body control module and register all keys with the diagnostic instrument. 5 Can the body control module be initialized and can the registered key start the vehicle?
	NO → Repair or replace the ignition key or body control module.
YES ↓	
At this point the system is functioning normally. The problem may be caused by module connections. Address the root cause of any connector or pin problems,	
Next Step ↓	
Diagnosis end.	

B1507-08、 U0423-62、 U0424-62

Fault diagnosis code
B1507-08: Basestation Communication Error
U0423-62: Signal compare failure Odometer
U0424-62: Signal compare failure VIN not equal with IPK's
Detection tools
1 Multimeter and diagnostic apparatus
Possible causes
<ul style="list-style-type: none"> • Lines, terminals or connectors • BCM
Conditions for fault code operation
Turn the ignition switch to ON position.
Conditions for fault code setting
B1507-08
U0423-62
U0424-62
To set the effect of a fault code condition
Description of circuit diagram
The device is connected to serial data circuit, which is used to monitor the communication situation of serial data during normal operation of vehicle. The devices will exchange the operation information and commands mutually. The device has programming information required to be exchanged on the serial data circuit. The receiver device will also monitor such information; in addition, there are some regular information indication transmitter devices available.

Circuit diagram

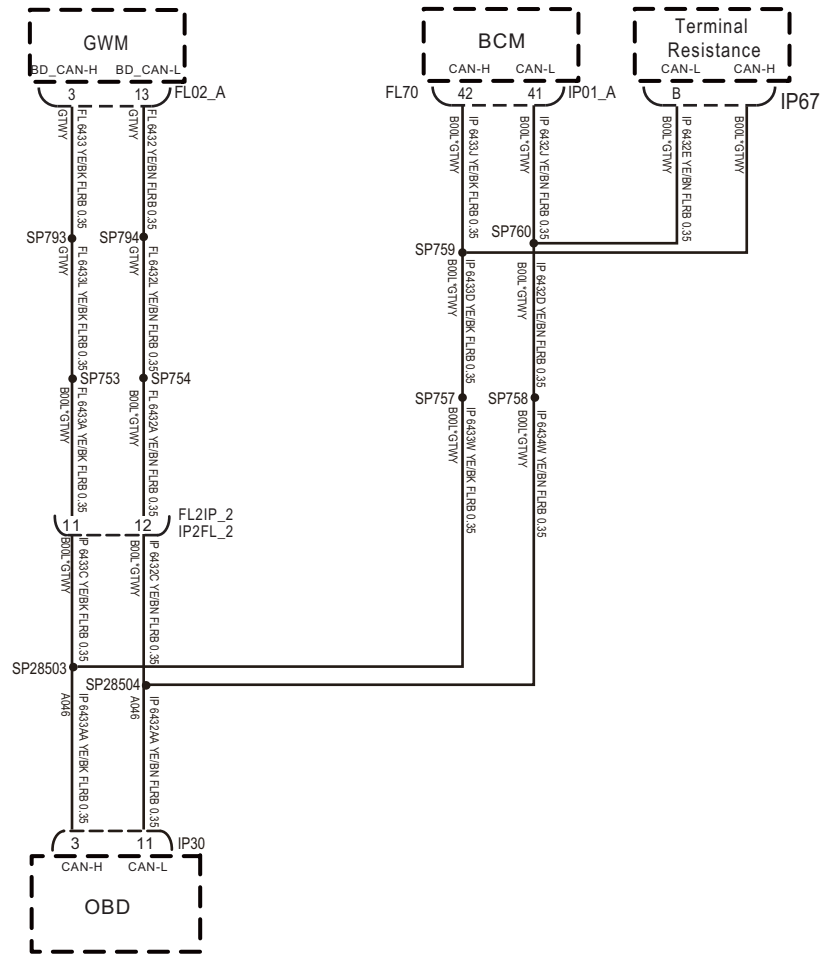

IP01_A

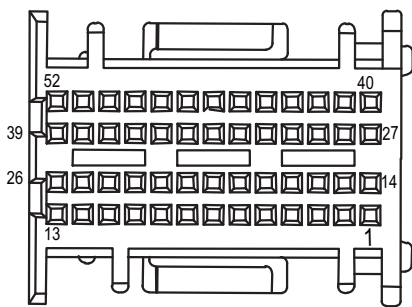

IP67

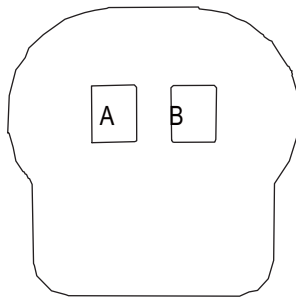

FL02_A

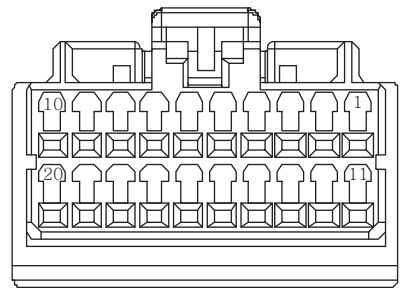

IP30

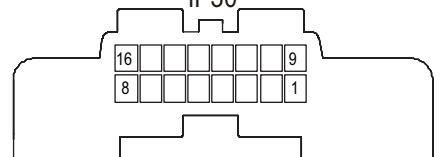

EK890006

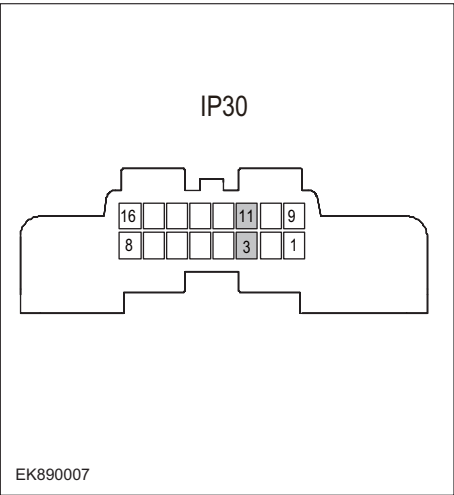
Troubleshooting steps	
Steps1	General inspection.
	<ol style="list-style-type: none"> 1 Check whether the fuse is damaged. 2 Check battery capacity. 3 Check the BCM harness plug for damage, poor contact, aging and looseness. 4 Check whether the result is normal or not?
	NO → Repair or replace the faulted parts.
YES ↓	
Steps2	Check fault codes.
	<ol style="list-style-type: none"> 1 Connect the fault diagnosis instrument to the diagnosis interface. 2 Turn the ignition switch to ON position. 3 Diagnose BCM with diagnostic instrument. 4 If there is any fault code except for B1507-08、U0423-62、U0424-62?
	YES → Refer to: DTC Summary list(BCM)
NO ↓	
Steps3	Inspection for CAN communication network completeness.
	<ol style="list-style-type: none"> 1 Turn the ignition switch to OFF. 2 Measure the resistance between the harness terminals of diagnose interface. Measuring circuit: the resistance between terminal 3 and 11 on plug IP28. Standard value: ≈ 60Ω 3 Check whether the result is normal or not?
	NO → Repair or replace the faulted parts.
YES ↓	

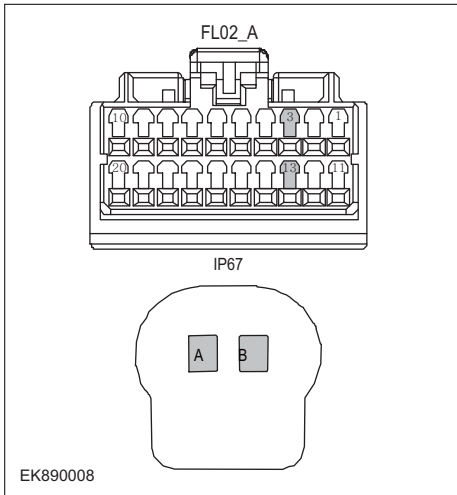
Steps4	Check the terminal resistance of gateway module and BD resistor.
	<ol style="list-style-type: none"> 1 Turn the ignition switch to OFF. 2 Disconnect the gateway module harness plug FL02_A. 3 Measure the resistance between the gateway module harness terminals. Measuring circuit: resistance between terminal 3 and terminal 13 of FL02_A plug. Standard value:110~130Ω 4 Connect the gateway module harness plug FL02_A. 5 Disconnect BD resistor harness plug IP67. 6 Measure the resistance between BD resistor harness terminals. Measuring circuit: resistance between terminal A and terminal B of IP67 plug. Standard value:110~130Ω 7 Check whether the result is normal or not?
<p>NO → Repair or replace the faulted parts.</p>	
<p>YES ↓</p>	
Steps5	Check whether BCM is abnormal.
	<ol style="list-style-type: none"> 1 Turn the ignition switch to OFF. 2 Disconnect and check the connectors IP01_A, IP01_B and IP01_C of BCM harness. 3 Check and repair. <ul style="list-style-type: none"> • Corrosion(install new adapting piece or terminal-cleaning module and pin). • Pin damaged or bent-install new terminal/pin. • Fly out of pins-install new pins as needed. 4 Reconnect the BCM plug and all other previously disconnected plugs. Make sure that the pins are properly positioned and fixed. 5 Run the system and determine if the problem persists?
<p>YES → Replace BCM.</p>	
<p>NO ↓</p>	
<p>At this point the system is functioning normally. The problem may be caused by module connections. Address the root cause of any connector or pin problems,</p>	
<p>Next Step ↓</p>	
<p>Diagnosis end.</p>	

U1532-00、U1533-00、U1534-00、U1535-00、U1536-00

Fault diagnosis code
U1532-00: ASIC_Error LIN signal: ASIC_Error =1
U1533-00: Rain Channel A Error LIN signal: Rain Channel A Error=1
U1534-00: Rain Channel B Error LIN signal: Rain Channel B Error=1
U1535-00: Ambient Light Error LIN signal: Ambient Light Error =1
U1536-00: Solar Sensor Error LIN signal: Solar Sensor Error =1
Detection tools
1 Multimeter and diagnostic apparatus
Possible causes
<ul style="list-style-type: none"> • Lines, terminals or connectors • BCM • PEPS • IMMO • Fuse failure
Conditions for fault code operation
Turn the ignition switch to ON position.
Conditions for fault code setting
U1532-00
U1533-00
U1534-00
U1535-00
U1536-00
To set the effect of a fault code condition
1
2
Description of circuit diagram

Circuit diagram

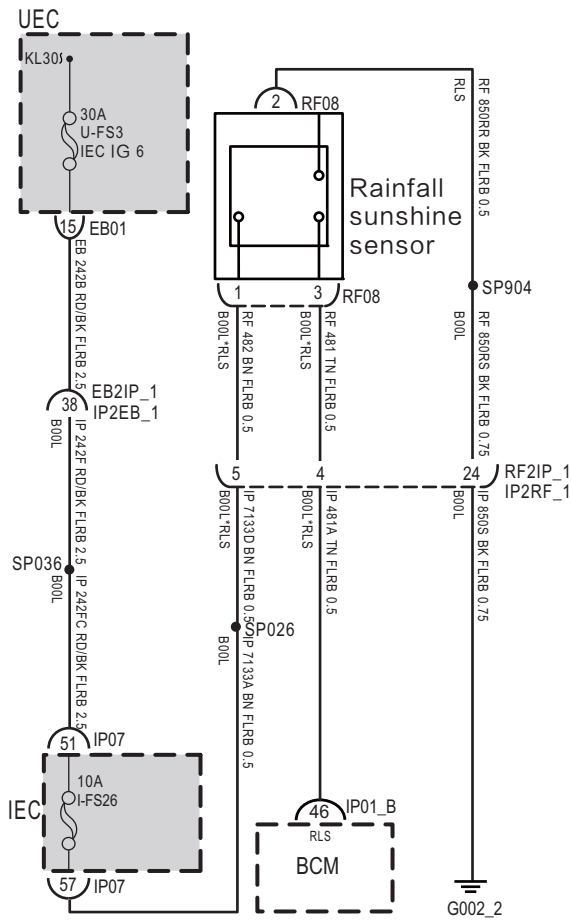

IP01_B

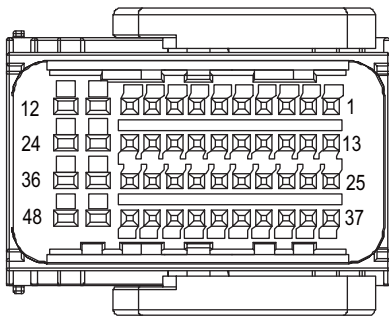

RF08

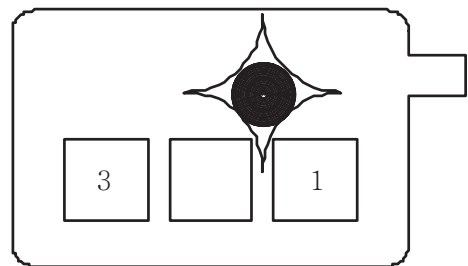

EK890062

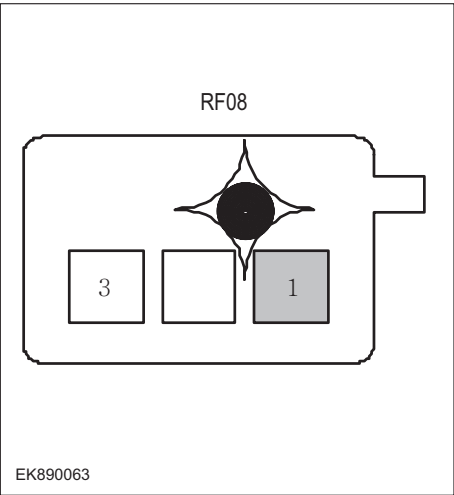
Troubleshooting steps	
Steps1	General inspection.
	<ol style="list-style-type: none"> 1 Check fuseU-FS3、 I-FS26 for damage. 2 Check battery capacity. 3 Check the harness plug of air conditioning control module for damage, poor contact, aging and looseness. 4 Check whether the result is normal or not?
NO → Repair or replace the faulted parts.	
YES ↓	
Steps2	Check fault codes.
	<ol style="list-style-type: none"> 1 Connect the fault diagnosis instrument to the diagnosis interface. 2 Turn the ignition switch to ON position. 3 Diagnosticsing BCM using a diagnostics. 4 If there is any fault code except for U1532-00、 U1533-00、 U1534-00、 U1535-00、 U1536-00?
YES → Refer to: DTC Summary list(BCM)	
NO ↓	
Steps3	Check the power supply voltage of rainfall sunshine sensor.
	<ol style="list-style-type: none"> 1 Turn the ignition switch to OFF. 2 Disconnect the rain sunshine sensor harness plug RF08. 3 Measure the voltage between the rain sunshine sensor harness terminal and ground. Measuring circuit: voltage between terminal 1 of RF08 plug and ground. Standard value:10~14V 4 Check whether the result is normal or not?
NO → Repair or replace the faulted parts.	
YES ↓	

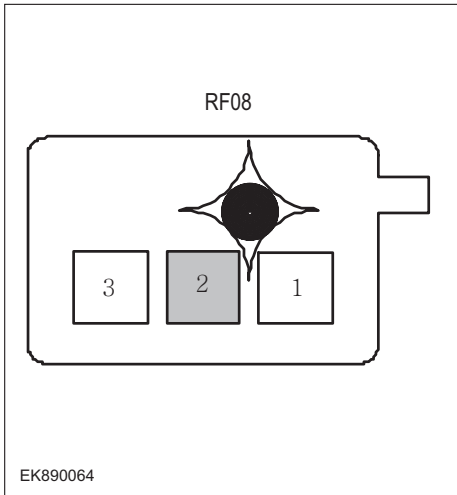
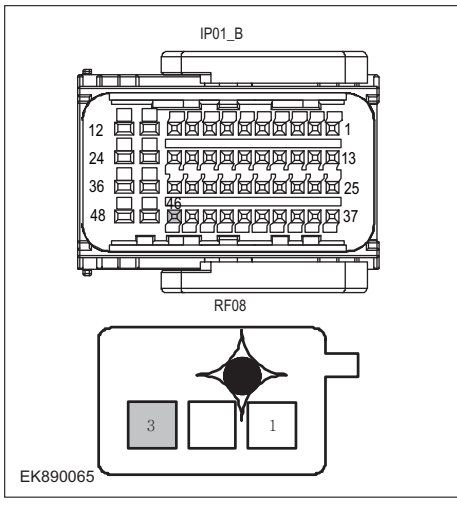
Steps4	Check the rain sunshine sensor ground circuit for an open circuit.
	<ol style="list-style-type: none"> 1 Turn the ignition switch to OFF. 2 Disconnect the harness plug RF08 of the sunshine sensor. 3 Measure the resistance between harness plug of sunshine sensor and ground. Measuring circuit: resistance between terminal 2 of RF08 plug and ground. Standard value:< 1Ω 4 Test whether the resistance is less than 1Ω?
NO → Repair or replace the faulted parts.	
YES ↓	
Steps5	Check the circuit between BCM and sunshine rain sensor.
	<ol style="list-style-type: none"> 1 Turn the ignition switch to OFF. 2 Disconnect BCM harness plug IP01 _ B. 3 Disconnect the harness plug RF08 of the sunshine rain sensor. 4 Measure the resistance between BCM harness plug and sunshine rain sensor harness plug. Measuring circuit: resistance between No.46 terminal of IP01_B plug and No.3 terminal of RF08 plug. Standard value:< 1Ω 5 Test whether the resistance is less than 1Ω?
NO → Repair or replace the faulted parts.	
YES ↓	

Steps6	Replace the sunshine rain sensor in good condition.
	<ol style="list-style-type: none"> 1 Replace the sunshine rain sensor in good condition. 2 Reconnect all disconnected harness terminals. 3 Connect the fault diagnosis instrument to the diagnosis interface. 4 Turn the ignition switch to ON position. 5 Read the BCM Diagnostic Trouble Code (DTC) with a scan tool. 6 Clear the BCM diagnostic trouble code (DTC). 7 Turn the ignition switch to OFF. 8 Wait at least 15 seconds to allow the module to shut down correctly. 9 Turn the ignition switch to ON again. 10 Read the DTC again. 11 Does the fault code still exist?
NO → Replace the sunshine rainfall sensor.	
YES ↓	
Steps7	Test whether BCM is norm.
	<ol style="list-style-type: none"> 1 Turn the ignition switch to OFF. 2 Disconnect and check the harness plug IP01_A、IP01_B、IP01_C of BCM. 3 Check and repair. <ul style="list-style-type: none"> • Corrosion(install new adapting piece or terminal-cleaning module and pin). • Pin damaged or bent-install new terminal/pin. • Fly out of pins-install new pins as needed. 4 Reconnect the BCM plug and all other previously disconnected plug. Make sure the pin is properly positioned and fixed. 5 Run the system and determine if the problem persists?
YES → Replace the BCM.	
NO ↓	
At this point the system is functioning normally. The problem may be caused by module connections. Address the root cause of any connector or pin problems,	
Next Step ↓	
Diagnosis end.	

U1537-00、 U1538-00、 U1539-00、 U153A-00、 U153B-00、 U153C-00

Fault diagnosis code
U1537-00: RLS Auto Config Error LIN signal: RLS Auto Config Error=1
U1538-00: RLS's Far(Ambient-D) Light Works Fault LIN signal: Err_Ambient_D=7 for 5 times
U1539-00: RLS Powerup is more than High-Voltage LIN signal: Err_PORup=1 for 5 times
U153A-00: RLS Powerup is less than Low-Voltage LIN signal: Err_PORup=2 for 5 times
U153B-00: RLS's Wiper always Stops at the Park Position LIN signal: Err_Wiper_Status=3 for 5 times
U153C-00: RLS's Wiper always doesn't Stop at the Park Position LIN signal: Err_Wiper_Status=8 for 5 times
Detection tools
1 Multimeter and diagnostic apparatus
Possible causes
<ul style="list-style-type: none"> • Lines, terminals or connectors • BCM • PEPS • IMMO • Fuse failure
Conditions for fault code operation
Turn the ignition switch to ON position.
Conditions for fault code setting
U1537-00
U1538-00
U1539-00
U153A-00
U153B-00
U153C-00
To set the effect of a fault code condition
1
2
Description of circuit diagram

Circuit diagram

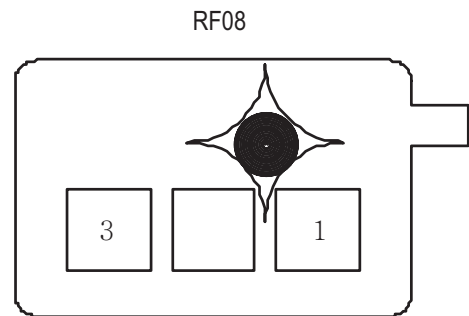
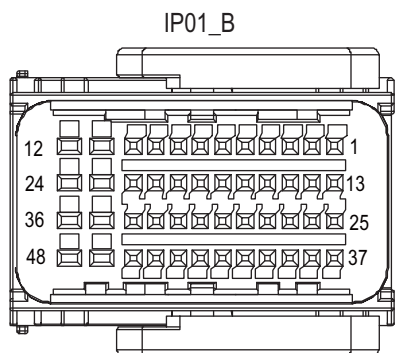
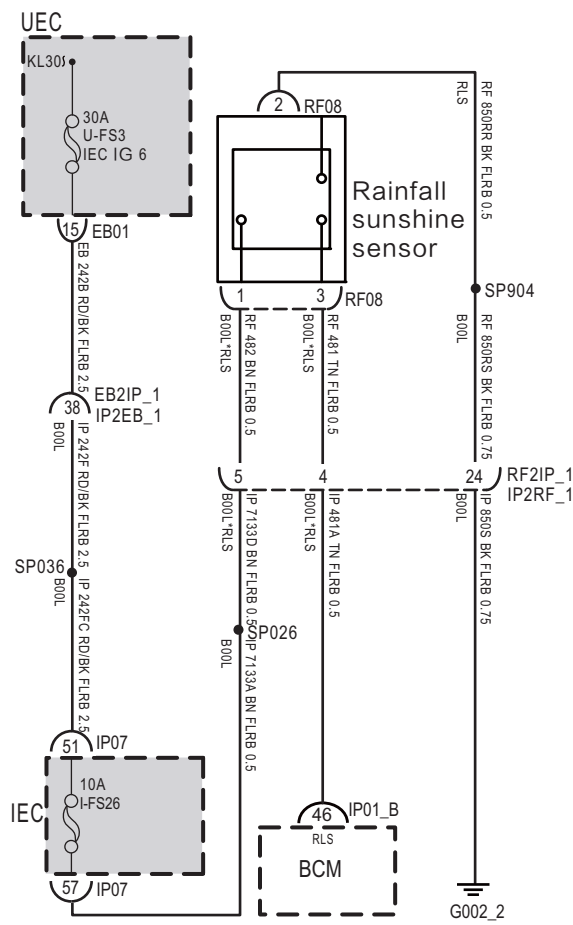

EK890062

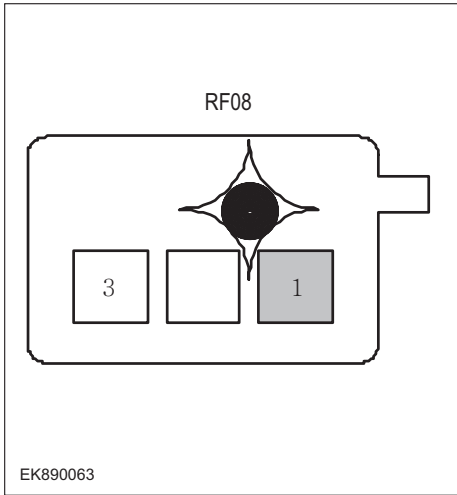
Troubleshooting steps	
Steps1	General inspection.
	<ol style="list-style-type: none"> 1 Check fuseU-FS3、 I-FS26 for damage. 2 Check battery capacity. 3 Check the harness plug of air conditioning control module for damage, poor contact, aging and looseness. 4 Check whether the result is normal or not?
	NO → Repair or replace the faulted parts.
YES ↓	
Steps2	Check fault codes.
	<ol style="list-style-type: none"> 1 Connect the fault diagnosis instrument to the diagnosis interface. 2 Turn the ignition switch to ON position. 3 Diagnosticing BCM using a diagnostics. 4 If there is any fault code except for U1537-00、 U1538-00、 U1539-00、 U153A-00、 U153B-00、 U153C-00?
	YES → Refer to: DTC Summary list(BCM)
NO ↓	
Steps3	Check the power supply voltage of rainfall sunshine sensor.
	<ol style="list-style-type: none"> 1 Turn the ignition switch to OFF. 2 Disconnect the rain sunshine sensor harness plug RF08. 3 Measure the voltage between the rain sunshine sensor harness terminal and ground. Measuring circuit: voltage between terminal 1 of RF08 plug and ground. Standard value:10~14V 4 Check whether the result is normal or not?
	NO → Repair or replace the faulted parts.
YES ↓	

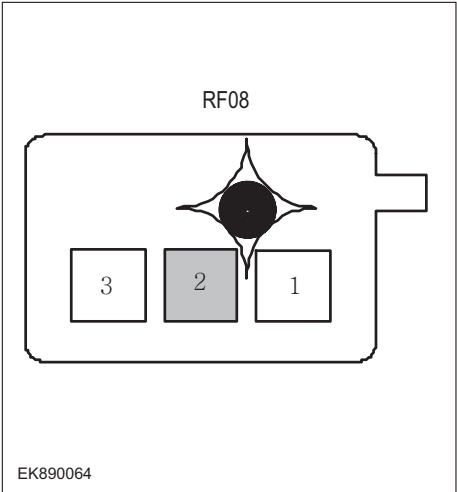
Steps4	Check the rain sunshine sensor ground circuit for an open circuit.
	<ol style="list-style-type: none"> 1 Turn the ignition switch to OFF. 2 Disconnect the harness plug RF08 of the sunshine sensor. 3 Measure the resistance between harness plug of sunshine sensor and ground. Measuring circuit: resistance between terminal 2 of RF08 plug and ground. Standard value:< 1Ω 4 Test whether the resistance is less than 1Ω?

NO → Repair or replace the faulted parts.

YES ↓

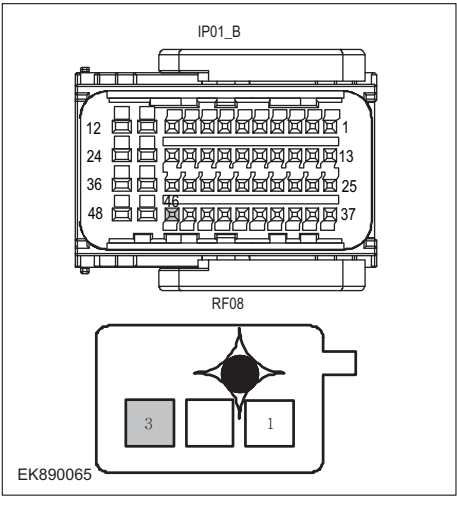
Steps5	Check the circuit between BCM and sunshine rain sensor.
	<ol style="list-style-type: none"> 1 Turn the ignition switch to OFF. 2 Disconnect BCM harness plug IP01 _ B. 3 Disconnect the harness plug RF08 of the sunshine rain sensor. 4 Measure the resistance between BCM harness plug and sunshine rain sensor harness plug. Measuring circuit: resistance between No.46 terminal of IP01_B plug and No.3 terminal of RF08 plug. Standard value:< 1Ω 5 Test whether the resistance is less than 1Ω?

NO → Repair or replace the faulted parts.

YES ↓

Steps6	Replace the sunshine rain sensor in good condition.
	<ol style="list-style-type: none"> 1 Replace the sunshine rain sensor in good condition. 2 Reconnect all disconnected harness terminals. 3 Connect the fault diagnosis instrument to the diagnosis interface. 4 Turn the ignition switch to ON position. 5 Read the BCM Diagnostic Trouble Code (DTC) with a scan tool. 6 Clear the BCM diagnostic trouble code (DTC). 7 Turn the ignition switch to OFF. 8 Wait at least 15 seconds to allow the module to shut down correctly. 9 Turn the ignition switch to ON again. 10 Read the DTC again. 11 Does the fault code still exist?
NO → Replace the sunshine rainfall sensor.	
YES ↓	
Steps7	Test whether BCM is norm.
	<ol style="list-style-type: none"> 1 Turn the ignition switch to OFF. 2 Disconnect and check the harness plug IP01_A、IP01_B、IP01_C of BCM. 3 Check and repair. <ul style="list-style-type: none"> • Corrosion(install new adapting piece or terminal-cleaning module and pin). • Pin damaged or bent-install new terminal/pin. • Fly out of pins-install new pins as needed. 4 Reconnect the BCM plug and all other previously disconnected plug. Make sure the pin is properly positioned and fixed. 5 Run the system and determine if the problem persists?
YES → Replace the BCM.	
NO ↓	
At this point the system is functioning normally. The problem may be caused by module connections. Address the root cause of any connector or pin problems,	
Next Step ↓	
Diagnosis end.	

B1401-77

Fault diagnosis code
B1401-77: Front wiper stall
Detection tools
1 Multimeter and diagnostic apparatus
Possible causes
<ul style="list-style-type: none">• Lines, terminals or connectors• Storage battery• BCM• Front wiper motor• Fuse
Conditions for fault code operation
Turn the ignition switch to ON position.
Conditions for fault code setting
B1401-77
To set the effect of a fault code condition
Description of circuit diagram

Circuit diagram

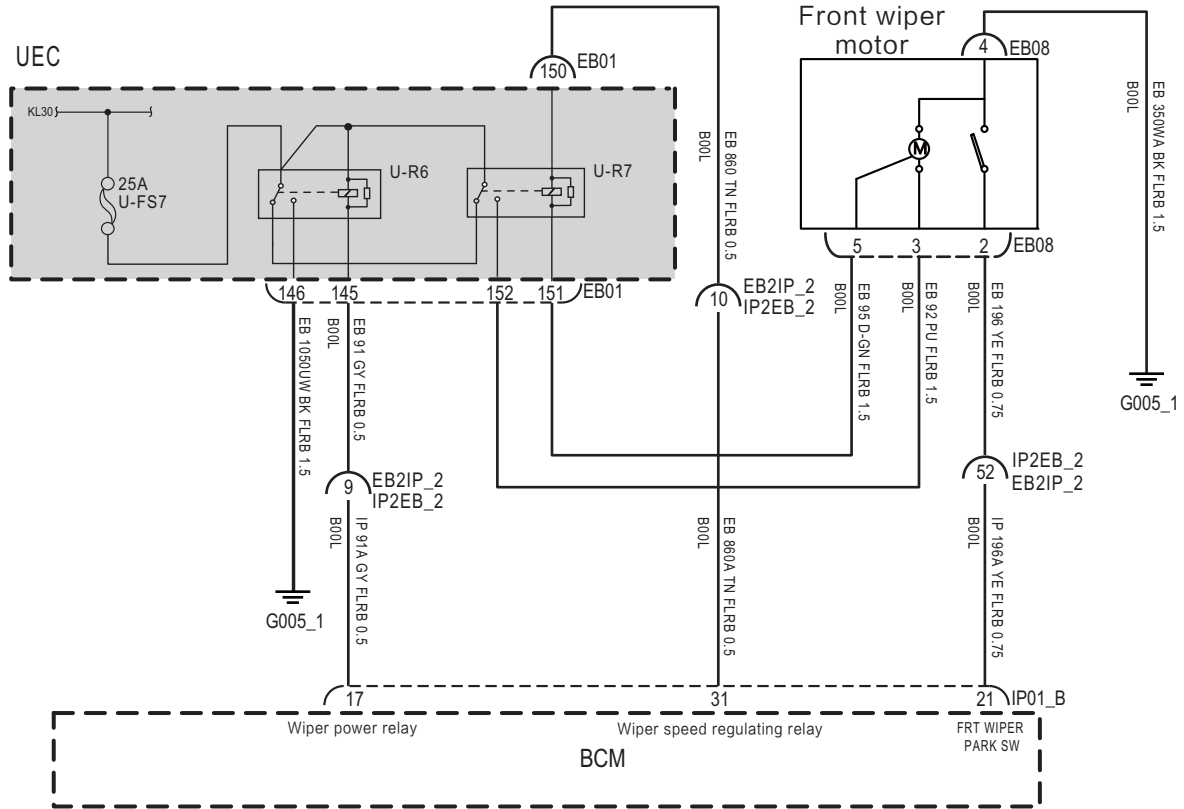

IP01_B

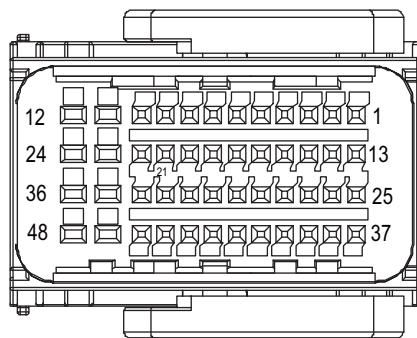

EB08

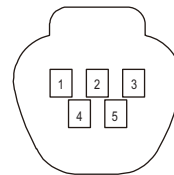

EK890153

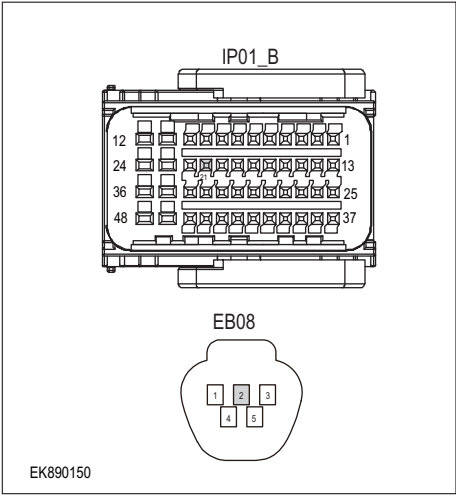
Troubleshooting steps	
Steps1	General inspection.
	<ol style="list-style-type: none"> 1 Check fuseU-FS7, relay U-R6、 U-R7 for damage. 2 Check battery capacity. 3 Check the harness plug of air conditioning control module for damage, poor contact, aging and looseness. 4 Check whether the result is normal or not?
	NO → Repair or replace the faulted parts.
YES ↓	
Steps2	Check fault codes.
	<ol style="list-style-type: none"> 1 Connect the fault diagnosis instrument to the diagnosis interface. 2 Turn the ignition switch to ON position. 3 Diagnosticsing BCM using a diagnostics. 4 If there is any fault code except for B1401-7?
	YES → Refer to: DTC Summary list(BCM)
NO ↓	
Steps3	Check BCM front wiper control line (open circuit)
	<ol style="list-style-type: none"> 1 Turn the ignition switch to OFF. 2 Disconnect BCM harness plug IP01 _ B 3 Disconnect the engine compartment fuse box harness plug EB01. 4 Disconnect the front wiper harness plug EB06. 5 Measure the voltage between BCM harness terminal and engine compartment fuse box harness terminal. Measuring circuit: resistance between No.13 terminal of IP01_B plug and No.145 of EB01 plug. Measuring circuit: resistance between No.31 terminal of IP01_B plug and No.150 of EB01 plug. Standard value: ≈ 0Ω 6 Measure the voltage between BCM harness terminal and front wiper harness terminal. Measuring circuit: resistance between No.21 terminal of IP01_B plug and No.2 of EB08 plug. Standard value: ≈ 0Ω Check whether the result is normal or not?
	1
	NO → Repair or replace the faulted parts.

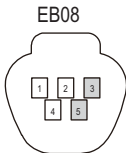
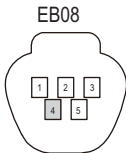
YES ↓	
Steps4	Check the front wiper battery voltage.
 <p>EK890151</p>	<ol style="list-style-type: none"> 1 Connect plug IP01_B of BCM harness. 2 Connect the engine compartment fuse box harness plug EB01. 3 Turn the ignition switch to ON. 4 Open the low gear and high gear of the front wiper. 5 Measure the voltage between the front wiper harness terminal and ground. Measuring circuit: voltage between terminal 3 of EB08 plug and ground. Measuring circuit: voltage between terminal 5 of EB08 plug and ground. Standard value:10~14V 6 Check whether the result is normal or not?
NO → Repair or replace the faulted parts.	
YES ↓	
Steps5	Check the front wiper ground circuit for an open circuit.
 <p>EK890152</p>	<ol style="list-style-type: none"> 1 Turn the ignition switch to OFF. 2 Disconnect the front wiper harness plug EB08. 3 Measure the resistance between front wiper harness plug and ground. Measuring circuit: resistance between terminal 4 of EB08 plug and ground. Standard value:< 1Ω 4 Test whether the resistance is less than 1Ω?
NO → Repair or replace the faulted parts.	
YES ↓	

Steps6	Install the front wiper in good condition.	
	<ol style="list-style-type: none"> 1 Follow the Steps in the maintenance manual and replace the electronic gear parts in good condition. 2 Reconnect all disconnected harness terminals. 3 Connect the fault diagnosis instrument to the diagnosis interface. 4 Turn the ignition switch to ON position. 5 Read the BCM Diagnostic Trouble Code (DTC) with a scan tool. 6 Clear the BCM diagnostic trouble code (DTC). 7 Turn the ignition switch to OFF. 8 Wait at least 15 seconds to allow the module to shut down correctly. 9 Turn the ignition switch to ON again. 10 Read the DTC again. 11 Does the fault code still exist? 	
		NO → Replace the front wiper.
YES ↓		
Steps7	Test whether BCM is norm.	
	<ol style="list-style-type: none"> 1 Turn the ignition switch to OFF. 2 Disconnect and check the harness plug IP01_A、IP01_B、IP01_C of BCM. 3 Check and repair. <ul style="list-style-type: none"> • Corrosion(install new adapting piece or terminal-cleaning module and pin). • Pin damaged or bent-install new terminal/pin. • Fly out of pins-install new pins as needed. 4 Reconnect the BCM plug and all other previously disconnected plug. Make sure the pin is properly positioned and fixed. 5 Run the system and determine if the problem persists? 	
		YES → Replace the BCM.
NO ↓		
At this point the system is functioning normally. The problem may be caused by module connections. Address the root cause of any connector or pin problems,		
Next Step ↓		
Diagnosis end.		

B1205-94

Fault diagnosis code
B1205-94: HAZARD_SW Sticky
Detection tools
1 Multimeter and diagnostic apparatus
Possible causes
<ul style="list-style-type: none"> • Lines, terminals or connectors • BCM • Danger warning light switch failure • Fuse failure
Conditions for fault code operation
Turn the ignition switch to ON position.
Conditions for fault code setting
B1205-94
To set the effect of a fault code condition
1
2
Description of circuit diagram
BCM monitors the hazard warning light switch through low reference circuit and signal circuit.

Circuit diagram

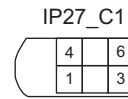
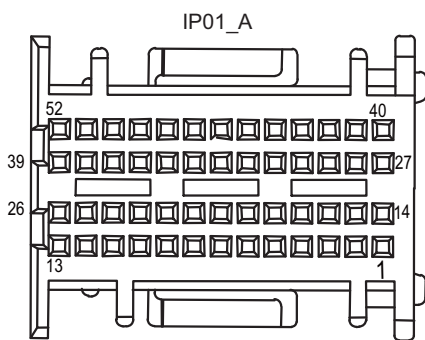
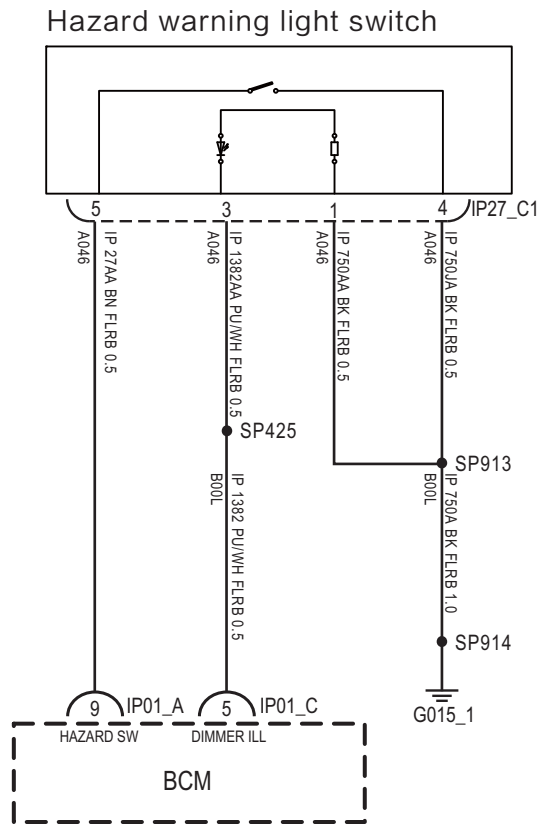

EK890100

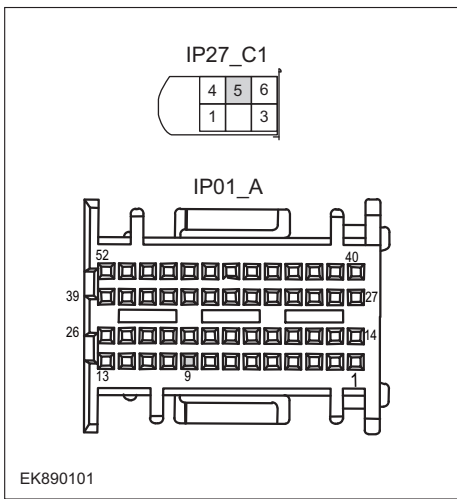
Troubleshooting steps	
Steps1	General inspection.
	<ol style="list-style-type: none"> 1 Check whether the fuse is damaged. 2 Check battery capacity. 3 Check the harness plug of air conditioning control module for damage, poor contact, aging and looseness. 4 Check whether the result is normal or not?
	NO → Repair or replace the faulted parts.
YES ↓	
Steps2	Check fault codes.
	<ol style="list-style-type: none"> 1 Connect the fault diagnosis instrument to the diagnosis interface. 2 Turn the ignition switch to ON position. 3 Diagnosticing BCM using a diagnostics. 4 If there is any fault code except for B1205-94?
	YES → Refer to: DTC Summary list(BCM)
NO ↓	
Steps3	Check hazard warning light switch and BCM circuit (open circuit).
 <p>EK890101</p>	<ol style="list-style-type: none"> 1 Turn the ignition switch to OFF. 2 Disconnect the plug IP01_A of BCM harness. 3 Disconnect the hazard warning lamp switch harness plug IP27_C1. 4 Measure the resistance between the hazard warning lamp switch harness terminal and BCM harness terminal. Measuring circuit: resistance between terminal 5 of IP27_C1 plug and terminal 9 of IP01_A plug. Standard value: $\approx 0\Omega$ 5 Check whether the result is normal or not?
	NO → Repair or replace the faulted parts.
YES ↓	

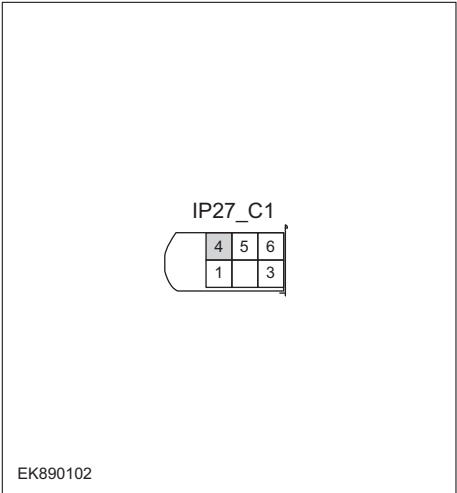
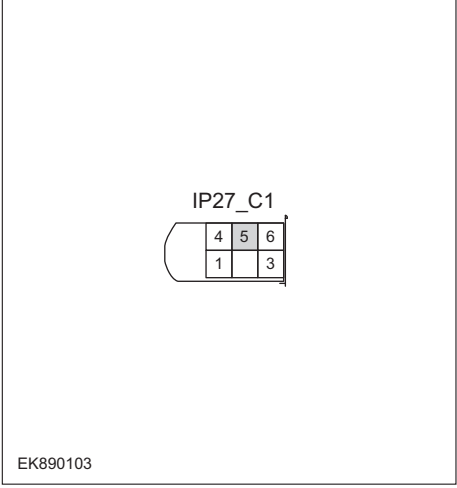
Steps5	Check the hazard lamp switch ground circuit for an open circuit.
	<ol style="list-style-type: none"> 1 Turn the ignition switch to OFF. 2 Measure the resistance between hazard warning lamp switch harness plug and ground. Measuring circuit: resistance between terminal 4 of IP27_C1 plug and ground. Standard value:< 1Ω 3 Test whether the resistance is less than 1Ω?
NO → Repair or replace the faulted parts.	
YES ↓	
Steps6	Check hazard warning lamp switch circuit (short circuit).
	<ol style="list-style-type: none"> 1 Turn the ignition switch to OFF. 2 Connect plug IP09_A of BCM harness. 3 Measure the resistance between hazard warning lamp switch harness plug and ground. Measuring circuit: resistance between terminal 5 of IP27_C1 plug and ground. Standard value:infinite 4 Measure voltage between hazard lamp switch harness plug and ground. Measuring circuit: voltage between terminal 5 of IP27_C1 plug and ground. Standard value: ≈ 0V 5 Check whether the result is normal or not?
NO → Repair or replace the faulted parts.	
YES ↓	

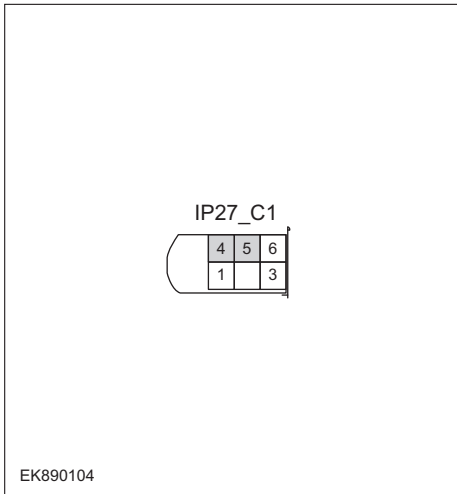
Steps7	Check the hazard warning light switch (component inspection).
	<ol style="list-style-type: none"> 1 Turn the ignition switch to OFF. 2 Put the hazard warning lamp switch in the "ON" state, and measure the resistance (switch terminal) between the hazard warning lamp switch terminals. Measuring circuit: resistance between terminal 4 and terminal 5 of IP27_C1 plug. Standard value: $\approx 0 \Omega$ 3 Turn the hazard warning lamp switch to the "OFF" state, and measure the resistance (switch terminal) between the hazard warning lamp switch terminals. Measuring circuit: resistance between terminal 4 and terminal 5 of IP27_C1 plug. Standard value: infinite 4 Check whether the result is normal or not?
<p>NO → Please replace the hazard warning light switch.</p>	
<p>YES ↓</p>	
Steps8	Test whether BCM is norm.
	<ol style="list-style-type: none"> 1 Turn the ignition switch to OFF. 2 Disconnect and check the harness plug IP01_A、IP01_B、IP01_C of BCM. 3 Check and repair. <ul style="list-style-type: none"> • Corrosion(install new adapting piece or terminal-cleaning module and pin). • Pin damaged or bent-install new terminal/pin. • Fly out of pins-install new pins as needed. 4 Reconnect the BCM plug and all other previously disconnected plug. Make sure the pin is properly positioned and fixed. 5 Run the system and determine if the problem persists?
<p>YES → Replace the BCM.</p>	
<p>NO ↓</p>	
<p>At this point the system is functioning normally. The problem may be caused by module connections. Address the root cause of any connector or pin problems,</p>	
<p>Next Step ↓</p>	
<p>Diagnosis end.</p>	

B1162-11、 B1162-13、 B1162-1E

Fault diagnosis code
B1162-11: SSW Circuit short to ground
B1162-13: SSW Circuit open circuit
B1162-1E: SSW Circuit resistance out of range
Detection tools
1 Multimeter and diagnostic apparatus
Possible causes
<ul style="list-style-type: none"> • Lines, terminals or connectors • BCM • Switch failure • Fuse failure
Conditions for fault code operation
Turn the ignition switch to ON position.
Conditions for fault code setting
B1162-11
B1162-13
B1162-1E
To set the effect of a fault code condition
1
2
Description of circuit diagram

Circuit diagram

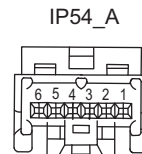
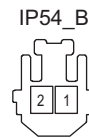
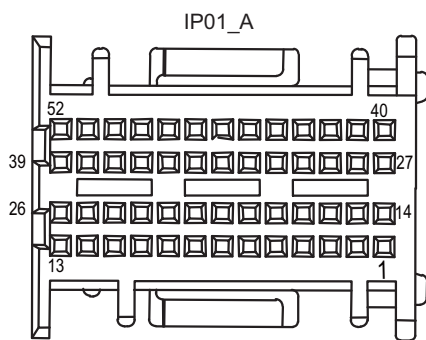
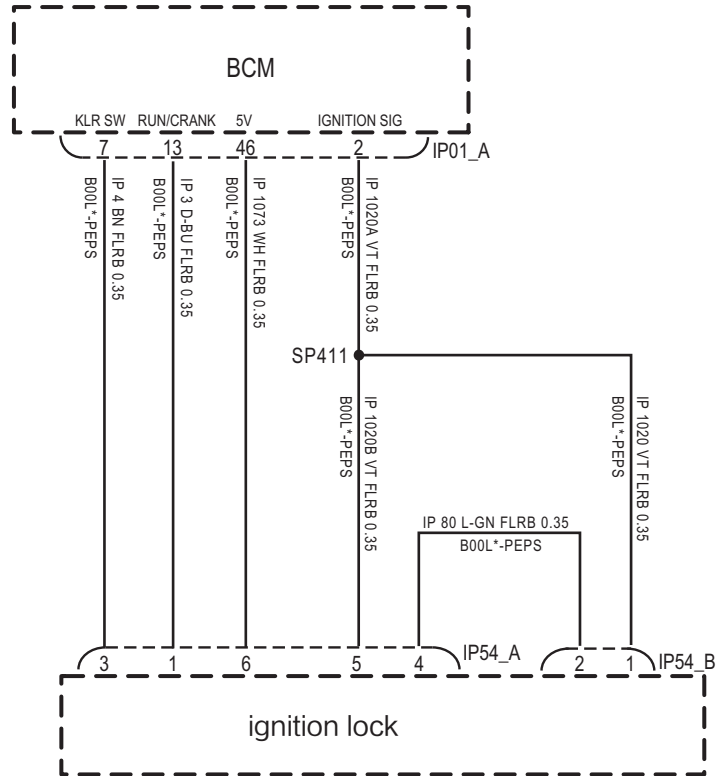

EK890105

Troubleshooting steps	
Steps1	General inspection.
	<ol style="list-style-type: none"> 1 Check whether the fuse is damaged. 2 Check battery capacity. 3 Check ignition switch and body control module wiring harness plug for damage, poor contact, aging and looseness. 4 Check whether the result is normal or not?
	NO → Repair or replace the faulted parts.
YES ↓	
Steps2	Check fault codes.
	<ol style="list-style-type: none"> 1 Connect the fault diagnosis instrument to the diagnosis interface. 2 Turn the ignition switch to ON position. 3 Diagnosticising BCM using a diagnostics. 4 If there is any fault code except for B1162-11、 B1162-13、 B1162-1E?
	YES → Refer to: DTC Summary list(BCM)
NO ↓	

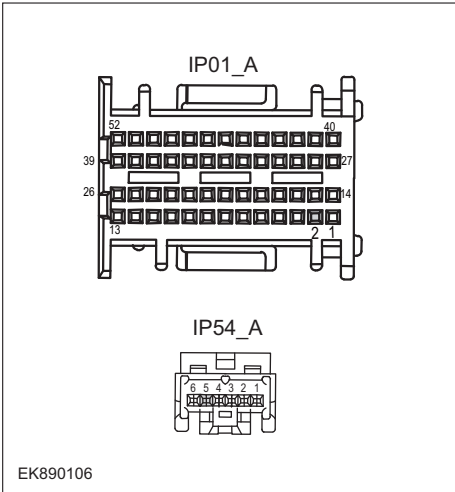
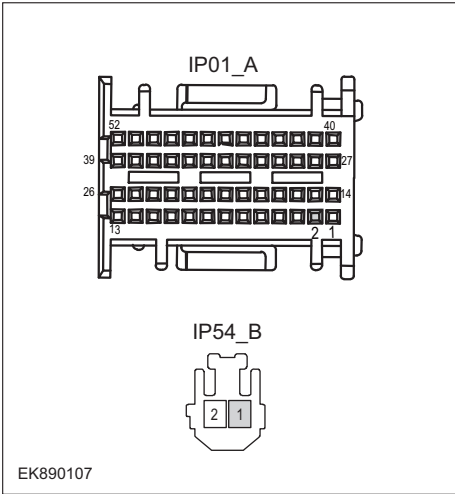
Steps3	Check ignition switch circuit (open circuit).
<div style="text-align: center;">  <p>EK890106</p> </div> <div style="text-align: center;">  <p>EK890107</p> </div>	<ol style="list-style-type: none"> 1 Turn the ignition switch to OFF. 2 Disconnect the plug IP01_A of BCM harness. 3 Disconnect plug IP54-A and IP54_B of ignition switch harness. 4 Measure the resistance between ignition switch harness terminal and BCM harness terminal. Measuring circuit: resistance between terminal 5 of IP54_A plug and terminal 2 of IP01_A header. Measuring circuit: resistance between terminal 1 of IP54_B plug and terminal 2 of IP01_A plug. Standard value: $\approx 0\Omega$ 5 Check whether the result is normal or not?
	<p>NO → Repair or replace the faulted parts.</p>
<p>YES ↓</p>	

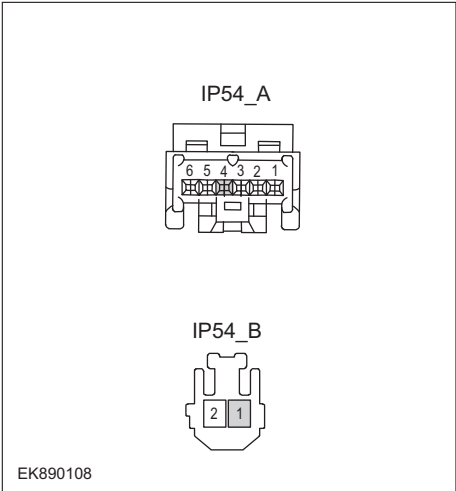
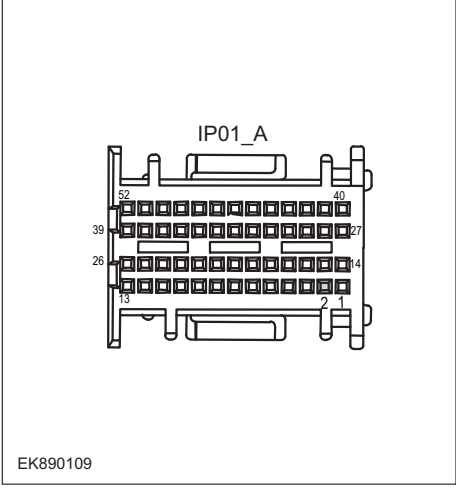
Steps4	Check ignition switch circuit (open circuit).
	<ol style="list-style-type: none"> 1 Turn the ignition switch to OFF. 2 Disconnect plug IP54-A and IP54_B of ignition switch harness. 3 Measure the resistance between ignition switch harness terminals. Measuring circuit: the resistance between No.4 terminal of IP54_A plug and No.2 terminal of IP54_B header. <p>Standard value: $\approx 0\Omega$</p> <ol style="list-style-type: none"> 4 Check whether the result is normal or not?
NO → Repair or replace the faulted parts.	
YES ↓	
Steps5	Check the BCM supply voltage.
	<ol style="list-style-type: none"> 1 Turn the ignition switch to ON. 2 Connect the plug IP0A_A of BCM harness. 3 Measure the voltage between BCM harness terminal and ground. Measuring circuit: voltage between terminal 2 of IP01_A plug and ground. <p>Standard value: 10~14V</p> <ol style="list-style-type: none"> 4 Check whether the result is normal or not?
NO → Repair or replace the faulted parts.	
YES ↓	

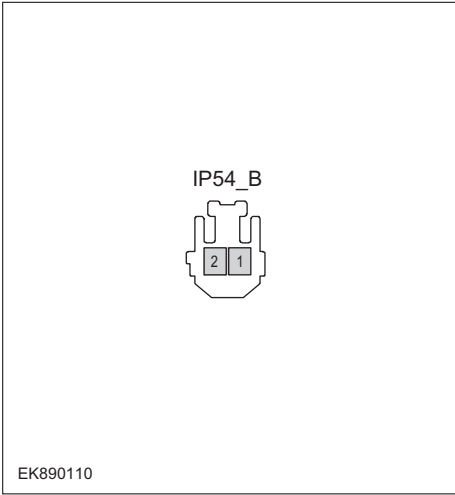
Steps6	Check the ignition switch (component inspection).
	<ol style="list-style-type: none"> 1 Turn the ignition switch to OFF. 2 Turn the ignition switch to the "ON" state and measure the resistance between the ignition switch terminals (switch terminals). Measuring circuit: resistance between terminal 1 of IP54_B plug and terminal 2 of IP54_B plug. Standard value: $\approx 0\Omega$ 3 Turn the ignition switch to the "OFF" state, and measure the resistance between the ignition switch terminals (switch terminals). Measuring circuit: resistance between terminal 1 of IP54_B plug and terminal 2 of IP54_B plug. Standard value: infinite <p>Check whether the result is normal or not?</p>
<p>NO → Repair or replace the faulted parts.</p>	
<p>YES ↓</p>	
Steps10	Test whether BCM is norm.
	<ol style="list-style-type: none"> 1 Turn the ignition switch to OFF. 2 Disconnect and check the harness plug IP01_A、IP01_B、IP01_C of BCM. 3 Check and repair. <ul style="list-style-type: none"> • Corrosion(install new adapting piece or terminal-cleaning module and pin). • Pin damaged or bent-install new terminal/pin. • Fly out of pins-install new pins as needed. 4 Reconnect the BCM plug and all other previously disconnected plug. Make sure the pin is properly positioned and fixed. 5 Run the system and determine if the problem persists?
<p>YES → Replace the BCM.</p>	
<p>NO ↓</p>	
<p>At this point the system is functioning normally. The problem may be caused by module connections. Address the root cause of any connector or pin problems,</p>	
<p>Next Step ↓</p>	
<p>Diagnosis end.</p>	

U0156-87

Fault diagnosis code
U0156-87: Missing message
Detection tools
1 Multimeter and diagnostic apparatus
Possible causes
<ul style="list-style-type: none"> • Lines, terminals or connectors • BCM • Fuse failure
Conditions for fault code operation
Turn the ignition switch to ON position.
Conditions for fault code setting
U0156-87
To set the effect of a fault code condition
1
2
Description of circuit diagram

Circuit diagram

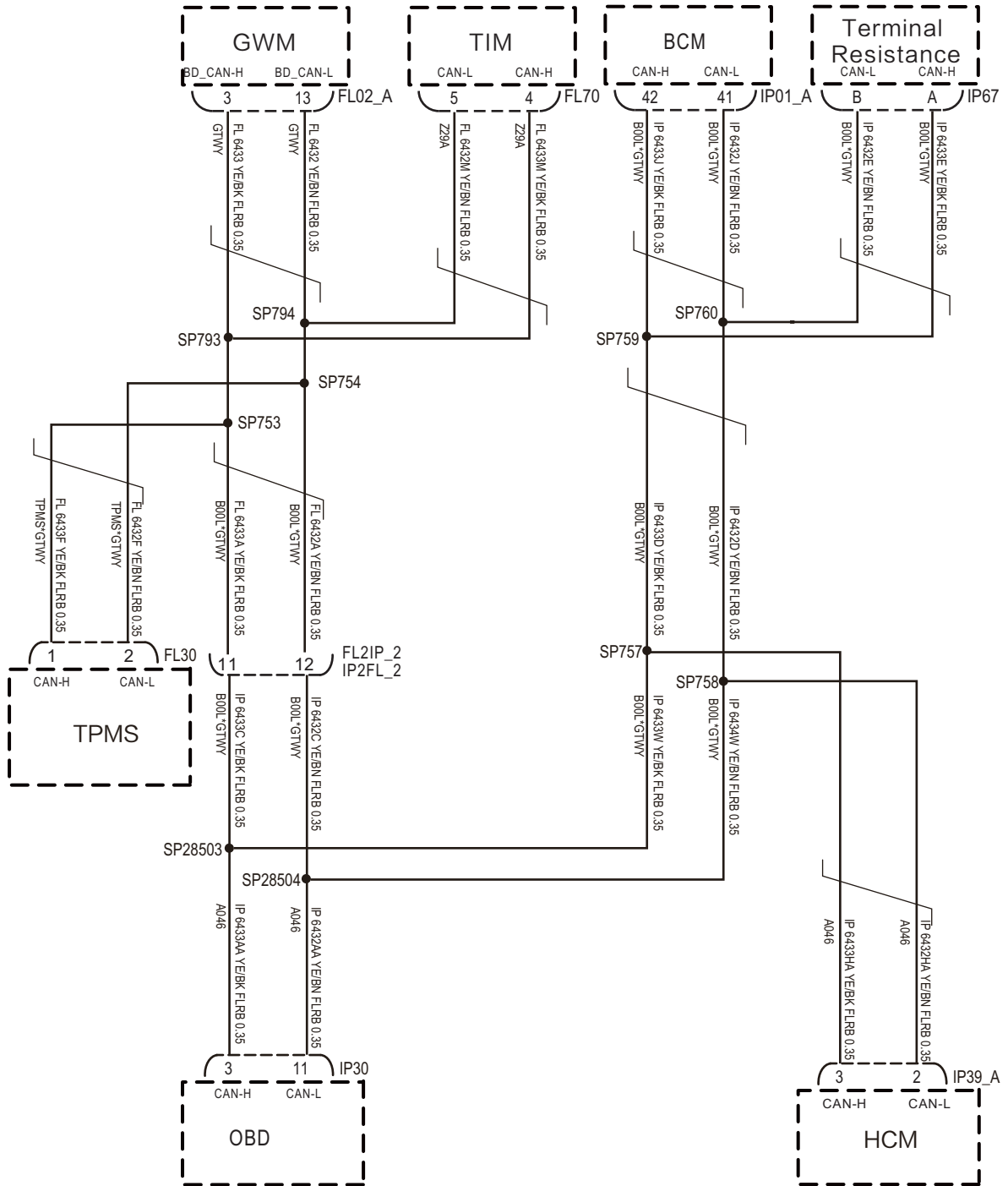

EK890111

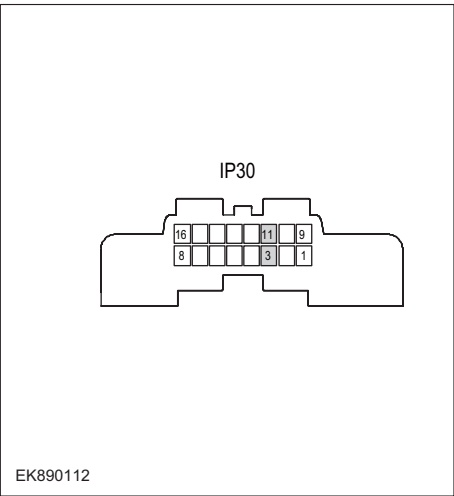
Troubleshooting steps	
Steps1	General inspection.
	<ol style="list-style-type: none"> 1 Check whether the fuse is damaged. 2 Check battery capacity. 3 Check the harness plug of air conditioning control module for damage, poor contact, aging and looseness. 4 Check whether the result is normal or not?
NO → Repair or replace the faulted parts.	
YES ↓	
Steps2	Check fault codes.
	<ol style="list-style-type: none"> 1 Connect the fault diagnosis instrument to the diagnosis interface. 2 Turn the ignition switch to ON position. 3 Diagnosticsing BCM using a diagnostics. 4 If there is any fault code except for U0156-87?
YES → Refer to: DTC Summary list(BCM)	
NO ↓	
Steps3	Inspection for CAN communication network completeness.
 <p style="text-align: center;">IP30</p> <p style="text-align: center;">EK890112</p>	<ol style="list-style-type: none"> 1 Turn the ignition switch to OFF. 2 Measure the resistance between the harness terminals of diagnose interface <p>Measuring circuit: the resistance between terminal 3 and 11 on plug IP28.</p> <p>Standard value: $\approx 60\Omega$</p> <p>Check whether the result is normal or not</p>
NO → Repair or replace the faulted parts.	
YES ↓	

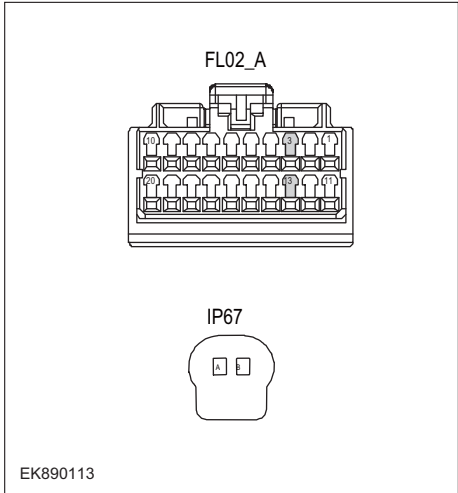
Steps4	Check the gateway module and terminal resistance.
	<ol style="list-style-type: none"> 1 Turn the ignition switch to ON. 2 Disconnect the gateway module harness plug FL02_A. 3 Measure the resistance between the gateway module harness terminals. Measuring circuit: resistance between terminal 3 and terminal 13 of FL02_A plug. Standard value:110~130Ω 4 Connect the gateway module harness plug FL02_A. 5 Disconnect terminal resistance harness plug IP67. 6 Measure the resistance between terminal resistance harness terminals. Measuring circuit: resistance between terminal A and terminal B of IP67_A plug. Standard value:110~130Ω 7 Check whether the result is normal or not?
<p>NO → Repair or replace the faulted parts.</p>	
<p>YES ↓</p>	
Steps5	Test whether BCM is norm.
	<ol style="list-style-type: none"> 1 Turn the ignition switch to OFF. 2 Disconnect and check the harness plug IP01_A, IP01_B, IP01_C of BCM. 3 Check and repair. <ul style="list-style-type: none"> • Corrosion(install new adapting piece or terminal-cleaning module and pin). • Pin damaged or bent-install new terminal/pin. • Fly out of pins-install new pins as needed. 4 Reconnect the BCM plug and all other previously disconnected plug. Make sure the pin is properly positioned and fixed. 5 Run the system and determine if the problem persists?
<p>YES → Replace the BCM.</p>	
<p>NO ↓</p>	
<p>At this point the system is functioning normally. The problem may be caused by module connections. Address the root cause of any connector or pin problems,</p>	
<p>Next Step ↓</p>	
<p>Diagnosis end.</p>	

B1166-11、 B1167-11、 B1168-12

Fault diagnosis code
B1166-11: Circuit short to ground
B1167-11: Circuit short to ground
B1168-12: Circuit short to battery
Detection tools
1 Multimeter and diagnostic apparatus
Possible causes
<ul style="list-style-type: none"> • Lines, terminals or connectors • BCM • Ignition switch module failure. • Fuse failure
Conditions for fault code operation
Turn the ignition switch to ON position.
Conditions for fault code setting
B1166-11
B1167-11
B1168-12
To set the effect of a fault code condition
1
2
Description of circuit diagram

Circuit diagram

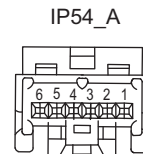
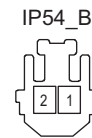
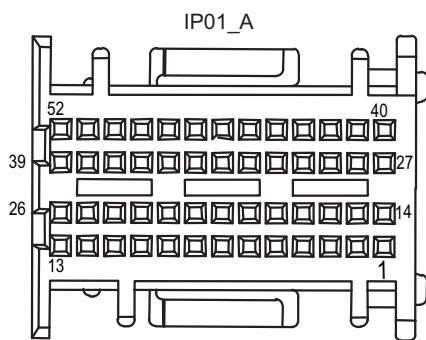
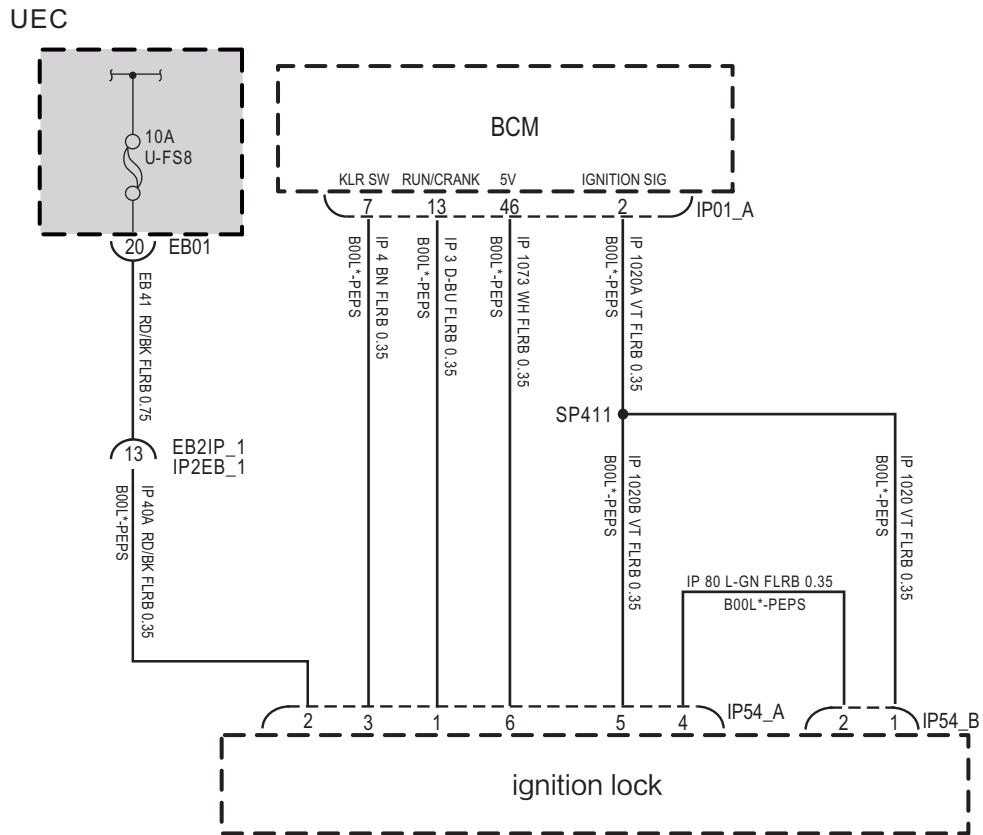

EK890114

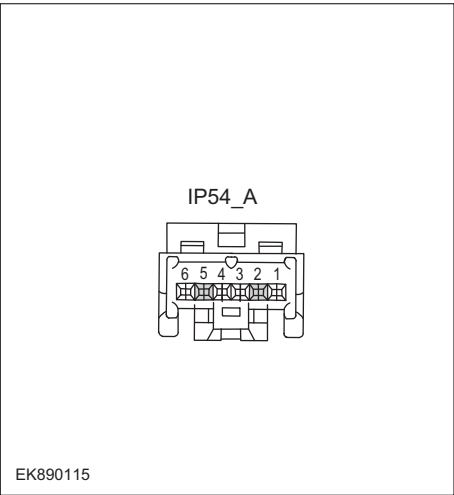
Troubleshooting steps	
Steps1	General inspection.
	<ol style="list-style-type: none"> 1 Check fuseU-FS8 for damage. 2 Check battery capacity. 1 Check the ignition switch module and BCM harness plug for damage, poor contact, aging and looseness. 2 Check whether the result is normal or not?
NO → Repair or replace the faulted parts.	
YES ↓	
Steps2	Check fault codes.
	<ol style="list-style-type: none"> 1 Connect the fault diagnosis instrument to the diagnosis interface. 2 Turn the ignition switch to ON position. 3 Diagnose BCM with diagnostic instrument. 4 If there is any fault code except for B1166-11、 B1167-11、 B11168-12?
YES → Refer to: DTC Summary list(BCM)	
NO ↓	
Steps3	Check the battery supply voltage of the ignition switch.
	<ol style="list-style-type: none"> 1 Turn the ignition switch to OFF. 2 Disconnect plug IP54_A of ignition switch harness. 3 Measure the voltage between ignition switch harness terminal and ground. Measuring circuit: voltage between terminal 2 of IP54_A plug and ground. Standard value:10~14V 4 Check whether the result is normal or not?
NO → Repair or replace the faulted parts.	
YES ↓	

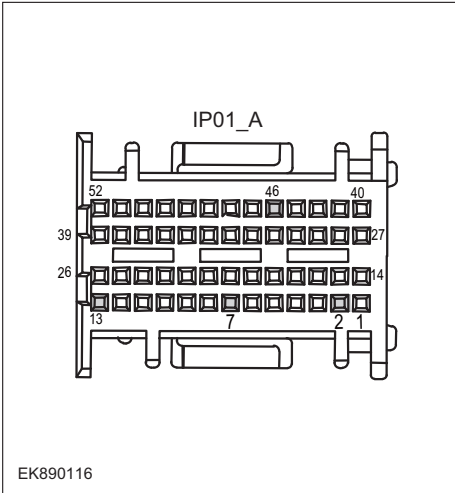
Steps4	Check ignition switch circuit (BCM terminal) (short circuit).
 <p>EK890116</p>	<ol style="list-style-type: none"> 1 Connect plug IP54_A and IP54_B of ignition switch harness. 2 Turn the ignition switch to OFF. 3 Disconnect the plug IP01_A of BCM harness. 4 Measure the resistance between BCM harness plug and ground. <ul style="list-style-type: none"> Measuring circuit: resistance between terminal 2 of IP01_A plug and ground. Measuring circuit: resistance between terminal 7 of IP01_A plug and ground. Measuring circuit: resistance between terminal 13 of IP01_A plug and ground. Measuring circuit: resistance between No.46 terminal of IP01_A plug and ground. <p>Standard value: infinite</p> 5 Measure the voltage between BCM harness plug and ground. <ul style="list-style-type: none"> Measuring circuit: voltage between terminal 2 of IP01_A plug and ground. Measuring circuit: voltage between terminal 7 of IP01_A plug and ground. Measuring circuit: voltage between terminal 13 of IP01_A plug and ground. Measuring circuit: voltage between No.46 terminal of IP01_A plug and ground. <p>Standard value: ≈ 0V</p> 6 Check whether the result is normal or not?
	<p>NO → Repair or replace the faulted parts.</p>
<p>YES ↓</p>	

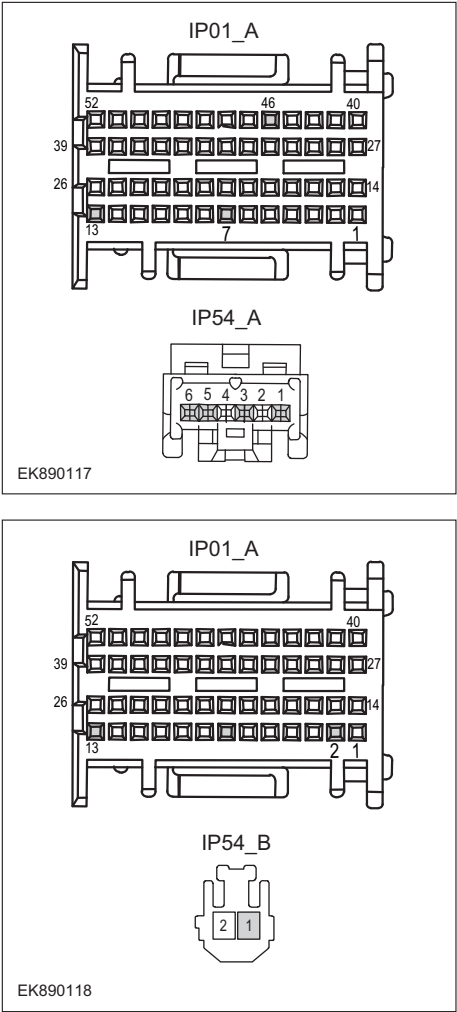
Steps5	Check the circuit between ignition switch and BCM (open circuit).
 <p>IP01_A</p> <p>IP54_A</p> <p>EK890117</p> <p>IP01_A</p> <p>IP54_B</p> <p>EK890118</p>	<ol style="list-style-type: none"> 1 Turn the ignition switch to OFF. 2 Disconnect the ignition switch harness plugs IP54_A and ip54 _ B. 3 Measure the resistance between ignition switch harness terminal and BCM harness terminal. <p>Measuring circuit: resistance between terminal 1 of IP54_A plug and terminal 13 of IP01_A plug.</p> <p>Measuring circuit: resistance between terminal 3 of IP54_A plug and terminal 7 of IP01_A plug.</p> <p>Measuring circuit: resistance between terminal 5 of IP54_A plug and terminal 2 of IP01_A plug.</p> <p>Measuring circuit: resistance between No.6 terminal of IP54_A plug and No.46 terminal of IP01_A plug.</p> <p>Measuring circuit: resistance between terminal 1 of IP54_B plug and terminal 2 of IP09_A plug.</p> <p>Standard value: $\approx 0\Omega$</p> 4 Check whether the result is normal or not?
NO → Repair or replace the faulted parts.	
YES ↓	
Steps6	Check whether BCM is abnormal.
	<ol style="list-style-type: none"> 1 Turn the ignition switch to OFF. 2 Disconnect and check the harness plug IP01_A, IP01_B、 IP01_C of BCM. 3 Check and repair. <ul style="list-style-type: none"> • Corrosion(install new adapting piece or terminal-cleaning module and pin). • Pin damaged or bent-install new terminal/pin. • Fly out of pins-install new pins as needed. 4 Reconnect the BCM plug and all other previously disconnected plugs. Make sure that the pins are properly positioned and fixed. 5 Run the system and determine if the problem persists?
YES → Replace BCM.	

NO ↓
At this point the system is functioning normally. The problem may be caused by module connections. Address the root cause of any connector or pin problems,
Next Step ↓
Diagnosis end.

B1169-11、 B1169-13、 B1120-1E

Fault diagnosis code
B1169-11: Gear Shift input Circuit short to ground
B1169-13: Gear Shift input Circuit open circuit
B1169-1E: Gear Shift input resistance out of range
Detection tools
1 Multimeter and diagnostic apparatus
Possible causes
<ul style="list-style-type: none"> • Lines, terminals or connectors • BCM • Shifter malfunction • Fuse failure
Conditions for fault code operation
Turn the ignition switch to ON position.
Conditions for fault code setting
B1169-11
B1169-13
B1169-1E
To set the effect of a fault code condition
1
2
Description of circuit diagram

Circuit diagram

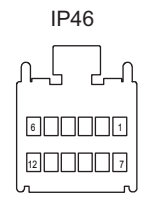
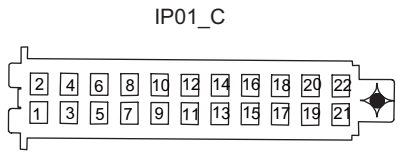
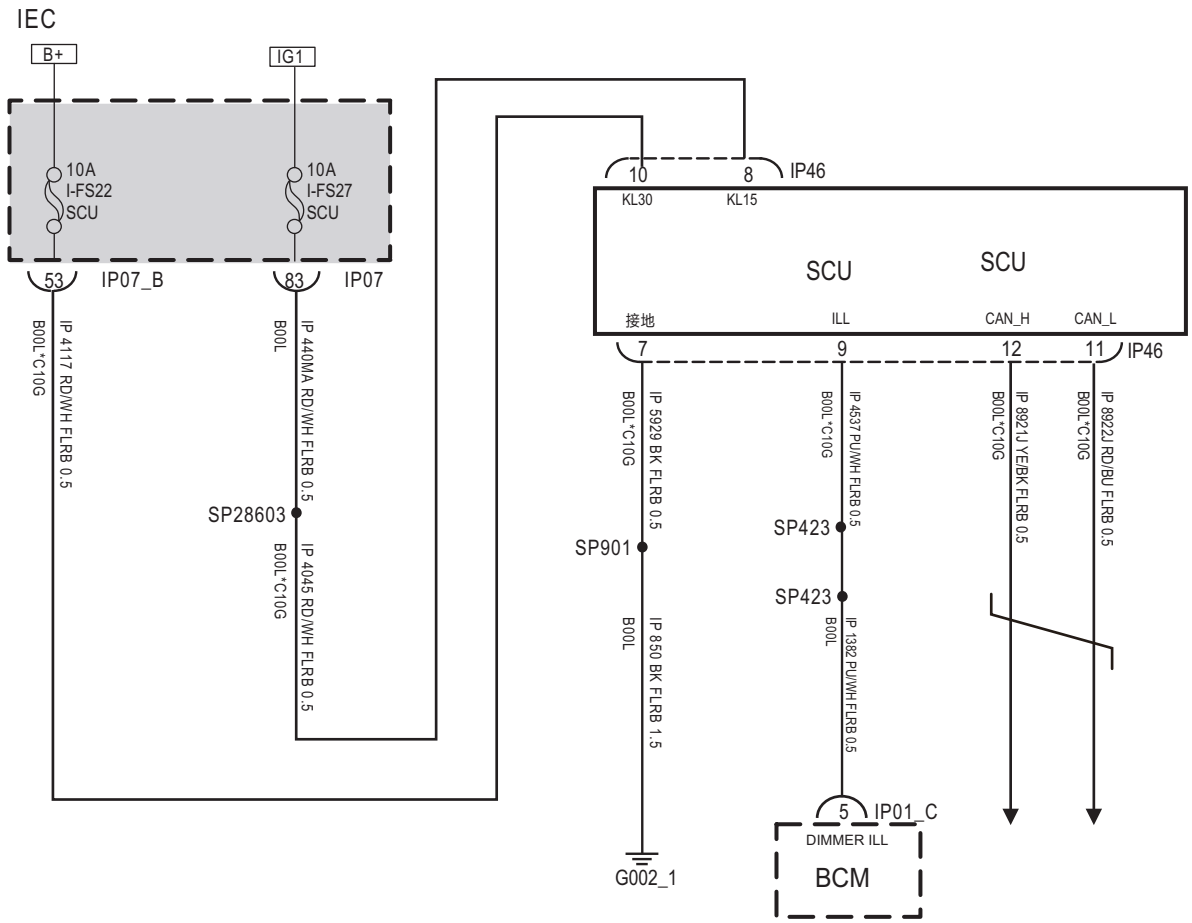

EK890119

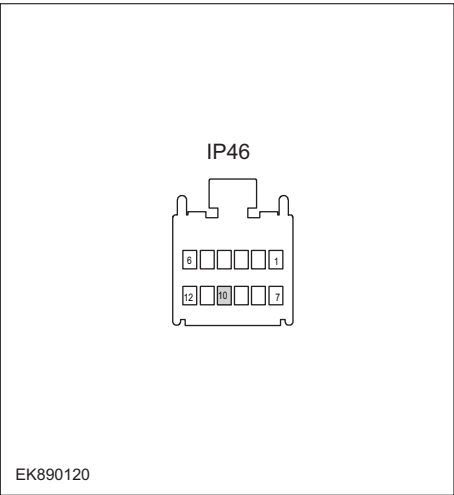
Troubleshooting steps	
Steps1	General inspection.
	<ol style="list-style-type: none"> 1 Check fuseI-FS22、 I-FS27 for damage. 2 Check battery capacity. 3 Check the electronic gear and BCM harness plugs for damage, poor contact, aging, and looseness. 4 Check whether the result is normal or not?
NO → Repair or replace the faulted parts.	
YES ↓	
Steps2	Check fault codes.
	<ol style="list-style-type: none"> 1 Connect the fault diagnosis instrument to the diagnosis interface. 2 Turn the ignition switch to ON position. 3 Diagnose BCM with diagnostic instrument. 4 If there is any fault code except for B1169-11、 B1169-13、 B1120-1E?
YES → Refer to: DTC Summary list(BCM)	
NO ↓	
Steps3	Check the power supply voltage of electronic shift battery.
	<ol style="list-style-type: none"> 1 Turn the ignition switch to OFF. 2 Disconnect the electronic gear harness plug IP46. 3 Measure the voltage between electronic gear harness terminal and ground. Measuring circuit: voltage between terminal 10 of IP46 plug and ground. Standard value:10~14V 4 Check whether the result is normal or not?
NO → Repair or replace the faulted parts.	
YES ↓	

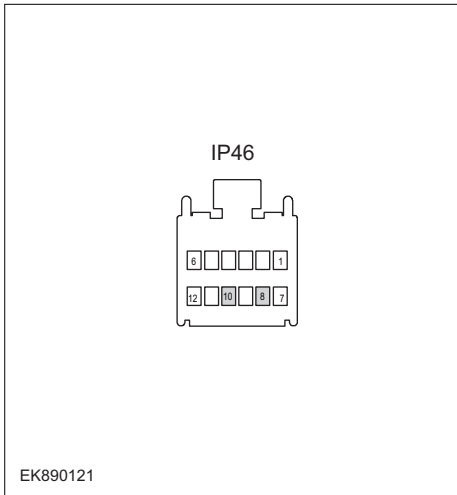
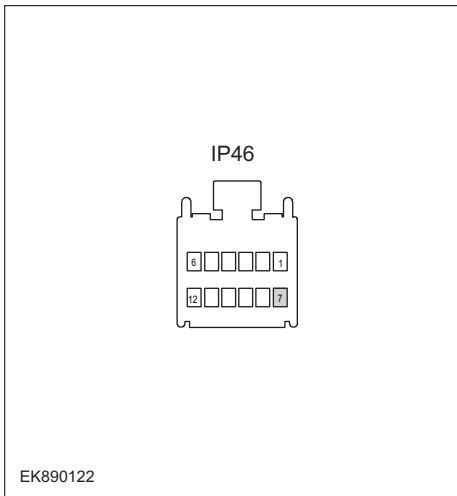
Steps4	Check the power supply voltage under the starting or running state of electronic gear.
 <p style="text-align: center;">IP46</p> <p style="text-align: center;">EK890121</p>	<ol style="list-style-type: none"> 1 Turn the ignition switch to ON. 2 Measure the voltage between electronic gear harness terminal and ground. Measuring circuit: voltage between terminal 8 of IP46 plug and ground. Measuring circuit: voltage between terminal 10 of IP46 plug and ground. Standard value:10~14V 3 Check whether the result is normal or not?
NO → Repair or replace the faulted parts.	
YES ↓	
Steps5	Check the electronic gear ground circuit for an open circuit.
 <p style="text-align: center;">IP46</p> <p style="text-align: center;">EK890122</p>	<ol style="list-style-type: none"> 1 Turn the ignition switch to OFF. 2 Measure the resistance between electronic gear harness plug and ground. Measuring circuit: resistance between terminal 7 of IP46 plug and ground. Standard value:< 1Ω 3 Test whether the resistance is less than 1Ω?
NO → Repair or replace the faulted parts.	
YES ↓	

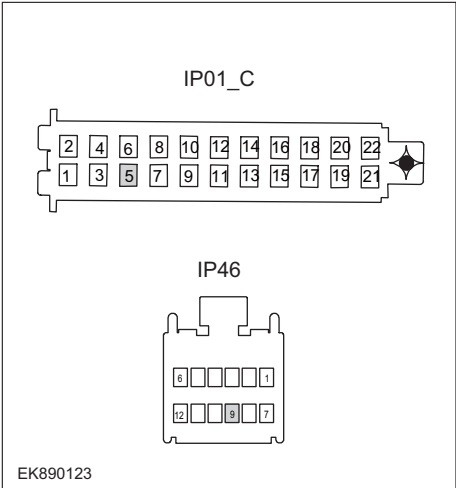
Steps6	Check the communication circuit between electronic gear and BCM (open circuit).
	<ol style="list-style-type: none"> 1 Turn the ignition switch to OFF. 2 Disconnect plug IP01_C of BCM harness. 3 Measure the resistance between electronic gear harness terminal and BCM harness terminal. Measuring circuit: resistance between terminal 9 of IP46 plug and terminal 5 of IP01_C plug. Standard value: $\approx 0\Omega$ 4 Check whether the result is normal or not?

NO → Repair or replace the faulted parts.

YES ↓

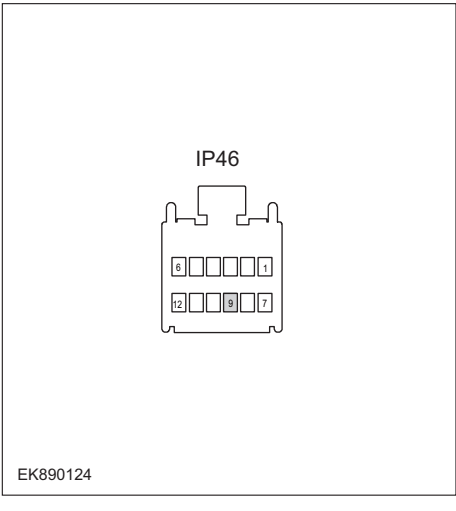
Steps7	Check communication circuit (short circuit) between electronic gear and BCM.
	<ol style="list-style-type: none"> 1 Turn the ignition switch to OFF. 2 Measure the resistance between electronic gear harness plug and ground. Measuring circuit: resistance between terminal 9 of IP46 plug and ground. Standard value: infinite 3 Measure the voltage between electronic gear harness plug and ground. Measuring circuit: voltage between terminal 9 of IP46 plug and ground. Standard value: $\approx 0V$ 4 Check whether the result is normal or not?

NO → Repair or replace the faulted parts.

YES ↓

Steps8	Replace the electronic gear parts in good condition.
	<ol style="list-style-type: none"> 1 Follow the Steps in the maintenance manual and replace the electronic gear parts in good condition. 2 Reconnect all disconnected harness terminals. 3 Connect the fault diagnosis instrument to the diagnosis interface. 4 Turn the ignition switch to ON position. 5 Read the BCM Diagnostic Trouble Code (DTC) with a scan tool. 6 Clear the BCM diagnostic trouble code (DTC). 7 Turn the ignition switch to OFF. 8 Wait at least 15 seconds to allow the module to shut down correctly. 9 Turn the ignition switch to ON again.. 10 Read the DTC again. 11 Does the fault code still exist?
NO → Replace the electronic gear.	
YES ↓	
Steps9	Check whether BCM is abnormal.
	<ol style="list-style-type: none"> 1 Turn the ignition switch to OFF. 2 Disconnect and check the connectors IP01_A, IP01_B and IP01_C of BCM harness. 3 Check and repair. <ul style="list-style-type: none"> • Corrosion(install new adapting piece or terminal-cleaning module and pin). • Pin damaged or bent-install new terminal/pin. • Fly out of pins-install new pins as needed. 4 Reconnect the BCM plug and all other previously disconnected plugs. Make sure that the pins are properly positioned and fixed. 5 Run the system and determine if the problem persists?
YES → Replace BCM.	
NO ↓	
At this point the system is functioning normally. The problem may be caused by module connections. Address the root cause of any connector or pin problems,	
Next Step ↓	
Diagnosis end.	

B1206-94

Fault diagnosis code
B1206-94: The overtaking light switch is sticky
Detection tools
1 Multimeter and diagnostic apparatus
Possible causes
<ul style="list-style-type: none"> • Lines, terminals or connectors • BCM • Left combination switch • Fuse failure
Conditions for fault code operation
Turn the ignition switch to ON position.
Conditions for fault code setting
B1206-94
To set the effect of a fault code condition
1
2
Description of circuit diagram

Circuit diagram

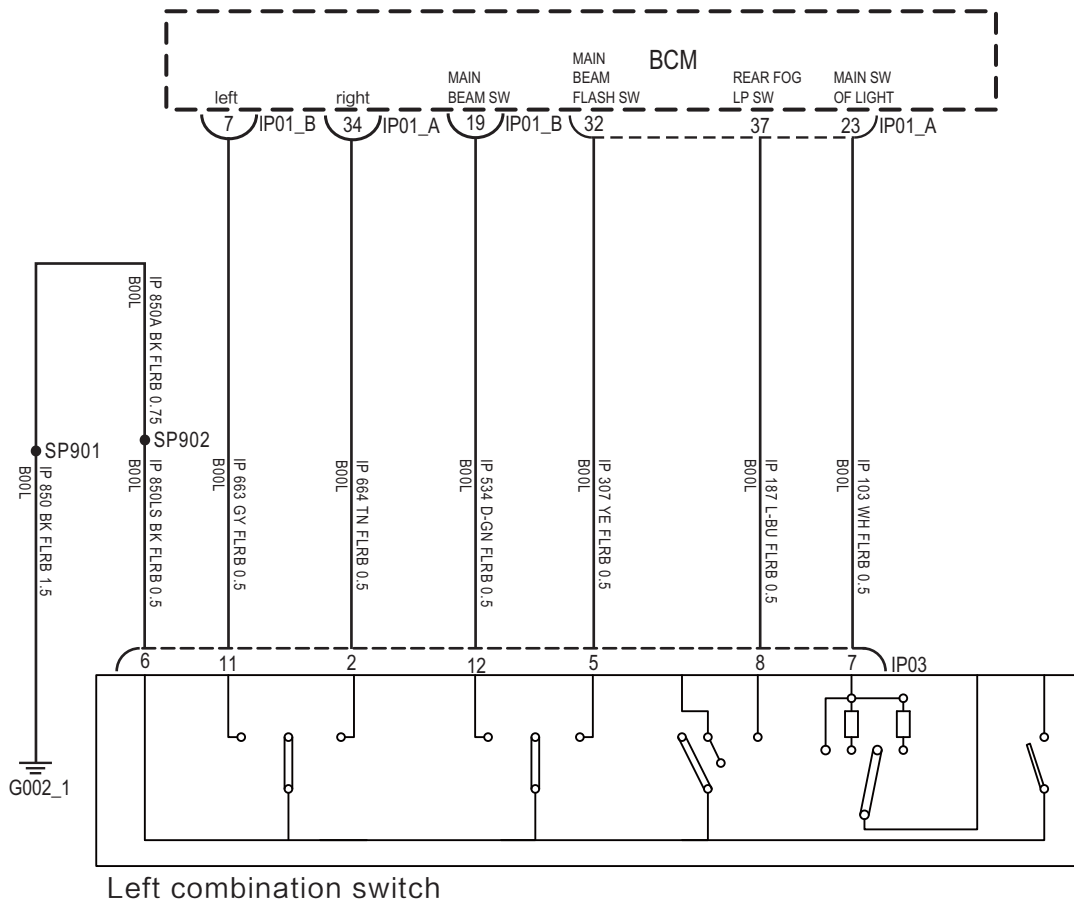

Left combination switch

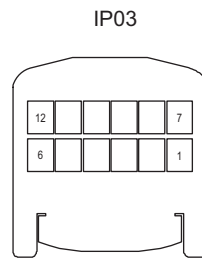
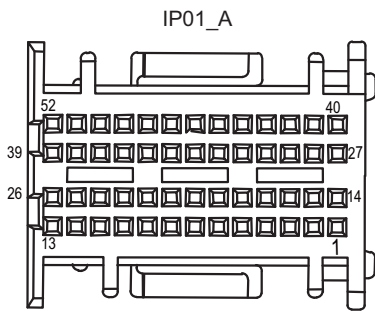

EK890125

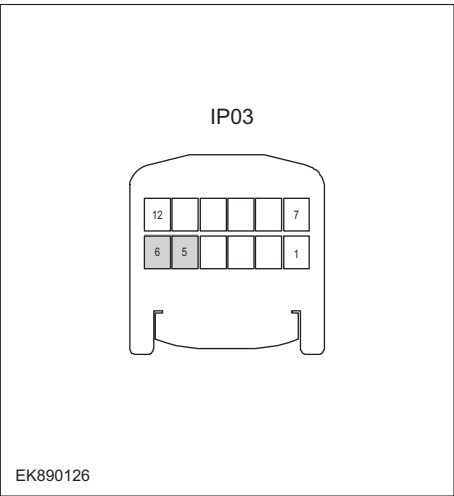
Troubleshooting steps	
Steps1	General inspection.
	<ol style="list-style-type: none"> 1 Check whether the fuse is damaged. 2 Check battery capacity. 3 Check the harness plug of air conditioning control module for damage, poor contact, aging and looseness. 4 Check whether the result is normal or not?
NO → Repair or replace the faulted parts.	
YES ↓	
Steps2	Check fault codes.
	<ol style="list-style-type: none"> 1 Connect the fault diagnosis instrument to the diagnosis interface. 2 Turn the ignition switch to ON position. 3 Diagnosticsing BCM using a diagnostics. 4 If there is any fault code except for B1206-94?
YES → Refer to: DTC Summary list(BCM)	
NO ↓	
Steps3	Check the combination light switch (overtaking light) (component inspection).
 <p style="text-align: center;">IP03</p> <p style="text-align: center;">EK890126</p>	<ol style="list-style-type: none"> 1 Turn the ignition switch to OFF. 2 Disconnect the combination light switch harness plug IP03. 3 Place the combination light switch in the "overtaking light" position and measure the resistance between the terminals of the combination light switch (combination switch terminal). Measuring circuit: The resistance between terminal 5 and terminal 6 of IP03 plug. Standard value: ≈ 0Ω 4 Check whether the result is normal or not?
NO → Please replace the combination light switch.	
YES ↓	

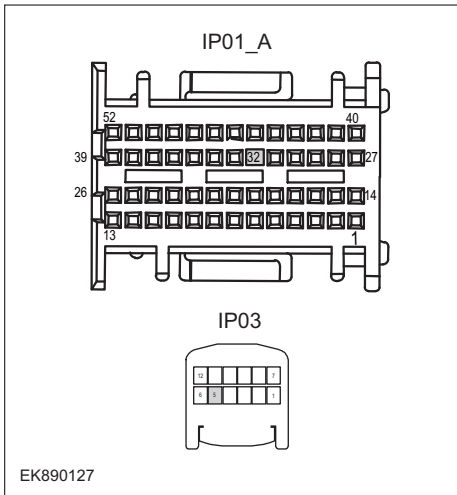
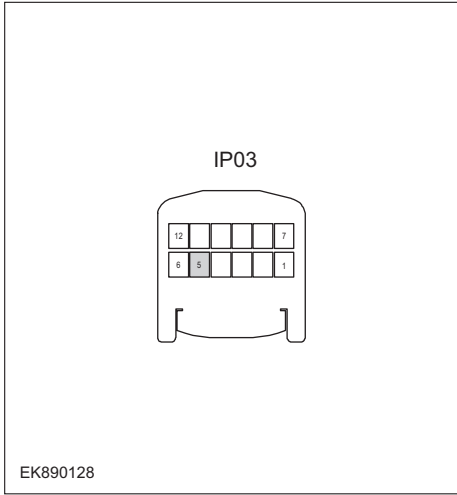
Steps4	Check the combination light switch and BCM circuit (open circuit).
	<ol style="list-style-type: none"> 1 Turn the ignition switch to OFF. 2 Disconnect the plug IP01_A of BCM harness. 3 Disconnect the combination light switch harness plug IP03. 4 Measure the resistance between the combination light switch harness terminal and the BCM harness terminal. Measuring circuit: IP03 plug terminal 5 and IP01_ The resistance between terminal 32 of plug A. Standard value: $\approx 0\Omega$ 5 Check whether the result is normal or not?
NO → Repair or replace the faulted parts.	
YES ↓	
Steps5	Check the combined light switch circuit (short circuit).
	<ol style="list-style-type: none"> 1 Turn the ignition switch to OFF. 2 Connect BCM harness plug IP01_A. 3 Measure the resistance between the harness plug of the combination light switch and ground. Measuring circuit: The resistance between terminal 5 of IP03 plug and the grounding. Standard value: infinite 4 Measure the voltage between the harness plug of the combination light switch and ground. Measuring circuit: The voltage between terminal 5 of IP03 plug and the grounding. Standard value: $\approx 0V$ 5 Check whether the result is normal or not?
NO → Repair or replace the faulted parts.	
YES ↓	

BCM

Steps6	Test whether BCM is norm.
	<ol style="list-style-type: none"> 1 Turn the ignition switch to OFF. 2 Disconnect and check the harness plug IP01_A、IP01_B、 IP01_C of BCM. 3 Check and repair. <ul style="list-style-type: none"> • Corrosion(install new adapting piece or terminal-cleaning module and pin). • Pin damaged or bent-install new terminal/pin. • Fly out of pins-install new pins as needed. 4 Reconnect the BCM plug and all other previously disconnected plug. Make sure the pin is properly positioned and fixed. 5 Run the system and determine if the problem persists?
	YES → Replace the BCM.
NO ↓	
At this point the system is functioning normally. The problem may be caused by module connections. Address the root cause of any connector or pin problems,	
Next Step ↓	
Diagnosis end.	

B1170-11、 B1170-12、 B1175-11、 B1175-12

Fault diagnosis code
B1170-11: Brake SW input Circuit short to ground
B1170-12: Brake SW input short to battery
B1175-11: 5V_VCC_OUTPUT short to ground (J2-05, Medium low, low configuration)
B1175-12: 5V short to battery (J2-05, Medium low, low configuration)
Detection tools
1 Multimeter and diagnostic apparatus
Possible causes
<ul style="list-style-type: none"> • Lines, terminals or connectors • BCM • Brake pedal sensor malfunction • Fuse failure
Conditions for fault code operation
Turn the ignition switch to ON position.
Conditions for fault code setting
B1170-11
B1170-12
B1175-11
B1175-12
To set the effect of a fault code condition
1
2
Description of circuit diagram

Circuit diagram

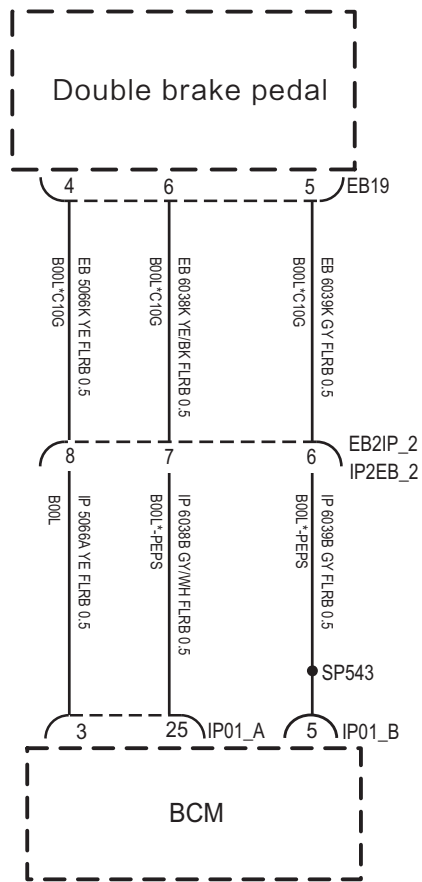

IP01_A

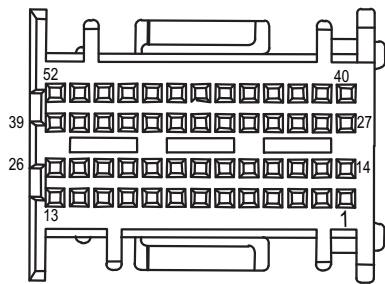

IP01_B

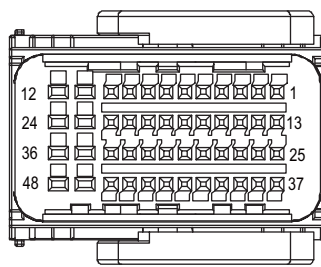

EK890129

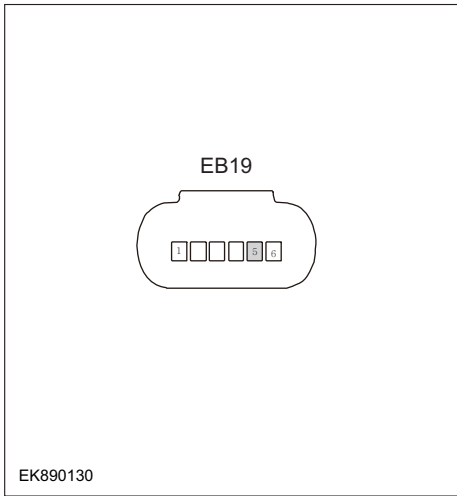
Troubleshooting steps	
Steps1	General inspection.
	<ol style="list-style-type: none"> 1 Check whether the fuse is damaged. 2 Check battery capacity. 3 Check the harness plug of air conditioning control module for damage, poor contact, aging and looseness. 4 Check whether the result is normal or not?
	NO → Repair or replace the faulted parts.
YES ↓	
Steps2	Check fault codes.
	<ol style="list-style-type: none"> 1 Connect the fault diagnosis instrument to the diagnosis interface. 2 Turn the ignition switch to ON position. 3 Diagnosticsing BCM using a diagnostics. 4 If there is any fault code except for B1170-11、B1170-12?
	YES → Refer to: DTC Summary list(BCM)
NO ↓	
Steps3	Check the power supply circuit of the brake pedal sensor circuit.
	<ol style="list-style-type: none"> 1 Turn the ignition switch to OFF. 2 Disconnect the brake pedal sensor harness plug EB19. 3 Turn the ignition switch to ON. 4 Measure the voltage between the harness terminal of the brake pedal sensor and ground. Measuring circuit: The voltage between terminal 4 of EB19 plug and the grounding. Standard value:4.8~5.2V 5 Check whether the result is normal or not?
	NO → Repair or replace the faulted parts.
YES ↓	

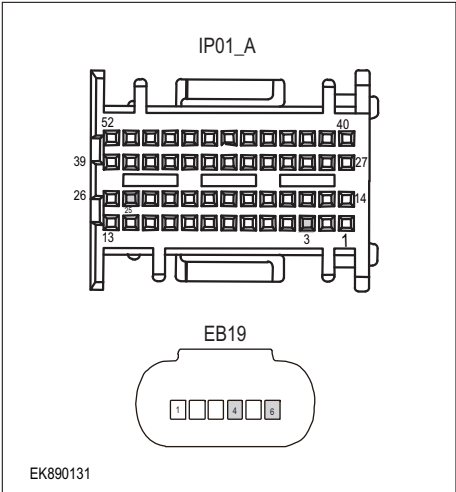
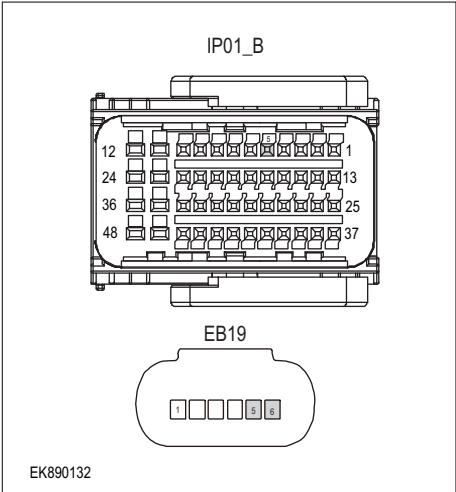
Steps4	Check the brake pedal sensor and BCM circuit (open circuit).
 	<ol style="list-style-type: none"> 1 Turn the ignition switch to OFF. 2 Disconnect the BCM harness plug IP01_ A、 IP01_ B. 3 Open the brake pedal sensor harness plug EB19. 4 Measure the resistance between the brake pedal sensor harness terminal and the BCM harness terminal. Measuring circuit: EB19 plug terminal 4 and IP01_ The resistance between terminal 3 of plug A. Measuring circuit: EB19 plug terminal 5 and IP01_ The resistance between terminal 5 of plug B. Measuring circuit: EB19 plug terminal 6 and IP01_ The resistance between terminal 25 of plug A. Standard value: $\approx 0\Omega$ 5 Check whether the result is normal or not?
<p>NO → Repair or replace the faulted parts.</p>	
<p>YES ↓</p>	

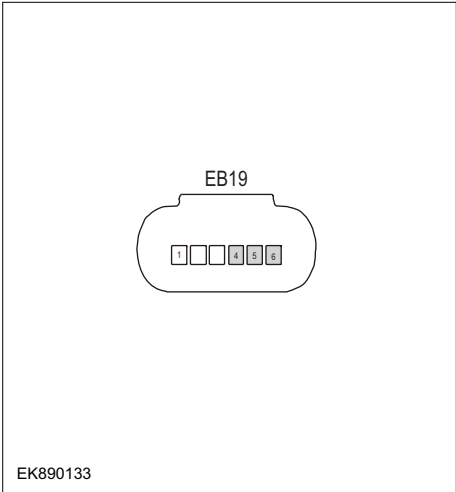
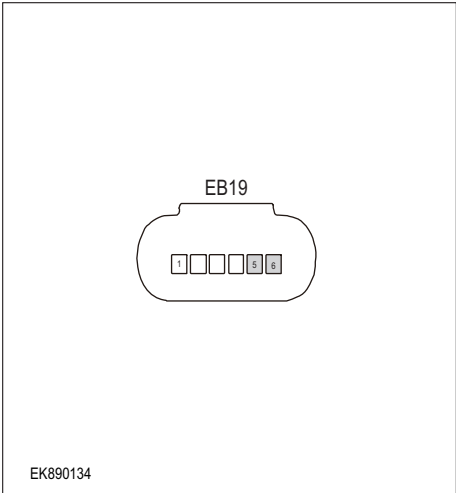
Steps5	Check the brake pedal sensor circuit (short circuit).
	<ol style="list-style-type: none"> 1 Turn the ignition switch to OFF. 2 Connect BCM harness plug IP01_ A、 IP01_ B. 3 Measure the resistance between the brake pedal sensor harness plug and ground. Measuring circuit: The resistance between terminal 4 of EB19 plug and the grounding. Measuring circuit: The resistance between terminal 5 of EB19 plug and the grounding. Measuring circuit: The resistance between terminal 6 of EB19 plug and the grounding. Standard value:infinite 4 Measure the voltage between the brake pedal sensor harness plug and ground. Measuring circuit: The voltage between terminal 4 of EB19 plug and the grounding. Measuring circuit: The voltage between terminal 5 of EB19 plug and the grounding. Measuring circuit: The voltage between terminal 6 of EB19 plug and the grounding. Standard value: ≈ 0V 5 Check whether the result is normal or not?
NO → Repair or replace the faulted parts.	
YES ↓	
Steps6	Check the brake pedal sensor (component inspection).
	<ol style="list-style-type: none"> 1 Turn the ignition switch to OFF. 2 Directly measure the resistance between the brake pedal sensor terminals (sensor end). Measuring circuit: The resistance between terminal 5 and terminal 6 of EB19 plug. Standard value: 3 Measure the resistance between the brake pedal sensor terminal and the housing. Measuring circuit: The resistance between terminal 5 of EB19 plug and the housing. Measuring circuit: The resistance between terminal 6 of EB19 plug and the housing. Standard value:infinite 4 Check whether the result is normal or not?
NO → Please replace the brake pedal sensor.	
YES ↓	

BCM

Steps7	Test whether BCM is norm.
	<ol style="list-style-type: none">1 Turn the ignition switch to OFF.2 Disconnect and check the harness plug IP01_A、IP01_B、IP01_C of BCM.3 Check and repair.<ul style="list-style-type: none">• Corrosion(install new adapting piece or terminal-cleaning module and pin).• Pin damaged or bent-install new terminal/pin.• Fly out of pins-install new pins as needed.4 Reconnect the BCM plug and all other previously disconnected plug. Make sure the pin is properly positioned and fixed.5 Run the system and determine if the problem persists?
	YES → Replace the BCM.
NO ↓	
At this point the system is functioning normally. The problem may be caused by module connections. Address the root cause of any connector or pin problems,	
Next Step ↓	
Diagnosis end.	

B1172-1E

Fault diagnosis code
B1172-1E: MLS SW out of range
Detection tools
1 Multimeter and diagnostic apparatus
Possible causes
<ul style="list-style-type: none"> • Lines, terminals or connectors • BCM • Light switch malfunction • Fuse failure
Conditions for fault code operation
Turn the ignition switch to ON position.
Conditions for fault code setting
B1172-1E
To set the effect of a fault code condition
1
2
Description of circuit diagram

Circuit diagram

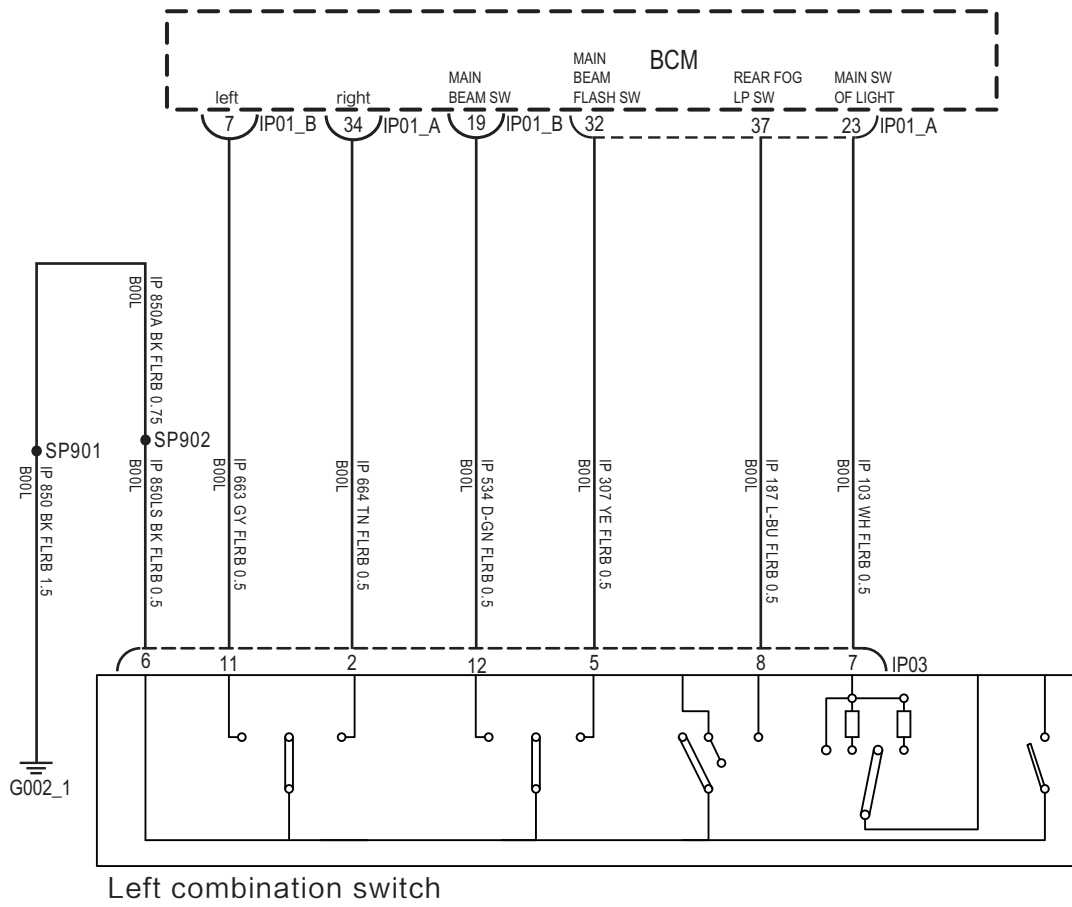

IP01_A

IP01_B

IP03

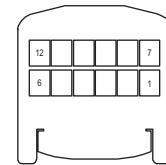
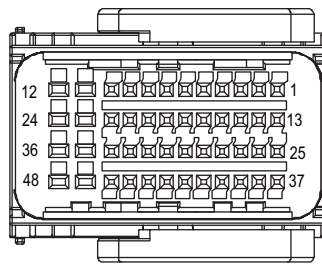
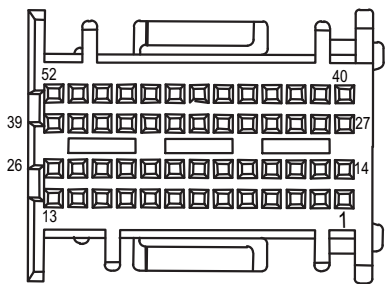

EK890125

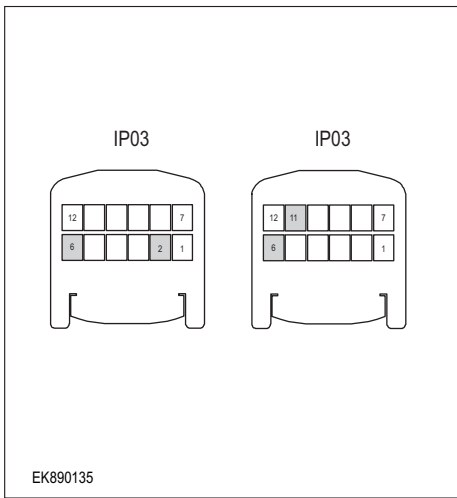
Troubleshooting steps	
Steps1	General inspection.
	<ol style="list-style-type: none"> 1 Check whether the fuse is damaged. 2 Check battery capacity. 3 Check the harness plug of air conditioning control module for damage, poor contact, aging and looseness. 4 Check whether the result is normal or not?
	NO → Repair or replace the faulted parts.
YES ↓	
Steps2	Check fault codes.
	<ol style="list-style-type: none"> 1 Connect the fault diagnosis instrument to the diagnosis interface. 2 Turn the ignition switch to ON position. 3 Diagnosticsing BCM using a diagnostics. 4 If there is any fault code except for B1171-1E?
	YES → Refer to: DTC Summary list(BCM)
NO ↓	
Steps3	Check the combination lamp switch (turn signal switch) (component inspection).
	<ol style="list-style-type: none"> 1 Turn the ignition switch to OFF. 2 Disconnect the combination light switch harness plug IP03. 3 Place the combined light switch in the "Left turn signal" gear, and measure the resistance between the terminals of the combined light switch (combined switch terminal). Measuring circuit: The resistance between terminal 11 of IP03 plug and terminal 6 of IP03 plug. Standard value: ≈ 0Ω 4 Place the combined light switch in the "right turn signal" gear, and measure the resistance between the terminals of the combined light switch (combined switch terminal). Measuring circuit: The resistance between terminal 2 of IP03 plug and terminal 6 of IP03 plug. Standard value: ≈ 0Ω 5 Check whether the result is normal or not?
	NO → Please replace the combination light switch.
YES ↓	

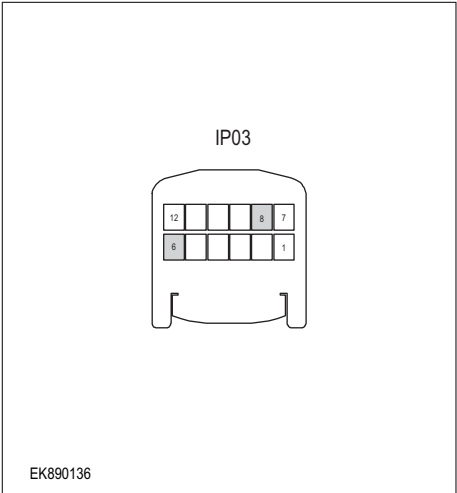
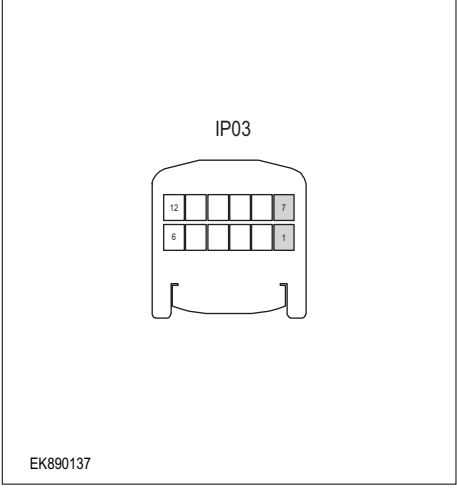
Steps4	Check the combination light switch (fog light switch) (component inspection).
 <p style="text-align: center;">IP03</p> <p style="text-align: center;">EK890136</p>	<ol style="list-style-type: none"> 1 Turn the ignition switch to OFF. 2 Place the combination light switch in the "rear fog light" position and measure the resistance between the terminals of the combination light switch (combination switch terminal). <p>Measuring circuit: The resistance between terminal 8 of IP03 plug and terminal 6 of IP03 plug.</p> <p>Standard value: $\approx 0\Omega$</p> <ol style="list-style-type: none"> 3 Check whether the result is normal or not?
<p>NO → Please replace the combination light switch.</p>	
<p>YES ↓</p>	
Steps5	Check the combined light switch (low beam switch) (component inspection).
 <p style="text-align: center;">IP03</p> <p style="text-align: center;">EK890137</p>	<ol style="list-style-type: none"> 1 Turn the ignition switch to OFF. 2 Place the combined light switch in the "low beam" gear, and measure the resistance between the terminals of the combined light switch (combined switch terminal). <p>Measuring circuit: The resistance between terminal 7 of IP03 plug and terminal 1 of IP03 plug.</p> <p>Standard value: $\approx 0\Omega$</p> <ol style="list-style-type: none"> 3 Check whether the result is normal or not?
<p>NO → Please replace the combination light switch.</p>	
<p>YES ↓</p>	

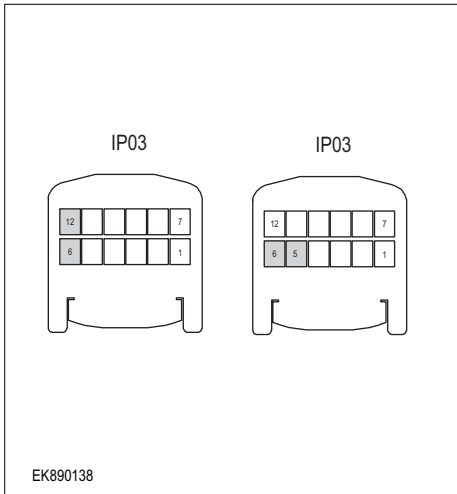
Steps6	Check the combination light switch (high beam switch) (component inspection).
	<ol style="list-style-type: none"> 1 Turn the ignition switch to OFF. 2 Place the combination light switch in the "high beam" position and measure the resistance between the terminals of the combination light switch (combination switch terminal). Measuring circuit: The resistance between terminal 12 of IP03 plug and terminal 6 of IP03 plug. Standard value: $\approx 0\Omega$ 3 Place the combination light switch in the "flash" position and measure the resistance between the terminals of the combination light switch (combination switch terminal). Measuring circuit: The resistance between terminal 5 of IP03 plug and terminal 6 of IP03 plug. Standard value: $\approx 0\Omega$ 4 Check whether the result is normal or not?
	<p>NO → Please replace the combination light switch.</p>
<p>YES ↓</p>	

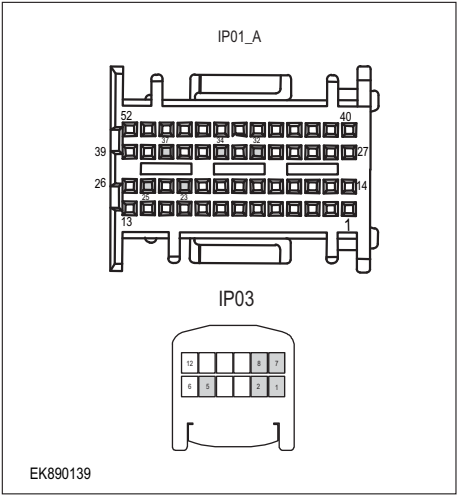
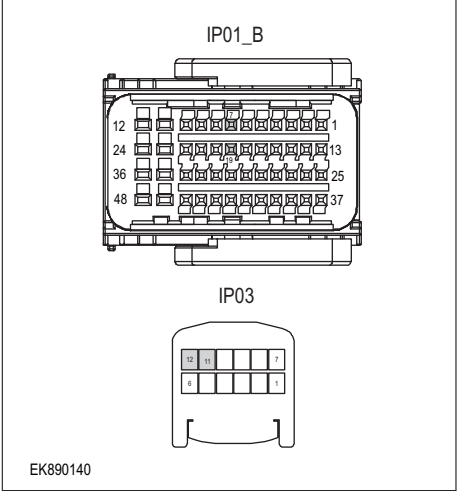
Steps7	Check the combination light switch and BCM circuit (open circuit).
 	<ol style="list-style-type: none"> 1 Turn the ignition switch to OFF. 2 Disconnect the BCM harness plug IP01_ A、 IP01_ B. 3 Disconnect the combination light switch harness plug IP03. 4 Measure the resistance between the combination light switch harness terminal and the BCM harness terminal. <ul style="list-style-type: none"> Measuring circuit: IP03 plug terminal 1 and IP01_ The resistance between terminal 25 of plug A. Measuring circuit: IP03 plug terminal 2 and IP01_ The resistance between terminal 34 of plug A. Measuring circuit: IP03 plug terminal 5 and IP01_ The resistance between terminal 32 of plug A. Measuring circuit: IP03 plug terminal 7 and IP01_ The resistance between terminal 23 of plug A. Measuring circuit: IP03 plug terminal 8 and IP01_ The resistance between terminal 37 of plug A. Measuring circuit: IP03 plug terminal 11 and IP01_ The resistance between terminal 7 of plug B. Measuring circuit: IP03 plug terminal 12 and IP01_ The resistance between terminal 19 of plug B. <p>Standard value: $\approx 0\Omega$</p> 5 Check whether the result is normal or not?
	<p>NO → Repair or replace the faulted parts.</p>
<p>YES ↓</p>	

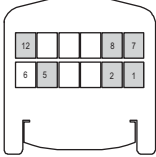
Steps8	Check the combined light switch circuit (short circuit).
<div style="text-align: center;">  <p>IP03</p> </div> <p>EK890141</p>	<ol style="list-style-type: none"> 1 Turn the ignition switch to OFF. 2 Connect BCM harness plug IP09_A、 IP09_B. 3 Measure the resistance between the harness plug of the combination light switch and ground. <ul style="list-style-type: none"> Measuring circuit: The resistance between terminal 1 of IP03 plug and the grounding. Measuring circuit: The resistance between terminal 2 of IP03 plug and the grounding. Measuring circuit: The resistance between terminal 5 of IP03 plug and the grounding. Measuring circuit: The resistance between terminal 7 of IP03 plug and the grounding. Measuring circuit: The resistance between terminal 8 of IP03 plug and the grounding. Measuring circuit: The resistance between terminal 11 of IP03 plug and the grounding. Measuring circuit: The resistance between terminal 12 of IP03 plug and the grounding. <p>Standard value: infinite</p> 4 Measure the voltage between the harness plug of the combination light switch and ground. <ul style="list-style-type: none"> Measuring circuit: The voltage between terminal 1 of IP03 plug and the grounding. Measuring circuit: The voltage between terminal 2 of IP03 plug and the grounding. Measuring circuit: The voltage between terminal 5 of IP03 plug and the grounding. Measuring circuit: The voltage between terminal 7 of IP03 plug and the grounding. Measuring circuit: The voltage between terminal 8 of IP03 plug and the grounding. Measuring circuit: The voltage between terminal 11 of IP03 plug and the grounding. Measuring circuit: The voltage between terminal 12 of IP03 plug and the grounding. <p>Standard value: ≈ 0V</p> 5 Check whether the result is normal or not?
	<p>NO → Repair or replace the faulted parts.</p>
<p>YES ↓</p>	

Steps9	Test whether BCM is norm.
	<ol style="list-style-type: none"> 1 Turn the ignition switch to OFF. 2 Disconnect and check BCM harness plug IP01_ A、 IP02_ B、 IP01_ C 3 Check and repair. <ul style="list-style-type: none"> • Corrosion(install new adapting piece or terminal-cleaning module and pin). • Pin damaged or bent-install new terminal/pin. • Fly out of pins-install new pins as needed. 4 Reconnect the BCM plug and all other previously disconnected plug. Make sure the pin is properly positioned and fixed. 5 Run the system and determine if the problem persists?
	YES → Replace the BCM.
NO ↓	
At this point the system is functioning normally. The problem may be caused by module connections. Address the root cause of any connector or pin problems,	
Next Step ↓	
Diagnosis end.	

B1173-11、 B1173-1E

Fault diagnosis code
B1173-11: Dimmer SW input Circuit short to ground
B1120-1E: Dimmer SW input out of range
Detection tools
1 Multimeter and diagnostic apparatus
Possible causes
<ul style="list-style-type: none"> • Lines, terminals or connectors • BCM • Fuse failure
Conditions for fault code operation
Turn the ignition switch to ON position.
Conditions for fault code setting
B1173-11
B1120-1E
To set the effect of a fault code condition
1
2
Description of circuit diagram

Circuit diagram

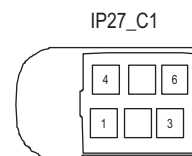
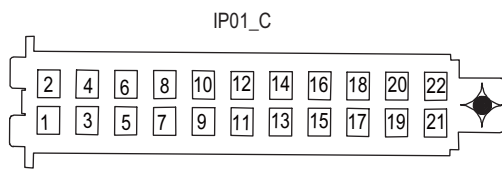
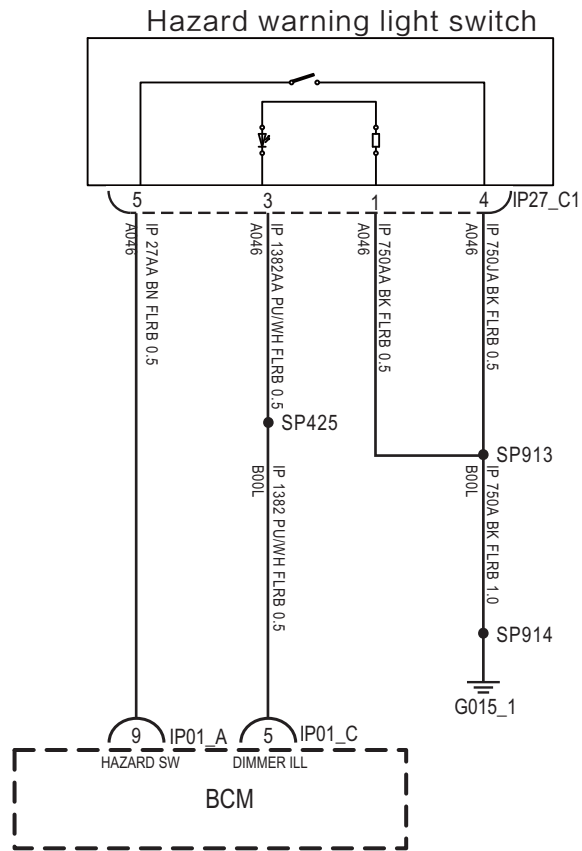

EK890146

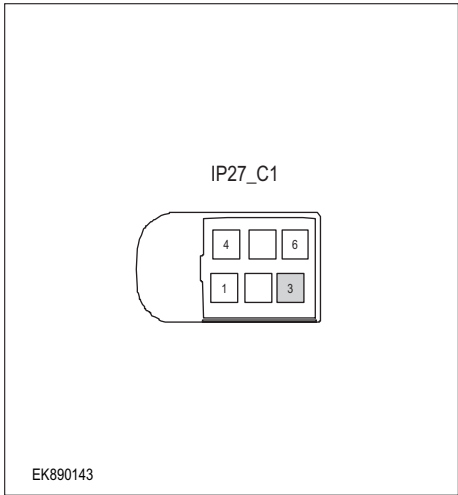
Troubleshooting steps	
Steps1	General inspection.
	<ol style="list-style-type: none"> 1 Check whether the fuse is damaged. 2 Check battery capacity. 3 Check the harness plug of air conditioning control module for damage, poor contact, aging and looseness. 4 Check whether the result is normal or not?
	NO → Repair or replace the faulted parts.
YES ↓	
Steps2	Check fault codes.
	<ol style="list-style-type: none"> 1 Connect the fault diagnosis instrument to the diagnosis interface. 2 Turn the ignition switch to ON position. 3 Diagnosticsing BCM using a diagnostics. 4 If there is any fault code except for B1173-11、 B1173-1E?
	YES → Refer to: DTC Summary list(BCM)
NO ↓	
Steps3	Check the power supply of the backlight during startup or operation.
 <p style="text-align: center;">IP27_C1</p> <p style="text-align: left; font-size: small;">EK890143</p>	<ol style="list-style-type: none"> 1 Turn the ignition switch to OFF. 2 Disconnect the hazard warning light switch harness plug IP27_C1. 3 Turn the ignition switch to ON. 4 Measure the voltage between the backlight harness terminal and ground. Measuring circuit: IP27_ The voltage between terminal 3 of C1 plug and ground. Standard value:10~14V 5 Check whether the result is normal or not?
	NO → Repair or replace the faulted parts.
YES ↓	

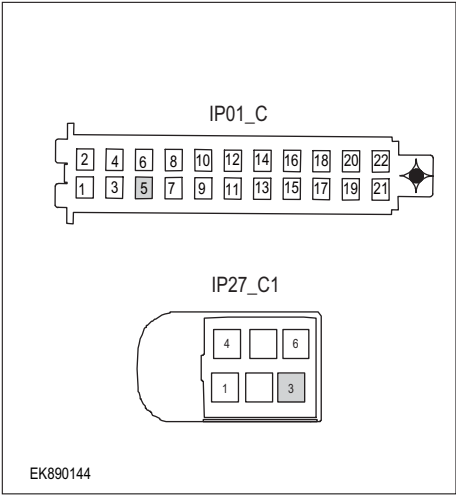
Steps4	Check the circuit (open circuit) between the hazard warning light switch and the BCM.
	<ol style="list-style-type: none"> 1 Disconnect plug IP01_C of BCM harness. 2 Measure the resistance between the harness terminal of the hazard warning light switch and the BCM harness terminal. Measuring circuit: IP01_ Terminal 5 of plug C and IP27_ The resistance between terminal 3 of C1 plug. <p>Standard value: $\approx 0\Omega$</p> <ol style="list-style-type: none"> 3 Check whether the result is normal or not?

NO → Repair or replace the faulted parts.

YES ↓

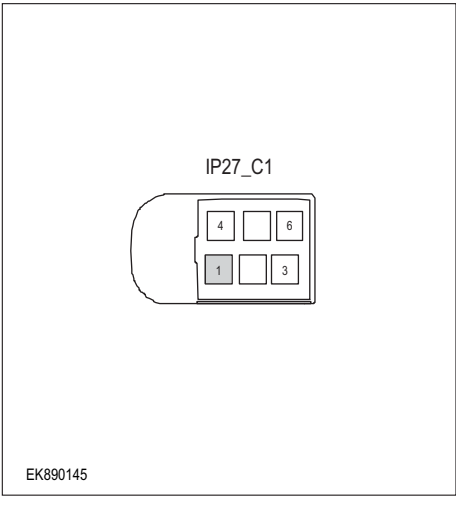
Steps5	Check the ground circuit of the backlight for an open.
	<ol style="list-style-type: none"> 1 Turn the ignition switch to OFF. 2 Measure the resistance between backlight harness plug and ground. Measuring circuit: IP27_ The resistance between terminal 1 of C1 plug and ground. <p>Standard value: $< 1\Omega$</p> <ol style="list-style-type: none"> 3 Test whether the resistance is less than 1Ω?

NO → Repair or replace the faulted parts.

YES ↓

Steps6	Test whether BCM is norm.
	<ol style="list-style-type: none"> 1 Turn the ignition switch to OFF. 2 Disconnect and check the harness plug IP01_A、IP01_B、 IP01_C of BCM. 3 Check and repair. <ul style="list-style-type: none"> • Corrosion(install new adapting piece or terminal-cleaning module and pin). • Pin damaged or bent-install new terminal/pin. • Fly out of pins-install new pins as needed. 4 Reconnect the BCM plug and all other previously disconnected plug. Make sure the pin is properly positioned and fixed. 5 Run the system and determine if the problem persists?
	YES → Replace the BCM.
NO ↓	
At this point the system is functioning normally. The problem may be caused by module connections. Address the root cause of any connector or pin problems,	
Next Step ↓	
Diagnosis end.	

B1176-11、 B1176-12

Fault diagnosis code
B1176-11: Brake SW input Circuit short to ground
B1176-12: Brake SW input short to battery
Detection tools
1 Multimeter and diagnostic apparatus
Possible causes
<ul style="list-style-type: none"> • Lines, terminals or connectors • BCM • Fuse failure
Conditions for fault code operation
Turn the ignition switch to ON position.
Conditions for fault code setting
B1176-11
B1176-12
To set the effect of a fault code condition
1
2
Description of circuit diagram

Circuit diagram

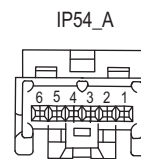
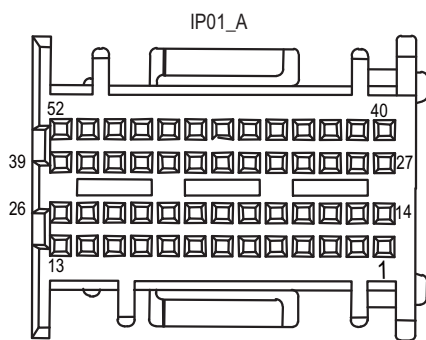
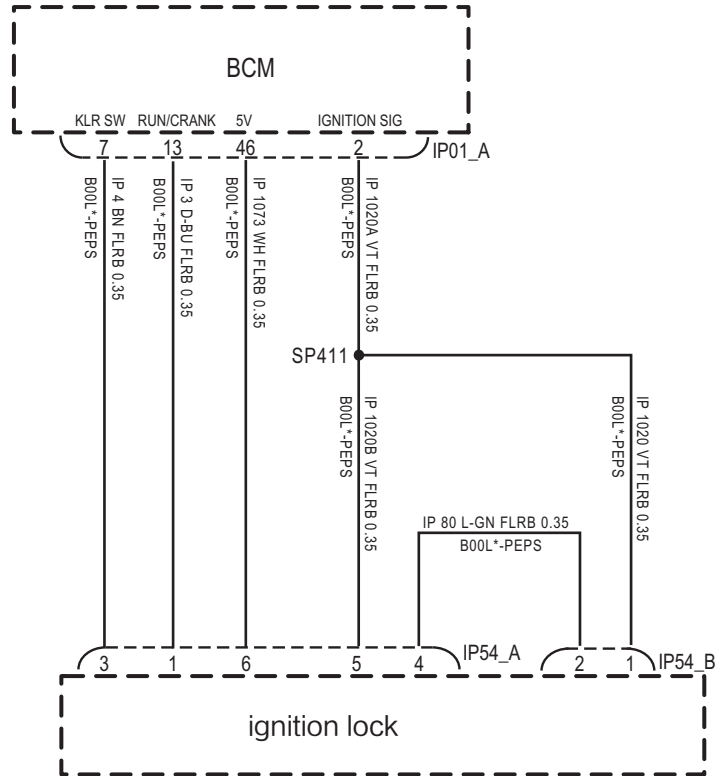

EK890147

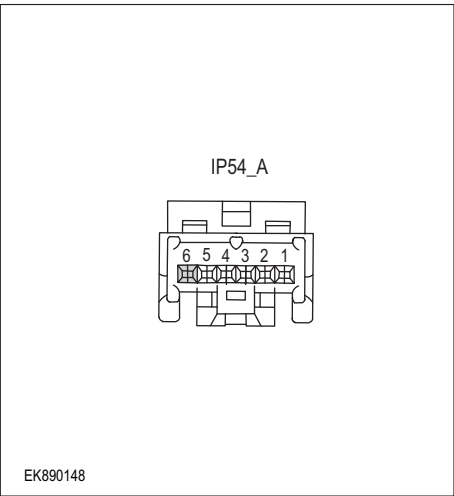
Troubleshooting steps	
Steps1	General inspection.
	<ol style="list-style-type: none"> 1 Check whether the fuse is damaged. 2 Check battery capacity. 3 Check the harness plug of air conditioning control module for damage, poor contact, aging and looseness. 4 Check whether the result is normal or not?
	NO → Repair or replace the faulted parts.
YES ↓	
Steps2	Check fault codes.
	<ol style="list-style-type: none"> 1 Connect the fault diagnosis instrument to the diagnosis interface. 2 Turn the ignition switch to ON position. 3 Diagnosticsing BCM using a diagnostics. 4 If there is any fault code except for B1176-11、B1176-12?
	YES → Refer to: DTC Summary list(BCM)
NO ↓	
Steps3	Check the ignition switch and BCM circuit (open circuit).
 <p style="text-align: center;">IP54_A</p> <p style="text-align: center;">6 5 4 3 2 1</p> <p>EK890148</p>	<ol style="list-style-type: none"> 1 Turn the ignition switch to OFF. 2 Disconnect the plug IP01_A of BCM harness. 3 Disconnect the ignition switch harness plug IP54_A. 4 Measure the resistance between the ignition switch harness terminal and the BCM harness terminal. Measuring circuit: IP54_ Terminal 6 of plug A and IP01_ The resistance between terminal 46 of plug A. Standard value: ≈ 0Ω 5 Check whether the result is normal or not?
	1
	NO → Repair or replace the faulted parts.
YES ↓	

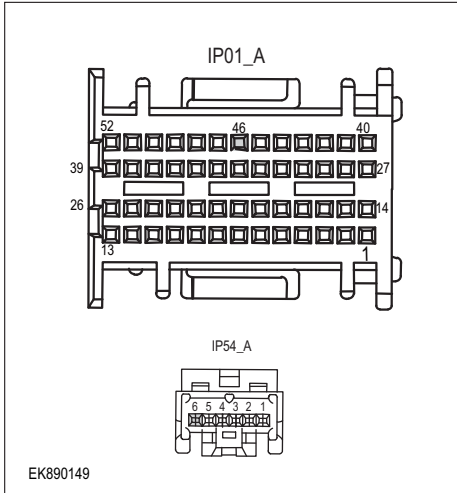
Steps4	Check the brake pedal sensor circuit (short circuit).
	<ol style="list-style-type: none"> 1 Turn the ignition switch to OFF. 2 Connect BCM harness plug IP01_ A. 3 Connect the ignition switch harness plug IP54_ A. 4 Turn the ignition switch to ON. 5 Measure the resistance between the ignition switch harness plug and ground. Measuring circuit: IP54_ The resistance between terminal 6 of plug A and the grounding. Standard value:infinite 6 Measure the voltage between the brake pedal sensor harness plug and ground. Measuring circuit: IP54_ The voltage between terminal 6 of plug A and the grounding. Standard value: ≈ 5V 7 Check whether the result is normal or not?
NO → Repair or replace the faulted parts.	
YES ↓	
Steps5	Test whether BCM is norm.
	<ol style="list-style-type: none"> 1 Turn the ignition switch to OFF. 2 Disconnect and check the harness plug IP01_A、IP01_B、 IP01_C of BCM. 3 Check and repair. <ul style="list-style-type: none"> • Corrosion(install new adapting piece or terminal-cleaning module and pin). • Pin damaged or bent-install new terminal/pin. • Fly out of pins-install new pins as needed. 4 Reconnect the BCM plug and all other previously disconnected plug. Make sure the pin is properly positioned and fixed. 5 Run the system and determine if the problem persists?
YES → Replace the BCM.	
NO ↓	
At this point the system is functioning normally. The problem may be caused by module connections. Address the root cause of any connector or pin problems,	
Next Step ↓	
Diagnosis end.	

DTC Summary List (AVAS)

DTC	English descriptions	Reference page
U1562-17	Power supply voltage over 16V	U1562-17, U1563-16
U1563-16	Power supply voltage below 9V	
B1570-31	Amplifier Short	B1570-31
U0294-87	CAN VCU/HCU Communication time out	U0294-87, U0121-87, U0073-88
U0121-87	CAN ESC/ABS Communication time out	
U0073-88	CAN bus off	

U1562-17、 U1563-16

Fault diagnosis code
U1562-17: Power supply voltage over 16V
U1563-16: Power supply voltage below 9V
Detection tools
1 Multimeter and diagnostic apparatus
Possible causes
<ul style="list-style-type: none"> • Circuit,terminal and adapting piece fault • Battery • AVAS Module • Charging system • Insurance fuse
Conditions for fault code operation
Turn the ignition switch to ON position.
Conditions for fault code setting
U1562-17
Internal local voltage> 16V
U1563-16
Internal local voltage < 9V
To set the effect of a fault code condition
No sound
Description of circuit diagram
The AVAS will monitor whether all sensors and actuators are within normal range all the time. Meanwhile,it will check the connector for virtual connection, short circuit, open circuit and the connection rationality with other signals. When fault occurs, the AVAS module will save the fault code corresponding to that fault and enable safety mode.

Circuit diagram

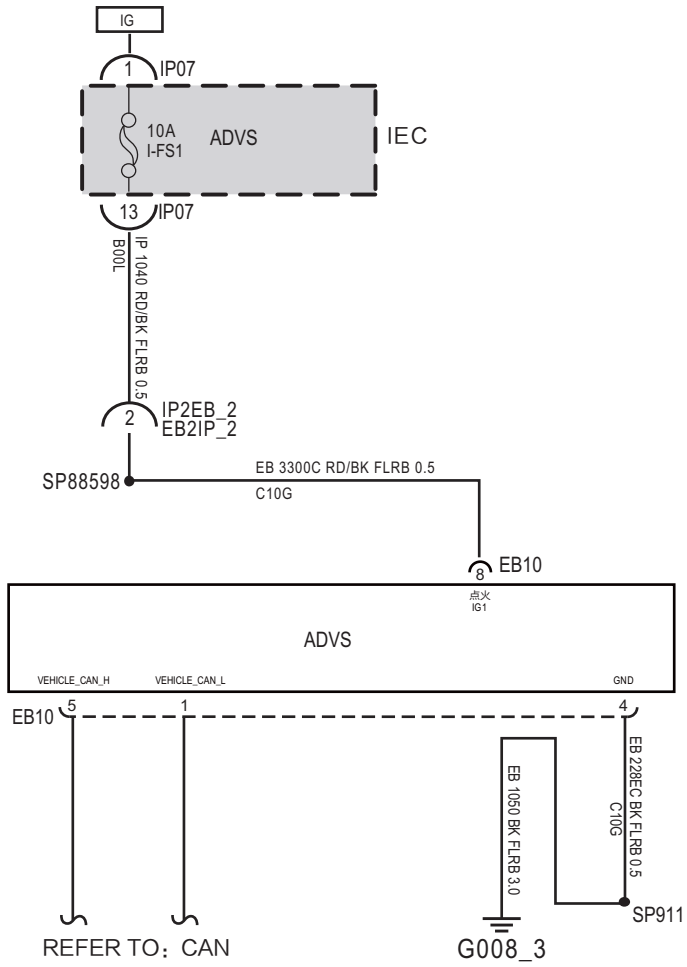

REFER TO: CAN

G008_3

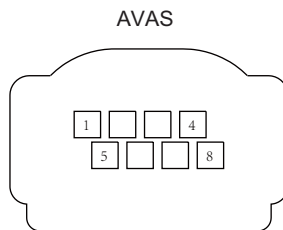

EK895001

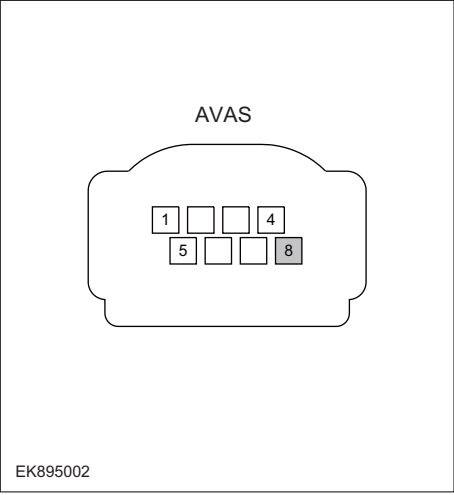
Troubleshooting procedures	
Step1	General inspection.
	<ol style="list-style-type: none"> 1 Check the fusel-FS1for damage. 2 Check battery capacity. 3 Check the harness plug of AVAS for damage, poor contact, aging and looseness. 4 Check whether the result is normal or not? 5
NO → Repair or replace the faulted parts.	
YES ↓	
Step2	Check fault codes.
	<ol style="list-style-type: none"> 1 Connect the fault diagnosis instrument to the diagnosis interface. 2 Turn the ignition switch to ON position. 3 Diagnose the AVAS with diagnostic apparatus. 4 If there is any fault code except forU1562-17、 U1563-16?
YES → 参见: DTC Summary List (AVAS) 。	
NO ↓	
Step 3	Check the power voltage of AVAS battery.
 <p style="text-align: center;">AVAS</p> <p style="text-align: center;">1 4 5 8</p> <p>EK895002</p>	<ol style="list-style-type: none"> 1 Turn the ignition switch to OFF. 2 Disconnect the harness plug of AVAS module. 3 Measure the voltage between the harness terminal of AVAS and ground. Measuring circuit: voltage between terminal 8 on plug AVAS Module and ground. Standard value: < 1V 4 Check whether the result is normal or not? 5
NO → Repair or replace the faulted parts.	
YES ↓	

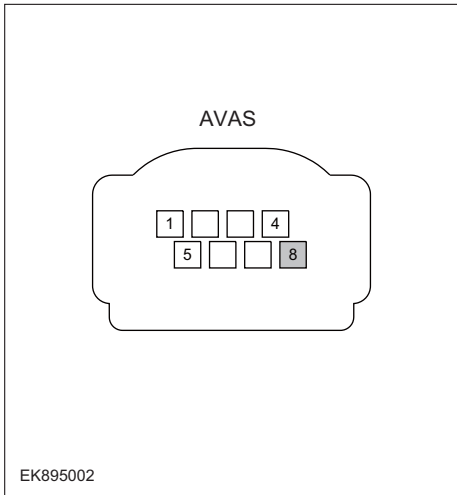
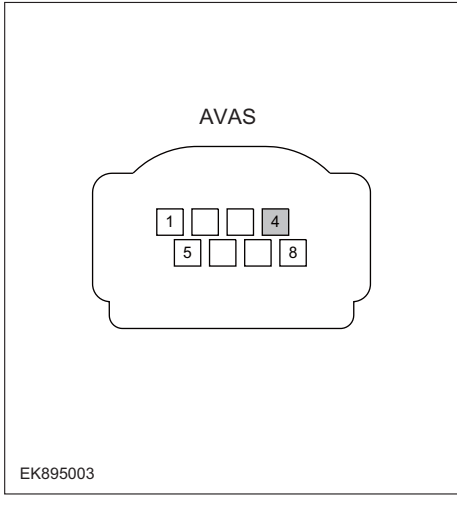
Step 4	Check the power voltage when the AVAS is started or operating
 <p style="text-align: center;">AVAS</p> <p style="text-align: center;">EK895002</p>	<ol style="list-style-type: none"> 1 Turn the ignition switch to ON. 2 Measure the voltage between the harness terminal of AVAS and ground. Measuring circuit: voltage between terminal 6 on plug AVAS Module and ground. Standard value: 10~14V 3 Check whether the result is normal or not? 4
NO → 请维修或更换检测到故障的零件。	
YES ↓	
Step5	Test whether the grounding circuit of AVAS is open.
 <p style="text-align: center;">AVAS</p> <p style="text-align: center;">EK895003</p>	<ol style="list-style-type: none"> 1 Turn the ignition switch to OFF. 2 Disconnect the harness plug of AVAS module. 3 Measure the resistance between the harness terminal of AVAS and ground. Measuring circuit: voltage between terminal 4 on plug AVAS Module and ground. Standard value: < 1Ω 4 Test whether the resistance is less than 1Ω?
NO → Repair or replace the faulted parts.	
YES ↓	

AVAS

Step 6	Test whether AVAS is norm.
	<ol style="list-style-type: none">1 Turn the ignition switch to OFF.2 Disconnect and check the harness plug of AVAS.3 Check and repair:<ul style="list-style-type: none">• Corrosion(install new adapting piece or terminal-cleaning module and pin).• Pin damaged or bent-install new terminal/pin.4 Fly out of pins-install new pins as needed.5 Reconnect the AVAS plug and all other previously disconnected plug. Make sure the pin is properly positioned and fixed.6 Run the system and determine if the problem persists?7
	YES → Change the AVAS Module
NO ↓	
At this point the system is functioning normally. The problem may be caused by module connections. Address the root cause of any connector or pin problems.	
Next Step ↓	
Diagnosis end.	

B1570-31

Fault diagnosis code
B1570-31: Amplifier Short
Detection tools
1 Multimeter and diagnostic apparatus
Possible causes
<ul style="list-style-type: none">• Circuit, terminal and adapting piece fault• AVAS module fault• Control switch fault
Conditions for fault code operation
Turn the ignition switch to ON position.
Conditions for fault code setting
B1570-31
When the output is valid, the output is equal to "low" and the output is short-circuited.
To set the effect of a fault code condition
No sound
Description of circuit diagram

Circuit diagram

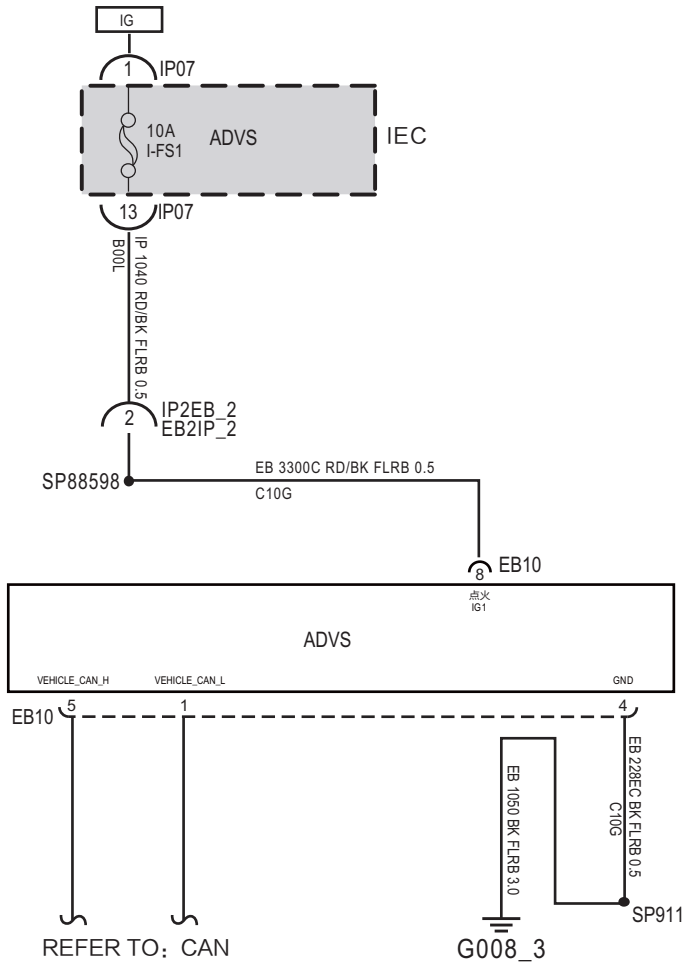

AVAS

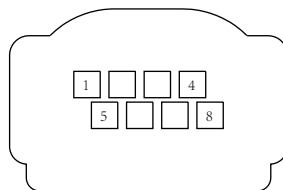

EK895001

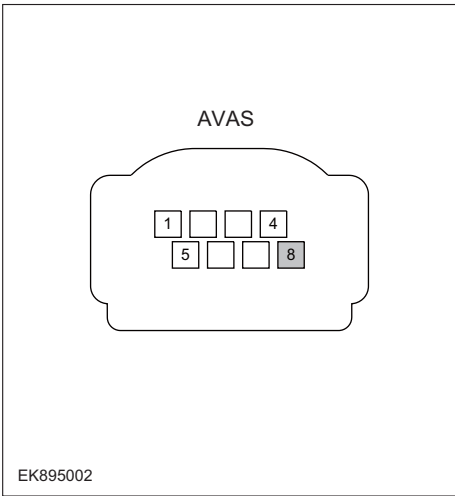
Troubleshooting procedures	
Step 1	General inspection
	<ol style="list-style-type: none"> 1 Check the fuse I-FS1 or damage. 2 Check battery capacity. 3 Check the harness plug of AVAS for damage, poor contact, aging and looseness. 4 Check whether the result is normal or not?
<p>NO → Repair or replace the faulted parts.</p>	
<p>YES ↓</p>	
Step 2	Check fault codes.
	<ol style="list-style-type: none"> 1 Connect the fault diagnosis instrument to the diagnosis interface. 2 Turn the ignition switch to ON position. 3 Diagnose the AVAS with diagnostic apparatus. 4 Is there any other fault code except for B1570-31?
<p>YES → Refer to: DTC Summary List (AVAS).</p>	
<p>NO ↓</p>	
Step 3	Check the power voltage of AVAS battery.
 <p style="text-align: center;">AVAS</p> <p style="text-align: center;">1 □ □ □ 4</p> <p style="text-align: center;">5 □ □ 8</p> <p>EK895002</p>	<ol style="list-style-type: none"> 1 Turn the ignition switch to OFF. 2 Disconnect the harness plug of AVAS module. 3 Measure the voltage between the harness terminal of AVAS and ground. <p>Measuring circuit: voltage between terminal 8 on plug AVAS Module and ground.</p> <p>Standard value: < 1V</p> <ol style="list-style-type: none"> 4 Check whether the result is normal or not?
<p>NO → Repair or replace the faulted parts.</p>	
<p>YES ↓</p>	

AVAS

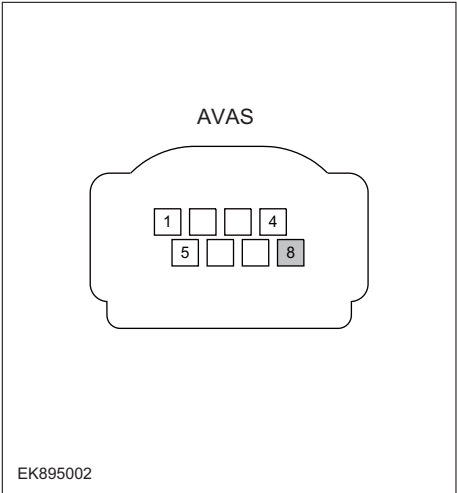
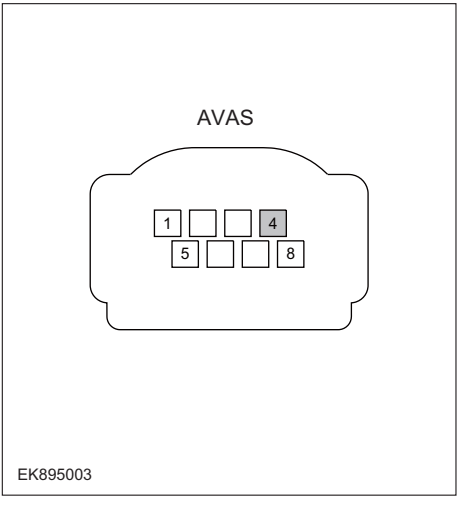
Step4	Check the power voltage when the AVAS is started or operating
 <p style="text-align: center;">AVAS</p> <p style="text-align: center;">EK895002</p>	<ol style="list-style-type: none"> 1 Turn the ignition switch to ON. 2 Measure the voltage between the harness terminal of AVAS and ground. Measuring circuit: voltage between terminal 8 on plug AVAS Module and ground. Standard value:10~14V 3 Check whether the result is normal or not?
NO → Repair or replace the faulted parts.	
YES ↓	
Step5	Test whether the grounding circuit of AVAS is open.
 <p style="text-align: center;">AVAS</p> <p style="text-align: center;">EK895003</p>	<ol style="list-style-type: none"> 1 Turn the ignition switch to OFF. 2 Disconnect the harness plug of AVAS module. 3 Measure the resistance between the harness terminal of AVAS and ground. Measuring circuit: voltage between terminal 4 on plug AVAS Module and ground. Standard value: < 1Ω 4 Test whether the resistance is less than 1Ω?
NO → Repair or replace the faulted parts.	
YES ↓	

Step6	Test whether AVAS is norm
	<ol style="list-style-type: none"> 1 Turn the ignition switch to OFF. 2 Disconnect and check the harness plug of AVAS. 3 Check and repair: <ul style="list-style-type: none"> • Corrosion(install new adapting piece or terminal-cleaning module and pin). • Pin damaged or bent-install new terminal/pin. 4 Fly out of pins-install new pins as needed. 5 Reconnect the AVAS plug and all other previously disconnected plug. Make sure the pin is properly positioned and fixed. 6 Run the system and determine if the problem persists?
	YES → Change the AVAS Module
NO ↓	
At this point the system is functioning normally. The problem may be caused by module connections. Address the root cause of any connector or pin problems.	
Next Step ↓	
Diagnosis end.	

AVAS

U0294-87、U0121-87、U0073-88

Fault diagnosis code
U0294-87: CAN VCU/HCU Communication time out
U0121-87: CAN ESC/ABS Communication time out
U0073-88: CAN bus off
Detection tools
1 Multimeter and diagnostic apparatus
Possible causes
<ul style="list-style-type: none">• Circuit,terminal and adapting piece fault• AVAS Module
Conditions for fault code operation
Turn the ignition switch to ON position.
Conditions for fault code setting
U0294-87
Gear loss signal
U0121-87
Invalid Vehicle Speed
U0073-88
CAN BusOff Failure
To set the effect of a fault code condition
No sound or abnormal sound
Description of circuit diagram
The device is connected to serial data circuit, which is used to monitor the communication situation of serial data during normal operation of vehicle. The devices will exchange the operation information and commands mutually. The device has programming information required to be exchanged on the serial data circuit. The receiver device will also monitor such information; in addition, there are some regular information indication transmitter devices available.

Circuit diagram

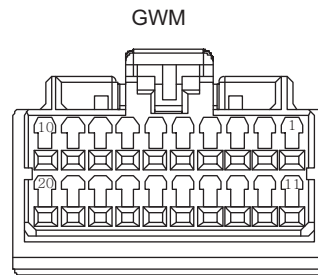
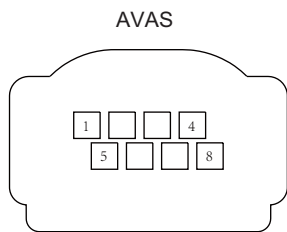
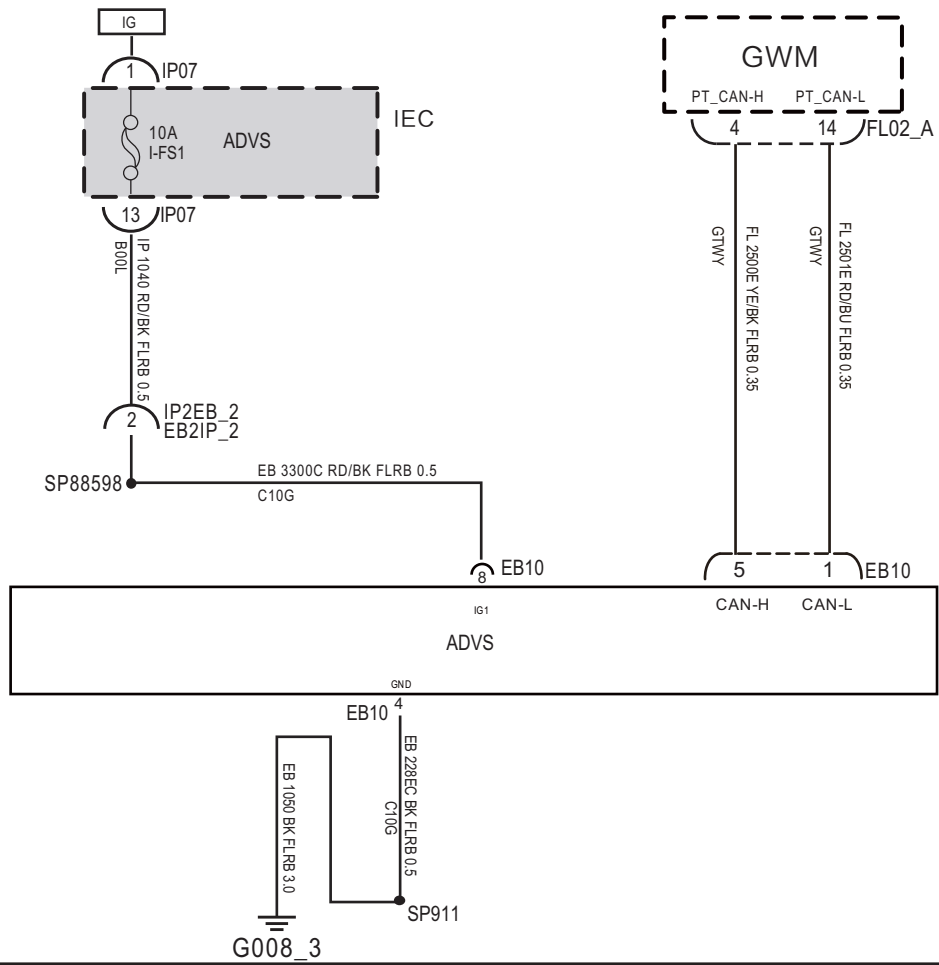

EK895004

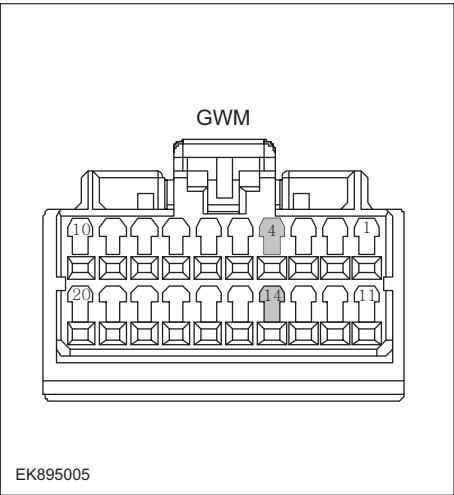
Troubleshooting procedures	
Step1	General inspection.
	<ol style="list-style-type: none"> 1 Check the fuse for damage. 2 Check battery capacity. 3 Check the harness plug of AVAS for damage, poor contact, aging and looseness. 4 Check whether the result is normal or not?
	NO → Repair or replace the faulted parts.
YES ↓	
Step2	Check fault codes.
	<ol style="list-style-type: none"> 1 Connect the fault diagnosis instrument to the diagnosis interface. 2 Turn the ignition switch to ON position. 3 Diagnose the AVAS with diagnostic apparatus. 4 Is there any other fault code except for U0294-87、U0121-87、U0073-88?
	YES → 参见: DTC Summary List (AVAS) .
NO ↓	
Step3	Check the terminating resistance of GWM module.
 <p>The diagram shows a GWM module connector with two rows of terminals. The top row has terminals labeled 10, 4, and 1. The bottom row has terminals labeled 20, 14, and 11. Terminal 4 is highlighted in the top row, and terminal 14 is highlighted in the bottom row. The diagram is labeled 'GWM' and 'EK895005'.</p>	<ol style="list-style-type: none"> 1 Turn the ignition switch to OFF. 2 Disconnect the GWM module harness plug FL02_A. 3 Measure the resistance between the wiring harness terminals of the GWM module. Measuring circuit: the resistance between terminal 4 and 14 on plug GWM. Standard value: 110~130Ω 4 Check whether the result is normal or not?
	NO → Repair or replace the faulted parts.
YES ↓	

Step4	Test whether AVAS is norm.
	<ol style="list-style-type: none"> 1 Turn the ignition switch to OFF. 2 Disconnect and check the harness plug of AVAS. 3 Check and repair: <ul style="list-style-type: none"> • Corrosion(install new adapting piece or terminal-cleaning module and pin). • Pin damaged or bent-install new terminal/pin. • Fly out of pins-install new pins as needed. 4 Reconnect the AVAS plug and all other previously disconnected plug. Make sure the pin is properly positioned and fixed. 5 Run the system and determine if the problem persists?
	YES → Change the AVAS Module
NO ↓	
At this point the system is functioning normally. The problem may be caused by module connections. Address the root cause of any connector or pin problems.	
Next Step ↓	
Diagnosis end.	

DTC Summary list(BMS)

Notes for high voltage maintenance:

On the premise of wearing and preparing protective equipment in strict accordance with the requirements of high-voltage maintenance operations, the following points should also be paid attention to:

- 1 The orange wire harness in the cabin is a high-voltage wire harness. Do not touch it without discharge treatment or wearing insulation tools.
- 2 In all maintenance operations involving vehicle electrical and high-voltage wiring harness areas, the high-voltage wiring harness plugs connected with power batteries should be disconnected, and the high-voltage wiring harness and electrical discharge operation.
- 3 Maintenance personnel shall place insulating objects (such as insulation sticks) beside them, and be equipped with safety supervision personnel to avoid inadvertent electric shock.
- 4 Turn off the ignition switch and do not perform other operations within 3 minutes of disconnecting the negative electrode of the battery.
- 5 After the power failure, keep the key of the vehicle and forbid others to operate it.
- 6 If the power battery has a maintenance switch, remove the maintenance switch first and then disconnect the power battery wiring harness.
- 7 For the power battery harness plug, disconnect the low-voltage control harness first and then the high-voltage connection harness (the red harness is positive and the black harness is negative).
- 8 Discharge the wiring harness connecting the positive and negative high voltage terminals of the battery box.
- 9 Discharge high voltage electrical appliances and wire harness terminals. Use a multimeter to measure the voltage at both ends and check that the voltage is zero before performing related operations.
- 10 The disassembled and disconnected connectors of high-voltage electrical appliances shall be sealed with black tape to prevent sundries from entering.
- 11 The wiring harness connectors should be kept dry. If cooling water and oil are accidentally spilled into the high-voltage wiring harness or electrical interior, they should be cleaned and dried with compressed air. And use Megohm meter to measure the insulation resistance of high-voltage electrical appliances or wiring harness to meet the standard before installation.
- 12 Before opening the cover of the engine room of the electric vehicle, the key should be turned to the OFF gear; It is strictly prohibited to touch the devices marked with high pressure danger warning signs in the cabin of the electric vehicle directly; Spraying water or washing is prohibited in the engine room of the vehicle; Do not open the front hatch cover in the rain to prevent electrical leakage.

DTC	English descriptions	Reference page
P0561-00	BMU over temperature fault	P0561-00
P0562-F1	BMS power supply voltage low	P0562-F1 、 P0563-F1
P0563-F1	BMS power supply voltage high	
P0A0A-00	High voltage interlock loop 1 open circuit	P0A0A-00 、 P0A0B-00 、 P0A0C-00 、 P0A0D-00
P0A0B-00	High voltage interlock loop invalid	
P0A0C-00	High voltage interlock loop 1 short to GND	
P0A0D-00	High voltage interlock loop 1 short to source power	
P0A7D-F0	SOC too low	P0A7D-F0 、 P0A80-F0 、 P0C30-F0 、 P1DF6-F0 、 P1DF6-F1
P0A80-F0	SOC jump	
P0C30-F0	SOC too high	
P1DF6-F0	SOH low level 1	
P1DF6-F1	SOH low level 2	

BMS(CN)

DTC	English descriptions	Reference page
P0AA1-00	Main positive or precharge relay stuck fault	P0AA1-00 、 P0AA2-00 、 P0ADB-00 、 P0ADC-00 、 P0AD9-00 、 P0ADA-00
P0AA2-00	Main positive relay open fault	
P0ADB-00	Main positive contactor coil circuit short to GND fault	
P0ADC-00	Main positive contactor coil circuit short to power fault	
P0AD9-00	Main positive contactor coil circuit open fault	
P0ADA-00	Main positive contactor coil circuit current abnormal fault	
P0AA4-00	Main negative relay stuck fault	P0AA4-00 、 P0AA5-00 、 P0ADF-00 、 P0AE0-00 、 P0ADD-00 、 P0ADE-00
P0AA5-00	Main negative relay stuck open fault	
P0ADF-00	Main negative contactor coil circuit short to GND fault	
P0AE0-00	Main negative contactor coil circuit short to power fault	
P0ADD-00	Main negative contactor coil circuit open fault	
P0ADE-00	Main negative contactor coil circuit current abnormal fault	
P0AA6-F1	High voltage relay closed, isolation level 2 fault	P0AA6-F1 、 P0AA6-F0 、 P0AA7-00 、 P0AA8-F0 、 P0AA8-F1 、 P0AA9-00
P0AA6-F0	High voltage relay closed, isolation level 1 fault	
P0AA7-00	isolation detection circuit fault	
P0AA8-F0	High voltage relay opened, isolation level 2 fault	
P0AA8-F1	High voltage relay opened, isolation level 1 fault	
P0AA9-00	double isolation resistance is low	
P0AC1-00	Current sensor fault	P0AC1-00 、 P0AC3-00 、 P0AC4-00
P0AC3-00	First current sensor zero offset high fault	
P0AC4-00	Current sample message lost	
P0AE3-00	Precharge relay stuck open fault	P0AE3-00 、 P1B0A-F0 、 P1B0A-F1 、 P1B09-F0 、 P0AE6-F0 、 P0AE6-F1 、 P0AE6-F2 、 P0AE7-00 、 P1B09-F1
P1B0A-F0	Precharge over current	
P1B0A-F1	Precharge short circuit	
P1B09-F0	Precharge timeout	
P0AE6-F0	Precharge contactor coil circuit short to GND fault	
P0AE6-F1	Precharge contactor coil circuit short to power fault	
P0AE6-F2	Precharge contactor coil circuit open fault	
P0AE7-00	Precharge contactor coil circuit current abnormal fault	
P1B09-F1	consecutivly precharges in a short period	
P0AF7-00	High voltage circuit open circuit	P0AF7-00 、 P0AFA-F0 、 P0AFB-F0
P0AFA-F0	Pack voltage low - level 1	
P0AFB-F0	Pack voltage high - level 1	
P0D94-00	vehicle Charging electronic lock state abnormal	P0D94-00

DTC	English descriptions	Reference page
P0DAD-00	balance circuit open	P0DAD-00 , P0DCA-00 , P0DE6-F0 , P0DE6-F1 , P0DE6-F2 , P0DE6-F3 , P0DE7-F0 , P0DE7-F1 , P0DE7-F2 , P0DE7-F3 , P1B02-00 , P1B11-F0 , C0111-96 , C0112-96 , P1B11-F1 , C1001-04 , P1E00-F0 , P1B44-00 , P1B48-00
P0DCA-00	balance circuit short	
P0DE6-F0	Single Cell undervoltage level1	
P0DE6-F1	single cell undervoltage level2	
P0DE6-F2	single cell undervoltage level3	
P0DE6-F3	single cell extremely undervoltage	
P0DE7-F0	Single Cell Over Voltage Level 1	
P0DE7-F1	Single Cell Over Voltage Level 2	
P0DE7-F2	Single Cell Over Voltage Level 3	
P0DE7-F3	Single Cell Over Voltage Extremely	
P1B02-00	BMS unintended reset	
P1B11-F0	Cell voltage sample open wire fault	
P1B11-F1	Cell voltage sensor fault	
P1E00-F0	Cell unbalance	
P1B44-00	balance circuit over temperature	
P1B48-00	balance circuit temperature invalid fault	
P1B19-00	AC charging socket temperature sensor fault	P1B19-00
P1B2B-00	DC charger provided power and BMS required power	The charger does not work, because it does not match the vehicle. Please replace the right charger.
P1B2E-00	DC charging socket temperature sensor fault	P1B2E-00
P1B34-00	Sensor failed during HV power on	
P1B37-00	heat relay stuck open fault	P1B37-00 , P1B38-00 , P1B51-00
P1B38-00	heater relay stuck close fault	
P1B51-00	Heating circuit open circuit	
P1B43-00	Crash fault(from vehicle CAN signal)	P1B43-00
P1B42-00	Charging stoped by OBC	Diagnose the CDU system for DTCs, and diagnosis and maintenance for the DTCs.
P1B55-00	Charging stoped by VCU	Diagnose the VCU system for DTCs, and diagnosis and maintenance for the DTCs.

BMS(CN)

DTC	English descriptions	Reference page
P1D45-F0	Cell temperature sensor fault - level 1	P1D45-F0 、 P1D45-F1 、 P1D45-F2 、 P1E01-F0 、 P1E01-F1 、 P1E01-F2 、 P1E02-F0 、 P1E03-F0
P1D45-F1	Cell temperature sensor fault - level 2	
P1D45-F2	Cell Temperature measurement fault	
P1E01-F0	Cell temperature high - level 1	
P1E01-F1	Cell temperature high - level 2	
P1E01-F2	Cell temperature high - level 3	
P1E02-F0	Cell temperature low - level 1	
P1E03-F0	Cell temperature difference high - level 1	
P1DF3-F1	DC charging socket over temperature level 2	P1DF3-F1 、 P1DF3-F0
P1DF3-F0	DC charging socket over temperature level 1	
P1DF2-F1	AC charging socket over temperature	P1DF2-F1
P1DF7-00	Over Current Peak Error	P1DF7-00 、 P1DF7-F0 、 P1DF7-F1 、 P1DF7-F2 、 P1DF8-F0 、 P1DF8-F1 、 P1DF8-F2 、 P1DF9-F0 、 P1DF9-F1 、 P1DF9-F2
P1DF7-F0	Discharge over current level 1	
P1DF7-F1	Discharge over current level 2	
P1DF7-F2	Discharge over current level 3	
P1DF8-F0	Charge over current level 1	
P1DF8-F1	Charge over current level 2	
P1DF8-F2	Charge over current level 3	
P1DF9-F0	Recharge over current level 1	
P1DF9-F1	Recharge over current level 2	
P1DF9-F2	Recharge over current level 3	
P1F03-00	CC2 short to GND	
U1007-00	DC charge equipment fault	U1007-00 、 U0073-87 、 U0074-88 、 U0111-87 、 U0112-87 、 U1001-00 、 U1009-00 、 U1013-00
U0073-88	Vehicle CAN BusOff fault	
U0074-88	BMS internal CAN Busoff fault	
U0111-87	Vehicle CAN Bus error	
U0112-87	BMS internal CAN Bus error	
U1001-00	BMS Charging CAN Busoff fault	
U1009-00	Internal daisy chain no update fault	
U1013-00	BMS stop charging abnormally	
P1B23-00	DC charging positive relay adhesion failure	P1B23-00 、 P1B1F-F0 、 P1B1F-F1 、 P1B1F-F2 、 P1B20-00
P1B1F-F0	DC charge positive contactor coil circuit short to GND fault	
P1B1F-F1	DC charge positive contactor coil circuit short to power fault	
P1B1F-F2	DC charge positive contactor coil circuit open fault	
P1B20-00	DC charge positive contactor coil circuit current abnormal fault	

DTC	English descriptions	Reference page
P1B25-F0	DC charge negative contactor coil circuit short to GND fault	P1B25-F0 、 P1B25-F1 、 P1B25-F2 、 P1B24-00
P1B25-F1	DC charge negative contactor coil circuit short to power fault	
P1B25-F2	DC charge negative contactor coil circuit open fault	
P1B24-00	DC charge negative contactor coil circuit over current fault	

P0561-00

Fault diagnosis code
P0561-00: BMU over temperature fault
Detection tools
1 Multimeter and diagnostic apparatus
Possible causes
<ul style="list-style-type: none">• BMS fault• Cooling system fault• BMS and PCB temperature circuit fault
Conditions for fault code operation
Turn the ignition switch to ON position.
Conditions for fault code setting
P0561-00
The temperature of BMU and PCB is too high: PCB sample temperature ≥ 105 °C (TBD)
To set the effect of a fault code condition
BMS function is limited

Troubleshooting steps	
Step 1	General inspection.
	<ol style="list-style-type: none"> 1 Check battery capacity. 2 Check the harness plug of BMS for damage, poor contact, aging and looseness. 3 Check whether the result is normal or not?
	NO → Repair or replace the faulted parts.
YES ↓	
Step 2	Check fault codes.
	<ol style="list-style-type: none"> 1 Connect the fault diagnosis instrument to the diagnosis interface. 2 Turn the ignition switch to ON position. 3 Diagnose the BMS with diagnostic apparatus. 4 Is there any other fault code except for P0561-00?
	YES → Refer to: DTC Summary list(BMS) .
NO ↓	
Step 3	Check cooling system.
	<ol style="list-style-type: none"> 1 Check whether there is leakage or poor heat dissipation in the cooling system. 2 Check whether the result is normal or not?
	NO → Repair the cooling system.
YES ↓	
Step 4	Check the connecting cable of BMS.
	<ol style="list-style-type: none"> 1 Turn the ignition switch to OFF. 2 Make protective preparations according to the safety operation specifications of the high voltage voltage in the maintenance manual. 3 Disconnect the harness plug battery pack high voltage. 4 Disconnect the high voltage harness plug of BMS. 5 Check whether the BMS connection cable is rotten, damaged, and water enters. 6 Check whether the result is normal or not?
	NO → Repair or replace the faulted parts.
YES ↓	

BMS(CN)

Step 5	Check BMS and PCB temperature circuit.
	<ol style="list-style-type: none"> 1 Turn the ignition switch to OFF. 2 Make protective preparations according to the safety operation specifications of the high voltage voltage in the maintenance manual. 3 Open the BMS end cover. 4 Check whether the BMS and PCB temperature circuit exist the situation of open or short circuit. 5 Check whether the BMS and PCB temperature circuit exist the situation of shorting to battery. 6 Check whether the result is normal or not?
	NO → Repair or replace the faulted parts.
YES ↓	
Step 6	Check BMS and PCB temperature signal checking module.
	<ol style="list-style-type: none"> 1 Turn the ignition switch to OFF. 2 Make protective preparations according to the safety operation specifications of the high voltage voltage in the maintenance manual. 3 Open the BMS end cover. 4 Check whether the BMS and PCB temperature signal checking module is damaged. 5 Check whether the result is normal or not?
	NO → Repair or replace the faulted parts.
YES ↓	
Step 7	Perform initialization.
	<ol style="list-style-type: none"> 1 Turn the ignition switch to OFF. 2 Connect the fault diagnosis instrument to the diagnosis interface. 3 Turn the ignition switch to ON. 4 The BMS module was initialized with the diagnostic instrument. 5 Can the BMS be initialized and is the BMS restored?
	NO → Repair or change the BMS module.
YES ↓	

Step 8	Test whether BMS is norm.
	<ol style="list-style-type: none"> 1 Turn the ignition switch to OFF. 2 Disconnect and check the harness plug EB90of BMS. 3 Check and repair. <ul style="list-style-type: none"> • Corrosion(install new adapting piece or terminal-cleaning module and pin). • Pin damaged or bent-install new terminal/pin. • Fly out of pins-install new pins as needed. 4 Reconnect the BMS plug and all other previously disconnected plug. Make sure the pin is properly positioned and fixed. 5 Run the system and determine if the problem persists?
	YES → Replace the BMS.
NO ↓	
At this point the system is functioning normally. The problem may be caused by module connections. Address the root cause of any connector or pin problems.	
Next Step ↓	
Diagnosis end.	

BMS(CN)

P0562-F1、 P0563-F1

Fault diagnosis code
P0562-F1: BMS Voltage below the Low_Threshold
P0563-F1: BMS Voltage above the High_Threshold
Detection tools
1 Multimeter and diagnostic apparatus
Possible causes
<ul style="list-style-type: none">• Circuit,terminal and adapting piece fault• Battery• BMS• Charging system• Insurance fuse
Conditions for fault code operation
Turn the ignition switch to ON position.
Conditions for fault code setting
P0562-F1
Low-voltage power supply voltage is lower than the normal operating range: BMS lead-acid sampling voltage $\leq 8400\text{mV}$
P0563-F1
Low-voltage power supply voltage is higher than the normal operating range: BMS lead-acid sampling voltage $\geq 16900\text{mV}$
To set the effect of a fault code condition
BMS function is limited
Description of circuit diagram
The BMS will monitor whether all sensors and actuators are within normal range all the time. Meanwhile,it will check the connector for virtual connection, short circuit, open circuit and the connection rationality with other signals. When fault occurs, the BMS module will save the fault code corresponding to that fault and enable safety mode.

Circuit diagram

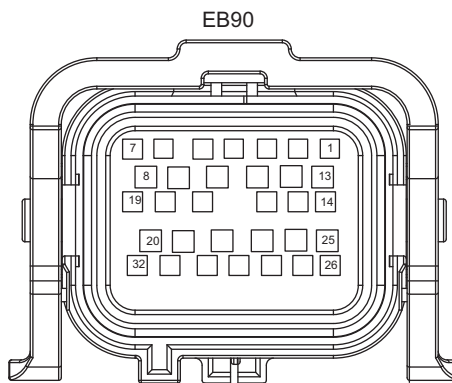
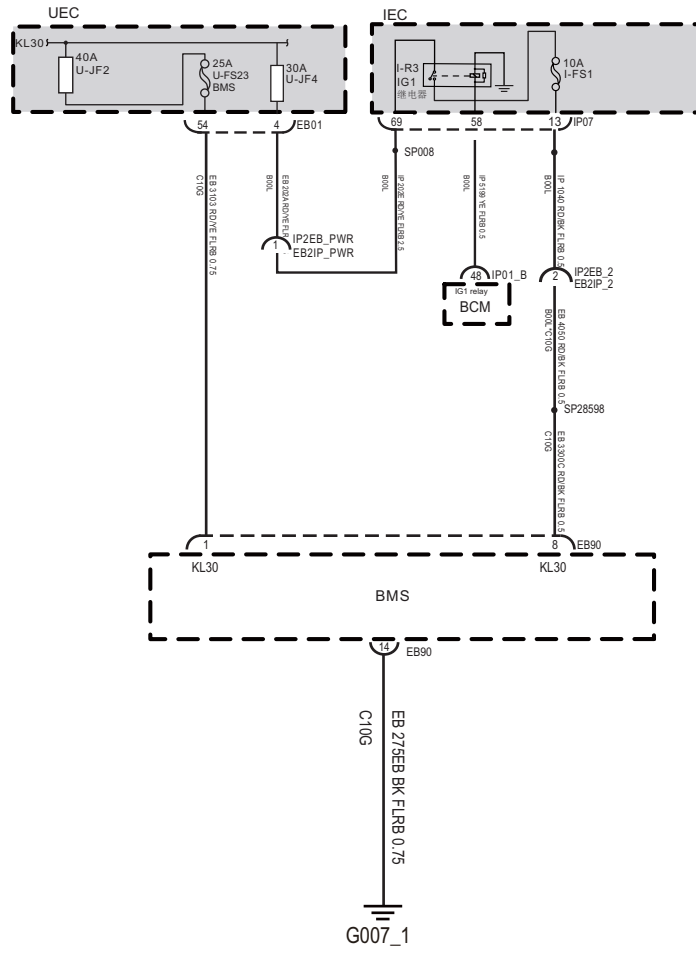

EK893001

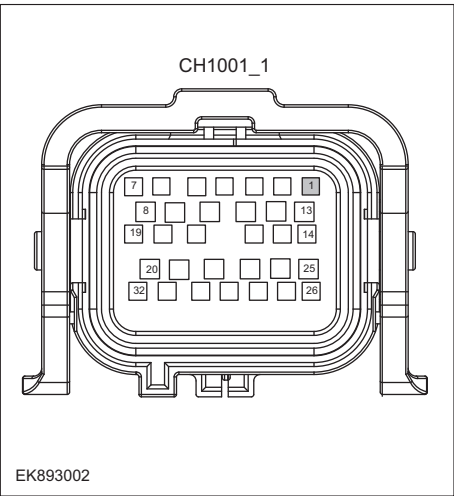
Troubleshooting steps	
Step 1	General inspection.
	<ol style="list-style-type: none"> 1 Check fuses EF30/F14 for damage. 2 Check battery capacity. 3 Check the harness plug of BMS for damage, poor contact, aging and looseness. 4 Check whether the result is normal or not?
NO → Repair or replace the faulted parts.	
YES ↓	
Step 2	Check fault codes.
	<ol style="list-style-type: none"> 1 Connect the fault diagnosis instrument to the diagnosis interface. 2 Turn the ignition switch to ON position. 3 Diagnose the BMS with diagnostic apparatus. 4 If there is any fault code except for P0562-F1,P0563-F1?
YES → Refer to: DTC Summary list(BMS) .	
NO ↓	
Step 3	Check the power voltage of BMS battery.
	<ol style="list-style-type: none"> 1 Turn the ignition switch to OFF. 2 Disconnect the harness plug EB90of BMS. 3 Measure the voltage between the harness terminal of BMS and ground. Measuring circuit: voltage between terminal 1 on plug EB90and ground. Standard value:10~14V 4 Check whether the result is normal or not?
NO → Repair or replace the faulted parts.	
YES ↓	

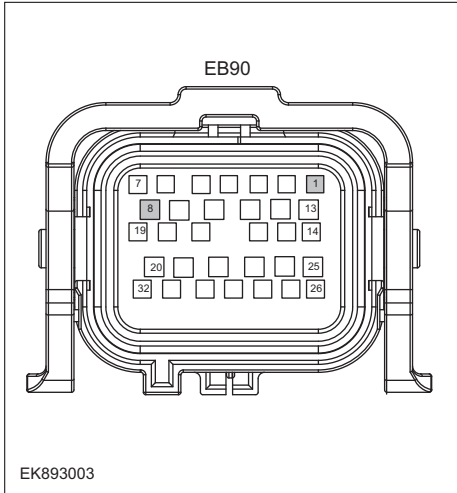
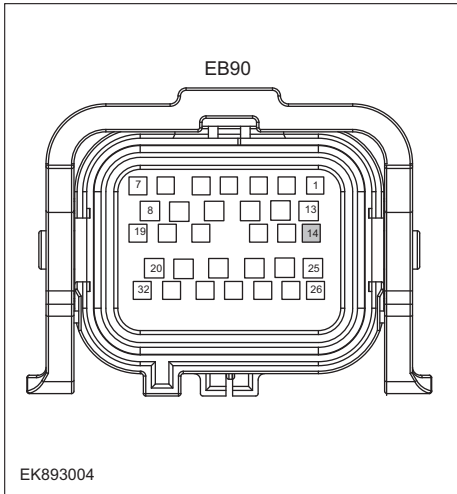
Step 4	Check the power voltage when the BMS is started or operating
 <p>EB90</p> <p>EK893003</p>	<ol style="list-style-type: none"> 1 Turn the ignition switch to ON. 2 Measure the voltage between the harness terminal of BMS and ground. Measuring circuit: voltage between terminal 1 on plug EB90 and ground. Measuring circuit: voltage between terminal 8 on plug EB90 and ground. Standard value: 10~14V 3 Check whether the result is normal or not?
NO → Repair or replace the faulted parts.	
YES ↓	
Step 5	Test whether the grounding circuit of BMS is open.
 <p>EB90</p> <p>EK893004</p>	<ol style="list-style-type: none"> 1 Turn the ignition switch to OFF. 2 Disconnect the harness plug EB90 of BMS. 3 Measure the resistance between the harness terminal of BMS and ground. Measuring circuit: resistance between terminal 14 on plug EB90 and ground. Standard value: < 1Ω 4 Test whether the resistance is less than 1Ω?
NO → Repair or replace the faulted parts.	
YES ↓	

BMS(CN)

Step 6	Test whether BMS is norm.
	<ol style="list-style-type: none"> 1 Turn the ignition switch to OFF. 2 Disconnect and check the harness plug EB90of BMS. 3 Check and repair. <ul style="list-style-type: none"> • Corrosion(install new adapting piece or terminal-cleaning module and pin). • Pin damaged or bent-install new terminal/pin. • Fly out of pins-install new pins as needed. 4 Reconnect the BMS plug and all other previously disconnected plug. Make sure the pin is properly positioned and fixed. 5 Run the system and determine if the problem persists?
	YES → Replace the BMS.
NO ↓	
At this point the system is functioning normally. The problem may be caused by module connections. Address the root cause of any connector or pin problems.	
Next Step ↓	
Diagnosis end.	

P0A0A-00、 P0A0B-00、 P0A0C-00、 P0A0D-00

Fault diagnosis code
P0A0A-00: High voltage interlock loop 1 open circuit
P0A0B-00: High voltage interlock loop invalid
P0A0C-00: High voltage interlock loop 1 short to GND
P0A0D-00: High voltage interlock loop 1 short to source power
Detection tools
1 Multimeter and diagnostic apparatus
Possible causes
<ul style="list-style-type: none"> • Circuit,terminal and adapting piece fault • BMS fault • Interlock instrument fault
Conditions for fault code operation
Turn the ignition switch to ON position.
Conditions for fault code setting
P0A0A-00
High voltage interlock loop 1 open, loop resistance value is greater than the set range
P0A0B-00
High voltage interlock loop 1 short to source power
P0A0C-00
High voltage interlock loop 1 short to GND
P0A0D-00
If the state of HV interlock is greater than 7 times in the 13 check periods, it is a HV interlock loop error, but it is not a "HV interlock loop short" or "HV interlock loop short" or "HV interlock loop short to ground"
To set the effect of a fault code condition
High voltage component does not work properly
Description of circuit diagram
BMS always monitors high voltage interlock circuit. Meanwhile,it will check the connector for virtual connection, short circuit, open circuit and the connection rationality with other signals. When fault occurs, the BMS module will save the fault code corresponding to that fault and enable safety mode.

Circuit diagram

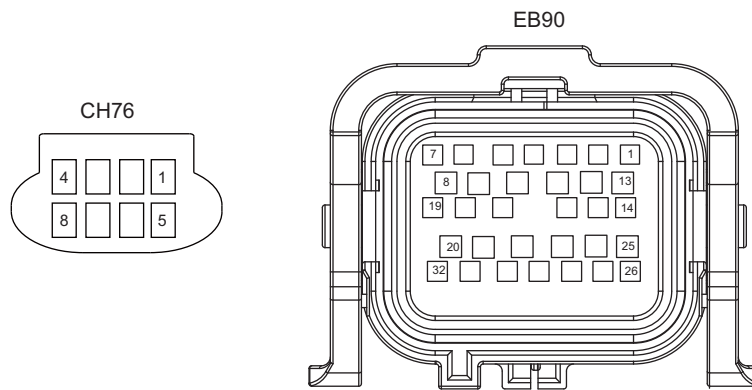
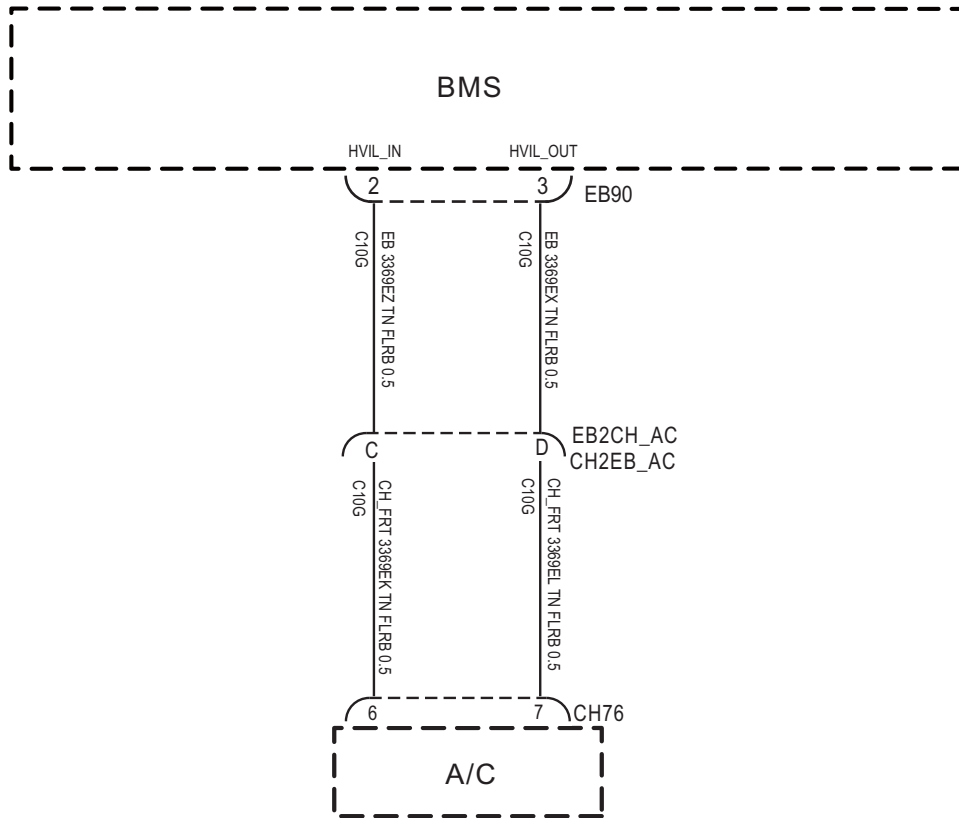

EK893005

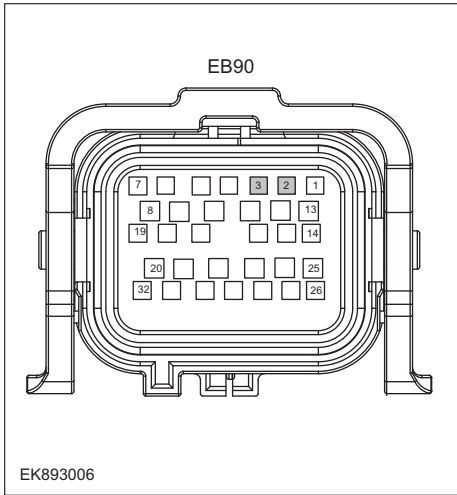
Troubleshooting steps	
Step 1	General inspection.
	<ol style="list-style-type: none"> 1 Check the fuse for damage. 2 Check battery capacity. 3 Check the harness plug of BMS for damage, poor contact, aging and looseness. 4 Check whether the result is normal or not?
	NO → Repair or replace the faulted parts.
YES ↓	
Step 2	Check fault codes.
	<ol style="list-style-type: none"> 1 Connect the fault diagnosis instrument to the diagnosis interface. 2 Turn the ignition switch to ON position. 3 Diagnose the BMS with diagnostic apparatus. 4 Is there any other fault code except for P0A0A-00、P0A0B-00、P0A0C-00、P0A0D-00?
	YES → Refer to: DTC Summary list(BMS) .
NO ↓	
Step 3	Check BMS interlock circuit. (Open circuit)
	<ol style="list-style-type: none"> 1 Turn the ignition switch to OFF. 2 Disconnect the harness plug EB90 of BMS. 3 Measure the resistance between the harness terminals of BMS. Measuring circuit: resistance between terminal 2 and terminal 3 on plug EB90. Standard value: < 1Ω 4 Check whether the result is normal or not?
	NO → Repair or replace the faulted parts.
YES ↓	

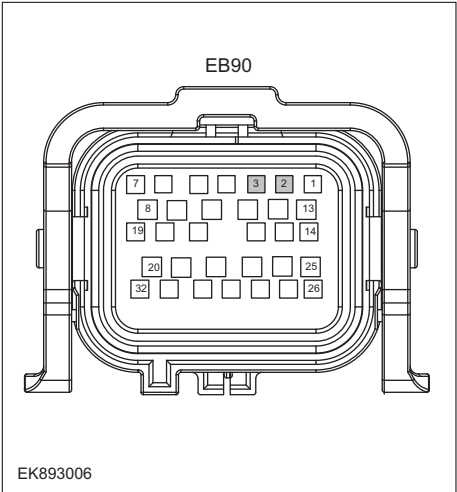
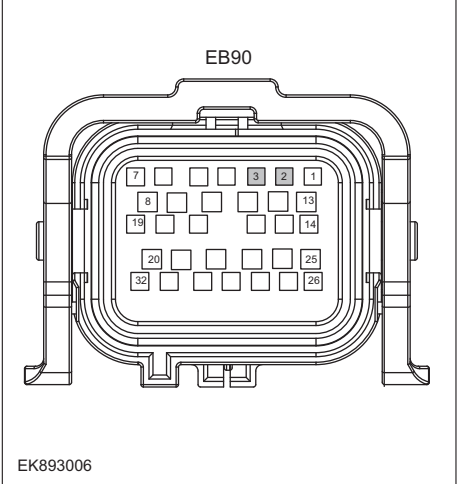
Step 4	Check BMS interlock instrument. (Module terminal)
 <p style="text-align: center;">EB90</p> <p style="text-align: left;">EK893006</p>	<ol style="list-style-type: none"> 1 Measure the resistance between the harness terminals of BMS(Module terminal). Measuring circuit: resistance between terminal 2 and terminal 3 on plug EB90. Standard value: < 1Ω 2 Check whether the result is normal or not?
NO → Repair or replace the faulted parts.	
YES ↓	
Step 5	Check BMS interlock circuit. (Short circuit)
 <p style="text-align: center;">EB90</p> <p style="text-align: left;">EK893006</p>	<ol style="list-style-type: none"> 1 Turn the ignition switch to OFF. 2 Measure the resistance between the harness terminal of BMS and ground. Measuring circuit: resistance between terminal 2 on plug EB90and ground. Measuring circuit: resistance between terminal 3 on plug EB90and ground. Standard value: ∞ 3 Measure the voltage between the harness terminal of BMS and ground. Measuring circuit: voltage between terminal 2 on plug EB90and ground. Measuring circuit: voltage between terminal 3 on plug EB90and ground. Standard value: ≈ 0V 4 Check whether the result is normal or not?
NO → Repair or replace the faulted parts.	
YES ↓	

Step 6	Test whether BMS is norm.
	<ol style="list-style-type: none"> 1 Turn the ignition switch to OFF. 2 Disconnect and check the harness plug EB90of BMS. 3 Check and repair. <ul style="list-style-type: none"> • Corrosion(install new adapting piece or terminal-cleaning module and pin). • Pin damaged or bent-install new terminal/pin. • Fly out of pins-install new pins as needed. 4 Reconnect the BMS plug and all other previously disconnected plug. Make sure the pin is properly positioned and fixed. 5 Run the system and determine if the problem persists?
	YES → Replace the BMS.
NO ↓	
At this point the system is functioning normally. The problem may be caused by module connections. Address the root cause of any connector or pin problems.	
Next Step ↓	
Diagnosis end.	

BMS(CN)

P0A7D-F0、 P0A80-F0、 P0C30-F0、 P1DF6-F0、 P1DF6-F1

Fault diagnosis code
P0A7D-F0: SOC too low
P0A80-F0: SOC jump
P0C30-F0: SOC too high
P1DF6-F0: SOH low level 1
P1DF6-F1: SOH low level 2
Detection tools
1 Multimeter and diagnostic apparatus
Possible causes
<ul style="list-style-type: none">• Circuit,terminal and adapting piece fault• BMS fault• The SOC circuit of BMS fault• Battery pack fault
Conditions for fault code operation
Turn the ignition switch to ON position.
Conditions for fault code setting
P0A7D-F0
If the SOC is lower than the lower limit: display SOC \leq 0%
P0A80-F0
(The BMS detected a missing storage SOC value)&&(The SOC values are shown to be corrected for voltmeter)
P0C30-F0
If the SOC is higher than the higher limit: the displayed SOC value from power-on read storage $>$ 100%
P1DF6-F0
SOH reaches the alarm threshold: SOH \leq 80%
P1DF6-F1
SOH reaches the alarm threshold: SOH \leq 70%
To set the effect of a fault code condition
SOC fault
Description of circuit diagram
BMS always monitors internal sensor and circuit. Meanwhile,it will check the connector for virtual connection, short circuit, open circuit and the connection rationality with other signals. When fault occurs, the BMS module will save the fault code corresponding to that fault and enable safety mode.

Troubleshooting steps	
Step 1	General inspection.
	<ol style="list-style-type: none"> 1 Check the fuse for damage. 2 Check battery capacity. 3 Check the harness plug of BMS for damage, poor contact, aging and looseness. 4 Check whether the result is normal or not?
	NO → Repair or replace the faulted parts.
YES ↓	
Step 2	Check fault codes.
	<ol style="list-style-type: none"> 1 Connect the fault diagnosis instrument to the diagnosis interface. 2 Turn the ignition switch to ON position. 3 Diagnose the BMS with diagnostic apparatus. 4 Is there any other fault code except for P0A7D-F0/P0A80-F0/P0C30-F0/P1DF6-F0/P1DF6-F1?
	YES → Refer to: DTC Summary list(BMS) .
NO ↓	
Step 3	Check the connecting cable of BMS.
	<ol style="list-style-type: none"> 1 Turn the ignition switch to OFF. 2 Make protective preparations according to the safety operation specifications of the high voltage voltage in the maintenance manual. 3 Disconnect the harness plug battery pack high voltage. 4 Disconnect the high voltage harness plug of BMS. 5 Check whether the BMS connection cable is rotten, damaged, and water enters. 6 Check whether the result is normal or not?
	NO → Repair or replace the faulted parts.
YES ↓	

BMS(CN)

Step 4	Perform initialization.
	<ol style="list-style-type: none"> 1 Turn the ignition switch to OFF. 2 Connect the fault diagnosis instrument to the diagnosis interface. 3 Turn the ignition switch to ON. 4 The BMS module was initialized with the diagnostic instrument. 5 Can the BMS be initialized and is the BMS restored?
	NO → Repair or change the BMS module.
YES ↓	
Step 5	Check the battery pack battery health status.
	<ol style="list-style-type: none"> 1 Use a diagnostic device to check the health of the battery pack. (If this function is available) 2 Check the battery pack battery health status?
	NO → Repair or replace the battery pack.
YES ↓	
Step 6	Test whether BMS is norm.
	<ol style="list-style-type: none"> 1 Turn the ignition switch to OFF. 2 Disconnect and check the harness plug EB90of BMS. 3 Check and repair. <ul style="list-style-type: none"> • Corrosion(install new adapting piece or terminal-cleaning module and pin). • Pin damaged or bent-install new terminal/pin. • Fly out of pins-install new pins as needed. 4 Reconnect the BMS plug and all other previously disconnected plug. Make sure the pin is properly positioned and fixed. 5 Run the system and determine if the problem persists?
	YES → Replace the BMS.
NO ↓	
At this point the system is functioning normally. The problem may be caused by module connections. Address the root cause of any connector or pin problems.	
Next Step ↓	
Diagnosis end.	

P0AA1-00、 P0AA2-00、 P0ADB-00、 P0ADC-00、 P0AD9-00、 P0ADA-00

Fault diagnosis code
P0AA1-00: Main positive or precharge relay stuck fault
P0AA2-00: Main positive relay open fault
P0ADB-00: Main positive contactor coil circuit short to GND fault
P0ADC-00: Main positive contactor coil circuit short to power fault
P0AD9-00: Main positive contactor coil circuit open fault
P0ADA-00: Main positive contactor coil circuit current abnormal fault
Detection tools
1 Multimeter and diagnostic apparatus
Possible causes
<ul style="list-style-type: none"> • BMS fault • Main positive relay fault • BMS main positive relay circuit fault
Conditions for fault code operation
Turn the ignition switch to ON position.
Conditions for fault code setting
P0AA1-00
$ \text{Main positive relay outside lateral voltage} - \text{main positive relay inside lateral voltage} < 5\% * \text{main positive relay inside lateral voltage}$
P0AA2-00
After closing main negative relay, $ \text{pack voltage } U1-U7 > 10\% \text{pack voltage } U1$;
P0ADB-00
Main positive relay coil circuit diagnosis voltage 300Mv
P0ADC-00
Main positive relay coil circuit diagnosis voltage 1000Mv
P0AD9-00
Main positive relay coil circuit diagnosis voltage 500Mv
P0ADA-00
To set the effect of a fault code condition

Troubleshooting steps	
Step 1	General inspection.
	<ol style="list-style-type: none"> 1 Check battery capacity. 2 Check the harness plug of BMS for damage, poor contact, aging and looseness. 3 Check the harness plug of battery pack high voltage for damage, poor contact, aging and looseness. 4 Check whether the result is normal or not?
	NO → Repair or replace the faulted parts.
YES ↓	
Step 2	Check fault codes.
	<ol style="list-style-type: none"> 1 Connect the fault diagnosis instrument to the diagnosis interface. 2 Turn the ignition switch to ON position. 3 Diagnose the BMS with diagnostic apparatus. 4 If there is any fault code except for P0AA1-00、 P0AA2-00、 P0ADB-00、 P0ADC-00、 P0AD9-00、 P0ADA-00?
	YES → Refer to: DTC Summary list(BMS) .
NO ↓	
Step 3	Check the connecting cable of BMS.
	<ol style="list-style-type: none"> 1 Turn the ignition switch to OFF. 2 Make protective preparations according to the safety operation specifications of the high voltage voltage in the maintenance manual. 3 Disconnect the harness plug battery pack high voltage. 4 Disconnect the high voltage harness plug of BMS. 5 Check whether the BMS connection cable is rotten, damaged, and water enters. 6 Check whether the result is normal or not?
	NO → Repair or replace the faulted parts.
YES ↓	

Step 4	Check the main positive relay circuit.
	<ol style="list-style-type: none"> 1 Turn the ignition switch to OFF. 2 Make protective preparations according to the safety operation specifications of the high voltage voltage in the maintenance manual. 3 Open the BMS end cover. 4 Check whether the main positive relay circuit exist the situation of open or short circuit. 5 Check whether the main positive relay circuit exist the situation of shorting to battery. 6 Check whether the result is normal or not?
	NO → Repair or replace the faulted parts.
YES ↓	
Step 5	Check main positive relay signal checking module.
	<ol style="list-style-type: none"> 1 Turn the ignition switch to OFF. 2 Make protective preparations according to the safety operation specifications of the high voltage voltage in the maintenance manual. 3 Open the BMS end cover. 4 Check whether the main positive relay signal checking module is damaged. 5 Check whether the result is normal or not?
	NO → Repair or replace the faulted parts.
YES ↓	
Step 6	Check the main positive relay(components).
	<ol style="list-style-type: none"> 1 Check the harness plug of BMS internal main positive relay for damage, poor contact, aging and looseness. 2 Check whether the BMS internal main positive relay works. 3 Check whether the result is normal or not?
	NO → Repair or replace the faulted parts.
YES ↓	

BMS(CN)

Step 7	Perform initialization.	
		<ol style="list-style-type: none"> 1 Turn the ignition switch to OFF. 2 Connect the fault diagnosis instrument to the diagnosis interface. 3 Turn the ignition switch to ON. 4 The BMS module was initialized with the diagnostic instrument. 5 Can the BMS be initialized and is the BMS restored?
		NO → Repair or change the BMS module.
YES ↓		
Step 8	Test whether BMS is norm.	
		<ol style="list-style-type: none"> 1 Turn the ignition switch to OFF. 2 Disconnect and check the harness plug EB90of BMS. 3 Check and repair. <ul style="list-style-type: none"> • Corrosion(install new adapting piece or terminal-cleaning module and pin). • Pin damaged or bent-install new terminal/pin. • Fly out of pins-install new pins as needed. 4 Reconnect the BMS plug and all other previously disconnected plug. Make sure the pin is properly positioned and fixed. 5 Run the system and determine if the problem persists?
		YES → Replace the BMS.
NO ↓		
At this point the system is functioning normally. The problem may be caused by module connections. Address the root cause of any connector or pin problems.		
Next Step ↓		
Diagnosis end.		

P0AA4-00、 P0AA5-00、 P0ADF-00、 P0AE0-00、 P0ADD-00、 P0ADE-00

Fault diagnosis code
P0AA4-00: Main negative relay stuck fault
P0AA5-00: Main negative relay stuck open fault
P0ADF-00: Main negative contactor coil circuit short to GND fault
P0AE0-00: Main negative contactor coil circuit short to power fault
P0ADD-00: Main negative contactor coil circuit open fault
P0ADE-00: Main negative contactor coil circuit current abnormal fault
Detection tools
1 Multimeter and diagnostic apparatus
Possible causes
<ul style="list-style-type: none"> • BMS fault • Main negative relay fault • BMS main negative relay circuit fault
Conditions for fault code operation
Turn the ignition switch to ON position.
Conditions for fault code setting
P0AA4-00
After closing main negative relay, $ \text{pack voltage U1-main negative relay outside lateral voltage U7} 5\% * \text{pack voltage U1}$;
P0AA5-00
After closing main negative relay, $ \text{pack voltage U1-U7} > 10\% \text{pack voltage U1}$;
P0ADF-00
Main negative contactor coil circuit diagnosis voltage 300Mv
P0AE0-00
Main negative contactor coil circuit diagnosis voltage 1000Mv
P0ADD-00
Main negative contactor coil circuit diagnosis voltage $< 500\text{Mv}$
P0ADE-00
To set the effect of a fault code condition

Troubleshooting steps	
Step 1	General inspection.
	<ol style="list-style-type: none"> 1 Check battery capacity. 2 Check the harness plug of BMS for damage, poor contact, aging and looseness. 3 Check the harness plug of battery pack high voltage for damage, poor contact, aging and looseness. 4 Check whether the result is normal or not?
	NO → Repair or replace the faulted parts.
YES ↓	
Step 2	Check fault codes.
	<ol style="list-style-type: none"> 1 Connect the fault diagnosis instrument to the diagnosis interface. 2 Turn the ignition switch to ON position. 3 Diagnose the BMS with diagnostic apparatus. 4 If there is any fault code except for P0AA4-00、 P0AA5-00、 P0ADF-00、 P0AE0-00、 P0ADD-00、 P0ADE-00?
	YES → Refer to: DTC Summary list(BMS) .
NO ↓	
Step 3	Check the connecting cable of BMS.
	<ol style="list-style-type: none"> 1 Turn the ignition switch to OFF. 2 Make protective preparations according to the safety operation specifications of the high voltage voltage in the maintenance manual. 3 Disconnect the harness plug battery pack high voltage. 4 Disconnect the high voltage harness plug of BMS. 5 Check whether the BMS connection cable is rotten, damaged, and water enters. 6 Check whether the result is normal or not?
	NO → Repair or replace the faulted parts.
YES ↓	

Step 4	Check the main negative relay circuit.
	<ol style="list-style-type: none"> 1 Turn the ignition switch to OFF. 2 Make protective preparations according to the safety operation specifications of the high voltage voltage in the maintenance manual. 3 Open the BMS end cover. 4 Check whether the main negative relay circuit exist the situation of open or short circuit. 5 Check whether the main negative relay circuit exist the situation of shorting to battery. 6 Check whether the result is normal or not?
	NO → Repair or replace the faulted parts.
YES ↓	
Step 5	Check main negative relay signal checking module.
	<ol style="list-style-type: none"> 1 Turn the ignition switch to OFF. 2 Make protective preparations according to the safety operation specifications of the high voltage voltage in the maintenance manual. 3 Open the BMS end cover. 4 Check whether the main negative relay signal checking module is damaged. 5 Check whether the result is normal or not?
	NO → Repair or replace the faulted parts.
YES ↓	
Step 6	Check the main negative relay(components).
	<ol style="list-style-type: none"> 1 Check the harness plug of BMS internal main negative relay for damage, poor contact, aging and looseness. 2 Check whether the BMS internal main negative relay works. 3 Check whether the result is normal or not?
	NO → Repair or replace the faulted parts.
YES ↓	

BMS(CN)

Step 7	Perform initialization.	
		<ol style="list-style-type: none"> 1 Turn the ignition switch to OFF. 2 Connect the fault diagnosis instrument to the diagnosis interface. 3 Turn the ignition switch to ON. 4 The BMS module was initialized with the diagnostic instrument. 5 Can the BMS be initialized and is the BMS restored?
		NO → Repair or change the BMS module.
YES ↓		
Step 8	Test whether BMS is norm.	
		<ol style="list-style-type: none"> 1 Turn the ignition switch to OFF. 2 Disconnect and check the harness plug EB90of BMS. 3 Check and repair. <ul style="list-style-type: none"> • Corrosion(install new adapting piece or terminal-cleaning module and pin). • Pin damaged or bent-install new terminal/pin. • Fly out of pins-install new pins as needed. 4 Reconnect the BMS plug and all other previously disconnected plug. Make sure the pin is properly positioned and fixed. 5 Run the system and determine if the problem persists?
		YES → Replace the BMS.
NO ↓		
At this point the system is functioning normally. The problem may be caused by module connections. Address the root cause of any connector or pin problems.		
Next Step ↓		
Diagnosis end.		

P0AA6-F1、 P0AA6-F0、 P0AA7-00、 P0AA8-F0、 P0AA8-F1、 P0AA9-00

Fault diagnosis code
P0AA6-F1: High voltage relay closed, isolation level 2 fault
P0AA6-F0: High voltage relay closed, isolation level 1 fault
P0AA7-00: isolation detection circuit fault
P0AA8-F0: High voltage relay opened, isolation level 2 fault
P0AA8-F1: High voltage relay opened, isolation level 1 fault
P0AA9-00: double isolation resistance is low
Detection tools
1 Multimeter, diagnostic apparatus and tramegger.
Possible causes
<ul style="list-style-type: none"> • BMS fault • Cooling system fault
Conditions for fault code operation
Turn the ignition switch to ON position.
Conditions for fault code setting
P0AA6-F1
The insulation value of the high voltage system is lower than the fault threshold: insulation resistance value $\leq 500\Omega/V$ (DC charging $\leq 100\Omega/V$)(when high voltage relay closed)
P0AA6-F0
The insulation value of the high voltage system is lower than the fault threshold: insulation resistance value $\leq 750\Omega/V$ (DC charging $\leq 500\Omega/V$)(when high voltage relay closed)
P0AA7-00
When the two Mos tubes are closed, the positive voltage and negative voltage do not conform to the voltage: The sum of voltage values $\leq 0.9*$ Pack voltage The sum of voltage values $(V_p, V_n) \leq 1.1*$ Pack voltage Invalid insulation sampling voltage
P0AA8-F0
The high voltage insulation values between main positive relay and main negative relay are lower than fault threshold. Insulation resistance value $\leq 500\Omega/V$ (DC charging $\leq 100\Omega/V$) (when the high voltage relay closed)
P0AA8-F1
The high voltage insulation values between main positive relay and main negative relay are lower than alarm threshold: Insulation resistance value $\leq 750\Omega/V$ (DC charging $\leq 500\Omega/V$) (when the high voltage relay closed)
P0AA9-00
Positive insulation and negative insulation value are below than alarm threshold value: insulation resistance value $\leq 500\Omega/V$ (DC charging $\leq 100\Omega/V$)

BMS(CN)

To set the effect of a fault code condition
High voltage component does not work properly

Troubleshooting steps	
Step 1	General inspection.
	<ol style="list-style-type: none"> 1 Check battery capacity. 2 Check the harness plug of BMS for damage, poor contact, aging and looseness. 3 Check the harness plug of battery pack high voltage for damage, poor contact, aging and looseness. 4 Check whether the result is normal or not?
	NO → Repair or replace the faulted parts.
YES ↓	
Step 2	Check fault codes.
	<ol style="list-style-type: none"> 1 Connect the fault diagnosis instrument to the diagnosis interface. 2 Turn the ignition switch to ON position. 3 Diagnose the BMS with diagnostic apparatus. 4 If there is any fault code except for P0AA6-F1、 P0AA6-F0、 P0AA7-00、 P0AA8-F0、 P0AA8-F1、 P0AA9-00?
	YES → Refer to: DTC Summary list(BMS) .
NO ↓	
Step 3	Check the connecting cable of BMS.
	<ol style="list-style-type: none"> 1 Turn the ignition switch to OFF. 2 Make protective preparations according to the safety operation specifications of the high voltage voltage in the maintenance manual. 3 Disconnect the harness plug battery pack high voltage. 4 Disconnect the high voltage harness plug of BMS. 5 Check whether the BMS connection cable is rotten, damaged, and water enters. 6 Check whether the result is normal or not?
	NO → Repair or replace the faulted parts.
YES ↓	

BMS(CN)

Step 4	Check the insulation of BMS.	
	1	Use a megohm meter to check the insulation resistance of the BMS housing and grounding according to the procedure in the maintenance manual. Standard value (insulation level 1) > 750Ω/V (DC charging > 500Ω/V) Standard value (insulation level 2) > 500Ω/V (DC charging > 100Ω/V)
	2	Check whether the result is normal or not?
	NO →	Repair or replace the faulted parts.
YES ↓		
Step 5	Check the insulation of BMS high-voltage cables.	
	1	Use a megohm meter to check the insulation resistance of the BMS high voltage and grounding according to the procedure in the maintenance manual. Standard value (insulation level 1) > 750Ω/V (DC charging > 500Ω/V) Standard value (insulation level 2) > 500Ω/V (DC charging > 100Ω/V)
	2	Check whether the result is normal or not?
	NO →	Repair or replace the faulted parts.
YES ↓		
Step 6	Perform initialization.	
	1	Turn the ignition switch to OFF.
	2	Connect the fault diagnosis instrument to the diagnosis interface.
	3	Turn the ignition switch to ON.
	4	The BMS module was initialized with the diagnostic instrument.
	5	Can the BMS be initialized and is the BMS restored?
	NO →	Repair or change the BMS module.
YES ↓		

Step 7	Test whether BMS is norm.
	<ol style="list-style-type: none"> 1 Turn the ignition switch to OFF. 2 Disconnect and check the harness plug EB90of BMS. 3 Check and repair. <ul style="list-style-type: none"> • Corrosion(install new adapting piece or terminal-cleaning module and pin). • Pin damaged or bent-install new terminal/pin. • Fly out of pins-install new pins as needed. 4 Reconnect the BMS plug and all other previously disconnected plug. Make sure the pin is properly positioned and fixed. 5 Run the system and determine if the problem persists?
	YES → Replace the BMS.
NO ↓	
At this point the system is functioning normally. The problem may be caused by module connections. Address the root cause of any connector or pin problems.	
Next Step ↓	
Diagnosis end.	

BMS(CN)

P0AC1-00、 P0AC3-00、 P0AC4-00

Fault diagnosis code
P0AC1-00: Current sensor fault
P0AC3-00: First current sensor zero offset high fault
P0AC4-00: Current sample message lost
Detection tools
1 Multimeter and diagnostic apparatus
Possible causes
<ul style="list-style-type: none">• BMS fault• The current circuit of BMS fault
Conditions for fault code operation
Turn the ignition switch to ON position.
Conditions for fault code setting
P0AC1-00
(Out of detection range (-800A, +800A)) (D2D communication fault) (CSU current is not updated) (CSU power supply voltage fault) (SHUNT open)
P0AC3-00
When all contactor coils are disconnected and there is no adhesive failure, $ \text{total circuit current} \geq 2\text{A}$
P0AC4-00
The BMU cannot receive current packets from the CSU.
To set the effect of a fault code condition
BMS function is limited

Troubleshooting steps	
Step 1	General inspection.
	<ol style="list-style-type: none"> 1 Check battery capacity. 2 Check the harness plug of BMS for damage, poor contact, aging and looseness. 3 Check whether the result is normal or not?
	NO → Repair or replace the faulted parts.
YES ↓	
Step 2	Check fault codes.
	<ol style="list-style-type: none"> 1 Connect the fault diagnosis instrument to the diagnosis interface. 2 Turn the ignition switch to ON position. 3 Diagnose the BMS with diagnostic apparatus. 4 Is there any other fault code except for P0AC1-00/P0AC3-00/P0AC4-00?
	YES → Refer to: DTC Summary list(BMS) .
NO ↓	
Step 3	Check cooling system.
	<ol style="list-style-type: none"> 1 Check whether there is leakage or poor heat dissipation in the cooling system. 2 Check whether the result is normal or not?
	NO → Repair the cooling system.
YES ↓	
Step 4	Check the connecting cable of BMS.
	<ol style="list-style-type: none"> 1 Turn the ignition switch to OFF. 2 Make protective preparations according to the safety operation specifications of the high voltage voltage in the maintenance manual. 3 Disconnect the harness plug battery pack high voltage. 4 Disconnect the high voltage harness plug of BMS. 5 Check whether the BMS connection cable is rotten, damaged, and water enters. 6 Check whether the result is normal or not?
	NO → Repair or replace the faulted parts.
YES ↓	

BMS(CN)

Step 5	Check current sampling circuit.
	<ol style="list-style-type: none"> 1 Turn the ignition switch to OFF. 2 Make protective preparations according to the safety operation specifications of the high voltage voltage in the maintenance manual. 3 Open the BMS end cover. 4 Check whether the current sampling circuit exist the situation of open or short circuit. 5 Check whether the current sampling circuit exist the situation of shorting to battery. 6 Check whether the result is normal or not?
	NO → Repair or replace the faulted parts.
YES ↓	
Step 6	Check current sampling signal checking module.
	<ol style="list-style-type: none"> 1 Turn the ignition switch to OFF. 2 Make protective preparations according to the safety operation specifications of the high voltage voltage in the maintenance manual. 3 Open the BMS end cover. 4 Check whether the current sampling signal checking module is damaged. 5 Check whether the result is normal or not?
	NO → Repair or replace the faulted parts.
YES ↓	
Step 7	Perform initialization.
	<ol style="list-style-type: none"> 1 Turn the ignition switch to OFF. 2 Connect the fault diagnosis instrument to the diagnosis interface. 3 Turn the ignition switch to ON. 4 The BMS module was initialized with the diagnostic instrument. 5 Can the BMS be initialized and is the BMS restored?
	NO → Repair or change the BMS module.
YES ↓	

Step 8	Test whether BMS is norm.
	<ol style="list-style-type: none"> 1 Turn the ignition switch to OFF. 2 Disconnect and check the harness plug EB90of BMS. 3 Check and repair. <ul style="list-style-type: none"> • Corrosion(install new adapting piece or terminal-cleaning module and pin). • Pin damaged or bent-install new terminal/pin. • Fly out of pins-install new pins as needed. 4 Reconnect the BMS plug and all other previously disconnected plug. Make sure the pin is properly positioned and fixed. 5 Run the system and determine if the problem persists?
	YES → Replace the BMS.
NO ↓	
At this point the system is functioning normally. The problem may be caused by module connections. Address the root cause of any connector or pin problems.	
Next Step ↓	
Diagnosis end.	

BMS(CN)

P0AE3-00、P1B0A-F0、P1B0A-F1、P1B09-F0、P0AE6-F0、P0AE6-F1、P0AE6-F2、P0AE7-00、P1B09-F1

Fault diagnosis code
P0AE3-00: Precharge relay stuck open fault
P1B0A-F0: Precharge over current
P1B0A-F1: Precharge short circuit
P1B09-F0: Precharge timeout
P0AE6-F0: Precharge contactor coil circuit short to GND fault
P0AE6-F1: Precharge contactor coil circuit short to power fault
P0AE6-F2: Precharge contactor coil circuit open fault
P0AE7-00: Precharge contactor coil circuit current abnormal fault
P1B09-F1: consecutivly precharges in a short period
Detection tools
1 Multimeter and diagnostic apparatus
Possible causes
<ul style="list-style-type: none"> • BMS fault • Precharge relay fault • BMS precharge relay circuit fault
Conditions for fault code operation
Turn the ignition switch to ON position.
Conditions for fault code setting
P0AE3-00
During a period of time when the precharged relay is requested to close, it is checked that the precharged relay cannot close: positive relay outside lateral voltage $\leq 50\%$ * main positive relay inside lateral voltage&& bus current $\leq 2A$
P1B0A-F0
The precharge current exceeds the overcurrent protection threshold of the precharge resistor:main circuit current $\geq 0.3^*$ (HV_in / precharge resistance value)
P1B0A-F1
The precharge current exceeds the short circuit protection threshold of the precharge resistor: (Outside lateral high voltage ≤ 0.4 times battery voltage)&&(main circuit current $\geq 0.6 * (HV_in / precharge resistance value)$)
P1B09-F0
The precharge current exceeds the overtime protection threshold of the precharge resistor: [Main positive relay outside lateral - main positive relay inside lateral voltage $< 10V$; precharge times are 3 times.
P0AE6-F0
Precharge contactor coil circuit short to ground fault: precharge contactor coil diagnosis voltage $< 300Mv$

P0AE6-F1
Precharge contactor coil circuit short to power fault: precharge contactor coil diagnosis voltage > 1000Mv
P0AE6-F2
Precharge contactor coil circuit open fault: precharge contactor coil diagnosis voltage < 500Mv
P0AE7-00
P1B09-F1
To set the effect of a fault code condition

Troubleshooting steps	
Step 1	General inspection.
	<ol style="list-style-type: none"> 1 Check battery capacity. 2 Check the harness plug of BMS for damage, poor contact, aging and looseness. 3 Check the harness plug of battery pack high voltage for damage, poor contact, aging and looseness. 4 Check whether the result is normal or not?
	NO → Repair or replace the faulted parts.
YES ↓	
Step 2	Check fault codes.
	<ol style="list-style-type: none"> 1 Connect the fault diagnosis instrument to the diagnosis interface. 2 Turn the ignition switch to ON position. 3 Diagnose the BMS with diagnostic apparatus. 4 If there is any fault code except for P0AE3-00、 P1B0A-F0、 P1B0A-F1、 P1B09-F0、 P0AE6-F0、 P0AE6-F1、 P0AE6-F2、 P0AE7-00、 P1B09-F1?
	YES → Refer to: DTC Summary list(BMS) .
NO ↓	
Step 3	Check the connecting cable of BMS.
	<ol style="list-style-type: none"> 1 Turn the ignition switch to OFF. 2 Make protective preparations according to the safety operation specifications of the high voltage voltage in the maintenance manual. 3 Disconnect the harness plug battery pack high voltage. 4 Disconnect the high voltage harness plug of BMS. 5 Check whether the BMS connection cable is rotten, damaged, and water enters. 6 Check whether the result is normal or not?
	NO → Repair or replace the faulted parts.
YES ↓	

Step 4	Check the precharge relay circuit.
	<ol style="list-style-type: none"> 1 Turn the ignition switch to OFF. 2 Make protective preparations according to the safety operation specifications of the high voltage voltage in the maintenance manual. 3 Open the BMS end cover. 4 Check whether the precharge relay circuit exist the situation of open or short circuit. 5 Check whether the precharge relay circuit exist the situation of shorting to battery. 6 Check whether the result is normal or not?
	NO → Repair or replace the faulted parts.
YES ↓	
Step 5	Check precharge relay signal checking module.
	<ol style="list-style-type: none"> 1 Turn the ignition switch to OFF. 2 Make protective preparations according to the safety operation specifications of the high voltage voltage in the maintenance manual. 3 Open the BMS end cover. 4 Check whether the precharge relay signal checking module is damaged. 5 Check whether the result is normal or not?
	NO → Repair or replace the faulted parts.
YES ↓	
Step 6	Check the precharge relay. (components)
	<ol style="list-style-type: none"> 1 Check the harness plug of BMS internal precharge relay for damage, poor contact, aging and looseness. 2 Check whether the BMS internal main negative relay works. 3 Check whether the result is normal or not?
	NO → Repair or replace the faulted parts.
YES ↓	

BMS(CN)

Step 7	Perform initialization.	
		<ol style="list-style-type: none"> 1 Turn the ignition switch to OFF. 2 Connect the fault diagnosis instrument to the diagnosis interface. 3 Turn the ignition switch to ON. 4 The BMS module was initialized with the diagnostic instrument. 5 Can the BMS be initialized and is the BMS restored?
		NO → Repair or change the BMS module.
YES ↓		
Step 8	Test whether BMS is norm.	
		<ol style="list-style-type: none"> 1 Turn the ignition switch to OFF. 2 Disconnect and check the harness plug EB90of BMS. 3 Check and repair. <ul style="list-style-type: none"> • Corrosion(install new adapting piece or terminal-cleaning module and pin). • Pin damaged or bent-install new terminal/pin. • Fly out of pins-install new pins as needed. 4 Reconnect the BMS plug and all other previously disconnected plug. Make sure the pin is properly positioned and fixed. 5 Run the system and determine if the problem persists?
		YES → Replace the BMS.
NO ↓		
At this point the system is functioning normally. The problem may be caused by module connections. Address the root cause of any connector or pin problems.		
Next Step ↓		
Diagnosis end.		

P0AF7-00、 P0AFA-F0、 P0AFB-F0

Fault diagnosis code
P0AF7-00: High voltage circuit open circuit
P0AFA-F0: Pack voltage low - level 1
P0AFB-F0: Pack voltage high - level 1
Detection tools
1 Multimeter and diagnostic apparatus
Possible causes
<ul style="list-style-type: none"> • BMS fault • Main positive relay fault • BMS main positive relay circuit fault
Conditions for fault code operation
Turn the ignition switch to ON position.
Conditions for fault code setting
P0AF7-00
The high voltage circuit of the battery system is open (the high voltage connection between the positive and negative relays)
P0AFA-F0
Voltage pack is higher than the protection threshold
P0AFB-F0
Voltage pack is lower than the protection threshold
To set the effect of a fault code condition
Lost power

Troubleshooting steps	
Step 1	General inspection.
	<ol style="list-style-type: none"> 1 Check battery capacity. 2 Check the harness plug of BMS for damage, poor contact, aging and looseness. 3 Check the harness plug of battery pack high voltage for damage, poor contact, aging and looseness. 4 Check whether the result is normal or not?
	NO → Repair or replace the faulted parts.
YES ↓	
Step 2	Check fault codes.
	<ol style="list-style-type: none"> 1 Connect the fault diagnosis instrument to the diagnosis interface. 2 Turn the ignition switch to ON position. 3 Diagnose the BMS with diagnostic apparatus. 4 Is there any other fault code except for P0AF7-00/P0AFA-F0/P0AFB-F0?
	YES → Refer to: DTC Summary list(BMS) .
NO ↓	
Step 3	Check the connecting cable of BMS.
	<ol style="list-style-type: none"> 1 Turn the ignition switch to OFF. 2 Make protective preparations according to the safety operation specifications of the high voltage voltage in the maintenance manual. 3 Disconnect the harness plug battery pack high voltage. 4 Disconnect the high voltage harness plug of BMS. 5 Check whether the BMS connection cable is rotten, damaged, and water enters. 6 Check whether the result is normal or not?
	NO → Repair or replace the faulted parts.
YES ↓	

Step 4	Check the insulation of BMS.
	<ol style="list-style-type: none"> 1 Use a megohm meter to check the insulation resistance of the BMS housing and grounding according to the procedure in the maintenance manual. Standard value (insulation level 1) > 750Ω/V (DC charging > 500Ω/V) Standard value (insulation level 2) > 500Ω/V (DC charging > 100Ω/V) 2 Check whether the result is normal or not?
	NO → Repair or replace the faulted parts.
YES ↓	
Step 5	Check the insulation of BMS high-voltage cables.
	<ol style="list-style-type: none"> 1 Use a megohm meter to check the insulation resistance of the BMS high voltage and grounding according to the procedure in the maintenance manual. Standard value (insulation level 1) > 750Ω/V (DC charging > 500Ω/V) Standard value (insulation level 2) > 500Ω/V (DC charging > 100Ω/V) 2 Check whether the result is normal or not?
	NO → Repair or replace the faulted parts.
YES ↓	
Step 6	Check the main positive relay circuit.
	<ol style="list-style-type: none"> 1 Turn the ignition switch to OFF. 2 Make protective preparations according to the safety operation specifications of the high voltage voltage in the maintenance manual. 3 Open the BMS end cover. 4 Check whether the main positive relay circuit exist the situation of open or short circuit. 5 Check whether the main positive relay circuit exist the situation of shorting to battery. 6 Check whether the result is normal or not?
	NO → Repair or replace the faulted parts.
YES ↓	

BMS(CN)

Step 7	Check main positive relay signal checking module.
	<ol style="list-style-type: none"> 1 Turn the ignition switch to OFF. 2 Make protective preparations according to the safety operation specifications of the high voltage voltage in the maintenance manual. 3 Open the BMS end cover. 4 Check whether the main positive relay signal checking module is damaged. 5 Check whether the result is normal or not?
	NO → Repair or replace the faulted parts.
YES ↓	
Step 8	Check the main negative relay circuit.
	<ol style="list-style-type: none"> 1 Turn the ignition switch to OFF. 2 Make protective preparations according to the safety operation specifications of the high voltage voltage in the maintenance manual. 3 Open the BMS end cover. 4 Check whether the main positive relay circuit exist the situation of open or short circuit. 5 Check whether the main positive relay circuit exist the situation of shorting to battery. 6 Check whether the result is normal or not?
	NO → Repair or replace the faulted parts.
YES ↓	
Step 9	Check main negative relay signal checking module.
	<ol style="list-style-type: none"> 1 Turn the ignition switch to OFF. 2 Make protective preparations according to the safety operation specifications of the high voltage voltage in the maintenance manual. 3 Open the BMS end cover. 4 Check whether the main positive relay signal checking module is damaged. 5 Check whether the result is normal or not?
	NO → Repair or replace the faulted parts.
YES ↓	

Step 10	Check the main positive relay(components).
	<ol style="list-style-type: none"> 1 Check the harness plug of BMS internal main positive relay for damage, poor contact, aging and looseness. 2 Check whether the BMS internal main positive relay works. 3 Check whether the result is normal or not?
	NO → Repair or replace the faulted parts.
YES ↓	
Step 11	Check the main negative relay(components).
	<ol style="list-style-type: none"> 1 Check the harness plug of BMS internal main positive relay for damage, poor contact, aging and looseness. 2 Check whether the BMS internal main positive relay works. 3 Check whether the result is normal or not?
	NO → Repair or replace the faulted parts.
YES ↓	
Step 12	Perform initialization.
	<ol style="list-style-type: none"> 1 Turn the ignition switch to OFF. 2 Connect the fault diagnosis instrument to the diagnosis interface. 3 Turn the ignition switch to ON. 4 The BMS module was initialized with the diagnostic instrument. 5 Can the BMS be initialized and is the BMS restored?
	NO → Repair or change the BMS module.
YES ↓	
Step 13	Test whether BMS is norm.
	<ol style="list-style-type: none"> 1 Turn the ignition switch to OFF. 2 Disconnect and check the harness plug EB90of BMS. 3 Check and repair. <ul style="list-style-type: none"> • Corrosion(install new adapting piece or terminal-cleaning module and pin). • Pin damaged or bent-install new terminal/pin. • Fly out of pins-install new pins as needed. 4 Reconnect the BMS plug and all other previously disconnected plug. Make sure the pin is properly positioned and fixed. 5 Run the system and determine if the problem persists?
	YES → Replace the BMS.

BMS(CN)

NO ↓
At this point the system is functioning normally. The problem may be caused by module connections. Address the root cause of any connector or pin problems.
Next Step ↓
Diagnosis end.

P0D94-00

Fault diagnosis code
vehicle Charging electronic lock state abnormal
Detection tools
1 Multimeter and diagnostic apparatus
Possible causes
<ul style="list-style-type: none"> • Circuit,terminal and adapting piece fault • Electronic lock instrument fault
Conditions for fault code operation
Turn the ignition switch to ON position.
Conditions for fault code setting
P0D94-00
The electronic lock fails to be locked or unlocked, and the electronic lock is unlocked abnormally during charging:
<ol style="list-style-type: none"> 1. Electronic lock fails to lock 2. Electronic lock fails to unlock 3. The electronic lock is unlocked abnormally during charging
To set the effect of a fault code condition
<ol style="list-style-type: none"> 1. Electronic lock fails to lock 2. Electronic lock fails to unlock 3. The electronic lock is unlocked abnormally during charging
Description of circuit diagram

Circuit diagram

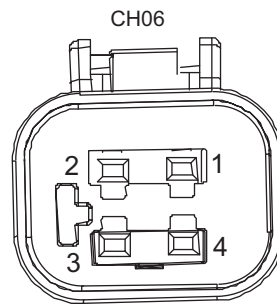
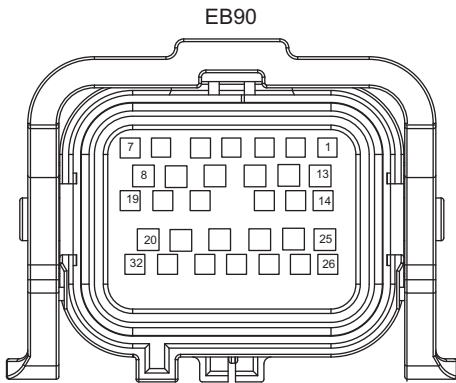
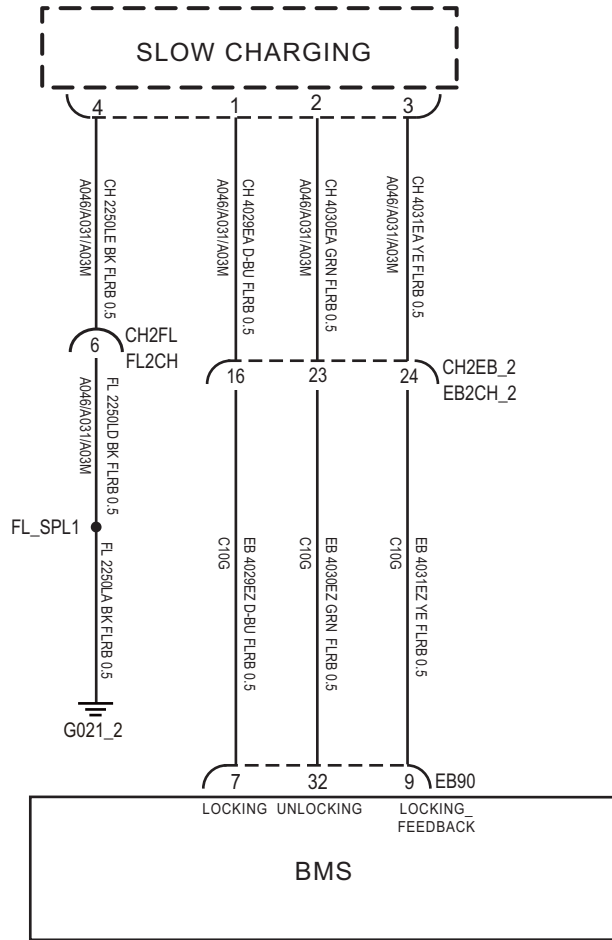

EK893007

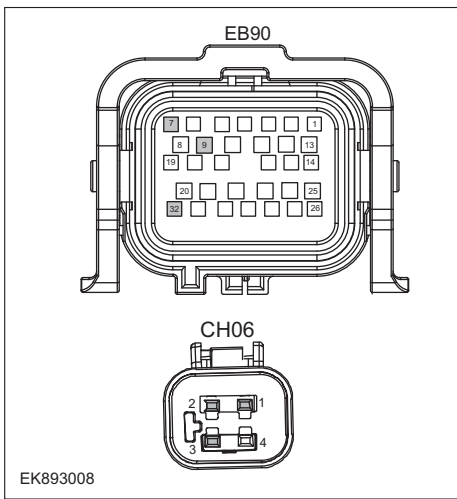
Troubleshooting steps	
Step 1	General inspection.
	<ol style="list-style-type: none"> 1 Check the fuse for damage. 2 Check battery capacity. 3 Check the harness plug of BMS for damage, poor contact, aging and looseness. 4 Check whether the result is normal or not?
	NO → Repair or replace the faulted parts.
YES ↓	
Step 2	Check fault codes.
	<ol style="list-style-type: none"> 1 Connect the fault diagnosis instrument to the diagnosis interface. 2 Turn the ignition switch to ON position. 3 Diagnose the BMS with diagnostic apparatus. 4 Is there any other fault code except for P0D94-00?
	YES → Refer to: DTC Summary list(BMS) .
NO ↓	
Step 3	Check the circuit between slow charging and BMS. (Open circuit)
	<ol style="list-style-type: none"> 1 Turn the ignition switch to OFF. 2 Disconnect the harness plug CH06 of slow charging. 3 Disconnect the harness plug EB90 of BMS. 4 Measure the resistance between the harness terminals of slow charging and CCS. <ul style="list-style-type: none"> Measuring circuit: resistance between terminal 1 on plug CH06 and terminal 7 on plug EB90. Measuring circuit: resistance between terminal 2 on plug CH06 and terminal 32 on plug EB90. Measuring circuit: resistance between terminal 3 on plug CH06 and terminal 9 on plug EB90. <p>Standard value: < 1Ω</p> 5 Check whether the result is normal or not?
	NO → Repair or replace the faulted parts.
YES ↓	

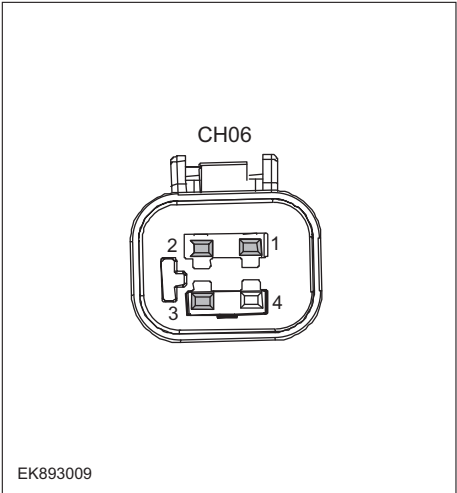
Step 4	Check the circuit of slow charging. (Short circuit)
	<ol style="list-style-type: none"> 1 Turn the ignition switch to OFF. 2 Connect the harness plug EB90of BMS. 3 Measure the resistance between the harness terminal of slow charging and ground. Measuring circuit: resistance between terminal 1 on plug CH06 and ground. Measuring circuit: resistance between terminal 2 on plug CH06 and ground. Measuring circuit: resistance between terminal 3 on plug CH06 and ground. Standard value: ∞ 4 Measure the voltage between the harness terminal of slow charging and ground. Measuring circuit: voltage between terminal 1 on plug EB1007 and ground. Measuring circuit: voltage between terminal 2 on plug EB1007 and ground. Measuring circuit: voltage between terminal 3 on plug EB1007 and ground. Standard value: ≈ 0V 5 Check whether the result is normal or not?
NO → Repair or replace the faulted parts.	
YES ↓	
Step 5	Test whether BMS is norm.
	<ol style="list-style-type: none"> 1 Turn the ignition switch to OFF. 2 Disconnect and check the harness plug EB90of BMS. 3 Check and repair. <ul style="list-style-type: none"> • Corrosion(install new adapting piece or terminal-cleaning module and pin). • Pin damaged or bent-install new terminal/pin. • Fly out of pins-install new pins as needed. 4 Reconnect the BMS plug and all other previously disconnected plug. Make sure the pin is properly positioned and fixed. 5 Run the system and determine if the problem persists?
YES → Replace the BMS.	
NO ↓	
At this point the system is functioning normally. The problem may be caused by module connections. Address the root cause of any connector or pin problems.	

Next Step ↓
Diagnosis end.

BMS(CN)

P0DAD-00、P0DCA-00、P0DE6-F0、P0DE6-F1、P0DE6-F2、P0DE6-F3、P0DE7-F0、P0DE7-F1、P0DE7-F2、P0DE7-F3、P1B02-00、P1B11-F0、C0111-96、C0112-96、P1B11-F1、C1001-04、P1E00-F0、P1B44-00、P1B48-00

Fault diagnosis code
P0DAD-00: balance circuit open
P0DCA-00: balance circuit short
P0DE6-F0: Single Cell undervoltage level1
P0DE6-F1: single cell undervoltage level2
P0DE6-F2: single cell undervoltage level3
P0DE6-F3: single cell extremely undervoltage
P0DE7-F0: Single Cell Over Voltage Level 1
P0DE7-F1: Single Cell Over Voltage Level 2
P0DE7-F2: Single Cell Over Voltage Level 3
P0DE7-F3: Single Cell Over Voltage Extremely
P1B02-00: BMS unintended reset
P1B11-F0: Cell voltage sample open wire fault
P1B11-F1: Cell voltage sensor fault
P1E00-F0: Cell unbalance
P1B44-00: balance circuit over temperature
P1B48-00: balance circuit temperature invalid fault
Detection tools
1 Multimeter and diagnostic apparatus
Possible causes
<ul style="list-style-type: none">• BMS fault• BMS balance function fault• Battery pack damage
Conditions for fault code operation
Turn the ignition switch to ON position.
Conditions for fault code setting
P0DAD-00
BMS detects that the balance circuit open fault flag is valid&& CMC does not have a short circuit fault
P0DCA-00
BMS detects that the balance circuit short fault flag is valid
P0DE6-F0

<p>Unit voltage is lower than the alarm value:</p> <p>$V_{min} \leq 2800\text{mV}$ ($T_{min} > 20\text{ }^{\circ}\text{C}$)</p> <p>$V_{min} \leq 2500\text{mV}$ ($10\text{ }^{\circ}\text{C} < T_{min} \leq 20\text{ }^{\circ}\text{C}$)</p> <p>$V_{min} \leq 2300\text{mV}$ ($0\text{ }^{\circ}\text{C} < T_{min} \leq 10\text{ }^{\circ}\text{C}$)</p> <p>$V_{min} \leq 2100\text{mV}$ ($-5\text{ }^{\circ}\text{C} < T_{min} \leq 0\text{ }^{\circ}\text{C}$)</p> <p>$V_{min} \leq 2100\text{mV}$ ($0\text{ }^{\circ}\text{C} < T_{min} \leq -5\text{ }^{\circ}\text{C}$)</p> <p>$V_{min} \leq 2100\text{mV}$ ($T_{min} \leq -10\text{ }^{\circ}\text{C}$)</p>
P0DE6-F1
<p>Unit voltage is lower than the protection threshold:</p> <p>$V_{min} \leq 2500\text{mV}$ ($T_{min} > 20\text{ }^{\circ}\text{C}$)</p> <p>$V_{min} \leq 2350\text{mV}$ ($10\text{ }^{\circ}\text{C} < T_{min} \leq 20\text{ }^{\circ}\text{C}$)</p> <p>$V_{min} \leq 2100\text{mV}$ ($0\text{ }^{\circ}\text{C} < T_{min} \leq 10\text{ }^{\circ}\text{C}$)</p> <p>$V_{min} \leq 1900\text{mV}$ ($-5\text{ }^{\circ}\text{C} < T_{min} \leq 0\text{ }^{\circ}\text{C}$)</p> <p>$V_{min} \leq 1900\text{mV}$ ($0\text{ }^{\circ}\text{C} < T_{min} \leq -5\text{ }^{\circ}\text{C}$)</p> <p>$V_{min} \leq 1900\text{mV}$ ($T_{min} \leq -10\text{ }^{\circ}\text{C}$)</p>
P0DE6-F2
<p>Unit voltage is lower than the protection threshold1:</p> <p>$V_{min} \leq 2300\text{mV}$ ($T_{min} > 20\text{ }^{\circ}\text{C}$)</p> <p>$V_{min} \leq 2200\text{mV}$ ($10\text{ }^{\circ}\text{C} < T_{min} \leq 20\text{ }^{\circ}\text{C}$)</p> <p>$V_{min} \leq 1900\text{mV}$ ($0\text{ }^{\circ}\text{C} < T_{min} \leq 10\text{ }^{\circ}\text{C}$)</p> <p>$V_{min} \leq 1700\text{mV}$ ($-5\text{ }^{\circ}\text{C} < T_{min} \leq 0\text{ }^{\circ}\text{C}$)</p> <p>$V_{min} \leq 1700\text{mV}$ ($0\text{ }^{\circ}\text{C} < T_{min} \leq -5\text{ }^{\circ}\text{C}$)</p> <p>$V_{min} \leq 1700\text{mV}$ ($T_{min} \leq -10\text{ }^{\circ}\text{C}$)</p>
P0DE6-F3
<p>Unit voltage is lower than the protection threshold2:</p> <p>$V_{min} \leq 1800\text{mV}$ ($T_{min} > 20\text{ }^{\circ}\text{C}$)</p> <p>$V_{min} \leq 1800\text{mV}$ ($10\text{ }^{\circ}\text{C} < T_{min} \leq 20\text{ }^{\circ}\text{C}$)</p> <p>$V_{min} \leq 1500\text{mV}$ ($0\text{ }^{\circ}\text{C} < T_{min} \leq 10\text{ }^{\circ}\text{C}$)</p> <p>$V_{min} \leq 1500\text{mV}$ ($-5\text{ }^{\circ}\text{C} < T_{min} \leq 0\text{ }^{\circ}\text{C}$)</p> <p>$V_{min} \leq 1500\text{mV}$ ($0\text{ }^{\circ}\text{C} < T_{min} \leq -5\text{ }^{\circ}\text{C}$)</p> <p>$V_{min} \leq 1500\text{mV}$ ($T_{min} \leq -10\text{ }^{\circ}\text{C}$)</p>
P0DE7-F0
<p>Unit voltage is higher than the alarm value:</p> <p>$V_{max} \geq 3800\text{mV}$</p>
P0DE7-F1

BMS(CN)

Unit voltage is higher than the protection threshold: $V_{max} \geq 3850\text{mV}$
P0DE7-F2
Unit voltage is higher than the safe threshold1: $V_{max} \geq 3900\text{mV}$
P0DE7-F3
Unit voltage is higher than the safe threshold2: $V_{max} \geq 4200\text{mV}$
P1B02-00
BMS detects Reset during system running: number of unexpected restarts of BMS ≥ 1
P1B11-F0
The core voltage sampling line is short: (17823 sample line dropped diagnosis result is valid)&&(the voltage of either of the two adjacent cells of the dropped sampling line is less than or equal to 0.25V)
P1B11-F1
The sampling voltage of the cell exceeds the normal voltage range of the cell: when no hardware fault occurs, the voltage of a unit exceeds the upper limit(over 0V~4.8V)
P1E00-F0
The difference between the maximum SOC and minimum SOC exceeds the allowable range: $(\text{SOC_Max} - \text{SOC_Min}) \geq 15\%$
P1B44-00
Balance circuit temperature sampling is higher than protection threshold: balance circuit temperature $>90^\circ\text{C}$ && balance circuit temperature valid
P1B48-00
Balance circuit temperature sampling invalid: under the daisy chain upgraded: balance circuit temperature sampling invalid
To set the effect of a fault code condition
Cell function is limited

Troubleshooting steps	
Step 1	General inspection.
	<ol style="list-style-type: none"> 1 Check battery capacity. 2 Check the harness plug of BMS for damage, poor contact, aging and looseness. 3 Check the harness plug of battery pack high voltage for damage, poor contact, aging and looseness. 4 Check whether the result is normal or not?
	NO → Repair or replace the faulted parts.
YES ↓	
Step 2	Check fault codes.
	<ol style="list-style-type: none"> 1 Connect the fault diagnosis instrument to the diagnosis interface. 2 Turn the ignition switch to ON position. 3 Diagnose the BMS with diagnostic apparatus. 4 Is there any other fault code except for P0DAD-00, P0DCA-00, P0DE6-F0, P0DE6-F1, P0DE6-F2, P0DE6-F3, P0DE7-F0, P0DE7-F1, P0DE7-F2, P0DE7-F3, P1B02-00, P1B11-F0, P1B11-F1, P1E00-F0, C0062-08, P1B44-00, P1B48-00?
	YES → Refer to: DTC Summary list(BMS) .
NO ↓	
Step 3	Carry out automatic balance operation of battery pack cell.
	<ol style="list-style-type: none"> 1 According to the maintenance process of the manufacturer, the battery pack cells is automatically balanced. 2 Clear the BMS Fault code and re-use the diagnostic instrument to diagnose BMS. 3 Test whether the faulted code is existed.
	YES → Diagnosis end.
NO ↓	

BMS(CN)

Step 4	Check the connecting cable of BMS.
	<ol style="list-style-type: none"> 1 Turn the ignition switch to OFF. 2 Make protective preparations according to the safety operation specifications of the high voltage voltage in the maintenance manual. 3 Disconnect the harness plug battery pack high voltage. 4 Disconnect the high voltage harness plug of BMS. 5 Check whether the BMS connection cable is rotten, damaged, and water enters. 6 Check whether the result is normal or not?
	NO → Repair or replace the faulted parts.
YES ↓	
Step 5	Perform initialization.
	<ol style="list-style-type: none"> 1 Turn the ignition switch to OFF. 2 Connect the fault diagnosis instrument to the diagnosis interface. 3 Turn the ignition switch to ON. 4 The BMS module was initialized with the diagnostic instrument. 5 Can the BMS be initialized and is the BMS restored?
	NO → Repair or change the BMS module.
YES ↓	
Step 6	Test whether BMS is norm.
	<ol style="list-style-type: none"> 1 Turn the ignition switch to OFF. 2 Disconnect and check the harness plug EB90of BMS. 3 Check and repair. <ul style="list-style-type: none"> • Corrosion(install new adapting piece or terminal-cleaning module and pin). • Pin damaged or bent-install new terminal/pin. • Fly out of pins-install new pins as needed. 4 Reconnect the BMS plug and all other previously disconnected plug. Make sure the pin is properly positioned and fixed. 5 Run the system and determine if the problem persists?
	YES → Replace the BMS.
NO ↓	
At this point the system is functioning normally. The problem may be caused by module connections. Address the root cause of any connector or pin problems.	
Next Step ↓	

Diagnosis end.

P1B19-00

Fault diagnosis code
P1B19-00: AC charging socket temperature sensor fault
Detection tools
1 Multimeter and diagnostic apparatus
Possible causes
<ul style="list-style-type: none">• Circuit,terminal and adapting piece fault• Temperature sensor fault
Conditions for fault code operation
Turn the ignition switch to ON position.
Conditions for fault code setting
P1B19-00
The temperature sensor of the charging socket is faulty, and the collected temperature value is invalid: the charging socket temperature sensor is sampling out of range
To set the effect of a fault code condition
The temperature sensor of the charging socket is faulty, and the collected temperature value is invalid
Description of circuit diagram

Circuit diagram

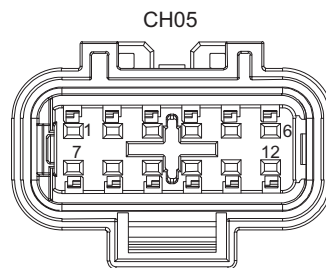
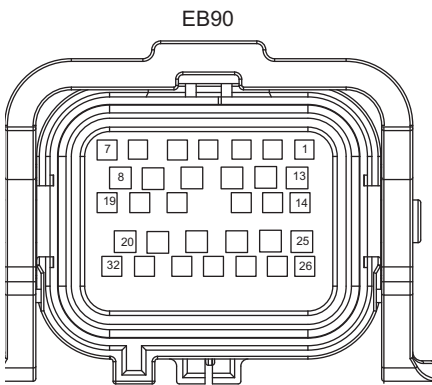
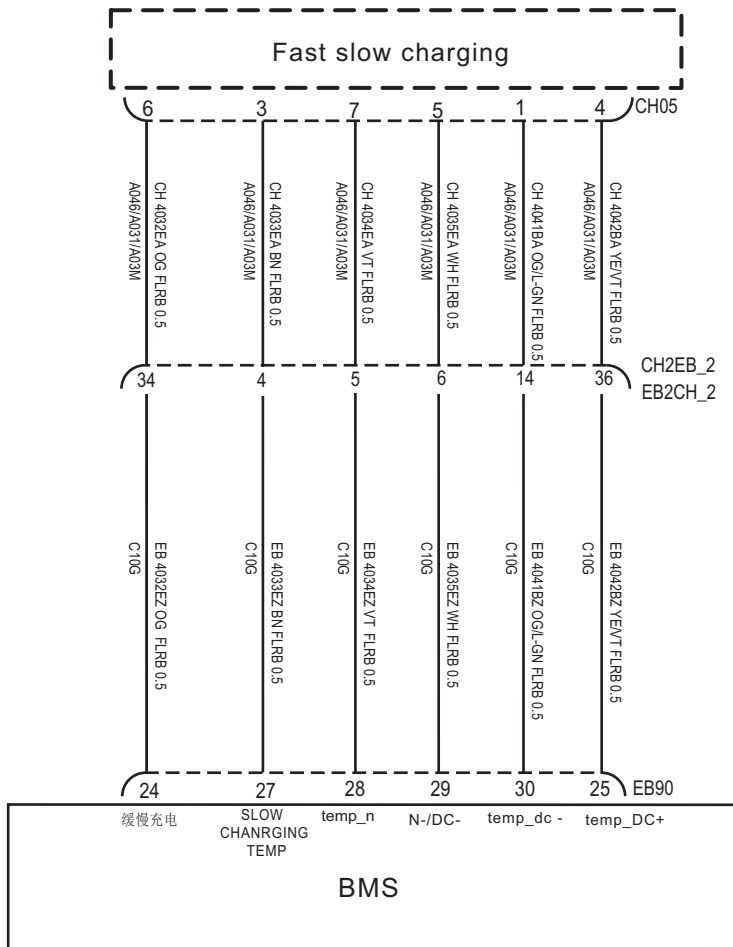

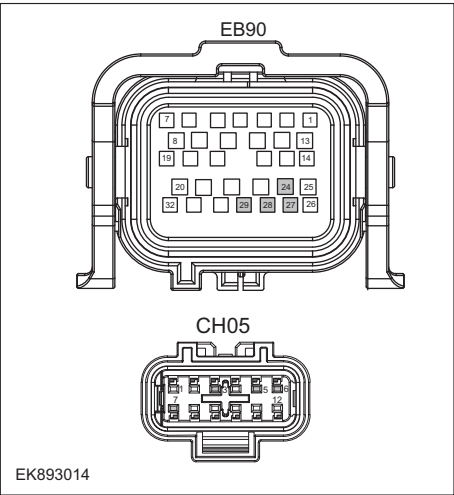
Troubleshooting steps	
Step 1	General inspection.
	<ol style="list-style-type: none"> 1 Check the fuse for damage. 2 Check battery capacity. 3 Check the harness plug of BMS for damage, poor contact, aging and looseness. 4 Check whether the result is normal or not?
NO → Repair or replace the faulted parts.	
YES ↓	
Step 2	Check fault codes.
	<ol style="list-style-type: none"> 1 Connect the fault diagnosis instrument to the diagnosis interface. 2 Turn the ignition switch to ON position. 3 Diagnose the BMS with diagnostic apparatus. 4 Is there any other fault code except for P1B19-00?
YES → Refer to: DTC Summary list(BMS) .	
NO ↓	
Step 3	Check the circuit between slow charging and BMS. (Open circuit)
	<ol style="list-style-type: none"> 1 Turn the ignition switch to OFF. 2 Disconnect the harness plug EB90 of BMS. 3 Disconnect the harness plug CH06 of slow charging. 4 Measure the resistance between the harness terminals of BMS and slow charging. Measuring circuit: resistance between terminal 3 on plug EB90 and terminal 27 on plug CH05. Measuring circuit: resistance between terminal 5 on plug EB90 and terminal 29 on plug CH05. Measuring circuit: resistance between terminal 6 on plug EB90 and terminal 24 on plug CH05. Measuring circuit: resistance between terminal 7 on plug EB90 and terminal 28 on plug CH05. Standard value: < 1Ω 5 Check whether the result is normal or not?
NO → Repair or replace the faulted parts.	
YES ↓	
Step 4	Check the circuit of slow charging. (Short circuit)

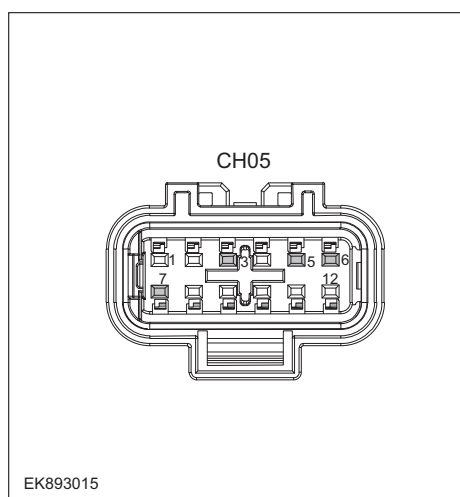

- 1 Turn the ignition switch to OFF.
- 2 Connect the harness plug EB90 of BMS.
- 3 Measure the resistance between the harness terminal of slow charging and ground.

Measuring circuit: resistance between terminal 3 on plug CH05 and ground.

Measuring circuit: resistance between terminal 5 on plug CH05 and ground.

Measuring circuit: resistance between terminal 6 on plug CH05 and ground.

Measuring circuit: resistance between terminal 7 on plug CH05 and ground.

Standard value: ∞

- 4 Measure the voltage between the harness terminal of slow charging and ground.

Measuring circuit: voltage between terminal 3 on plug CH05 and ground.

Measuring circuit: voltage between terminal 5 on plug CH05 and ground.

Measuring circuit: voltage between terminal 6 on plug CH05 and ground.

Measuring circuit: voltage between terminal 7 on plug CH05 and ground.

Standard value: $\approx 0V$

- 5 Check whether the result is normal or not?

NO → Repair or replace the faulted parts.

YES ↓

BMS(CN)

Step 5	Test whether BMS is norm.
	<ol style="list-style-type: none"> 1 Turn the ignition switch to OFF. 2 Disconnect and check the harness plug EB90of BMS. 3 Check and repair. <ul style="list-style-type: none"> • Corrosion(install new adapting piece or terminal-cleaning module and pin). • Pin damaged or bent-install new terminal/pin. • Fly out of pins-install new pins as needed. 4 Reconnect the BMS plug and all other previously disconnected plug. Make sure the pin is properly positioned and fixed. 5 Run the system and determine if the problem persists?
	YES → Replace the BMS.
NO ↓	
At this point the system is functioning normally. The problem may be caused by module connections. Address the root cause of any connector or pin problems.	
Next Step ↓	
Diagnosis end.	

P1B2E-00

Fault diagnosis code
P1B2E-00: DC charging socket temperature sensor fault
Detection tools
1 Multimeter and diagnostic apparatus
Possible causes
<ul style="list-style-type: none"> • Circuit, terminal and adapting piece fault • Temperature sensor fault
Conditions for fault code operation
Turn the ignition switch to ON position.
Conditions for fault code setting
P1B2E-00
The temperature sensor of the charging socket is faulty, and the collected temperature value is invalid: the charging socket temperature sensor is sampling out of range
To set the effect of a fault code condition
The temperature sensor of the charging socket is faulty, and the collected temperature value is invalid
Description of circuit diagram

Circuit diagram

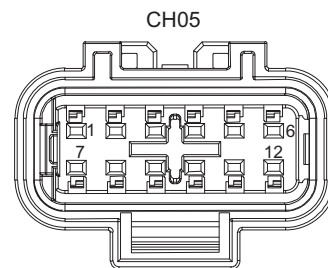
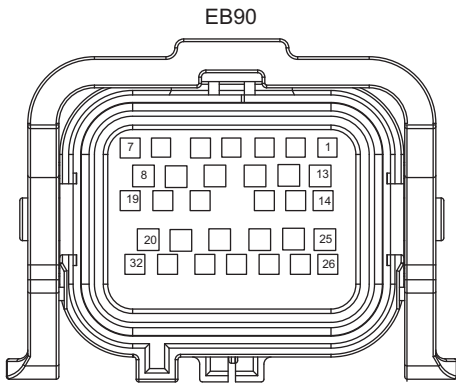
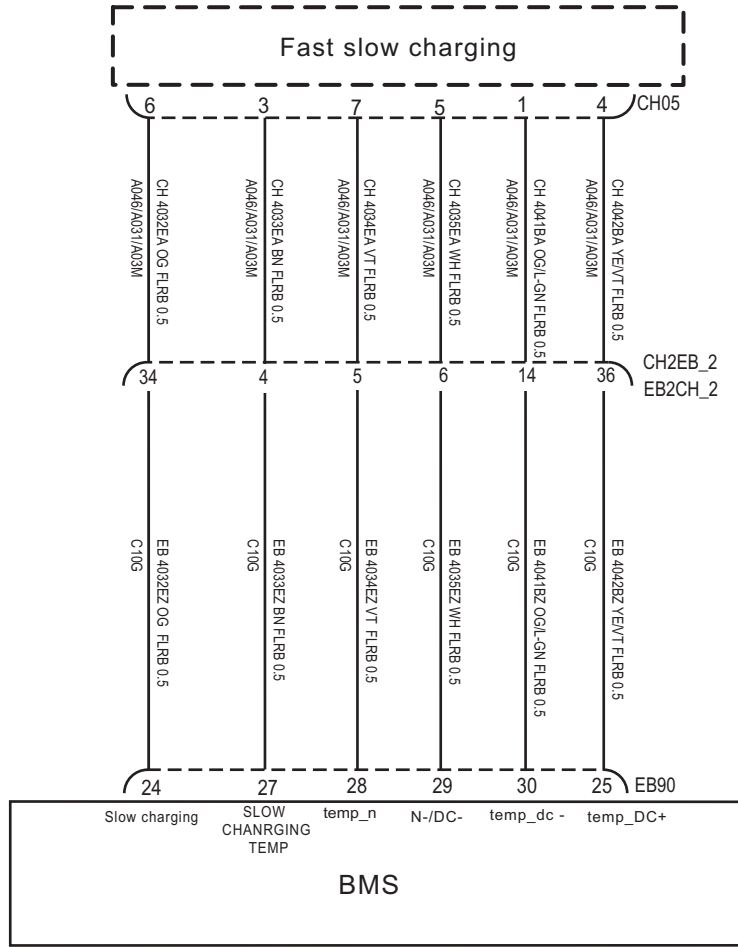

EK893010

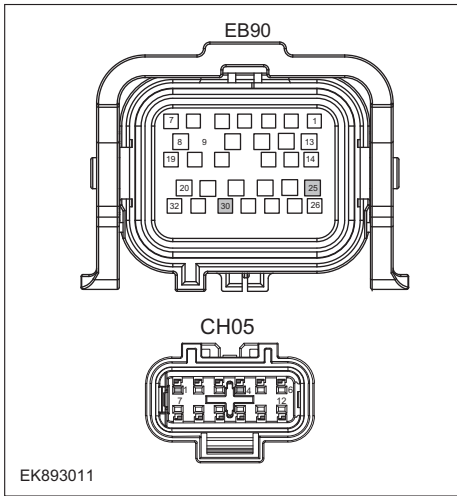
Troubleshooting steps	
Step 1	General inspection.
	<ol style="list-style-type: none"> 1 Check the fuse for damage. 2 Check battery capacity. 3 Check the harness plug of BMS for damage, poor contact, aging and looseness. 4 Check whether the result is normal or not?
	NO → Repair or replace the faulted parts.
YES ↓	
Step 2	Check fault codes.
	<ol style="list-style-type: none"> 1 Connect the fault diagnosis instrument to the diagnosis interface. 2 Turn the ignition switch to ON position. 3 Diagnose the BMS with diagnostic apparatus. 4 Is there any other fault code except for P1B2E-00?
	YES → Refer to: DTC Summary list(BMS) .
NO ↓	
Step 3	Check the circuit between fast charging and BMS. (Open circuit)
	<ol style="list-style-type: none"> 1 Turn the ignition switch to OFF. 2 Disconnect the harness plug CH05 of fast charging. 3 Disconnect the harness plug EB90 of BMS. 4 Measure the resistance between the harness terminals of fast charging and BMS. Measuring circuit: resistance between terminal 1 on plug CH05 and terminal 30 on plug EB90. Measuring circuit: resistance between terminal 4 on plug CH05 and terminal 25 on plug EB90. Standard value: < 1Ω 5 Check whether the result is normal or not?
	NO → Repair or replace the faulted parts.
YES ↓	

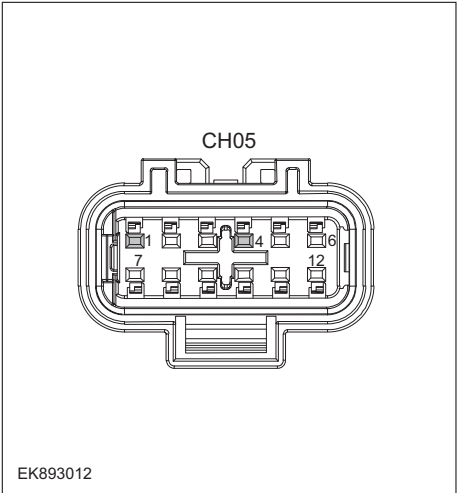
Step 4	Check the circuit of fast charging. (Short circuit)
	<ol style="list-style-type: none"> 1 Turn the ignition switch to OFF. 2 Connect the harness plug EB90 of BMS. 3 Measure the resistance between the harness terminal of fast charging and ground. Measuring circuit: resistance between terminal 1 on plug CH05 and ground. Measuring circuit: resistance between terminal 4 on plug CH05 and ground. Standard value: ∞ 4 Measure the voltage between the harness terminal of BMS and ground. Measuring circuit: voltage between terminal 1 on plug CH05 and ground. Measuring circuit: voltage between terminal 4 on plug CH05 and ground. Standard value: $\approx 0V$ 5 Check whether the result is normal or not?
NO → Repair or replace the faulted parts.	
YES ↓	
Step 5	Test whether BMS is norm.
	<ol style="list-style-type: none"> 1 Turn the ignition switch to OFF. 2 Disconnect and check the harness plug EB90of BMS. 3 Check and repair. <ul style="list-style-type: none"> • Corrosion(install new adapting piece or terminal-cleaning module and pin). • Pin damaged or bent-install new terminal/pin. • Fly out of pins-install new pins as needed. 4 Reconnect the BMS plug and all other previously disconnected plug. Make sure the pin is properly positioned and fixed. 5 Run the system and determine if the problem persists?
YES → Replace the BMS.	
NO ↓	
At this point the system is functioning normally. The problem may be caused by module connections. Address the root cause of any connector or pin problems.	
Next Step ↓	
Diagnosis end.	

P1B37-00、 P1B38-00、 P1B51-00

Fault diagnosis code
P1B37-00: heat relay stuck open fault
P1B38-00: heater relay stuck close fault
P1B51-00: Heating circuit open circuit
Detection tools
1 Multimeter and diagnostic apparatus
Possible causes
<ul style="list-style-type: none"> • BMS fault • Heat relay fault • BMS heating relay circuit fault
Conditions for fault code operation
Turn the ignition switch to ON position.
Conditions for fault code setting
P1B37-00
Within a period of time after the heating request closes the heating positive relay, it is detected that the heating relay is open: After closing heating relay, [heating relay outside lateral voltage U2-heating relay inside voltage U1] > 10% pack voltage
P1B38-00
Within a period of time after the heating relay, it is detected that the heating relay stuck: After closing heating relay, heating positive inside lateral voltage-heating positive outside lateral voltage 5%pack voltage U1 and heating positive outside lateral voltage > 20% pack voltage
P1B51-00
Minimum battery temperature Tmin temperature rise within 2400000 ≤ 3 °C
To set the effect of a fault code condition
Battery pack heating function is faulty

Troubleshooting steps	
Step 1	General inspection.
	<ol style="list-style-type: none"> 1 Check battery capacity. 2 Check the harness plug of BMS for damage, poor contact, aging and looseness. 3 Check the harness plug of battery pack high voltage for damage, poor contact, aging and looseness. 4 Check whether the result is normal or not?
	NO → Repair or replace the faulted parts.
YES ↓	
Step 2	Check fault codes.
	<ol style="list-style-type: none"> 1 Connect the fault diagnosis instrument to the diagnosis interface. 2 Turn the ignition switch to ON position. 3 Diagnose the BMS with diagnostic apparatus. 4 Is there any other fault code except for P1B37-00/P1B38-00/P1B51-00?
	YES → Refer to: DTC Summary list(BMS) .
NO ↓	
Step 3	Check the connecting cable of BMS.
	<ol style="list-style-type: none"> 1 Turn the ignition switch to OFF. 2 Make protective preparations according to the safety operation specifications of the high voltage voltage in the maintenance manual. 3 Disconnect the harness plug battery pack high voltage. 4 Disconnect the high voltage harness plug of BMS. 5 Check whether the BMS connection cable is rotten, damaged, and water enters. 6 Check whether the result is normal or not?
	NO → Repair or replace the faulted parts.
YES ↓	

Step 4	Check the heating relay circuit.	
		<ol style="list-style-type: none"> 1 Turn the ignition switch to OFF. 2 Make protective preparations according to the safety operation specifications of the high voltage voltage in the maintenance manual. 3 Open the BMS end cover. 4 Check whether the heating relay circuit exist the situation of open or short circuit. 5 Check whether the heating relay circuit exist the situation of shorting to battery. 6 Check whether the result is normal or not?
		NO → Repair or replace the faulted parts.
YES ↓		
Step 5	Check heating relay signal checking module.	
		<ol style="list-style-type: none"> 1 Turn the ignition switch to OFF. 2 Make protective preparations according to the safety operation specifications of the high voltage voltage in the maintenance manual. 3 Open the BMS end cover. 4 Check whether the heating relay signal checking module is damaged. 5 Check whether the result is normal or not?
		NO → Repair or replace the faulted parts.
YES ↓		
Step 6	Check the heating relay. (components)	
		<ol style="list-style-type: none"> 1 Check the harness plug of BMS internal heating relay for damage, poor contact, aging and looseness. 2 Check whether the BMS internal heating relay works. 3 Check whether the result is normal or not?
		NO → Repair or replace the faulted parts.
YES ↓		
Step 7	Perform initialization.	
		<ol style="list-style-type: none"> 1 Turn the ignition switch to OFF. 2 Connect the fault diagnosis instrument to the diagnosis interface. 3 Turn the ignition switch to ON. 4 The BMS module was initialized with the diagnostic instrument. 5 Can the BMS be initialized and is the BMS restored?

BMS(CN)

		NO → Repair or change the BMS module.
YES ↓		
Step 8	Test whether BMS is norm.	
		<ol style="list-style-type: none"> 1 Turn the ignition switch to OFF. 2 Disconnect and check the harness plug EB90of BMS. 3 Check and repair. <ul style="list-style-type: none"> • Corrosion(install new adapting piece or terminal-cleaning module and pin). • Pin damaged or bent-install new terminal/pin. • Fly out of pins-install new pins as needed. 4 Reconnect the BMS plug and all other previously disconnected plug. Make sure the pin is properly positioned and fixed. 5 Run the system and determine if the problem persists?
		YES → Replace the BMS.
NO ↓		
At this point the system is functioning normally. The problem may be caused by module connections. Address the root cause of any connector or pin problems.		
Next Step ↓		
Diagnosis end.		

P1B43-00

Fault diagnosis code
P1B43-00: Crash fault(from vehicle CAN signal)
Detection tools
1 Multimeter and diagnostic apparatus
Possible causes
<ul style="list-style-type: none"> • Circuit,terminal and adapting piece fault • BMS fault
Conditions for fault code operation
Turn the ignition switch to ON position.
Conditions for fault code setting
P1B43-00
BMS confirmed the collision by detecting the CAN signal of the vehicle:the crash signal transmitted by the CAN signal is valid
To set the effect of a fault code condition
Enable emergency mode
Description of circuit diagram

Circuit diagram

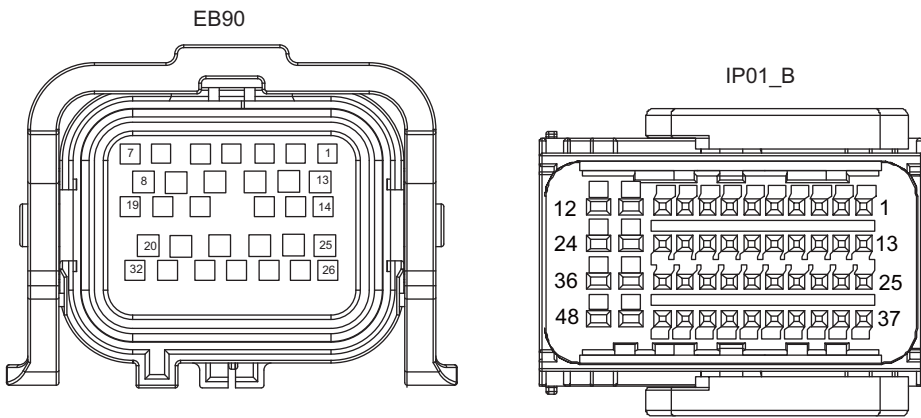
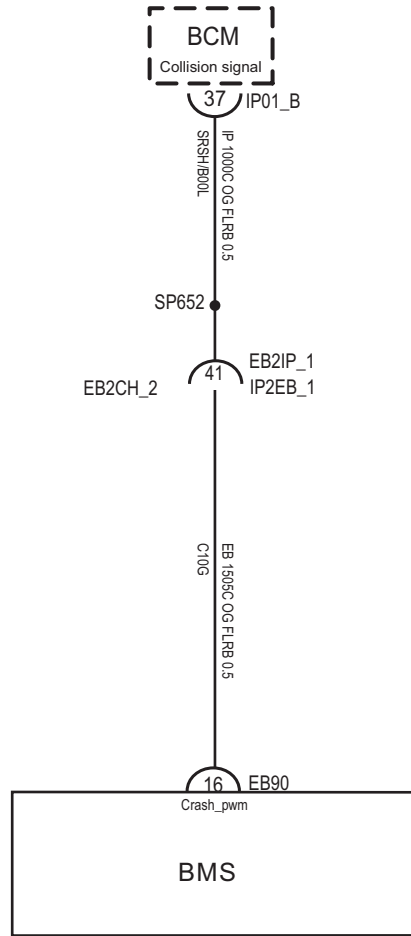

EK893016

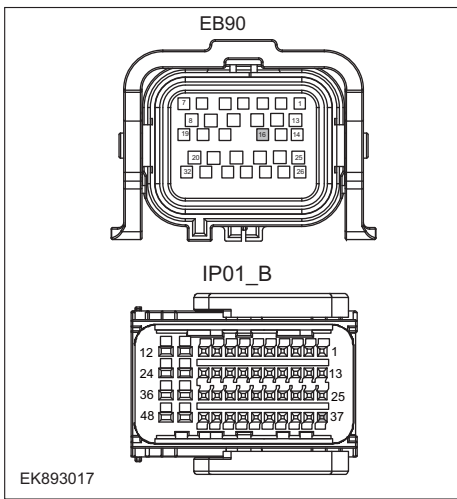
Troubleshooting steps	
Step 1	General inspection.
	<ol style="list-style-type: none"> 1 Check the fuse for damage. 2 Check battery capacity. 3 Check the harness plug of BMS for damage, poor contact, aging and looseness. 4 Check whether the result is normal or not?
	NO → Repair or replace the faulted parts.
YES ↓	
Step 2	Check fault codes.
	<ol style="list-style-type: none"> 1 Connect the fault diagnosis instrument to the diagnosis interface. 2 Turn the ignition switch to ON position. 3 Diagnose the BMS with diagnostic apparatus. 4 Is there any other fault code except for P1B43-00?
	YES → Refer to: DTC Summary list(BMS) .
NO ↓	
Step 3	Check the circuit between BMS and BCM. (Open circuit)
	<ol style="list-style-type: none"> 1 Turn the ignition switch to OFF. 2 Disconnect the harness plug EB90 of BMS. 3 Disconnect the harness plug IP01_B of BCM. 4 Measure the resistance between the harness terminals of BMS and BCM. Measuring circuit: resistance between terminal 16 on plug EB90 and terminal 37 on plug IP01_B. Standard value: < 1Ω 5 Check whether the result is normal or not?
	NO → Repair or replace the faulted parts.
YES ↓	

BMS(CN)

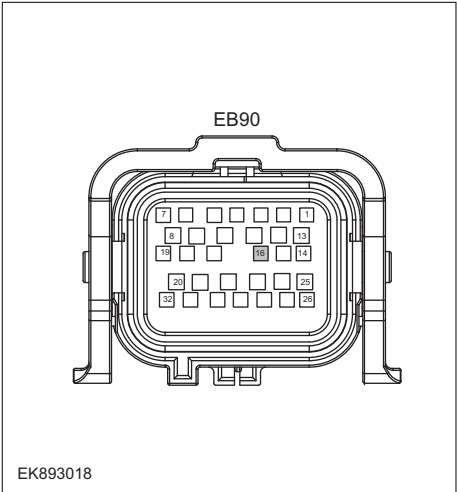
Step 4	Check BMS circuit. (Short circuit)
 <p>EK893018</p>	<ol style="list-style-type: none"> 1 Turn the ignition switch to OFF. 2 Connect the harness plug IP01_B of body control module. 3 Measure the resistance between the harness terminal of BMS and ground. Measuring circuit: resistance between terminal 16 on plug EB90 and ground. Standard value: ∞ 4 Measure the voltage between the harness terminal of BCM and ground. Measuring circuit: voltage between terminal 16 on plug EB90 and ground. Standard value: $\approx 0V$ 5 Check whether the result is normal or not?
NO → Repair or replace the faulted parts.	
YES ↓	
Step 5	Test whether BMS is norm.
	<ol style="list-style-type: none"> 1 Turn the ignition switch to OFF. 2 Disconnect and check the harness plug EB90 of BMS. 3 Check and repair. <ul style="list-style-type: none"> • Corrosion (install new adapting piece or terminal-cleaning module and pin). • Pin damaged or bent - install new terminal/pin. • Fly out of pins - install new pins as needed. 4 Reconnect the BMS plug and all other previously disconnected plug. Make sure the pin is properly positioned and fixed. 5 Run the system and determine if the problem persists?
YES → Replace the BMS.	
NO ↓	
At this point the system is functioning normally. The problem may be caused by module connections. Address the root cause of any connector or pin problems.	
Next Step ↓	
Diagnosis end.	

P1D45-F0、 P1D45-F1、 P1D45-F2、 P1E01-F0、 P1E01-F1、 P1E01-F2、 P1E02-F0、 P1E03-F0

Fault diagnosis code
P1D45-F0: Cell temperature sensor fault - level 1
P1D45-F1: Cell temperature sensor fault - level 2
P1D45-F2: Cell Temperature measurement fault
P1E01-F0: Cell temperature high - level 1
P1E01-F1: Cell temperature high - level 2
P1E01-F2: Cell temperature high - level 3
P1E02-F0: Cell temperature low - level 1
P1E03-F0: Cell temperature difference high - level 1
Detection tools
1 Multimeter and diagnostic apparatus
Possible causes
<ul style="list-style-type: none"> • BMS fault • BMS internal temperature sensor fault • BMS internal temperature circuit fault
Conditions for fault code operation
Turn the ignition switch to ON position.
Conditions for fault code setting
P1D45-F0
The sampled battery temperature exceeds the normal range, but the system temperature monitoring function is not affected: The temperature sampling value exceeds the sampling range (-40 °C ~120 °C), and one unit module appears;
P1D45-F1
The sampled battery temperature exceeds the normal range, and the system temperature monitoring function is affected: The temperature sampling value exceeds the sampling range (-40 °C ~120 °C), and two unit modules appear; or the module has only one temperature sampling point, and the temperature sampling value of the temperature sampling point is out of the sampling range(-40 °C ~120 °C);
P1D45-F2
The sampling chip or 3/8 decoder is abnormal:sampling chip error(ErrorMash is not equal to zero), or 3/8 decoder reference voltage anomaly
P1E01-F0
The maximum battery temperature is higher than the alarm threshold: $T_{max} \geq 60\text{ }^{\circ}\text{C}$
P1E01-F1
The maximum battery temperature is higher than the protection threshold: $T_{max} \geq 65\text{ }^{\circ}\text{C}$
P1E01-F2
The maximum battery temperature is higher than the safe threshold: $T_{max} \geq 69\text{ }^{\circ}\text{C}$

BMS(CN)

P1E02-F0
The minimum battery temperature is lower than the protection threshold: $\leq -25\text{ }^{\circ}\text{C}$
P1E03-F0
The difference between maximum battery temperature and the minimum battery temperature exceeds battery system alarm threshold: $(T_{\text{max}} - T_{\text{min}}) \geq 20\text{ }^{\circ}\text{C}$
To set the effect of a fault code condition
Function is limited

Troubleshooting steps	
Step 1	General inspection.
	<ol style="list-style-type: none"> 1 Check battery capacity. 2 Check the harness plug of BMS for damage, poor contact, aging and looseness. 3 Check the harness plug of battery pack high voltage for damage, poor contact, aging and looseness. 4 Check whether the result is normal or not?
	NO → Repair or replace the faulted parts.
YES ↓	
Step 2	Check fault codes.
	<ol style="list-style-type: none"> 1 Connect the fault diagnosis instrument to the diagnosis interface. 2 Turn the ignition switch to ON position. 3 Diagnose the BMS with diagnostic apparatus. 4 If there is any fault code except for P1D45-F0, P1D45-F1, P1D45-F2, P1E01-F0, P1E01-F1, P1E01-F2, P1E02-F0, P1E03-F0?
	YES → Refer to: DTC Summary list(BMS) .
NO ↓	
Step 3	Check cooling system.
	<ol style="list-style-type: none"> 1 Check whether there is leakage or poor heat dissipation in the cooling system. 2 Check whether the result is normal or not?
	NO → Repair the cooling system.
YES ↓	
Step 4	Check the connecting cable of BMS.
	<ol style="list-style-type: none"> 1 Turn the ignition switch to OFF. 2 Make protective preparations according to the safety operation specifications of the high voltage voltage in the maintenance manual. 3 Disconnect the harness plug battery pack high voltage. 4 Disconnect the high voltage harness plug of BMS. 5 Check whether the BMS connection cable is rotten, damaged, and water enters. 6 Check whether the result is normal or not?
	NO → Repair or replace the faulted parts.
YES ↓	

BMS(CN)

Step 5	Perform initialization.	
		<ol style="list-style-type: none"> 1 Turn the ignition switch to OFF. 2 Connect the fault diagnosis instrument to the diagnosis interface. 3 Turn the ignition switch to ON. 4 The BMS module was initialized with the diagnostic instrument. 5 Can the BMS be initialized and is the BMS restored?
		NO → Repair or change the BMS module.
YES ↓		
Step 6	Test whether BMS is norm.	
		<ol style="list-style-type: none"> 1 Turn the ignition switch to OFF. 2 Disconnect and check the harness plug EB90of BMS. 3 Check and repair. <ul style="list-style-type: none"> • Corrosion(install new adapting piece or terminal-cleaning module and pin). • Pin damaged or bent-install new terminal/pin. • Fly out of pins-install new pins as needed. 4 Reconnect the BMS plug and all other previously disconnected plug. Make sure the pin is properly positioned and fixed. 5 Run the system and determine if the problem persists?
		YES → Replace the BMS.
NO ↓		
At this point the system is functioning normally. The problem may be caused by module connections. Address the root cause of any connector or pin problems.		
Next Step ↓		
Diagnosis end.		

P1DF3-F1、 P1DF3-F0

Fault diagnosis code
P1DF3-F1: DC charging socket over temperature level 2
P1DF3-F2: DC charging socket over temperature level 1
Detection tools
1 Multimeter and diagnostic apparatus
Possible causes
<ul style="list-style-type: none"> • Circuit,terminal and adapting piece fault • Temperature sensor fault
Conditions for fault code operation
Turn the ignition switch to ON position.
Conditions for fault code setting
P1DF3-F1
DC charging socket temperature sampling value and valid and temperature ≥ 120 °C &&DC charging gun insertion is effective
P1DF3-F0
DC charging socket temperature sampling value and valid and temperature ≥ 100 °C &&DC charging gun insertion is effective
To set the effect of a fault code condition
Description of circuit diagram

Circuit diagram

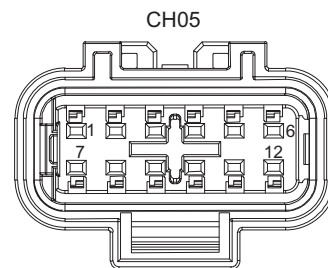
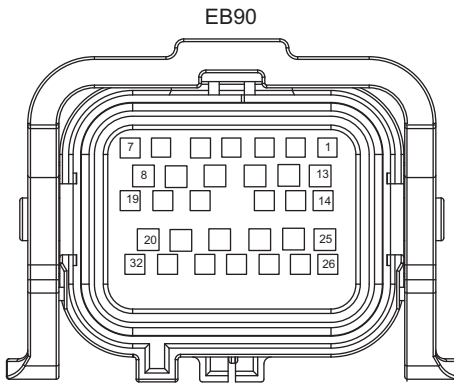
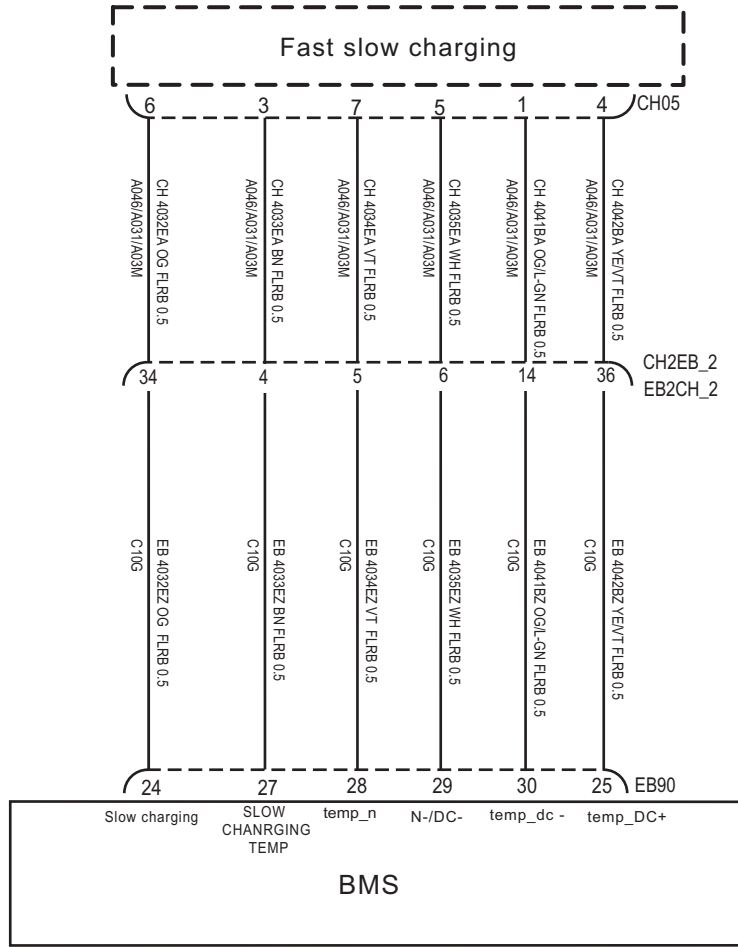



EK893010

Troubleshooting steps	
Step 1	General inspection.
	<ol style="list-style-type: none"> 1 Check the fuse for damage. 2 Check battery capacity. 3 Check the harness plug of BMS for damage, poor contact, aging and looseness. 4 Check whether the result is normal or not?
	NO → Repair or replace the faulted parts.
YES ↓	
Step 2	Check fault codes.
	<ol style="list-style-type: none"> 1 Connect the fault diagnosis instrument to the diagnosis interface. 2 Turn the ignition switch to ON position. 3 Diagnose the BMS with diagnostic apparatus. 4 If there is any fault code except for P1DF3-F1,P1DF3-F0?
	YES → Refer to: DTC Summary list(BMS) .
NO ↓	
Step 3	Check CDU.
	<ol style="list-style-type: none"> 1 Connect the fault diagnosis instrument to the diagnosis interface. 2 Turn the ignition switch to ON position. 3 Diagnose the CDU with diagnostic apparatus. 4 Test whether the faulted code is existed.
	YES → DTC diagnosis is performed based on specific fault codes.
NO ↓	
Step 4	Check the DC power supply.
	<ol style="list-style-type: none"> 1 Make protective preparations according to the safety operation specifications of the high voltage voltage in the maintenance manual. 2 Check the DC power supply. 3 Check whether the result is normal or not?
	NO → Replace the AC power in good condition.
YES ↓	

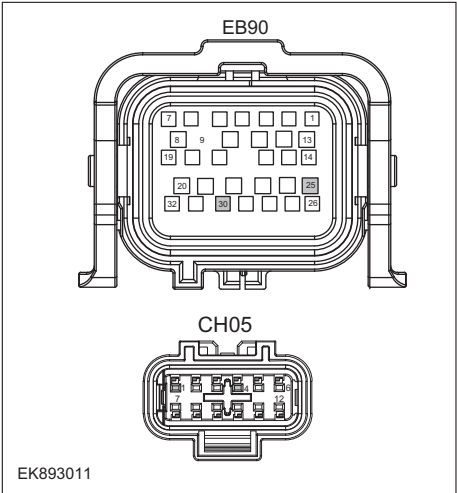
BMS(CN)

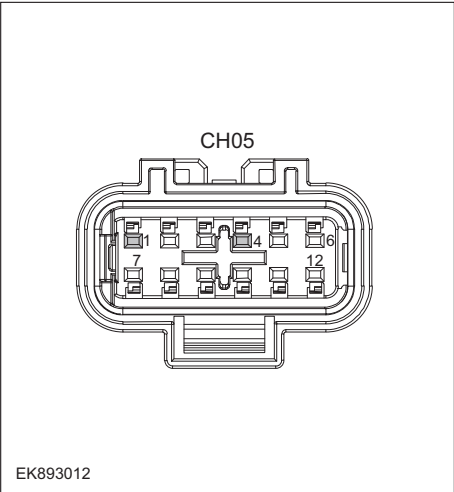
Step 5	Check the circuit between fast charging and BMS. (Open circuit)
 <p data-bbox="212 719 288 734">EK893011</p>	<ol style="list-style-type: none"> 1 Turn the ignition switch to OFF. 2 Disconnect the harness plug CH05 of fast charging. 3 Disconnect the harness plug EB90 of BMS. 4 Measure the resistance between the harness terminals of fast charging and BMS. Measuring circuit: resistance between terminal 1 on plug CH05 and terminal 30 on plug EB90. Measuring circuit: resistance between terminal 4 on plug CH05 and terminal 25 on plug EB90. Standard value: < 1Ω 5 Check whether the result is normal or not?
	<p>NO → Repair or replace the faulted parts.</p>
<p>YES ↓</p>	

Step 6	Check the circuit of fast charging. (Short circuit)
<div style="text-align: center;">  <p>CH05</p> <p>EK893012</p> </div>	<ol style="list-style-type: none"> 1 Turn the ignition switch to OFF. 2 Connect the harness plug EB90 of BMS. 3 Measure the resistance between the harness terminal of fast charging and ground. Measuring circuit: resistance between terminal 1 on plug CH05 and ground. Measuring circuit: resistance between terminal 4 on plug CH05 and ground. Standard value: ∞ 4 Measure the voltage between the harness terminal of BMS and ground. Measuring circuit: voltage between terminal 1 on plug CH05 and ground. Measuring circuit: voltage between terminal 4 on plug CH05 and ground. Standard value: $\approx 0V$ 5 Check whether the result is normal or not?
	<p>NO → Repair or replace the faulted parts.</p>
<p>YES ↓</p>	

Step 7	Check the DC charging gun (functional check).
<p style="text-align: center;">直流充电枪接口</p>  <p style="text-align: left; margin-left: 10px;">EK893028</p>	<p>1 Measure the resistance between the harness terminals of DC charging gun.</p> <p>Measure circuit: resistance between the DC+ and DC- terminals of the DC charging gun.</p> <p>Standard value: ∞</p> <p>Measure circuit: resistance between A+ and A- terminals of the DC charging gun.</p> <p>Standard value: ∞</p> <p>Measure circuit: resistance between the S+ and S- terminals of the DC charging gun.</p> <p>Standard value: 120 Ω</p> <p>Measure circuit: resistance between CC1 and CC2 terminals of the DC charging gun.</p> <p>Standard value: ∞</p> <p>Measure circuit: resistance between the CC1 and PE terminals of the DC charging gun.</p> <p>Standard value(connect the confirmation switch): ∞</p> <p>Standard value(disconnect the confirmation switch): 1000 Ω</p> <p>Measure circuit: resistance between the CC2 and PE terminals of the DC charging gun.</p> <p>Standard value: 1000 Ω</p> <p>2 Check whether the result is normal or not?</p>
	<p>NO → Repair or replace the faulted parts.</p>
<p>YES ↓</p>	

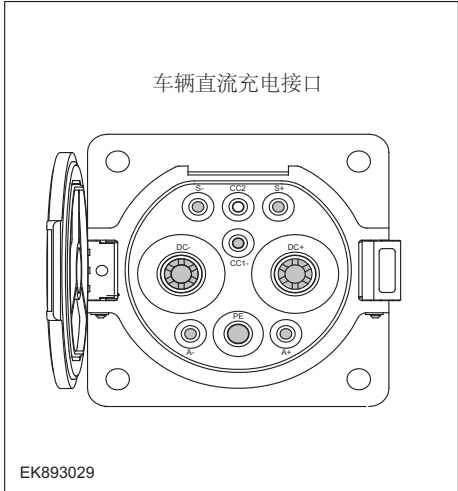
Step 8	Check the DC charging port of the vehicle (functional check).
	<ol style="list-style-type: none"> 1 Turn the ignition switch to OFF. 2 Open the vehicle DC charging port cover. 3 Measure the resistance between the harness terminals of DC charging port. Measure circuit: resistance between the DC+ and DC- terminals of the DC charging gun. Standard value: ∞ Measure circuit: resistance between A+ and A- terminals of the DC charging gun. Standard value: ∞ Measure circuit: resistance between the S+ and S- terminals of the DC charging gun. Standard value: 120 Ω Measure circuit: resistance between the CC1 and PE terminals of the DC charging gun. Standard value: 1000 Ω 4 Check whether the result is normal or not?
NO → Repair or replace the faulted parts.	
YES ↓	
Step 9	Check the high-voltage cable connecting the DC charging port of the vehicle to the CDU (wiring harness conduction check).
	<ol style="list-style-type: none"> 1 Turn the ignition switch to OFF. 2 Disconnect AC charging high-voltage cable of CDU. 3 Measure the resistance between the harness terminals of DC charging port interface and plug. Measure circuit: the resistance between the DC+, DC- of AC charging port and CDU. Standard value: $\approx 0\Omega$ 4 Check whether the result is normal or not?
NO → Repair or replace the faulted parts.	
YES ↓	

BMS(CN)

Step 10	Test whether BMS is norm.
	<ol style="list-style-type: none"> 1 Turn the ignition switch to OFF. 2 Disconnect and check the harness plug EB90of BMS. 3 Check and repair. <ul style="list-style-type: none"> • Corrosion(install new adapting piece or terminal-cleaning module and pin). • Pin damaged or bent-install new terminal/pin. • Fly out of pins-install new pins as needed. 4 Reconnect the BMS plug and all other previously disconnected plug. Make sure the pin is properly positioned and fixed. 5 Run the system and determine if the problem persists?
	YES → Replace the BMS.
NO ↓	
At this point the system is functioning normally. The problem may be caused by module connections. Address the root cause of any connector or pin problems.	
Next Step ↓	
Diagnosis end.	

P1DF2-F1

Fault diagnosis code
P1DF2-F1: AC charging socket over temperature
Detection tools
1 Multimeter and diagnostic apparatus
Possible causes
<ul style="list-style-type: none"> • Circuit, terminal and adapting piece fault • Temperature sensor fault
Conditions for fault code operation
Turn the ignition switch to ON position.
Conditions for fault code setting
P1DF2-F1
AC charging socket temperature sampling value valid and temperature \geq [CaERRT_ACChrgPlugOverTempFitValue(1,2)=100] °C && AC charging gun insertion signal is effective
To set the effect of a fault code condition
Description of circuit diagram

Circuit diagram

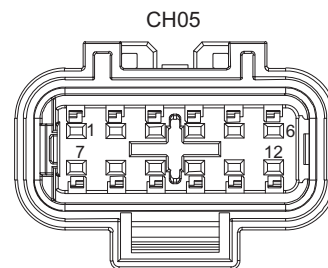
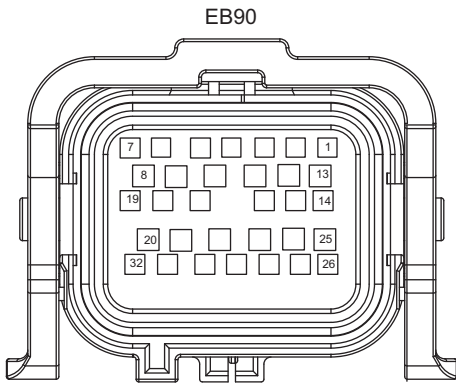
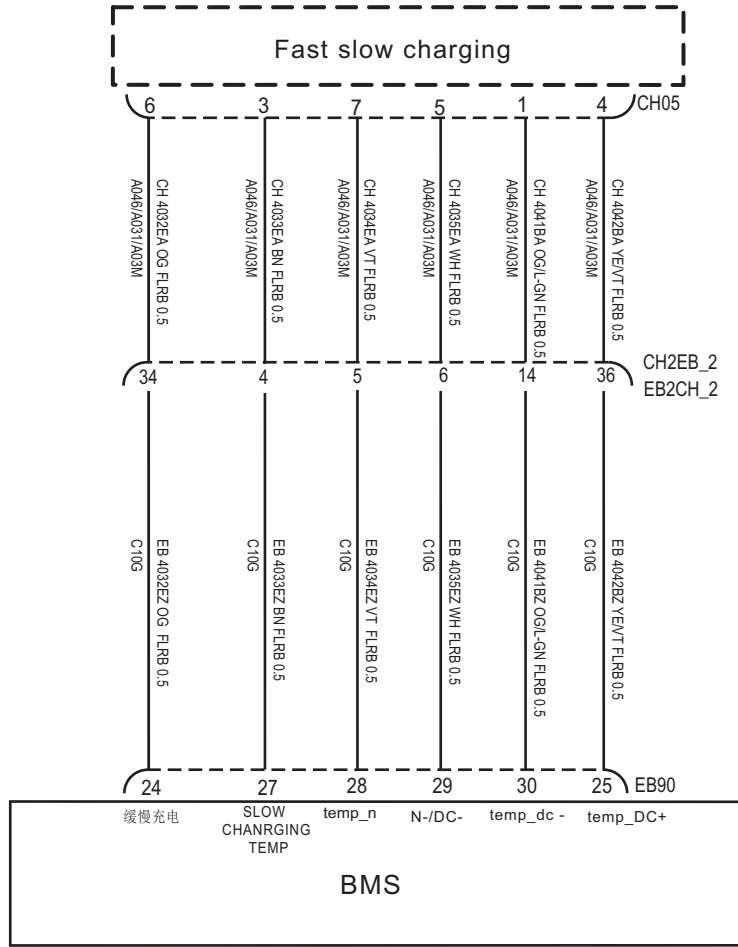



EK893013

Troubleshooting steps	
Step 1	General inspection.
	<ol style="list-style-type: none"> 1 Check the fuse for damage. 2 Check battery capacity. 3 Check the harness plug of BMS for damage, poor contact, aging and looseness. 4 Check whether the result is normal or not?
	NO → Repair or replace the faulted parts.
YES ↓	
Step 2	Check fault codes.
	<ol style="list-style-type: none"> 1 Connect the fault diagnosis instrument to the diagnosis interface. 2 Turn the ignition switch to ON position. 3 Diagnose the BMS with diagnostic apparatus. 4 Is there any other fault code except for P1DF2-F1?
	YES → Refer to: DTC Summary list(BMS) .
NO ↓	
Step 3	Check CDU.
	<ol style="list-style-type: none"> 1 Connect the fault diagnosis instrument to the diagnosis interface. 2 Turn the ignition switch to ON position. 3 Diagnose the CDU with diagnostic apparatus. 4 Test whether the faulted code is existed.
	YES → DTC diagnosis is performed based on specific fault codes.
NO ↓	
Step 4	Check the AC power supply.
	<ol style="list-style-type: none"> 1 Make protective preparations according to the safety operation specifications of the high voltage voltage in the maintenance manual. 2 Measure the AC power voltage. Measure circuit: voltage between the L and N terminals of the AC power socket. Standard value: 198V~235.4V 3 Check whether the result is normal or not?
	NO → Replace the AC power in good condition.
YES ↓	

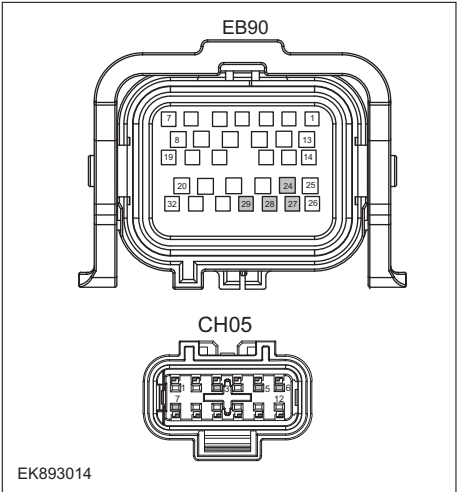
BMS(CN)

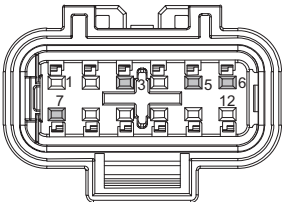
Step 5	Check the circuit between slow charging and BMS. (Open circuit)
 <p>EK893014</p>	<ol style="list-style-type: none"> 1 Turn the ignition switch to OFF. 2 Disconnect the harness plug EB90of BMS. 3 Disconnect the harness plug CH05 of slow charging. 4 Measure the resistance between the harness terminals of BMS and slow charging. <ul style="list-style-type: none"> Measuring circuit: resistance between terminal 27 on plug EB90and terminal 3 on plug CH05. Measuring circuit: resistance between terminal 29 on plug EB90and terminal 5 on plug CH05. Measuring circuit: resistance between terminal 24 on plug EB90and terminal 6 on plug CH05. Measuring circuit: resistance between terminal 28 on plug EB90and terminal 7 on plug CH05. <p>Standard value: < 1Ω</p> 5 Check whether the result is normal or not?
	<p>NO → Repair or replace the faulted parts.</p>
<p>YES ↓</p>	

Step 6	Check the circuit of slow charging. (Short circuit)
<div data-bbox="240 253 699 745" style="text-align: center;">  <p>CH05</p> <p>EK893015</p> </div>	<ol style="list-style-type: none"> 1 Turn the ignition switch to OFF. 2 Connect the harness plug EB90 of BMS. 3 Measure the resistance between the harness terminal of slow charging and ground. <ul style="list-style-type: none"> Measuring circuit: resistance between terminal 3 on plug CH05 and ground. Measuring circuit: resistance between terminal 5 on plug CH05 and ground. Measuring circuit: resistance between terminal 6 on plug CH05 and ground. Measuring circuit: resistance between terminal 7 on plug CH05 and ground. <p>Standard value: ∞</p> 4 Measure the voltage between the harness terminal of slow charging and ground. <ul style="list-style-type: none"> Measuring circuit: voltage between terminal 3 on plug CH05 and ground. Measuring circuit: voltage between terminal 5 on plug CH05 and ground. Measuring circuit: voltage between terminal 6 on plug CH05 and ground. Measuring circuit: voltage between terminal 7 on plug CH05 and ground. <p>Standard value: $\approx 0V$</p> 5 Check whether the result is normal or not?
	<p>NO → Repair or replace the faulted parts.</p>
<p>YES ↓</p>	

Step 7	Check the AC charging gun (functional check).
 <p>交流充电枪接口</p> <p>EK894011</p>	<p>1 Measure the resistance between the harness terminals of AC charging gun.</p> <p>Measure circuit: resistance between the L and PE terminals of the AC charging gun.</p> <p>Standard value: ∞</p> <p>Measure circuit: the resistance between the N and PE terminals of AC charging gun.</p> <p>Standard value: ∞</p> <p>Measure circuit: resistance between the CP and PE terminals of the AC charging gun.</p> <p>Standard value: ∞</p> <p>Measure circuit: resistance between the CC and PE terminals of the AC charging gun.</p> <p>Standard value(connect the confirmation switch): ∞</p> <p>Standard value(disconnect the confirmation switch): 680Ω</p> <p>2 Check whether the result is normal or not?</p>
<p>NO → Repair or replace the faulted parts.</p>	
<p>YES ↓</p>	

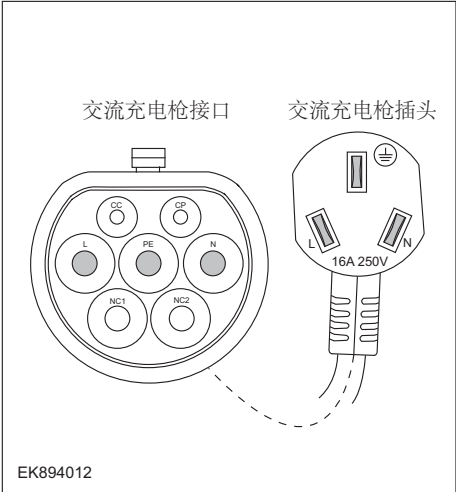
Step 8	Check the AC charging gun (wiring harness conduction check).
 <p>交流充电枪接口 交流充电枪插头</p> <p>EK894012</p>	<p>1 Measure the resistance between the harness terminals of AC charging gun and plug.</p> <p>Measure circuit: resistance between the PE terminal of the AC charging gun and grounding terminal of plug.</p> <p>Standard value: $\approx 0 \Omega$</p> <p>Measure circuit: resistance between the L terminal of the AC charging gun interface and the L terminal of the plug.</p> <p>Standard value: $\approx 0 \Omega$</p> <p>Measure circuit: the resistance between the N terminal of the AC charging gun interface and the N terminal of the plug.</p> <p>Standard value: $\approx 0 \Omega$</p> <p>2 Check whether the result is normal or not?</p>
<p>NO → Repair or replace the faulted parts.</p>	
<p>YES ↓</p>	

Step 9	Check the AC charging port of the vehicle (functional check).
	<ol style="list-style-type: none"> 1 Turn the ignition switch to OFF. 2 Open the vehicle AC charging port cover. 3 Measure the resistance between the harness terminals of AC charging port interface. Measure circuit: resistance between the L and PE terminals of the AC charging port. Standard value: ∞ Measure circuit: the resistance between the N and PE terminals of AC charging port. Standard value: ∞ Measure circuit: resistance between the CP and PE terminals of the AC charging port. Standard value: ∞ Measure circuit: resistance between the CC and PE terminals of the AC charging port. Standard value(connect the confirmation switch): ∞ Standard value(disconnect the confirmation switch): 680 Ω 4 Check whether the result is normal or not?
NO → Repair or replace the faulted parts.	
YES ↓	
Step 10	Check the high-voltage cable connecting the AC charging port of the vehicle to the CDU (wiring harness conduction check).
	<ol style="list-style-type: none"> 1 Turn the ignition switch to OFF. 2 Disconnect AC charging high-voltage cable of CDU. 3 Measure the resistance between the harness terminals of AC charging port interface and plug. Measure circuit: the resistance between the L1, L2, L3, N of AC charging port and CDU. Standard value: $\approx 0\Omega$ 4 Check whether the result is normal or not?
NO → Repair or replace the faulted parts.	
YES ↓	

BMS(CN)

Step 11	Test whether BMS is norm.
	<ol style="list-style-type: none"> 1 Turn the ignition switch to OFF. 2 Disconnect and check the harness plug EB90of BMS. 3 Check and repair. <ul style="list-style-type: none"> • Corrosion(install new adapting piece or terminal-cleaning module and pin). • Pin damaged or bent-install new terminal/pin. • Fly out of pins-install new pins as needed. 4 Reconnect the BMS plug and all other previously disconnected plug. Make sure the pin is properly positioned and fixed. 5 Run the system and determine if the problem persists?
	YES → Replace the BMS.
NO ↓	
At this point the system is functioning normally. The problem may be caused by module connections. Address the root cause of any connector or pin problems.	
Next Step ↓	
Diagnosis end.	

P1DF7-00、P1DF7-F0、P1DF7-F1、P1DF7-F2、P1DF8-F0、P1DF8-F1、P1DF8-F2、P1DF9-F0、P1DF9-F1、P1DF9-F2

Fault diagnosis code
P1DF7-00: Over Current Peak Error
P1DF7-F0: Discharge over current level 1
P1DF7-F1: Discharge over current level 2
P1DF7-F2: Discharge over current level 3
P1DF8-F0: Charge over current level 1
P1DF8-F1: Charge over current level 2
P1DF8-F2: Charge over current level 3
P1DF9-F0: Recharge over current level 1
P1DF9-F1: Recharge over current level 2
P1DF9-F2: Recharge over current level 3
Detection tools
1 Multimeter and diagnostic apparatus
Possible causes
<ul style="list-style-type: none"> • BMS fault • BMS insulation fault • BMS high voltage circuit fault • The current circuit of BMS fault
Conditions for fault code operation
Turn the ignition switch to ON position.
Conditions for fault code setting
P1DF7-00
The fuse may break due to excessive passing current: bus circuit current $\geq 1000A$
P1DF7-F0
Any branch discharge current is higher than the alarm threshold: $\geq 1.05 \times \text{look-up discharge current} + 1A$
P1DF7-F1
Any branch discharge current is higher than the alarm threshold: $\geq 1.2 \times \text{look-up discharge current} + 1A$
P1DF7-F2
Any branch discharge current is higher than the alarm threshold: $\geq 1.25 \times \text{look-up discharge current} + 1A$
P1DF8-F0
Any branch charge current is higher than the alarm threshold: $\leq 1.05 \times \text{look-up charge current} + 1A$
P1DF8-F1
Any branch charge current is higher than the alarm threshold: $\leq 1.1 \times \text{look-up charge current} + 1A$

BMS(CN)

P1DF8-F2
Any branch charge current is higher than the alarm threshold: $\leq 1.2 \cdot \text{look-up charge current} + 1\text{A}$
P1DF9-F0
The recharging flow of any branch is higher than the alarm threshold in driving mode: $\leq 1.05 \cdot \text{look-up recharge current} + 1\text{A}$
P1DF9-F1
The recharging flow of any branch is higher than the protection threshold in driving mode: $\leq 1.2 \cdot \text{look-up recharge current} + 1\text{A}$
P1DF9-F2
The recharging flow of any branch is higher than the safe threshold in driving mode: $\leq 1.25 \cdot \text{look-up recharge current} + 1\text{A}$
To set the effect of a fault code condition

Troubleshooting steps	
Step 1	General inspection.
	<ol style="list-style-type: none"> 1 Check battery capacity. 2 Check the harness plug of BMS for damage, poor contact, aging and looseness. 3 Check the harness plug of battery pack high voltage for damage, poor contact, aging and looseness. 4 Check whether the result is normal or not?
	NO → Repair or replace the faulted parts.
YES ↓	
Step 2	Check fault codes.
	<ol style="list-style-type: none"> 1 Connect the fault diagnosis instrument to the diagnosis interface. 2 Turn the ignition switch to ON position. 3 Diagnose the BMS with diagnostic apparatus. 4 If there is any fault code except for P1DF7-00/P1DF7-F0/P1DF7-F1/P1DF8-F0/P1DF8-F1/P1DF8-F2?
	YES → Refer to: DTC Summary list(BMS) .
NO ↓	
Step 3	Check the connecting cable of BMS.
	<ol style="list-style-type: none"> 1 Turn the ignition switch to OFF. 2 Make protective preparations according to the safety operation specifications of the high voltage voltage in the maintenance manual. 3 Disconnect the harness plug battery pack high voltage. 4 Disconnect the high voltage harness plug of BMS. 5 Check whether the BMS connection cable is rotten, damaged, and water enters. 6 Check whether the result is normal or not?
	NO → Repair or replace the faulted parts.
YES ↓	

BMS(CN)

Step 4	Check the insulation of BMS.	
	1	Use a megohm meter to check the insulation resistance of the BMS housing and grounding according to the procedure in the maintenance manual. Standard value (insulation level 1) > 750Ω/V (DC charging > 500Ω/V) Standard value (insulation level 2) > 500Ω/V (DC charging > 100Ω/V)
	2	Check whether the result is normal or not?
	NO →	Repair or replace the faulted parts.
YES ↓		
Step 5	Check the insulation of BMS high-voltage cables.	
	1	Use a megohm meter to check the insulation resistance of the BMS high voltage and grounding according to the procedure in the maintenance manual. Standard value (insulation level 1) > 750Ω/V (DC charging > 500Ω/V) Standard value (insulation level 2) > 500Ω/V (DC charging > 100Ω/V)
	2	Check whether the result is normal or not?
	NO →	Repair or replace the faulted parts.
YES ↓		
Step 6	Perform initialization.	
	1	Turn the ignition switch to OFF.
	2	Connect the fault diagnosis instrument to the diagnosis interface.
	3	Turn the ignition switch to ON.
	4	The BMS module was initialized with the diagnostic instrument.
	5	Can the BMS be initialized and is the BMS restored?
	NO →	Repair or change the BMS module.
YES ↓		

Step 7	Test whether BMS is norm.
	<ol style="list-style-type: none"> 1 Turn the ignition switch to OFF. 2 Disconnect and check the harness plug EB90of BMS. 3 Check and repair. <ul style="list-style-type: none"> • Corrosion(install new adapting piece or terminal-cleaning module and pin). • Pin damaged or bent-install new terminal/pin. • Fly out of pins-install new pins as needed. 4 Reconnect the BMS plug and all other previously disconnected plug. Make sure the pin is properly positioned and fixed. 5 Run the system and determine if the problem persists?
	YES → Replace the BMS.
NO ↓	
At this point the system is functioning normally. The problem may be caused by module connections. Address the root cause of any connector or pin problems.	
Next Step ↓	
Diagnosis end.	

BMS(CN)

U1007-00、 U0073-87、 U0074-88、 U0111-87、 U0112-87、 U1001-00、 U1009-00、 U1013-00

Fault diagnosis code
U1007-00: DC charge equipment fault
U0073-87: Vehicle CAN BusOff fault
U0074-88: BMS internal CAN Busoff fault
U0111-87: Vehicle CAN Bus error
U0112-87: BMS internal CAN Bus error
U1001-00: BMS Charging CAN Busoff fault
U1009-00: Internal daisy chain no update fault
U1013-00: BMS stop charging abnormally
Detection tools
1 Multimeter and diagnostic apparatus
Possible causes
<ul style="list-style-type: none">• Circuit,terminal and adapting piece fault• PEU Module
Conditions for fault code operation
Turn the ignition switch to ON position.
Conditions for fault code setting
U1007-00
The CC sampling voltage is out of the normal voltage range
U0073-87
The BMS cannot receive all ACAN packets.
U0074-88
The SCAN bus is Busoff.
U0111-87
The BMS cannot receive all ACAN packets.
U0112-87
The BMS cannot receive all SCAN packets.
U1001-00
The TCAN bus is Busoff.
U1009-00
The daisy chain communication data between the sampling chips has not been updated continuously.
U1013-00
During the charging process, the BMS fault causes the charging exit.
To set the effect of a fault code condition

Description of circuit diagram

The device is connected to serial data circuit, which is used to monitor the communication situation of serial data during normal operation of vehicle. The devices will exchange the operation information and commands mutually. The device has programming information required to be exchanged on the serial data circuit. The receiver device will also monitor such information; in addition, there are some regular information indication transmitter devices available.

Circuit diagram

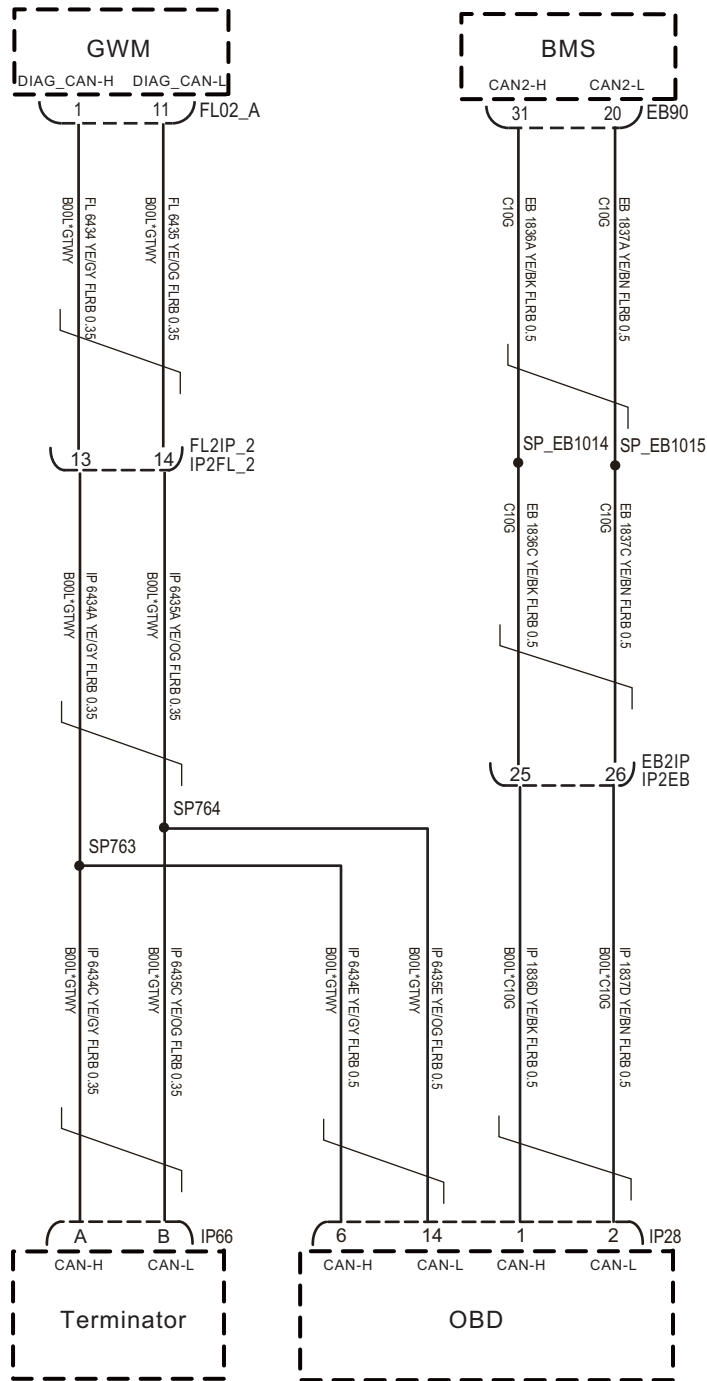

EK893025

Circuit diagram

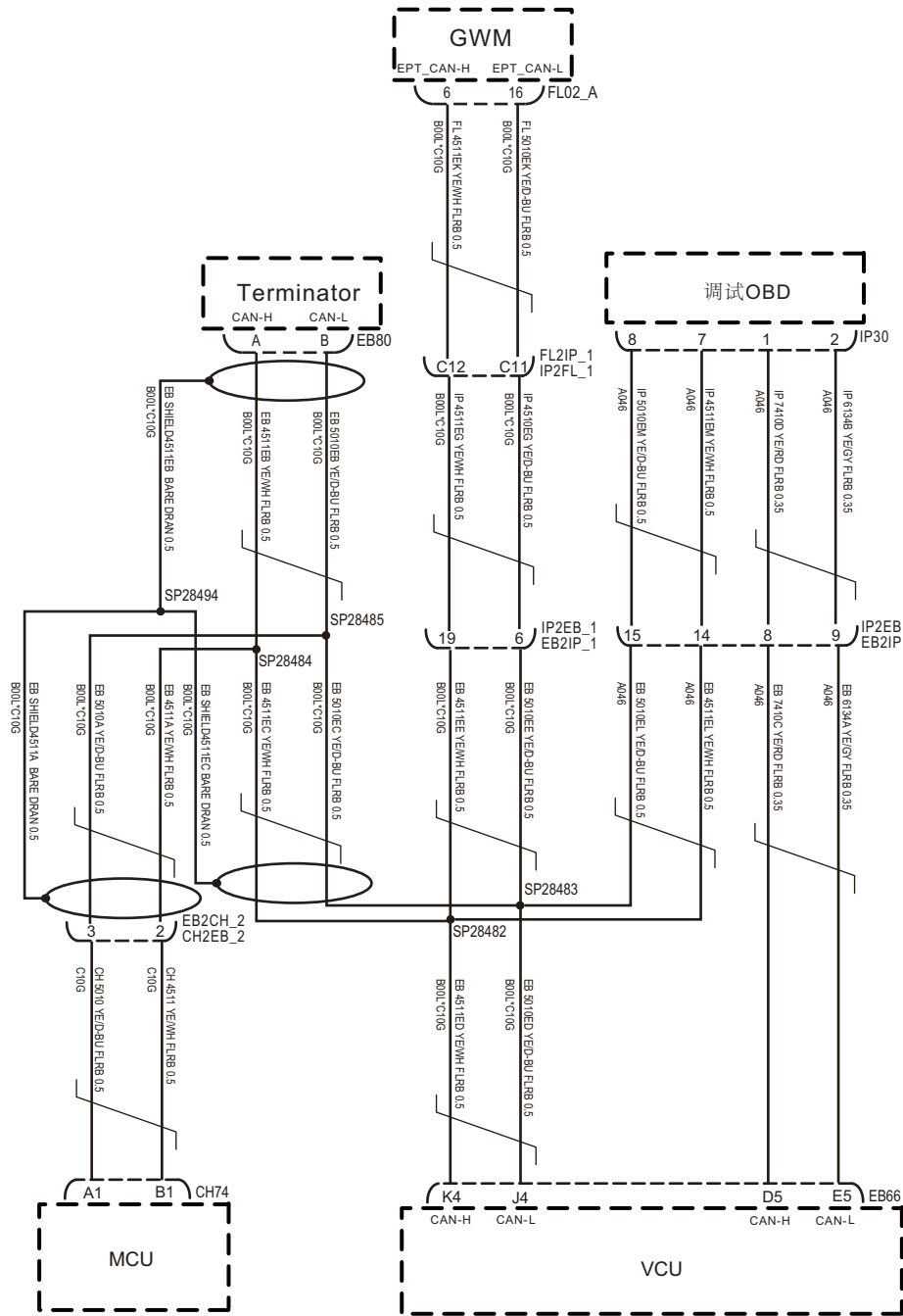

EK893026

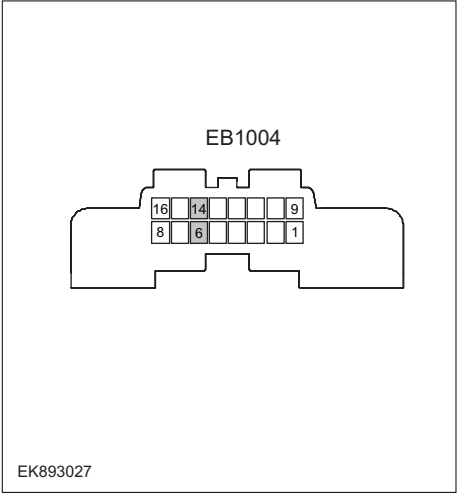
Troubleshooting steps	
Step 1	General inspection.
	<ol style="list-style-type: none"> 1 Check the fuse for damage. 2 Check battery capacity. 3 Check the harness plug of CDU for damage, poor contact, aging and looseness. 4 Check whether the result is normal or not?
NO → Repair or replace the faulted parts.	
YES ↓	
Step 2	Check fault codes.
	<ol style="list-style-type: none"> 1 Connect the fault diagnosis instrument to the diagnosis interface. 2 Turn the ignition switch to ON position. 3 Diagnose the CDU with diagnostic apparatus. 4 If there is any fault code except for U1007-00, U0111-87, U0074-88、U0073-87、U0112-87、U1001-00、U1009-00、U1013-00?
YES → Refer to: DTC Summary list(BMS) .	
NO ↓	
Step 3	Inspection for CAN communication network completeness.
	<ol style="list-style-type: none"> 1 Turn the ignition switch to OFF. 2 Measure the resistance between the harness terminals of diagnose interface. Measuring circuit: resistance between terminal 6 and terminal 14 on plug IP28. Standard value: $\approx 60\Omega$ 3 Check whether the result is normal or not?
NO → Repair or replace the faulted parts.	
YES ↓	

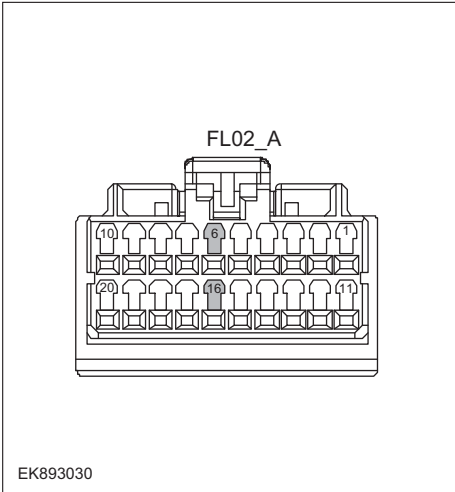
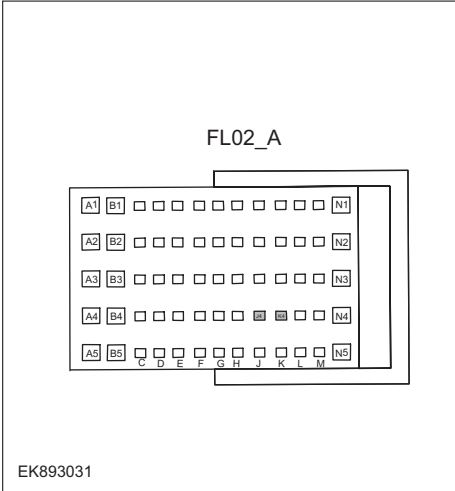
<p>Step 4</p>	<p>Check the terminating resistance of GAW module and VCU resistor.</p>
<div style="text-align: center;">  <p>EK893030</p> </div> <div style="text-align: center; margin-top: 20px;">  <p>EK893031</p> </div>	<ol style="list-style-type: none"> 1 Turn the ignition switch to OFF. 2 Disconnect the harness plug EL02_A of network gateway module. 3 Measure the resistance between harness terminals on network gateway module. Measuring circuit: the resistance between terminal 6 and 16 on plug EL02_A. Standard value: 110~130Ω 4 Connect the harness plug EL02_A of network gateway module. 5 Disconnect the harness plug EB66 of GAW module. 6 Measure the resistance between harness terminals on GAW module. Measuring circuit: resistance between terminal K4 and terminal J4 on plug EB66. Standard value: 110~130Ω 7 Check whether the result is normal or not?
<p>NO → Repair or replace the faulted parts.</p>	
<p>YES ↓</p>	
<p>Step 5</p>	<p>Test whether BMS is norm.</p>
	<ol style="list-style-type: none"> 1 Turn the ignition switch to OFF. 2 Disconnect and check the harness plug EB90of BMS. 3 Check and repair. <ul style="list-style-type: none"> • Corrosion(install new adapting piece or terminal-cleaning module and pin). • Pin damaged or bent-install new terminal/pin. • Fly out of pins-install new pins as needed. 4 Reconnect the BMS plug and all other previously disconnected plug. Make sure the pin is properly positioned and fixed. 5 Run the system and determine if the problem persists?
<p>YES → Replace the BMS.</p>	
<p>NO ↓</p>	

BMS(CN)

At this point the system is functioning normally. The problem may be caused by module connections. Address the root cause of any connector or pin problems.

Next Step ↓

Diagnosis end.

P1B23-00、 P1B1F-F0、 P1B1F-F1、 P1B1F-F2、 P1B20-00

Fault diagnosis code
P1B23-00: DC charging positive relay adhesion failure
P1B1F-F0: DC charge positive contactor coil circuit short to GND fault
P1B1F-F1: DC charge positive contactor coil circuit short to power fault
P1B1F-F2: DC charge positive contactor coil circuit open fault
P1B20-00: DC charge positive contactor coil circuit current abnormal fault
Detection tools
1 Multimeter and diagnostic apparatus
Possible causes
<ul style="list-style-type: none"> • BMS fault • DC charging positive relay fault • BMS DC charging positive relay circuit fault
Conditions for fault code operation
Turn the ignition switch to ON position.
Conditions for fault code setting
P1B23-00
P1B1F-F0
P1B1F-F1
P1B1F-F2
P1B20-00
To set the effect of a fault code condition
Description of circuit diagram

Circuit diagram

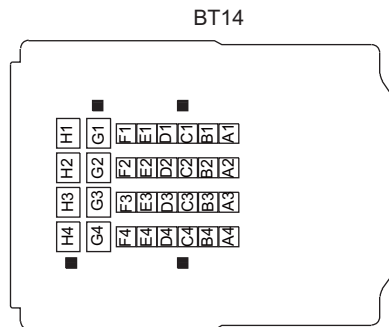
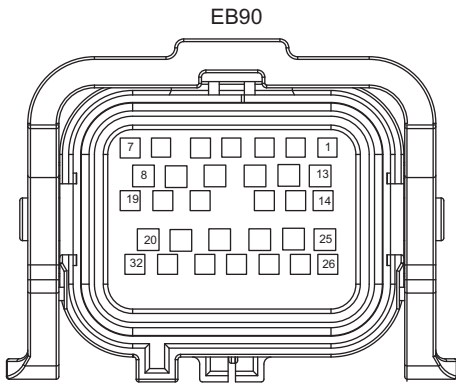
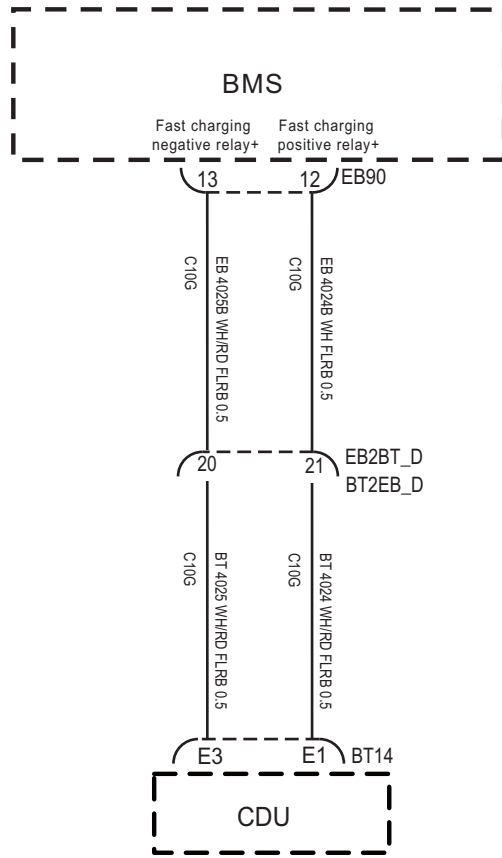

EK893019

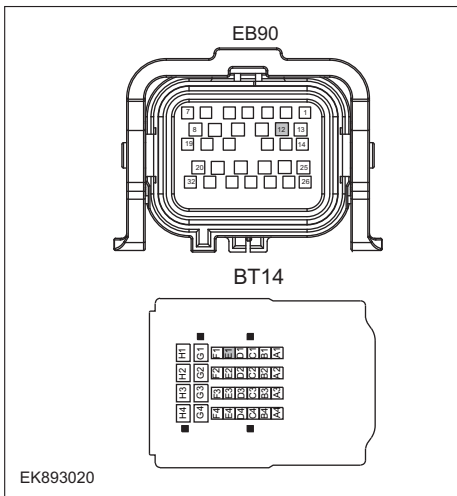
Troubleshooting steps	
Step 1	General inspection.
	<ol style="list-style-type: none"> 1 Check battery capacity. 2 Check the harness plug of BMS for damage, poor contact, aging and looseness. 3 Check the harness plug of battery pack high voltage for damage, poor contact, aging and looseness. 4 Check whether the result is normal or not?
	NO → Repair or replace the faulted parts.
YES ↓	
Step 2	Check fault codes.
	<ol style="list-style-type: none"> 1 Connect the fault diagnosis instrument to the diagnosis interface. 2 Turn the ignition switch to ON position. 3 Diagnose the BMS with diagnostic apparatus. 4 Is there any other fault code except for P1B23-00/P1B1F-F0/P1B1F-F1/P1B1F-F2/P1B20-00?
	YES → Refer to: DTC Summary list(BMS) .
NO ↓	
Step 3	Check the circuit between BMS and CDU. (Open circuit)
	<ol style="list-style-type: none"> 1 Turn the ignition switch to OFF. 2 Disconnect the harness plug EB90 of BMS. 3 Disconnect the harness plug BT14 of CDU. 4 Measure the resistance between the harness terminals of BMS and CDU. Measuring circuit: resistance between terminal 12 on plug EB90 and terminal E1 on plug BT14. Standard value: <math>< 1\Omega</math> 5 Check whether the result is normal or not?
	NO → Repair or replace the faulted parts.
YES ↓	

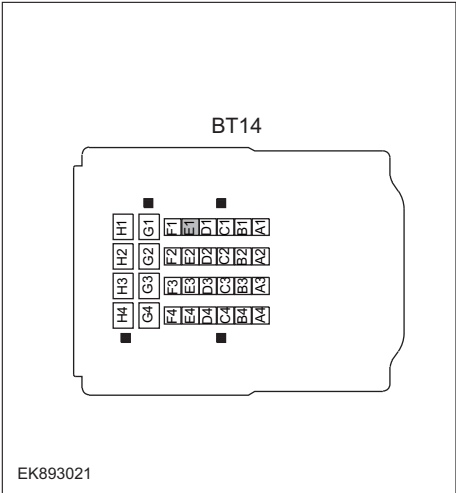
Step 4	Check CDU circuit. (Short circuit)
	<ol style="list-style-type: none"> 1 Turn the ignition switch to OFF. 2 Connect the harness plug EB90of BMS. 3 Measure the resistance between the harness terminal of CDU and ground. Measuring circuit: resistance between terminal E1 on plug BT14 and ground. Standard value: ∞ 4 Measure the voltage between the harness terminal of BCM and ground. Measuring circuit: voltage between terminal E1 on plug BT14 and ground. Standard value: ≈ 0V 5 Check whether the result is normal or not?
NO → Repair or replace the faulted parts.	
YES ↓	
Step 5	Check the connecting cable of BMS.
	<ol style="list-style-type: none"> 1 Turn the ignition switch to OFF. 2 Make protective preparations according to the safety operation specifications of the high voltage voltage in the maintenance manual. 3 Disconnect the harness plug battery pack high voltage. 4 Disconnect the high voltage harness plug of BMS. 5 Check whether the BMS connection cable is rotten, damaged, and water enters. 6 Check whether the result is normal or not?
NO → Repair or replace the faulted parts.	
YES ↓	
Step 6	Check the connecting cable of CDU.
	<ol style="list-style-type: none"> 1 Turn the ignition switch to OFF. 2 Make protective preparations according to the safety operation specifications of the high voltage voltage in the maintenance manual. 3 Disconnect the harness plug battery pack high voltage. 4 Disconnect the high voltage harness plug of CDU. 5 Check whether the CDU connection cable is rotten, damaged, and water enters. 6 Check whether the result is normal or not?
NO → Repair or replace the faulted parts.	

YES ↓	
Step 7	Check the DC charging positive relay circuit.
	<ol style="list-style-type: none"> 1 Turn the ignition switch to OFF. 2 Make protective preparations according to the safety operation specifications of the high voltage voltage in the maintenance manual. 3 Open the CDU end cover. 4 Check whether the main positive relay circuit exist the situation of open or short circuit. 5 Check whether the main positive relay circuit exist the situation of shorting to battery. 6 Check whether the result is normal or not?
	NO → Repair or replace the faulted parts.
YES ↓	
Step 8	Check DC charging positive relay signal checking module.
	<ol style="list-style-type: none"> 1 Turn the ignition switch to OFF. 2 Make protective preparations according to the safety operation specifications of the high voltage voltage in the maintenance manual. 3 Open the CDU end cover. 4 Check whether the DC positive relay signal checking module is damaged. 5 Check whether the result is normal or not?
	NO → Repair or replace the faulted parts.
YES ↓	
Step 9	Perform initialization.
	<ol style="list-style-type: none"> 1 Turn the ignition switch to OFF. 2 Connect the fault diagnosis instrument to the diagnosis interface. 3 Turn the ignition switch to ON. 4 The BMS module was initialized with the diagnostic instrument. 5 Can the BMS be initialized and is the BMS restored?
	NO → Repair or change the BMS module.
YES ↓	

BMS(CN)

Step 10	Test whether BMS is norm.
	<ol style="list-style-type: none">1 Turn the ignition switch to OFF.2 Disconnect and check the harness plug EB90of BMS.3 Check and repair.<ul style="list-style-type: none">• Corrosion(install new adapting piece or terminal-cleaning module and pin).• Pin damaged or bent-install new terminal/pin.• Fly out of pins-install new pins as needed.4 Reconnect the BMS plug and all other previously disconnected plug. Make sure the pin is properly positioned and fixed.5 Run the system and determine if the problem persists?
	YES → Replace the BMS.
NO ↓	
At this point the system is functioning normally. The problem may be caused by module connections. Address the root cause of any connector or pin problems.	
Next Step ↓	
Diagnosis end.	

P1B25-F0、 P1B25-F1、 P1B25-F2、 P1B24-00

Fault diagnosis code
P1B25-F0: DC charge negative contactor coil circuit short to GND fault
P1B25-F1: DC charge negative contactor coil circuit short to power fault
P1B25-F2: DC charge negative contactor coil circuit open fault
P1B24-00: DC charge negative contactor coil circuit over current fault
Detection tools
1 Multimeter and diagnostic apparatus
Possible causes
<ul style="list-style-type: none"> • BMS fault • DC charging negative relay fault • The DC charging relay circuit of CDU fault
Conditions for fault code operation
Turn the ignition switch to ON position.
Conditions for fault code setting
P1B25-F0
P1B25-F1
P1B25-F2
P1B24-00
To set the effect of a fault code condition
Description of circuit diagram

Circuit diagram

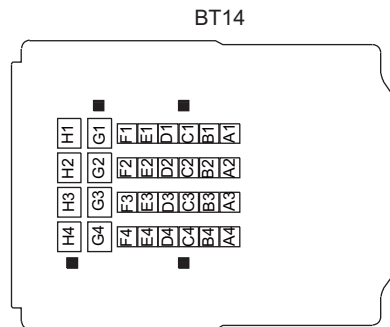
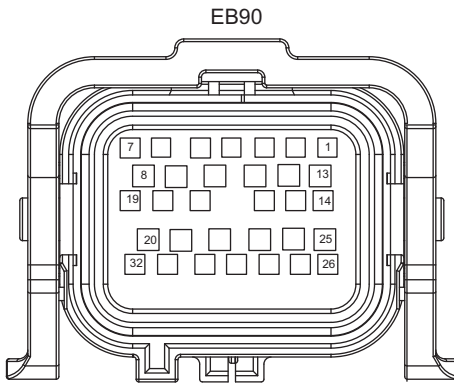
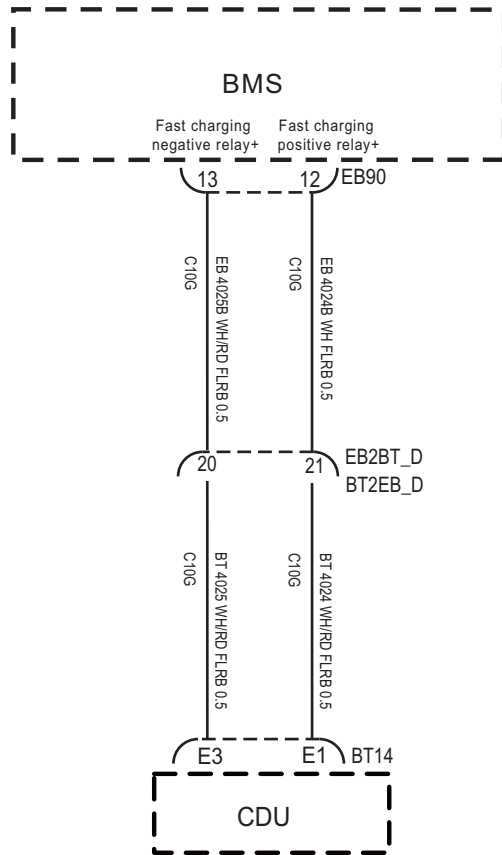

EK893022

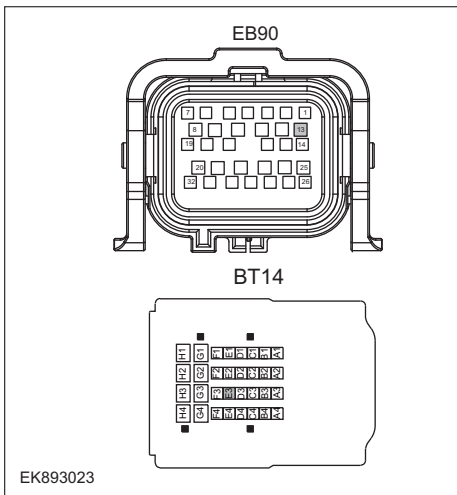
Troubleshooting steps	
Step 1	General inspection.
	<ol style="list-style-type: none"> 1 Check battery capacity. 2 Check the harness plug of BMS for damage, poor contact, aging and looseness. 3 Check the harness plug of battery pack high voltage for damage, poor contact, aging and looseness. 4 Check whether the result is normal or not?
	NO → Repair or replace the faulted parts.
YES ↓	
Step 2	Check fault codes.
	<ol style="list-style-type: none"> 1 Connect the fault diagnosis instrument to the diagnosis interface. 2 Turn the ignition switch to ON position. 3 Diagnose the BMS with diagnostic apparatus. 4 Is there any other fault code except for P1B25-F0、P1B25-F1、 P1B25-F2、 P1B24-00?
	YES → Refer to: DTC Summary list(BMS) .
NO ↓	
Step 3	Check the circuit between BMS and CDU. (Open circuit)
	<ol style="list-style-type: none"> 1 Turn the ignition switch to OFF. 2 Disconnect the harness plug EB90 of BMS. 3 Disconnect the harness plug BT14 of CDU. 4 Measure the resistance between the harness terminals of BMS and CDU. Measuring circuit: resistance between terminal 13 on plug EB90 and terminal E3 on plug BT14. Standard value: < 1Ω 5 Check whether the result is normal or not?
	NO → Repair or replace the faulted parts.
YES ↓	

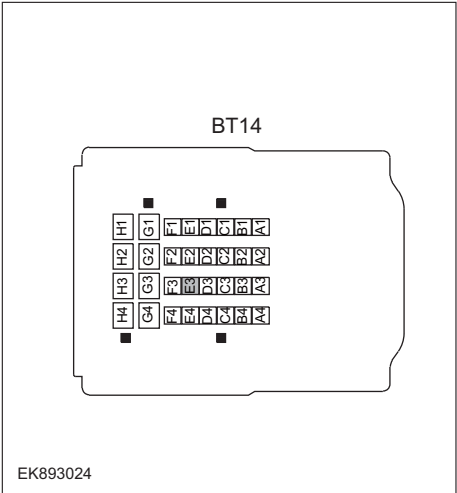
Step 4	Check CDU circuit. (Short circuit)
	<ol style="list-style-type: none"> 1 Turn the ignition switch to OFF. 2 Connect the harness plug EB90of BMS. 3 Measure the resistance between the harness terminal of CDU and ground. Measuring circuit: resistance between terminal E3 on plug BT14 and ground. Standard value: ∞ 4 Measure the voltage between the harness terminal of BCM and ground. Measuring circuit: voltage between terminal E3 on plug BT14 and ground. Standard value: $\approx 0V$ 5 Check whether the result is normal or not?
NO → Repair or replace the faulted parts.	
YES ↓	
Step 5	Check the connecting cable of BMS.
	<ol style="list-style-type: none"> 1 Turn the ignition switch to OFF. 2 Make protective preparations according to the safety operation specifications of the high voltage voltage in the maintenance manual. 3 Disconnect the harness plug battery pack high voltage. 4 Disconnect the high voltage harness plug of BMS. 5 Check whether the BMS connection cable is rotten, damaged, and water enters. 6 Check whether the result is normal or not?
NO → Repair or replace the faulted parts.	
YES ↓	
Step 6	Check the connecting cable of CDU.
	<ol style="list-style-type: none"> 1 Turn the ignition switch to OFF. 2 Make protective preparations according to the safety operation specifications of the high voltage voltage in the maintenance manual. 3 Disconnect the harness plug battery pack high voltage. 4 Disconnect the high voltage harness plug of CDU. 5 Check whether the CDU connection cable is rotten, damaged, and water enters. 6 Check whether the result is normal or not?
NO → Repair or replace the faulted parts.	

YES ↓	
Step 7	Check the DC charging relay circuit.
	<ol style="list-style-type: none"> 1 Turn the ignition switch to OFF. 2 Make protective preparations according to the safety operation specifications of the high voltage voltage in the maintenance manual. 3 Open the CDU end cover. 4 Check whether the main negative relay circuit exist the situation of open or short circuit. 5 Check whether the main negative relay circuit exist the situation of shorting to battery. 6 Check whether the result is normal or not?
	NO → Repair or replace the faulted parts.
YES ↓	
Step 8	Check DC charging relay signal checking module.
	<ol style="list-style-type: none"> 1 Turn the ignition switch to OFF. 2 Make protective preparations according to the safety operation specifications of the high voltage voltage in the maintenance manual. 3 Open the CDU end cover. 4 Check whether the DC neagtive relay signal checking module is damaged. 5 Check whether the result is normal or not?
	NO → Repair or replace the faulted parts.
YES ↓	
Step 9	Perform initialization.
	<ol style="list-style-type: none"> 1 Turn the ignition switch to OFF. 2 Connect the fault diagnosis instrument to the diagnosis interface. 3 Turn the ignition switch to ON. 4 The BMS module was initialized with the diagnostic instrument. 5 Can the BMS be initialized and is the BMS restored?
	NO → Repair or change the BMS module.
YES ↓	

BMS(CN)

Step 10	Test whether BMS is norm.
	<ol style="list-style-type: none"> 1 Turn the ignition switch to OFF. 2 Disconnect and check the harness plug EB90of BMS. 3 Check and repair. <ul style="list-style-type: none"> • Corrosion(install new adapting piece or terminal-cleaning module and pin). • Pin damaged or bent-install new terminal/pin. • Fly out of pins-install new pins as needed. 4 Reconnect the BMS plug and all other previously disconnected plug. Make sure the pin is properly positioned and fixed. 5 Run the system and determine if the problem persists?
	YES → Replace the BMS.
NO ↓	
At this point the system is functioning normally. The problem may be caused by module connections. Address the root cause of any connector or pin problems.	
Next Step ↓	
Diagnosis end.	

DTC Summary list(CDU)

Notes for high voltage maintenance:

On the premise of wearing and preparing protective equipment in strict accordance with the requirements of high-voltage maintenance operations, the following points should also be paid attention to:

- 1 The orange wire harness in the cabin is a high-voltage wire harness. Do not touch it without discharge treatment or wearing insulation tools.
- 2 In all maintenance operations involving vehicle electrical and high-voltage wiring harness areas, the high-voltage wiring harness plugs connected with power batteries should be disconnected, and the high-voltage wiring harness and electrical discharge operation.
- 3 Maintenance personnel shall place insulating objects (such as insulation sticks) beside them, and be equipped with safety supervision personnel to avoid inadvertent electric shock.
- 4 Turn off the ignition switch and do not perform other operations within 3 minutes of disconnecting the negative electrode of the battery.
- 5 After the power failure, keep the key of the vehicle and forbid others to operate it.
- 6 If the power battery has a maintenance switch, remove the maintenance switch first and then disconnect the power battery wiring harness.
- 7 For the power battery harness plug, disconnect the low-voltage control harness first and then the high-voltage connection harness (the red harness is positive and the black harness is negative).
- 8 Discharge the wiring harness connecting the positive and negative high voltage terminals of the battery box.
- 9 Discharge high voltage electrical appliances and wire harness terminals. Use a multimeter to measure the voltage at both ends and check that the voltage is zero before performing related operations.
- 10 The disassembled and disconnected connectors of high-voltage electrical appliances shall be sealed with black tape to prevent sundries from entering.
- 11 The wiring harness connectors should be kept dry. If cooling water and oil are accidentally spilled into the high-voltage wiring harness or electrical interior, they should be cleaned and dried with compressed air. And use Megohm meter to measure the insulation resistance of high-voltage electrical appliances or wiring harness to meet the standard before installation.
- 12 Before opening the cover of the engine room of the electric vehicle, the key should be turned to the OFF gear; It is strictly prohibited to touch the devices marked with high pressure danger warning signs in the cabin of the electric vehicle directly; Spraying water or washing is prohibited in the engine room of the vehicle; Do not open the front hatch cover in the rain to prevent electrical leakage.

DTC	English descriptions	Reference page
P0D27-00	AC input undervoltage	P0D27-00 , P0D28-00 , P0D2A-00
P0D28-00	AC input overvoltage	
P0D2A-00	AC input overcurrent	
P0D28-F0	OBCPFC overvoltage	P0D28-F0 , P0D27-F0
P0D27-F0	OBCPFC undervoltage	
P1F0A-F0	OBC output overvoltage	P1F0A-F0 , P0D21-F0 , P1F0C-00 , P1F10-00
P0D21-F0	OBC output undervoltage	
P1F0C-00	OBC output overcurrent	
P1F10-00	OBC output CT overcurrent hardware protection	

DTC	English descriptions	Reference page
P1F20-00	Inverter AC undervoltage	P1F20-00 、 P1F21-00 、 P1F22-00
P1F21-00	Inverter AC overvoltage	
P1F22-00	Inverter AC overcurrent	
P1F23-00	Inverter PFC overvoltage	P1F23-00 、 P1F24-00
P1F24-00	Inverter PFC undervoltage	
P1F25-00	Inverter HVDC overvoltage	P1F25-00 、 P1F26-00 、 P1F27-00
P1F26-00	Inverter HVDC undervoltage	
P1F27-00	Inverter HVDC overcurrent	
P0E57-00	DCDC input overvoltage	P0E57-00 、 P1AE3-16 、 P1AE5-00
P1AE3-16	DCDC input undervoltage	
P1AE5-00	DCDC input CT overcurrent hardware protection	
P1AD1-17	DCDC output overvoltage	P1AD1-17 、 P1AD0-16 、 P0D33-00 、 P1AD2-12
P1AD0-16	DCDC output undervoltage	
P0D33-00	DCDC output overcurrent	
P1AD2-12	DCDC output short circuit	
P0562-F0	Internal auxiliary source undervoltage	P0562-F0 、 P1F28-00 、 P0562-00 、 P0563-00
P1F28-00	Internal auxiliary source overvoltage	
P0562-00	KL30 overpressure	
P0563-00	KL30 undervoltage	
P1F01-00	PFC temperature 1 over temperature	P1F01-00
P1F02-00	PFC temperature 2 over temperature	P1F02-00
P1F1C-00	PFC temperature 3 over temperature	P1F1C-00
P1F03-00	LLC temperature 1 over temperature (bridge arm 1)	P1F03-00
P1F04-00	LLC temperature 2 over temperature (bridge arm 2)	P1F04-00
P1F12-00	LLC temperature 3 over temperature (HV_SEC secondary side MOS tube)	P1F12-00
P1F13-00	LLC temperature 4 over temperature (HV output PCB)	P1F13-00
P1AE0-00	DCDC temperature 1 over temperature (input MOS tube)	P1AE0-00
P1AE1-00	DCDC temperature 2 over temperature (synchronous rectifier)	P1AE1-00
P1F06-00	DCDC temperature 3 over temperature (water channel)	P1F06-00
P1F14-00	DCDC temperature 4 over temperature (LV output PCB)	P1F14-00
P1F15-00	CDU Bronze temperature over temperature	P1F15-00
P1F05-00	Chamber temperature overtemperature	P1F05-00
P1F07-00	Low temperature protection of internal ambient temperature	P1F07-00 、 P1F08-00 、 P1F06-F0 、 P0EA6-F0
P1F08-00	The internal environment slowly rises	
P1F06-F0	OBC temperature drop power	
P0EA6-F0	DCDC temperature drop power	

CDU

DTC	English descriptions	Reference page
P1F0D-00	EEPROM failure	P1F0D-00
P1F16-00	Power battery output high voltage interlock failure	P1F16-00
P1F17-00	PTC high voltage interlock failure	P1F17-00
P1F18-00	Air conditioner compressor high pressure interlock failure	P1F18-00
P1F19-00	AC input high voltage interlock failure	P1F19-00
P1F1A-00	DC input high voltage interlock failure	P1F1A-00 、 P1F1E-00
P1F1E-00	DC input high voltage negative interlock failure	
P1F1B-00	Motor input high voltage interlock failure	P1F1B-00
P1F1D-00	Open lid interlock failure	P1F1D-00
P1F09-00	SCI1 communication failure	P1F09-00 、 P1F11-00 、 U0111-87 、 U0294-87 、 U0073-88
P1F11-00	SCI2 communication failure	
U0111-87	Abnormal communication between OBC and BMS CAN (598 or 603 message lost)	
U0294-87	Communication between DCDC and VCU CAN is abnormal (282 packets are lost)	
U0073-88	BUS OFF	
P1F0E-00	The waterway is blocked from water	P1F0E-00

P0D27-00、 P0D28-00、 P0D2A-00

Fault diagnosis code
P0D27-00: AC input undervoltage
P0D28-00: AC input overvoltage
P0D2A-00: AC input overcurrent
Detection tools
1 Multimeter and diagnostic apparatus
Possible causes
<ul style="list-style-type: none"> • Circuit,terminal and adapting piece fault • AC battery fault • The AC charging module in the CDU is fault
Conditions for fault code operation
Turn the ignition switch to ON position.
Conditions for fault code setting
P0D27-00
Single phase: AC input voltage<85V and lasting for 100 milliseconds
Three phase: AC input line voltage < 288V and lasting for 100 milliseconds
P0D28-00
Single phase: AC input voltage>275V and lasting for 100 milliseconds
Three phase: AC input line voltage>476V and lasting for 100 milliseconds
P0D2A-00
Single phase: AC input current>35A and lasting for 500 milliseconds
Three phase: AC input current>48A and lasting for 500 milliseconds
To set the effect of a fault code condition
OBC stops power output
Description of circuit diagram

Circuit diagram

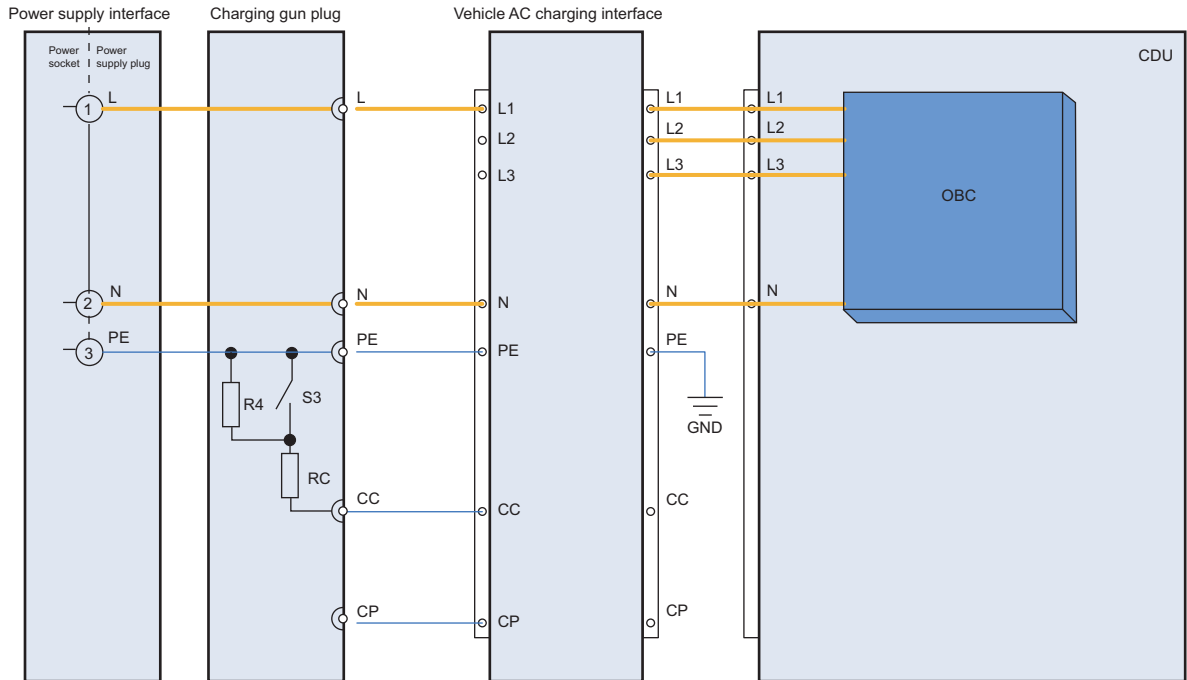

AC charging gun interface

AC charging gun plug

Vehicle AC charging interface

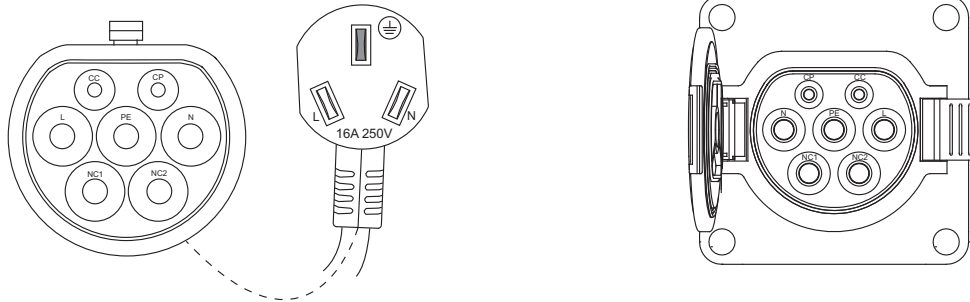

EK894010

Troubleshooting steps	
Step 1	General inspection.
	<ol style="list-style-type: none"> 1 Check the fuse for damage. 2 Check battery capacity. 3 Check the harness plug of CDU for damage, poor contact, aging and looseness. 4 Check whether the result is normal or not?
	NO → Repair or replace the faulted parts.
YES ↓	
Step 2	Check fault codes.
	<ol style="list-style-type: none"> 1 Connect the fault diagnosis instrument to the diagnosis interface. 2 Turn the ignition switch to ON position. 3 Diagnose the CDU module with diagnostic apparatus. 4 Is there any other fault code except for P0D27-00/P0D28-00/P0D2A-00?
	YES → Refer to: DTC Summary list(CDU) .
NO ↓	
Step 3	Check the AC power supply.
	<ol style="list-style-type: none"> 1 Make protective preparations according to the safety operation specifications of the high voltage voltage in the maintenance manual. 2 Measure the AC power voltage. Measure circuit: voltage between the L and N terminals of the AC power socket. Standard value: 198V~235.4V 3 Check whether the result is normal or not?
	NO → Replace the AC power in good condition.
YES ↓	

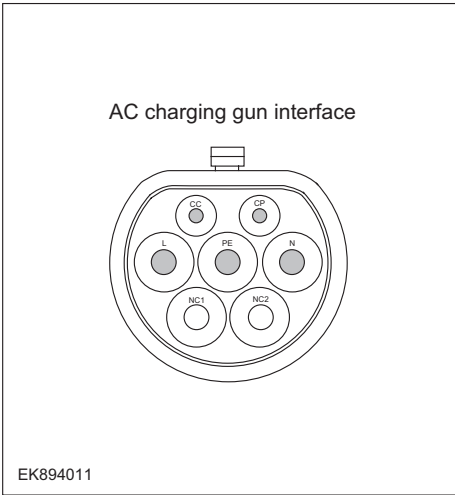
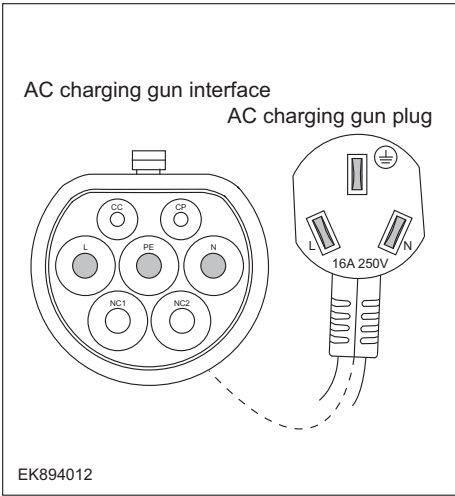
Step 4	Check the AC charging gun (functional check).
 <p>AC charging gun interface</p> <p>EK894011</p>	<p>1 Measure the resistance between the harness terminals of AC charging gun.</p> <p>Measure circuit: resistance between the L and PE terminals of the AC charging gun.</p> <p>Standard value: ∞</p> <p>Measure circuit: the resistance between the N and PE terminals of AC charging gun.</p> <p>Standard value: ∞</p> <p>Measure circuit: resistance between the CP and PE terminals of the AC charging gun.</p> <p>Standard value: ∞</p> <p>Measure circuit: resistance between the CC and PE terminals of the AC charging gun.</p> <p>Standard value(connect the confirmation switch): ∞</p> <p>Standard value(disconnect the confirmation switch): 680 Ω</p> <p>2 Check whether the result is normal or not?</p>
<p>NO → Repair or replace the faulted parts.</p>	
<p>YES ↓</p>	
Step 5	Check the AC charging gun (wiring harness conduction check).
 <p>AC charging gun interface</p> <p>AC charging gun plug</p> <p>EK894012</p>	<p>1 Measure the resistance between the harness terminals of AC charging gun and plug.</p> <p>Measure circuit: resistance between the PE terminal of the AC charging gun and grounding terminal of plug.</p> <p>Standard value: $\approx 0\Omega$</p> <p>Measure circuit: resistance between the L terminal of the AC charging gun interface and the L terminal of the plug.</p> <p>Standard value: $\approx 0\Omega$</p> <p>Measure circuit: the resistance between the N terminal of the AC charging gun interface and the N terminal of the plug.</p> <p>Standard value: $\approx 0\Omega$</p> <p>2 Check whether the result is normal or not?</p>
<p>NO → Repair or replace the faulted parts.</p>	
<p>YES ↓</p>	

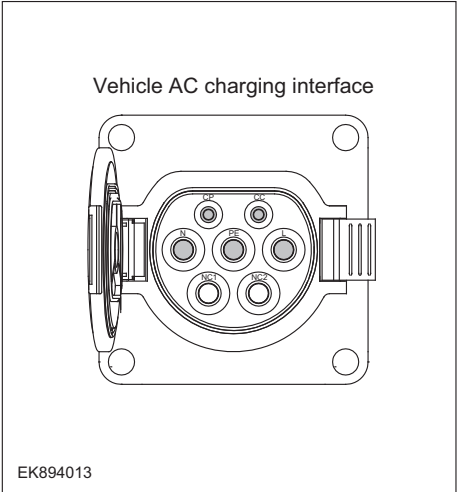
Step 6	Check the AC charging port of the vehicle (functional check).
<p style="text-align: center;">Vehicle AC charging interface</p>  <p style="text-align: left; margin-left: 10px;">EK894013</p>	<ol style="list-style-type: none"> 1 Turn the ignition switch to OFF. 2 Open the vehicle AC charging port cover. 3 Measure the resistance between the harness terminals of AC charging port interface. Measure circuit: resistance between the L and PE terminals of the AC charging port. Standard value: ∞ Measure circuit: the resistance between the N and PE terminals of AC charging port. Standard value: ∞ Measure circuit: resistance between the CP and PE terminals of the AC charging port. Standard value: ∞ Measure circuit: resistance between the CC and PE terminals of the AC charging port. Standard value(connect the confirmation switch): ∞ Standard value(disconnect the confirmation switch): 680 Ω 4 Check whether the result is normal or not?
NO → Repair or replace the faulted parts.	
YES ↓	
Step 7	Check the high-voltage cable connecting the AC charging port of the vehicle to the CDU (wiring harness conduction check).
	<ol style="list-style-type: none"> 1 Turn the ignition switch to OFF. 2 Disconnect AC charging high-voltage cable of CDU. 3 Measure the resistance between the harness terminals of AC charging port interface and plug. Measure circuit: the resistance between the L1, L2, L3, N of AC charging port and CDU. Standard value: ≈ 0Ω 4 Check whether the result is normal or not?
NO → Repair or replace the faulted parts.	
YES ↓	

CDU

Step 8	Test whether CDU is norm.
	<ol style="list-style-type: none"> 1 Turn the ignition switch to OFF. 2 Disconnect and check the harness plug BT14、 BT15 of CDU. 3 Check and repair. <ul style="list-style-type: none"> • Corrosion(install new adapting piece or terminal-cleaning module and pin). • Pin damaged or bent-install new terminal/pin. 4 Fly out of pins-install new pins as needed. 5 Reconnect the CDU plug and all other previously disconnected plug. Make sure the pin is properly positioned and fixed. 6 Run the system and determine if the problem persists?
	YES → Change the CDU Module.
NO ↓	
At this point the system is functioning normally. The problem may be caused by module connections. Address the root cause of any connector or pin problems.	
Next Step ↓	
Diagnosis end.	

P0D28-F0、 P0D27-F0

Fault diagnosis code
P0D28-F0: OBCPFC overvoltage
P0D27-F0: OBCPFC undervoltage
Detection tools
1 Multimeter and diagnostic apparatus
Possible causes
<ul style="list-style-type: none"> • Circuit,terminal and adapting piece fault • OBC battery fault • OBC and PFC of CDU fault
Conditions for fault code operation
Turn the ignition switch to ON position.
Conditions for fault code setting
P0D28-F0
PFC voltage>860V for 100 milliseconds
P0D27-F0
Single phase: PFC voltage<400V and lasting for 120 milliseconds
Three phase: PFC voltage AC voltage * 2.4495+10.0 (not less than 580) and lasting for 120 milliseconds
To set the effect of a fault code condition
OBC stops power output
Description of circuit diagram

Circuit diagram

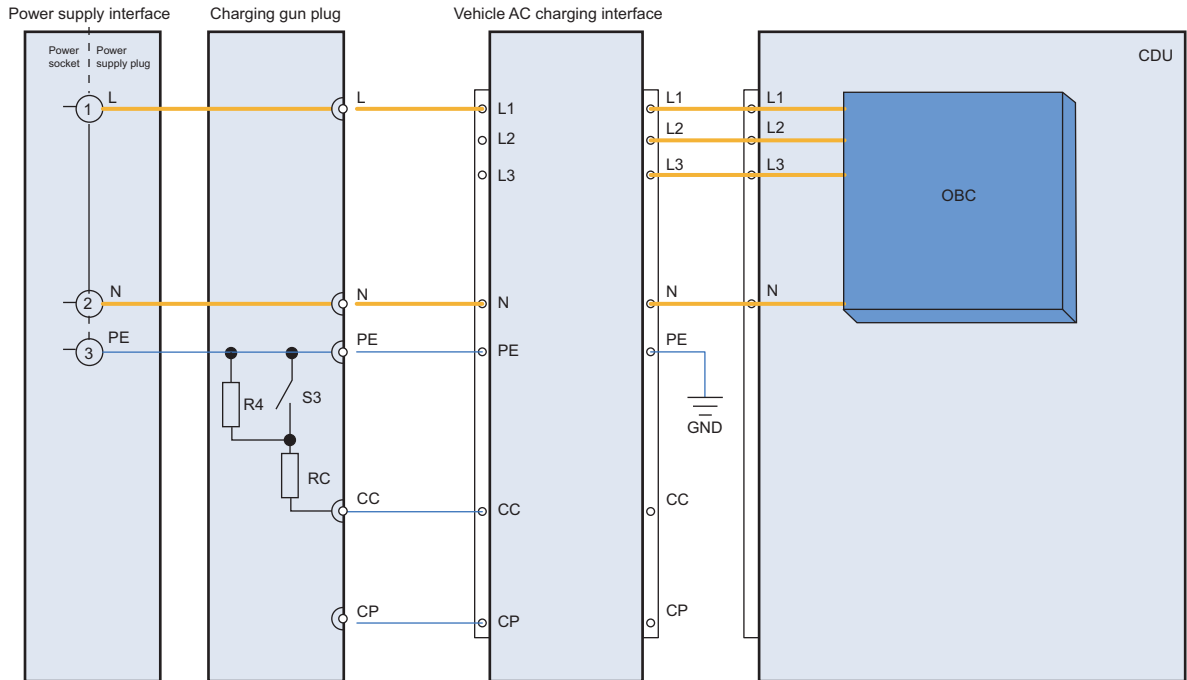

AC charging gun interface

AC charging gun plug

Vehicle AC charging interface

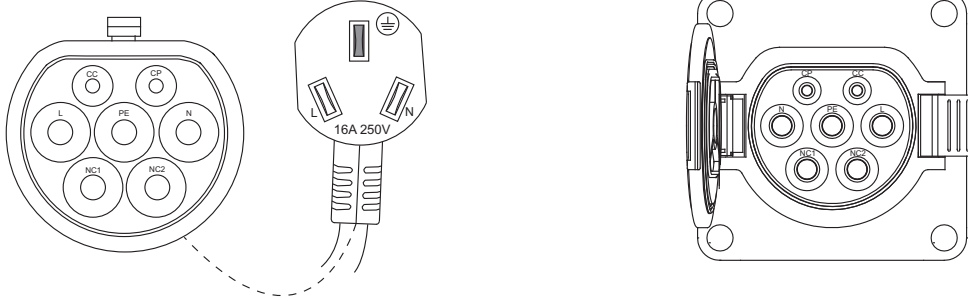

EK894010

Troubleshooting steps	
Step 1	General inspection.
	<ol style="list-style-type: none"> 1 Check the fuse for damage. 2 Check battery capacity. 3 Check the harness plug of CDU for damage, poor contact, aging and looseness. 4 Check whether the result is normal or not?
	NO → Repair or replace the faulted parts.
YES ↓	
Step 2	Check fault codes.
	<ol style="list-style-type: none"> 1 Connect the fault diagnosis instrument to the diagnosis interface. 2 Turn the ignition switch to ON position. 3 Diagnose the CDU module with diagnostic apparatus. 4 If there is any fault code except for P0D28-F0/P0D27-F0?
	YES → Refer to: DTC Summary list(CDU) .
NO ↓	
Step 3	Check the AC power supply.
	<ol style="list-style-type: none"> 1 Make protective preparations according to the safety operation specifications of the high voltage voltage in the maintenance manual. 2 Check the input voltage of AC power supply. 3 Check whether the result is normal or not?
	NO → Replace the AC power in good condition.
YES ↓	
Step 4	Check the AC charging gun.
	<ol style="list-style-type: none"> 1 Check whether the AC charging status is intact and the function is normal. 2 Check whether the result is normal or not?
	NO → Repair or replace the faulted parts.
YES ↓	
Step 5	Check the cable connecting the charging port to the OBC.
	<ol style="list-style-type: none"> 1 Turn the ignition switch to OFF. 2 Disconnect the high voltage wiring harness connector of the vehicle. 3 Check whether the charging port to the OBC connection cable is rotten, damaged, and water enters. 4 Check whether the result is normal or not?

CDU

		NO → Repair or replace the faulted parts.
YES ↓		
Step 6	Check OBC.	
		<ol style="list-style-type: none"> 1 Turn the ignition switch to OFF. 2 Make protective preparations according to the safety operation specifications of the high voltage voltage in the maintenance manual. 3 Open the OBC end cover. 4 Check whether the internal circuit of OBC is damaged. 5 Check whether the result is normal or not?
		NO → Repair or replace the faulted parts.
YES ↓		
Step 7	Test whether CDU is norm.	
		<ol style="list-style-type: none"> 1 Turn the ignition switch to OFF. 2 Disconnect and check the harness plug BT14、 BT15 of CDU. 3 Check and repair. <ul style="list-style-type: none"> • Corrosion(install new adapting piece or terminal-cleaning module and pin). • Pin damaged or bent-install new terminal/pin. 4 Fly out of pins-install new pins as needed. 5 Reconnect the CDU plug and all other previously disconnected plug. Make sure the pin is properly positioned and fixed. 6 Run the system and determine if the problem persists?
		YES → Change the CDU Module
NO ↓		
At this point the system is functioning normally. The problem may be caused by module connections. Address the root cause of any connector or pin problems.		
Next Step ↓		
Diagnosis end.		

P1F0A-F0、 P0D21-F0、 P1F0C-00、 P1F10-00

Fault diagnosis code
P1F0A-F0: OBC input overvoltage
P0D21-F0: OBC input undervoltage
P1F0C-00: OBC input overcurrent
P1F10-00: OBC output CT overcurrent hardware protection
Detection tools
1 Multimeter and diagnostic apparatus
Possible causes
<ul style="list-style-type: none"> • Circuit,terminal and adapting piece fault • OBC battery fault • The AC charging module in the CDU is fault
Conditions for fault code operation
Turn the ignition switch to ON position.
Conditions for fault code setting
P1F0A-F0
voltage>450V and lasting for 200ms
P0D21-F0
voltage>450V and lasting for 200ms
P1F0C-00
OBC output current greater than 33A and lasting for 10ms
P1F10-00
CT current greater than 60A
To set the effect of a fault code condition
OBC stops power output
Description of circuit diagram

Circuit diagram

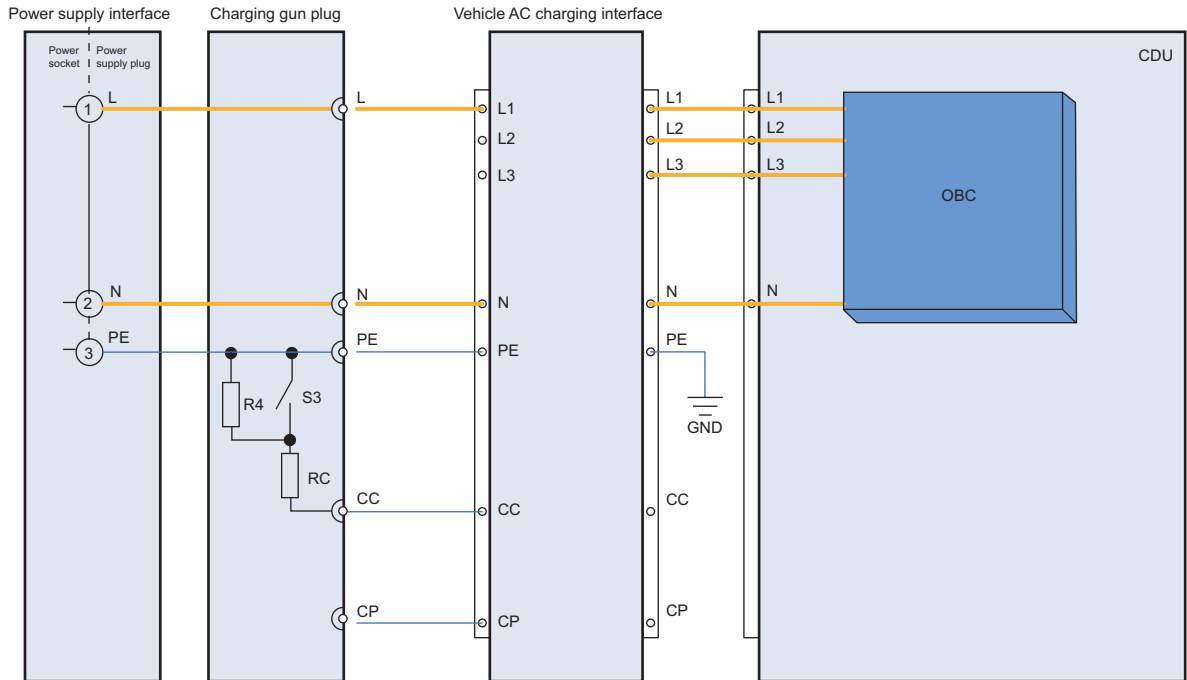

AC charging gun interface

AC charging gun plug

Vehicle AC charging interface

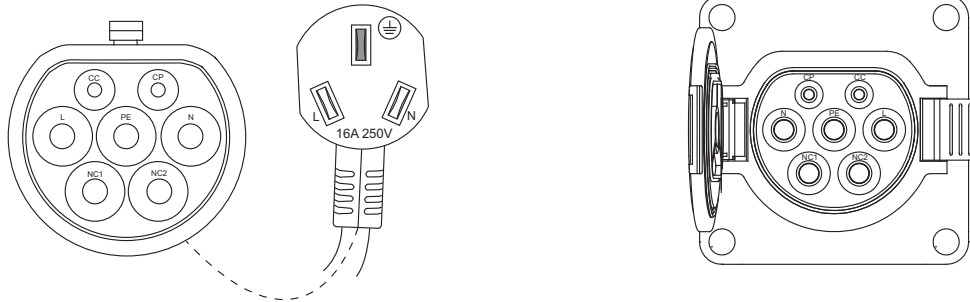

EK894010

Troubleshooting steps	
Step 1	General inspection.
	<ol style="list-style-type: none"> 1 Check the fuse for damage. 2 Check battery capacity. 3 Check the harness plug of CDU for damage, poor contact, aging and looseness. 4 Check whether the result is normal or not?
	NO → Repair or replace the faulted parts.
YES ↓	
Step 2	Check fault codes.
	<ol style="list-style-type: none"> 1 Connect the fault diagnosis instrument to the diagnosis interface. 2 Turn the ignition switch to ON position. 3 Diagnose the CDU module with diagnostic apparatus. 4 Is there any other fault code except for P1F0A-F0、P0D21-F0、P1F0C-00、P1F10-00?
	YES → Refer to: DTC Summary list(CDU) .
NO ↓	
Step 3	Check the AC power supply.
	<ol style="list-style-type: none"> 1 Make protective preparations according to the safety operation specifications of the high voltage voltage in the maintenance manual. 2 Check the input voltage of AC power supply. 3 Check whether the result is normal or not?
	NO → Replace the AC power in good condition.
YES ↓	
Step 4	Check the AC charging gun.
	<ol style="list-style-type: none"> 1 Check whether the AC charging status is intact and the function is normal. 2 Check whether the result is normal or not?
	NO → Repair or replace the faulted parts.
YES ↓	

Step 5	Check the cable connecting the charging port to the OBC.	
		<ol style="list-style-type: none"> 1 Turn the ignition switch to OFF. 2 Disconnect the high voltage wiring harness connector of the vehicle. 3 Check whether the charging port to the OBC connection cable is rotten, damaged, and water enters. 4 Check whether the result is normal or not?
		NO → Repair or replace the faulted parts.
YES ↓		
Step 6	Check OBC output circuit.	
		<ol style="list-style-type: none"> 1 Turn the ignition switch to OFF. 2 Make protective preparations according to the safety operation specifications of the high voltage voltage in the maintenance manual. 3 Disconnect the OBC output end part cable harness connector. 4 Check OBC output circuit. 5 Check whether the result is normal or not?
		NO → Repair or replace the faulted parts.
YES ↓		
Step 7	Check OBC.	
		<ol style="list-style-type: none"> 1 Turn the ignition switch to OFF. 2 Make protective preparations according to the safety operation specifications of the high voltage voltage in the maintenance manual. 3 Open the OBC end cover. 4 Check whether the internal circuit of OBC is damaged. 5 Check whether the result is normal or not?
		NO → Repair or replace the faulted parts.
YES ↓		

Step 8	Test whether CDU is norm.
	<ol style="list-style-type: none"> 1 Turn the ignition switch to OFF. 2 Disconnect and check the harness plug BT14、 BT15 of CDU. 3 Check and repair. <ul style="list-style-type: none"> • Corrosion(install new adapting piece or terminal-cleaning module and pin). • Pin damaged or bent-install new terminal/pin. 4 Fly out of pins-install new pins as needed. 5 Reconnect the CDU plug and all other previously disconnected plug. Make sure the pin is properly positioned and fixed. 6 Run the system and determine if the problem persists?
	YES → Change the CDU Module
NO ↓	
At this point the system is functioning normally. The problem may be caused by module connections. Address the root cause of any connector or pin problems.	
Next Step ↓	
Diagnosis end.	

P1F20-00、 P1F21-00、 P1F22-00

Fault diagnosis code
P1F20-00: Inverter AC undervoltage
P1F21-00: Inverter AC overvoltage
P1F22-00: Inverter AC overcurrent
Detection tools
1 Multimeter and diagnostic apparatus
Possible causes
<ul style="list-style-type: none"> • Circuit,terminal and adapting piece fault • OBC battery fault • The inverter AC module in the CDU is faulty
Conditions for fault code operation
Turn the ignition switch to ON position.
Conditions for fault code setting
P1F20-00
Inverter AC voltage is less than 170V and lasts for 100ms
P1F21-00
Inverter AC voltage greater than 264V and lasting for 100ms
P1F22-00
Inverter AC current greater than 36A and lasting for 500ms
To set the effect of a fault code condition
Inverter stop power output
Description of circuit diagram

Circuit diagram

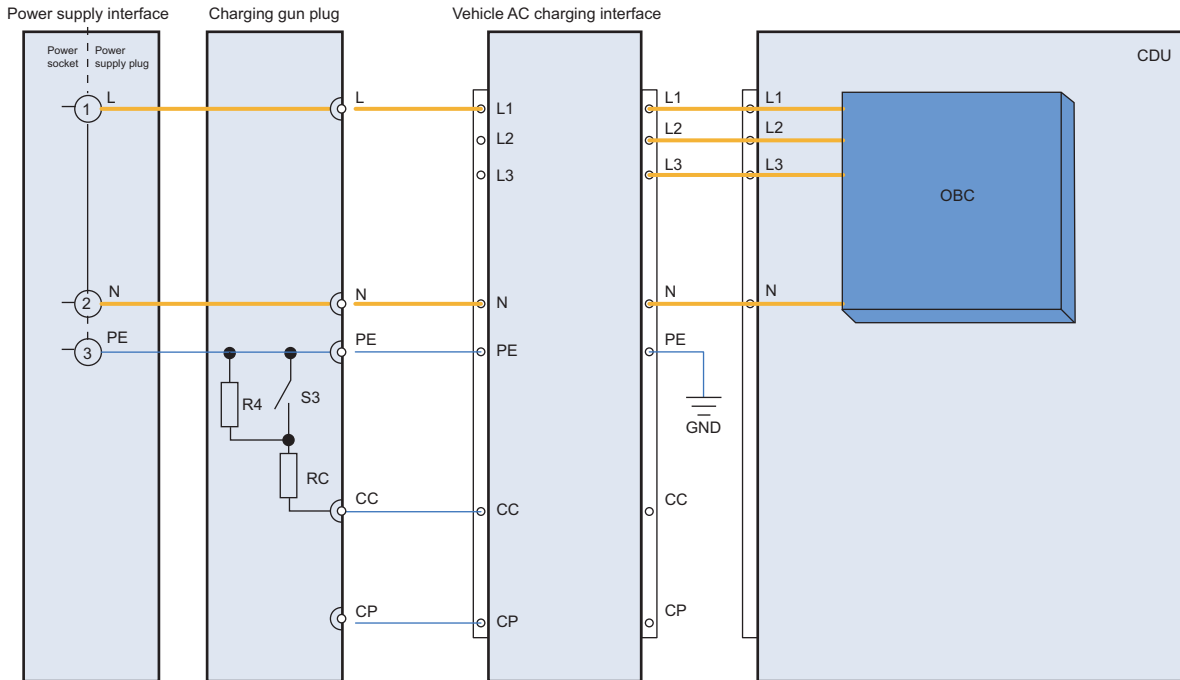

AC charging gun interface

AC charging gun plug

Vehicle AC charging interface

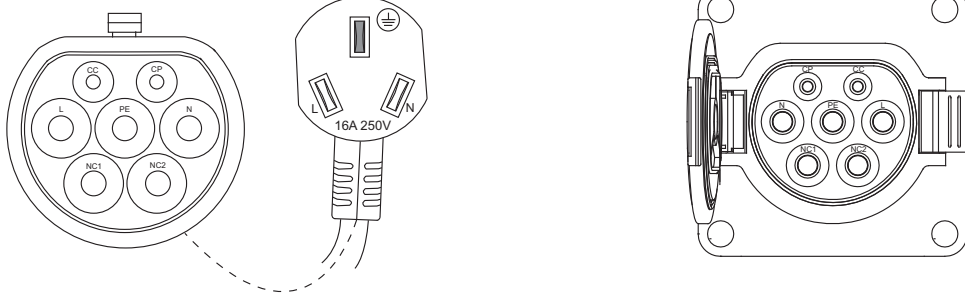

EK894010

Troubleshooting steps	
Step 1	General inspection.
	<ol style="list-style-type: none"> 1 Check the fuse for damage. 2 Check battery capacity. 3 Check the harness plug of CDU for damage, poor contact, aging and looseness. 4 Check whether the result is normal or not?
	NO → Repair or replace the faulted parts.
YES ↓	
Step 2	Check fault codes.
	<ol style="list-style-type: none"> 1 Connect the fault diagnosis instrument to the diagnosis interface. 2 Turn the ignition switch to ON position. 3 Diagnose the CDU module with diagnostic apparatus. 4 Is there any other fault code except for P1F20-00/P1F21-00/P1F22-00?
	YES → Refer to: DTC Summary list(CDU) .
NO ↓	
Step 3	Check the AC power supply.
	<ol style="list-style-type: none"> 1 Make protective preparations according to the safety operation specifications of the high voltage voltage in the maintenance manual. 2 Check the input voltage of AC power supply. 3 Check whether the result is normal or not?
	NO → Replace the AC power in good condition.
YES ↓	
Step 4	Check the AC charging gun.
	<ol style="list-style-type: none"> 1 Check whether the AC charging status is intact and the function is normal. 2 Check whether the result is normal or not?
	NO → Repair or replace the faulted parts.
YES ↓	

Step 5	Check the cable connecting the charging port to the OBC.	
		<ol style="list-style-type: none"> 1 Turn the ignition switch to OFF. 2 Disconnect the high voltage wiring harness connector of the vehicle. 3 Check whether the charging port to the OBC connection cable is rotten, damaged, and water enters. 4 Check whether the result is normal or not?
		NO → Repair or replace the faulted parts.
YES ↓		
Step 6	Check inverter AC circuit.	
		<ol style="list-style-type: none"> 1 Turn the ignition switch to OFF. 2 Make protective preparations according to the safety operation specifications of the high voltage voltage in the maintenance manual. 3 Open the CDU end cover. 4 Check inverter AC circuit. 5 Check whether the result is normal or not?
		NO → Repair or replace the faulted parts.
YES ↓		
Step 7	Check OBC.	
		<ol style="list-style-type: none"> 1 Turn the ignition switch to OFF. 2 Make protective preparations according to the safety operation specifications of the high voltage voltage in the maintenance manual. 3 Open the OBC end cover. 4 Check whether the internal circuit of OBC is damaged. 5 Check whether the result is normal or not?
		NO → Repair or replace the faulted parts.
YES ↓		

CDU

Step 8	Test whether CDU is norm.
	<ol style="list-style-type: none">1 Turn the ignition switch to OFF.2 Disconnect and check the harness plug BT14、 BT15 of CDU.3 Check and repair.<ul style="list-style-type: none">• Corrosion(install new adapting piece or terminal-cleaning module and pin).• Pin damaged or bent-install new terminal/pin.4 Fly out of pins-install new pins as needed.5 Reconnect the CDU plug and all other previously disconnected plug. Make sure the pin is properly positioned and fixed.6 Run the system and determine if the problem persists?
	YES → Change the CDU Module
NO ↓	
At this point the system is functioning normally. The problem may be caused by module connections. Address the root cause of any connector or pin problems.	
Next Step ↓	
Diagnosis end.	

P1F23-00、 P1F24-00

Fault diagnosis code
P1F23-00: Inverter PFC overvoltage
P1F24-00: Inverter PFC undervoltage
Detection tools
1 Multimeter and diagnostic apparatus
Possible causes
<ul style="list-style-type: none"> • Circuit,terminal and adapting piece fault • OBC battery fault • The inverter PFC module in the CDU is faulty
Conditions for fault code operation
Turn the ignition switch to ON position.
Conditions for fault code setting
P1F23-00
Inverter PFC voltage greater than 820V and lasting for 100ms
P1F24-00
Inverter PFC voltage is less than 350V and lasts for 120ms
To set the effect of a fault code condition
Inverter stop power output
Description of circuit diagram

Circuit diagram

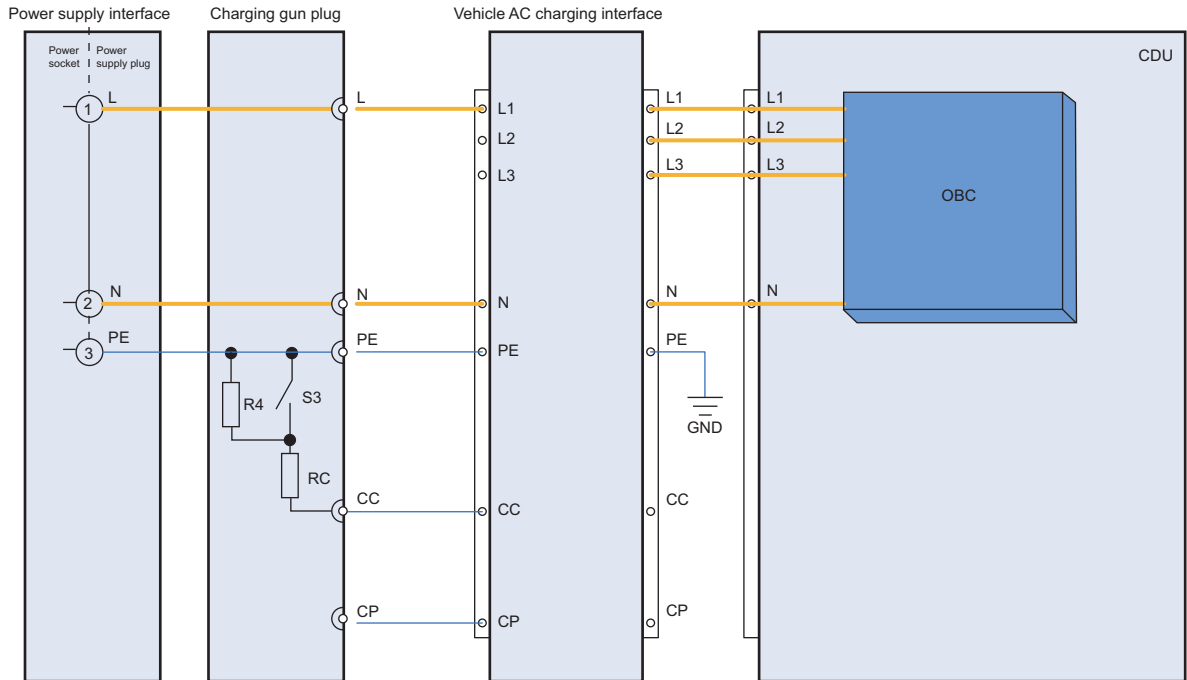

AC charging gun interface

AC charging gun plug

Vehicle AC charging interface

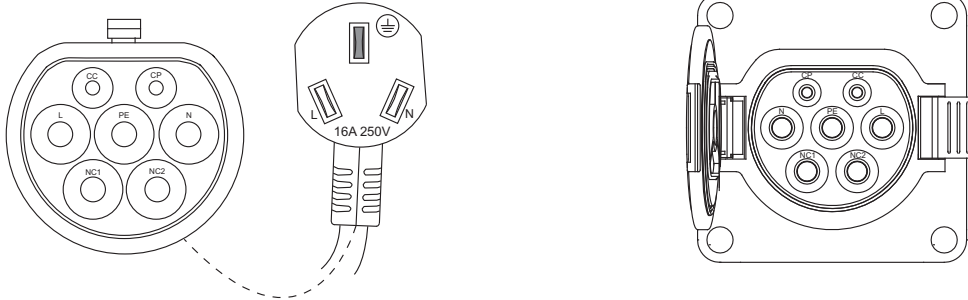

EK894010

Troubleshooting steps	
Step 1	General inspection.
	<ol style="list-style-type: none"> 1 Check the fuse for damage. 2 Check battery capacity. 3 Check the harness plug of CDU for damage, poor contact, aging and looseness. 4 Check whether the result is normal or not?
	NO → Repair or replace the faulted parts.
YES ↓	
Step 2	Check fault codes.
	<ol style="list-style-type: none"> 1 Connect the fault diagnosis instrument to the diagnosis interface. 2 Turn the ignition switch to ON position. 3 Diagnose the CDU module with diagnostic apparatus. 4 If there is any fault code except for P1F23-00,P1F24-00?
	YES → Refer to: DTC Summary list(CDU) .
NO ↓	
Step 3	Check the AC power supply.
	<ol style="list-style-type: none"> 1 Make protective preparations according to the safety operation specifications of the high voltage voltage in the maintenance manual. 2 Check the input voltage of AC power supply. 3 Check whether the result is normal or not?
	NO → Replace the AC power in good condition.
YES ↓	
Step 4	Check the AC charging gun.
	<ol style="list-style-type: none"> 1 Check whether the AC charging status is intact and the function is normal. 2 Check whether the result is normal or not?
	NO → Repair or replace the faulted parts.
YES ↓	
Step 5	Check the cable connecting the cahrging port to the OBC.
	<ol style="list-style-type: none"> 1 Turn the ignition switch to OFF. 2 Disconnect the high voltage wiring harness connector of the vehicle. 3 Check whether the charging port to the OBC connection cable is rotten, damaged, and water enters. 4 Check whether the result is normal or not?

CDU

		NO → Repair or replace the faulted parts.
YES ↓		
Step 6	Check OBC.	
		<ol style="list-style-type: none"> 1 Turn the ignition switch to OFF. 2 Make protective preparations according to the safety operation specifications of the high voltage voltage in the maintenance manual. 3 Open the OBC end cover. 4 Check whether the internal circuit of OBC is damaged. 5 Check whether the result is normal or not?
		NO → Repair or replace the faulted parts.
YES ↓		
Step 7	Test whether CDU is norm.	
		<ol style="list-style-type: none"> 1 Turn the ignition switch to OFF. 2 Disconnect and check the harness plug BT14、 BT15 of CDU. 3 Check and repair. <ul style="list-style-type: none"> • Corrosion(install new adapting piece or terminal-cleaning module and pin). • Pin damaged or bent-install new terminal/pin. 4 Fly out of pins-install new pins as needed. 5 Reconnect the CDU plug and all other previously disconnected plug. Make sure the pin is properly positioned and fixed. 6 Run the system and determine if the problem persists?
		YES → Change the CDU Module
NO ↓		
At this point the system is functioning normally. The problem may be caused by module connections. Address the root cause of any connector or pin problems.		
Next Step ↓		
Diagnosis end.		

P1F25-00、 P1F26-00、 P1F27-00

Fault diagnosis code
P1F25-00: Inverter HVDC overvoltage
P1F26-00: Inverter HVDC undervoltage
P1F27-00: Inverter HVDC overcurrent
Detection tools
1 Multimeter and diagnostic apparatus
Possible causes
<ul style="list-style-type: none"> • Circuit,terminal and adapting piece fault • OBC battery fault • The inverter HVDC module in the CDU is faulty
Conditions for fault code operation
Turn the ignition switch to ON position.
Conditions for fault code setting
P1F25-00
Inverter high-voltage DC voltage greater than 510V and lasting for 200ms
P1F26-00
Inverted high-voltage DC voltage less than 100V and lasting for 1000ms
P1F27-00
Inverter high-voltage DC current greater than 8KW/high-voltage DC voltage for 100ms
To set the effect of a fault code condition
Inverter stop power output
Description of circuit diagram

Circuit diagram

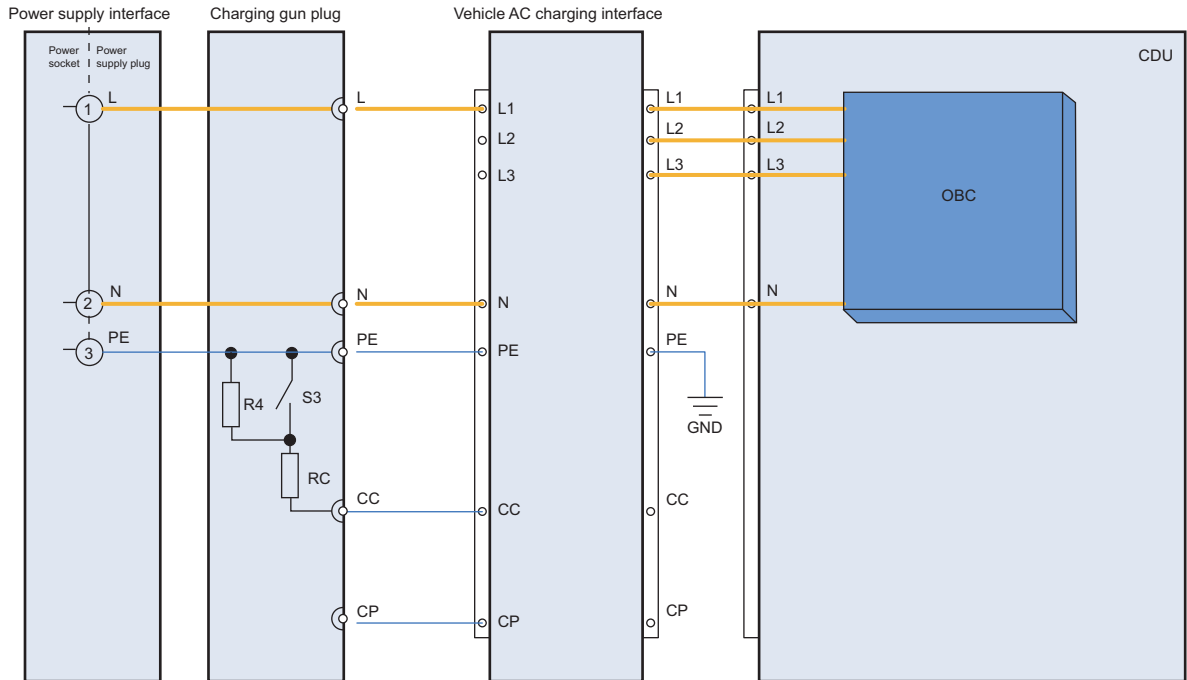

AC charging gun interface

AC charging gun plug

Vehicle AC charging interface

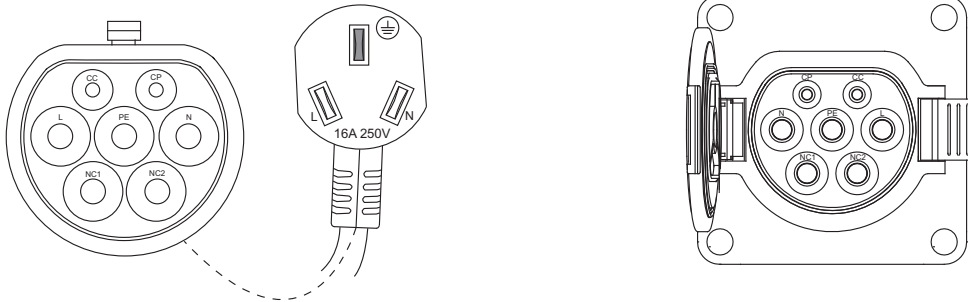

EK894010

Troubleshooting steps	
Step 1	General inspection.
	<ol style="list-style-type: none"> 1 Check the fuse for damage. 2 Check battery capacity. 3 Check the harness plug of CDU for damage, poor contact, aging and looseness. 4 Check whether the result is normal or not?
	NO → Repair or replace the faulted parts.
YES ↓	
Step 2	Check fault codes.
	<ol style="list-style-type: none"> 1 Connect the fault diagnosis instrument to the diagnosis interface. 2 Turn the ignition switch to ON position. 3 Diagnose the CDU module with diagnostic apparatus. 4 Is there any other fault code except for P1F25-00/P1F26-00/P1F27-00?
	YES → Refer to: DTC Summary list(CDU) .
NO ↓	
Step 3	Check the AC power supply.
	<ol style="list-style-type: none"> 1 Make protective preparations according to the safety operation specifications of the high voltage voltage in the maintenance manual. 2 Check the input voltage of AC power supply. 3 Check whether the result is normal or not?
	NO → Replace the AC power in good condition.
YES ↓	
Step 4	Check the AC charging gun.
	<ol style="list-style-type: none"> 1 Check whether the AC charging status is intact and the function is normal. 2 Check whether the result is normal or not?
	NO → Repair or replace the faulted parts.
YES ↓	

CDU

Step 5	Check the cable connecting the charging port to the OBC.	
		<ol style="list-style-type: none"> 1 Turn the ignition switch to OFF. 2 Disconnect the high voltage wiring harness connector of the vehicle. 3 Check whether the charging port to the OBC connection cable is rotten, damaged, and water enters. 4 Check whether the result is normal or not?
		NO → Repair or replace the faulted parts.
YES ↓		
Step 6	Check the inverter HVDC circuit.	
		<ol style="list-style-type: none"> 1 Turn the ignition switch to OFF. 2 Make protective preparations according to the safety operation specifications of the high voltage voltage in the maintenance manual. 3 Open the CDU end cover. 4 Check the inverter HVDC circuit. 5 Check whether the result is normal or not?
		NO → Repair or replace the faulted parts.
YES ↓		
Step 7	Check OBC.	
		<ol style="list-style-type: none"> 1 Turn the ignition switch to OFF. 2 Make protective preparations according to the safety operation specifications of the high voltage voltage in the maintenance manual. 3 Open the OBC end cover. 4 Check whether the internal circuit of OBC is damaged. 5 Check whether the result is normal or not?
		NO → Repair or replace the faulted parts.
YES ↓		

Step 8	Test whether CDU is norm.
	<ol style="list-style-type: none"> 1 Turn the ignition switch to OFF. 2 Disconnect and check the harness plug BT14、 BT15 of CDU. 3 Check and repair. <ul style="list-style-type: none"> • Corrosion(install new adapting piece or terminal-cleaning module and pin). • Pin damaged or bent-install new terminal/pin. 4 Fly out of pins-install new pins as needed. 5 Reconnect the CDU plug and all other previously disconnected plug. Make sure the pin is properly positioned and fixed. 6 Run the system and determine if the problem persists?
	YES → Change the CDU Module
NO ↓	
At this point the system is functioning normally. The problem may be caused by module connections. Address the root cause of any connector or pin problems.	
Next Step ↓	
Diagnosis end.	

CDU

P0E57-00、 P1AE3-16、 P1AE5-00

Fault diagnosis code
P0E57-00: DCDC input overvoltage
P1AE3-16: DCDC input undervoltage
P1AE5-00: DCDC input CT overcurrent hardware protection
Detection tools
1 Multimeter and diagnostic apparatus
Possible causes
<ul style="list-style-type: none">• Circuit,terminal and adapting piece fault• OBC battery fault• The DCDC module of CDU fault
Conditions for fault code operation
Turn the ignition switch to ON position.
Conditions for fault code setting
P0E57-00
Voltage>450V for 200ms
P1AE3-16
Voltage<210V and lasting for 1000ms
P1AE5-00
CT current greater than 25A
To set the effect of a fault code condition
DCDC stops power output
Description of circuit diagram

Circuit diagram

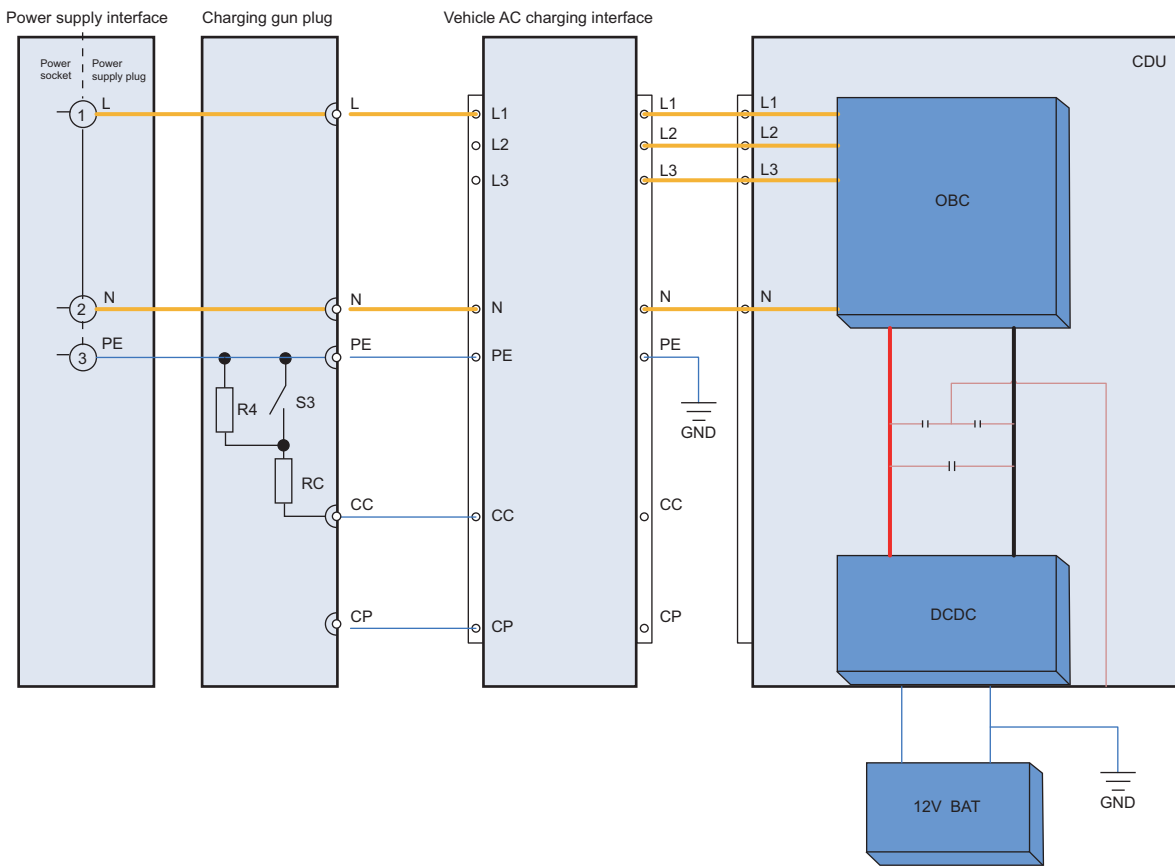

AC charging gun interface AC charging gun plug

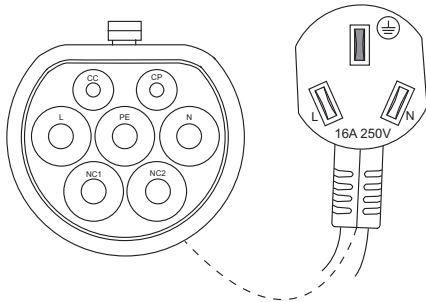

Vehicle AC charging interface

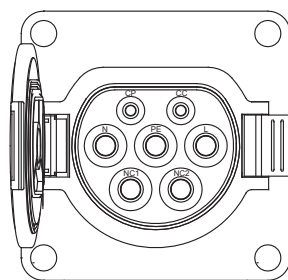

EK894015

Troubleshooting steps	
Step 1	General inspection.
	<ol style="list-style-type: none"> 1 Check the fuse for damage. 2 Check battery capacity. 3 Check the harness plug of CDU for damage, poor contact, aging and looseness. 4 Check whether the result is normal or not?
	NO → Repair or replace the faulted parts.
YES ↓	
Step 2	Check fault codes.
	<ol style="list-style-type: none"> 1 Connect the fault diagnosis instrument to the diagnosis interface. 2 Turn the ignition switch to ON position. 3 Diagnose the CDU module with diagnostic apparatus. 4 Is there any other fault code except for P0E57-00/P1AE3-16/P1AE5-00?
	YES → Refer to: DTC Summary list(CDU) .
NO ↓	
Step 3	Check the AC power supply.
	<ol style="list-style-type: none"> 1 Make protective preparations according to the safety operation specifications of the high voltage voltage in the maintenance manual. 2 Check the input voltage of AC power supply. 3 Check whether the result is normal or not?
	NO → Replace the AC power in good condition.
YES ↓	
Step 4	Check the AC charging gun.
	<ol style="list-style-type: none"> 1 Check whether the AC charging status is intact and the function is normal. 2 Check whether the result is normal or not?
	NO → Repair or replace the faulted parts.
YES ↓	

Step 5	Check the cable connecting the charging port to the OBC.	
		<ol style="list-style-type: none"> 1 Turn the ignition switch to OFF. 2 Disconnect the high voltage wiring harness connector of the vehicle. 3 Check whether the charging port to the OBC connection cable is rotten, damaged, and water enters. 4 Check whether the result is normal or not?
		NO → Repair or replace the faulted parts.
YES ↓		
Step 6	Check DCDC output circuit.	
		<ol style="list-style-type: none"> 1 Turn the ignition switch to OFF. 2 Make protective preparations according to the safety operation specifications of the high voltage voltage in the maintenance manual. 3 Open the CDU end cover. 4 Check DCDC output circuit. 5 Check whether the result is normal or not?
		NO → Repair or replace the faulted parts.
YES ↓		
Step 7	Check OBC.	
		<ol style="list-style-type: none"> 1 Turn the ignition switch to OFF. 2 Make protective preparations according to the safety operation specifications of the high voltage voltage in the maintenance manual. 3 Open the OBC end cover. 4 Check whether the internal circuit of OBC is damaged. 5 Check whether the result is normal or not?
		NO → Repair or replace the faulted parts.
YES ↓		

CDU

Step 8	Test whether CDU is norm.
	<ol style="list-style-type: none"> 1 Turn the ignition switch to OFF. 2 Disconnect and check the harness plug BT14、 BT15 of CDU. 3 Check and repair. <ul style="list-style-type: none"> • Corrosion(install new adapting piece or terminal-cleaning module and pin). • Pin damaged or bent-install new terminal/pin. 4 Fly out of pins-install new pins as needed. 5 Reconnect the CDU plug and all other previously disconnected plug. Make sure the pin is properly positioned and fixed. 6 Run the system and determine if the problem persists?
	YES → Change the CDU Module.
NO ↓	
At this point the system is functioning normally. The problem may be caused by module connections. Address the root cause of any connector or pin problems.	
Next Step ↓	
Diagnosis end.	

P1AD1-17、 P1AD0-16、 P0D33-00、 P1AD2-12

Fault diagnosis code
P1AD1-17: DCDC output overvoltage
P1AD0-16: DCDC output undervoltage
P0D33-00: DCDC output overcurrent
P1AD2-12: DCDC output short circuit
Detection tools
1 Multimeter and diagnostic apparatus
Possible causes
<ul style="list-style-type: none"> • Circuit,terminal and adapting piece fault • OBC battery fault • The DCDC moudle of CDU fault
Conditions for fault code operation
Turn the ignition switch to ON position.
Conditions for fault code setting
P1AD1-17
DCDC output voltage>17V and lasts for 200 milliseconds
P1AD0-16
DCDC output voltage<8V and lasting for 200 milliseconds
P0D33-00
3KWDCDC: DCDC output current>225A for 20 milliseconds
P1AD2-12
Current greater than 230A or (output voltage drop slope greater than 2V/20us and output voltage less than 6V)
To set the effect of a fault code condition
DCDC stops power output
Description of circuit diagram

Circuit diagram

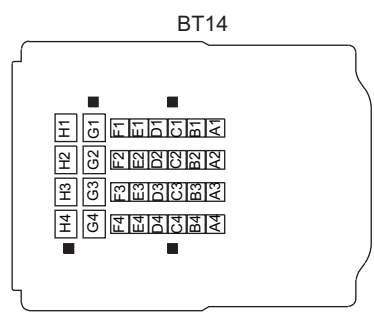
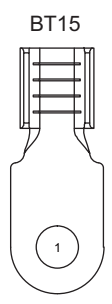
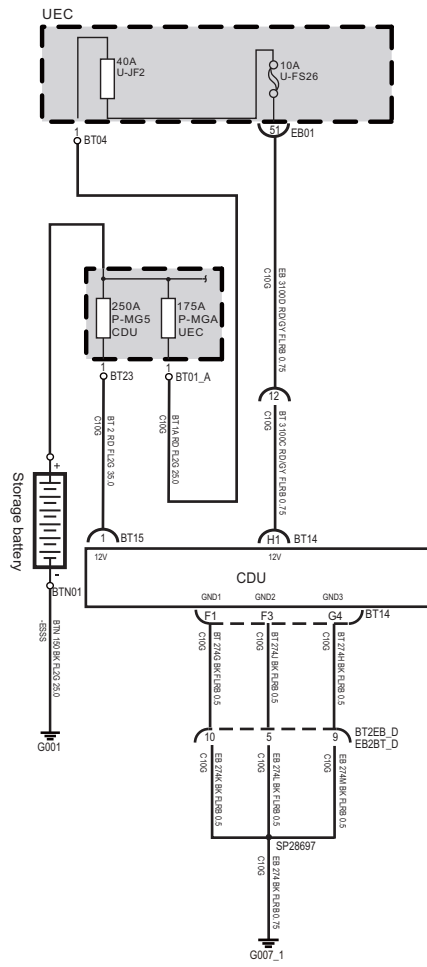

EK894005

Troubleshooting steps	
Step 1	General inspection.
	<ol style="list-style-type: none"> 1 Check the fuse for damage. 2 Check battery capacity. 3 Check the harness plug of CDU for damage, poor contact, aging and looseness. 4 Check whether the result is normal or not?
	NO → Repair or replace the faulted parts.
YES ↓	
Step 2	Check fault codes.
	<ol style="list-style-type: none"> 1 Connect the fault diagnosis instrument to the diagnosis interface. 2 Turn the ignition switch to ON position. 3 Diagnose the CDU module with diagnostic apparatus. 4 Is there any other fault code except for P1AD1-17、P1AD0-16、P0D33-00、P1AD2-12?
	YES → Refer to: DTC Summary list(CDU) .
NO ↓	
Step 3	Check the AC power supply.
	<ol style="list-style-type: none"> 1 Make protective preparations according to the safety operation specifications of the high voltage voltage in the maintenance manual. 2 Check the input voltage of AC power supply. 3 Check whether the result is normal or not?
	NO → Replace the AC power in good condition.
YES ↓	
Step 4	Check the AC charging gun.
	<ol style="list-style-type: none"> 1 Check whether the AC charging status is intact and the function is normal. 2 Check whether the result is normal or not?
	NO → Repair or replace the faulted parts.
YES ↓	

CDU

Step 5	Check the cable connecting the charging port to the OBC.	
		<ol style="list-style-type: none"> 1 Turn the ignition switch to OFF. 2 Disconnect the high voltage wiring harness connector of the vehicle. 3 Check whether the charging port to the OBC connection cable is rotten, damaged, and water enters. 4 Check whether the result is normal or not?
		NO → Repair or replace the faulted parts.
YES ↓		
Step 6	Check DCDC output circuit.	
		<ol style="list-style-type: none"> 1 Turn the ignition switch to OFF. 2 Make protective preparations according to the safety operation specifications of the high voltage voltage in the maintenance manual. 3 Open the CDU end cover. 4 Check DCDC output circuit. 5 Check whether the result is normal or not?
		NO → Repair or replace the faulted parts.
YES ↓		
Step 7	Check DCDC output circuit.	
		<ol style="list-style-type: none"> 1 Turn the ignition switch to OFF. 2 Make protective preparations according to the safety operation specifications of the high voltage voltage in the maintenance manual. 3 Disconnect the harness plug of battery and DCDC. 4 Check whether the output circuit of DCDC exist the situation of open or short circuit. 5 Check whether the result is normal or not?
		NO → Repair or replace the faulted parts.
YES ↓		

Step 8	Test whether CDU is norm.
	<ol style="list-style-type: none"> 1 Turn the ignition switch to OFF. 2 Disconnect and check the harness plug BT14、 BT15 of CDU. 3 Check and repair. <ul style="list-style-type: none"> • Corrosion(install new adapting piece or terminal-cleaning module and pin). • Pin damaged or bent-install new terminal/pin. 4 Fly out of pins-install new pins as needed. 5 Reconnect the CDU plug and all other previously disconnected plug. Make sure the pin is properly positioned and fixed. 6 Run the system and determine if the problem persists?
	YES → Change the CDU Module
NO ↓	
At this point the system is functioning normally. The problem may be caused by module connections. Address the root cause of any connector or pin problems.	
Next Step ↓	
Diagnosis end.	

P0562-F0、 P1F28-00、 P0562-00、 P0563-00

Fault diagnosis code
P0562-F0: Internal auxiliary source undervoltage
P1F28-00: Internal auxiliary source overvoltage
P0562-00: KL30 overpressure
P0563-00: KL30 undervoltage
Detection tools
1 Multimeter and diagnostic apparatus
Possible causes
<ul style="list-style-type: none"> • Circuit,terminal and adapting piece fault • Battery • CDU Module • Charging system • Insurance fuse
Conditions for fault code operation
Turn the ignition switch to ON position.
Conditions for fault code setting
P0562-F0
Auxiliary source voltage<8.5V for 1 second
P1F28-00
Auxiliary source voltage>15V for 1 second
P0562-00
KL30 voltage>16.5V for 1 second
P0563-00
KL30 voltage<8.5V for 1 second
To set the effect of a fault code condition
OBC stops power output, inverter stops power output, DCDC stops power output
Description of circuit diagram
The CDU will monitor whether all sensors and actuators are within normal range all the time. Meanwhile,it will check the connector for virtual connection, short circuit, open circuit and the connection rationality with other signals. When fault occurs, the CDU module will save the fault code corresponding to that fault and enable safety mode.

Circuit diagram

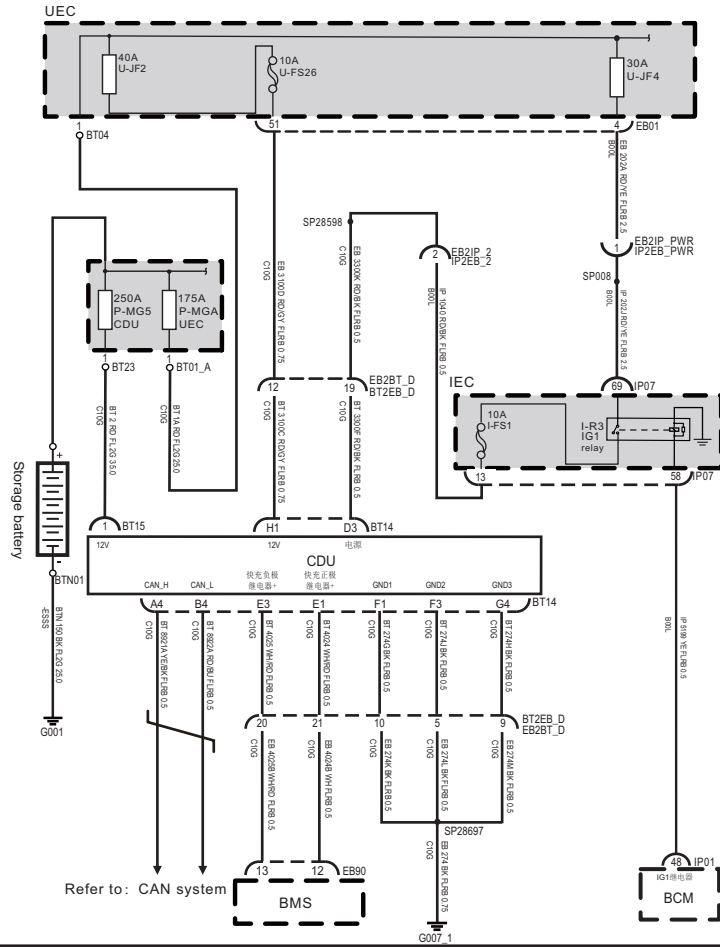

BT14

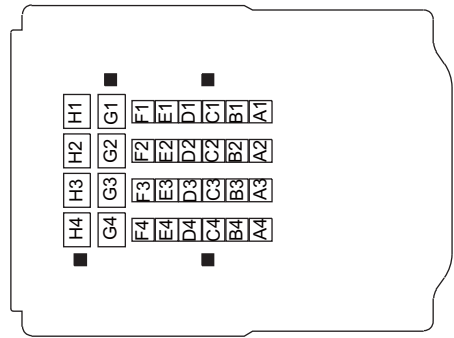

EK894001

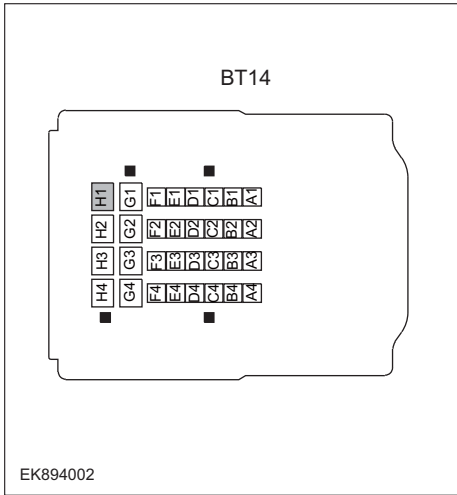
Troubleshooting steps	
Step 1	General inspection.
	<ol style="list-style-type: none"> 1 Check fuses U-FS26/I-FS1 for damage. 2 Check battery capacity. 3 Check the harness plug of CDU for damage, poor contact, aging and looseness. 4 Check whether the result is normal or not?
<p>NO → Repair or replace the faulted parts.</p>	
<p>YES ↓</p>	
Step 2	Check fault codes.
	<ol style="list-style-type: none"> 1 Connect the fault diagnosis instrument to the diagnosis interface. 2 Turn the ignition switch to ON position. 3 Diagnose the CDU with diagnostic apparatus. 4 Is there any other fault code except for P0562-F0、P1F28-00、P0562-00、P0563-00?
<p>YES → Refer to:DTC Summary list(CDU).</p>	
<p>NO ↓</p>	
Step 3	Check the power voltage of CDU battery.
	<ol style="list-style-type: none"> 1 Turn the ignition switch to OFF. 2 Disconnect the harness plug BT14 of CDU module. 3 Measure the voltage between the harness terminal of CDU and ground. Measuring circuit: voltage between terminal H1 on plug BT14 and ground. Standard value:10~14V 4 Check whether the result is normal or not?
<p>NO → Repair or replace the faulted parts.</p>	
<p>YES ↓</p>	

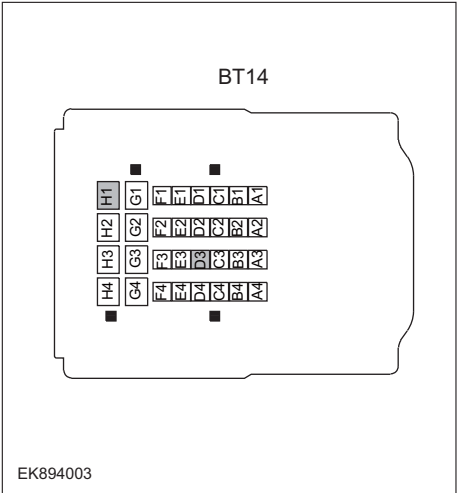
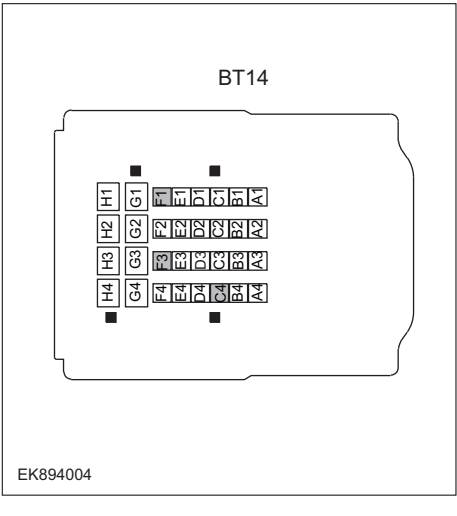
Step 4	Check the power voltage when the CDU is started or operating
	<ol style="list-style-type: none"> 1 Turn the ignition switch to ON. 2 Measure the voltage between the harness terminal of CDU and ground. Measuring circuit: voltage between terminal H1 on plug BT14 and ground. Measuring circuit: voltage between terminal D3 on plug BT14 and ground. Standard value: 10~14V 3 Check whether the result is normal or not?
<p>NO → Repair or replace the faulted parts.</p>	
<p>YES ↓</p>	
Step 5	Test whether the grounding circuit of CDU is open.
	<ol style="list-style-type: none"> 1 Turn the ignition switch to OFF. 2 Disconnect the harness plug BT14 of CDU module. 3 Measure the resistance between the harness terminal of CDU and ground. Measuring circuit: resistance between terminal F1 on plug BT14 and ground. Measuring circuit: resistance between terminal F3 on plug BT14 and ground. Measuring circuit: resistance between terminal G4 on plug BT14 and ground. Standard value: < 1Ω 4 Test whether the resistance is less than 1Ω?
<p>NO → Repair or replace the faulted parts.</p>	
<p>YES ↓</p>	

CDU

Step 6	Test whether CDU is norm.
	<ol style="list-style-type: none"> 1 Turn the ignition switch to OFF. 2 Disconnect and check the harness plug BT14、 BT15 of CDU. 3 Check and repair. <ul style="list-style-type: none"> • Corrosion(install new adapting piece or terminal-cleaning module and pin). • Pin damaged or bent-install new terminal/pin. 4 Fly out of pins-install new pins as needed. 5 Reconnect the CDU plug and all other previously disconnected plug. Make sure the pin is properly positioned and fixed. 6 Run the system and determine if the problem persists?
	YES → Change the CDU Module
NO ↓	
At this point the system is functioning normally. The problem may be caused by module connections. Address the root cause of any connector or pin problems.	
Next Step ↓	
Diagnosis end.	

P1F01-00

Fault diagnosis code
P1F01-00: PFC temperature 1 over temperature
Detection tools
1 Multimeter and diagnostic apparatus
Possible causes
<ul style="list-style-type: none">• Circuit,terminal and adapting piece fault• Cooling system fault• The PFC of CDU fault
Conditions for fault code operation
Turn the ignition switch to ON position.
Conditions for fault code setting
P1F01-00
Temperature greater than 100 °C for 3 seconds
To set the effect of a fault code condition
OBC stops power output, inverter stops power output
Description of circuit diagram

Circuit diagram

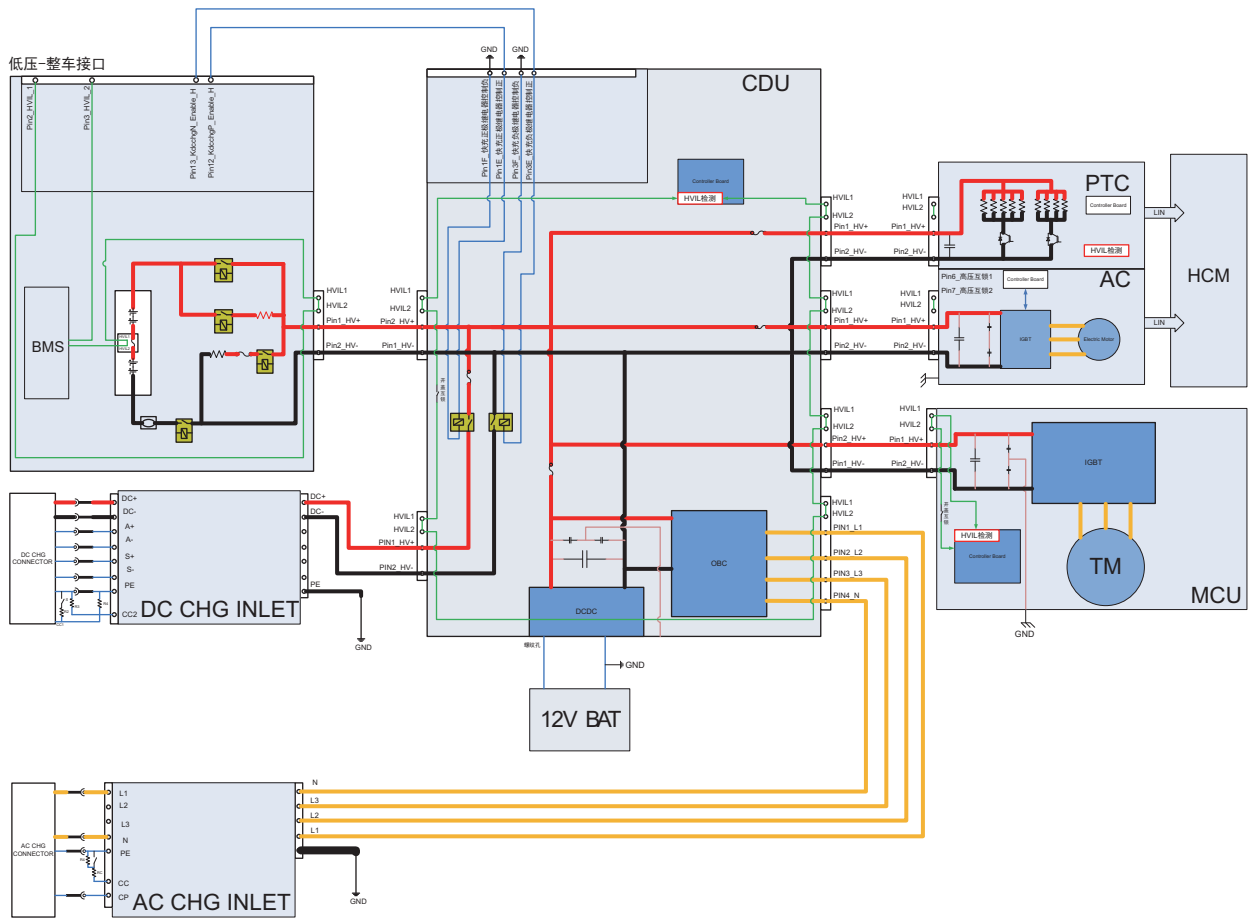

EK894014

Troubleshooting steps	
Step 1	General inspection.
	<ol style="list-style-type: none"> 1 Check the fuse for damage. 2 Check battery capacity. 3 Check the harness plug of CDU for damage, poor contact, aging and looseness. 4 Check whether the result is normal or not?
	NO → Repair or replace the faulted parts.
YES ↓	
Step 2	Check fault codes.
	<ol style="list-style-type: none"> 1 Connect the fault diagnosis instrument to the diagnosis interface. 2 Turn the ignition switch to ON position. 3 Diagnose the CDU module with diagnostic apparatus. 4 Is there any other fault code except for P1F01-00?
	YES → Refer to: DTC Summary list(CDU) .
NO ↓	
Step 3	Check cooling system.
	<ol style="list-style-type: none"> 1 Check whether there is leakage or poor heat dissipation in the cooling system. 2 Check whether the result is normal or not?
	NO → Repair the cooling system.
YES ↓	
Step 4	Check the connecting cable of CDU.
	<ol style="list-style-type: none"> 1 Turn the ignition switch to OFF. 2 Make protective preparations according to the safety operation specifications of the high voltage voltage in the maintenance manual. 3 Disconnect the harness plug battery pack high voltage. 4 Disconnect the high voltage harness plug of CDU. 5 Check whether the CDU connection cable is rotten, damaged, and water enters. 6 Check whether the result is normal or not?
	NO → Repair or replace the faulted parts.
YES ↓	

CDU

Step 5	Check CDU internal circuit.
	<ol style="list-style-type: none"> 1 Turn the ignition switch to OFF. 2 Make protective preparations according to the safety operation specifications of the high voltage voltage in the maintenance manual. 3 Open the CDU end cover. 4 Check CDU internal circuit. 5 Check whether the result is normal or not?
	NO → Repair or replace the faulted parts.
YES ↓	
Step 6	Test whether CDU is norm.
	<ol style="list-style-type: none"> 1 Turn the ignition switch to OFF. 2 Disconnect and check the harness plug BT14、 BT15 of CDU. 3 Check and repair. <ul style="list-style-type: none"> • Corrosion(install new adapting piece or terminal-cleaning module and pin). • Pin damaged or bent-install new terminal/pin. 4 Fly out of pins-install new pins as needed. 5 Reconnect the CDU plug and all other previously disconnected plug. Make sure the pin is properly positioned and fixed. 6 Run the system and determine if the problem persists?
	YES → Change the CDU Module
NO ↓	
At this point the system is functioning normally. The problem may be caused by module connections. Address the root cause of any connector or pin problems.	
Next Step ↓	
Diagnosis end.	

P1F02-00

Fault diagnosis code
P1F02-00: PFC temperature 2 over temperature
Detection tools
1 Multimeter and diagnostic apparatus
Possible causes
<ul style="list-style-type: none">• Circuit, terminal and adapting piece fault• Cooling system fault• The PFC of CDU fault
Conditions for fault code operation
Turn the ignition switch to ON position.
Conditions for fault code setting
P1F02-00
Single phase charging: temperature greater than 110 °C for 3 seconds Three phase charging: temperature greater than 98 °C for 3 seconds
To set the effect of a fault code condition
OBC stops power output, inverter stops power output
Description of circuit diagram

Circuit diagram

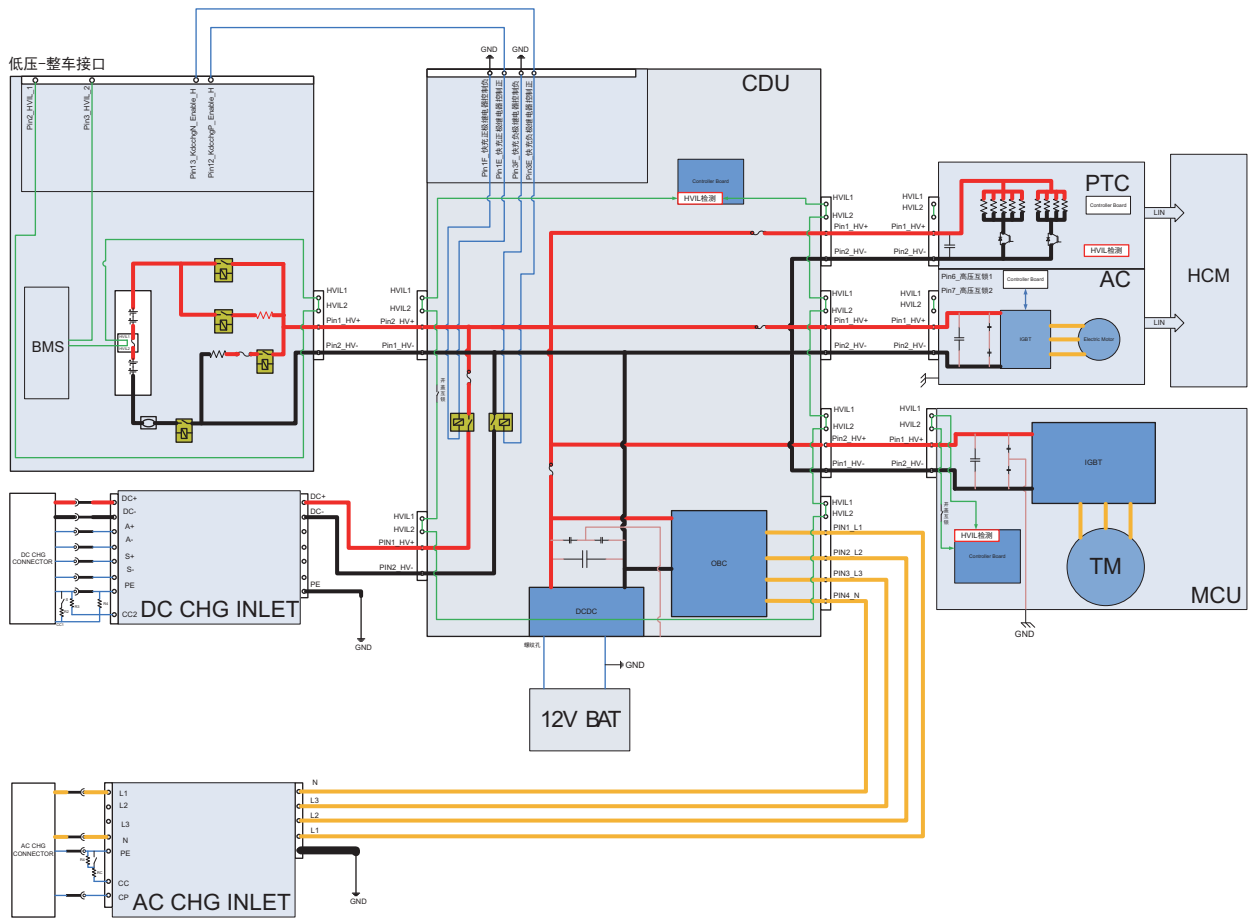

EK894014

Troubleshooting steps	
Step 1	General inspection.
	<ol style="list-style-type: none"> 1 Check the fuse for damage. 2 Check battery capacity. 3 Check the harness plug of CDU for damage, poor contact, aging and looseness. 4 Check whether the result is normal or not?
	NO → Repair or replace the faulted parts.
YES ↓	
Step 2	Check fault codes.
	<ol style="list-style-type: none"> 1 Connect the fault diagnosis instrument to the diagnosis interface. 2 Turn the ignition switch to ON position. 3 Diagnose the CDU module with diagnostic apparatus. 4 Is there any other fault code except for P1F02-00?
	YES → Refer to: DTC Summary list(CDU) .
NO ↓	
Step 3	Check cooling system.
	<ol style="list-style-type: none"> 1 Check whether there is leakage or poor heat dissipation in the cooling system. 2 Check whether the result is normal or not?
	NO → Repair the cooling system.
YES ↓	
Step 4	Check the connecting cable of CDU.
	<ol style="list-style-type: none"> 1 Turn the ignition switch to OFF. 2 Make protective preparations according to the safety operation specifications of the high voltage voltage in the maintenance manual. 3 Disconnect the harness plug battery pack high voltage. 4 Disconnect the high voltage harness plug of CDU. 5 Check whether the CDU connection cable is rotten, damaged, and water enters. 6 Check whether the result is normal or not?
	NO → Repair or replace the faulted parts.
YES ↓	

CDU

Step 5	Check CDU internal circuit.
	<ol style="list-style-type: none"> 1 Turn the ignition switch to OFF. 2 Make protective preparations according to the safety operation specifications of the high voltage voltage in the maintenance manual. 3 Open the CDU end cover. 4 Check CDU internal circuit. 5 Check whether the result is normal or not?
	NO → Repair or replace the faulted parts.
YES ↓	
Step 6	Test whether CDU is norm.
	<ol style="list-style-type: none"> 1 Turn the ignition switch to OFF. 2 Disconnect and check the harness plug BT14、 BT15 of CDU. 3 Check and repair. <ul style="list-style-type: none"> • Corrosion(install new adapting piece or terminal-cleaning module and pin). • Pin damaged or bent-install new terminal/pin. 4 Fly out of pins-install new pins as needed. 5 Reconnect the CDU plug and all other previously disconnected plug. Make sure the pin is properly positioned and fixed. 6 Run the system and determine if the problem persists?
	YES → Change the CDU Module
NO ↓	
At this point the system is functioning normally. The problem may be caused by module connections. Address the root cause of any connector or pin problems.	
Next Step ↓	
Diagnosis end.	

P1F1C-00

Fault diagnosis code
P1F1C-00: PFC temperature 3 over temperature
Detection tools
1 Multimeter and diagnostic apparatus
Possible causes
<ul style="list-style-type: none">• Circuit,terminal and adapting piece fault• Cooling system fault• The PFC of CDU fault
Conditions for fault code operation
Turn the ignition switch to ON position.
Conditions for fault code setting
P1F1C-00
Temperature greater than 100 °C for 3 seconds
To set the effect of a fault code condition
OBC stops power output, inverter stops power output
Description of circuit diagram

Circuit diagram

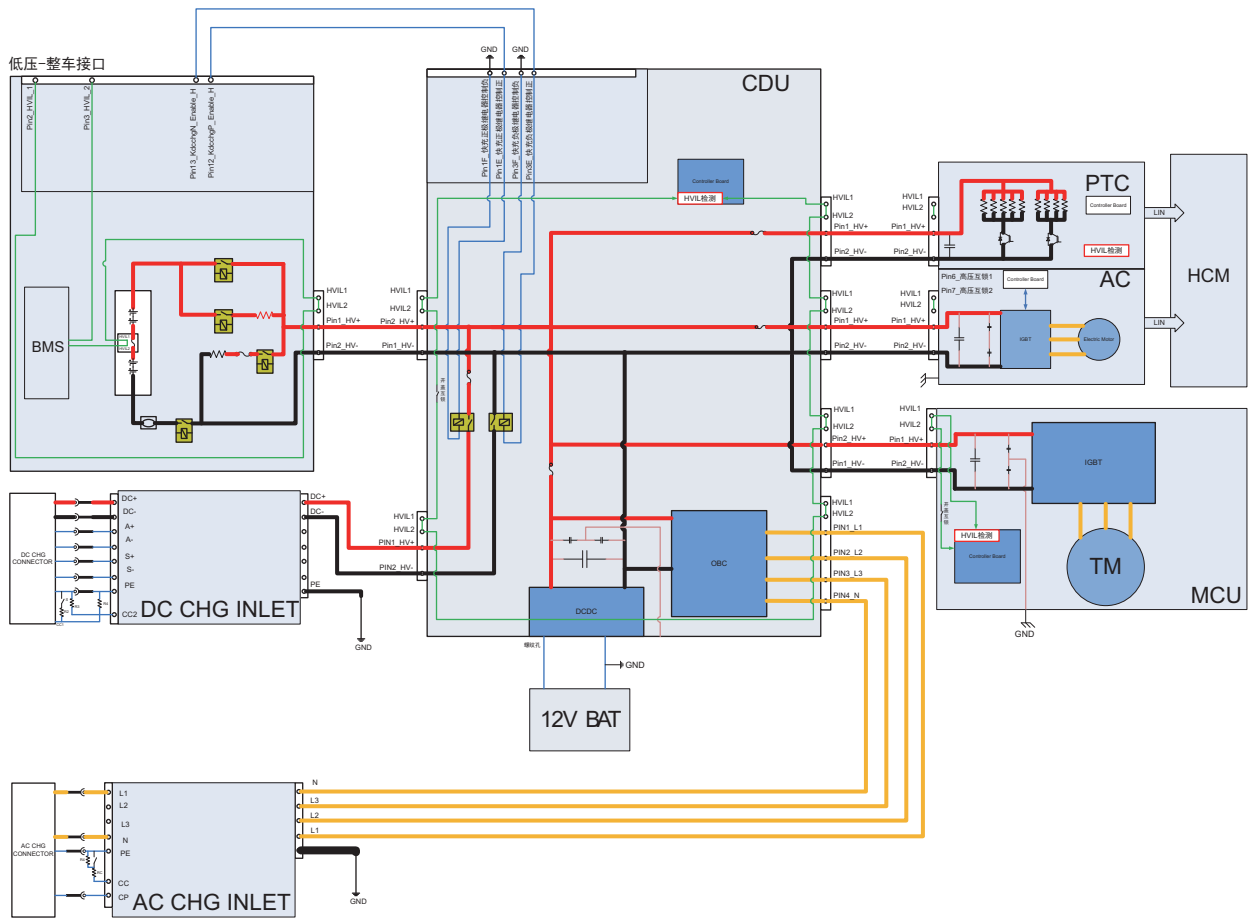

EK894014

Troubleshooting steps	
Step 1	General inspection.
	<ol style="list-style-type: none"> 1 Check the fuse for damage. 2 Check battery capacity. 3 Check the harness plug of CDU for damage, poor contact, aging and looseness. 4 Check whether the result is normal or not?
	NO → Repair or replace the faulted parts.
YES ↓	
Step 2	Check fault codes.
	<ol style="list-style-type: none"> 1 Connect the fault diagnosis instrument to the diagnosis interface. 2 Turn the ignition switch to ON position. 3 Diagnose the CDU module with diagnostic apparatus. 4 Is there any other fault code except for P1F1C-00?
	YES → Refer to: DTC Summary list(CDU) .
NO ↓	
Step 3	Check cooling system.
	<ol style="list-style-type: none"> 1 Check whether there is leakage or poor heat dissipation in the cooling system. 2 Check whether the result is normal or not?
	NO → Repair the cooling system.
YES ↓	
Step 4	Check the connecting cable of CDU.
	<ol style="list-style-type: none"> 1 Turn the ignition switch to OFF. 2 Make protective preparations according to the safety operation specifications of the high voltage voltage in the maintenance manual. 3 Disconnect the harness plug battery pack high voltage. 4 Disconnect the high voltage harness plug of CDU. 5 Check whether the CDU connection cable is rotten, damaged, and water enters. 6 Check whether the result is normal or not?
	NO → Repair or replace the faulted parts.
YES ↓	

CDU

Step 5	Check CDU internal circuit.
	<ol style="list-style-type: none"> 1 Turn the ignition switch to OFF. 2 Make protective preparations according to the safety operation specifications of the high voltage voltage in the maintenance manual. 3 Open the CDU end cover. 4 Check CDU internal circuit. 5 Check whether the result is normal or not?
	NO → Repair or replace the faulted parts.
YES ↓	
Step 6	Test whether CDU is norm.
	<ol style="list-style-type: none"> 1 Turn the ignition switch to OFF. 2 Disconnect and check the harness plug BT14、 BT15 of CDU. 3 Check and repair. <ul style="list-style-type: none"> • Corrosion(install new adapting piece or terminal-cleaning module and pin). • Pin damaged or bent-install new terminal/pin. 4 Fly out of pins-install new pins as needed. 5 Reconnect the CDU plug and all other previously disconnected plug. Make sure the pin is properly positioned and fixed. 6 Run the system and determine if the problem persists?
	YES → Change the CDU Module.
NO ↓	
At this point the system is functioning normally. The problem may be caused by module connections. Address the root cause of any connector or pin problems.	
Next Step ↓	
Diagnosis end.	

P1F03-00

Fault diagnosis code
P1F03-00: LLC temperature 1 over temperature (bridge arm 1)
Detection tools
1 Multimeter and diagnostic apparatus
Possible causes
<ul style="list-style-type: none">• Circuit,terminal and adapting piece fault• Cooling system fault• The LLC of CDU fault
Conditions for fault code operation
Turn the ignition switch to ON position.
Conditions for fault code setting
P1F03-00
To set the effect of a fault code condition
Description of circuit diagram

Circuit diagram

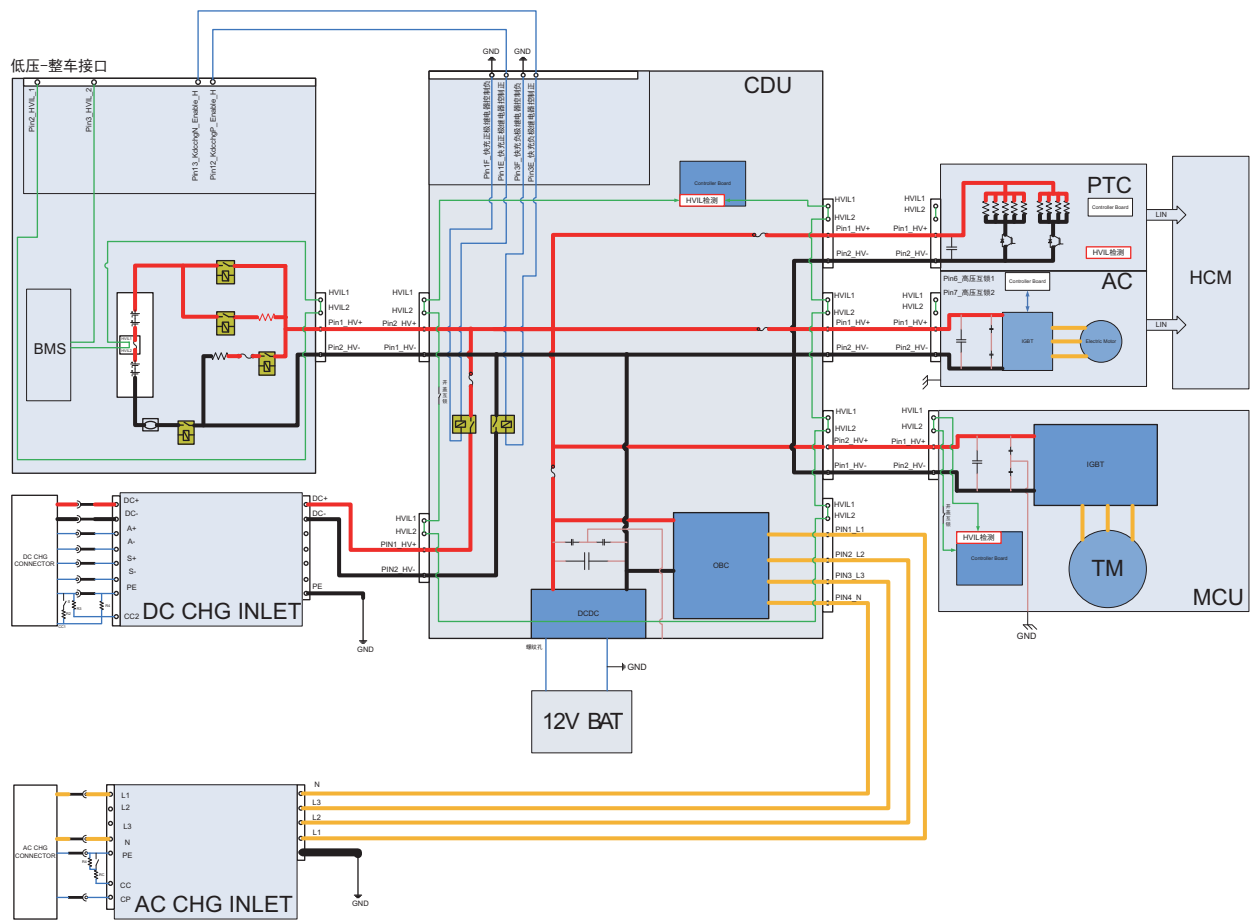

EK894014

Troubleshooting steps	
Step 1	General inspection.
	<ol style="list-style-type: none"> 1 Check the fuse for damage. 2 Check battery capacity. 3 Check the harness plug of CDU for damage, poor contact, aging and looseness. 4 Check whether the result is normal or not?
	NO → Repair or replace the faulted parts.
YES ↓	
Step 2	Check fault codes.
	<ol style="list-style-type: none"> 1 Connect the fault diagnosis instrument to the diagnosis interface. 2 Turn the ignition switch to ON position. 3 Diagnose the CDU module with diagnostic apparatus. 4 Is there any other fault code except for P1F03-00?
	YES → Refer to: DTC Summary list(CDU) .
NO ↓	
Step 3	Check cooling system.
	<ol style="list-style-type: none"> 1 Check whether there is leakage or poor heat dissipation in the cooling system. 2 Check whether the result is normal or not?
	NO → Repair the cooling system.
YES ↓	
Step 4	Check the connecting cable of CDU.
	<ol style="list-style-type: none"> 1 Turn the ignition switch to OFF. 2 Make protective preparations according to the safety operation specifications of the high voltage voltage in the maintenance manual. 3 Disconnect the harness plug battery pack high voltage. 4 Disconnect the high voltage harness plug of CDU. 5 Check whether the CDU connection cable is rotten, damaged, and water enters. 6 Check whether the result is normal or not?
	NO → Repair or replace the faulted parts.
YES ↓	

CDU

Step 5	Check CDU internal circuit.
	<ol style="list-style-type: none"> 1 Turn the ignition switch to OFF. 2 Make protective preparations according to the safety operation specifications of the high voltage voltage in the maintenance manual. 3 Open the CDU end cover. 4 Check CDU internal circuit. 5 Check whether the result is normal or not?
	NO → Repair or replace the faulted parts.
YES ↓	
Step 6	Test whether CDU is norm.
	<ol style="list-style-type: none"> 1 Turn the ignition switch to OFF. 2 Disconnect and check the harness plug BT14、 BT15 of CDU. 3 Check and repair. <ul style="list-style-type: none"> • Corrosion(install new adapting piece or terminal-cleaning module and pin). • Pin damaged or bent-install new terminal/pin. 4 Fly out of pins-install new pins as needed. 5 Reconnect the CDU plug and all other previously disconnected plug. Make sure the pin is properly positioned and fixed. 6 Run the system and determine if the problem persists?
	YES → Change the CDU Module
NO ↓	
At this point the system is functioning normally. The problem may be caused by module connections. Address the root cause of any connector or pin problems.	
Next Step ↓	
Diagnosis end.	

P1F04-00

Fault diagnosis code
P1F04-00: LLC temperature 2 over temperature (bridge arm 2)
Detection tools
1 Multimeter and diagnostic apparatus
Possible causes
<ul style="list-style-type: none">• Circuit, terminal and adapting piece fault• Cooling system fault• The LLC of CDU fault
Conditions for fault code operation
Turn the ignition switch to ON position.
Conditions for fault code setting
P1F04-00
Temperature greater than 105 °C for 3 seconds
To set the effect of a fault code condition
OBC stops power output, inverter stops power output
Description of circuit diagram

Circuit diagram

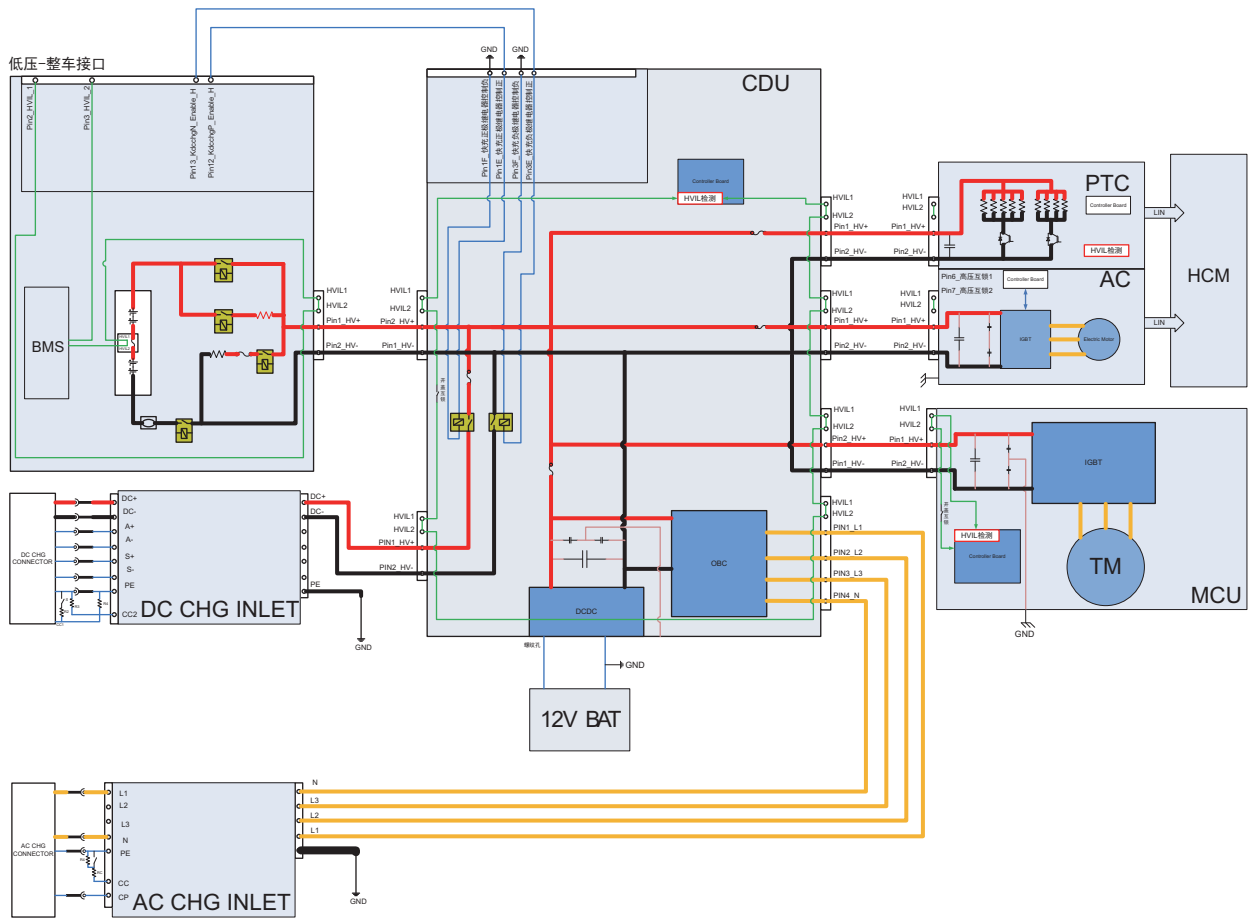

EK894014

Troubleshooting steps	
Step 1	General inspection.
	<ol style="list-style-type: none"> 1 Check the fuse for damage. 2 Check battery capacity. 3 Check the harness plug of CDU for damage, poor contact, aging and looseness. 4 Check whether the result is normal or not?
	NO → Repair or replace the faulted parts.
YES ↓	
Step 2	Check fault codes.
	<ol style="list-style-type: none"> 1 Connect the fault diagnosis instrument to the diagnosis interface. 2 Turn the ignition switch to ON position. 3 Diagnose the CDU module with diagnostic apparatus. 4 Is there any other fault code except for P1F04-00?
	YES → Refer to: DTC Summary list(CDU) .
NO ↓	
Step 3	Check cooling system.
	<ol style="list-style-type: none"> 1 Check whether there is leakage or poor heat dissipation in the cooling system. 2 Check whether the result is normal or not?
	NO → Repair the cooling system.
YES ↓	
Step 4	Check the connecting cable of CDU.
	<ol style="list-style-type: none"> 1 Turn the ignition switch to OFF. 2 Make protective preparations according to the safety operation specifications of the high voltage voltage in the maintenance manual. 3 Disconnect the harness plug battery pack high voltage. 4 Disconnect the high voltage harness plug of CDU. 5 Check whether the CDU connection cable is rotten, damaged, and water enters. 6 Check whether the result is normal or not?
	NO → Repair or replace the faulted parts.
YES ↓	

CDU

Step 5	Check CDU internal circuit.
	<ol style="list-style-type: none"> 1 Turn the ignition switch to OFF. 2 Make protective preparations according to the safety operation specifications of the high voltage voltage in the maintenance manual. 3 Open the CDU end cover. 4 Check CDU internal circuit. 5 Check whether the result is normal or not?
	NO → Repair or replace the faulted parts.
YES ↓	
Step 6	Test whether CDU is norm.
	<ol style="list-style-type: none"> 1 Turn the ignition switch to OFF. 2 Disconnect and check the harness plug BT14、 BT15 of CDU. 3 Check and repair. <ul style="list-style-type: none"> • Corrosion(install new adapting piece or terminal-cleaning module and pin). • Pin damaged or bent-install new terminal/pin. 4 Fly out of pins-install new pins as needed. 5 Reconnect the CDU plug and all other previously disconnected plug. Make sure the pin is properly positioned and fixed. 6 Run the system and determine if the problem persists?
	YES → Change the CDU Module
NO ↓	
At this point the system is functioning normally. The problem may be caused by module connections. Address the root cause of any connector or pin problems.	
Next Step ↓	
Diagnosis end.	

P1F12-00

Fault diagnosis code
P1F12-00: LLC temperature 3 over temperature (HV_SEC secondary side MOS tube)
Detection tools
1 Multimeter and diagnostic apparatus
Possible causes
<ul style="list-style-type: none">• Circuit,terminal and adapting piece fault• Cooling system fault• The LLC of CDU fault
Conditions for fault code operation
Turn the ignition switch to ON position.
Conditions for fault code setting
P1F12-00
Temperature greater than 105 °C for 3 seconds
To set the effect of a fault code condition
OBC stops power output, inverter stops power output
Description of circuit diagram

Circuit diagram

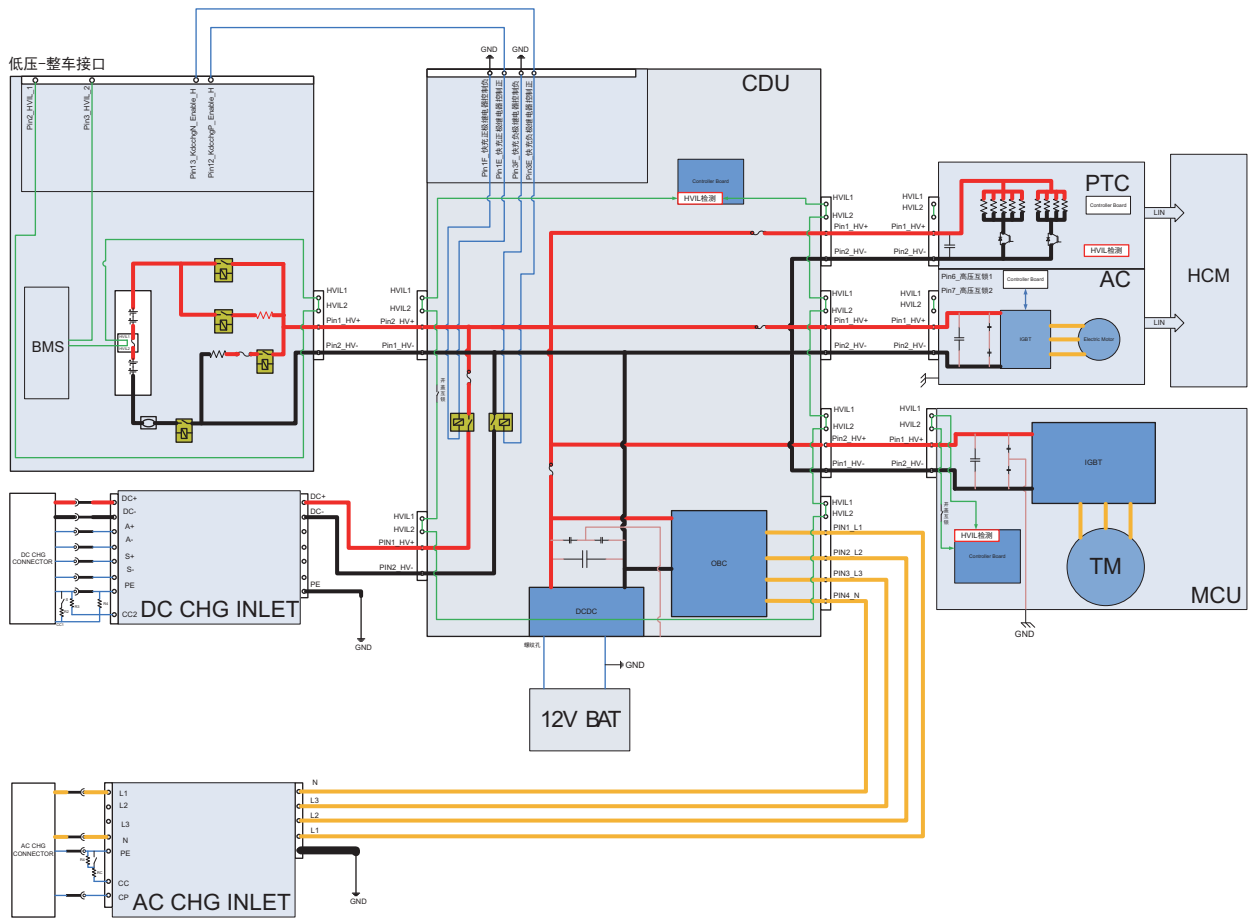

EK894014

Troubleshooting steps	
Step 1	General inspection.
	<ol style="list-style-type: none"> 1 Check the fuse for damage. 2 Check battery capacity. 3 Check the harness plug of CDU for damage, poor contact, aging and looseness. 4 Check whether the result is normal or not?
	NO → Repair or replace the faulted parts.
YES ↓	
Step 2	Check fault codes.
	<ol style="list-style-type: none"> 1 Connect the fault diagnosis instrument to the diagnosis interface. 2 Turn the ignition switch to ON position. 3 Diagnose the CDU module with diagnostic apparatus. 4 Is there any other fault code except for P1F12-00?
	YES → Refer to: DTC Summary list(CDU) .
NO ↓	
Step 3	Check cooling system.
	<ol style="list-style-type: none"> 1 Check whether there is leakage or poor heat dissipation in the cooling system. 2 Check whether the result is normal or not?
	NO → Repair the cooling system.
YES ↓	
Step 4	Check the connecting cable of CDU.
	<ol style="list-style-type: none"> 1 Turn the ignition switch to OFF. 2 Make protective preparations according to the safety operation specifications of the high voltage voltage in the maintenance manual. 3 Disconnect the harness plug battery pack high voltage. 4 Disconnect the high voltage harness plug of CDU. 5 Check whether the CDU connection cable is rotten, damaged, and water enters. 6 Check whether the result is normal or not?
	NO → Repair or replace the faulted parts.
YES ↓	

CDU

Step 5	Check CDU internal circuit.
	<ol style="list-style-type: none"> 1 Turn the ignition switch to OFF. 2 Make protective preparations according to the safety operation specifications of the high voltage voltage in the maintenance manual. 3 Open the CDU end cover. 4 Check CDU internal circuit. 5 Check whether the result is normal or not?
	NO → Repair or replace the faulted parts.
YES ↓	
Step 6	Test whether CDU is norm.
	<ol style="list-style-type: none"> 1 Turn the ignition switch to OFF. 2 Disconnect and check the harness plug BT14、 BT15 of CDU. 3 Check and repair. <ul style="list-style-type: none"> • Corrosion(install new adapting piece or terminal-cleaning module and pin). • Pin damaged or bent-install new terminal/pin. 4 Fly out of pins-install new pins as needed. 5 Reconnect the CDU plug and all other previously disconnected plug. Make sure the pin is properly positioned and fixed. 6 Run the system and determine if the problem persists?
	YES → Change the CDU Module
NO ↓	
At this point the system is functioning normally. The problem may be caused by module connections. Address the root cause of any connector or pin problems.	
Next Step ↓	
Diagnosis end.	

P1F13-00

Fault diagnosis code
P1F13-00: LLC temperature 4 over temperature (HV output PCB)
Detection tools
1 Multimeter and diagnostic apparatus
Possible causes
<ul style="list-style-type: none">• Circuit,terminal and adapting piece fault• Cooling system fault• The LLC of CDU fault
Conditions for fault code operation
Turn the ignition switch to ON position.
Conditions for fault code setting
P1F13-00
To set the effect of a fault code condition
Description of circuit diagram

Circuit diagram

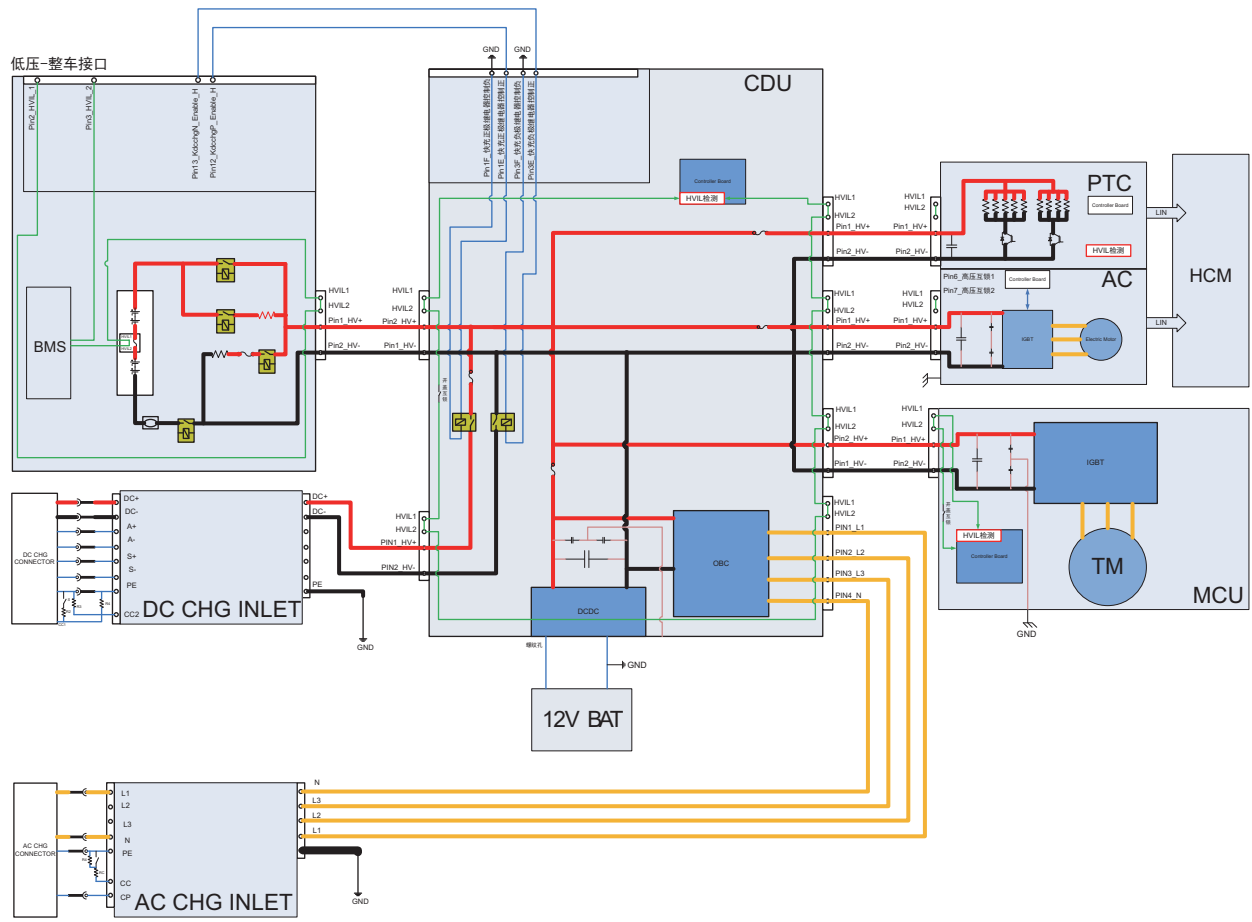

EK894014

Troubleshooting steps	
Step 1	General inspection.
	<ol style="list-style-type: none"> 1 Check the fuse for damage. 2 Check battery capacity. 3 Check the harness plug of CDU for damage, poor contact, aging and looseness. 4 Check whether the result is normal or not?
	NO → Repair or replace the faulted parts.
YES ↓	
Step 2	Check fault codes.
	<ol style="list-style-type: none"> 1 Connect the fault diagnosis instrument to the diagnosis interface. 2 Turn the ignition switch to ON position. 3 Diagnose the CDU module with diagnostic apparatus. 4 Is there any other fault code except for P1F13-00?
	YES → Refer to: DTC Summary list(CDU) .
NO ↓	
Step 3	Check cooling system.
	<ol style="list-style-type: none"> 1 Check whether there is leakage or poor heat dissipation in the cooling system. 2 Check whether the result is normal or not?
	NO → Repair the cooling system.
YES ↓	
Step 4	Check the connecting cable of CDU.
	<ol style="list-style-type: none"> 1 Turn the ignition switch to OFF. 2 Make protective preparations according to the safety operation specifications of the high voltage voltage in the maintenance manual. 3 Disconnect the harness plug battery pack high voltage. 4 Disconnect the high voltage harness plug of CDU. 5 Check whether the CDU connection cable is rotten, damaged, and water enters. 6 Check whether the result is normal or not?
	NO → Repair or replace the faulted parts.
YES ↓	

CDU

Step 5	Check CDU internal circuit.
	<ol style="list-style-type: none"> 1 Turn the ignition switch to OFF. 2 Make protective preparations according to the safety operation specifications of the high voltage voltage in the maintenance manual. 3 Open the CDU end cover. 4 Check CDU internal circuit. 5 Check whether the result is normal or not?
	NO → Repair or replace the faulted parts.
YES ↓	
Step 6	Test whether CDU is norm.
	<ol style="list-style-type: none"> 1 Turn the ignition switch to OFF. 2 Disconnect and check the harness plug BT14、 BT15 of CDU. 3 Check and repair. <ul style="list-style-type: none"> • Corrosion(install new adapting piece or terminal-cleaning module and pin). • Pin damaged or bent-install new terminal/pin. 4 Fly out of pins-install new pins as needed. 5 Reconnect the CDU plug and all other previously disconnected plug. Make sure the pin is properly positioned and fixed. 6 Run the system and determine if the problem persists?
	YES → Change the CDU Module
NO ↓	
At this point the system is functioning normally. The problem may be caused by module connections. Address the root cause of any connector or pin problems.	
Next Step ↓	
Diagnosis end.	

P1AE0-00

Fault diagnosis code
P1AE0-00: DCDC temperature 1 over temperature (input MOS tube)
Detection tools
1 Multimeter and diagnostic apparatus
Possible causes
<ul style="list-style-type: none">• Circuit,terminal and adapting piece fault• Cooling system fault• The DCDC of CDU fault
Conditions for fault code operation
Turn the ignition switch to ON position.
Conditions for fault code setting
P1AE0-00
Temperature greater than 95 °C for 3 seconds
To set the effect of a fault code condition
DCDC stops power output
Description of circuit diagram

Circuit diagram

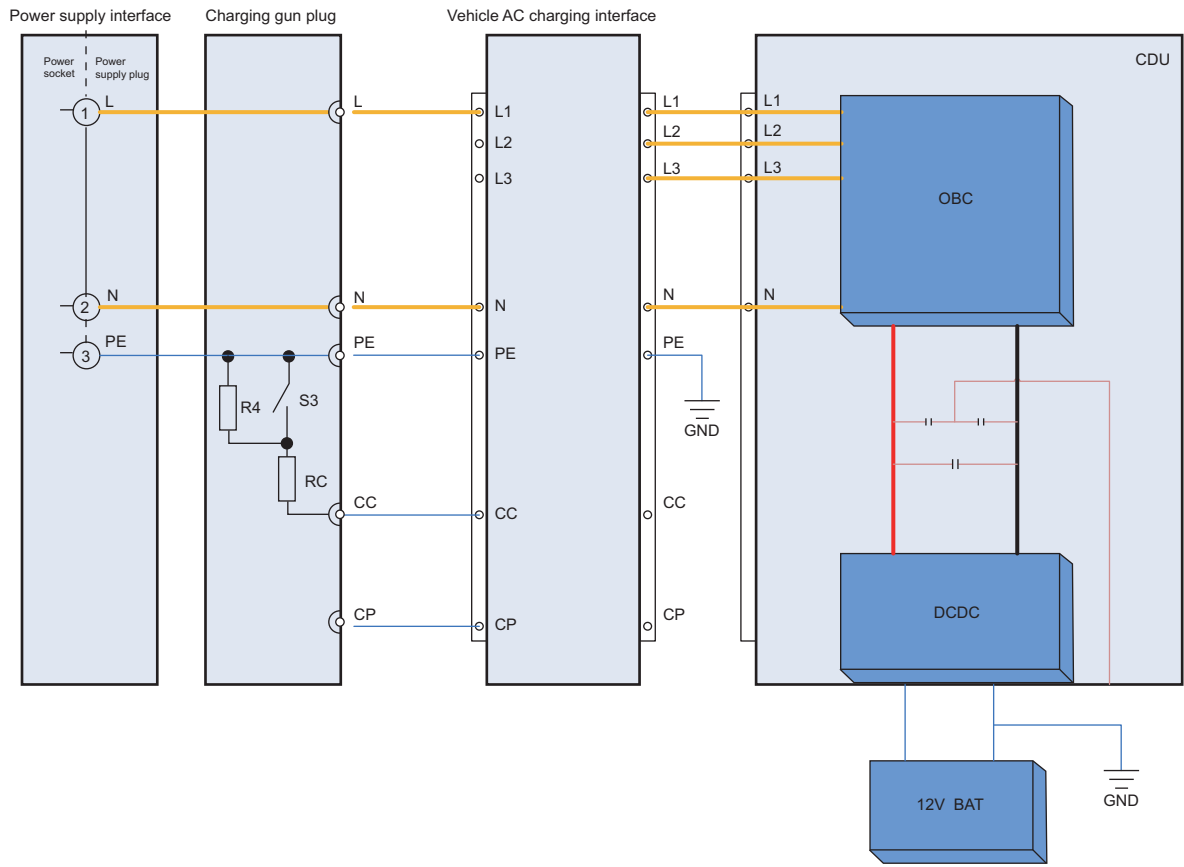

AC charging gun interface AC charging gun plug

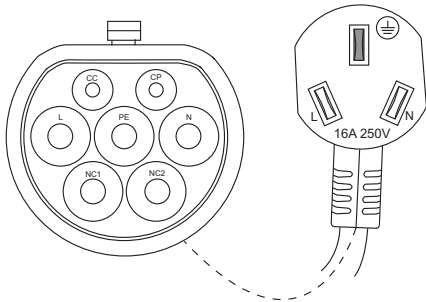

Vehicle AC charging interface

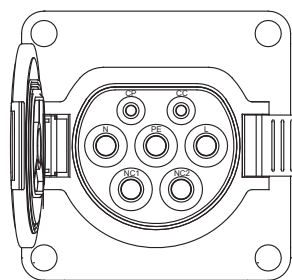

EK894015

Troubleshooting steps	
Step 1	General inspection.
	<ol style="list-style-type: none"> 1 Check the fuse for damage. 2 Check battery capacity. 3 Check the harness plug of CDU for damage, poor contact, aging and looseness. 4 Check whether the result is normal or not?
	NO → Repair or replace the faulted parts.
YES ↓	
Step 2	Check fault codes.
	<ol style="list-style-type: none"> 1 Connect the fault diagnosis instrument to the diagnosis interface. 2 Turn the ignition switch to ON position. 3 Diagnose the CDU module with diagnostic apparatus. 4 Is there any other fault code except for P1AE0-00?
	YES → Refer to: DTC Summary list(CDU) .
NO ↓	
Step 3	Check cooling system.
	<ol style="list-style-type: none"> 1 Check whether there is leakage or poor heat dissipation in the cooling system. 2 Check whether the result is normal or not?
	NO → Repair the cooling system.
YES ↓	
Step 4	Check the connecting cable of CDU.
	<ol style="list-style-type: none"> 1 Turn the ignition switch to OFF. 2 Make protective preparations according to the safety operation specifications of the high voltage voltage in the maintenance manual. 3 Disconnect the harness plug battery pack high voltage. 4 Disconnect the high voltage harness plug of CDU. 5 Check whether the CDU connection cable is rotten, damaged, and water enters. 6 Check whether the result is normal or not?
	NO → Repair or replace the faulted parts.
YES ↓	

CDU

Step 5	Check CDU internal circuit.
	<ol style="list-style-type: none"> 1 Turn the ignition switch to OFF. 2 Make protective preparations according to the safety operation specifications of the high voltage voltage in the maintenance manual. 3 Open the CDU end cover. 4 Check CDU internal circuit. 5 Check whether the result is normal or not?
	NO → Repair or replace the faulted parts.
YES ↓	
Step 6	Test whether CDU is norm.
	<ol style="list-style-type: none"> 1 Turn the ignition switch to OFF. 2 Disconnect and check the harness plug BT14、 BT15 of CDU. 3 Check and repair. <ul style="list-style-type: none"> • Corrosion(install new adapting piece or terminal-cleaning module and pin). • Pin damaged or bent-install new terminal/pin. 4 Fly out of pins-install new pins as needed. 5 Reconnect the CDU plug and all other previously disconnected plug. Make sure the pin is properly positioned and fixed. 6 Run the system and determine if the problem persists?
	YES → Change the CDU Module
NO ↓	
At this point the system is functioning normally. The problem may be caused by module connections. Address the root cause of any connector or pin problems.	
Next Step ↓	
Diagnosis end.	

P1AE1-00

Fault diagnosis code
P1AE1-00: DCDC temperature 2 over temperature (synchronous rectifier)
Detection tools
1 Multimeter and diagnostic apparatus
Possible causes
<ul style="list-style-type: none">• Circuit,terminal and adapting piece fault• Cooling system fault• The DCDC of CDU fault
Conditions for fault code operation
Turn the ignition switch to ON position.
Conditions for fault code setting
P1AE1-00
Temperature greater than 95 °C for 3 seconds
To set the effect of a fault code condition
DCDC stops power output
Description of circuit diagram

Circuit diagram

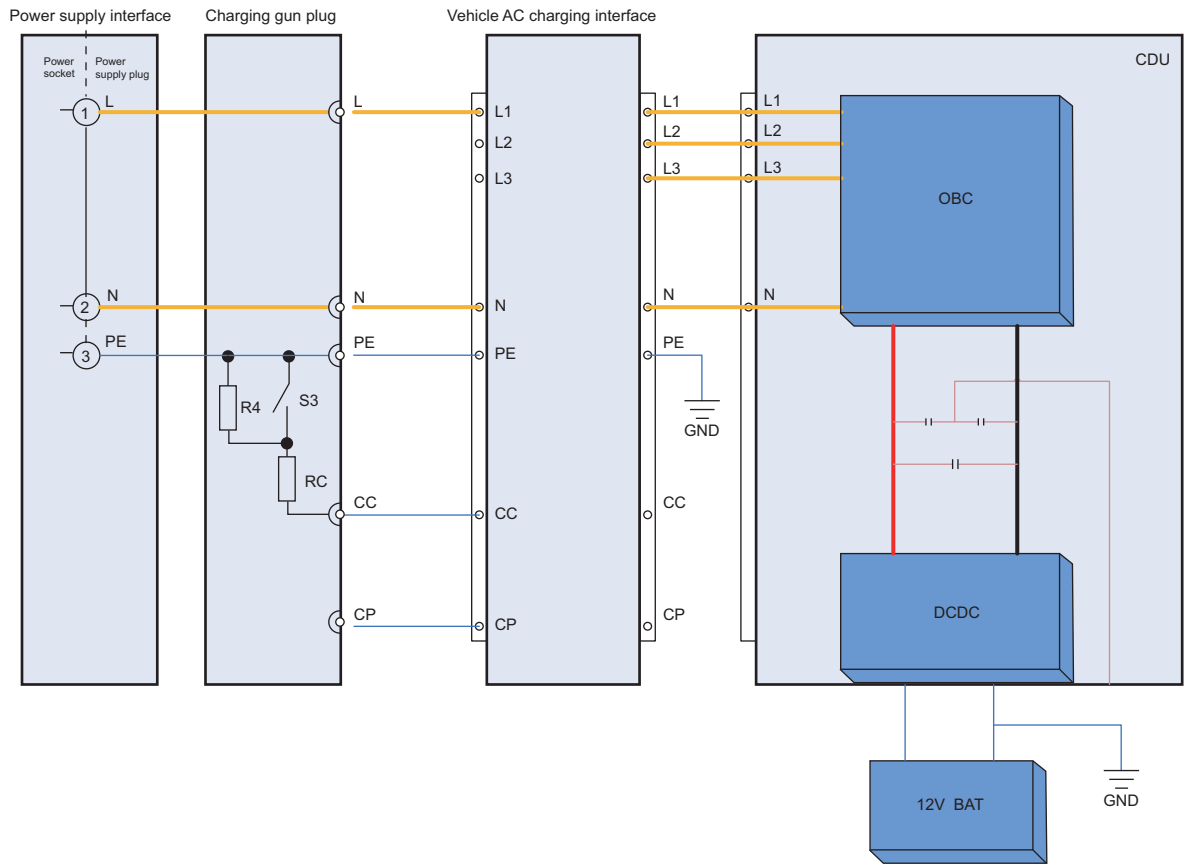

AC charging gun interface AC charging gun plug

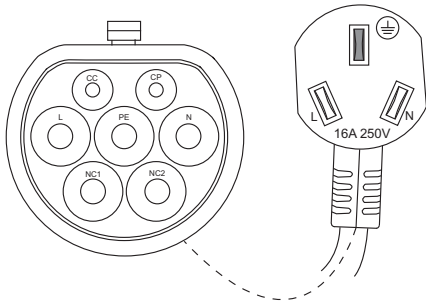

Vehicle AC charging interface

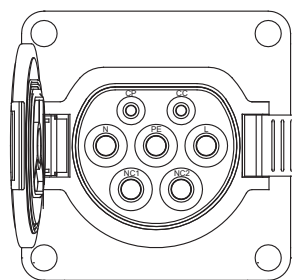

EK894015

Troubleshooting steps	
Step 1	General inspection.
	<ol style="list-style-type: none"> 1 Check the fuse for damage. 2 Check battery capacity. 3 Check the harness plug of CDU for damage, poor contact, aging and looseness. 4 Check whether the result is normal or not?
	NO → Repair or replace the faulted parts.
YES ↓	
Step 2	Check fault codes.
	<ol style="list-style-type: none"> 1 Connect the fault diagnosis instrument to the diagnosis interface. 2 Turn the ignition switch to ON position. 3 Diagnose the CDU module with diagnostic apparatus. 4 Is there any other fault code except for P1AE1-00?
	YES → Refer to: DTC Summary list(CDU) .
NO ↓	
Step 3	Check cooling system.
	<ol style="list-style-type: none"> 1 Check whether there is leakage or poor heat dissipation in the cooling system. 2 Check whether the result is normal or not?
	NO → Repair the cooling system.
YES ↓	
Step 4	Check the connecting cable of CDU.
	<ol style="list-style-type: none"> 1 Turn the ignition switch to OFF. 2 Make protective preparations according to the safety operation specifications of the high voltage voltage in the maintenance manual. 3 Disconnect the harness plug battery pack high voltage. 4 Disconnect the high voltage harness plug of CDU. 5 Check whether the CDU connection cable is rotten, damaged, and water enters. 6 Check whether the result is normal or not?
	NO → Repair or replace the faulted parts.
YES ↓	

CDU

Step 5	Check CDU internal circuit.
	<ol style="list-style-type: none"> 1 Turn the ignition switch to OFF. 2 Make protective preparations according to the safety operation specifications of the high voltage voltage in the maintenance manual. 3 Open the CDU end cover. 4 Check CDU internal circuit. 5 Check whether the result is normal or not?
	NO → Repair or replace the faulted parts.
YES ↓	
Step 6	Test whether CDU is norm.
	<ol style="list-style-type: none"> 1 Turn the ignition switch to OFF. 2 Disconnect and check the harness plug BT14、 BT15 of CDU. 3 Check and repair. <ul style="list-style-type: none"> • Corrosion(install new adapting piece or terminal-cleaning module and pin). • Pin damaged or bent-install new terminal/pin. 4 Fly out of pins-install new pins as needed. 5 Reconnect the CDU plug and all other previously disconnected plug. Make sure the pin is properly positioned and fixed. 6 Run the system and determine if the problem persists?
	YES → Change the CDU Module.
NO ↓	
At this point the system is functioning normally. The problem may be caused by module connections. Address the root cause of any connector or pin problems.	
Next Step ↓	
Diagnosis end.	

P1F06-00

Fault diagnosis code
P1F06-00: DCDC temperature 3 over temperature (water channel)
Detection tools
1 Multimeter and diagnostic apparatus
Possible causes
<ul style="list-style-type: none">• Circuit,terminal and adapting piece fault• Cooling system fault• The DCDC of CDU fault
Conditions for fault code operation
Turn the ignition switch to ON position.
Conditions for fault code setting
P1F06-00
Temperature greater than 85 °C for 3 seconds
To set the effect of a fault code condition
OBC stops power output, inverter stops power output, DCDC stops power output
Description of circuit diagram

Circuit diagram

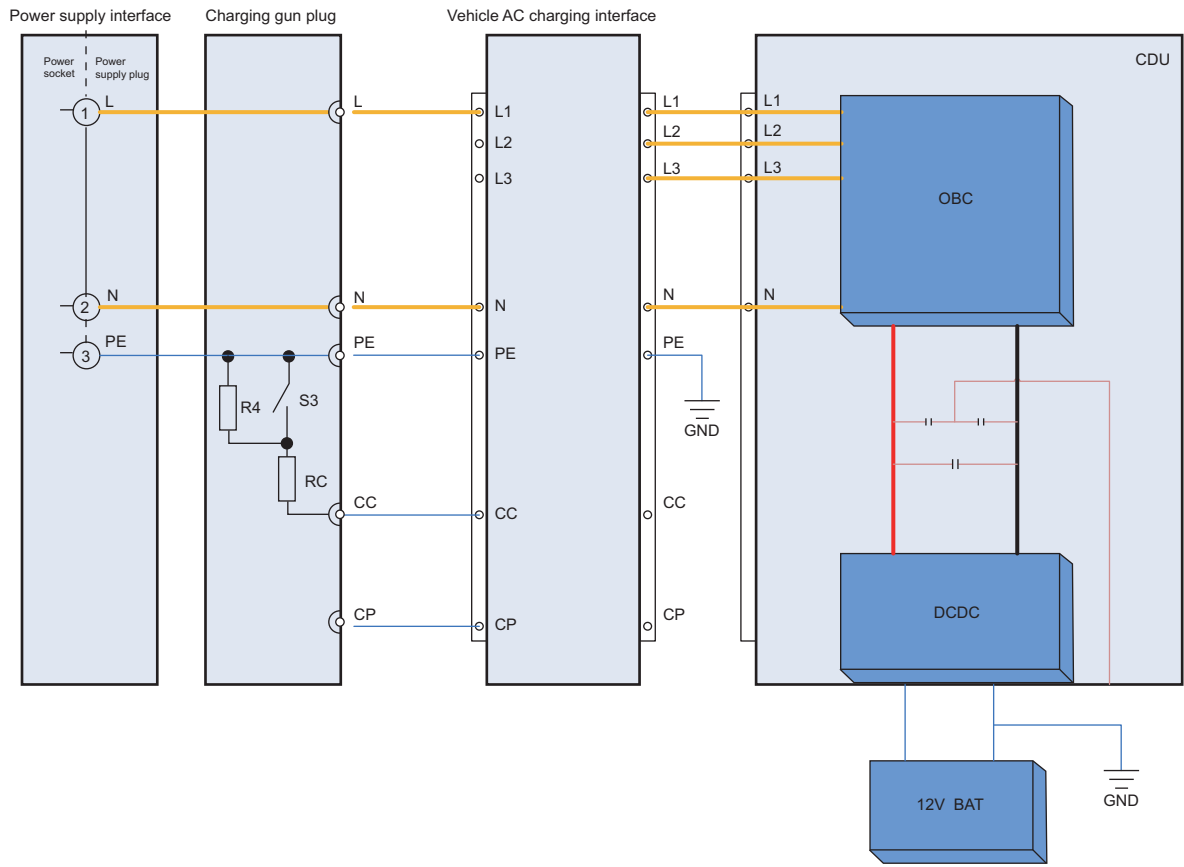

AC charging gun interface AC charging gun plug

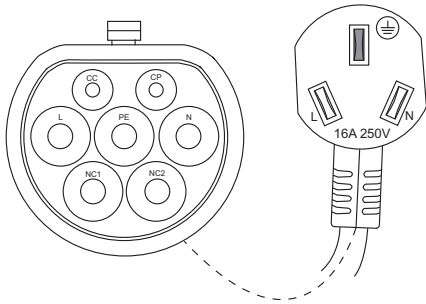

Vehicle AC charging interface

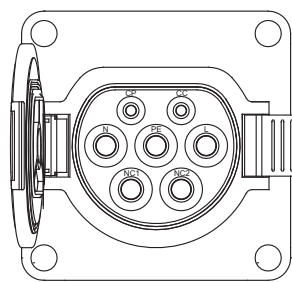

EK894015

Troubleshooting steps	
Step 1	General inspection.
	<ol style="list-style-type: none"> 1 Check the fuse for damage. 2 Check battery capacity. 3 Check the harness plug of CDU for damage, poor contact, aging and looseness. 4 Check whether the result is normal or not?
	NO → Repair or replace the faulted parts.
YES ↓	
Step 2	Check fault codes.
	<ol style="list-style-type: none"> 1 Connect the fault diagnosis instrument to the diagnosis interface. 2 Turn the ignition switch to ON position. 3 Diagnose the CDU module with diagnostic apparatus. 4 Is there any other fault code except for P1F06-00?
	YES → Refer to: DTC Summary list(CDU) .
NO ↓	
Step 3	Check cooling system.
	<ol style="list-style-type: none"> 1 Check whether there is leakage or poor heat dissipation in the cooling system. 2 Check whether the result is normal or not?
	NO → Repair the cooling system.
YES ↓	
Step 4	Check the connecting cable of CDU.
	<ol style="list-style-type: none"> 1 Turn the ignition switch to OFF. 2 Make protective preparations according to the safety operation specifications of the high voltage voltage in the maintenance manual. 3 Disconnect the harness plug battery pack high voltage. 4 Disconnect the high voltage harness plug of CDU. 5 Check whether the CDU connection cable is rotten, damaged, and water enters. 6 Check whether the result is normal or not?
	NO → Repair or replace the faulted parts.
YES ↓	

CDU

Step 5	Check CDU internal circuit.
	<ol style="list-style-type: none"> 1 Turn the ignition switch to OFF. 2 Make protective preparations according to the safety operation specifications of the high voltage voltage in the maintenance manual. 3 Open the CDU end cover. 4 Check CDU internal circuit. 5 Check whether the result is normal or not?
	NO → Repair or replace the faulted parts.
YES ↓	
Step 6	Test whether CDU is norm.
	<ol style="list-style-type: none"> 1 Turn the ignition switch to OFF. 2 Disconnect and check the harness plug BT14、 BT15 of CDU. 3 Check and repair. <ul style="list-style-type: none"> • Corrosion(install new adapting piece or terminal-cleaning module and pin). • Pin damaged or bent-install new terminal/pin. 4 Fly out of pins-install new pins as needed. 5 Reconnect the CDU plug and all other previously disconnected plug. Make sure the pin is properly positioned and fixed. 6 Run the system and determine if the problem persists?
	YES → Change the CDU Module
NO ↓	
At this point the system is functioning normally. The problem may be caused by module connections. Address the root cause of any connector or pin problems.	
Next Step ↓	
Diagnosis end.	

P1F14-00

Fault diagnosis code
P1F14-00: DCDC temperature 4 over temperature (LV output PCB)
Detection tools
1 Multimeter and diagnostic apparatus
Possible causes
<ul style="list-style-type: none">• Circuit,terminal and adapting piece fault• Cooling system fault• The DCDC of CDU fault
Conditions for fault code operation
Turn the ignition switch to ON position.
Conditions for fault code setting
P1F14-00
Temperature greater than 95 °C for 3 seconds
To set the effect of a fault code condition
DCDC stops power output
Description of circuit diagram

Circuit diagram

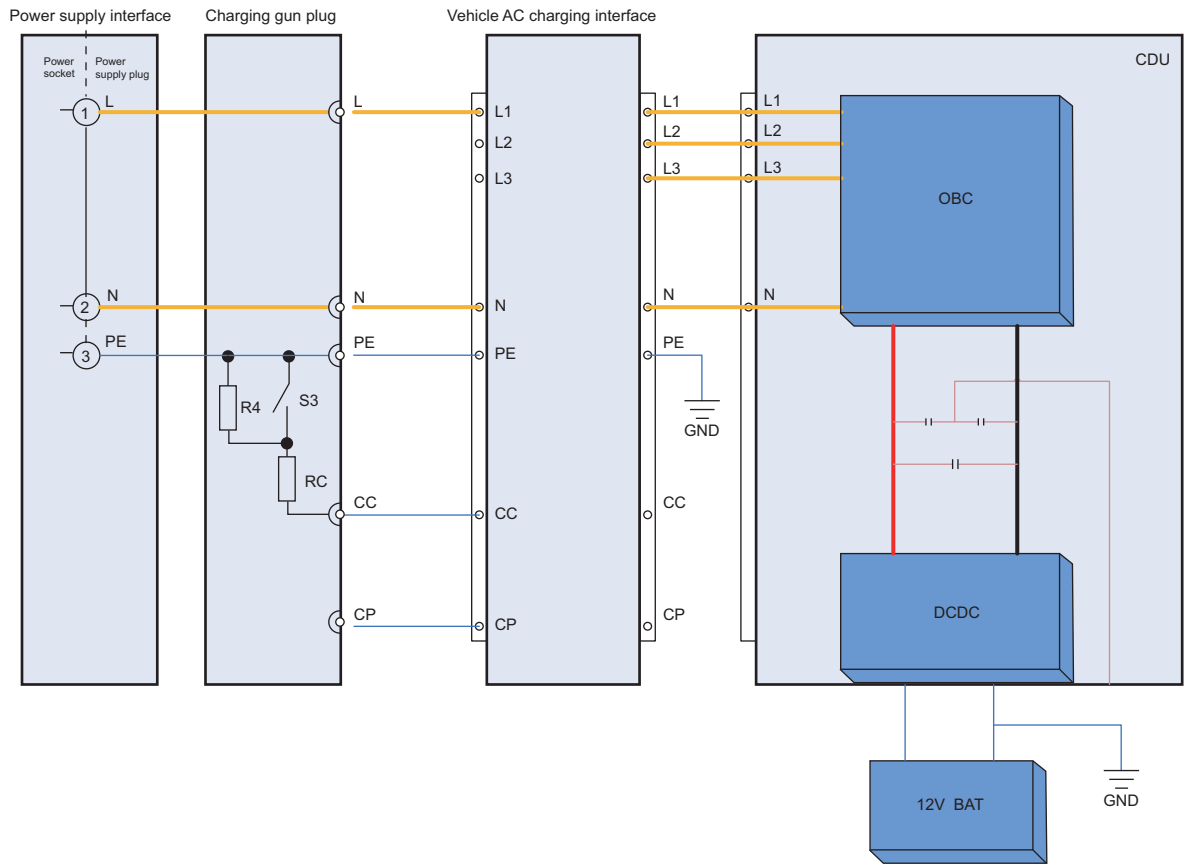

AC charging gun interface AC charging gun plug

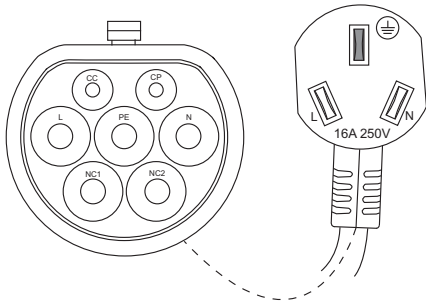

Vehicle AC charging interface

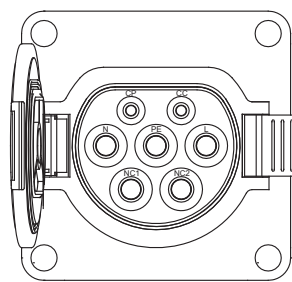

EK894015

Troubleshooting steps	
Step 1	General inspection.
	<ol style="list-style-type: none"> 1 Check the fuse for damage. 2 Check battery capacity. 3 Check the harness plug of CDU for damage, poor contact, aging and looseness. 4 Check whether the result is normal or not?
	NO → Repair or replace the faulted parts.
YES ↓	
Step 2	Check fault codes.
	<ol style="list-style-type: none"> 1 Connect the fault diagnosis instrument to the diagnosis interface. 2 Turn the ignition switch to ON position. 3 Diagnose the CDU module with diagnostic apparatus. 4 Is there any other fault code except for P1F14-00?
	YES → Refer to: DTC Summary list(CDU) .
NO ↓	
Step 3	Check cooling system.
	<ol style="list-style-type: none"> 1 Check whether there is leakage or poor heat dissipation in the cooling system. 2 Check whether the result is normal or not?
	NO → Repair the cooling system.
YES ↓	
Step 4	Check the connecting cable of CDU.
	<ol style="list-style-type: none"> 1 Turn the ignition switch to OFF. 2 Make protective preparations according to the safety operation specifications of the high voltage voltage in the maintenance manual. 3 Disconnect the harness plug battery pack high voltage. 4 Disconnect the high voltage harness plug of CDU. 5 Check whether the CDU connection cable is rotten, damaged, and water enters. 6 Check whether the result is normal or not?
	NO → Repair or replace the faulted parts.
YES ↓	

CDU

Step 5	Check CDU internal circuit.
	<ol style="list-style-type: none"> 1 Turn the ignition switch to OFF. 2 Make protective preparations according to the safety operation specifications of the high voltage voltage in the maintenance manual. 3 Open the CDU end cover. 4 Check CDU internal circuit. 5 Check whether the result is normal or not?
	NO → Repair or replace the faulted parts.
YES ↓	
Step 6	Test whether CDU is norm.
	<ol style="list-style-type: none"> 1 Turn the ignition switch to OFF. 2 Disconnect and check the harness plug BT14、 BT15 of CDU. 3 Check and repair. <ul style="list-style-type: none"> • Corrosion(install new adapting piece or terminal-cleaning module and pin). • Pin damaged or bent-install new terminal/pin. 4 Fly out of pins-install new pins as needed. 5 Reconnect the CDU plug and all other previously disconnected plug. Make sure the pin is properly positioned and fixed. 6 Run the system and determine if the problem persists?
	YES → Change the CDU Module
NO ↓	
At this point the system is functioning normally. The problem may be caused by module connections. Address the root cause of any connector or pin problems.	
Next Step ↓	
Diagnosis end.	

P1F15-00

Fault diagnosis code
P1F15-00: CDU Bronze temperature over temperature
Detection tools
1 Multimeter and diagnostic apparatus
Possible causes
<ul style="list-style-type: none">• Circuit,terminal and adapting piece fault• Cooling system fault• The bronze circuit of CDU
Conditions for fault code operation
Turn the ignition switch to ON position.
Conditions for fault code setting
P1F15-00
Temperature greater than 120 °C for 3 seconds
To set the effect of a fault code condition
OBC stops power output, inverter stops power output, DCDC stops power output
Description of circuit diagram

Circuit diagram

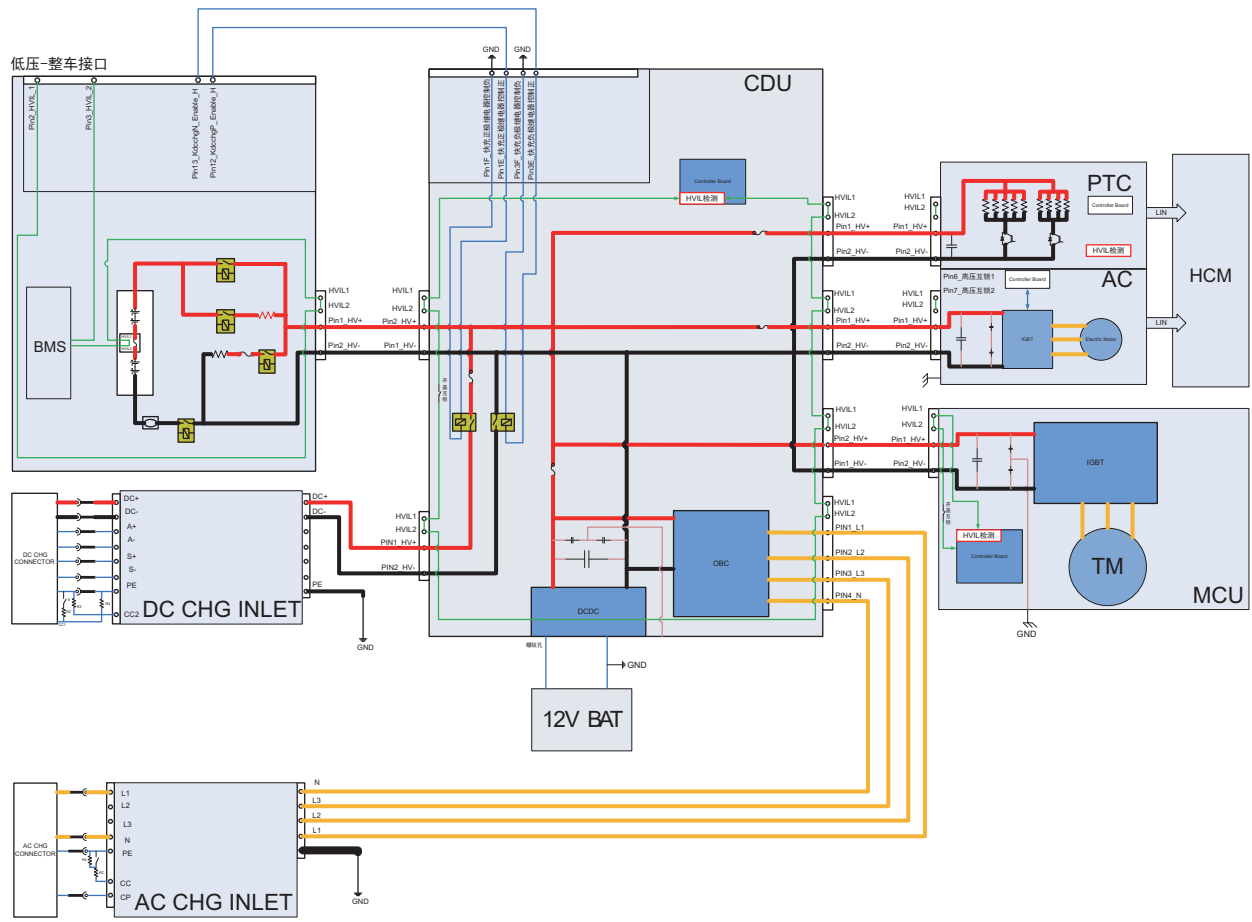

EK894014

Troubleshooting steps	
Step 1	General inspection.
	<ol style="list-style-type: none"> 1 Check the fuse for damage. 2 Check battery capacity. 3 Check the harness plug of CDU for damage, poor contact, aging and looseness. 4 Check whether the result is normal or not?
	NO → Repair or replace the faulted parts.
YES ↓	
Step 2	Check fault codes.
	<ol style="list-style-type: none"> 1 Connect the fault diagnosis instrument to the diagnosis interface. 2 Turn the ignition switch to ON position. 3 Diagnose the CDU module with diagnostic apparatus. 4 Is there any other fault code except for P1F15-00?
	YES → Refer to: DTC Summary list(CDU) .
NO ↓	
Step 3	Check cooling system.
	<ol style="list-style-type: none"> 1 Check whether there is leakage or poor heat dissipation in the cooling system. 2 Check whether the result is normal or not?
	NO → Repair the cooling system.
YES ↓	
Step 4	Check the connecting cable of CDU.
	<ol style="list-style-type: none"> 1 Turn the ignition switch to OFF. 2 Make protective preparations according to the safety operation specifications of the high voltage voltage in the maintenance manual. 3 Disconnect the harness plug battery pack high voltage. 4 Disconnect the high voltage harness plug of CDU. 5 Check whether the CDU connection cable is rotten, damaged, and water enters. 6 Check whether the result is normal or not?
	NO → Repair or replace the faulted parts.
YES ↓	

CDU

Step 5	Check CDU internal circuit.
	<ol style="list-style-type: none"> 1 Turn the ignition switch to OFF. 2 Make protective preparations according to the safety operation specifications of the high voltage voltage in the maintenance manual. 3 Open the CDU end cover. 4 Check CDU internal circuit. 5 Check whether the result is normal or not?
	NO → Repair or replace the faulted parts.
YES ↓	
Step 6	Test whether CDU is norm.
	<ol style="list-style-type: none"> 1 Turn the ignition switch to OFF. 2 Disconnect and check the harness plug BT14、 BT15 of CDU. 3 Check and repair. <ul style="list-style-type: none"> • Corrosion(install new adapting piece or terminal-cleaning module and pin). • Pin damaged or bent-install new terminal/pin. 4 Fly out of pins-install new pins as needed. 5 Reconnect the CDU plug and all other previously disconnected plug. Make sure the pin is properly positioned and fixed. 6 Run the system and determine if the problem persists?
	YES → Change the CDU Module
NO ↓	
At this point the system is functioning normally. The problem may be caused by module connections. Address the root cause of any connector or pin problems.	
Next Step ↓	
Diagnosis end.	

P1F05-00

Fault diagnosis code
P1F05-00: Chamber temperature overtemperature
Detection tools
1 Multimeter and diagnostic apparatus
Possible causes
<ul style="list-style-type: none">• Circuit,terminal and adapting piece fault• Cooling system fault• The Chamber temperature of CDU fault
Conditions for fault code operation
Turn the ignition switch to ON position.
Conditions for fault code setting
P1F05-00
Temperature greater than 115 °C for 3 seconds
To set the effect of a fault code condition
OBC stops power output, inverter stops power output, DCDC stops power output
Description of circuit diagram

Circuit diagram

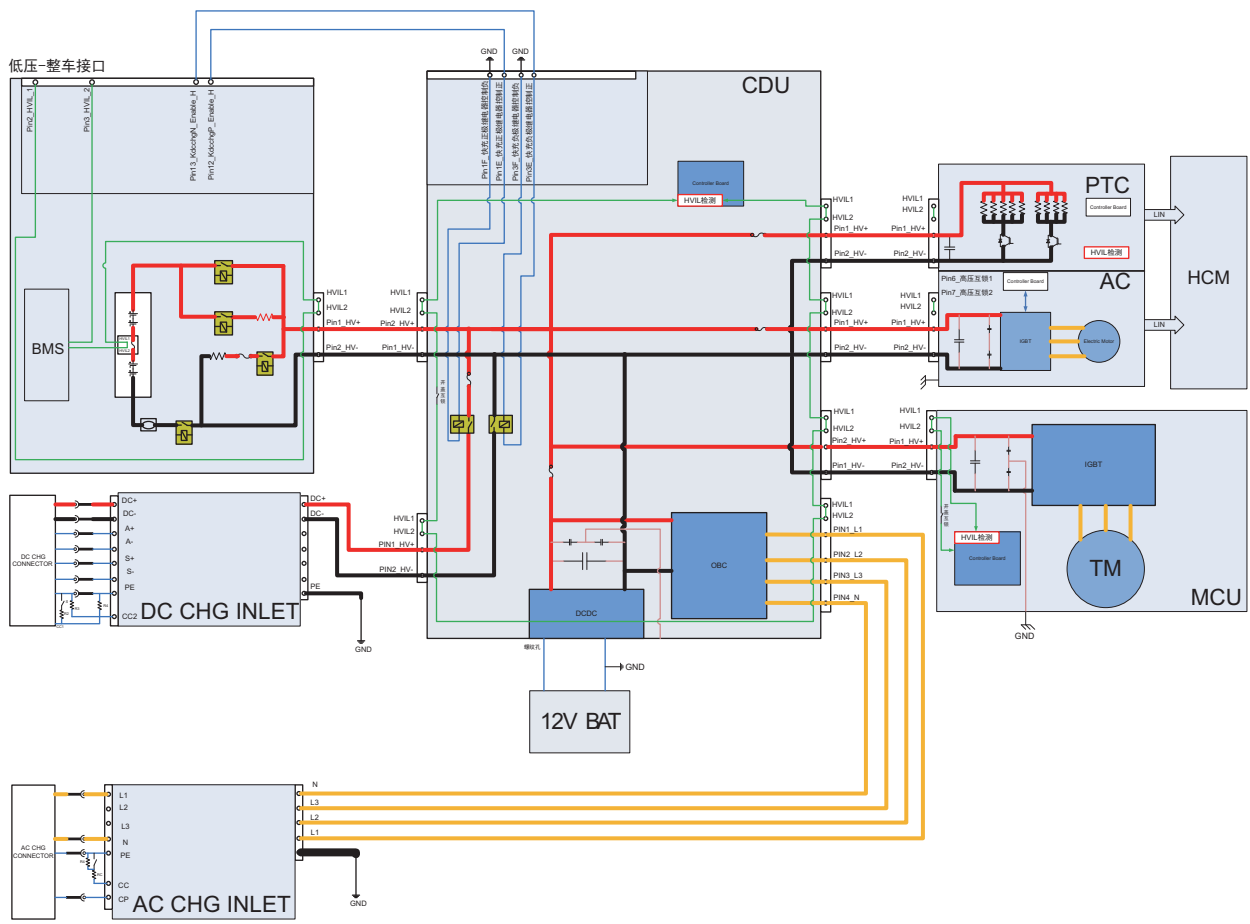

EK894014

Troubleshooting steps	
Step 1	General inspection.
	<ol style="list-style-type: none"> 1 Check the fuse for damage. 2 Check battery capacity. 3 Check the harness plug of CDU for damage, poor contact, aging and looseness. 4 Check whether the result is normal or not?
	NO → Repair or replace the faulted parts.
YES ↓	
Step 2	Check fault codes.
	<ol style="list-style-type: none"> 1 Connect the fault diagnosis instrument to the diagnosis interface. 2 Turn the ignition switch to ON position. 3 Diagnose the CDU module with diagnostic apparatus. 4 Is there any other fault code except for P1F05-00?
	YES → Refer to: DTC Summary list(CDU) .
NO ↓	
Step 3	Check cooling system.
	<ol style="list-style-type: none"> 1 Check whether there is leakage or poor heat dissipation in the cooling system. 2 Check whether the result is normal or not?
	NO → Repair the cooling system.
YES ↓	
Step 4	Check the connecting cable of CDU.
	<ol style="list-style-type: none"> 1 Turn the ignition switch to OFF. 2 Make protective preparations according to the safety operation specifications of the high voltage voltage in the maintenance manual. 3 Disconnect the harness plug battery pack high voltage. 4 Disconnect the high voltage harness plug of CDU. 5 Check whether the CDU connection cable is rotten, damaged, and water enters. 6 Check whether the result is normal or not?
	NO → Repair or replace the faulted parts.
YES ↓	

CDU

Step 5	Check CDU internal circuit.
	<ol style="list-style-type: none"> 1 Turn the ignition switch to OFF. 2 Make protective preparations according to the safety operation specifications of the high voltage voltage in the maintenance manual. 3 Open the CDU end cover. 4 Check CDU internal circuit. 5 Check whether the result is normal or not?
	NO → Repair or replace the faulted parts.
YES ↓	
Step 6	Test whether CDU is norm.
	<ol style="list-style-type: none"> 1 Turn the ignition switch to OFF. 2 Disconnect and check the harness plug BT14、 BT15 of CDU. 3 Check and repair. <ul style="list-style-type: none"> • Corrosion(install new adapting piece or terminal-cleaning module and pin). • Pin damaged or bent-install new terminal/pin. 4 Fly out of pins-install new pins as needed. 5 Reconnect the CDU plug and all other previously disconnected plug. Make sure the pin is properly positioned and fixed. 6 Run the system and determine if the problem persists?
	YES → Change the CDU Module
NO ↓	
At this point the system is functioning normally. The problem may be caused by module connections. Address the root cause of any connector or pin problems.	
Next Step ↓	
Diagnosis end.	

P1F07-00、 P1F08-00、 P1F06-F0、 P0EA6-F0

Fault diagnosis code
P1F07-00: Low temperature protection of internal ambient temperature
P1F08-00: The internal environment slowly rises
P1F06-F0: OBC temperature drop power
P0EA6-F0: DCDC temperature drop power
Detection tools
1 Multimeter and diagnostic apparatus
Possible causes
<ul style="list-style-type: none"> • Circuit,terminal and adapting piece fault • Cooling system fault • Ambient temperature is too low • The ambient temperature of CDU fault
Conditions for fault code operation
Turn the ignition switch to ON position.
Conditions for fault code setting
P1F07-00
Temperature less than -40 °C for 3 seconds
P1F06-F0
<p>1. PFC temperature 1 is greater than 90 °C (power decreases by 10% for every 1 °C increase)</p> <p>2.If PFC temperature 2 is greater than 105 °C (single-phase charging) or 90 °C (three-phase charging), the power will decrease by 10% for every 1 °C increase</p> <p>3. PFC temperature 3 is greater than 90 °C (power decreases by 10% for every 1 °C increase)</p> <p>4. LLC temperature 1 is greater than 90 °C (single-phase charging) or 100 °C (three-phase charging) (power decreases by 10% for every 1 °C increase)</p> <p>5. LLC temperature 2 is greater than 90 °C (single-phase charging) or 100 °C (three-phase charging) (power decreases by 10% for every 1 °C increase)</p> <p>6. LLC temperature 3 is greater than 90 °C (single-phase charging) or 100 °C (three-phase charging) (power decreases by 10% for every 1 °C increase)</p> <p>7. LLC temperature 4 is greater than 90 °C (single-phase charging) or 105 °C (three-phase charging) (power decreases by 10% for every 1 °C increase)</p> <p>8. DCDC temperature 3 (water channel) greater than 65 °C (power decreases by 6% for every 1 °C increase)</p> <p>9. Chamber temperature greater than 85 °C (single-phase charging) or greater than 100 °C (three-phase charging) (power decreases by 10% for every 1 °C increase)</p> <p>Any temperature reaching the derating point above will cause the OBC output power to decrease. If multiple temperatures reach the derating point, the OBC output power will be reduced according to the maximum derating among them</p>

P0EA6-F0
<ol style="list-style-type: none">1. DCDC temperature 1 is greater than 90 °C2. DCDC temperature 2 is greater than 90 °C3. DCDC temperature 3 (water channel) greater than 65 °C4. DCDC temperature 4 is greater than 85 °C <p>Derating coefficient 0.82</p> <p>Reaching the derating point at any of the above temperatures will result in a reduction in DCDC output power. If multiple temperatures reach the derating point, the DCDC output power will be reduced according to the maximum derating among them</p>
To set the effect of a fault code condition
OBC stops power output, inverter stops power output
Description of circuit diagram

Circuit diagram

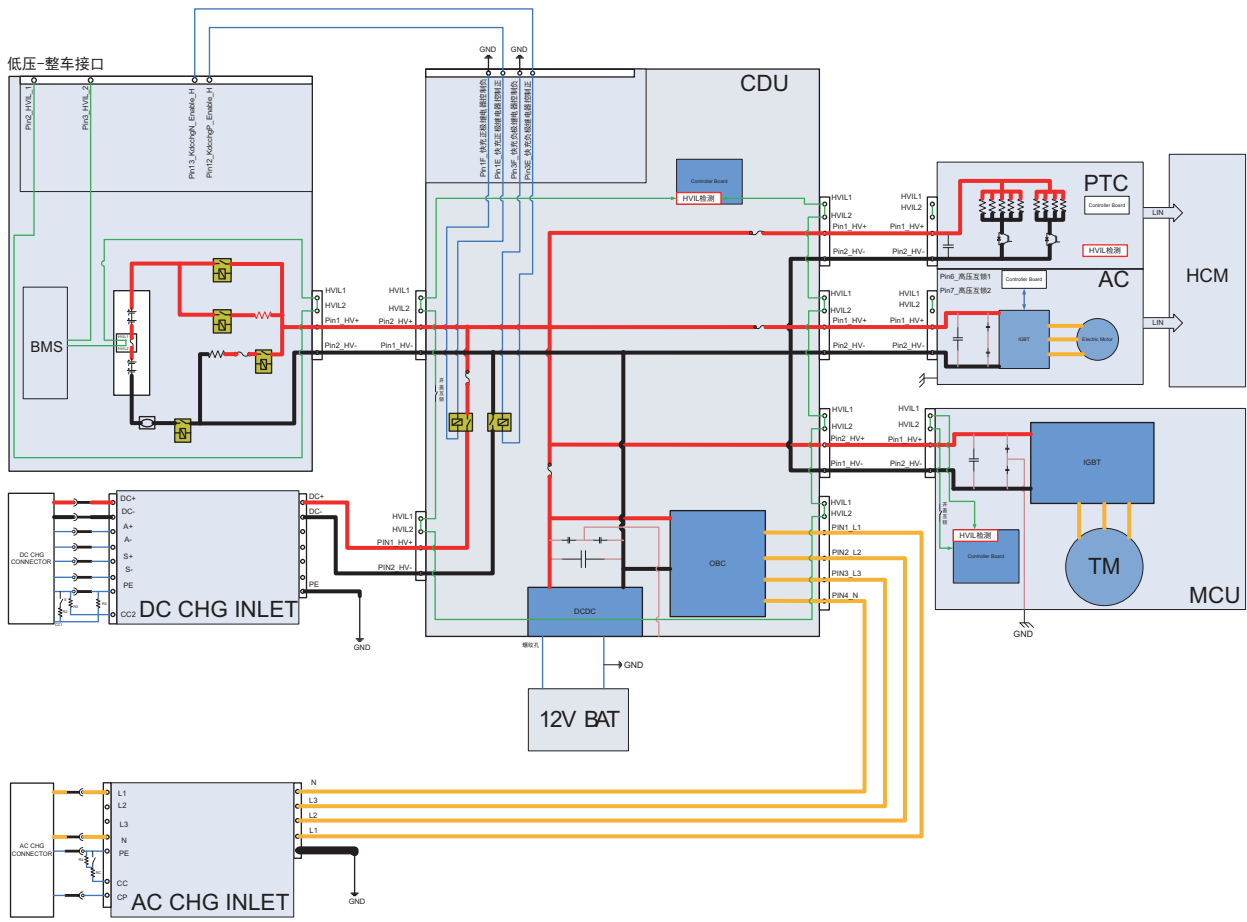

EK894014

Troubleshooting steps	
Step 1	General inspection.
	<ol style="list-style-type: none"> 1 Check the fuse for damage. 2 Check battery capacity. 3 Check the harness plug of CDU for damage, poor contact, aging and looseness. 4 Check whether the result is normal or not?
	NO → Repair or replace the faulted parts.
YES ↓	
Step 2	Check fault codes.
	<ol style="list-style-type: none"> 1 Connect the fault diagnosis instrument to the diagnosis interface. 2 Turn the ignition switch to ON position. 3 Diagnose the CDU module with diagnostic apparatus. 4 Is there any other fault code except for P1F07-00、P1F08-00、P1F06-F0、P0EA6-F0?
	YES → Refer to: DTC Summary list(CDU) .
NO ↓	
Step 3	Check the ambient temperature.
	<ol style="list-style-type: none"> 1 Check whether the ambient temperature is significantly lower than the rated operating temperature of the high-pressure system. 2 Check whether the result is normal or not?
	NO → It is judged to be caused by extreme temperature environment, and DTC will be checked when the temperature recovers.
YES ↓	
Step 4	Check preheating system(if equipped).
	<ol style="list-style-type: none"> 1 Check whether the preheating system is normal. 2 Check whether the result is normal or not?
	NO → Repair the preheating system.
YES ↓	

Step 5	Check the connecting cable of CDU.
	<ol style="list-style-type: none"> 1 Turn the ignition switch to OFF. 2 Make protective preparations according to the safety operation specifications of the high voltage voltage in the maintenance manual. 3 Disconnect the harness plug battery pack high voltage. 4 Disconnect the high voltage harness plug of CDU. 5 Check whether the CDU connection cable is rotten, damaged, and water enters. 6 Check whether the result is normal or not?
	NO → Repair or replace the faulted parts.
YES ↓	
Step 6	Check CDU internal circuit.
	<ol style="list-style-type: none"> 1 Turn the ignition switch to OFF. 2 Make protective preparations according to the safety operation specifications of the high voltage voltage in the maintenance manual. 3 Open the CDU end cover. 4 Check CDU internal circuit. 5 Check whether the result is normal or not?
	NO → Repair or replace the faulted parts.
YES ↓	
Step 7	Test whether CDU is norm.
	<ol style="list-style-type: none"> 1 Turn the ignition switch to OFF. 2 Disconnect and check the harness plug BT14、 BT15 of CDU. 3 Check and repair. <ul style="list-style-type: none"> • Corrosion(install new adapting piece or terminal-cleaning module and pin). • Pin damaged or bent-install new terminal/pin. 4 Fly out of pins-install new pins as needed. 5 Reconnect the CDU plug and all other previously disconnected plug. Make sure the pin is properly positioned and fixed. 6 Run the system and determine if the problem persists?
	YES → Change the CDU Module
NO ↓	
At this point the system is functioning normally. The problem may be caused by module connections. Address the root cause of any connector or pin problems.	

CDU

Next Step ↓
Diagnosis end.

P1F0D-00

Fault diagnosis code
P1F0D-00: EEPROM failure
Detection tools
1 Multimeter and diagnostic apparatus
Possible causes
<ul style="list-style-type: none">• Circuit,terminal and adapting piece fault• Software fault• CDU fault
Conditions for fault code operation
Turn the ignition switch to ON position.
Conditions for fault code setting
P1F0D-00
EEPROM reading and writing data failed
To set the effect of a fault code condition
Only record fault codes without affecting power output
Description of circuit diagram

Troubleshooting steps	
Step 1	General inspection.
	<ol style="list-style-type: none"> 1 Check the fuse for damage. 2 Check battery capacity. 3 Check the harness plug of CDU for damage, poor contact, aging and looseness. 4 Check whether the result is normal or not?
	NO → Repair or replace the faulted parts.
YES ↓	
Step 2	Check fault codes.
	<ol style="list-style-type: none"> 1 Connect the fault diagnosis instrument to the diagnosis interface. 2 Turn the ignition switch to ON position. 3 Diagnose the CDU module with diagnostic apparatus. 4 Is there any other fault code except for P1F0D-00?
	YES → Refer to: DTC Summary list(CDU) .
NO ↓	
Step 3	Perform initialization.
	<ol style="list-style-type: none"> 1 Turn the ignition switch to OFF. 2 Connect the fault diagnosis instrument to the diagnosis interface. 3 Turn the ignition switch to ON. 4 The CDU module was initialized with the diagnostic instrument. 5 Can the CDU be initialized and is the CDU restored?
	NO → Repair or change the CDU control module.
YES ↓	
Step 4	Check the connecting cable of CDU.
	<ol style="list-style-type: none"> 1 Turn the ignition switch to OFF. 2 Make protective preparations according to the safety operation specifications of the high voltage voltage in the maintenance manual. 3 Disconnect the harness plug battery pack high voltage. 4 Disconnect the high voltage harness plug of CDU. 5 Check whether the CDU connection cable is rotten, damaged, and water enters. 6 Check whether the result is normal or not?

		NO → Repair or replace the faulted parts.
YES ↓		
Step 5	Check CDU internal circuit.	
		<ol style="list-style-type: none"> 1 Turn the ignition switch to OFF. 2 Make protective preparations according to the safety operation specifications of the high voltage voltage in the maintenance manual. 3 Open the CDU end cover. 4 Check CDU internal circuit. 5 Check whether the result is normal or not?
		NO → Repair or replace the faulted parts.
YES ↓		
Step 6	Test whether CDU is norm.	
		<ol style="list-style-type: none"> 1 Turn the ignition switch to OFF. 2 Disconnect and check the harness plug BT14、 BT15 of CDU. 3 Check and repair. <ul style="list-style-type: none"> • Corrosion(install new adapting piece or terminal-cleaning module and pin). • Pin damaged or bent-install new terminal/pin. 4 Fly out of pins-install new pins as needed. 5 Reconnect the CDU plug and all other previously disconnected plug. Make sure the pin is properly positioned and fixed. 6 Run the system and determine if the problem persists?
		YES → Change the CDU Module
NO ↓		
At this point the system is functioning normally. The problem may be caused by module connections. Address the root cause of any connector or pin problems.		
Next Step ↓		
Diagnosis end.		

P1F16-00

Fault diagnosis code
P1F16-00: Power battery output high voltage interlock failure
Detection tools
1 Multimeter and diagnostic apparatus
Possible causes
<ul style="list-style-type: none"> • Circuit, terminal and adapting piece fault • High voltage interlock circuit fault
Conditions for fault code operation
Turn the ignition switch to ON position.
Conditions for fault code setting
P1F16-00
Detected disconnection of high-voltage interlock signal for 100ms
To set the effect of a fault code condition
OBC stops power output, inverter stops power output, DCDC stops power output
Description of circuit diagram

Circuit diagram

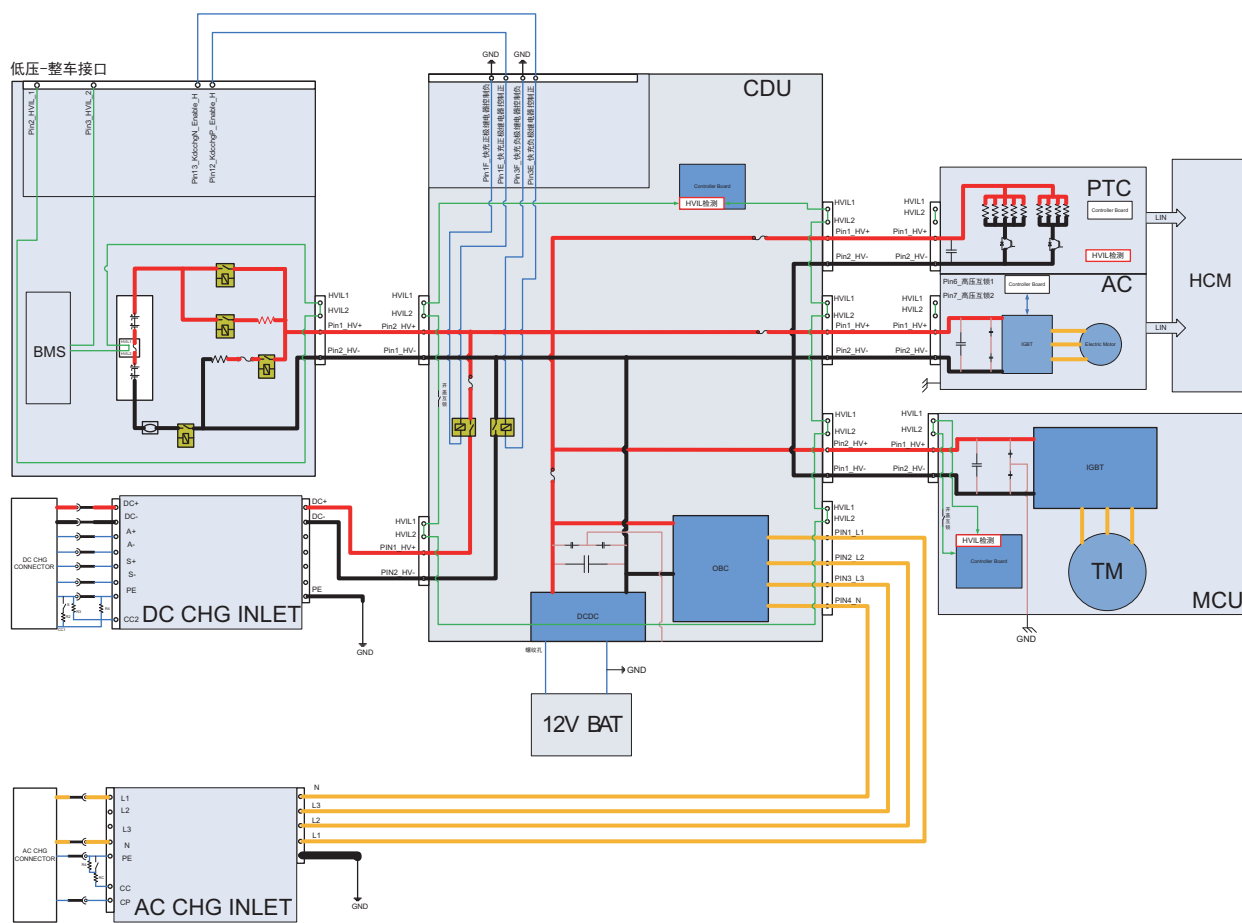

EK894014

Troubleshooting steps	
Step 1	General inspection.
	<ol style="list-style-type: none"> 1 Check the fuse for damage. 2 Check battery capacity. 3 Check the harness plug of CDU for damage, poor contact, aging and looseness. 4 Check whether the result is normal or not?
	NO → Repair or replace the faulted parts.
YES ↓	
Step 2	Check fault codes.
	<ol style="list-style-type: none"> 1 Connect the fault diagnosis instrument to the diagnosis interface. 2 Turn the ignition switch to ON position. 3 Diagnose the CDU module with diagnostic apparatus. 4 Is there any other fault code except for P1F16-00?
	YES → Refer to: DTC Summary list(CDU) .
NO ↓	
Step 3	Check battery pack high-voltage interlock of CDU.
	<ol style="list-style-type: none"> 1 Turn the ignition switch to OFF. 2 Make protective preparations according to the safety operation specifications of the high voltage voltage in the maintenance manual. 3 Disconnect the harness plug battery pack high voltage. 4 Disconnect the harness plug battery pack high voltage of CDU. 5 Check whether the CDU connection cable is rotten, damaged, and water enters. 6 Check whether the interlock circuit of CDU battery pack high-voltage exist the situation of open or short circuit. 7 Check whether the result is normal or not?
	NO → Repair or replace the faulted parts.
YES ↓	

Step 4	Check battery pack high-voltage interlock circuit.	
		<ol style="list-style-type: none"> 1 Turn the ignition switch to OFF. 2 Make protective preparations according to the safety operation specifications of the high voltage voltage in the maintenance manual. 3 Disconnect the harness plug battery pack high voltage. 4 Disconnect the harness plug battery pack high voltage of CDU. 5 Check whether the battery pack high-voltage interlock circuit is open. 6 Check whether the result is normal or not?
		NO → Repair or replace the faulted parts.
YES ↓		
Step 5	Check battery pack high-voltage cable interlock circuit.	
		<ol style="list-style-type: none"> 1 Turn the ignition switch to OFF. 2 Make protective preparations according to the safety operation specifications of the high voltage voltage in the maintenance manual. 3 Disconnect the harness plug battery pack high voltage. 4 Check whether the interlock circuit of high-voltage cable exist the situation of open or short circuit. 5 Check whether the result is normal or not?
		NO → Repair or replace the faulted parts.
YES ↓		
Step 6	Check CDU internal circuit.	
		<ol style="list-style-type: none"> 1 Turn the ignition switch to OFF. 2 Make protective preparations according to the safety operation specifications of the high voltage voltage in the maintenance manual. 3 Open the CDU end cover. 4 Check CDU internal circuit. 5 Check whether the result is normal or not?
		NO → Repair or replace the faulted parts.
YES ↓		

CDU

Step 7	Test whether CDU is norm.
	<ol style="list-style-type: none"> 1 Turn the ignition switch to OFF. 2 Disconnect and check the harness plug BT14、 BT15 of CDU. 3 Check and repair. <ul style="list-style-type: none"> • Corrosion(install new adapting piece or terminal-cleaning module and pin). • Pin damaged or bent-install new terminal/pin. 4 Fly out of pins-install new pins as needed. 5 Reconnect the CDU plug and all other previously disconnected plug. Make sure the pin is properly positioned and fixed. 6 Run the system and determine if the problem persists?
	YES → Change the CDU Module
NO ↓	
At this point the system is functioning normally. The problem may be caused by module connections. Address the root cause of any connector or pin problems.	
Next Step ↓	
Diagnosis end.	

P1F17-00

Fault diagnosis code
P1F17-00: PTC high voltage interlock failure
Detection tools
1 Multimeter and diagnostic apparatus
Possible causes
<ul style="list-style-type: none">• Circuit, terminal and adapting piece fault• High voltage interlock circuit fault
Conditions for fault code operation
Turn the ignition switch to ON position.
Conditions for fault code setting
P1F17-00
Detected disconnection of high-voltage interlock signal for 100ms
To set the effect of a fault code condition
OBC stops power output, inverter stops power output, DCDC stops power output
Description of circuit diagram

Circuit diagram

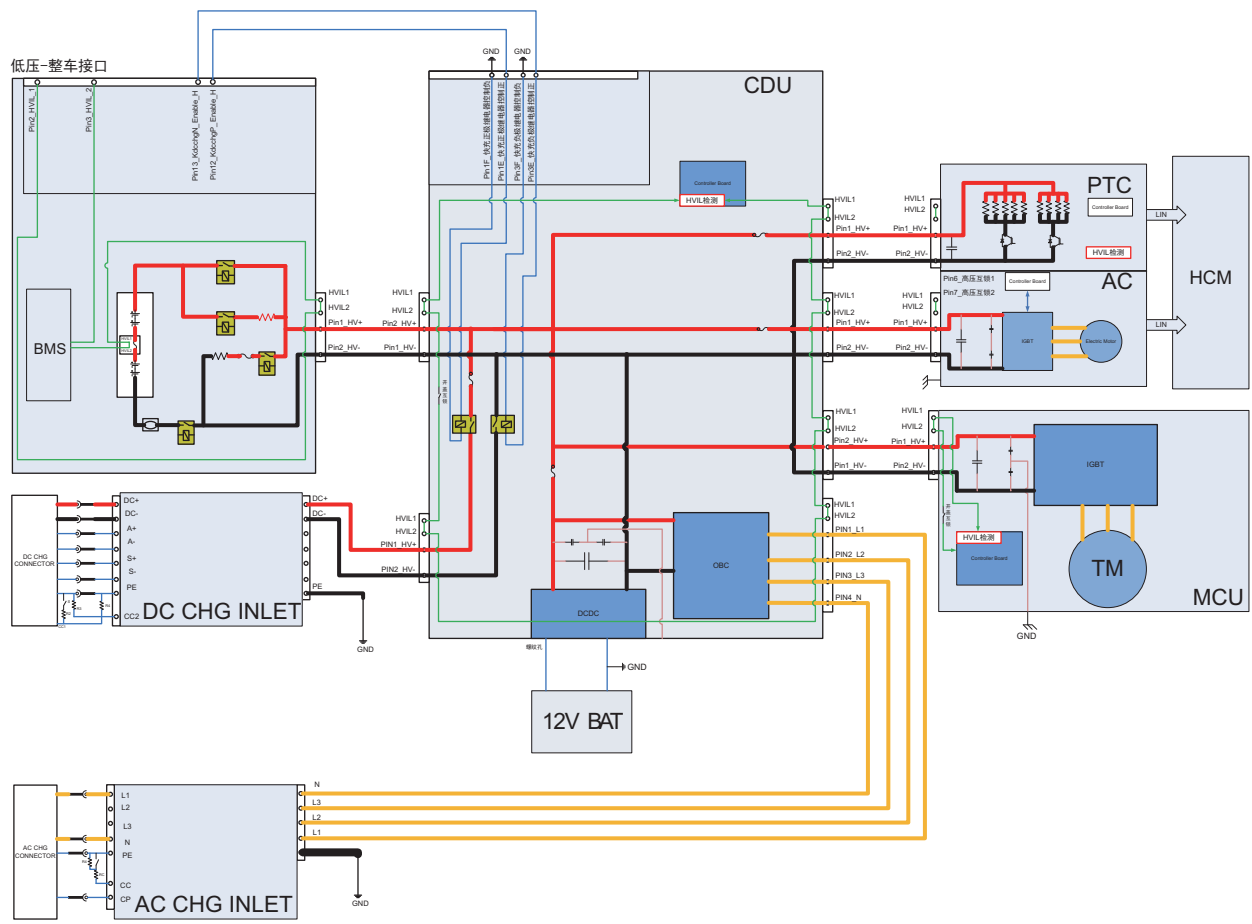

EK894014

Troubleshooting steps	
Step 1	General inspection.
	<ol style="list-style-type: none"> 1 Check the fuse for damage. 2 Check battery capacity. 3 Check the harness plug of CDU for damage, poor contact, aging and looseness. 4 Check whether the result is normal or not?
	NO → Repair or replace the faulted parts.
YES ↓	
Step 2	Check fault codes.
	<ol style="list-style-type: none"> 1 Connect the fault diagnosis instrument to the diagnosis interface. 2 Turn the ignition switch to ON position. 3 Diagnose the CDU module with diagnostic apparatus. 4 Is there any other fault code except for P1F17-00?
	YES → Refer to: DTC Summary list(CDU) .
NO ↓	
Step 3	Check PTC high-voltage interlock circuit of CDU.
	<ol style="list-style-type: none"> 1 Turn the ignition switch to OFF. 2 Make protective preparations according to the safety operation specifications of the high voltage voltage in the maintenance manual. 3 Disconnect the harness plug battery pack high voltage. 4 Disconnect the PTC high voltage harness plug of CDU. 5 Check whether the CDU connection cable is rotten, damaged, and water enters. 6 Check whether the PTC interlock circuit of CDU high-voltage exist the situation of open or short circuit. 7 Check whether the result is normal or not?
	NO → Repair or replace the faulted parts.
YES ↓	

CDU

Step 4	Check PTC high-voltage cable interlock circuit.
	<ol style="list-style-type: none"> 1 Turn the ignition switch to OFF. 2 Make protective preparations according to the safety operation specifications of the high voltage voltage in the maintenance manual. 3 Disconnect the PTC high voltage harness plug of CDU. 4 Disconnect the PTC high voltage harness plug of PTC. 5 Check whether the PTC high-voltage cable interlock circuit is open. 6 Check whether the result is normal or not?
	NO → Repair or replace the faulted parts.
YES ↓	
Step 5	Check PTC high-voltage interlock circuit of PTC.
	<ol style="list-style-type: none"> 1 Turn the ignition switch to OFF. 2 Make protective preparations according to the safety operation specifications of the high voltage voltage in the maintenance manual. 3 Disconnect the high voltage harness plug of PTC. 4 Check whether the interlock circuit of PTC high-voltage exist the situation of open or short circuit. 5 Check whether the result is normal or not?
	NO → Repair or replace the faulted parts.
YES ↓	
Step 6	Check CDU internal circuit.
	<ol style="list-style-type: none"> 1 Turn the ignition switch to OFF. 2 Make protective preparations according to the safety operation specifications of the high voltage voltage in the maintenance manual. 3 Open the CDU end cover. 4 Check CDU internal circuit. 5 Check whether the result is normal or not?
	NO → Repair or replace the faulted parts.
YES ↓	

Step 7	Test whether CDU is norm.
	<ol style="list-style-type: none"> 1 Turn the ignition switch to OFF. 2 Disconnect and check the harness plug BT14、 BT15 of CDU. 3 Check and repair. <ul style="list-style-type: none"> • Corrosion(install new adapting piece or terminal-cleaning module and pin). • Pin damaged or bent-install new terminal/pin. 4 Fly out of pins-install new pins as needed. 5 Reconnect the CDU plug and all other previously disconnected plug. Make sure the pin is properly positioned and fixed. 6 Run the system and determine if the problem persists?
	YES → Change the CDU Module
NO ↓	
At this point the system is functioning normally. The problem may be caused by module connections. Address the root cause of any connector or pin problems.	
Next Step ↓	
Diagnosis end.	

P1F18-00

Fault diagnosis code
P1F18-00: Air conditioner compressor high pressure interlock failure
Detection tools
1 Multimeter and diagnostic apparatus
Possible causes
<ul style="list-style-type: none"> • Circuit, terminal and adapting piece fault • High voltage interlock circuit fault
Conditions for fault code operation
Turn the ignition switch to ON position.
Conditions for fault code setting
P1F18-00
Detected disconnection of high-voltage interlock signal for 100ms
To set the effect of a fault code condition
OBC stops power output, inverter stops power output, DCDC stops power output
Description of circuit diagram

Circuit diagram

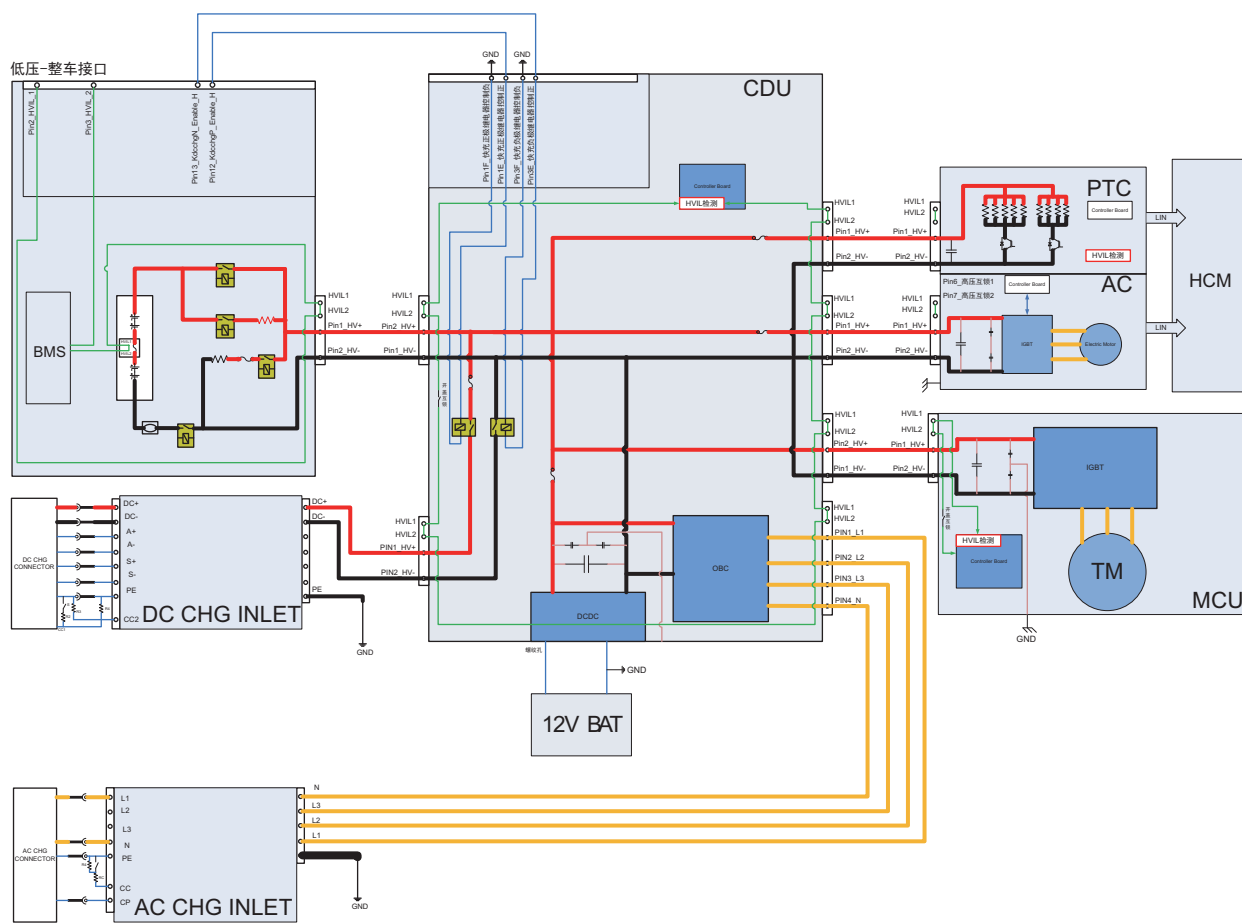

EK894014

Troubleshooting steps	
Step 1	General inspection.
	<ol style="list-style-type: none"> 1 Check the fuse for damage. 2 Check battery capacity. 3 Check the harness plug of CDU for damage, poor contact, aging and looseness. 4 Check whether the result is normal or not?
	NO → Repair or replace the faulted parts.
YES ↓	
Step 2	Check fault codes.
	<ol style="list-style-type: none"> 1 Connect the fault diagnosis instrument to the diagnosis interface. 2 Turn the ignition switch to ON position. 3 Diagnose the CDU module with diagnostic apparatus. 4 Is there any other fault code except for P1F18-00?
	YES → Refer to: DTC Summary list(CDU) .
NO ↓	
Step 3	Check air conditioner compressor high-voltage interlock circuit of CDU.
	<ol style="list-style-type: none"> 1 Turn the ignition switch to OFF. 2 Make protective preparations according to the safety operation specifications of the high voltage voltage in the maintenance manual. 3 Disconnect the harness plug battery pack high voltage. 4 Disconnect air conditioner compressor high-voltage interlock circuit of CDU. 5 Check whether the CDU connection cable is rotten, damaged, and water enters. 6 Check whether the interlock circuit of air conditioner compressor high-voltage exist the situation of open or short circuit. 7 Check whether the result is normal or not?
	NO → Repair or replace the faulted parts.
YES ↓	

Step 4	Check air conditioner compressor high-voltage interlock circuit.	
		<ol style="list-style-type: none"> 1 Turn the ignition switch to OFF. 2 Make protective preparations according to the safety operation specifications of the high voltage voltage in the maintenance manual. 3 Disconnect air conditioner compressor high-voltage interlock circuit of CDU. 4 Disconnect air conditioner compressor high-voltage interlock circuit. 5 Check whether the air conditioner compressor high-voltage interlock circuit is open. 6 Check whether the result is normal or not?
		NO → Repair or replace the faulted parts.
YES ↓		
Step 5	Check air conditioner compressor high-voltage cable interlock circuit.	
		<ol style="list-style-type: none"> 1 Turn the ignition switch to OFF. 2 Make protective preparations according to the safety operation specifications of the high voltage voltage in the maintenance manual. 3 Disconnect air conditioner compressor high-voltage harness plug. 4 Check whether the interlock circuit of air conditioner compressor high-voltage exist the situation of open or short circuit. 5 Check whether the result is normal or not?
		NO → Repair or replace the faulted parts.
YES ↓		
Step 6	Check CDU internal circuit.	
		<ol style="list-style-type: none"> 1 Turn the ignition switch to OFF. 2 Make protective preparations according to the safety operation specifications of the high voltage voltage in the maintenance manual. 3 Open the CDU end cover. 4 Check CDU internal circuit. 5 Check whether the result is normal or not?
		NO → Repair or replace the faulted parts.
YES ↓		

CDU

Step 7	Test whether CDU is norm.
	<ol style="list-style-type: none"> 1 Turn the ignition switch to OFF. 2 Disconnect and check the harness plug BT14、 BT15 of CDU. 3 Check and repair. <ul style="list-style-type: none"> • Corrosion(install new adapting piece or terminal-cleaning module and pin). • Pin damaged or bent-install new terminal/pin. 4 Fly out of pins-install new pins as needed. 5 Reconnect the CDU plug and all other previously disconnected plug. Make sure the pin is properly positioned and fixed. 6 Run the system and determine if the problem persists?
	YES → Change the CDU Module
NO ↓	
At this point the system is functioning normally. The problem may be caused by module connections. Address the root cause of any connector or pin problems.	
Next Step ↓	
Diagnosis end.	

P1F19-00

Fault diagnosis code
P1F19-00: AC input high voltage interlock failure
Detection tools
1 Multimeter and diagnostic apparatus
Possible causes
<ul style="list-style-type: none">• Circuit, terminal and adapting piece fault• High voltage interlock circuit fault
Conditions for fault code operation
Turn the ignition switch to ON position.
Conditions for fault code setting
P1F19-00
Detected disconnection of high-voltage interlock signal for 100ms
To set the effect of a fault code condition
OBC stops power output, inverter stops power output, DCDC stops power output
Description of circuit diagram

Circuit diagram

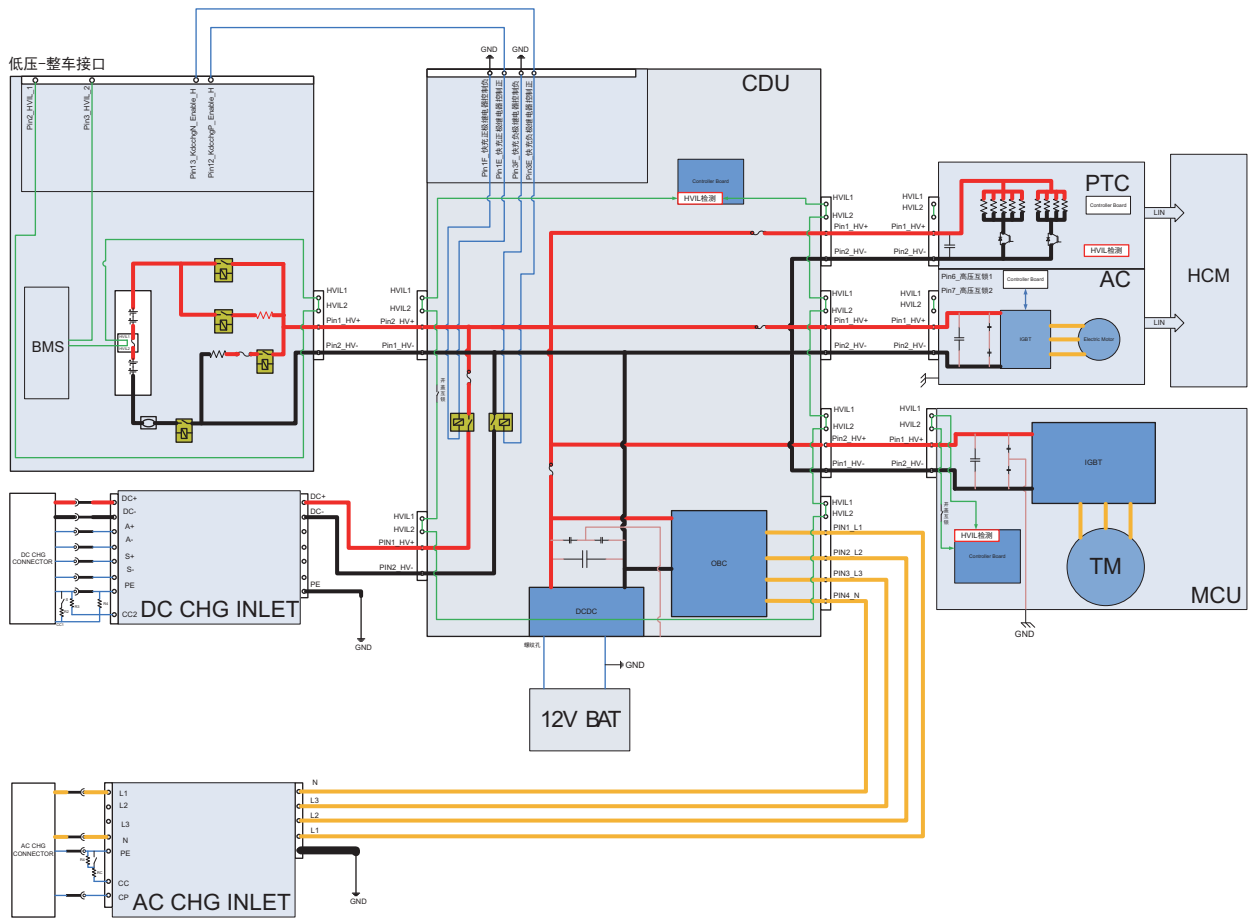

EK894014

Troubleshooting steps	
Step 1	General inspection.
	<ol style="list-style-type: none"> 1 Check the fuse for damage. 2 Check battery capacity. 3 Check the harness plug of CDU for damage, poor contact, aging and looseness. 4 Check whether the result is normal or not?
	NO → Repair or replace the faulted parts.
YES ↓	
Step 2	Check fault codes.
	<ol style="list-style-type: none"> 1 Connect the fault diagnosis instrument to the diagnosis interface. 2 Turn the ignition switch to ON position. 3 Diagnose the CDU module with diagnostic apparatus. 4 Is there any other fault code except for P1F19-00?
	YES → Refer to: DTC Summary list(CDU) .
NO ↓	
Step 3	Check the AC charging high-voltage interlock circuit of CDU.
	<ol style="list-style-type: none"> 1 Turn the ignition switch to OFF. 2 Make protective preparations according to the safety operation specifications of the high voltage voltage in the maintenance manual. 3 Disconnect the harness plug battery pack high voltage. 4 Disconnect the AC charging high voltage harness plug of CDU. 5 Check whether the CDU connection cable is rotten, damaged, and water enters. 6 Check whether the interlock circuit of CDU AC charging high-voltage exist the situation of open or short circuit. 7 Check whether the result is normal or not?
	NO → Repair or replace the faulted parts.
YES ↓	

CDU

Step 4	Check the AC charging high-voltage cable interlock circuit.
	<ol style="list-style-type: none"> 1 Turn the ignition switch to OFF. 2 Make protective preparations according to the safety operation specifications of the high voltage voltage in the maintenance manual. 3 Disconnect the AC charging high voltage harness plug of CDU. 4 Check whether the AC charging high-voltage cable interlock circuit is open. 5 Check whether the result is normal or not?
	NO → Repair or replace the faulted parts.
YES ↓	
Step 5	Check the AC charging port high-voltage cable interlock circuit.
	<ol style="list-style-type: none"> 1 Turn the ignition switch to OFF. 2 Make protective preparations according to the safety operation specifications of the high voltage voltage in the maintenance manual. 3 Open the AC charging port cover. 4 Check whether the interlock circuit of AC charging high-voltage cable exist the situation of open or short circuit. 5 Check whether the result is normal or not?
	NO → Repair or replace the faulted parts.
YES ↓	
Step 6	Check CDU internal circuit.
	<ol style="list-style-type: none"> 1 Turn the ignition switch to OFF. 2 Make protective preparations according to the safety operation specifications of the high voltage voltage in the maintenance manual. 3 Open the CDU end cover. 4 Check CDU internal circuit. 5 Check whether the result is normal or not?
	NO → Repair or replace the faulted parts.
YES ↓	

Step 7	Test whether CDU is norm.
	<ol style="list-style-type: none"> 1 Turn the ignition switch to OFF. 2 Disconnect and check the harness plug BT14、 BT15 of CDU. 3 Check and repair. <ul style="list-style-type: none"> • Corrosion(install new adapting piece or terminal-cleaning module and pin). • Pin damaged or bent-install new terminal/pin. 4 Fly out of pins-install new pins as needed. 5 Reconnect the CDU plug and all other previously disconnected plug. Make sure the pin is properly positioned and fixed. 6 Run the system and determine if the problem persists?
	YES → Change the CDU Module
NO ↓	
At this point the system is functioning normally. The problem may be caused by module connections. Address the root cause of any connector or pin problems.	
Next Step ↓	
Diagnosis end.	

P1F1A-00、 P1F1E-00

Fault diagnosis code
P1F1A-00: DC input high voltage interlock failure
P1F1E-00: DC input high voltage negative interlock failure
Detection tools
1 Multimeter and diagnostic apparatus
Possible causes
<ul style="list-style-type: none"> • Circuit,terminal and adapting piece fault • High voltage interlock circuit fault
Conditions for fault code operation
Turn the ignition switch to ON position.
Conditions for fault code setting
P1F1A-00
Detected disconnection of high-voltage interlock signal for 100ms
P1F1E-00
Detected disconnection of high-voltage interlock signal for 100ms
To set the effect of a fault code condition
OBC stops power output, inverter stops power output, DCDC stops power output
Description of circuit diagram

Circuit diagram

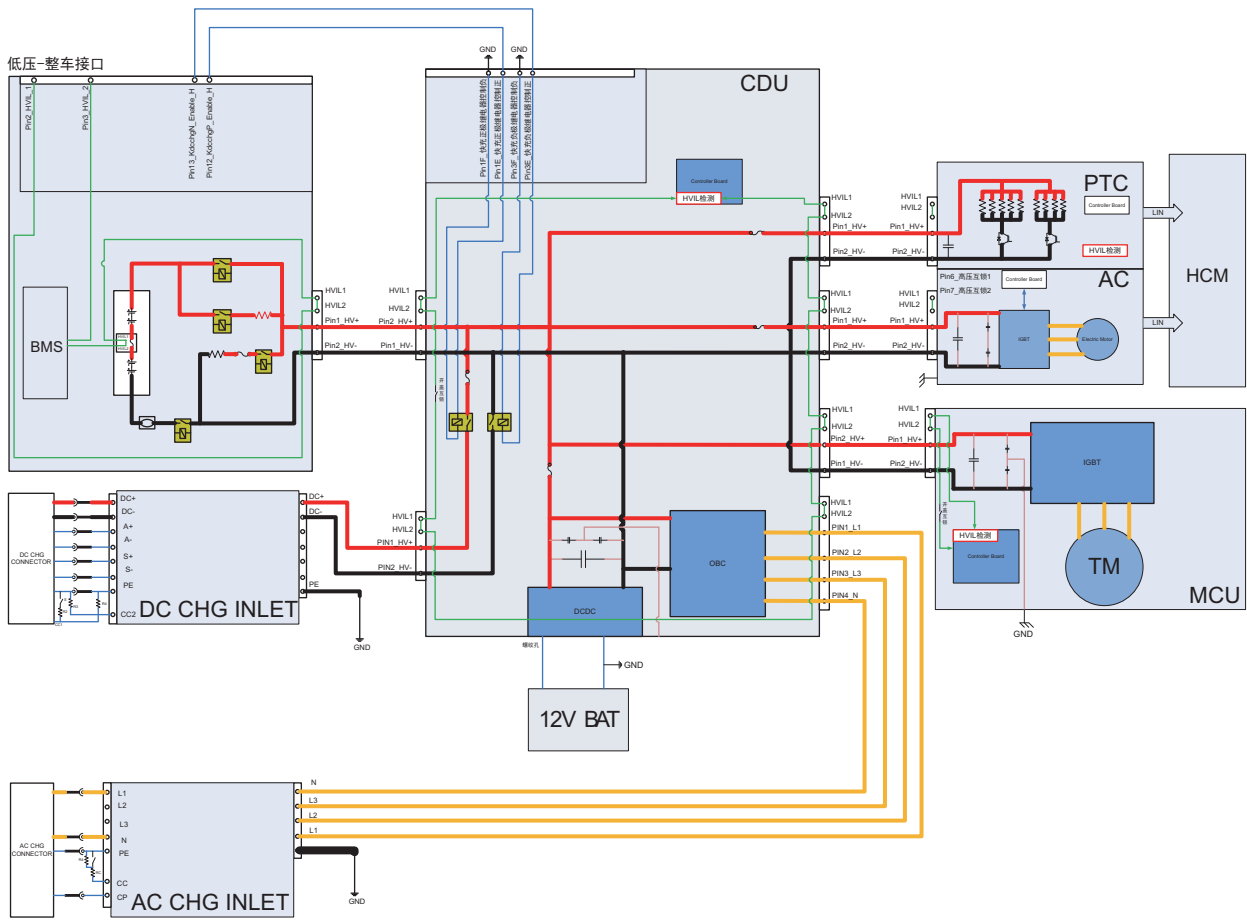

EK894014

Troubleshooting steps	
Step 1	General inspection.
	<ol style="list-style-type: none"> 1 Check the fuse for damage. 2 Check battery capacity. 3 Check the harness plug of CDU for damage, poor contact, aging and looseness. 4 Check whether the result is normal or not?
	NO → Repair or replace the faulted parts.
YES ↓	
Step 2	Check fault codes.
	<ol style="list-style-type: none"> 1 Connect the fault diagnosis instrument to the diagnosis interface. 2 Turn the ignition switch to ON position. 3 Diagnose the CDU module with diagnostic apparatus. 4 If there is any fault code except for P1F1A-00,P1F1E-00?
	YES → Refer to: DTC Summary list(CDU) .
NO ↓	
Step 3	Check the DC charging high-voltage interlock circuit of CDU.
	<ol style="list-style-type: none"> 1 Turn the ignition switch to OFF. 2 Make protective preparations according to the safety operation specifications of the high voltage voltage in the maintenance manual. 3 Disconnect the harness plug battery pack high voltage. 4 Disconnect the DC charging high voltage harness plug of CDU. 5 Check whether the CDU connection cable is rotten, damaged, and water enters. 6 Check whether the interlock circuit of CDU DC charging high-voltage exist the situation of open or short circuit. 7 Check whether the result is normal or not?
	NO → Repair or replace the faulted parts.
YES ↓	

Step 4	Check the DC charging high-voltage cable interlock circuit.	
		<ol style="list-style-type: none"> 1 Turn the ignition switch to OFF. 2 Make protective preparations according to the safety operation specifications of the high voltage voltage in the maintenance manual. 3 Disconnect the DC charging high voltage harness plug of CDU. 4 Check whether the DC charging high-voltage cable interlock circuit is open. 5 Check whether the result is normal or not?
		NO → Repair or replace the faulted parts.
YES ↓		
Step 5	Check the DC charging high-voltage cable interlock circuit.	
		<ol style="list-style-type: none"> 1 Turn the ignition switch to OFF. 2 Make protective preparations according to the safety operation specifications of the high voltage voltage in the maintenance manual. 3 Open the DC charging port cover. 4 Check whether the interlock circuit of DC charging high-voltage cable exist the situation of open or short circuit. 5 Check whether the result is normal or not?
		NO → Repair or replace the faulted parts.
YES ↓		
Step 6	Check CDU internal circuit.	
		<ol style="list-style-type: none"> 1 Turn the ignition switch to OFF. 2 Make protective preparations according to the safety operation specifications of the high voltage voltage in the maintenance manual. 3 Open the CDU end cover. 4 Check CDU internal circuit. 5 Check whether the result is normal or not?
		NO → Repair or replace the faulted parts.
YES ↓		

CDU

Step 7	Test whether CDU is norm.
	<ol style="list-style-type: none"> 1 Turn the ignition switch to OFF. 2 Disconnect and check the harness plug BT14、 BT15 of CDU. 3 Check and repair. <ul style="list-style-type: none"> • Corrosion(install new adapting piece or terminal-cleaning module and pin). • Pin damaged or bent-install new terminal/pin. 4 Fly out of pins-install new pins as needed. 5 Reconnect the CDU plug and all other previously disconnected plug. Make sure the pin is properly positioned and fixed. 6 Run the system and determine if the problem persists?
	YES → Change the CDU Module
NO ↓	
At this point the system is functioning normally. The problem may be caused by module connections. Address the root cause of any connector or pin problems.	
Next Step ↓	
Diagnosis end.	

P1F1B-00

Fault diagnosis code
P1F1B-00: Motor input high voltage interlock failure
Detection tools
1 Multimeter and diagnostic apparatus
Possible causes
<ul style="list-style-type: none">• Circuit, terminal and adapting piece fault• High voltage interlock circuit fault
Conditions for fault code operation
Turn the ignition switch to ON position.
Conditions for fault code setting
P1F1B-00
Detected disconnection of high-voltage interlock signal for 100ms
To set the effect of a fault code condition
OBC stops power output, inverter stops power output, DCDC stops power output
Description of circuit diagram

Circuit diagram

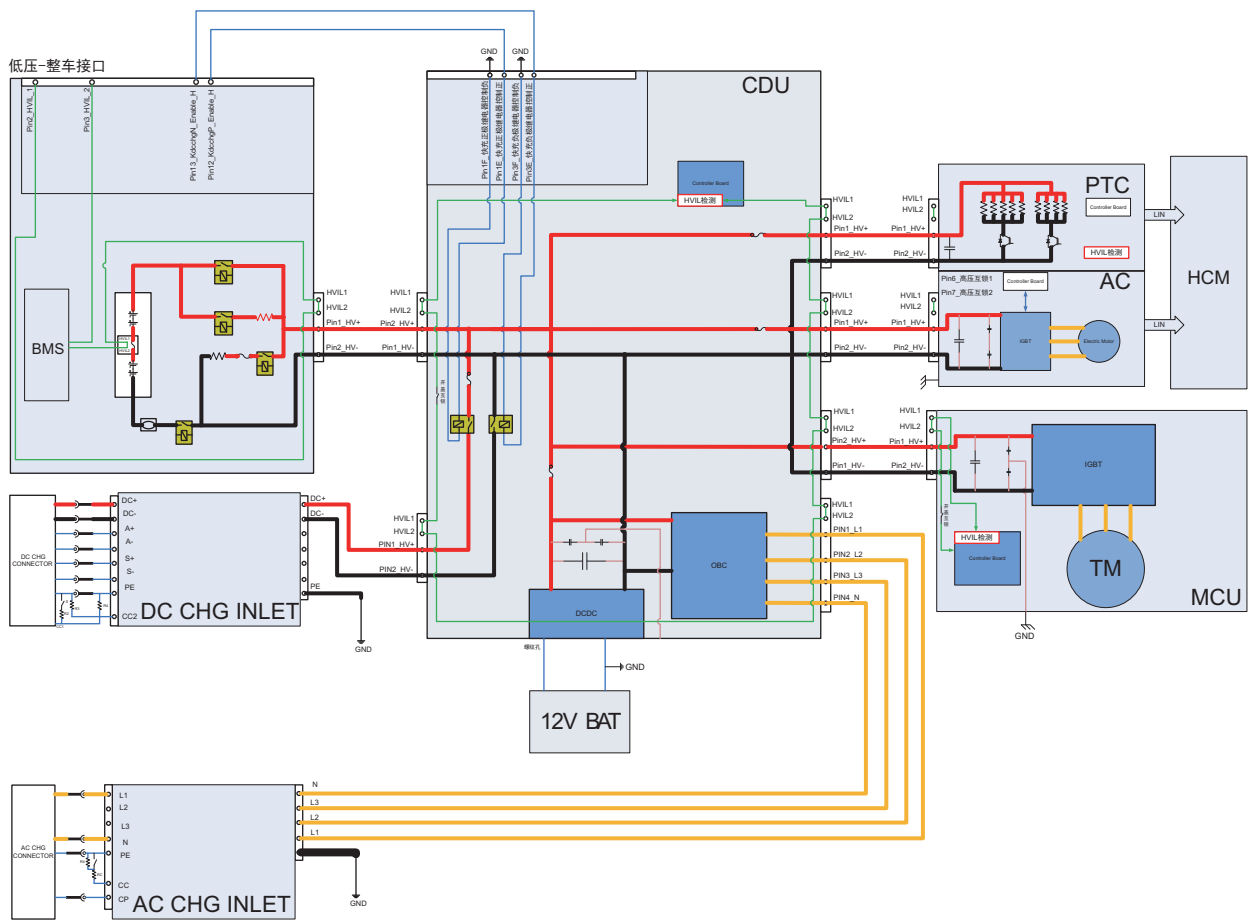

EK894014

Troubleshooting steps	
Step 1	General inspection.
	<ol style="list-style-type: none"> 1 Check the fuse for damage. 2 Check battery capacity. 3 Check the harness plug of CDU for damage, poor contact, aging and looseness. 4 Check whether the result is normal or not?
	NO → Repair or replace the faulted parts.
YES ↓	
Step 2	Check fault codes.
	<ol style="list-style-type: none"> 1 Connect the fault diagnosis instrument to the diagnosis interface. 2 Turn the ignition switch to ON position. 3 Diagnose the CDU module with diagnostic apparatus. 4 Is there any other fault code except for P1F1B-00?
	YES → Refer to: DTC Summary list(CDU) .
NO ↓	
Step 3	Check the driving motor high-voltage interlock circuit of CDU.
	<ol style="list-style-type: none"> 1 Turn the ignition switch to OFF. 2 Make protective preparations according to the safety operation specifications of the high voltage voltage in the maintenance manual. 3 Disconnect the harness plug battery pack high voltage. 4 Disconnect the harness plug driving motor high-voltage of CDU. 5 Check whether the CDU connection cable is rotten, damaged, and water enters. 6 Check whether the interlock circuit of CDU driving motor high-voltage exist the situation of open or short circuit. 7 Check whether the result is normal or not?
	NO → Repair or replace the faulted parts.
YES ↓	

CDU

Step 4	Check the driving motor high-voltage interlock circuit.	
		<ol style="list-style-type: none"> 1 Turn the ignition switch to OFF. 2 Make protective preparations according to the safety operation specifications of the high voltage voltage in the maintenance manual. 3 Disconnect the harness plug driving motor high-voltage of CDU. 4 Disconnect the harness plug driving motor high-voltage of driving motor. 5 Check whether the driving motor high-voltage interlock circuit is open. 6 Check whether the result is normal or not?
		NO → Repair or replace the faulted parts.
YES ↓		
Step 5	Check the driving motor high-voltage cable interlock circuit.	
		<ol style="list-style-type: none"> 1 Turn the ignition switch to OFF. 2 Make protective preparations according to the safety operation specifications of the high voltage voltage in the maintenance manual. 3 Disconnect the harness plug driving motor high-voltage of driving motor. 4 Check whether the interlock circuit of driving motor high-voltage cable exist the situation of open or short circuit. 5 Check whether the result is normal or not?
		NO → Repair or replace the faulted parts.
YES ↓		
Step 6	Check CDU internal circuit.	
		<ol style="list-style-type: none"> 1 Turn the ignition switch to OFF. 2 Make protective preparations according to the safety operation specifications of the high voltage voltage in the maintenance manual. 3 Open the CDU end cover. 4 Check CDU internal circuit. 5 Check whether the result is normal or not?
		NO → Repair or replace the faulted parts.
YES ↓		

Step 7	Test whether CDU is norm.
	<ol style="list-style-type: none"> 1 Turn the ignition switch to OFF. 2 Disconnect and check the harness plug BT14、 BT15 of CDU. 3 Check and repair. <ul style="list-style-type: none"> • Corrosion(install new adapting piece or terminal-cleaning module and pin). • Pin damaged or bent-install new terminal/pin. 4 Fly out of pins-install new pins as needed. 5 Reconnect the CDU plug and all other previously disconnected plug. Make sure the pin is properly positioned and fixed. 6 Run the system and determine if the problem persists?
	YES → Change the CDU Module
NO ↓	
At this point the system is functioning normally. The problem may be caused by module connections. Address the root cause of any connector or pin problems.	
Next Step ↓	
Diagnosis end.	

P1F1D-00

Fault diagnosis code
P1F1D-00: Open lid interlock failure
Detection tools
1 Multimeter and diagnostic apparatus
Possible causes
<ul style="list-style-type: none"> • Circuit, terminal and adapting piece fault • High voltage interlock circuit fault
Conditions for fault code operation
Turn the ignition switch to ON position.
Conditions for fault code setting
P1F1D-00
Detected disconnection of high-voltage interlock signal for 100ms
To set the effect of a fault code condition
Only report, CDU does not actively stop output
Description of circuit diagram

Circuit diagram

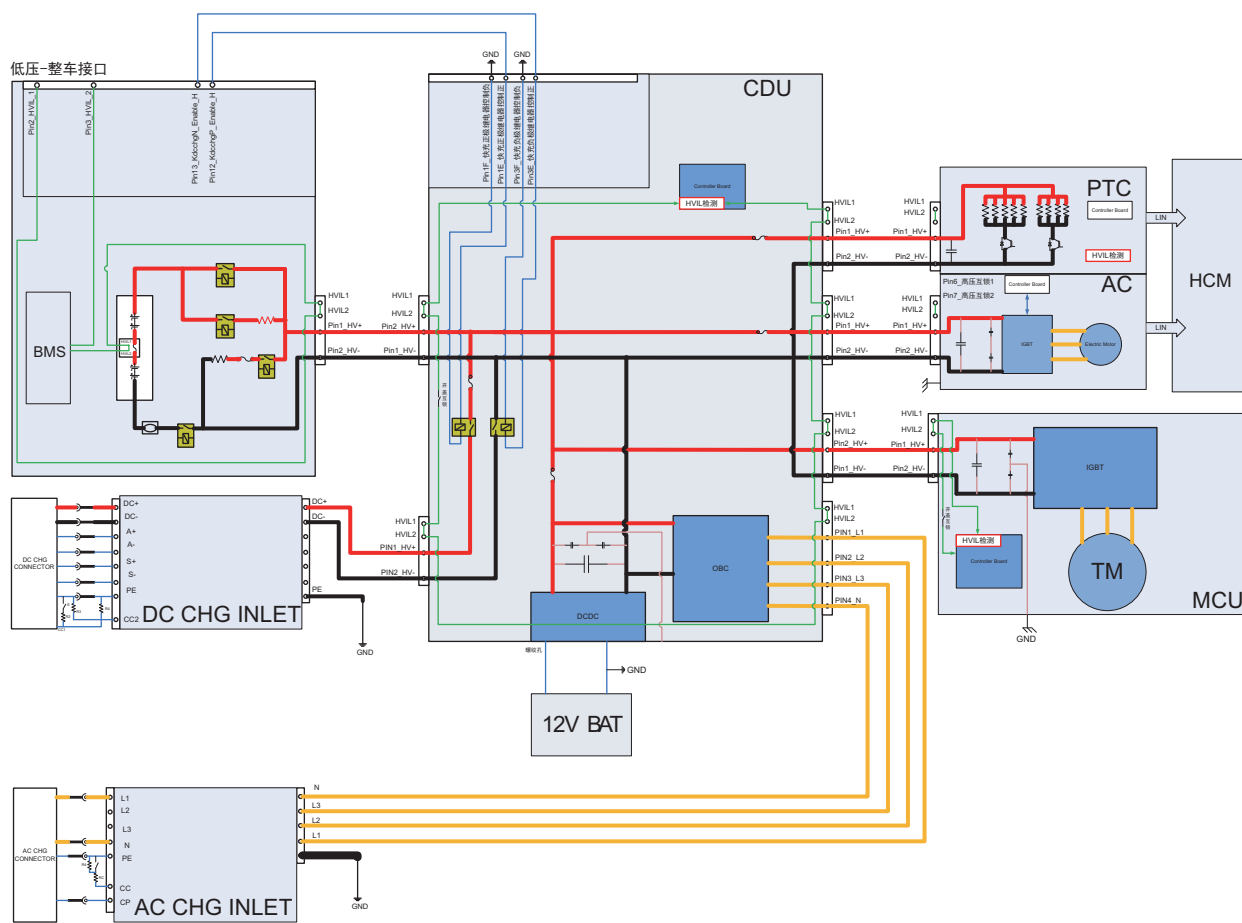

EK894014

Troubleshooting steps	
Step 1	General inspection.
	<ol style="list-style-type: none"> 1 Check the fuse for damage. 2 Check battery capacity. 3 Check the harness plug of CDU for damage, poor contact, aging and looseness. 4 Check whether the result is normal or not?
	NO → Repair or replace the faulted parts.
YES ↓	
Step 2	Check fault codes.
	<ol style="list-style-type: none"> 1 Connect the fault diagnosis instrument to the diagnosis interface. 2 Turn the ignition switch to ON position. 3 Diagnose the CDU module with diagnostic apparatus. 4 Is there any other fault code except for P1F1D-00?
	YES → Refer to: DTC Summary list(CDU) .
NO ↓	
Step 3	Check interlock switch circuit of CDU end cover.
	<ol style="list-style-type: none"> 1 Turn the ignition switch to OFF. 2 Make protective preparations according to the safety operation specifications of the high voltage voltage in the maintenance manual. 3 Disconnect the harness plug battery pack high voltage. 4 Check whether the CDU connection cable is rotten, damaged, and water enters. 5 Open the CDU end cover. 6 Check whether the interlock switch of CDU end cover exist the situation of open or short circuit. 7 Check whether the result is normal or not?
	NO → Repair or replace the faulted parts.
YES ↓	

Step 4	Check CDU internal circuit.
	<ol style="list-style-type: none"> 1 Turn the ignition switch to OFF. 2 Make protective preparations according to the safety operation specifications of the high voltage voltage in the maintenance manual. 3 Open the CDU end cover. 4 Check CDU internal circuit. 5 Check whether the result is normal or not?
	NO → Repair or replace the faulted parts.
YES ↓	
Step 5	Test whether CDU is norm.
	<ol style="list-style-type: none"> 1 Turn the ignition switch to OFF. 2 Disconnect and check the harness plug BT14、 BT15 of CDU. 3 Check and repair. <ul style="list-style-type: none"> • Corrosion(install new adapting piece or terminal-cleaning module and pin). • Pin damaged or bent-install new terminal/pin. 4 Fly out of pins-install new pins as needed. 5 Reconnect the CDU plug and all other previously disconnected plug. Make sure the pin is properly positioned and fixed. 6 Run the system and determine if the problem persists?
	YES → Change the CDU Module
NO ↓	
At this point the system is functioning normally. The problem may be caused by module connections. Address the root cause of any connector or pin problems.	
Next Step ↓	
Diagnosis end.	

P1F09-00、 P1F11-00、 U0111-87、 U0294-87、 U0073-88

Fault diagnosis code
P1F09-00: SCI1 communication failure
P1F11-00: SCI2 communication failure
U0111-87: Abnormal communication between OBC and BMS CAN (598 or 603 message lost)
U0294-87: Communication between DCDC and VCU CAN is abnormal (282 packets are lost)
U0073-88: BUS OFF
Detection tools
1 Multimeter and diagnostic apparatus
Possible causes
<ul style="list-style-type: none"> • Circuit,terminal and adapting piece fault • CDU Module
Conditions for fault code operation
Turn the ignition switch to ON position.
Conditions for fault code setting
P1F09-00
Continuous 10s MCU did not receive HV serial port data
P1F11-00
MCU did not receive PFC serial port data for 10 seconds
U0111-87
No BMS 598 or 603 message received after a timeout of 3 seconds
U0294-87
No VCU 282 message received after a timeout of 3 seconds
U0073-88
Entering Busoff three times in a row
To set the effect of a fault code condition
P1F09-00
OBC stops power output, inverter stops power output, DCDC stops power output
P1F11-00
OBC stops power output, inverter stops power output, DCDC stops power output
U0111-87
OBC stops power output, inverter stops power output
U0294-87
DCDC remains in the pre fault state
U0073-88
OBC stops power output, inverter stops power output, and DCDC remains in the pre fault state

Description of circuit diagram
<p>The device is connected to serial data circuit, which is used to monitor the communication situation of serial data during normal operation of vehicle. The devices will exchange the operation information and commands mutually. The device has programming information required to be exchanged on the serial data circuit. The receiver device will also monitor such information; in addition, there are some regular information indication transmitter devices available.</p>

Circuit diagram

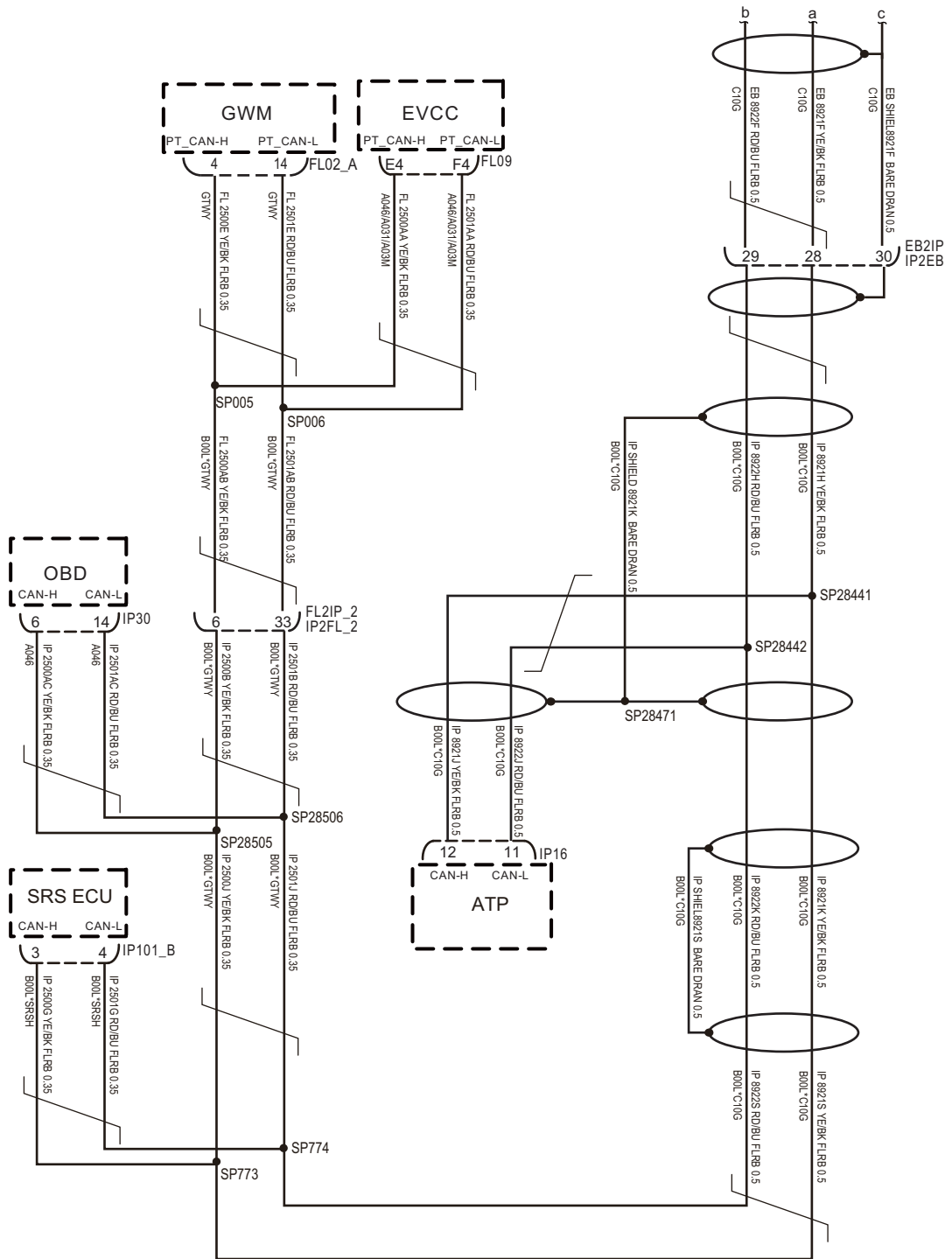

EK897006

Circuit diagram

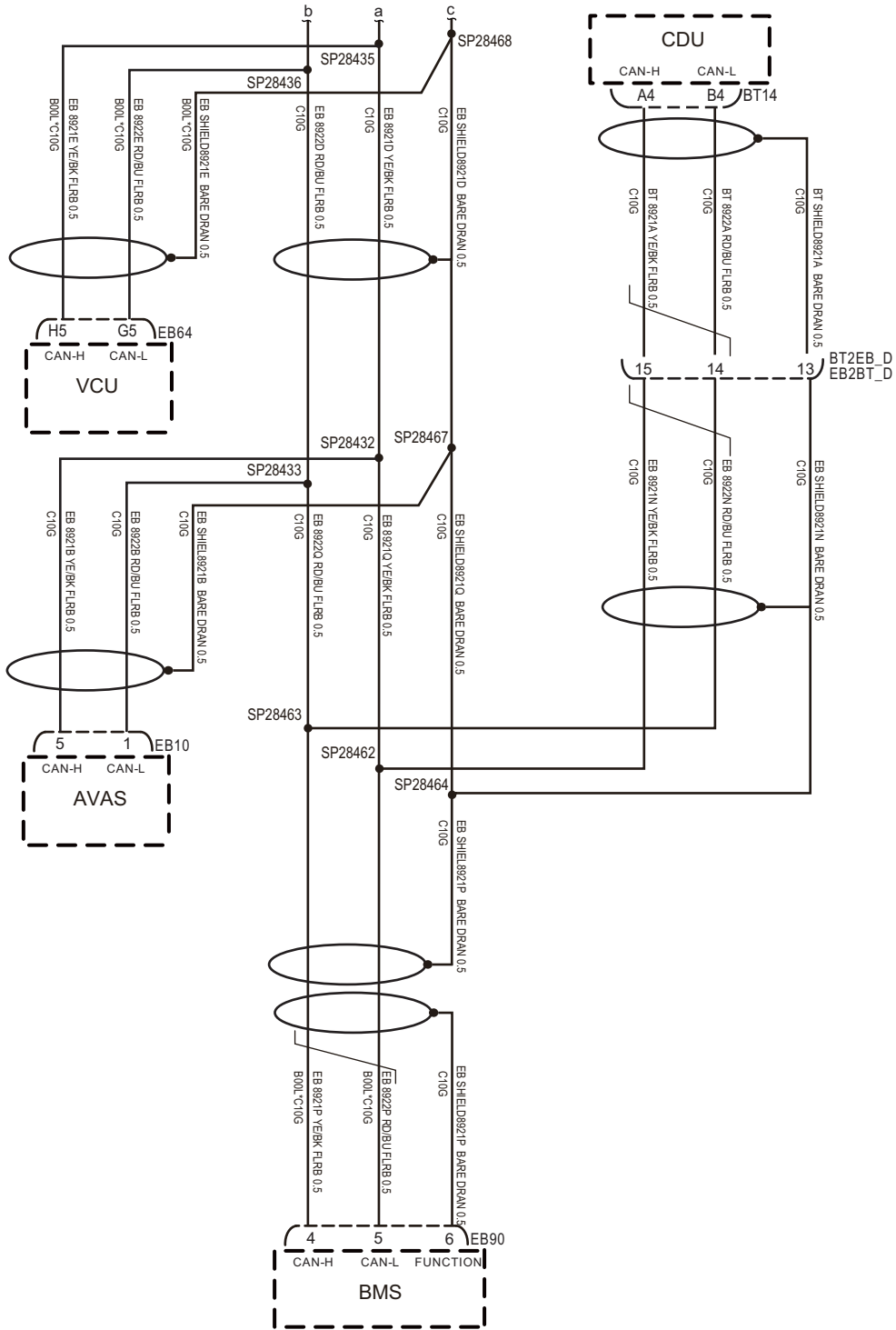

EK897007

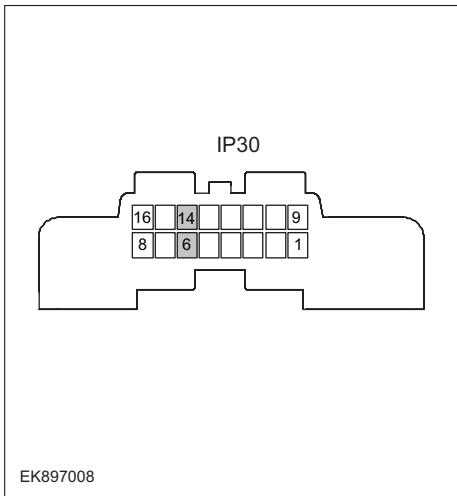
Troubleshooting steps	
Step 1	General inspection.
	<ol style="list-style-type: none"> 1 Check the fuse for damage. 2 Check battery capacity. 3 Check the harness plug of CDU for damage, poor contact, aging and looseness. 4 Check whether the result is normal or not?
NO → Repair or replace the faulted parts.	
YES ↓	
Step 2	Check fault codes.
	<ol style="list-style-type: none"> 1 Connect the fault diagnosis instrument to the diagnosis interface. 2 Turn the ignition switch to ON position. 3 Diagnose the CDU module with diagnostic apparatus. 4 Is there any other fault code except for P1F09-00/P1F11-00/U0111-87/U0294-87/U0073-88?
YES → Refer to: DTC Summary list(CDU) .	
NO ↓	
Step 3	Inspection for CAN communication network completeness.
	<ol style="list-style-type: none"> 1 Turn the ignition switch to OFF. 2 Measure the resistance between the harness terminals of diagnose interface. Measuring circuit: resistance between terminal 6 and terminal 14 on plug IP30. Standard value: ≈ 60Ω 3 Check whether the result is normal or not?
NO → Repair or replace the faulted parts.	
YES ↓	

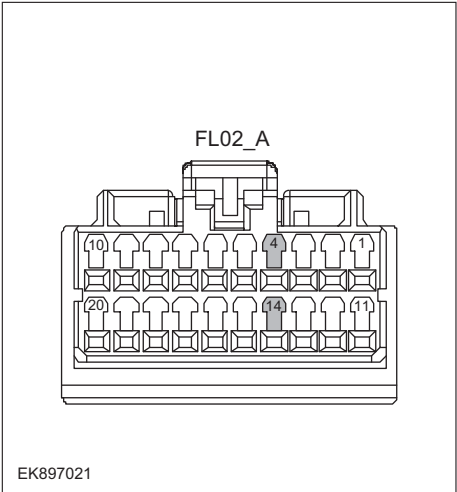
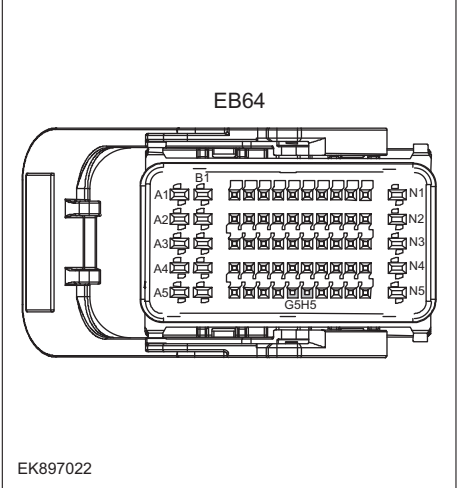
Step 4	Check the terminating resistance of CDU module and VCU resistor.
<div style="text-align: center;">  <p>EK897021</p> </div> <div style="text-align: center; margin-top: 20px;">  <p>EK897022</p> </div>	<ol style="list-style-type: none"> 1 Turn the ignition switch to OFF. 2 Disconnect the harness plug FL02_A of network gateway module. 3 Measure the resistance between harness terminals on network gateway module. Measuring circuit: the resistance between terminal 4 and 14 on plug FL02_A. Standard value: 110~130Ω 4 Connect the harness plug FL02_A of network gateway module. 5 Disconnect the harness plug EB64 of CDU module. 6 Measure the resistance between harness terminals on CDU module. Measuring circuit: resistance between terminal H5 and terminal G5 on plug EB64. Standard value: 110~130Ω 7 Check whether the result is normal or not?
NO → Repair or replace the faulted parts.	
YES ↓	
Step 5	Test whether CDU is norm.
	<ol style="list-style-type: none"> 1 Turn the ignition switch to OFF. 2 Disconnect and check the harness plug BT14、 BT15 of CDU. 3 Check and repair. <ul style="list-style-type: none"> • Corrosion(install new adapting piece or terminal-cleaning module and pin). • Pin damaged or bent-install new terminal/pin. 4 Fly out of pins-install new pins as needed. 5 Reconnect the CDU plug and all other previously disconnected plug. Make sure the pin is properly positioned and fixed. 6 Run the system and determine if the problem persists?
YES → Change the CDU Module	

CDU

NO ↓
At this point the system is functioning normally. The problem may be caused by module connections. Address the root cause of any connector or pin problems.
Next Step ↓
Diagnosis end.

P1F0E-00

Fault diagnosis code
P1F0E-00: The waterway is blocked from water
Detection tools
1 Multimeter and diagnostic apparatus
Possible causes
<ul style="list-style-type: none"> • Circuit,terminal and adapting piece fault • Cooling system fault • The LLC of CDU fault
Conditions for fault code operation
Turn the ignition switch to ON position.
Conditions for fault code setting
P1F0E-00
<p>1. OBC water pump shutdown protection strategy: fault diagnosis condition: OBC startup delay of 20 seconds, maximum water temperature $\geq 75\text{ }^{\circ}\text{C}$ and detection point 1- detection point 2 $\geq 6\text{ }^{\circ}\text{C}$, shutdown</p> <p>2. DCDC water pump shutdown and derating strategy: Fault judgment condition: DCDC startup delay of 20 seconds, maximum water temperature $\geq 75\text{ }^{\circ}\text{C}$ and $7\text{ }^{\circ}\text{C} > \text{Detection point 1- Detection point 2}$ Derating starts at $\geq 6\text{ }^{\circ}\text{C}$, derating coefficient 0.5</p> <p>$8\text{ }^{\circ}\text{C} > \text{Detection point 1- Detection point 2} \geq 7\text{ }^{\circ}\text{C}$, derating coefficient 0.25</p> <p>$\text{Detection point 1- Detection point 2} \geq 8\text{ }^{\circ}\text{C}$, shutdown protection</p> <p>If the power is turned off normally without judgment, and the water pump is triggered to shut down due to a malfunction during operation, the fault flag will not be cleared until the recovery conditions are met before clearing the fault flag</p>
To set the effect of a fault code condition
OBC stops power output, inverter stops power output, DCDC reduces power output or stops output
Description of circuit diagram

Circuit diagram

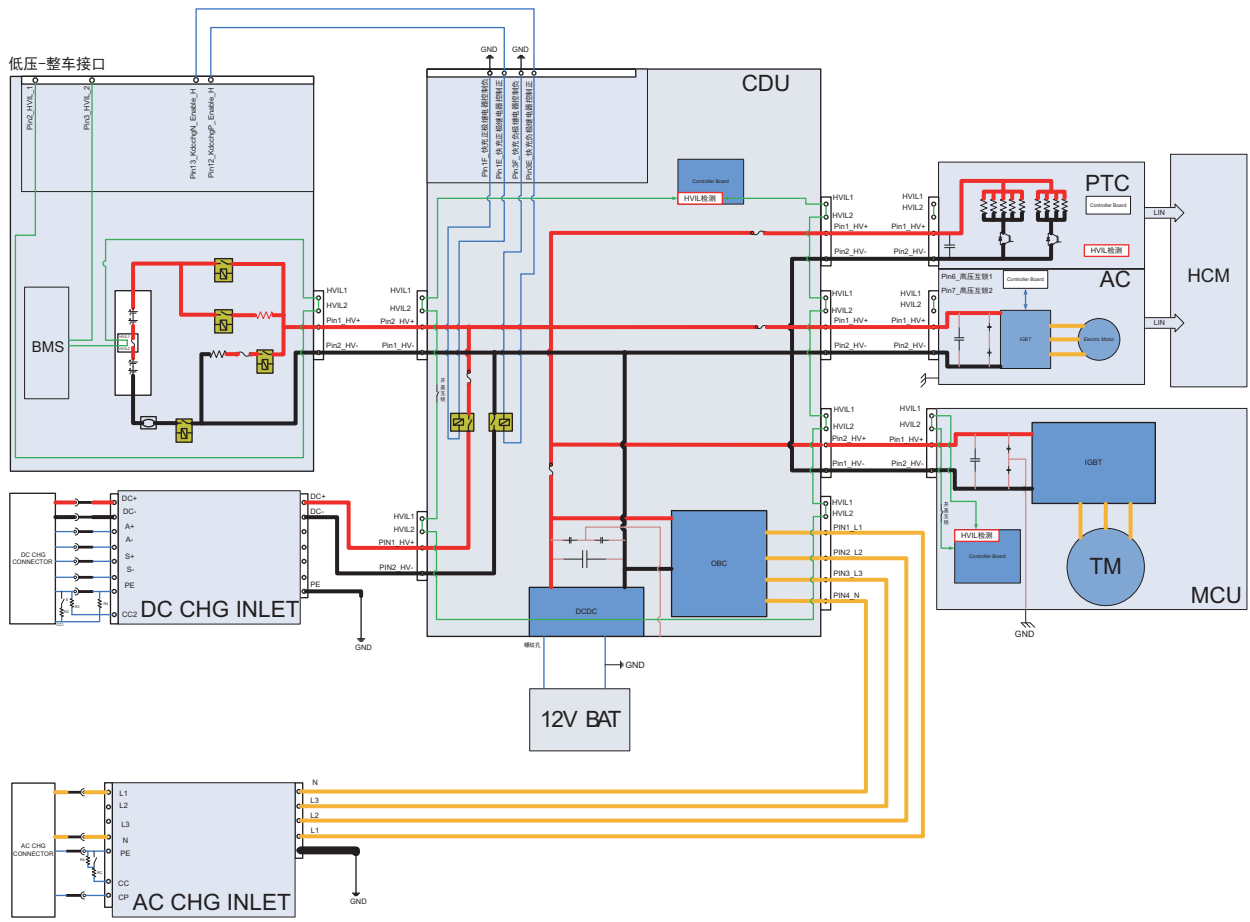

EK894014

Troubleshooting steps	
Step 1	General inspection.
	<ol style="list-style-type: none"> 1 Check the fuse for damage. 2 Check battery capacity. 3 Check the harness plug of CDU for damage, poor contact, aging and looseness. 4 Check whether the result is normal or not?
	NO → Repair or replace the faulted parts.
YES ↓	
Step 2	Check fault codes.
	<ol style="list-style-type: none"> 1 Connect the fault diagnosis instrument to the diagnosis interface. 2 Turn the ignition switch to ON position. 3 Diagnose the CDU module with diagnostic apparatus. 4 Is there any other fault code except for P1F01-00?
	YES → Refer to: DTC Summary list(CDU) .
NO ↓	
Step 3	Check cooling system.
	<ol style="list-style-type: none"> 1 Check whether there is leakage or poor heat dissipation in the cooling system. 2 Check the water pump. 3 Check whether the result is normal or not?
	NO → Repair the cooling system.
YES ↓	
Step 4	Check the connecting cable of CDU.
	<ol style="list-style-type: none"> 1 Turn the ignition switch to OFF. 2 Make protective preparations according to the safety operation specifications of the high voltage voltage in the maintenance manual. 3 Disconnect the harness plug battery pack high voltage. 4 Disconnect the high voltage harness plug of CDU. 5 Check whether the CDU connection cable is rotten, damaged, and water enters. 6 Check whether the result is normal or not?
	NO → Repair or replace the faulted parts.
YES ↓	

CDU

Step 5	Check CDU internal circuit.
	<ol style="list-style-type: none"> 1 Turn the ignition switch to OFF. 2 Make protective preparations according to the safety operation specifications of the high voltage voltage in the maintenance manual. 3 Open the CDU end cover. 4 Check CDU internal circuit. 5 Check whether the result is normal or not?
	NO → Repair or replace the faulted parts.
YES ↓	
Step 6	Test whether CDU is norm.
	<ol style="list-style-type: none"> 1 Turn the ignition switch to OFF. 2 Disconnect and check the harness plug BT14、 BT15 of CDU. 3 Check and repair. <ul style="list-style-type: none"> • Corrosion(install new adapting piece or terminal-cleaning module and pin). • Pin damaged or bent-install new terminal/pin. 4 Fly out of pins-install new pins as needed. 5 Reconnect the CDU plug and all other previously disconnected plug. Make sure the pin is properly positioned and fixed. 6 Run the system and determine if the problem persists?
	YES → Change the CDU Module
NO ↓	
At this point the system is functioning normally. The problem may be caused by module connections. Address the root cause of any connector or pin problems.	
Next Step ↓	
Diagnosis end.	

DTC Summary list (EPS)

DTC	English descriptions	Reference page
U3003-17	Battery Voltage High	U3003-17 、 U3003-16
U3003-16	Battery Voltage Low	
C1624-16	Temperature sensor signal too low	C1624-16 、 C1624-17
C1624-17	Temperature sensor signal too high	
C1614-4B	ECU overtemperature fault	C1614-4B 、 C1668-00
U1688-00	Temperature sensor failure	
U1BAC-00	The controller is reset abnormally	C1BAC-00 、 C1608-49 、 C1606-96
C1608-49	Internal electrical failure of the ECU	
C1606-96	ECU internal power failure	
C1606-97	The ECU internal motor drive failure	C1606-97
C1BC0-02	IG ignition signal is abnormal	C1BC0-02
C1604-96	SENT1、 SENT2 Signal protocol check failure	C1604-96 、 C1604-96 、 C1604-96 、 C1604-96 、 C1604-96
C1604-96	The torque signal data range of SENT1 and SENT2 is checked for faults	
C1604-96	The torque signal synchronization check fault of SENT1 and SENT2	
C1604-96	SENT1, SENT2 signal sampling timeout	
C1604-96	+5VA voltage fault	
C0051-29	The SENTANG signaling protocol checks for faults	C0051-29 、 C0051-29 、 C0051-29 、 C0051-29 、 C0051-54
C0051-29	SENT1, SENT2, SENTANG angle signal data range check fault	
C0051-29	SENTANG signal sampling timeout	
C0051-29	Angle overrun failure	
C0051-54	The angle sensor median is not calibrated for fault	
C1B8F-4B	The system enters thermal protection	C1B8F-4B
C1BB1-55	The controller is not configured	C1BB1-55
C1606-54	The motor (MR) is not calibrated	C1606-54
C1608-97	The magnetoresistive sensor is faulty	C1608-97
C1608-00	Current sense loop fault	C1608-00
C1606-00	Motor three-phase current failure	C1606-00
C1608-12	Motor terminal voltage	C1608-12
U0073-88	Control Module Communication Bus Off on "A"	U0073-88 、 U1261-87 、 U1261-81 、 U1262-87 、 U1262-81
U126187	The message GW_EMS_261h timed out	
U126181	The message GW_EMS_261h send value is invalid	
U126287	The packet GW_IPK_362h timed out	
U126281	The message GW_IPK_362h send value is invalid	

EPS

DTC	English descriptions	Reference page
U1269-87	The packet ABS_269h timed out	U1269-87 , U1269-81 , U1269-83 , U1269-82
U1269-81	The message ABS_269h send value is invalid	
U1269-83	Message ABS_269h - Incorrect Checksum	
U1269-82	Message ABS_269h - Incorrect Alive Counter	

U3003-17、 U3003-16

Fault diagnosis code
U3003-17: Battery Voltage High
U3003-16: Battery Voltage Low
Detection tools
1 Multimeter and diagnostic apparatus
Possible causes
<ul style="list-style-type: none"> • Circuit,terminal and adapting piece fault • Storage battery • EPS • Charging system • Fuse
Conditions for fault code operation
Turn the ignition switch to ON position.
Conditions for fault code setting
U3003-17
The battery voltage is above the warning threshold. The power supply voltage exceeds 16V for 15 seconds.
U3003-16
The battery voltage is below the warning threshold. Except during startup, the power supply voltage is below 9V for 15 seconds.
To set the effect of a fault code condition
Gradual reduction in assistance or No more assistance
Description of circuit diagram
The EPS will monitor whether all sensors and actuators are within normal range all the time. Meanwhile,it will check the connector for virtual connection, short circuit, open circuit and the connection rationality with other signals. When fault occurs, the EPS module will save the fault code corresponding to that fault and enable safety mode.

Circuit diagram

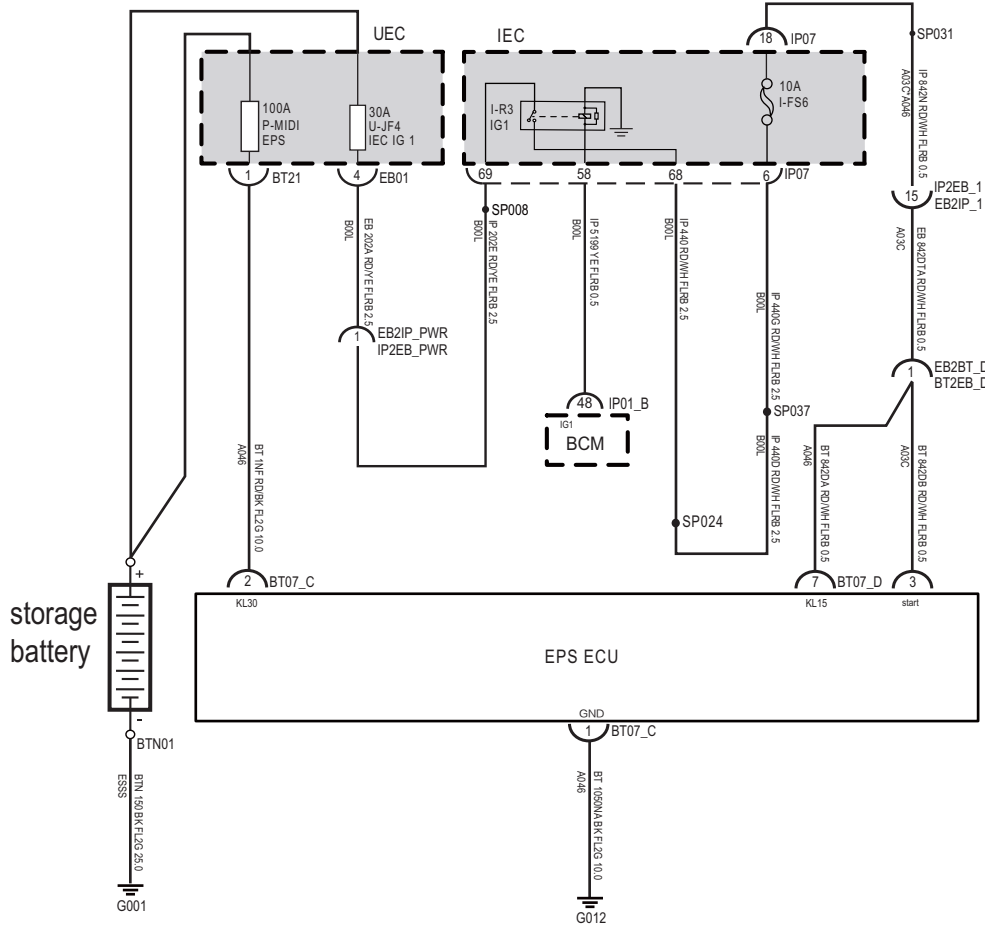

BT07_C

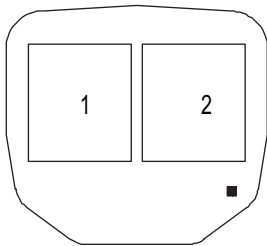

BT07_D

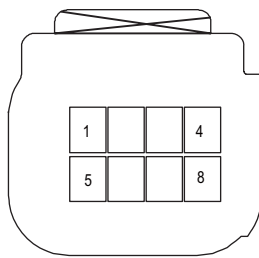

BT07_B

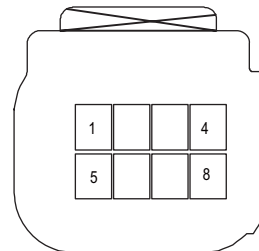

EK891501

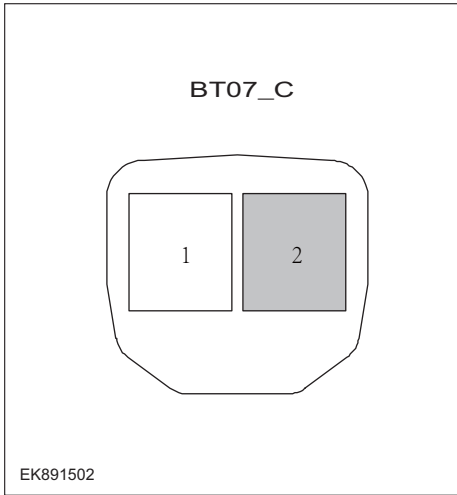
Troubleshooting procedures	
Step1	General inspection.
	<ol style="list-style-type: none"> 1 Check the fuse P-MIDI、 U-JF4、 I-F36 Is it damaged. 2 Check battery capacity. 3 Check the harness plug of EPS for damage, poor contact, aging and looseness. 4 Check whether the result is normal or not?
<p>NO → Repair or replace the faulted parts.</p>	
<p>YES ↓</p>	
Step2	Check fault codes.
	<ol style="list-style-type: none"> 1 Connect the fault diagnosis instrument to the diagnosis interface. 2 Turn the ignition switch to ON position. 3 Diagnose the EPS with diagnostic apparatus. 4 If there is any fault code except for U3003-17、 U3003-16?
<p>YES → Refer to:DTC Summary list (EPS).</p>	
<p>NO ↓</p>	
Step3	Check the EPSStorage battery power supply voltage.
	<ol style="list-style-type: none"> 1 Turn the ignition switch to OFF. 2 Disconnect the EPS harness plug BT07-C. 3 Measure the voltage between the EPS harness terminal and ground. Measuring circuit: The voltage between terminal 2 of BT07-C plug and the grounding. Standard value: 10-14V 4 Check whether the result is normal or not?
<p>NO → Repair or replace the faulted parts.</p>	
<p>YES ↓</p>	

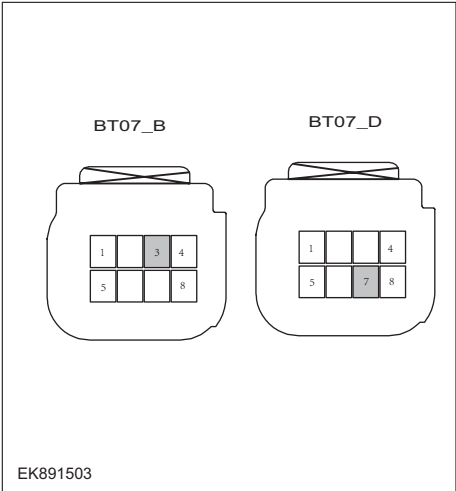
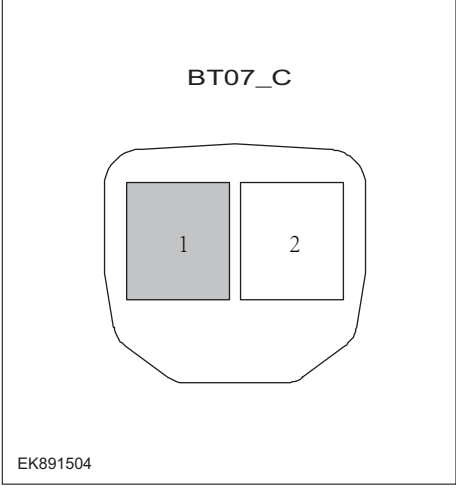
Step4	Check the power supply voltage during EPS startup or operation.
 <p>EK891503</p>	<ol style="list-style-type: none"> 1 Turn on the ignition. 2 Disconnect the EPS harness plugs BT07-D and BT07-B. 3 Measure the voltage between the EPS harness terminal and ground. Measuring circuit: The voltage between terminal 7 of BT07-D plug and the grounding. Measuring circuit: The voltage between terminal 3 of BT07-B plug and the grounding. Standard value: 10-14V 4 Check whether the result is normal or not?
<p>NO → Repair or replace the faulted parts.</p>	
<p>YES ↓</p>	
Step5	Check the EPS ground circuit for an open circuit.
 <p>EK891504</p>	<ol style="list-style-type: none"> 1 Turn the ignition switch to OFF. 2 Disconnect the EPS harness plug. 3 Measure the resistance between the EPS harness plug and ground. Measuring circuit: The resistance between terminal 1 of BT07-C plug and the grounding. Standard value:<1 Ω 4 Is the resistance less than 1 Ω?
<p>NO → Repair or replace the faulted parts.</p>	
<p>YES ↓</p>	

Step6	Test whether EPS is norm.
	<ol style="list-style-type: none"> 1 Turn the ignition switch to OFF. 2 Disconnect and check the harness plug BT07-B、 BT07-C、 BT07-D of EPS module. 3 Check and repair: <ul style="list-style-type: none"> • Corrosion(install new adapting piece or terminal-cleaning module and pin). • Pin damaged or bent-install new terminal/pin. 4 Fly out of pins-install new pins as needed. 5 Reconnect the EPS plug and all other previously disconnected plug. Make sure the pin is properly positioned and fixed. 6 Run the system and determine if the problem persists?.
	YES → Change the EPS .
NO ↓	
At this point the system is functioning normally. The problem may be caused by module connections. Address the root cause of any connector or pin problems.	
Next Step ↓	
Diagnosis end.	

C1624-16、 C1624-17

Fault diagnosis code
C1624-16: Temperature sensor signal too low
C1624-17: Temperature sensor signal too high
Detection tools
1 Multimeter and diagnostic apparatus
Possible causes
<ul style="list-style-type: none"> • Circuit,terminal and adapting piece fault • Storage battery • EPS • Charging system • Fuse
Conditions for fault code operation
Turn the ignition switch to ON position.
Conditions for fault code setting
C1624-16
C1624-17
To set the effect of a fault code condition
Gradual reduction in assistance or No more assistance
Description of circuit diagram
The EPS will monitor whether all sensors and actuators are within normal range all the time. Meanwhile,it will check the connector for virtual connection, short circuit, open circuit and the connection rationality with other signals. When fault occurs, the EPS module will save the fault code corresponding to that fault and enable safety mode.

Circuit diagram

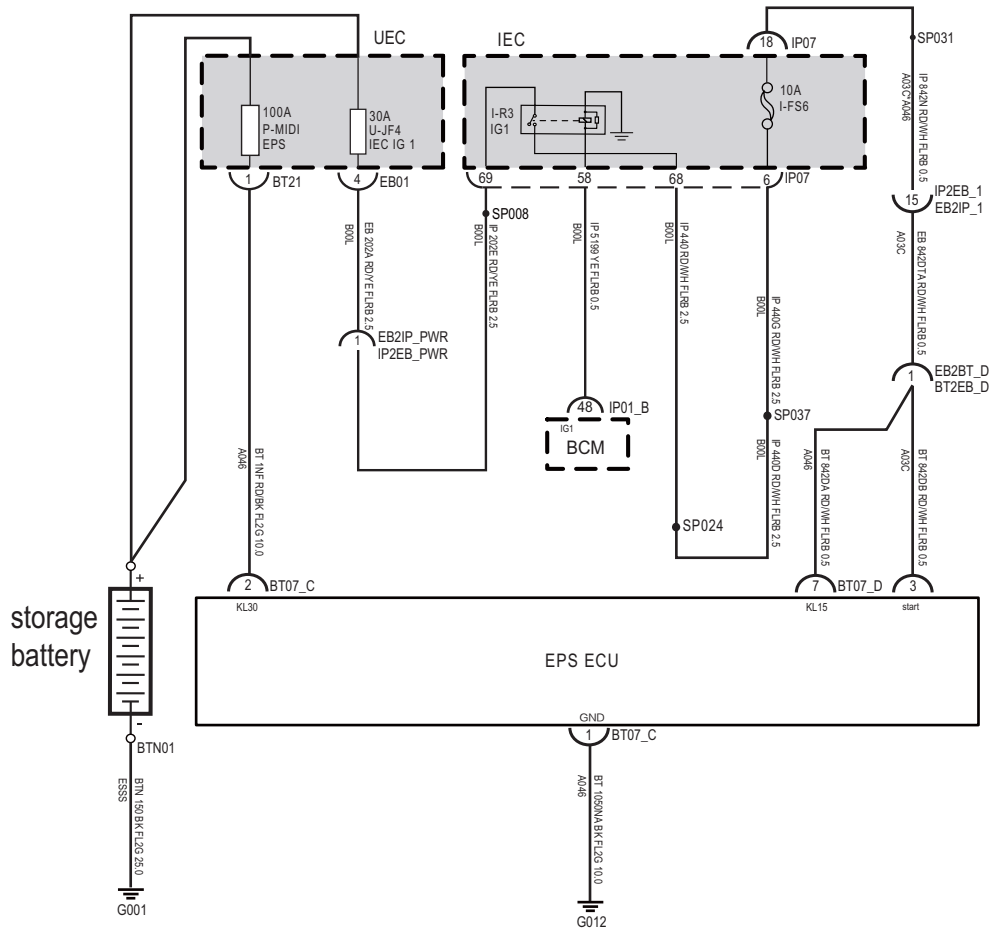

BT07_C

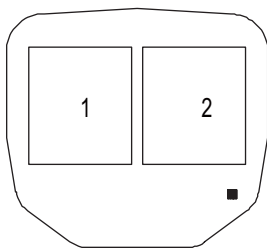

BT07_D

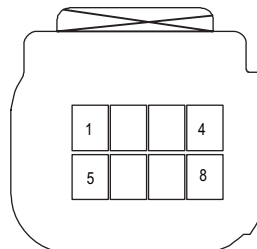

BT07_B

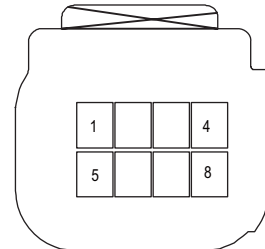

EK891501

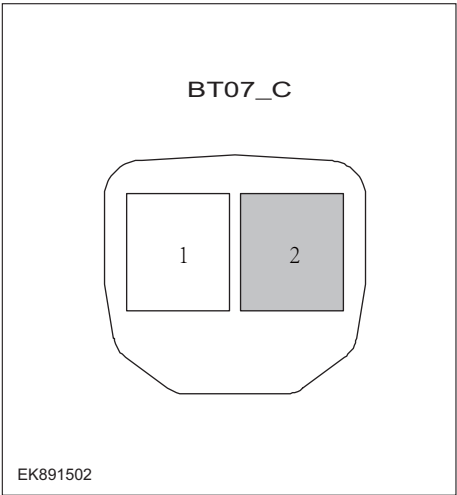
Troubleshooting procedures	
Step1	General inspection.
	<ol style="list-style-type: none"> 1 Check the fuse P-MIDI、 U-JF4、 I-F36 Is it damaged. 2 Check battery capacity. 3 Check the harness plug of EPS for damage, poor contact, aging and looseness. 4 Check whether the result is normal or not?
NO → Repair or replace the faulted parts.	
YES ↓	
Step2	Check fault codes.
	<ol style="list-style-type: none"> 1 Connect the fault diagnosis instrument to the diagnosis interface. 2 Turn the ignition switch to ON position. 3 Diagnose the EPS with diagnostic apparatus. 4 If there is any fault code except for U1624-17、 U1624-16?
YES → Refer to: DTC Summary list (EPS) .	
NO ↓	
Step3	Check the EPStorage battery power supply voltage.
	<ol style="list-style-type: none"> 1 Turn the ignition switch to OFF. 2 Disconnect the EPS harness plug BT07-C. 3 Measure the voltage between the EPS harness terminal and ground. Measuring circuit: The voltage between terminal 2 of BT07-C plug and the grounding. Standard value: 10-14V 4 Check whether the result is normal or not?
NO → Repair or replace the faulted parts.	
YES ↓	

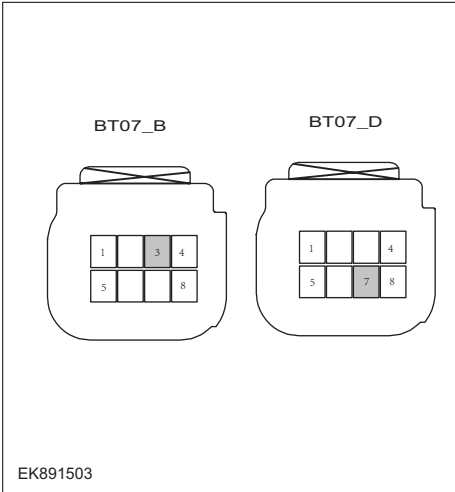
Step4	Check the power supply voltage during EPS startup or operation.
 <p>EK891503</p>	<ol style="list-style-type: none"> 1 Turn on the ignition. 2 Disconnect the EPS harness plugs BT07-D and BT07-B. 3 Measure the voltage between the EPS harness terminal and ground. Measuring circuit: The voltage between terminal 7 of BT07-D plug and the grounding. Measuring circuit: The voltage between terminal 3 of BT07-B plug and the grounding. Standard value: 10-14V 4 Check whether the result is normal or not?

NO → Repair or replace the faulted parts.

YES ↓

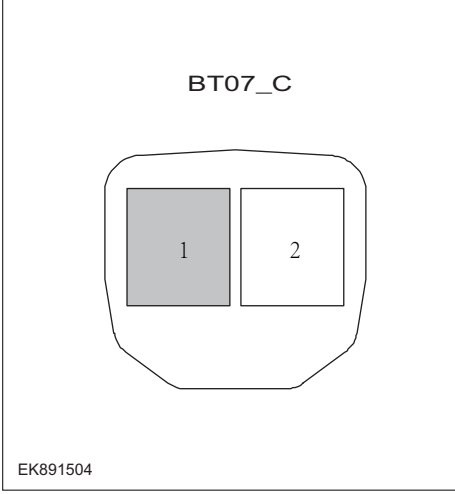
Step5	Check the EPS ground circuit for an open circuit.
 <p>EK891504</p>	<ol style="list-style-type: none"> 1 Turn the ignition switch to OFF. 2 Disconnect the EPS harness plug. 3 Measure the resistance between the EPS harness plug and ground. Measuring circuit: The resistance between terminal 1 of BT07-C plug and the grounding. Standard value:<1 Ω 4 Is the resistance less than 1 Ω?

NO → Repair or replace the faulted parts.

YES ↓

EPS

Step6	Test whether EPS is norm.
	<ol style="list-style-type: none">1 Turn the ignition switch to OFF.2 Disconnect and check the harness plug BT07-B、 BT07-C、 BT07-D of EPS module.3 Check and repair:<ul style="list-style-type: none">• Corrosion(install new adapting piece or terminal-cleaning module and pin).• Pin damaged or bent-install new terminal/pin.4 Fly out of pins-install new pins as needed.5 Reconnect the EPS plug and all other previously disconnected plug. Make sure the pin is properly positioned and fixed.6 Run the system and determine if the problem persists?.
	YES → Change the EPS .
NO ↓	
At this point the system is functioning normally. The problem may be caused by module connections. Address the root cause of any connector or pin problems.	
Next Step ↓	
Diagnosis end.	

C1614-4B、 C1668-00

Fault diagnosis code
C1614-4B: ECU overtemperature fault
C1668-00: Temperature sensor failure
Detection tools
1 Multimeter and diagnostic apparatus
Possible causes
<ul style="list-style-type: none"> • Circuit,terminal and adapting piece fault • Temperature Sensor Failure • EPS
Conditions for fault code operation
Turn the ignition switch to ON position.
Conditions for fault code setting
C1614-4B
Detect ECU temperature greater than 125 °C , duration>200ms
C1668-00
The voltage range of the temperature sensor exceeds 0.05V~4.95V
To set the effect of a fault code condition
No assistance

Troubleshooting procedures	
Step1	General inspection.
	<ol style="list-style-type: none"> 1 Check if the fuse is damaged. 2 Check battery capacity. 3 Check the harness plug of EPS for damage, poor contact, aging and looseness. 4 Check whether the result is normal or not?
	NO → Repair or replace the faulted parts.
YES ↓	
Step2	Check fault codes.
	<ol style="list-style-type: none"> 1 Connect the fault diagnosis instrument to the diagnosis interface. 2 Turn the ignition switch to ON position. 3 Diagnose the EPS with diagnostic apparatus. 4 If there is any fault code except for C1624-16、 C1624-17?
	YES → Refer to: DTC Summary list (EPS) .
NO ↓	
Step3	Perform initialization.
	<ol style="list-style-type: none"> 1 Turn the ignition switch to OFF. 2 Connect the fault diagnosis instrument to the diagnosis interface. 3 Turn on the ignition. 4 Use a diagnostic tool to initialize EPS. 5 Can EPS be initialized and restored to normal?
	NO → Repair or replace the EPS control module.
YES ↓	
Step4	Check the temperature sensor circuit.
	<ol style="list-style-type: none"> 1 Turn the ignition switch to OFF. 2 Check the temperature sensor circuit for short circuits, short circuits, damage, and other faults. 3 Check whether the result is normal or not?
	NO → Repair or replace the faulted parts.
YES ↓	

Step5	Test whether EPS is norm.
	<ol style="list-style-type: none"> 1 Turn the ignition switch to OFF. 2 Disconnect and check the harness plug BT07-B、 BT07-C、 BT07-D of EPS module. 3 Check and repair: <ul style="list-style-type: none"> • Corrosion(install new adapting piece or terminal-cleaning module and pin). • Pin damaged or bent-install new terminal/pin. 4 Fly out of pins-install new pins as needed. 5 Reconnect the EPS plug and all other previously disconnected plug. Make sure the pin is properly positioned and fixed. 6 Run the system and determine if the problem persists?.
	YES → Change the EPS .
NO ↓	
At this point the system is functioning normally. The problem may be caused by module connections. Address the root cause of any connector or pin problems.	
Next Step ↓	
Diagnosis end.	

C1BAC-00、 C1608-49、 C1606-96

Fault diagnosis code
C1BAC-00: The controller is reset abnormally
C1608-49: Internal electrical failure of the ECU
C1606-96: ECU internal power failure
Detection tools
1 Multimeter and diagnostic apparatus
Possible causes
<ul style="list-style-type: none"> • Circuit,terminal and adapting piece fault • INTERNAL FAULT • EPS
Conditions for fault code operation
Turn the ignition switch to ON position.
Conditions for fault code setting
C1BAC-00
MCU abnormal reset detected during power on initialization
C1608-49
By detecting the midpoint of the current sensor, online monitoring of the internal current, voltage, and speed of the ECU can detect related faults; MCU related faults
C1606-96
Detect faults related to the pre drive chip inside the ECU
To set the effect of a fault code condition
No assistance

Troubleshooting procedures	
Step1	General inspection.
	<ol style="list-style-type: none"> 1 Check if the fuse is damaged. 2 Check battery capacity. 3 Check the harness plug of EPS for damage, poor contact, aging and looseness. 4 Check whether the result is normal or not?
	NO → Repair or replace the faulted parts.
YES ↓	
Step2	Check fault codes.
	<ol style="list-style-type: none"> 1 Connect the fault diagnosis instrument to the diagnosis interface. 2 Turn the ignition switch to ON position. 3 Diagnose the EPS with diagnostic apparatus. 4 If there is any fault code except for C1BAC-00、 C1608-49、 C1606-96?
	YES → Refer to: DTC Summary list (EPS) .
NO ↓	
Step3	Perform initialization.
	<ol style="list-style-type: none"> 1 Turn the ignition switch to OFF. 2 Connect the fault diagnosis instrument to the diagnosis interface. 3 Turn on the ignition. 4 Use a diagnostic tool to initialize EPS. 5 Can EPS be initialized and restored to normal?
	NO → Repair or replace the EPS control module.
YES ↓	
Step4	Check the temperature sensor circuit.
	<ol style="list-style-type: none"> 1 Turn the ignition switch to OFF. 2 Check the temperature sensor circuit for short circuits, short circuits, damage, and other faults. 3 Check whether the result is normal or not?
	NO → Repair or replace the faulted parts.
YES ↓	

EPS

Step5	Test whether EPS is norm.
	<ol style="list-style-type: none"> 1 Turn the ignition switch to OFF. 2 Disconnect and check the harness plug BT07-B、 BT07-C、 BT07-D of EPS module. 3 Check and repair: <ul style="list-style-type: none"> • Corrosion(install new adapting piece or terminal-cleaning module and pin). • Pin damaged or bent-install new terminal/pin. 4 Fly out of pins-install new pins as needed. 5 Reconnect the EPS plug and all other previously disconnected plug. Make sure the pin is properly positioned and fixed. 6 Run the system and determine if the problem persists?.
	YES → Change the EPS .
NO ↓	
At this point the system is functioning normally. The problem may be caused by module connections. Address the root cause of any connector or pin problems.	
Next Step ↓	
Diagnosis end.	

C1606-97

Fault diagnosis code
C1606-97: The ECU internal motor drive failure
Detection tools
1 Multimeter and diagnostic apparatus
Possible causes
<ul style="list-style-type: none">• Circuit,terminal and adapting piece fault• INTERNAL FAULT• EPS
Conditions for fault code operation
Turn the ignition switch to ON position.
Conditions for fault code setting
C1606-97
Detect faults related to the pre drive chip inside the ECU
To set the effect of a fault code condition
No assistance

Troubleshooting procedures	
Step1	General inspection.
	<ol style="list-style-type: none"> 1 Check if the fuse is damaged. 2 Check battery capacity. 3 Check the harness plug of EPS for damage, poor contact, aging and looseness. 4 Check whether the result is normal or not?
	NO → Repair or replace the faulted parts.
YES ↓	
Step2	Check fault codes.
	<ol style="list-style-type: none"> 1 Connect the fault diagnosis instrument to the diagnosis interface. 2 Turn the ignition switch to ON position. 3 Diagnose the EPS with diagnostic apparatus. 4 If there is any fault code except for C1606-97?
	YES → Refer to: DTC Summary list (EPS) .
NO ↓	
Step3	Perform initialization.
	<ol style="list-style-type: none"> 1 Turn the ignition switch to OFF. 2 Connect the fault diagnosis instrument to the diagnosis interface. 3 Turn on the ignition. 4 Use a diagnostic tool to initialize EPS. 5 Can EPS be initialized and restored to normal?
	NO → Repair or replace the EPS control module.
YES ↓	
Step4	Check the software version.
	<ol style="list-style-type: none"> 1 Turn the ignition switch to OFF. 2 Connect the fault diagnosis instrument to the diagnosis interface. 3 Turn on the ignition. 4 Use a diagnostic tool to read the software version information of EPS and update it to the latest matching version. 5 Is the software update normal?
	NO → Repair or replace the EPS control module.
YES ↓	

Step5	Test whether EPS is norm.
	<ol style="list-style-type: none"> 1 Turn the ignition switch to OFF. 2 Disconnect and check the harness plug BT07-B、 BT07-C、 BT07-D of EPS module. 3 Check and repair: <ul style="list-style-type: none"> • Corrosion(install new adapting piece or terminal-cleaning module and pin). • Pin damaged or bent-install new terminal/pin. 4 Fly out of pins-install new pins as needed. 5 Reconnect the EPS plug and all other previously disconnected plug. Make sure the pin is properly positioned and fixed. 6 Run the system and determine if the problem persists?.
	YES → Change the EPS .
NO ↓	
At this point the system is functioning normally. The problem may be caused by module connections. Address the root cause of any connector or pin problems.	
Next Step ↓	
Diagnosis end.	

C1BC0-02

Fault diagnosis code
C1BC0-02: IG ignition signal is abnormal
Detection tools
1 Multimeter and diagnostic apparatus
Possible causes
<ul style="list-style-type: none"> • Circuit,terminal and adapting piece fault • INTERNAL FAULT • EPS
Conditions for fault code operation
Turn the ignition switch to ON position.
Conditions for fault code setting
C1BC0-02
The engine is in running mode (vehicle speed>5, speed>220), and the controller cannot detect the ignition signal. The controller reports a fault after 20 seconds
To set the effect of a fault code condition
No assistance

Troubleshooting procedures	
Step1	General inspection.
	<ol style="list-style-type: none"> 1 Check if the fuse is damaged. 2 Check battery capacity. 3 Check the harness plug of EPS for damage, poor contact, aging and looseness. 4 Check whether the result is normal or not?
	NO → Repair or replace the faulted parts.
YES ↓	
Step2	Check fault codes.
	<ol style="list-style-type: none"> 1 Connect the fault diagnosis instrument to the diagnosis interface. 2 Turn the ignition switch to ON position. 3 Diagnose the EPS with diagnostic apparatus. 4 If there is any fault code except for C1BC0-02?
	YES → Refer to: DTC Summary list (EPS) .
NO ↓	
Step3	Perform initialization.
	<ol style="list-style-type: none"> 1 Turn the ignition switch to OFF. 2 Connect the fault diagnosis instrument to the diagnosis interface. 3 Turn on the ignition. 4 Use a diagnostic tool to initialize EPS. 5 Can EPS be initialized and restored to normal?
	NO → Repair or replace the EPS control module.
YES ↓	
Step4	Check the software version.
	<ol style="list-style-type: none"> 1 Turn the ignition switch to OFF. 2 Connect the fault diagnosis instrument to the diagnosis interface. 3 Turn on the ignition. 4 Use a diagnostic tool to read the software version information of EPS and update it to the latest matching version. 5 Is the software update normal?
	NO → Repair or replace the EPS control module.
YES ↓	

EPS

Step5	Test whether EPS is norm.
	<ol style="list-style-type: none">1 Turn the ignition switch to OFF.2 Disconnect and check the harness plug BT07-B、 BT07-C、 BT07-D of EPS module.3 Check and repair:<ul style="list-style-type: none">• Corrosion(install new adapting piece or terminal-cleaning module and pin).• Pin damaged or bent-install new terminal/pin.4 Fly out of pins-install new pins as needed.5 Reconnect the EPS plug and all other previously disconnected plug. Make sure the pin is properly positioned and fixed.6 Run the system and determine if the problem persists?.
	YES → Change the EPS .
NO ↓	
At this point the system is functioning normally. The problem may be caused by module connections. Address the root cause of any connector or pin problems.	
Next Step ↓	
Diagnosis end.	

C1604-96、 C1604-96、 C1604-96、 C1604-96、 C1604-96

Fault diagnosis code
C1604-96: SENT1、 SENT2 Signal protocol check failure
C1604-96: The torque signal data range of SENT1 and SENT2 is checked for faults
C1604-96: The torque signal synchronization check fault of SENT1 and SENT2
C1604-96: SENT1, SENT2 signal sampling timeout
C1604-96: +5VA voltage fault
Detection tools
1 Multimeter and diagnostic apparatus
Possible causes
<ul style="list-style-type: none"> • Circuit,terminal and adapting piece fault • INTERNAL FAULT • EPS
Conditions for fault code operation
Turn the ignition switch to ON position.
Conditions for fault code setting
C1604-96:
SENT1 and SENT2 signal protocol check failure, duration>20m
C1604-96:
Fault in checking the torque signal data range of SENT1 and SENT2, with a duration of>20ms
C1604-96:
Synchronous check failure of torque signals for SENT1 and SENT2, duration>20ms
C1604-96:
Controller did not collect torque signal within 20ms
C1604-96:
The measured value of the torque sensor+5VA power supply voltage is not between 4.65 and 5.35V. Fault reported after 20ms
To set the effect of a fault code condition
No assistance

Troubleshooting procedures	
Step1	General inspection.
	<ol style="list-style-type: none"> 1 Check if the fuse is damaged. 2 Check battery capacity. 3 Check the harness plug of EPS for damage, poor contact, aging and looseness. 4 Check whether the result is normal or not?
	NO → Repair or replace the faulted parts.
YES ↓	
Step2	Check fault codes.
	<ol style="list-style-type: none"> 1 Connect the fault diagnosis instrument to the diagnosis interface. 2 Turn the ignition switch to ON position. 3 Diagnose the EPS with diagnostic apparatus. 4 If there is any fault code except for C1604-96、 C1604-96、 C1604-96、 C1604-96?
	YES → Refer to: DTC Summary list (EPS) .
NO ↓	
Step3	Perform initialization.
	<ol style="list-style-type: none"> 1 Turn the ignition switch to OFF. 2 Connect the fault diagnosis instrument to the diagnosis interface. 3 Turn on the ignition. 4 Use a diagnostic tool to initialize EPS. 5 Can EPS be initialized and restored to normal?
	NO → Repair or replace the EPS control module.
YES ↓	
Step4	Check the software version.
	<ol style="list-style-type: none"> 1 Turn the ignition switch to OFF. 2 Connect the fault diagnosis instrument to the diagnosis interface. 3 Turn on the ignition. 4 Use a diagnostic tool to read the software version information of EPS and update it to the latest matching version. 5 Is the software update normal?
	NO → Repair or replace the EPS control module.

YES ↓	
Step5	Test whether EPS is norm.
	<ol style="list-style-type: none"> 1 Turn the ignition switch to OFF. 2 Disconnect and check the harness plug BT07-B、 BT07-C、 BT07-D of EPS module. 3 Check and repair: <ul style="list-style-type: none"> • Corrosion(install new adapting piece or terminal-cleaning module and pin). • Pin damaged or bent-install new terminal/pin. 4 Fly out of pins-install new pins as needed. 5 Reconnect the EPS plug and all other previously disconnected plug. Make sure the pin is properly positioned and fixed. 6 Run the system and determine if the problem persists?.
	YES → Change the EPS .
NO ↓	
At this point the system is functioning normally. The problem may be caused by module connections. Address the root cause of any connector or pin problems.	
Next Step ↓	
Diagnosis end.	

EPS

C0051-29、C0051-29、C0051-29、C0051-29、C0051-29、C0051-54

Fault diagnosis code
C0051-29: The SENTANG signaling protocol checks for faults
C0051-29: SENT1, SENT2, SENTANG angle signal data range check fault
C0051-29: SENTANG signal sampling timeout
C0051-29: Angle overrun failure
C0051-54: The angle sensor median is not calibrated for fault
Detection tools
1 Multimeter and diagnostic apparatus
Possible causes
<ul style="list-style-type: none">• Circuit,terminal and adapting piece fault• INTERNAL FAULT• EPS
Conditions for fault code operation
Turn the ignition switch to ON position.
Conditions for fault code setting
C0051-29
SENTANG signal protocol checks for faults and starts reporting faults after 20ms
C0051-29
Angle signal data range check fault for SENT1, SENT2, SENTANG 20ms
C0051-29
SENTANG signal sampling timeout 20ms
C0051-29
Abnormal angle sensor signal, synchronization, cursor credibility, or other faults
C0051-54
The angle sensor has not been calibrated in the middle position
To set the effect of a fault code condition
No assistance

Troubleshooting procedures	
Step1	General inspection.
	<ol style="list-style-type: none"> 1 Check if the fuse is damaged. 2 Check battery capacity. 3 Check the harness plug of EPS for damage, poor contact, aging and looseness. 4 Check whether the result is normal or not?
	NO → Repair or replace the faulted parts.
YES ↓	
Step2	Check fault codes.
	<ol style="list-style-type: none"> 1 Connect the fault diagnosis instrument to the diagnosis interface. 2 Turn the ignition switch to ON position. 3 Diagnose the EPS with diagnostic apparatus. 4 If there is any fault code except for C0051-29、 C0051-29、 C0051-29、 C0051-54?
	YES → Refer to: DTC Summary list (EPS) .
NO ↓	
Step3	Perform initialization.
	<ol style="list-style-type: none"> 1 Turn the ignition switch to OFF. 2 Connect the fault diagnosis instrument to the diagnosis interface. 3 Turn on the ignition. 4 Use a diagnostic tool to initialize EPS. 5 Can EPS be initialized and restored to normal?
	NO → Repair or replace the EPS control module.
YES ↓	

EPS

Step4	Check the software version.
	<ol style="list-style-type: none"> 1 Turn the ignition switch to OFF. 2 Connect the fault diagnosis instrument to the diagnosis interface. 3 Turn on the ignition. 4 Use a diagnostic tool to read the software version information of EPS and update it to the latest matching version. 5 Is the software update normal?
	NO → Repair or replace the EPS control module.
YES ↓	
Step5	Test whether EPS is norm.
	<ol style="list-style-type: none"> 1 Turn the ignition switch to OFF. 2 Disconnect and check the harness plug BT07-B、 BT07-C、 BT07-D of EPS module. 3 Check and repair: <ul style="list-style-type: none"> • Corrosion(install new adapting piece or terminal-cleaning module and pin). • Pin damaged or bent-install new terminal/pin. 4 Fly out of pins-install new pins as needed. 5 Reconnect the EPS plug and all other previously disconnected plug. Make sure the pin is properly positioned and fixed. 6 Run the system and determine if the problem persists?.
	YES → Change the EPS .
NO ↓	
At this point the system is functioning normally. The problem may be caused by module connections. Address the root cause of any connector or pin problems.	
Next Step ↓	
Diagnosis end.	

C1B8F-4B

Fault diagnosis code
C1B8F-4B: The system enters thermal protection
Detection tools
1 Multimeter and diagnostic apparatus
Possible causes
<ul style="list-style-type: none"> • Circuit, terminal and adapting piece fault • INTERNAL FAULT • EPS
Conditions for fault code operation
Turn the ignition switch to ON position.
Conditions for fault code setting
C1B8F-4B
The internal temperature of the controller or motor exceeds the limit (calibration value)
To set the effect of a fault code condition
No assistance

Troubleshooting procedures	
Step1	General inspection.
	<ol style="list-style-type: none"> 1 Check if the fuse is damaged. 2 Check battery capacity. 3 Check the harness plug of EPS for damage, poor contact, aging and looseness. 4 Check whether the result is normal or not?
	NO → Repair or replace the faulted parts.
YES ↓	
Step2	Check fault codes.
	<ol style="list-style-type: none"> 1 Connect the fault diagnosis instrument to the diagnosis interface. 2 Turn the ignition switch to ON position. 3 Diagnose the EPS with diagnostic apparatus. 4 If there is any fault code except for C1B8F-4B?
	YES → Refer to: DTC Summary list (EPS) .
NO ↓	
Step3	Perform initialization.
	<ol style="list-style-type: none"> 1 Turn the ignition switch to OFF. 2 Connect the fault diagnosis instrument to the diagnosis interface. 3 Turn on the ignition. 4 Use a diagnostic tool to initialize EPS. 5 Can EPS be initialized and restored to normal?
	NO → Repair or replace the EPS control module.
YES ↓	
Step4	Check the software version.
	<ol style="list-style-type: none"> 1 Turn the ignition switch to OFF. 2 Connect the fault diagnosis instrument to the diagnosis interface. 3 Turn on the ignition. 4 Use a diagnostic tool to read the software version information of EPS and update it to the latest matching version. 5 Is the software update normal?
	NO → Repair or replace the EPS control module.
YES ↓	

Step5	Test whether EPS is norm.
	<ol style="list-style-type: none"> 1 Turn the ignition switch to OFF. 2 Disconnect and check the harness plug BT07-B、 BT07-C、 BT07-D of EPS module. 3 Check and repair: <ul style="list-style-type: none"> • Corrosion(install new adapting piece or terminal-cleaning module and pin). • Pin damaged or bent-install new terminal/pin. 4 Fly out of pins-install new pins as needed. 5 Reconnect the EPS plug and all other previously disconnected plug. Make sure the pin is properly positioned and fixed. 6 Run the system and determine if the problem persists?.
	YES → Change the EPS .
NO ↓	
At this point the system is functioning normally. The problem may be caused by module connections. Address the root cause of any connector or pin problems.	
Next Step ↓	
Diagnosis end.	

C1BB1-55

Fault diagnosis code
C1B8F-4B: The controller is not configured
Detection tools
1 Multimeter and diagnostic apparatus
Possible causes
<ul style="list-style-type: none"> • Circuit,terminal and adapting piece fault • INTERNAL FAULT • EPS
Conditions for fault code operation
Turn the ignition switch to ON position.
Conditions for fault code setting
C1BB1-55
The configuration word has never been written, and the read value is in the factory default state; Failed to read configuration word information after initialization check is completed
To set the effect of a fault code condition
No assistance

Troubleshooting procedures	
Step1	General inspection.
	<ol style="list-style-type: none"> 1 Check if the fuse is damaged. 2 Check battery capacity. 3 Check the harness plug of EPS for damage, poor contact, aging and looseness. 4 Check whether the result is normal or not?
	NO → Repair or replace the faulted parts.
YES ↓	
Step2	Check fault codes.
	<ol style="list-style-type: none"> 1 Connect the fault diagnosis instrument to the diagnosis interface. 2 Turn the ignition switch to ON position. 3 Diagnose the EPS with diagnostic apparatus. 4 If there is any fault code except for C1BB1-55?
	YES → Refer to: DTC Summary list (EPS) .
NO ↓	
Step3	Perform initialization.
	<ol style="list-style-type: none"> 1 Turn the ignition switch to OFF. 2 Connect the fault diagnosis instrument to the diagnosis interface. 3 Turn on the ignition. 4 Use a diagnostic tool to initialize EPS. 5 Can EPS be initialized and restored to normal?
	NO → Repair or replace the EPS control module.
YES ↓	
Step4	Check the software version.
	<ol style="list-style-type: none"> 1 Turn the ignition switch to OFF. 2 Connect the fault diagnosis instrument to the diagnosis interface. 3 Turn on the ignition. 4 Use a diagnostic tool to read the software version information of EPS and update it to the latest matching version. 5 Is the software update normal?
	NO → Repair or replace the EPS control module.
YES ↓	

EPS

Step5	Test whether EPS is norm.
	<ol style="list-style-type: none"> 1 Turn the ignition switch to OFF. 2 Disconnect and check the harness plug BT07-B、 BT07-C、 BT07-D of EPS module. 3 Check and repair: <ul style="list-style-type: none"> • Corrosion(install new adapting piece or terminal-cleaning module and pin). • Pin damaged or bent-install new terminal/pin. 4 Fly out of pins-install new pins as needed. 5 Reconnect the EPS plug and all other previously disconnected plug. Make sure the pin is properly positioned and fixed. 6 Run the system and determine if the problem persists?.
	YES → Change the EPS .
NO ↓	
At this point the system is functioning normally. The problem may be caused by module connections. Address the root cause of any connector or pin problems.	
Next Step ↓	
Diagnosis end.	

C1606-54

Fault diagnosis code
C1606-54: The motor (MR) is not calibrated
Detection tools
1 Multimeter and diagnostic apparatus
Possible causes
<ul style="list-style-type: none">• Circuit, terminal and adapting piece fault• INTERNAL FAULT• EPS
Conditions for fault code operation
Turn the ignition switch to ON position.
Conditions for fault code setting
C1606-54
Motor (MR) not calibrated
To set the effect of a fault code condition
No assistance

Troubleshooting procedures	
Step1	General inspection.
	<ol style="list-style-type: none"> 1 Check if the fuse is damaged. 2 Check battery capacity. 3 Check the harness plug of EPS for damage, poor contact, aging and looseness. 4 Check whether the result is normal or not?
	NO → Repair or replace the faulted parts.
YES ↓	
Step2	Check fault codes.
	<ol style="list-style-type: none"> 1 Connect the fault diagnosis instrument to the diagnosis interface. 2 Turn the ignition switch to ON position. 3 Diagnose the EPS with diagnostic apparatus. 4 If there is any fault code except for C1606-54?
	YES → Refer to: DTC Summary list (EPS) .
NO ↓	
Step3	Perform initialization.
	<ol style="list-style-type: none"> 1 Turn the ignition switch to OFF. 2 Connect the fault diagnosis instrument to the diagnosis interface. 3 Turn on the ignition. 4 Use a diagnostic tool to initialize EPS. 5 Can EPS be initialized and restored to normal?
	NO → Repair or replace the EPS control module.
YES ↓	
Step4	Check the software version.
	<ol style="list-style-type: none"> 1 Turn the ignition switch to OFF. 2 Connect the fault diagnosis instrument to the diagnosis interface. 3 Turn on the ignition. 4 Use a diagnostic tool to read the software version information of EPS and update it to the latest matching version. 5 Is the software update normal?
	NO → Repair or replace the EPS control module.
YES ↓	

Step5	Test whether EPS is norm.
	<ol style="list-style-type: none"> 1 Turn the ignition switch to OFF. 2 Disconnect and check the harness plug BT07-B、 BT07-C、 BT07-D of EPS module. 3 Check and repair: <ul style="list-style-type: none"> • Corrosion(install new adapting piece or terminal-cleaning module and pin). • Pin damaged or bent-install new terminal/pin. 4 Fly out of pins-install new pins as needed. 5 Reconnect the EPS plug and all other previously disconnected plug. Make sure the pin is properly positioned and fixed. 6 Run the system and determine if the problem persists?.
	YES → Change the EPS .
NO ↓	
At this point the system is functioning normally. The problem may be caused by module connections. Address the root cause of any connector or pin problems.	
Next Step ↓	
Diagnosis end.	

C1608-97

Fault diagnosis code
C1608-97: The magnetoresistive sensor is faulty
Detection tools
1 Multimeter and diagnostic apparatus
Possible causes
<ul style="list-style-type: none">• Circuit,terminal and adapting piece fault• INTERNAL FAULT• EPS
Conditions for fault code operation
Turn the ignition switch to ON position.
Conditions for fault code setting
C1608-97
Motor reluctance related faults
To set the effect of a fault code condition
No assistance

Troubleshooting procedures	
Step1	General inspection.
	<ol style="list-style-type: none"> 1 Check if the fuse is damaged. 2 Check battery capacity. 3 Check the harness plug of EPS for damage, poor contact, aging and looseness. 4 Check whether the result is normal or not?
	NO → Repair or replace the faulted parts.
YES ↓	
Step2	Check fault codes.
	<ol style="list-style-type: none"> 1 Connect the fault diagnosis instrument to the diagnosis interface. 2 Turn the ignition switch to ON position. 3 Diagnose the EPS with diagnostic apparatus. 4 If there is any fault code except for C1608-97?
	YES → Refer to: DTC Summary list (EPS) .
NO ↓	
Step3	Perform initialization.
	<ol style="list-style-type: none"> 1 Turn the ignition switch to OFF. 2 Connect the fault diagnosis instrument to the diagnosis interface. 3 Turn on the ignition. 4 Use a diagnostic tool to initialize EPS. 5 Can EPS be initialized and restored to normal?
	NO → Repair or replace the EPS control module.
YES ↓	
Step4	Check the software version.
	<ol style="list-style-type: none"> 1 Turn the ignition switch to OFF. 2 Connect the fault diagnosis instrument to the diagnosis interface. 3 Turn on the ignition. 4 Use a diagnostic tool to read the software version information of EPS and update it to the latest matching version. 5 Is the software update normal?
	NO → Repair or replace the EPS control module.
YES ↓	

EPS

Step5	Test whether EPS is norm.
	<ol style="list-style-type: none">1 Turn the ignition switch to OFF.2 Disconnect and check the harness plug BT07-B、 BT07-C、 BT07-D of EPS module.3 Check and repair:<ul style="list-style-type: none">• Corrosion(install new adapting piece or terminal-cleaning module and pin).• Pin damaged or bent-install new terminal/pin.4 Fly out of pins-install new pins as needed.5 Reconnect the EPS plug and all other previously disconnected plug. Make sure the pin is properly positioned and fixed.6 Run the system and determine if the problem persists?.
	YES → Change the EPS .
NO ↓	
At this point the system is functioning normally. The problem may be caused by module connections. Address the root cause of any connector or pin problems.	
Next Step ↓	
Diagnosis end.	

C1608-00

Fault diagnosis code
C1608-00: Current sense loop fault
Detection tools
1 Multimeter and diagnostic apparatus
Possible causes
<ul style="list-style-type: none">• Circuit, terminal and adapting piece fault• INTERNAL FAULT• EPS
Conditions for fault code operation
Turn the ignition switch to ON position.
Conditions for fault code setting
C1608-00
Current greater than 60A, speed less than 100RPM; The sum of three-phase currents is greater than 30A
To set the effect of a fault code condition
No assistance

Troubleshooting procedures	
Step1	General inspection.
	<ol style="list-style-type: none"> 1 Check if the fuse is damaged. 2 Check battery capacity. 3 Check the harness plug of EPS for damage, poor contact, aging and looseness. 4 Check whether the result is normal or not?
	NO → Repair or replace the faulted parts.
YES ↓	
Step2	Check fault codes.
	<ol style="list-style-type: none"> 1 Connect the fault diagnosis instrument to the diagnosis interface. 2 Turn the ignition switch to ON position. 3 Diagnose the EPS with diagnostic apparatus. 4 If there is any fault code except for C1608-00?
	YES → Refer to: DTC Summary list (EPS) .
NO ↓	
Step3	Perform initialization.
	<ol style="list-style-type: none"> 1 Turn the ignition switch to OFF. 2 Connect the fault diagnosis instrument to the diagnosis interface. 3 Turn on the ignition. 4 Use a diagnostic tool to initialize EPS. 5 Can EPS be initialized and restored to normal?
	NO → Repair or replace the EPS control module.
YES ↓	
Step4	Check the software version.
	<ol style="list-style-type: none"> 1 Turn the ignition switch to OFF. 2 Connect the fault diagnosis instrument to the diagnosis interface. 3 Turn on the ignition. 4 Use a diagnostic tool to read the software version information of EPS and update it to the latest matching version. 5 Is the software update normal?
	NO → Repair or replace the EPS control module.
YES ↓	

Step5	Test whether EPS is norm.
	<ol style="list-style-type: none"> 1 Turn the ignition switch to OFF. 2 Disconnect and check the harness plug BT07-B、 BT07-C、 BT07-D of EPS module. 3 Check and repair: <ul style="list-style-type: none"> • Corrosion(install new adapting piece or terminal-cleaning module and pin). • Pin damaged or bent-install new terminal/pin. 4 Fly out of pins-install new pins as needed. 5 Reconnect the EPS plug and all other previously disconnected plug. Make sure the pin is properly positioned and fixed. 6 Run the system and determine if the problem persists?.
	YES → Change the EPS .
NO ↓	
At this point the system is functioning normally. The problem may be caused by module connections. Address the root cause of any connector or pin problems.	
Next Step ↓	
Diagnosis end.	

C1606-00

Fault diagnosis code
C1606-00: Motor three-phase current failure
Detection tools
1 Multimeter and diagnostic apparatus
Possible causes
<ul style="list-style-type: none">• Circuit,terminal and adapting piece fault• INTERNAL FAULT• EPS
Conditions for fault code operation
Turn the ignition switch to ON position.
Conditions for fault code setting
C1606-00
Motor phase current greater than 150A
To set the effect of a fault code condition
No assistance

Troubleshooting procedures	
Step1	General inspection.
	<ol style="list-style-type: none"> 1 Check if the fuse is damaged. 2 Check battery capacity. 3 Check the harness plug of EPS for damage, poor contact, aging and looseness. 4 Check whether the result is normal or not?
	NO → Repair or replace the faulted parts.
YES ↓	
Step2	Check fault codes.
	<ol style="list-style-type: none"> 1 Connect the fault diagnosis instrument to the diagnosis interface. 2 Turn the ignition switch to ON position. 3 Diagnose the EPS with diagnostic apparatus. 4 If there is any fault code except for C1606-00?
	YES → Refer to: DTC Summary list (EPS) .
NO ↓	
Step3	Perform initialization.
	<ol style="list-style-type: none"> 1 Turn the ignition switch to OFF. 2 Connect the fault diagnosis instrument to the diagnosis interface. 3 Turn on the ignition. 4 Use a diagnostic tool to initialize EPS. 5 Can EPS be initialized and restored to normal?
	NO → Repair or replace the EPS control module.
YES ↓	
Step4	Check the software version.
	<ol style="list-style-type: none"> 1 Turn the ignition switch to OFF. 2 Connect the fault diagnosis instrument to the diagnosis interface. 3 Turn on the ignition. 4 Use a diagnostic tool to read the software version information of EPS and update it to the latest matching version. 5 Is the software update normal?
	NO → Repair or replace the EPS control module.
YES ↓	

EPS

Step5	Test whether EPS is norm.
	<ol style="list-style-type: none"> 1 Turn the ignition switch to OFF. 2 Disconnect and check the harness plug BT07-B、 BT07-C、 BT07-D of EPS module. 3 Check and repair: <ul style="list-style-type: none"> • Corrosion(install new adapting piece or terminal-cleaning module and pin). • Pin damaged or bent-install new terminal/pin. 4 Fly out of pins-install new pins as needed. 5 Reconnect the EPS plug and all other previously disconnected plug. Make sure the pin is properly positioned and fixed. 6 Run the system and determine if the problem persists?.
	YES → Change the EPS .
NO ↓	
At this point the system is functioning normally. The problem may be caused by module connections. Address the root cause of any connector or pin problems.	
Next Step ↓	
Diagnosis end.	

C1608-12

Fault diagnosis code
C1608-12: Motor terminal voltage
Detection tools
1 Multimeter and diagnostic apparatus
Possible causes
<ul style="list-style-type: none">• Circuit, terminal and adapting piece fault• INTERNAL FAULT• EPS
Conditions for fault code operation
Turn the ignition switch to ON position.
Conditions for fault code setting
C1608-12
Bus voltage - battery voltage $>5V$
To set the effect of a fault code condition
No assistance

Troubleshooting procedures	
Step1	General inspection.
	<ol style="list-style-type: none"> 1 Check if the fuse is damaged. 2 Check battery capacity. 3 Check the harness plug of EPS for damage, poor contact, aging and looseness. 4 Check whether the result is normal or not?
	NO → Repair or replace the faulted parts.
YES ↓	
Step2	Check fault codes.
	<ol style="list-style-type: none"> 1 Connect the fault diagnosis instrument to the diagnosis interface. 2 Turn the ignition switch to ON position. 3 Diagnose the EPS with diagnostic apparatus. 4 If there is any fault code except for C1608-12?
	YES → Refer to: DTC Summary list (EPS) .
NO ↓	
Step3	Perform initialization.
	<ol style="list-style-type: none"> 1 Turn the ignition switch to OFF. 2 Connect the fault diagnosis instrument to the diagnosis interface. 3 Turn on the ignition. 4 Use a diagnostic tool to initialize EPS. 5 Can EPS be initialized and restored to normal?
	NO → Repair or replace the EPS control module.
YES ↓	
Step4	Check the software version.
	<ol style="list-style-type: none"> 1 Turn the ignition switch to OFF. 2 Connect the fault diagnosis instrument to the diagnosis interface. 3 Turn on the ignition. 4 Use a diagnostic tool to read the software version information of EPS and update it to the latest matching version. 5 Is the software update normal?
	NO → Repair or replace the EPS control module.
YES ↓	

Step5	Test whether EPS is norm.
	<ol style="list-style-type: none"> 1 Turn the ignition switch to OFF. 2 Disconnect and check the harness plug BT07-B、 BT07-C、 BT07-D of EPS module. 3 Check and repair: <ul style="list-style-type: none"> • Corrosion(install new adapting piece or terminal-cleaning module and pin). • Pin damaged or bent-install new terminal/pin. 4 Fly out of pins-install new pins as needed. 5 Reconnect the EPS plug and all other previously disconnected plug. Make sure the pin is properly positioned and fixed. 6 Run the system and determine if the problem persists?.
	YES → Change the EPS .
NO ↓	
At this point the system is functioning normally. The problem may be caused by module connections. Address the root cause of any connector or pin problems.	
Next Step ↓	
Diagnosis end.	

EPS

U0073-88、 U1261-87、 U1261-81、 U1262-87、 U1262-81

Fault diagnosis code
U0073-88: CANBusoff
U1261-87: The message GW_EMS_261h timed out
U1261-81: The message GW_EMS_261h send value is invalid
U1262-87: The packet GW_IPK_362h timed out
U1262-81: The message GW_IPK_362h send value is invalid
Detection tools
1 Multimeter and diagnostic apparatus
Possible causes
<ul style="list-style-type: none">• Circuit,terminal and adapting piece fault• CAN• EPS
Conditions for fault code operation
Turn the ignition switch to ON position.
Conditions for fault code setting
U0073-88
When the cumulative error counter TEC of the CAN controller exceeds 255, the ECU enters a bus off state. 3 consecutive occurrences
U126187
Unable to receive message GW at 10 times the cycle_ EMS_ 261h
U126181
When 10 consecutive frames of messages meet any of the following conditions, 1.EngineStatusValidity=0x1: Invalid; 2. Message GW_ EMS_ The DLC length of 261h is not 8; 3.EngineStatus = 0x3.
U126287
Unable to receive message GW at 10 times the cycle_ IPK_ 362h
U126281
When 10 consecutive frames of messages meet any of the following conditions, 1. Message GW_ IPK_ The DLC length for 362 hours is not 8;2. ODOofIPK greater than 0xF423F;3.ODOofIPK=0xFFFFFFFF; 4.SystemBackupPowerModeValidity=0x1: Invalid;
To set the effect of a fault code condition
Default Assistance Provided
Description of circuit diagram
The device is connected to the serial data circuit and monitors the serial data communication during normal vehicle operation. Devices exchange operational information and instructions with each other. The device has programming information that needs to be exchanged on the serial data circuit. The receiver device also monitors this information; In addition, some regular information is used to indicate the availability of the transmitter device.

Circuit diagram

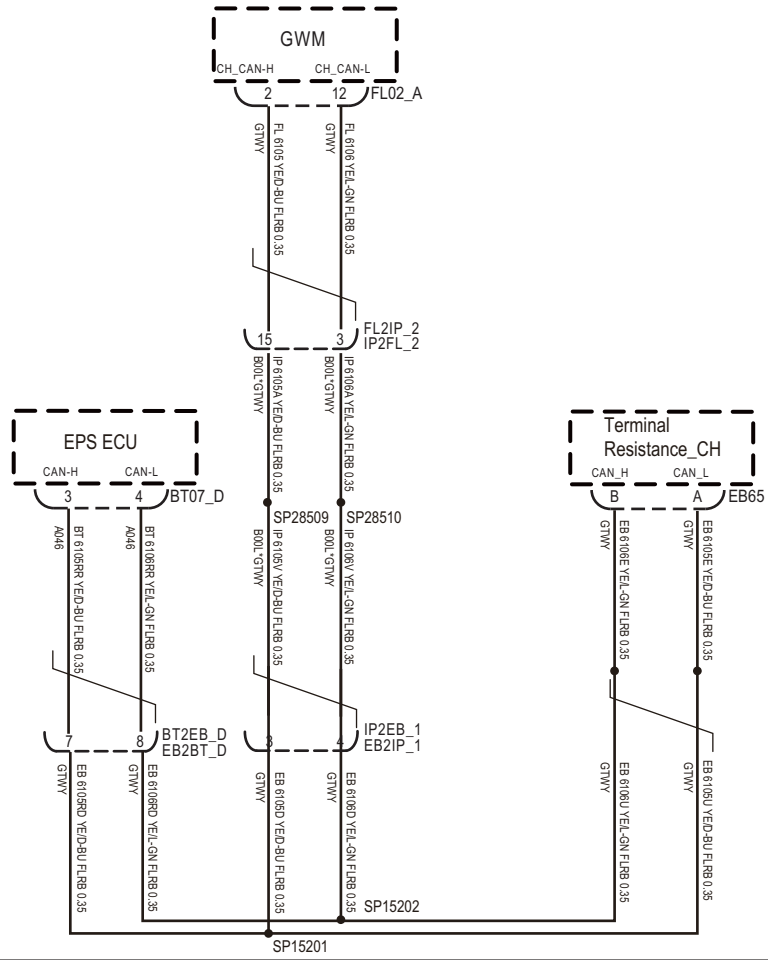

BT07_D

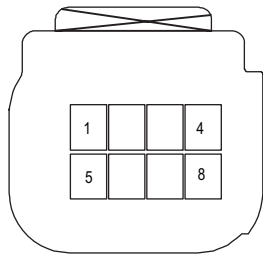

GWM

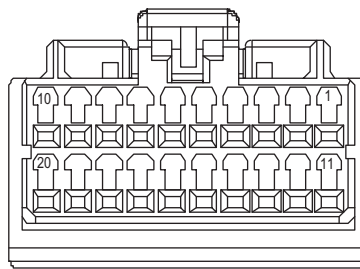

Terminal Resistance

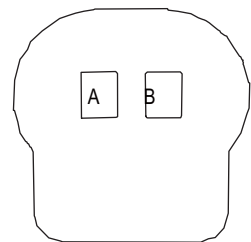

EK891505

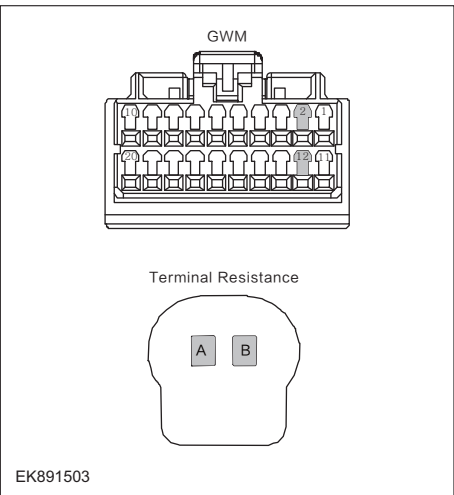
Troubleshooting procedures	
Step1	General inspection.
	<ol style="list-style-type: none"> 1 Check if the fuse is damaged. 2 Check battery capacity. 3 Check the harness plug of EPS for damage, poor contact, aging and looseness. 4 Check whether the result is normal or not?
NO → Repair or replace the faulted parts.	
YES ↓	
Step2	Check fault codes.
	<ol style="list-style-type: none"> 1 Connect the fault diagnosis instrument to the diagnosis interface. 2 Turn the ignition switch to ON position. 3 Diagnose the EPS with diagnostic apparatus. 4 If there is any fault code except for U0073-88、 U1261-87、 U1261-81、 U1262-87、 U1262-81?
YES → Refer to: DTC Summary list (EPS) .	
NO ↓	
Step3	Check the terminal resistance of the gateway module and CH CAN resistor.
	<ol style="list-style-type: none"> 1 Turn the ignition switch to OFF. 2 Disconnect the gateway module harness plug. 3 Measure the resistance between the harness terminals of the gateway module. Measuring circuit: The resistance between terminal 2 and terminal 12 of the gateway module plug. Standard value: 110~130 Ω 4 Connect the gateway module harness plug. 5 Disconnect the terminal resistor harness plug. 6 Measure the resistance between the harness terminals of the terminal resistance resistor. Measuring circuit: The resistance between terminal A and terminal B of the terminal resistance plug. Standard value: 110~130 Ω 7 Check whether the result is normal or not?
NO → Repair or replace the faulted parts.	
YES ↓	

Step4	Test whether EPS is norm.
	<ol style="list-style-type: none"> 1 Turn the ignition switch to OFF. 2 Disconnect and check the harness plug BT07-B、 BT07-C、 BT07-D of EPS module. 3 Check and repair: <ul style="list-style-type: none"> • Corrosion(install new adapting piece or terminal-cleaning module and pin). • Pin damaged or bent-install new terminal/pin. 4 Fly out of pins-install new pins as needed. 5 Reconnect the EPS plug and all other previously disconnected plug. Make sure the pin is properly positioned and fixed. 6 Run the system and determine if the problem persists?.
	YES → Change the EPS .
NO ↓	
At this point the system is functioning normally. The problem may be caused by module connections. Address the root cause of any connector or pin problems.	
Next Step ↓	
Diagnosis end.	

U1269-87、 U1269-81、 U1269-83、 U1269-82

Fault diagnosis code
The packet ABS_269h timed out
The message ABS_269h send value is invalid
Message ABS_269h - Incorrect Checksum
Message ABS_269h - Incorrect Alive Counter
Detection tools
1 Multimeter and diagnostic apparatus
Possible causes
<ul style="list-style-type: none"> • Circuit,terminal and adapting piece fault • ABD CAN • EPS
Conditions for fault code operation
Turn the ignition switch to ON position.
Conditions for fault code setting
U1269-87
Unable to receive message ABS at 10 times the cycle_ 269h
U1269-81
When 10 consecutive frames of messages meet any of the following conditions,
<ol style="list-style-type: none"> 1. Message ABS_ The DLC length of 269h is not 8; 2. The vehicle speed value is greater than 0x14D6; 3. The vehicle speed value is 0x1FFF; 4. VehicleSpeedStatus=0x1: Invalid; "
U1269-83
When 10 consecutive frames of messages meet the following conditions: ABSChecksum detected_ The signal value of 0x269 does not comply with the algorithm;"
U1269-82
When 10 consecutive frames of messages meet the following conditions: ABSMessageCounter_ When the signal value is discontinuous"
To set the effect of a fault code condition
Description of circuit diagram
The device is connected to the serial data circuit and monitors the serial data communication during normal vehicle operation. Devices exchange operational information and instructions with each other. The device has programming information that needs to be exchanged on the serial data circuit. The receiver device also monitors this information; In addition, some regular information is used to indicate the availability of the transmitter device.

Circuit diagram

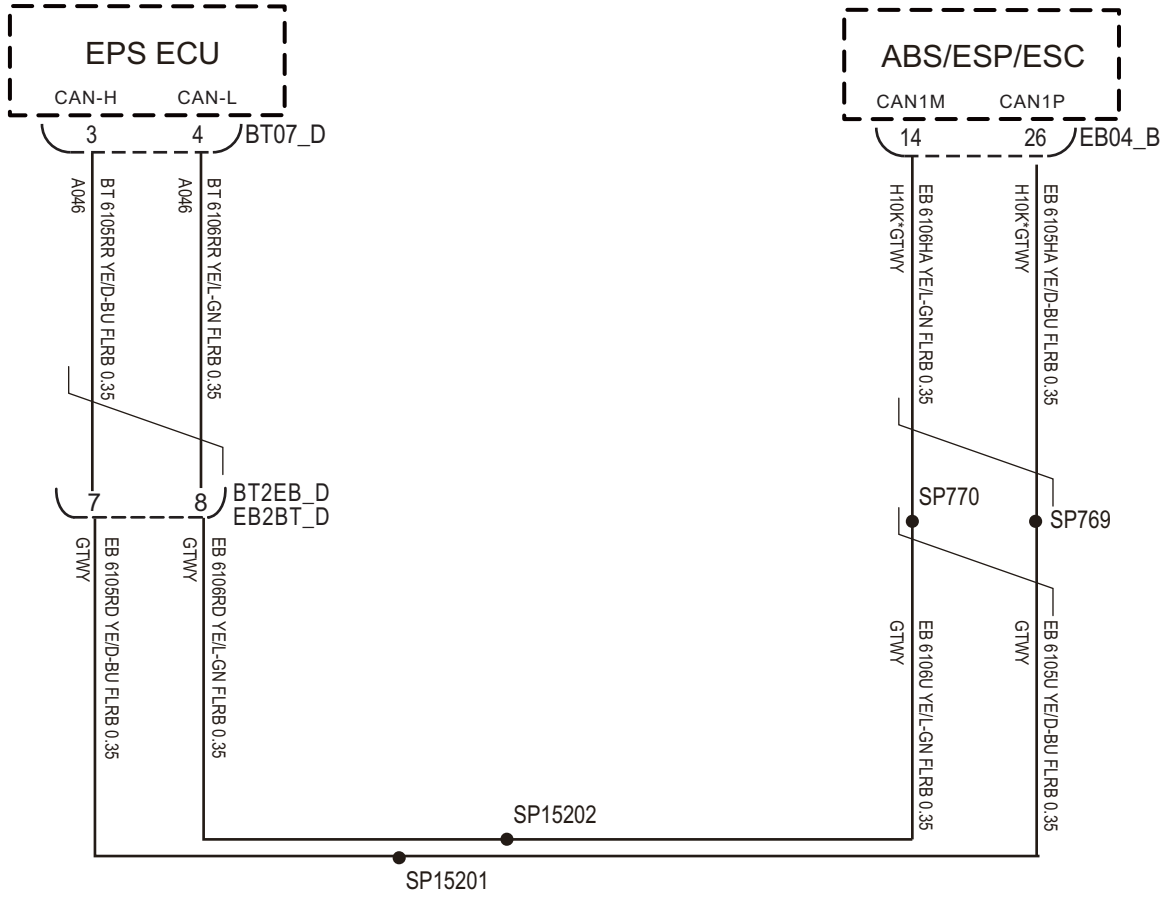

BT07_D

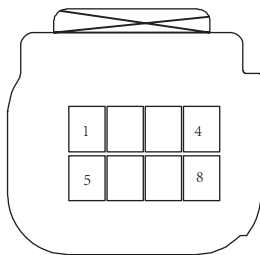

ABS

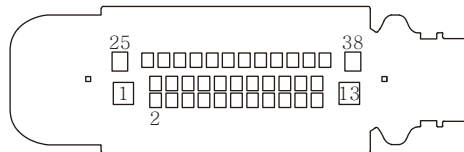

Terminal Resistance

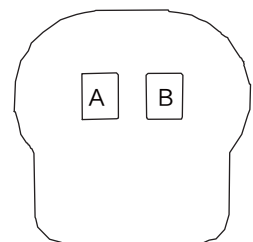

EK891507

Troubleshooting procedures	
Step1	General inspection.
	<ol style="list-style-type: none"> 1 Check if the fuse is damaged. 2 Check battery capacity. 3 Check the harness plug of EPS for damage, poor contact, aging and looseness. 4 Check whether the result is normal or not?
	NO → Repair or replace the faulted parts.
YES ↓	
Step2	Check fault codes.
	<ol style="list-style-type: none"> 1 Connect the fault diagnosis instrument to the diagnosis interface. 2 Turn the ignition switch to ON position. 3 Diagnose the EPS with diagnostic apparatus. 4 If there is any fault code except for U1269-87、 U1269-81、 U1269-83、 U1269-82?
	YES → Refer to: DTC Summary list (EPS) .
NO ↓	
Step3	Check the terminal resistance of the brake anti lock system and CH CAN resistor.
	<ol style="list-style-type: none"> 1 Turn the ignition switch to OFF. 2 Disconnect the harness plug of the brake anti lock system. 3 Measure the resistance between the harness terminals of the brake anti lock system. Measuring circuit: The resistance between terminal 14 and terminal 26 of the brake anti lock system plug. Standard value: 110~130 Ω 4 Connect the gateway module harness plug. 5 Disconnect the terminal resistor harness plug. 6 Measure the resistance between the harness terminals of the terminal resistance resistor. Measuring circuit: The resistance between terminal A and terminal B of the terminal resistance plug. Standard value: 110~130 Ω 7 Check whether the result is normal or not?
	NO → Repair or replace the faulted parts.
YES ↓	

Step4	Test whether EPS is norm.
	<ol style="list-style-type: none"> 1 Turn the ignition switch to OFF. 2 Disconnect and check the harness plug BT07-B、 BT07-C、 BT07-D of EPS module. 3 Check and repair: <ul style="list-style-type: none"> • Corrosion(install new adapting piece or terminal-cleaning module and pin). • Pin damaged or bent-install new terminal/pin. 4 Fly out of pins-install new pins as needed. 5 Reconnect the EPS plug and all other previously disconnected plug. Make sure the pin is properly positioned and fixed. 6 Run the system and determine if the problem persists?.
	YES → Change the EPS .
NO ↓	
At this point the system is functioning normally. The problem may be caused by module connections. Address the root cause of any connector or pin problems.	
Next Step ↓	
Diagnosis end.	

DTC Summary List (FICM) - left

DTC	English descriptions	Reference page
U1562-17	Battery Voltage High	U1562-17 , U1563-16
U1563-16	Battery Voltage Low	
U2020-47	Internal Watchdog error	U2020-47
U1500-00	VIN Mismatch with BCM (or IPK)	U1500-00
B1A1D-87	Lost Display Communication With LCD Panel Module via LVDS	B1A1D-87
U0100-87	Lost Communication With EMS Module	U0100-87
U0127-87	Lost Communication With TPMS Module	U0127-87
U0073-88	Control Module Communication Bus Off	U0073-88
U010F-87	Lost Communication With Air Conditioning Control Module	U010F-87
U0155-87	Lost Communication With IPK Module	U0155-87
U0140-87	Lost Communication With BCM Module	U0140-87
U0126-87	Lost Communication With SAS Module	U0126-87
U1031-87	Lost Communication With Infotainment Faceplate Module	U1031-87
U0121-87	Lost Communication With ESP or ABS Module	U0121-87
U0101-87	Lost Communication With TCU Module	U0101-87
B1A10-12	TUNER's antenna short to Battery	B1A10-12 , B1A10-11 , B1A10-13 , B1A10-19
B1A10-11	TUNER's antenna short to GND	
B1A10-13	The open circuit detection of TUNER's antenna	
B1A10-19	The Over-Current detection of TUNER's antenna	
U0237-87	Lost Communication With PEPS Module	U0237-87
U0236-87	Lost Communication With LDW Module	U0236-87
B1A20-11	Speaker FrontRight Short to Ground	B1A20-11 , B1A20-12 , B1A20-1A , B1A20-1B
B1A20-12	Speaker FrontRight circuit short to battery	
B1A20-1A	Speaker FrontRight circuit short	
B1A20-1B	Speaker FrontRight circuit open	
B1A21-11	Speaker FrontLeft Short to Ground	B1A21-11 , B1A21-12 , B1A21-1A , B1A21-1B
B1A21-12	Speaker FrontLeft circuit short to battery	
B1A21-1A	Speaker FrontLeft circuit short	
B1A21-1B	Speaker FrontLeft circuit open	
B1A22-11	Speaker RearRight Short to Ground	B1A22-11 , B1A22-12 , B1A22-1A , B1A22-1B
B1A22-12	Speaker RearRight circuit short to battery	
B1A22-1A	Speaker RearRight circuit short	
B1A22-1B	Speaker RearRight circuit open	

FICM

DTC	English descriptions	Reference page
B1A23-11	Speaker RearLeft Short to Ground	B1A23-11 , B1A23-12 , B1A23-1A , B1A23-1B
B1A23-12	Speaker RearLeft circuit short to battery	
B1A23-1A	Speaker RearLeft circuit short	
B1A23-1B	Speaker RearLeft circuit open	
B1A27-01	Power of USB port for TBOX Error	B1A27-01
B1A24-01	Power of USB1 port Error	B1A24-01
B1A26-01	Power of USB2 port Error	B1A26-01
B1A25-12	MIC1 short to Battery	B1A25-12 , B1A25-11 , B1A25-13 , B1A28-12 , B1A28-11 , B1A28-13
B1A25-11	MIC1 short to GND	
B1A25-13	MIC1 circuit open	
B1A28-12	MIC2 short to Battery	
B1A28-11	MIC2 short to GND	
B1A28-13	MIC2 circuit open	
B1A4E-71	Music or 360 Switch-faceplate stuck	B1A4E-71 , B1A50-11 , B1A4C-71 , B1A4D-71 , B1A39-71 , B1A3A-71
B1A50-11	Separate Infotainment Faceplate short to Ground	
B1A4C-71	Car Switch-faceplate stuck	
B1A4D-71	Music Switch-faceplate stuck	
B1A39-71	Volume Up Switch-faceplate stuck	
B1A3A-71	Volume Down Switch-faceplate stuck	
B1AA0-12	Infotainment Faceplate Enable Circuit Short to Battery	B1AA0-12 , B1AA0-11 , B1A50-15
B1AA0-11	Infotainment Faceplate Enable Circuit Short to Ground	
B1A50-15	Separate Infotainment Faceplate short to Battery or Open	
B1A3E-71	Seek Up Switch-SWC stuck	B1A3E-71 , B1A3F-71 , B1A01-71 , B1A02-71 , B1A05-71 , B1A06-71 , B1A07-71 , B1A08-71 , B1A4B-71
B1A01-71	Call/RejectSwitch-SWCstuck	
B1A02-71	MuteSwitch-SWCstuck	
B1A05-71	VolumeUpSwitch-SWCstuck	
B1A06-71	VolumeDownSwitch-SWCstuck	
B1A07-71	SourceSwitch-SWCstuck	
B1A08-71	VoiceSwitch-SWCstuck	
B1A4B-71	CustomSwitch-SWCstuck	
B1A3F-71	SeekDownSwitch-SWCstuck	
B1AE4-12	RearcameraVideoSignalCircuitShorttoBattery	
B1AE9-12	CameraPowershorttobattery	
B1AE9-11	CameraPowershorttoGND	

U1562-17、 U1563-16

Fault diagnosis code
U1562-17: Circuit voltage below threshold
U1563-16: Circuit voltage above threshold
Detection tools
1 Multimeter and diagnostic apparatus
Possible causes
<ul style="list-style-type: none"> • Circuit,terminal and adapting piece • Battery • FICM • Charging system • Insurance fuse
Conditions for fault code operation
Turn the ignition switch to the ON position
Conditions for fault code setting
U1562-17
U1563-16
To set the effect of a fault code condition
Description of circuit diagram
The FICM will monitor whether all sensors and actuators are within normal range all the time. Meanwhile,it will check the connector for virtual connection, short circuit, open circuit and the connection rationality with other signals. When fault occurs, the FICM module will save the fault code corresponding to that fault and enable safety mode.

Circuit diagram

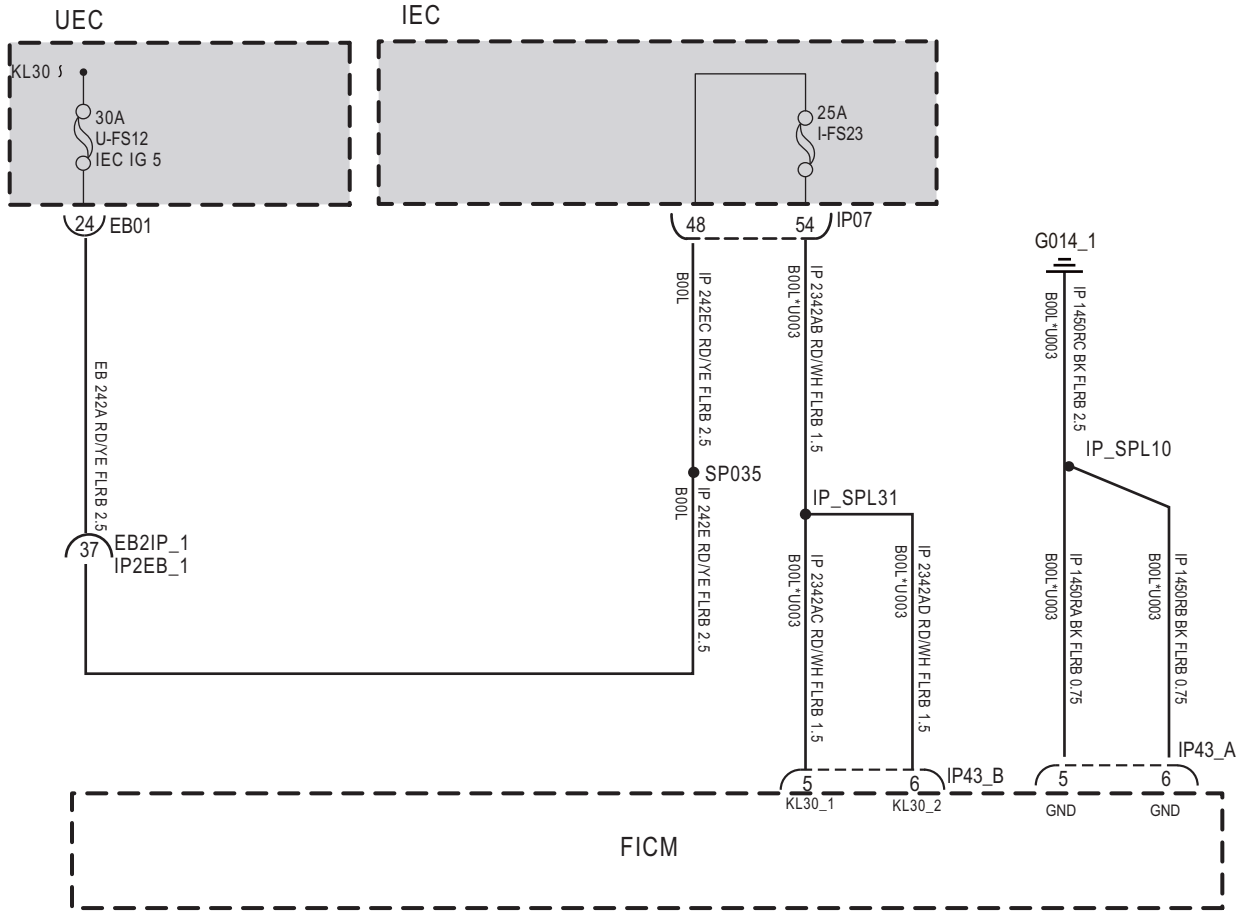

IP43_A

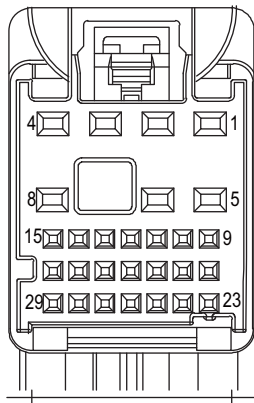

IP43_B

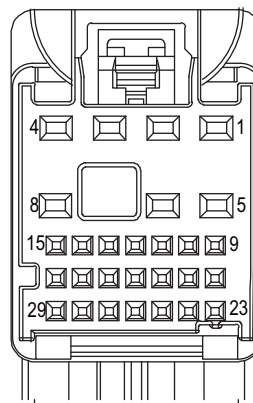

EK896001

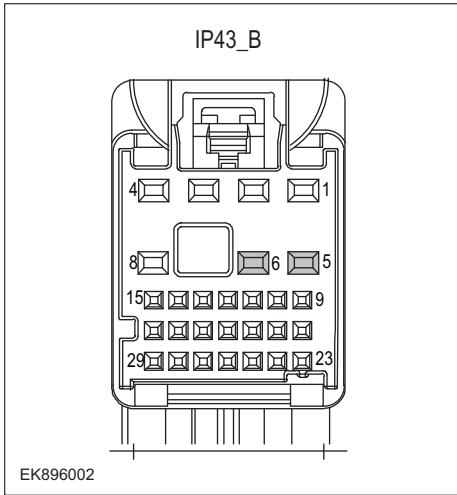
Troubleshooting steps	
Steps1	General inspection.
	<ol style="list-style-type: none"> 1 Check fuses U-FS12、 I-FS23 for damage. 2 Check battery capacity. 3 Check the harness plug of FICM for damage, poor contact, aging and looseness. 4 Check whether the result is normal or not?
	NO → Repair or replace the faulted parts.
YES ↓	
Steps2	Check fault codes.
	<ol style="list-style-type: none"> 1 Connect the fault diagnosis instrument to the diagnosis interface. 2 Turn the ignition switch to ON position. 3 Diagnose the FICM with diagnostic apparatus. 4 If there is any fault code except for U1562-17、 U1563-16?
	YES → Refer to: DTC Summary List (FICM) - left.
NO ↓	
Steps3	Check the FICMBattery power supply voltage.
	<ol style="list-style-type: none"> 1 Turn the ignition switch to OFF. 2 Disconnect the harness plug IP43_B of FICM module. 3 Measure the voltage between the FICM harness terminal and ground. Measuring circuit: IP43_ The voltage between terminal 5 of plug B and the grounding. Measuring circuit: IP43_ The voltage between terminal 6 of plug B and the grounding. Standard value:10~14V 4 Check whether the result is normal or not?
	NO → Repair or replace the faulted parts.
YES ↓	

FICM

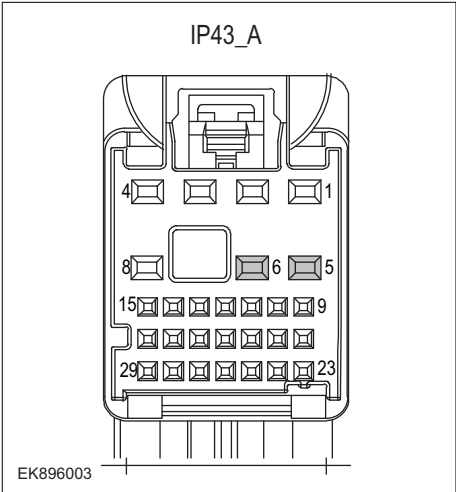
Steps4	Check the power voltage when the FICM is started or operating
	<ol style="list-style-type: none"> 1 Turn the ignition switch to OFF. 2 Disconnect the FICM harness plug IP43_ A. 3 Measure the resistance between the FICM harness plug and ground. Measuring circuit: IP43_ The resistance between terminal 5 of plug A and the grounding. Measuring circuit: IP43_ The resistance between terminal 6 of plug A and the grounding. Standard value: < 1Ω 4 Test whether the resistance is less than 1Ω?
NO → Repair or replace the faulted parts.	
YES ↓	
Steps5	Test whether FICM is norm.
	<ol style="list-style-type: none"> 1 Turn the ignition switch to OFF. 2 Disconnect and check the FICM harness plug IP43_ A, IP43_ B. 3 Check and repair. <ul style="list-style-type: none"> • Corrosion(install new adapting piece or terminal-cleaning module and pin). • Pin damaged or bent-install new terminal/pin. 4 Fly out of pins-install new pins as needed. 5 Reconnect the FICM plug and all other previously disconnected plug. Make sure the pin is properly positioned and fixed. 6 Run the system and determine if the problem persists?
YES → Change the FICM Module	
NO ↓	
At this point the system is functioning normally. The problem may be caused by module connections. Address the root cause of any connector or pin problems.	
Next Step ↓	
Diagnosis end.	

U2020-47

Fault diagnosis code
U2020-47: Internal Watchdog error
Detection tools
1 Multimeter and diagnostic apparatus
Possible causes
<ul style="list-style-type: none"> • Circuit,terminal and adapting piece • Battery • FICM • Charging system • Insurance fuse
Conditions for fault code operation
Turn the ignition switch to the ON position
Conditions for fault code setting
U2020-47
To set the effect of a fault code condition
Description of circuit diagram
The FICM will monitor whether all sensors and actuators are within normal range all the time. Meanwhile,it will check the connector for virtual connection, short circuit, open circuit and the connection rationality with other signals. When fault occurs, the FICM module will save the fault code corresponding to that fault and enable safety mode.

Circuit diagram

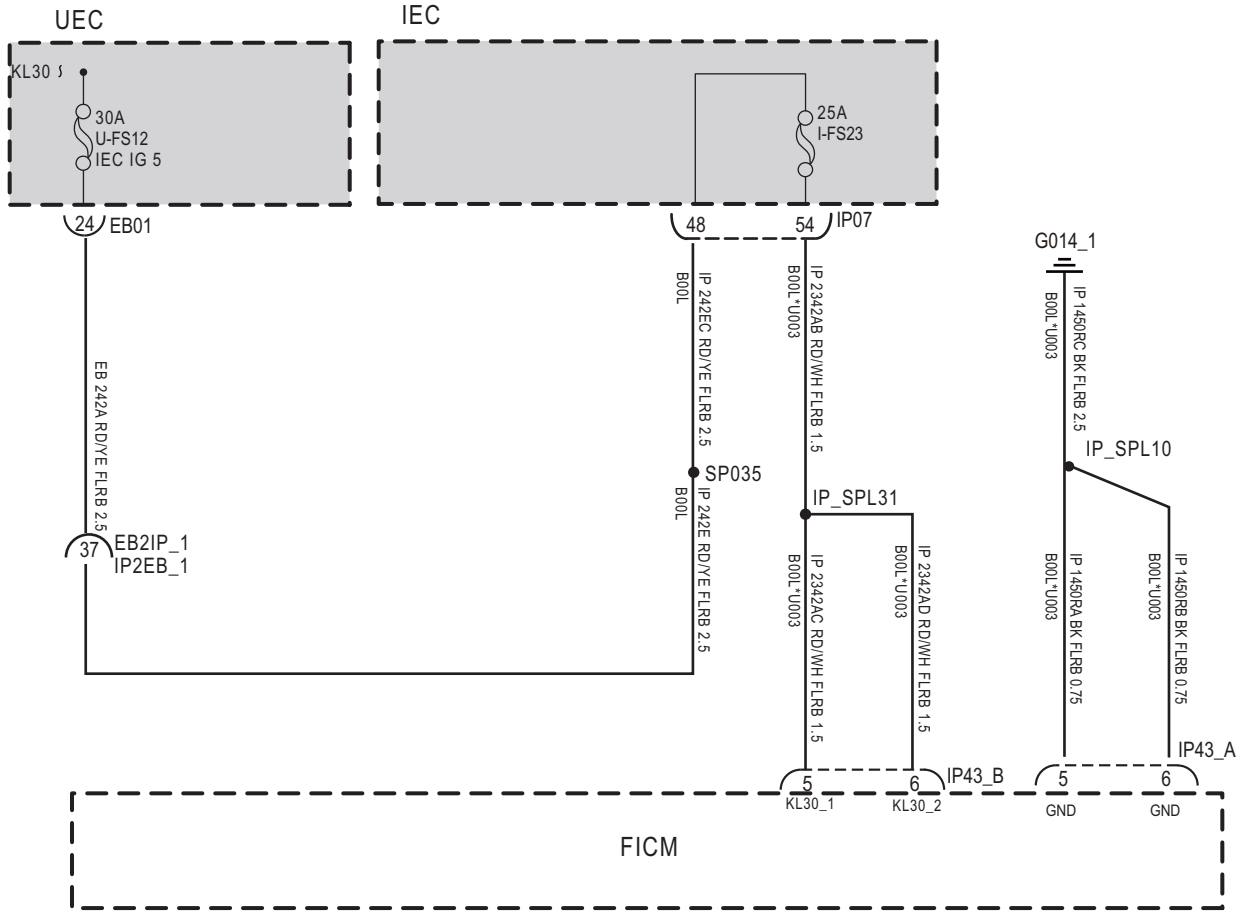

IP43_A

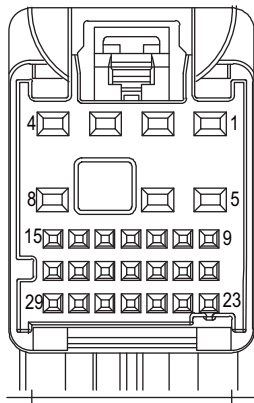

IP43_B

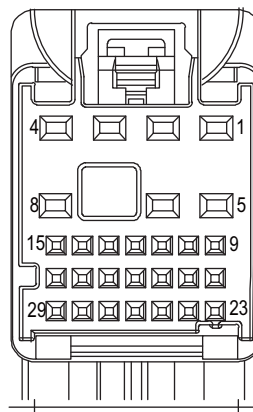

EK896001

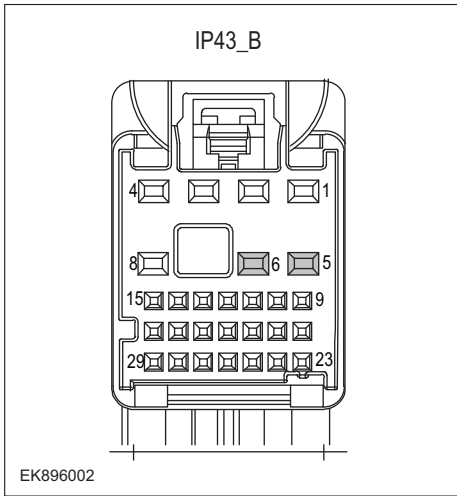
Troubleshooting steps	
Steps1	General inspection.
	<ol style="list-style-type: none"> 1 Check fusesU-FS12、 I-FS23 for damage. 2 Check battery capacity. 3 Check the harness plug of FICM for damage, poor contact, aging and looseness. 4 Check whether the result is normal or not?
	NO → Repair or replace the faulted parts.
YES ↓	
Steps2	Check fault codes.
	<ol style="list-style-type: none"> 1 Connect the fault diagnosis instrument to the diagnosis interface. 2 Turn the ignition switch to ON position. 3 Diagnose the FICM with diagnostic apparatus. 4 If there is any fault code except for U2020-47?
	YES → Refer to: DTC Summary List (FICM) - left .
NO ↓	
Steps3	Check the FICMBattery power supply voltage.
	<ol style="list-style-type: none"> 1 Turn the ignition switch to OFF. 2 Disconnect the harness plug IP43_B of FICM module. 3 Measure the voltage between the FICM harness terminal and ground. Measuring circuit: IP43_ The voltage between terminal 5 of plug B and the grounding. Measuring circuit: IP43_ The voltage between terminal 6 of plug B and the grounding. Standard value:10~14V 4 Check whether the result is normal or not?
	NO → Repair or replace the faulted parts.
YES ↓	

FICM

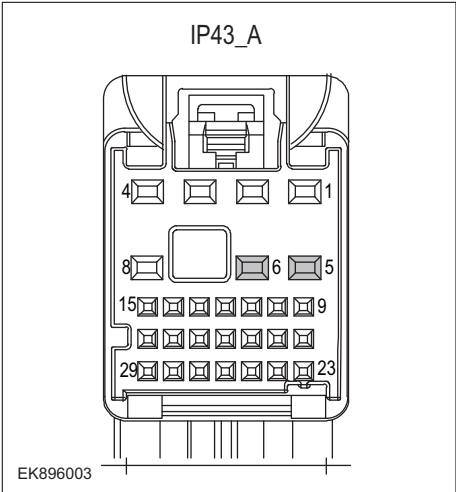
Steps4	Check the power voltage when the FICM is started or operating
	<ol style="list-style-type: none"> 1 Turn the ignition switch to OFF. 2 Disconnect the FICM harness plug IP43_ A. 3 Measure the resistance between the FICM harness plug and ground. Measuring circuit: IP43_ The resistance between terminal 5 of plug A and the grounding. Measuring circuit: IP43_ The resistance between terminal 6 of plug A and the grounding. Standard value: < 1Ω 4 Test whether the resistance is less than 1Ω?
NO → Repair or replace the faulted parts.	
YES ↓	
Steps5	Test whether FICM is norm.
	<ol style="list-style-type: none"> 1 Turn the ignition switch to OFF. 2 Disconnect and check the FICM harness plug IP43_ A, IP43_ B. 3 Check and repair. <ul style="list-style-type: none"> • Corrosion(install new adapting piece or terminal-cleaning module and pin). • Pin damaged or bent-install new terminal/pin. 4 Fly out of pins-install new pins as needed. 5 Reconnect the FICM plug and all other previously disconnected plug. Make sure the pin is properly positioned and fixed. 6 Run the system and determine if the problem persists?
YES → Change the FICM Module	
NO ↓	
At this point the system is functioning normally. The problem may be caused by module connections. Address the root cause of any connector or pin problems.	
Next Step ↓	
Diagnosis end.	

U1500-00

Fault diagnosis code
U1500-00: VIN Mismatch with BCM (or IPK)
Detection tools
1 Multimeter and diagnostic apparatus
Possible causes
<ul style="list-style-type: none">• Circuit, terminal and adapting piece• FICM• PEM
Conditions for fault code operation
Turn the ignition switch to the ON position
Conditions for fault code setting
U1500-00
To set the effect of a fault code condition

Troubleshooting steps	
Steps1	General inspection.
	<ol style="list-style-type: none"> 1 Check if the Insurance fuse is damaged. 2 Check the relay for damage 3 Check battery capacity. 4 Check the main relay and FICM harness plugs for damage, poor contact, aging, and looseness. 5 Check whether the result is normal or not?
	NO → Repair or replace the faulted parts.
YES ↓	
Steps2	Check fault codes.
	<ol style="list-style-type: none"> 1 Connect the fault diagnosis instrument to the diagnosis interface. 2 Turn the ignition switch to ON position. 3 Diagnose the FICM with diagnostic apparatus. 4 If there is any fault code except for U1500-00?
	YES → Refer to: DTC Summary List (FICM) - left .
NO ↓	
Steps3	Check BCM module fault codes.
	<ol style="list-style-type: none"> 1 Turn the ignition switch to OFF. 2 Connect the fault diagnosis instrument to the diagnosis interface. 3 Turn the ignition switch to ON position. 4 Use a diagnostic tool to diagnose the BCM. 5 Check whether the result is normal or not?
	NO → Please diagnose according to the specific DTC.
YES ↓	

Steps4	Test whether FICM is norm.
	<ol style="list-style-type: none"> 1 Turn the ignition switch to OFF. 2 Disconnect and check the FICM harness plug IP43_ A, IP43_ B. 3 Check and repair. <ul style="list-style-type: none"> • Corrosion(install new adapting piece or terminal-cleaning module and pin). • Pin damaged or bent-install new terminal/pin. • Fly out of pins-install new pins as needed. 4 Reconnect the FICM plug and all other previously disconnected plug. Make sure the pin is properly positioned and fixed. 5 Run the system and determine if the problem persists?
	YES → Change the FICM Module
NO ↓	
At this point the system is functioning normally. The problem may be caused by module connections. Address the root cause of any connector or pin problems.	
Next Step ↓	
Diagnosis end.	

B1A1D-87

Fault diagnosis code
B1A1D-87: Lost Display Communication With LCD Panel Module via LVDS
Detection tools
1 Multimeter and diagnostic apparatus
Possible causes
<ul style="list-style-type: none"> • Circuit, terminal and adapting piece • FICM • GWM
Conditions for fault code operation
Turn the ignition switch to the ON position
Conditions for fault code setting
B1A1D-87
To set the effect of a fault code condition
Description of circuit diagram
<p>The device is connected to the serial data circuit and monitors the serial data communication during normal vehicle operation. Devices exchange operational information and instructions with each other. The device has programming information that needs to be exchanged on the serial data circuit. The receiver device also monitors this information; In addition, some regular information is used to indicate the availability of the transmitter device.</p>

Circuit diagram

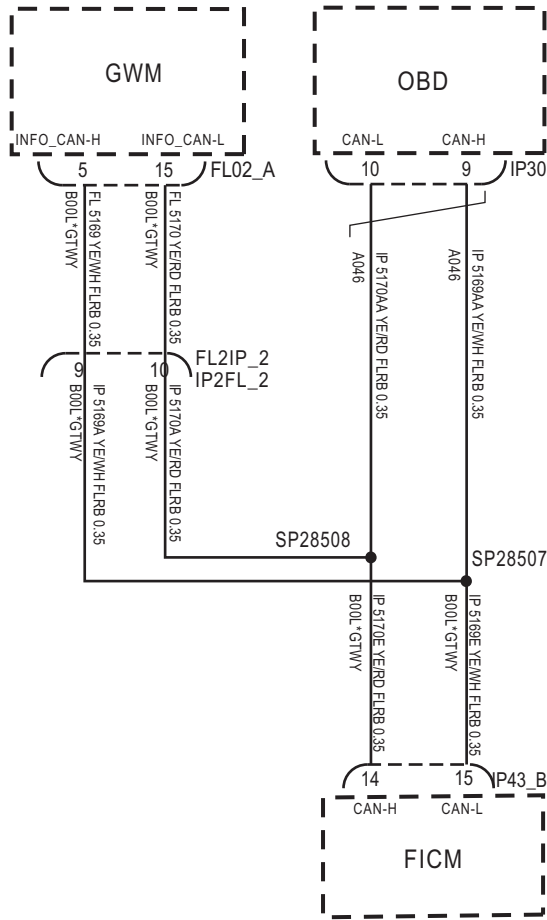

IP43_B

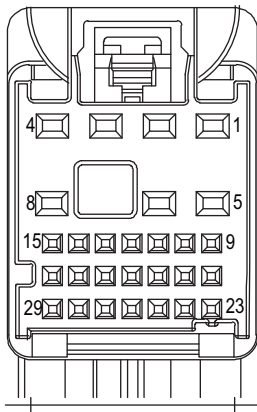

EK896004

FL02_A

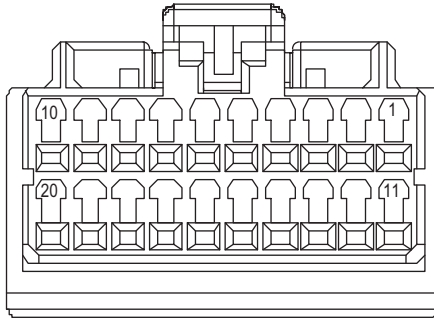

IP30

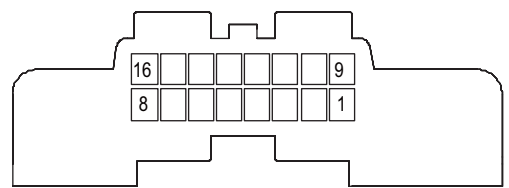

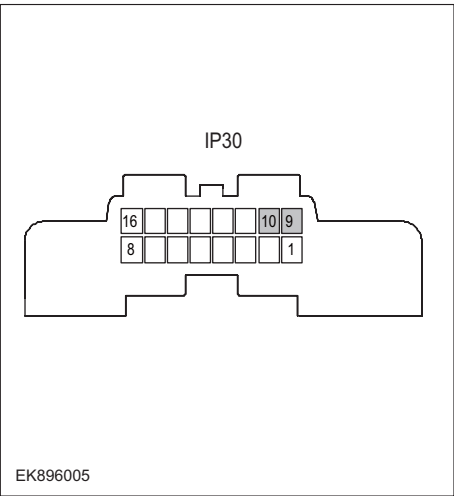
Troubleshooting steps	
Steps1	General inspection.
	<ol style="list-style-type: none"> 1 Check if the Insurance fuse is damaged. 2 Check battery capacity. 3 Check the GWM harness plug for damage, poor contact, aging, and looseness. 4 Check whether the result is normal or not?
NO → Repair or replace the faulted parts.	
YES ↓	
Steps2	Check fault codes.
	<ol style="list-style-type: none"> 1 Connect the fault diagnosis instrument to the diagnosis interface. 2 Turn the ignition switch to ON position. 3 Diagnose the GWM with diagnostic apparatus. 4 If there is any fault code except for B1A1D-87?
YES → Refer to: DTC Summary List (FICM) - left .	
NO ↓	
Steps3	Check the integrity of the CAN communication network.
	<ol style="list-style-type: none"> 1 Turn the ignition switch to OFF. 2 Measure the resistance between the diagnostic interface harness terminals. Measuring circuit: The resistance between terminal 9 and terminal 10 of IP30 plug. Standard value: $\approx 60 \Omega$ 3 Check whether the result is normal or not?
NO → Repair or replace the faulted parts.	
YES ↓	

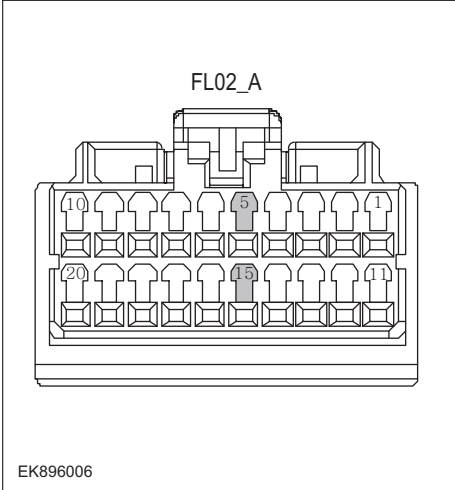
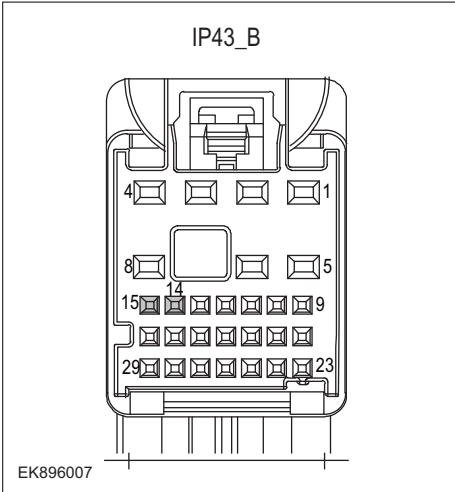
<p>Steps4</p>	<p>Check the terminal resistance of GWM and FICM.</p>
<div style="text-align: center;">  <p>FL02_A</p> <p>EK896006</p> </div> <div style="text-align: center; margin-top: 20px;">  <p>IP43_B</p> <p>EK896007</p> </div>	<ol style="list-style-type: none"> 1 Turn the ignition switch to OFF. 2 Disconnect the GWM harness plug FL02_ A. 3 Measure the resistance between the GWM harness terminals. Measuring circuit: FL02_ The resistance between terminal 5 and terminal 15 of plug A. Standard value: 110~130 Ω 4 Connect GWM harness plug FL02_ A. 5 Disconnect the harness plug IP43_ B of FICM module. 6 Measure the resistance between the FICM harness terminals. Measuring circuit: IP43_ The resistance between terminal 14 and terminal 15 of plug B. Standard value: 110~130 Ω 7 Check whether the result is normal or not?
<p>YES ↓</p>	<p>NO → Repair or replace the faulted parts.</p>

FICM

Steps5	Test whether FICM is norm.
	<ol style="list-style-type: none">1 Turn the ignition switch to OFF.2 Disconnect and check the FICM harness plug IP43_ A, IP43_ B.3 Check and repair.<ul style="list-style-type: none">• Corrosion(install new adapting piece or terminal-cleaning module and pin).• Pin damaged or bent-install new terminal/pin.• Fly out of pins-install new pins as needed.4 Reconnect the FICM plug and all other previously disconnected plug. Make sure the pin is properly positioned and fixed.5 Run the system and determine if the problem persists?
	YES → Change the FICM Module
NO ↓	
At this point the system is functioning normally. The problem may be caused by module connections. Address the root cause of any connector or pin problems.	
Next Step ↓	
Diagnosis end.	

U0100-87

Fault diagnosis code
U0100-87: Lost Communication With EMS Module
Detection tools
1 Multimeter and diagnostic apparatus
Possible causes
<ul style="list-style-type: none"> • Circuit, terminal and adapting piece • FICM • GWM
Conditions for fault code operation
Turn the ignition switch to the ON position
Conditions for fault code setting
U0100-87
To set the effect of a fault code condition
Description of circuit diagram
<p>The device is connected to the serial data circuit and monitors the serial data communication during normal vehicle operation. Devices exchange operational information and instructions with each other. The device has programming information that needs to be exchanged on the serial data circuit. The receiver device also monitors this information; In addition, some regular information is used to indicate the availability of the transmitter device.</p>

Circuit diagram

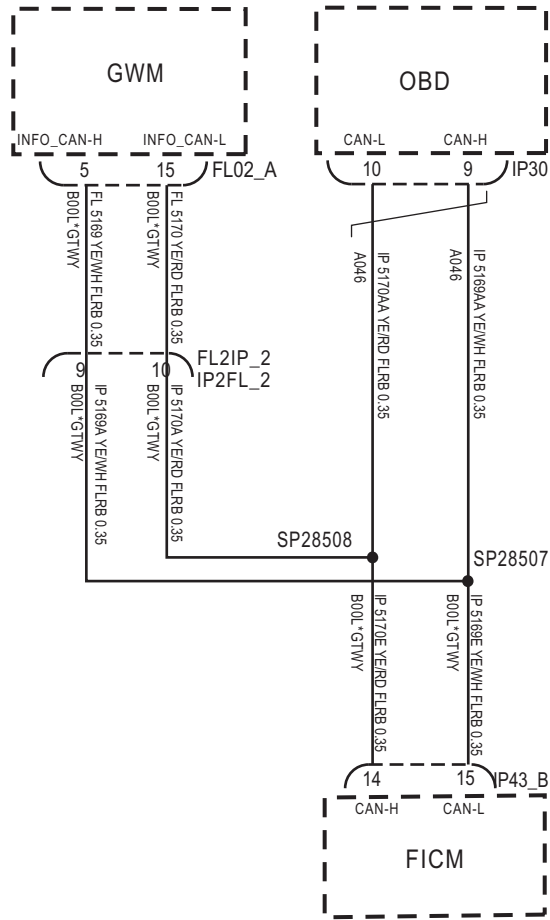

IP43_B

FL02_A

IP30

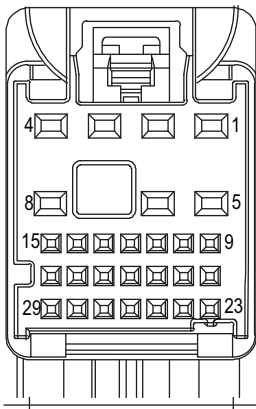

EK896004

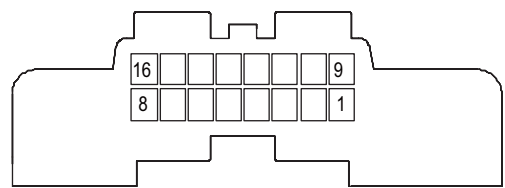
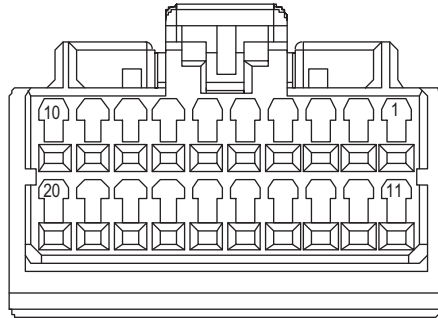

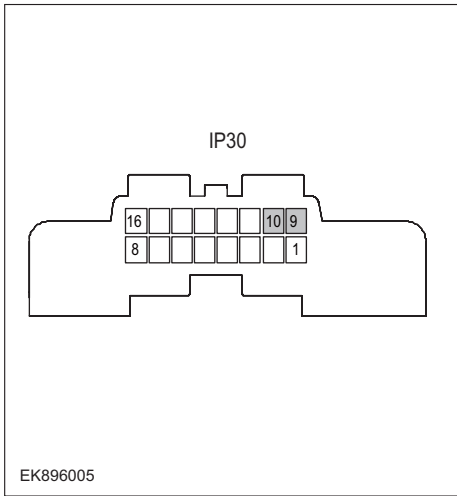
Troubleshooting steps	
Steps1	General inspection.
	<ol style="list-style-type: none"> 1 Check if the Insurance fuse is damaged. 2 Check battery capacity. 3 Check the GWM harness plug for damage, poor contact, aging, and looseness. 4 Check whether the result is normal or not?
	NO → Repair or replace the faulted parts.
YES ↓	
Steps2	Check fault codes.
	<ol style="list-style-type: none"> 1 Connect the fault diagnosis instrument to the diagnosis interface. 2 Turn the ignition switch to ON position. 3 Diagnose the GWM with diagnostic apparatus. 4 If there is any fault code except for U0100-87?
	YES → Refer to: DTC Summary List (FICM) - left .
NO ↓	
Steps3	Check the integrity of the CAN communication network.
 <p style="text-align: center;">IP30</p> <p style="text-align: center;">EK896005</p>	<ol style="list-style-type: none"> 1 Turn the ignition switch to OFF. 2 Measure the resistance between the diagnostic interface harness terminals. Measuring circuit: The resistance between terminal 9 and terminal 10 of IP30 plug. Standard value: ≈ 60 Ω 3 Check whether the result is normal or not?
	NO → Repair or replace the faulted parts.
YES ↓	

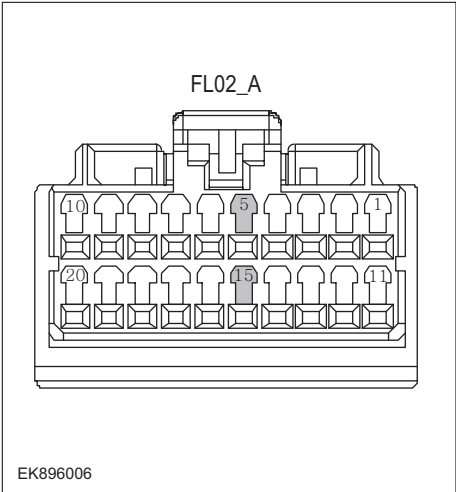
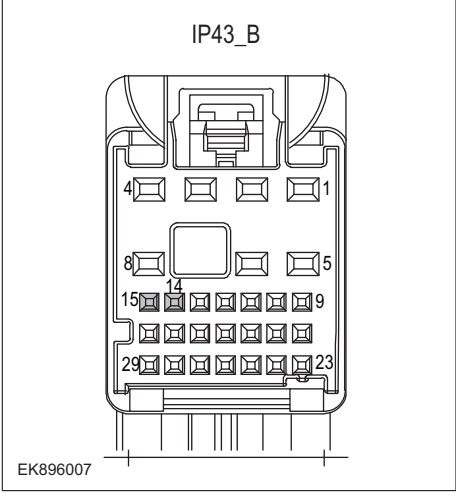
Steps4	Check the terminal resistance of GWM and FICM.
<div style="text-align: center;">  <p>FL02_A</p> <p>EK896006</p> </div> <div style="text-align: center; margin-top: 20px;">  <p>IP43_B</p> <p>EK896007</p> </div>	<ol style="list-style-type: none"> 1 Turn the ignition switch to OFF. 2 Disconnect the GWM harness plug FL02_ A. 3 Measure the resistance between the GWM harness terminals. Measuring circuit: FL02_ The resistance between terminal 5 and terminal 15 of plug A. Standard value: 110~130 Ω 4 Connect GWM harness plug FL02_ A. 5 Disconnect the harness plug IP43_ B of FICM module. 6 Measure the resistance between the FICM harness terminals. Measuring circuit: IP43_ The resistance between terminal 14 and terminal 15 of plug B. Standard value: 110~130 Ω 7 Check whether the result is normal or not?
	<p>NO → Repair or replace the faulted parts.</p>
<p>YES ↓</p>	

Steps5	Test whether FICM is norm.
	<ol style="list-style-type: none"> 1 Turn the ignition switch to OFF. 2 Disconnect and check the FICM harness plug IP43_ A、IP43_ B. 3 Check and repair. <ul style="list-style-type: none"> • Corrosion(install new adapting piece or terminal-cleaning module and pin). • Pin damaged or bent-install new terminal/pin. • Fly out of pins-install new pins as needed. 4 Reconnect the FICM plug and all other previously disconnected plug. Make sure the pin is properly positioned and fixed. 5 Run the system and determine if the problem persists?
	YES → Change the FICM Module
NO ↓	
At this point the system is functioning normally. The problem may be caused by module connections. Address the root cause of any connector or pin problems.	
Next Step ↓	
Diagnosis end.	

U0127-87

Fault diagnosis code
U0127-87: Lost Communication With TPMS Module
Detection tools
1 Multimeter and diagnostic apparatus
Possible causes
<ul style="list-style-type: none"> • Circuit, terminal and adapting piece • FICM • GWM
Conditions for fault code operation
Turn the ignition switch to the ON position
Conditions for fault code setting
U0127-87
To set the effect of a fault code condition
Description of circuit diagram
<p>The device is connected to the serial data circuit and monitors the serial data communication during normal vehicle operation. Devices exchange operational information and instructions with each other. The device has programming information that needs to be exchanged on the serial data circuit. The receiver device also monitors this information; In addition, some regular information is used to indicate the availability of the transmitter device.</p>

Circuit diagram

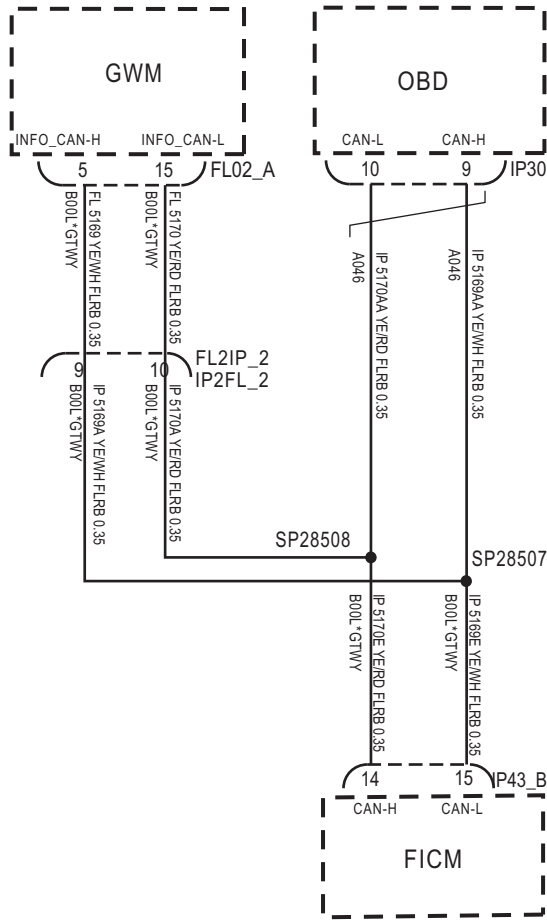

IP43_B

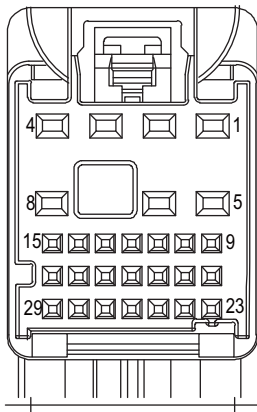

EK896004

FL02_A

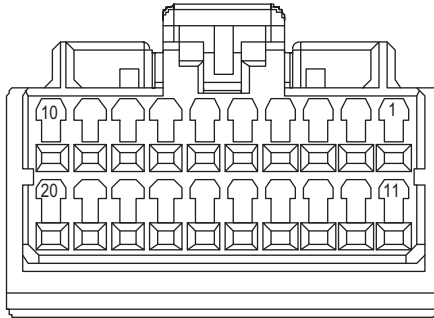

IP30

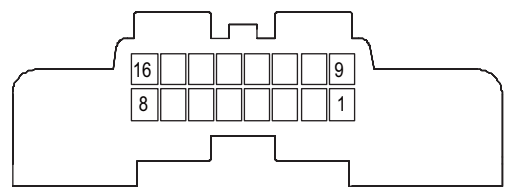

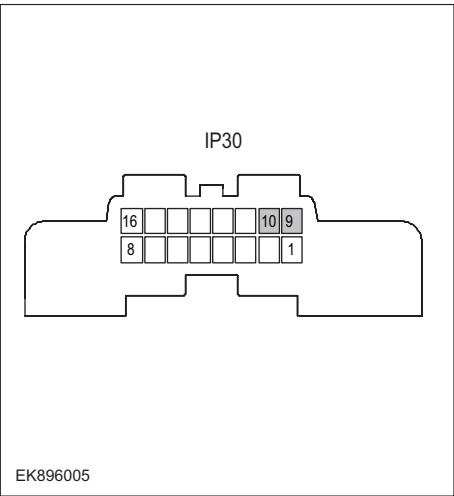
Troubleshooting steps	
Steps1	General inspection.
	<ol style="list-style-type: none"> 1 Check if the Insurance fuse is damaged. 2 Check battery capacity. 3 Check the GWM harness plug for damage, poor contact, aging, and looseness. 4 Check whether the result is normal or not?
NO → Repair or replace the faulted parts.	
YES ↓	
Steps2	Check fault codes.
	<ol style="list-style-type: none"> 1 Connect the fault diagnosis instrument to the diagnosis interface. 2 Turn the ignition switch to ON position. 3 Diagnose the GWM with diagnostic apparatus. 4 If there is any fault code except for U0127-87?
YES → Refer to: DTC Summary List (FICM) - left .	
NO ↓	
Steps3	Check the integrity of the CAN communication network.
 <p>The diagram shows a 16-pin IP30 connector. The terminals are arranged in two rows of eight. The top row terminals are numbered 16, 10, 9, and 1 from left to right. The bottom row terminals are numbered 8 and 1 from left to right. The connector is labeled 'IP30' and 'EK896005'.</p>	<ol style="list-style-type: none"> 1 Turn the ignition switch to OFF. 2 Measure the resistance between the diagnostic interface harness terminals. Measuring circuit: The resistance between terminal 9 and terminal 10 of IP30 plug. Standard value: $\approx 60 \Omega$ 3 Check whether the result is normal or not?
NO → Repair or replace the faulted parts.	
YES ↓	

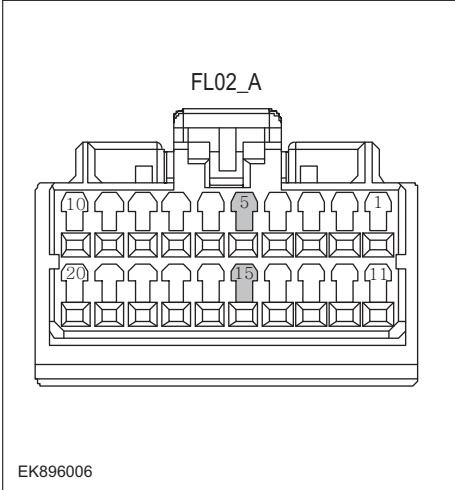
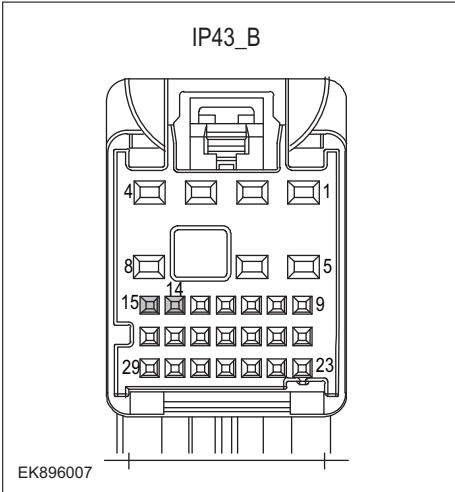
<p>Steps4</p>	<p>Check the terminal resistance of GWM and FICM.</p>
<div style="text-align: center;">  <p>FL02_A</p> <p>EK896006</p> </div> <div style="text-align: center; margin-top: 20px;">  <p>IP43_B</p> <p>EK896007</p> </div>	<ol style="list-style-type: none"> 1 Turn the ignition switch to OFF. 2 Disconnect the GWM harness plug FL02_ A. 3 Measure the resistance between the GWM harness terminals. Measuring circuit: FL02_ The resistance between terminal 5 and terminal 15 of plug A. Standard value: 110~130 Ω 4 Connect GWM harness plug FL02_ A. 5 Disconnect the harness plug IP43_ B of FICM module. 6 Measure the resistance between the FICM harness terminals. Measuring circuit: IP43_ The resistance between terminal 14 and terminal 15 of plug B. Standard value: 110~130 Ω 7 Check whether the result is normal or not?
<p>NO → Repair or replace the faulted parts.</p>	
<p>YES ↓</p>	

FICM

Steps5	Test whether FICM is norm.
	<ol style="list-style-type: none">1 Turn the ignition switch to OFF.2 Disconnect and check the FICM harness plug IP43_ A, IP43_ B.3 Check and repair.<ul style="list-style-type: none">• Corrosion(install new adapting piece or terminal-cleaning module and pin).• Pin damaged or bent-install new terminal/pin.• Fly out of pins-install new pins as needed.4 Reconnect the FICM plug and all other previously disconnected plug. Make sure the pin is properly positioned and fixed.5 Run the system and determine if the problem persists?
	YES → Change the FICM Module
NO ↓	
At this point the system is functioning normally. The problem may be caused by module connections. Address the root cause of any connector or pin problems.	
Next Step ↓	
Diagnosis end.	

U0073-88

Fault diagnosis code
U0073-88: Control Module Communication Bus Off
Detection tools
1 Multimeter and diagnostic apparatus
Possible causes
<ul style="list-style-type: none"> • Circuit, terminal and adapting piece • FICM • GWM
Conditions for fault code operation
Turn the ignition switch to the ON position
Conditions for fault code setting
U0073-88
To set the effect of a fault code condition
Description of circuit diagram
<p>The device is connected to the serial data circuit and monitors the serial data communication during normal vehicle operation. Devices exchange operational information and instructions with each other. The device has programming information that needs to be exchanged on the serial data circuit. The receiver device also monitors this information; In addition, some regular information is used to indicate the availability of the transmitter device.</p>

Circuit diagram

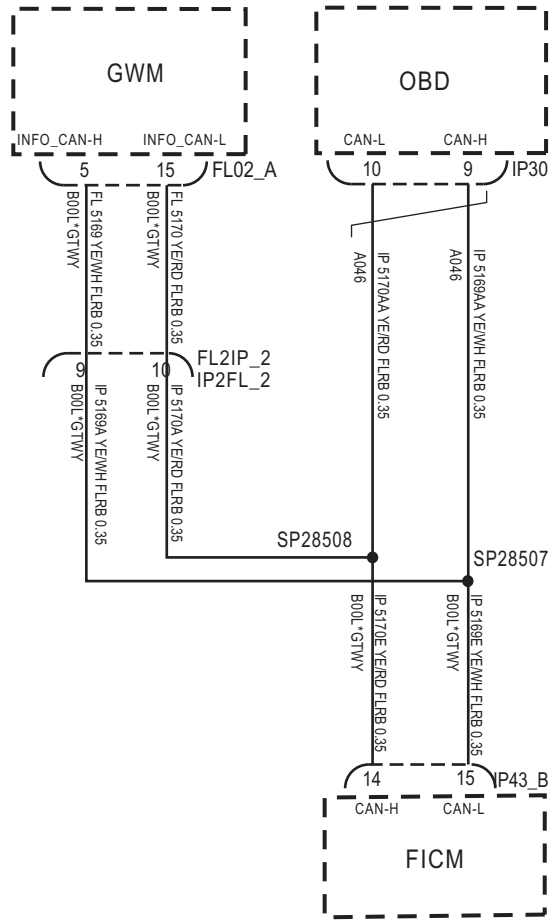

IP43_B

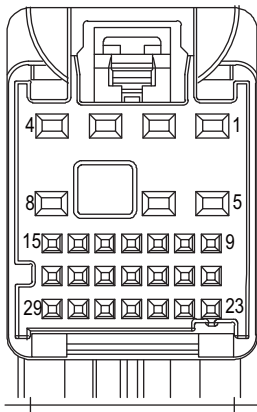

FL02_A

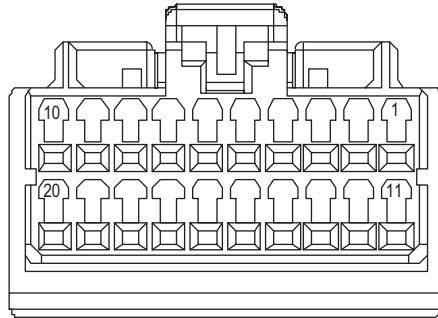

IP30

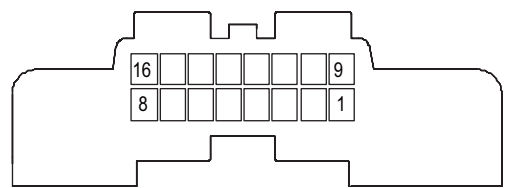

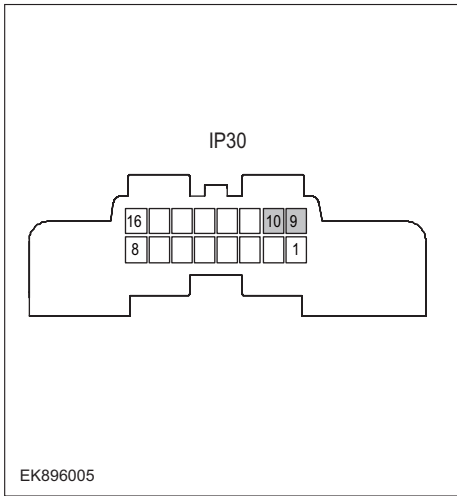
Troubleshooting steps	
Steps1	General inspection.
	<ol style="list-style-type: none"> 1 Check if the Insurance fuse is damaged. 2 Check battery capacity. 3 Check the GWM harness plug for damage, poor contact, aging, and looseness. 4 Check whether the result is normal or not?
	NO → Repair or replace the faulted parts.
YES ↓	
Steps2	Check fault codes.
	<ol style="list-style-type: none"> 1 Connect the fault diagnosis instrument to the diagnosis interface. 2 Turn the ignition switch to ON position. 3 Diagnose the GWM with diagnostic apparatus. 4 If there is any fault code except for U0073-88?
	YES → Refer to: DTC Summary List (FICM) - left .
NO ↓	
Steps3	Check the integrity of the CAN communication network.
	<ol style="list-style-type: none"> 1 Turn the ignition switch to OFF. 2 Measure the resistance between the diagnostic interface harness terminals. Measuring circuit: The resistance between terminal 9 and terminal 10 of IP30 plug. Standard value: ≈ 60 Ω 3 Check whether the result is normal or not?
	NO → Repair or replace the faulted parts.
YES ↓	

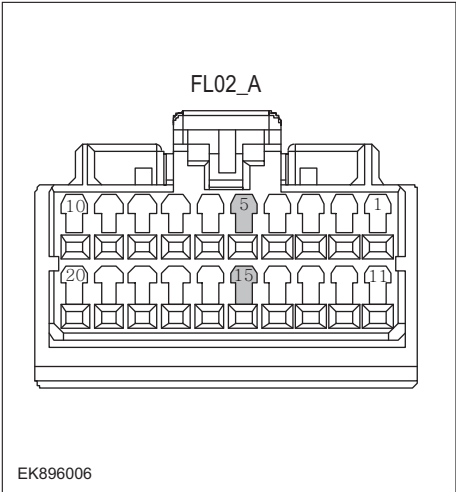
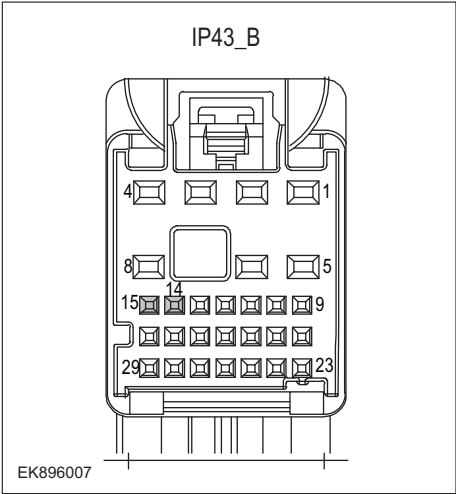
Steps4	Check the terminal resistance of GWM and FICM.
<div style="text-align: center;">  <p>FL02_A</p> <p>EK896006</p> </div> <div style="text-align: center; margin-top: 20px;">  <p>IP43_B</p> <p>EK896007</p> </div>	<ol style="list-style-type: none"> 1 Turn the ignition switch to OFF. 2 Disconnect the GWM harness plug FL02_ A. 3 Measure the resistance between the GWM harness terminals. Measuring circuit: FL02_ The resistance between terminal 5 and terminal 15 of plug A. Standard value: 110~130 Ω 4 Connect GWM harness plug FL02_ A. 5 Disconnect the harness plug IP43_ B of FICM module. 6 Measure the resistance between the FICM harness terminals. Measuring circuit: IP43_ The resistance between terminal 14 and terminal 15 of plug B. Standard value: 110~130 Ω 7 Check whether the result is normal or not?
	<p>NO → Repair or replace the faulted parts.</p>
<p>YES ↓</p>	

Steps5	Test whether FICM is norm.
	<ol style="list-style-type: none"> 1 Turn the ignition switch to OFF. 2 Disconnect and check the FICM harness plug IP43_ A, IP43_ B. 3 Check and repair. <ul style="list-style-type: none"> • Corrosion(install new adapting piece or terminal-cleaning module and pin). • Pin damaged or bent-install new terminal/pin. • Fly out of pins-install new pins as needed. 4 Reconnect the FICM plug and all other previously disconnected plug. Make sure the pin is properly positioned and fixed. 5 Run the system and determine if the problem persists?
	YES → Change the FICM Module
NO ↓	
At this point the system is functioning normally. The problem may be caused by module connections. Address the root cause of any connector or pin problems.	
Next Step ↓	
Diagnosis end.	

U010F-87

Fault diagnosis code
U010F-87: Lost Communication With Air Conditioning Control Module
Detection tools
1 Multimeter and diagnostic apparatus
Possible causes
<ul style="list-style-type: none"> • Circuit, terminal and adapting piece • FICM • GWM
Conditions for fault code operation
Turn the ignition switch to the ON position
Conditions for fault code setting
U010F-87
To set the effect of a fault code condition
Description of circuit diagram
<p>The device is connected to the serial data circuit and monitors the serial data communication during normal vehicle operation. Devices exchange operational information and instructions with each other. The device has programming information that needs to be exchanged on the serial data circuit. The receiver device also monitors this information; In addition, some regular information is used to indicate the availability of the transmitter device.</p>

Circuit diagram

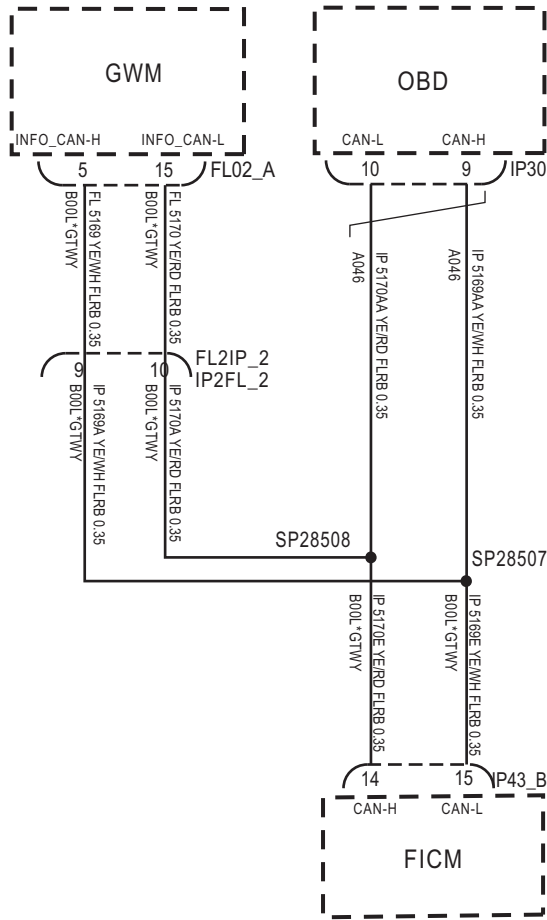

IP43_B

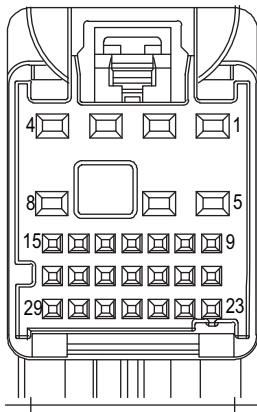

EK896004

FL02_A

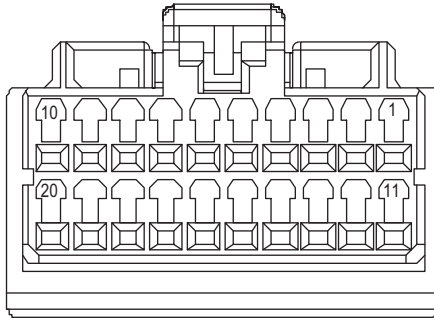

IP30

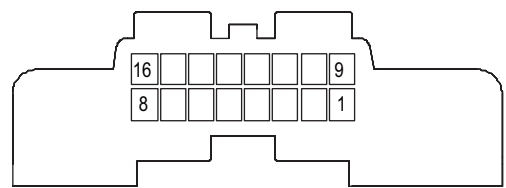

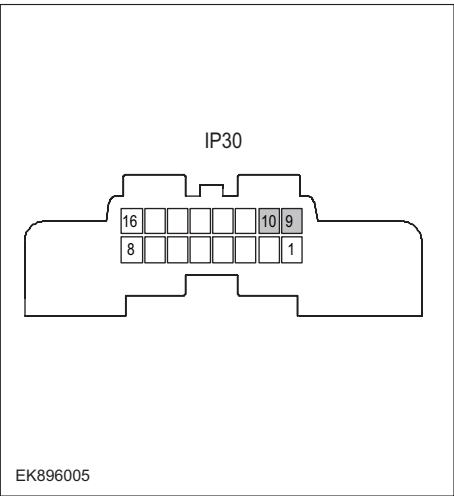
Troubleshooting steps	
Steps1	General inspection.
	<ol style="list-style-type: none"> 1 Check if the Insurance fuse is damaged. 2 Check battery capacity. 3 Check the GWM harness plug for damage, poor contact, aging, and looseness. 4 Check whether the result is normal or not?
NO → Repair or replace the faulted parts.	
YES ↓	
Steps2	Check fault codes.
	<ol style="list-style-type: none"> 1 Connect the fault diagnosis instrument to the diagnosis interface. 2 Turn the ignition switch to ON position. 3 Diagnose the GWM with diagnostic apparatus. 4 If there is any fault code except for U010F-87?
YES → Refer to: DTC Summary List (FICM) - left .	
NO ↓	
Steps3	Check the integrity of the CAN communication network.
 <p style="text-align: center;">IP30</p> <p style="text-align: center;">EK896005</p>	<ol style="list-style-type: none"> 1 Turn the ignition switch to OFF. 2 Measure the resistance between the diagnostic interface harness terminals. Measuring circuit: The resistance between terminal 9 and terminal 10 of IP30 plug. Standard value: $\approx 60 \Omega$ 3 Check whether the result is normal or not?
NO → Repair or replace the faulted parts.	
YES ↓	

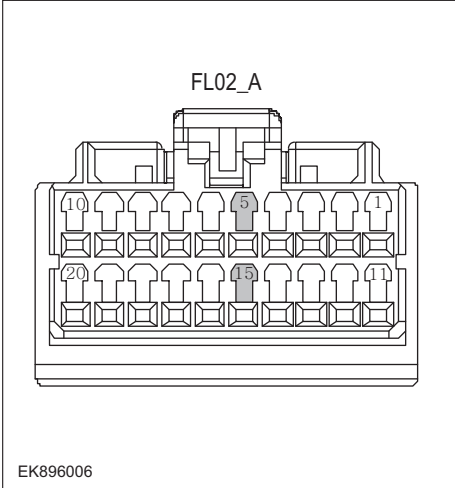
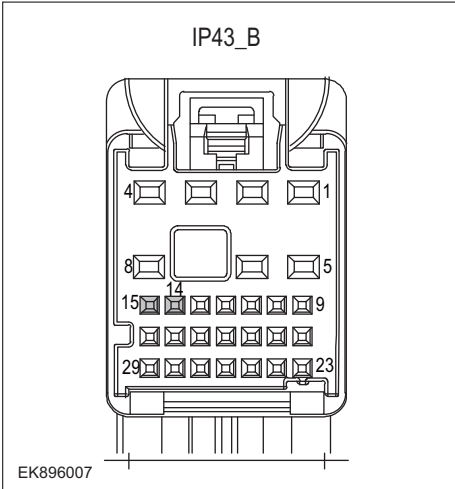
Steps4	Check the terminal resistance of GWM and FICM.
<div style="text-align: center;">  <p>FL02_A</p> <p>EK896006</p> </div> <div style="text-align: center; margin-top: 20px;">  <p>IP43_B</p> <p>EK896007</p> </div>	<ol style="list-style-type: none"> 1 Turn the ignition switch to OFF. 2 Disconnect the GWM harness plug FL02_ A. 3 Measure the resistance between the GWM harness terminals. Measuring circuit: FL02_ The resistance between terminal 5 and terminal 15 of plug A. Standard value: 110~130 Ω 4 Connect GWM harness plug FL02_ A. 5 Disconnect the harness plug IP43_ B of FICM module. 6 Measure the resistance between the FICM harness terminals. Measuring circuit: IP43_ The resistance between terminal 14 and terminal 15 of plug B. Standard value: 110~130 Ω 7 Check whether the result is normal or not?
<p>YES ↓</p>	<p>NO → Repair or replace the faulted parts.</p>

FICM

Steps5	Test whether FICM is norm.
	<ol style="list-style-type: none"> 1 Turn the ignition switch to OFF. 2 Disconnect and check the FICM harness plug IP43_ A, IP43_ B. 3 Check and repair. <ul style="list-style-type: none"> • Corrosion(install new adapting piece or terminal-cleaning module and pin). • Pin damaged or bent-install new terminal/pin. • Fly out of pins-install new pins as needed. 4 Reconnect the FICM plug and all other previously disconnected plug. Make sure the pin is properly positioned and fixed. 5 Run the system and determine if the problem persists?
	YES → Change the FICM Module
NO ↓	
At this point the system is functioning normally. The problem may be caused by module connections. Address the root cause of any connector or pin problems.	
Next Step ↓	
Diagnosis end.	

U0155-87

Fault diagnosis code
U0155-87: Lost Communication With IPK Module
Detection tools
1 Multimeter and diagnostic apparatus
Possible causes
<ul style="list-style-type: none"> • Circuit, terminal and adapting piece • FICM • GWM
Conditions for fault code operation
Turn the ignition switch to the ON position
Conditions for fault code setting
U0155-87
To set the effect of a fault code condition
Description of circuit diagram
<p>The device is connected to the serial data circuit and monitors the serial data communication during normal vehicle operation. Devices exchange operational information and instructions with each other. The device has programming information that needs to be exchanged on the serial data circuit. The receiver device also monitors this information; In addition, some regular information is used to indicate the availability of the transmitter device.</p>

Circuit diagram

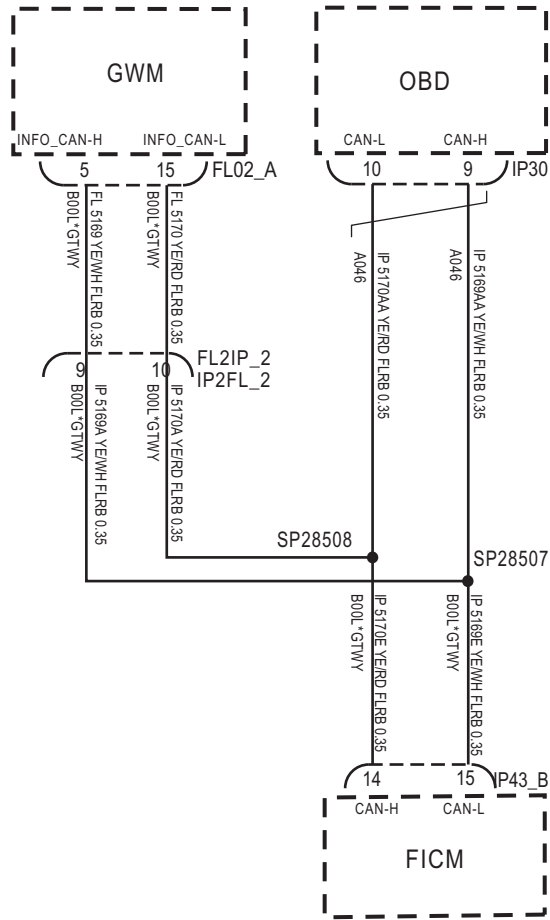

IP43_B

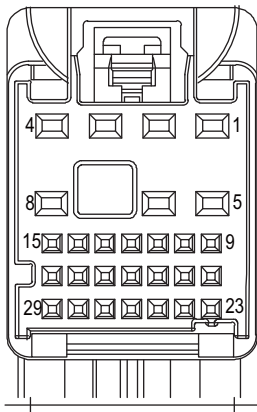

EK896004

FL02_A

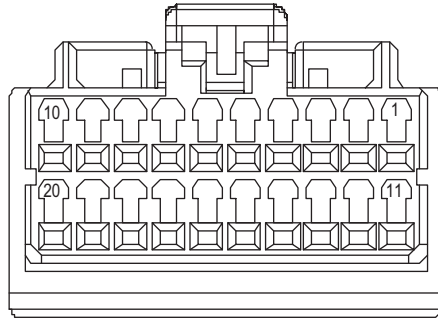

IP30

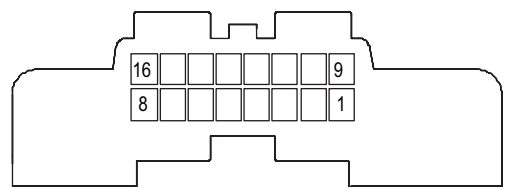

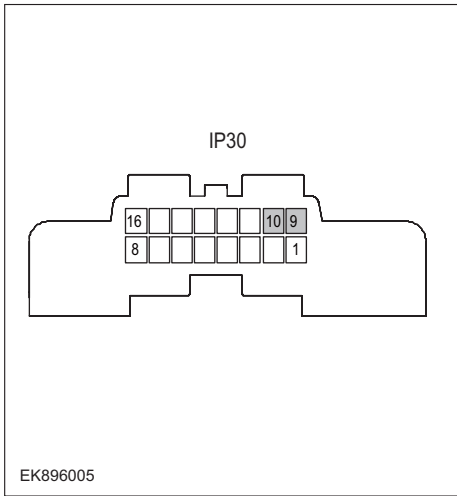
Troubleshooting steps	
Steps1	General inspection.
	<ol style="list-style-type: none"> 1 Check if the Insurance fuse is damaged. 2 Check battery capacity. 3 Check the GWM harness plug for damage, poor contact, aging, and looseness. 4 Check whether the result is normal or not?
	NO → Repair or replace the faulted parts.
YES ↓	
Steps2	Check fault codes.
	<ol style="list-style-type: none"> 1 Connect the fault diagnosis instrument to the diagnosis interface. 2 Turn the ignition switch to ON position. 3 Diagnose the GWM with diagnostic apparatus. 4 If there is any fault code except for U0155-87?
	YES → Refer to: DTC Summary List (FICM) - left .
NO ↓	
Steps3	Check the integrity of the CAN communication network.
 <p style="text-align: center;">IP30</p> <p style="text-align: center;">EK896005</p>	<ol style="list-style-type: none"> 1 Turn the ignition switch to OFF. 2 Measure the resistance between the diagnostic interface harness terminals. Measuring circuit: The resistance between terminal 9 and terminal 10 of IP30 plug. Standard value: ≈ 60 Ω 3 Check whether the result is normal or not?
	NO → Repair or replace the faulted parts.
YES ↓	

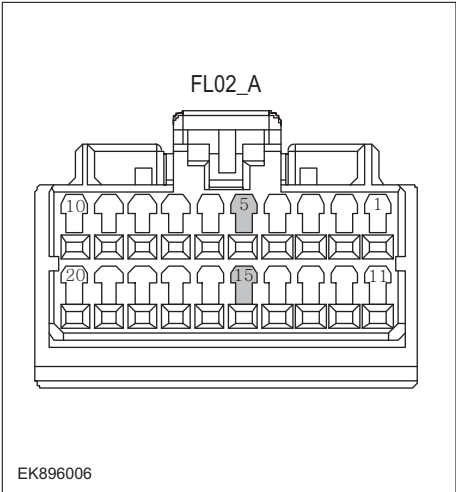
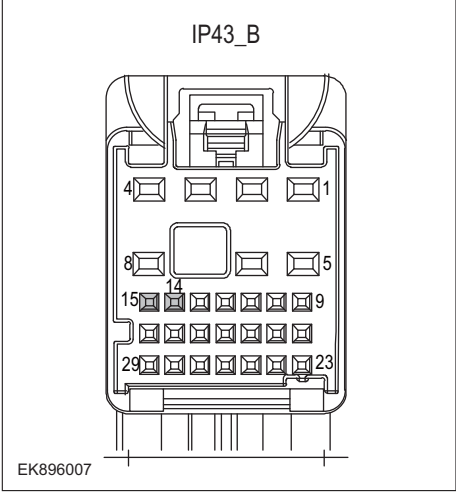
Steps4	Check the terminal resistance of GWM and FICM.
<div style="text-align: center;">  <p>FL02_A</p> <p>EK896006</p> </div> <div style="text-align: center; margin-top: 20px;">  <p>IP43_B</p> <p>EK896007</p> </div>	<ol style="list-style-type: none"> 1 Turn the ignition switch to OFF. 2 Disconnect the GWM harness plug FL02_ A. 3 Measure the resistance between the GWM harness terminals. Measuring circuit: FL02_ The resistance between terminal 5 and terminal 15 of plug A. Standard value: 110~130 Ω 4 Connect GWM harness plug FL02_ A. 5 Disconnect the harness plug IP43_ B of FICM module. 6 Measure the resistance between the FICM harness terminals. Measuring circuit: IP43_ The resistance between terminal 14 and terminal 15 of plug B. Standard value: 110~130 Ω 7 Check whether the result is normal or not?
	<p>NO → Repair or replace the faulted parts.</p>
<p>YES ↓</p>	

Steps5	Test whether FICM is norm.
	<ol style="list-style-type: none"> 1 Turn the ignition switch to OFF. 2 Disconnect and check the FICM harness plug IP43_ A、IP43_ B. 3 Check and repair. <ul style="list-style-type: none"> • Corrosion(install new adapting piece or terminal-cleaning module and pin). • Pin damaged or bent-install new terminal/pin. • Fly out of pins-install new pins as needed. 4 Reconnect the FICM plug and all other previously disconnected plug. Make sure the pin is properly positioned and fixed. 5 Run the system and determine if the problem persists?
	YES → Change the FICM Module
NO ↓	
At this point the system is functioning normally. The problem may be caused by module connections. Address the root cause of any connector or pin problems.	
Next Step ↓	
Diagnosis end.	

U0140-87

Fault diagnosis code
U0140-87: Lost Communication With BCM Module
Detection tools
1 Multimeter and diagnostic apparatus
Possible causes
<ul style="list-style-type: none"> • Circuit, terminal and adapting piece • FICM • GWM
Conditions for fault code operation
Turn the ignition switch to the ON position
Conditions for fault code setting
U0140-87
To set the effect of a fault code condition
Description of circuit diagram
<p>The device is connected to the serial data circuit and monitors the serial data communication during normal vehicle operation. Devices exchange operational information and instructions with each other. The device has programming information that needs to be exchanged on the serial data circuit. The receiver device also monitors this information; In addition, some regular information is used to indicate the availability of the transmitter device.</p>

Circuit diagram

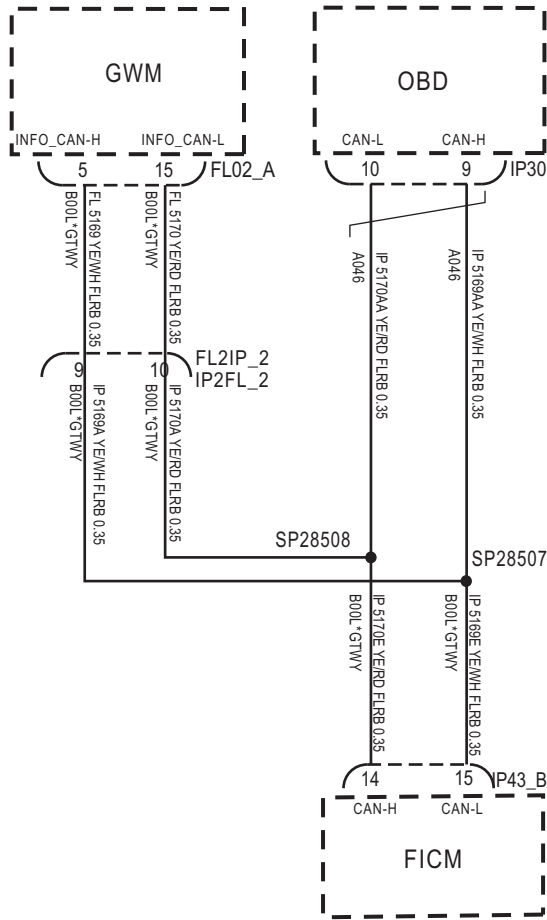

IP43_B

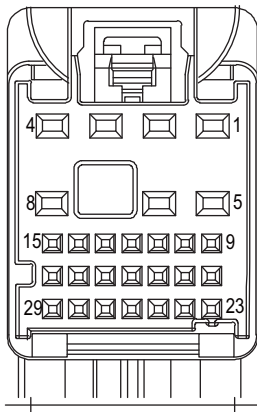

EK896004

FL02_A

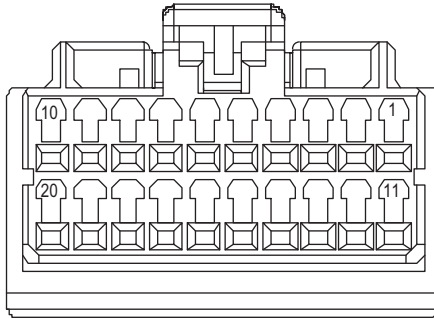

IP30

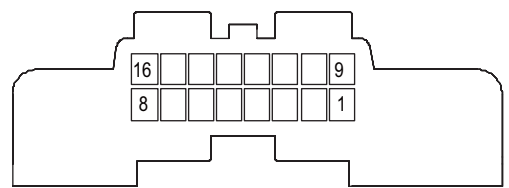

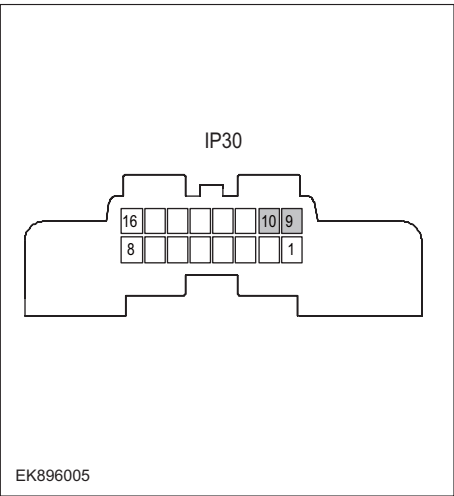
Troubleshooting steps	
Steps1	General inspection.
	<ol style="list-style-type: none"> 1 Check if the Insurance fuse is damaged. 2 Check battery capacity. 3 Check the GWM harness plug for damage, poor contact, aging, and looseness. 4 Check whether the result is normal or not?
NO → Repair or replace the faulted parts.	
YES ↓	
Steps2	Check fault codes.
	<ol style="list-style-type: none"> 1 Connect the fault diagnosis instrument to the diagnosis interface. 2 Turn the ignition switch to ON position. 3 Diagnose the GWM with diagnostic apparatus. 4 If there is any fault code except for U0140-87?
YES → Refer to: DTC Summary List (FICM) - left .	
NO ↓	
Steps3	Check the integrity of the CAN communication network.
 <p style="text-align: center;">IP30</p> <p style="text-align: center;">EK896005</p>	<ol style="list-style-type: none"> 1 Turn the ignition switch to OFF. 2 Measure the resistance between the diagnostic interface harness terminals. Measuring circuit: The resistance between terminal 9 and terminal 10 of IP30 plug. Standard value: ≈ 60 Ω 3 Check whether the result is normal or not?
NO → Repair or replace the faulted parts.	
YES ↓	

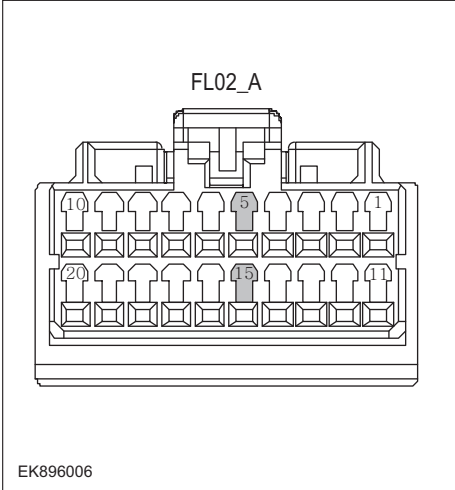
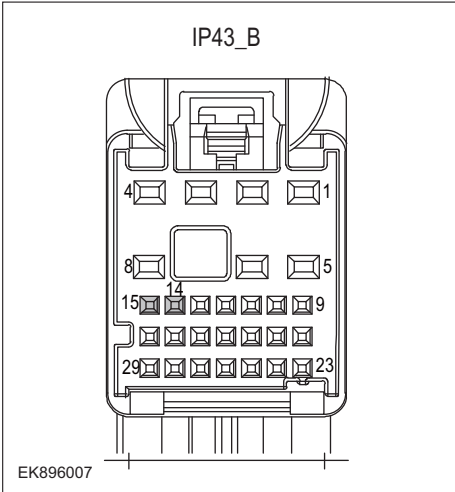
Steps4	Check the terminal resistance of GWM and FICM.
<div style="text-align: center;">  <p>FL02_A</p> <p>EK896006</p> </div> <div style="text-align: center; margin-top: 20px;">  <p>IP43_B</p> <p>EK896007</p> </div>	<ol style="list-style-type: none"> 1 Turn the ignition switch to OFF. 2 Disconnect the GWM harness plug FL02_ A. 3 Measure the resistance between the GWM harness terminals. Measuring circuit: FL02_ The resistance between terminal 5 and terminal 15 of plug A. Standard value: 110~130 Ω 4 Connect GWM harness plug FL02_ A. 5 Disconnect the harness plug IP43_ B of FICM module. 6 Measure the resistance between the FICM harness terminals. Measuring circuit: IP43_ The resistance between terminal 14 and terminal 15 of plug B. Standard value: 110~130 Ω 7 Check whether the result is normal or not?
<p>YES ↓</p>	<p>NO → Repair or replace the faulted parts.</p>

FICM

Steps5	Test whether FICM is norm.
	<ol style="list-style-type: none">1 Turn the ignition switch to OFF.2 Disconnect and check the FICM harness plug IP43_ A, IP43_ B.3 Check and repair.<ul style="list-style-type: none">• Corrosion(install new adapting piece or terminal-cleaning module and pin).• Pin damaged or bent-install new terminal/pin.• Fly out of pins-install new pins as needed.4 Reconnect the FICM plug and all other previously disconnected plug. Make sure the pin is properly positioned and fixed.5 Run the system and determine if the problem persists?
	YES → Change the FICM Module
NO ↓	
At this point the system is functioning normally. The problem may be caused by module connections. Address the root cause of any connector or pin problems.	
Next Step ↓	
Diagnosis end.	

U0126-87

Fault diagnosis code
U0126-87: Lost Communication With SAS Module
Detection tools
1 Multimeter and diagnostic apparatus
Possible causes
<ul style="list-style-type: none"> • Circuit, terminal and adapting piece • FICM • GWM
Conditions for fault code operation
Turn the ignition switch to the ON position
Conditions for fault code setting
U0126-87
To set the effect of a fault code condition
Description of circuit diagram
<p>The device is connected to the serial data circuit and monitors the serial data communication during normal vehicle operation. Devices exchange operational information and instructions with each other. The device has programming information that needs to be exchanged on the serial data circuit. The receiver device also monitors this information; In addition, some regular information is used to indicate the availability of the transmitter device.</p>

Circuit diagram

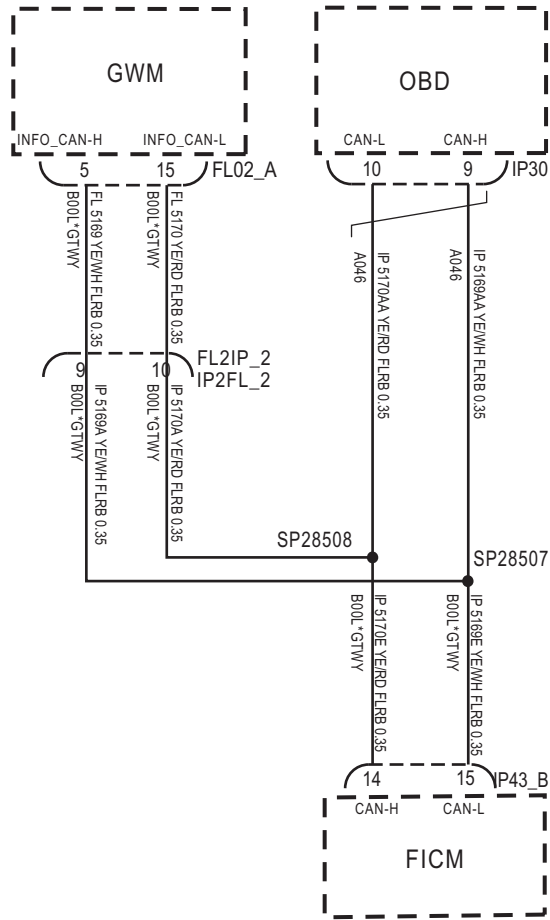

IP43_B

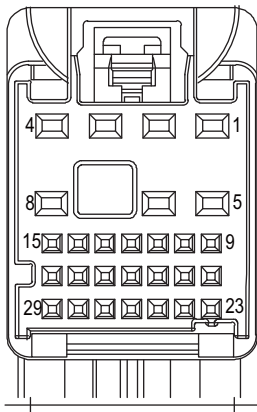

EK896004

FL02_A

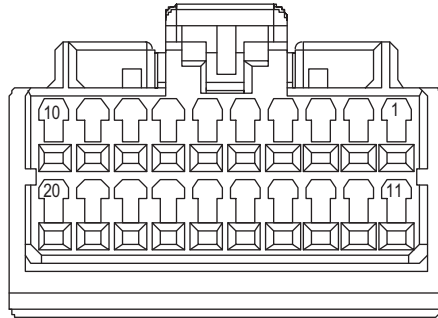

IP30

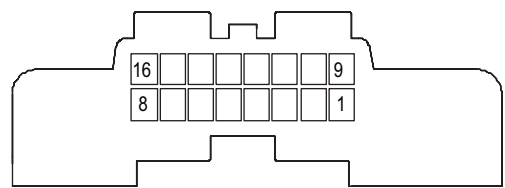

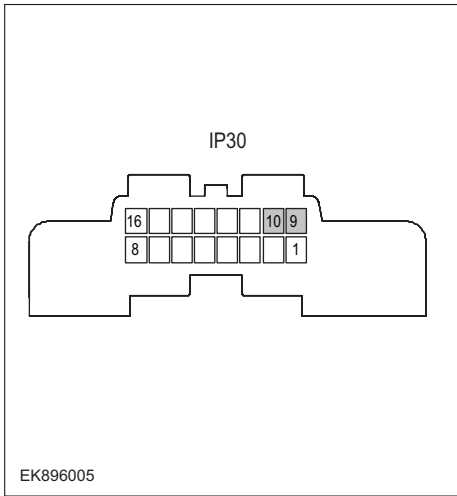
Troubleshooting steps	
Steps1	General inspection.
	<ol style="list-style-type: none"> 1 Check if the Insurance fuse is damaged. 2 Check battery capacity. 3 Check the GWM harness plug for damage, poor contact, aging, and looseness. 4 Check whether the result is normal or not?
	NO → Repair or replace the faulted parts.
YES ↓	
Steps2	Check fault codes.
	<ol style="list-style-type: none"> 1 Connect the fault diagnosis instrument to the diagnosis interface. 2 Turn the ignition switch to ON position. 3 Diagnose the GWM with diagnostic apparatus. 4 If there is any fault code except for U0126-87?
	YES → Refer to: DTC Summary List (FICM) - left .
NO ↓	
Steps3	Check the integrity of the CAN communication network.
	<ol style="list-style-type: none"> 1 Turn the ignition switch to OFF. 2 Measure the resistance between the diagnostic interface harness terminals. Measuring circuit: The resistance between terminal 9 and terminal 10 of IP30 plug. Standard value: $\approx 60 \Omega$ 3 Check whether the result is normal or not?
	NO → Repair or replace the faulted parts.
YES ↓	

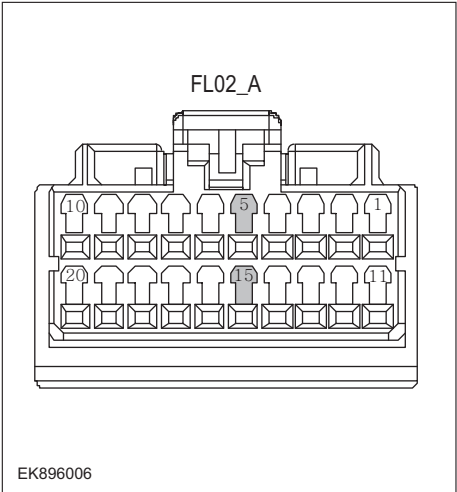
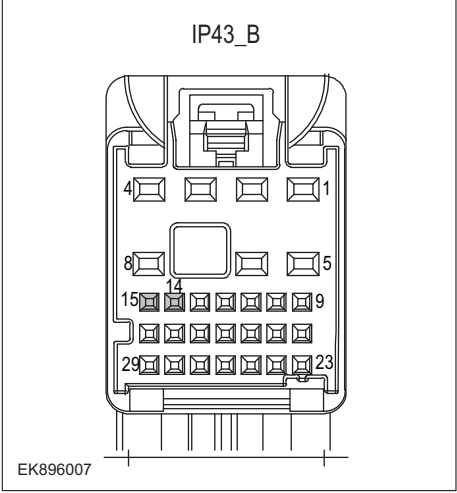
Steps4	Check the terminal resistance of GWM and FICM.
<div style="text-align: center;">  <p>FL02_A</p> <p>EK896006</p> </div> <div style="text-align: center; margin-top: 20px;">  <p>IP43_B</p> <p>EK896007</p> </div>	<ol style="list-style-type: none"> 1 Turn the ignition switch to OFF. 2 Disconnect the GWM harness plug FL02_ A. 3 Measure the resistance between the GWM harness terminals. Measuring circuit: FL02_ The resistance between terminal 5 and terminal 15 of plug A. Standard value: 110~130 Ω 4 Connect GWM harness plug FL02_ A. 5 Disconnect the harness plug IP43_ B of FICM module. 6 Measure the resistance between the FICM harness terminals. Measuring circuit: IP43_ The resistance between terminal 14 and terminal 15 of plug B. Standard value: 110~130 Ω 7 Check whether the result is normal or not?
<p>YES ↓</p>	<p>NO → Repair or replace the faulted parts.</p>

Steps5	Test whether FICM is norm.
	<ol style="list-style-type: none"> 1 Turn the ignition switch to OFF. 2 Disconnect and check the FICM harness plug IP43_ A、IP43_ B. 3 Check and repair. <ul style="list-style-type: none"> • Corrosion(install new adapting piece or terminal-cleaning module and pin). • Pin damaged or bent-install new terminal/pin. • Fly out of pins-install new pins as needed. 4 Reconnect the FICM plug and all other previously disconnected plug. Make sure the pin is properly positioned and fixed. 5 Run the system and determine if the problem persists?
	YES → Change the FICM Module
NO ↓	
At this point the system is functioning normally. The problem may be caused by module connections. Address the root cause of any connector or pin problems.	
Next Step ↓	
Diagnosis end.	

U1031-87

Fault diagnosis code
U1031-87: Lost Communication With Infotainment Faceplate Module
Detection tools
1 Multimeter and diagnostic apparatus
Possible causes
<ul style="list-style-type: none"> • Circuit, terminal and adapting piece • FICM • GWM
Conditions for fault code operation
Turn the ignition switch to the ON position
Conditions for fault code setting
U1031-87
To set the effect of a fault code condition
Description of circuit diagram
<p>The device is connected to the serial data circuit and monitors the serial data communication during normal vehicle operation. Devices exchange operational information and instructions with each other. The device has programming information that needs to be exchanged on the serial data circuit. The receiver device also monitors this information; In addition, some regular information is used to indicate the availability of the transmitter device.</p>

Circuit diagram

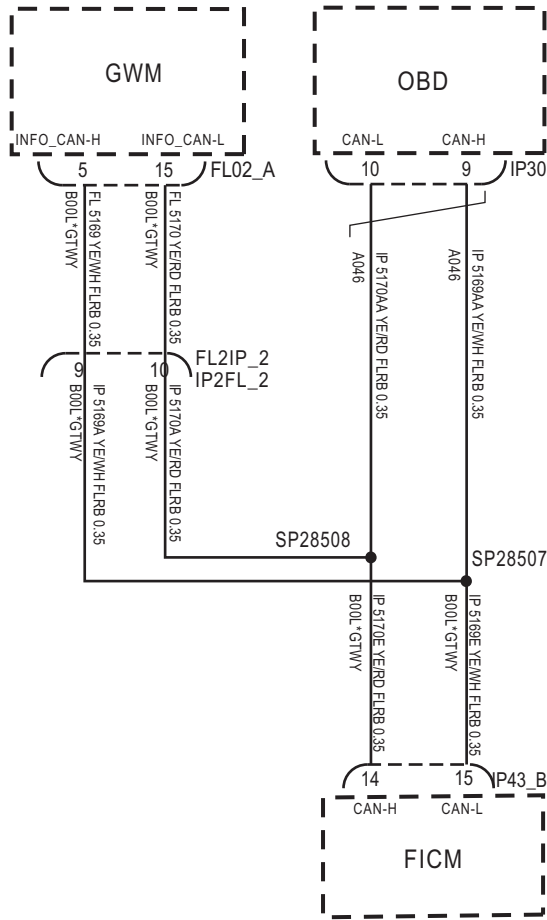

IP43_B

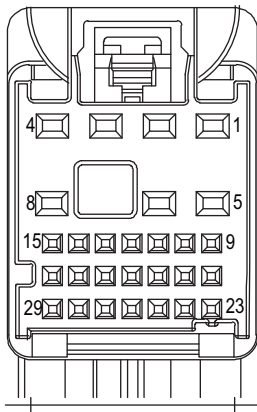

EK896004

FL02_A

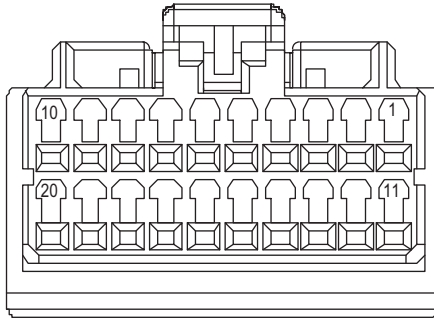

IP30

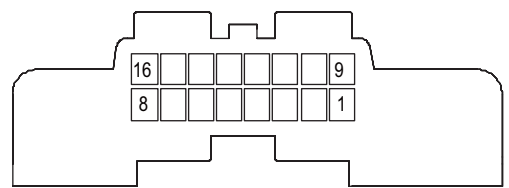

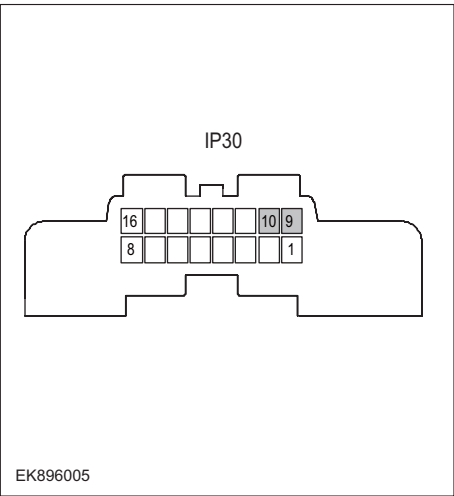
Troubleshooting steps	
Steps1	General inspection.
	<ol style="list-style-type: none"> 1 Check if the Insurance fuse is damaged. 2 Check battery capacity. 3 Check the GWM harness plug for damage, poor contact, aging, and looseness. 4 Check whether the result is normal or not?
NO → Repair or replace the faulted parts.	
YES ↓	
Steps2	Check fault codes.
	<ol style="list-style-type: none"> 1 Connect the fault diagnosis instrument to the diagnosis interface. 2 Turn the ignition switch to ON position. 3 Diagnose the GWM with diagnostic apparatus. 4 If there is any fault code except for U1031-87?
YES → Refer to: DTC Summary List (FICM) - left .	
NO ↓	
Steps3	Check the integrity of the CAN communication network.
 <p style="text-align: center;">IP30</p> <p style="text-align: center;">EK896005</p>	<ol style="list-style-type: none"> 1 Turn the ignition switch to OFF. 2 Measure the resistance between the diagnostic interface harness terminals. Measuring circuit: The resistance between terminal 9 and terminal 10 of IP30 plug. Standard value: ≈ 60 Ω 3 Check whether the result is normal or not?
NO → Repair or replace the faulted parts.	
YES ↓	

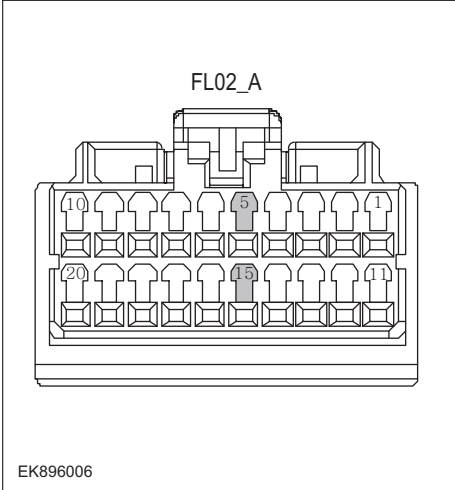
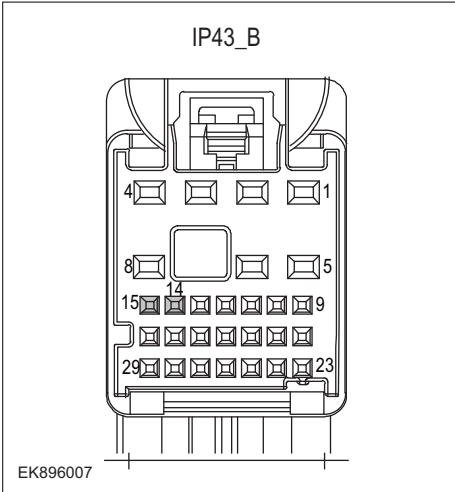
Steps4	Check the terminal resistance of GWM and FICM.
<div style="text-align: center;">  <p>FL02_A</p> <p>EK896006</p> </div> <div style="text-align: center; margin-top: 20px;">  <p>IP43_B</p> <p>EK896007</p> </div>	<ol style="list-style-type: none"> 1 Turn the ignition switch to OFF. 2 Disconnect the GWM harness plug FL02_ A. 3 Measure the resistance between the GWM harness terminals. Measuring circuit: FL02_ The resistance between terminal 5 and terminal 15 of plug A. Standard value: 110~130 Ω 4 Connect GWM harness plug FL02_ A. 5 Disconnect the harness plug IP43_ B of FICM module. 6 Measure the resistance between the FICM harness terminals. Measuring circuit: IP43_ The resistance between terminal 14 and terminal 15 of plug B. Standard value: 110~130 Ω 7 Check whether the result is normal or not?
<p>YES ↓</p>	<p>NO → Repair or replace the faulted parts.</p>

FICM

Steps5	Test whether FICM is norm.
	<ol style="list-style-type: none">1 Turn the ignition switch to OFF.2 Disconnect and check the FICM harness plug IP43_ A, IP43_ B.3 Check and repair.<ul style="list-style-type: none">• Corrosion(install new adapting piece or terminal-cleaning module and pin).• Pin damaged or bent-install new terminal/pin.• Fly out of pins-install new pins as needed.4 Reconnect the FICM plug and all other previously disconnected plug. Make sure the pin is properly positioned and fixed.5 Run the system and determine if the problem persists?
	YES → Change the FICM Module
NO ↓	
At this point the system is functioning normally. The problem may be caused by module connections. Address the root cause of any connector or pin problems.	
Next Step ↓	
Diagnosis end.	

U0121-87

Fault diagnosis code
U0121-87: Lost Communication With ESP or ABS Module
Detection tools
1 Multimeter and diagnostic apparatus
Possible causes
<ul style="list-style-type: none"> • Circuit, terminal and adapting piece • FICM • GWM
Conditions for fault code operation
Turn the ignition switch to the ON position
Conditions for fault code setting
U0121-87
To set the effect of a fault code condition
Description of circuit diagram
<p>The device is connected to the serial data circuit and monitors the serial data communication during normal vehicle operation. Devices exchange operational information and instructions with each other. The device has programming information that needs to be exchanged on the serial data circuit. The receiver device also monitors this information; In addition, some regular information is used to indicate the availability of the transmitter device.</p>

Circuit diagram

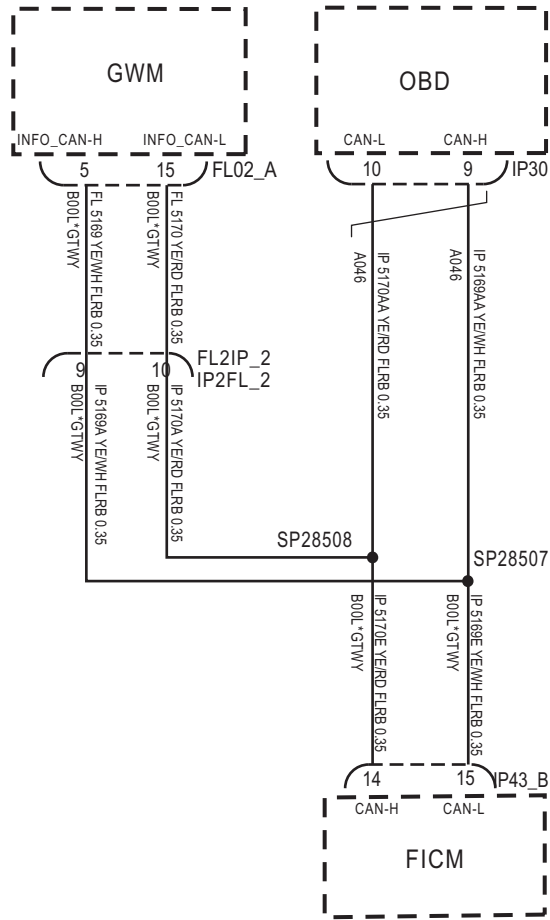

IP43_B

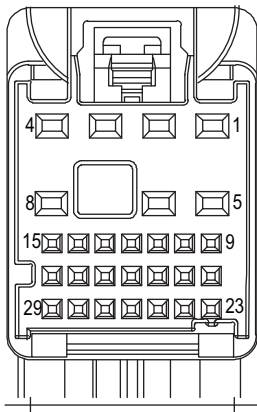

EK896004

FL02_A

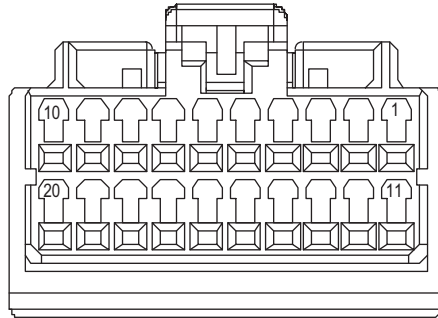

IP30

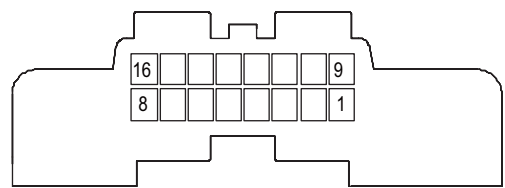

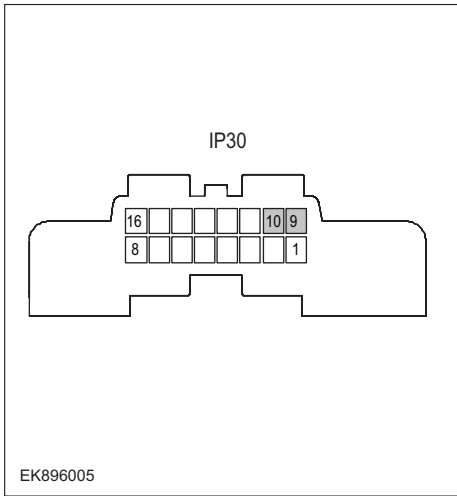
Troubleshooting steps	
Steps1	General inspection.
	<ol style="list-style-type: none"> 1 Check if the Insurance fuse is damaged. 2 Check battery capacity. 3 Check the GWM harness plug for damage, poor contact, aging, and looseness. 4 Check whether the result is normal or not?
	NO → Repair or replace the faulted parts.
YES ↓	
Steps2	Check fault codes.
	<ol style="list-style-type: none"> 1 Connect the fault diagnosis instrument to the diagnosis interface. 2 Turn the ignition switch to ON position. 3 Diagnose the GWM with diagnostic apparatus. 4 If there is any fault code except for U0121-87?
	YES → Refer to: DTC Summary List (FICM) - left .
NO ↓	
Steps3	Check the integrity of the CAN communication network.
 <p>The diagram shows a 16-pin IP30 plug. The top row of terminals is numbered 16, 15, 14, 13, 12, 11, 10, 9 from left to right. The bottom row is numbered 8, 7, 6, 5, 4, 3, 2, 1 from left to right. Terminals 9 and 10 are shaded. The reference code EK896005 is located at the bottom left of the diagram.</p>	<ol style="list-style-type: none"> 1 Turn the ignition switch to OFF. 2 Measure the resistance between the diagnostic interface harness terminals. Measuring circuit: The resistance between terminal 9 and terminal 10 of IP30 plug. Standard value: ≈ 60 Ω 3 Check whether the result is normal or not?
	NO → Repair or replace the faulted parts.
YES ↓	

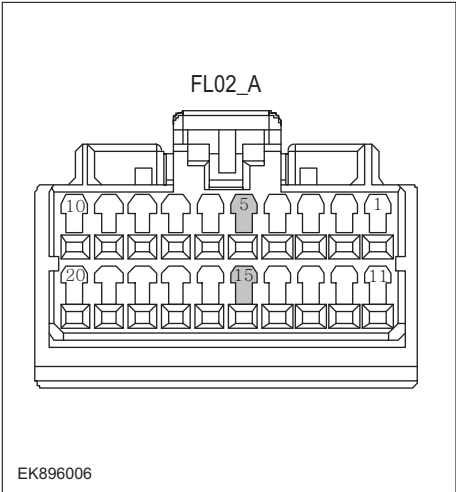
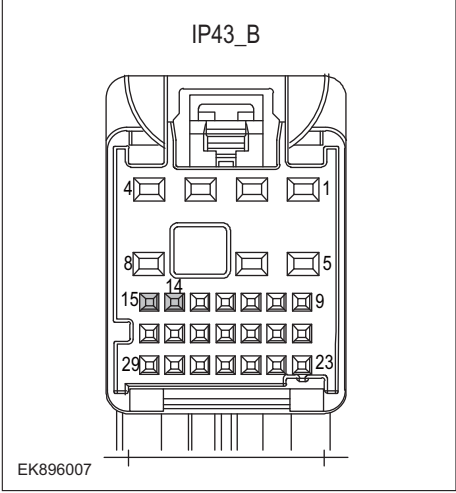
Steps4	Check the terminal resistance of GWM and FICM.
<div style="text-align: center;">  <p>FL02_A</p> <p>EK896006</p> </div> <div style="text-align: center; margin-top: 20px;">  <p>IP43_B</p> <p>EK896007</p> </div>	<ol style="list-style-type: none"> 1 Turn the ignition switch to OFF. 2 Disconnect the GWM harness plug FL02_ A. 3 Measure the resistance between the GWM harness terminals. Measuring circuit: FL02_ The resistance between terminal 5 and terminal 15 of plug A. Standard value: 110~130 Ω 4 Connect GWM harness plug FL02_ A. 5 Disconnect the harness plug IP43_ B of FICM module. 6 Measure the resistance between the FICM harness terminals. Measuring circuit: IP43_ The resistance between terminal 14 and terminal 15 of plug B. Standard value: 110~130 Ω 7 Check whether the result is normal or not?
	<p>NO → Repair or replace the faulted parts.</p>
<p>YES ↓</p>	

Steps5	Test whether FICM is norm.
	<ol style="list-style-type: none"> 1 Turn the ignition switch to OFF. 2 Disconnect and check the FICM harness plug IP43_ A、IP43_ B. 3 Check and repair. <ul style="list-style-type: none"> • Corrosion(install new adapting piece or terminal-cleaning module and pin). • Pin damaged or bent-install new terminal/pin. • Fly out of pins-install new pins as needed. 4 Reconnect the FICM plug and all other previously disconnected plug. Make sure the pin is properly positioned and fixed. 5 Run the system and determine if the problem persists?
	YES → Change the FICM Module
NO ↓	
At this point the system is functioning normally. The problem may be caused by module connections. Address the root cause of any connector or pin problems.	
Next Step ↓	
Diagnosis end.	

U0101-87

Fault diagnosis code
U0101-87: Lost Communication With TCU Module
Detection tools
1 Multimeter and diagnostic apparatus
Possible causes
<ul style="list-style-type: none"> • Circuit, terminal and adapting piece • FICM • GWM
Conditions for fault code operation
Turn the ignition switch to the ON position
Conditions for fault code setting
U0101-87
To set the effect of a fault code condition
Description of circuit diagram
<p>The device is connected to the serial data circuit and monitors the serial data communication during normal vehicle operation. Devices exchange operational information and instructions with each other. The device has programming information that needs to be exchanged on the serial data circuit. The receiver device also monitors this information; In addition, some regular information is used to indicate the availability of the transmitter device.</p>

Circuit diagram

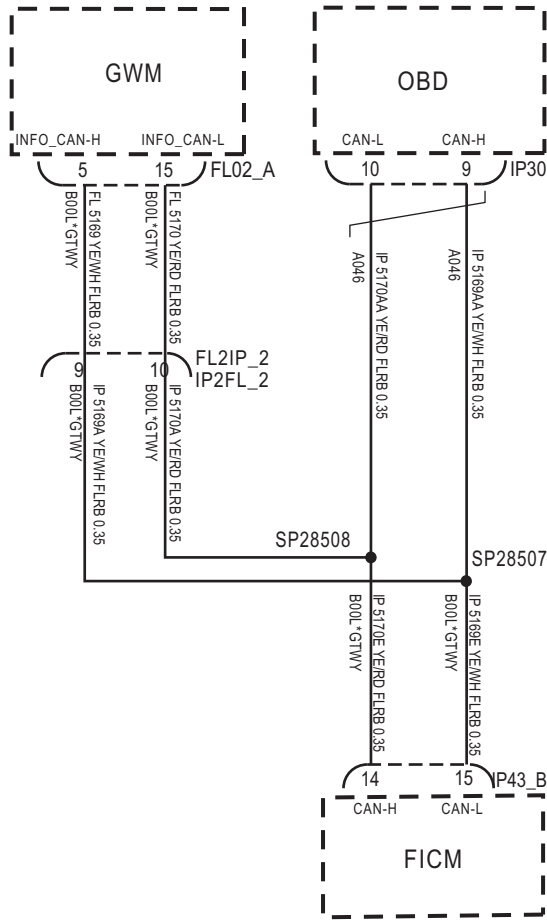

IP43_B

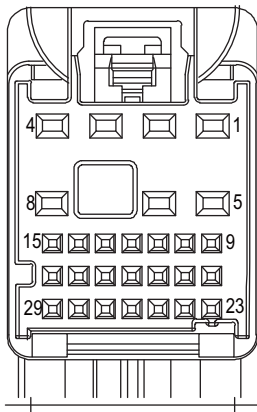

EK896004

FL02_A

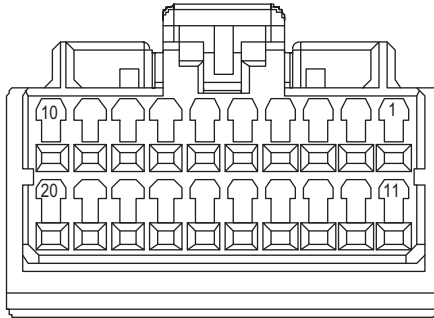

IP30

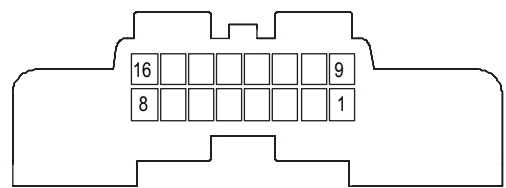

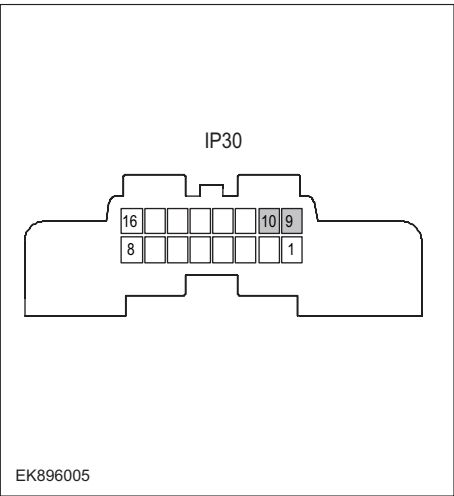
Troubleshooting steps	
Steps1	General inspection.
	<ol style="list-style-type: none"> 1 Check if the Insurance fuse is damaged. 2 Check battery capacity. 3 Check the GWM harness plug for damage, poor contact, aging, and looseness. 4 Check whether the result is normal or not?
NO → Repair or replace the faulted parts.	
YES ↓	
Steps2	Check fault codes.
	<ol style="list-style-type: none"> 1 Connect the fault diagnosis instrument to the diagnosis interface. 2 Turn the ignition switch to ON position. 3 Diagnose the GWM with diagnostic apparatus. 4 If there is any fault code except for U0101-87?
YES → Refer to: DTC Summary List (FICM) - left .	
NO ↓	
Steps3	Check the integrity of the CAN communication network.
 <p style="text-align: center;">IP30</p> <p style="text-align: center;">EK896005</p>	<ol style="list-style-type: none"> 1 Turn the ignition switch to OFF. 2 Measure the resistance between the diagnostic interface harness terminals. Measuring circuit: The resistance between terminal 9 and terminal 10 of IP30 plug. Standard value: $\approx 60 \Omega$ 3 Check whether the result is normal or not?
NO → Repair or replace the faulted parts.	
YES ↓	

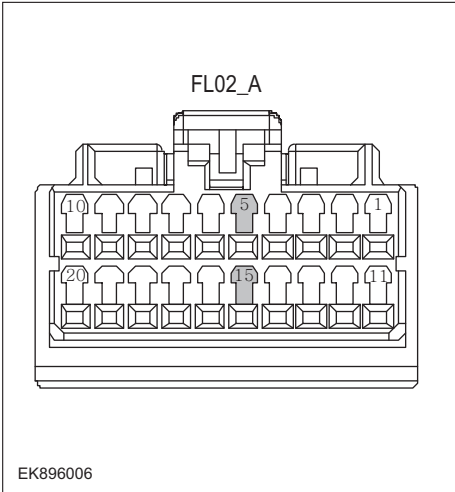
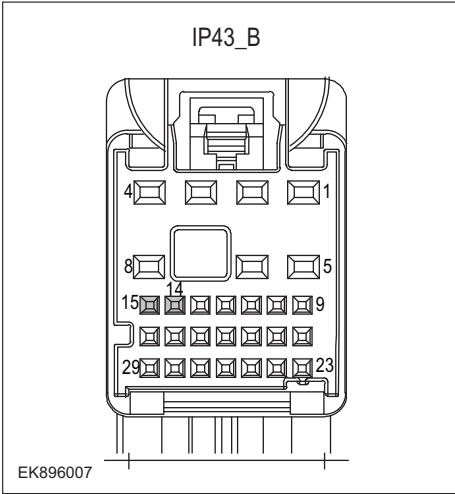
<p>Steps4</p>	<p>Check the terminal resistance of GWM and FICM.</p>
<div style="text-align: center;">  <p>FL02_A</p> <p>EK896006</p> </div> <div style="text-align: center; margin-top: 20px;">  <p>IP43_B</p> <p>EK896007</p> </div>	<ol style="list-style-type: none"> 1 Turn the ignition switch to OFF. 2 Disconnect the GWM harness plug FL02_ A. 3 Measure the resistance between the GWM harness terminals. Measuring circuit: FL02_ The resistance between terminal 5 and terminal 15 of plug A. Standard value: 110~130 Ω 4 Connect GWM harness plug FL02_ A. 5 Disconnect the harness plug IP43_B of FICM module. 6 Measure the resistance between the FICM harness terminals. Measuring circuit: IP43_ The resistance between terminal 14 and terminal 15 of plug B. Standard value: 110~130 Ω 7 Check whether the result is normal or not?
<p>NO → Repair or replace the faulted parts.</p>	
<p>YES ↓</p>	

FICM

Steps5	Test whether FICM is norm.
	<ol style="list-style-type: none"> 1 Turn the ignition switch to OFF. 2 Disconnect and check the FICM harness plug IP43_ A, IP43_ B. 3 Check and repair. <ul style="list-style-type: none"> • Corrosion(install new adapting piece or terminal-cleaning module and pin). • Pin damaged or bent-install new terminal/pin. • Fly out of pins-install new pins as needed. 4 Reconnect the FICM plug and all other previously disconnected plug. Make sure the pin is properly positioned and fixed. 5 Run the system and determine if the problem persists?
	YES → Change the FICM Module
NO ↓	
At this point the system is functioning normally. The problem may be caused by module connections. Address the root cause of any connector or pin problems.	
Next Step ↓	
Diagnosis end.	

B1A10-12、 B1A10-11、 B1A10-13、 B1A10-19

Fault diagnosis code
B1A10-12: TUNER's antenna short to Battery
B1A10-11: TUNER's antenna short to GND
B1A10-13: The open circuit detection of TUNER's antenna
B1A10-19: The Over-Current detection of TUNER's antenna
Detection tools
1 Multimeter and diagnostic apparatus
Possible causes
<ul style="list-style-type: none"> • Circuit,terminal and adapting piece • Battery • FICM • Charging system • Insurance fuse
Conditions for fault code operation
Turn the ignition switch to the ON position
Conditions for fault code setting
B1A10-12
B1A10-11
B1A10-13
B1A10-19
To set the effect of a fault code condition
Description of circuit diagram
The FICM will monitor whether all sensors and actuators are within normal range all the time. Meanwhile,it will check the connector for virtual connection, short circuit, open circuit and the connection rationality with other signals. When fault occurs, the FICM module will save the fault code corresponding to that fault and enable safety mode.

Circuit diagram

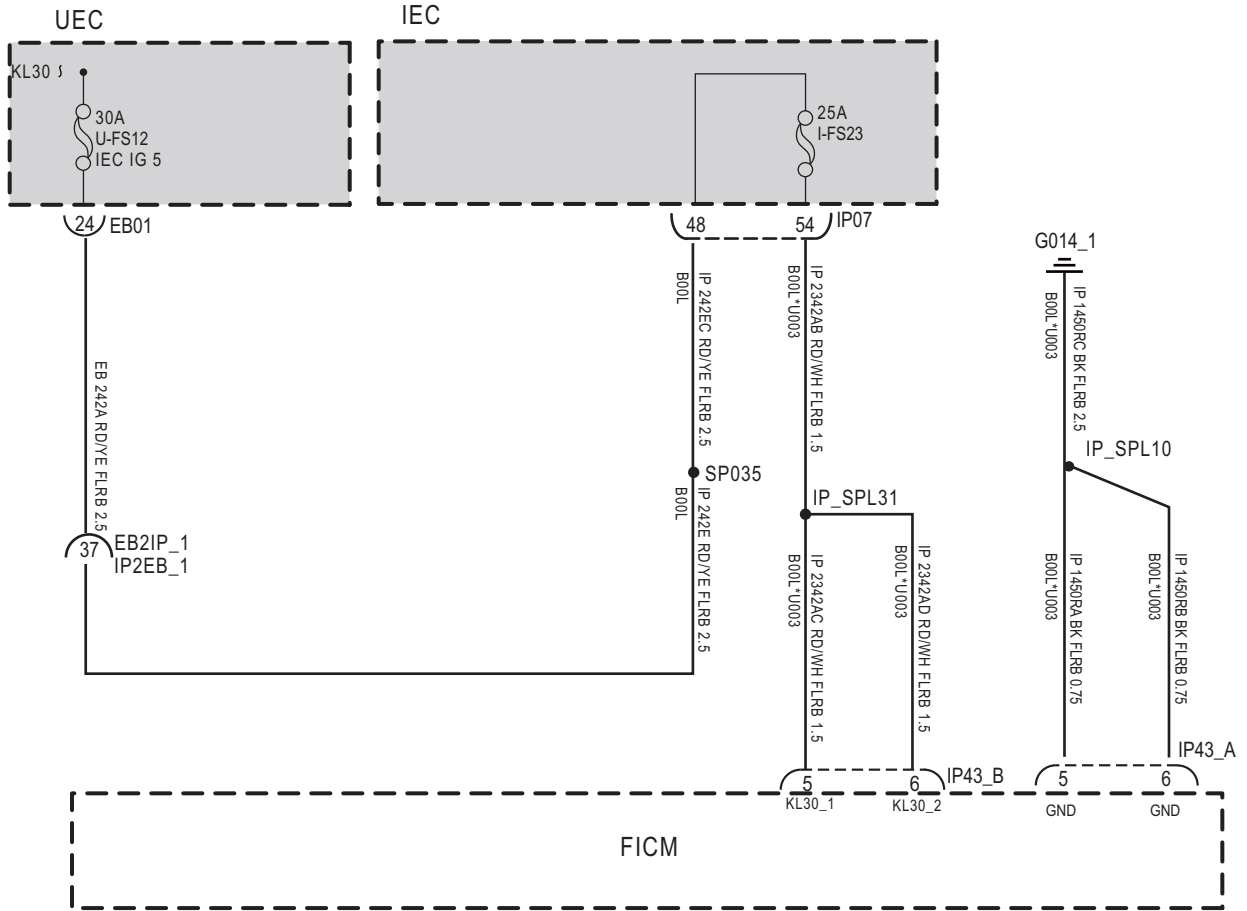

IP43_A

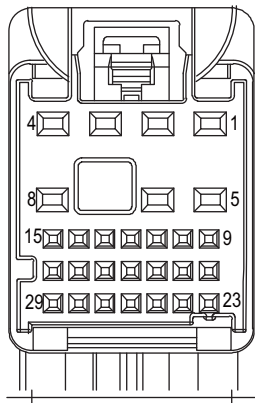

IP43_B

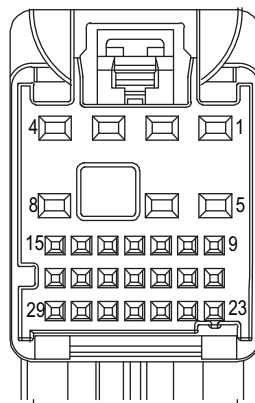

EK896001

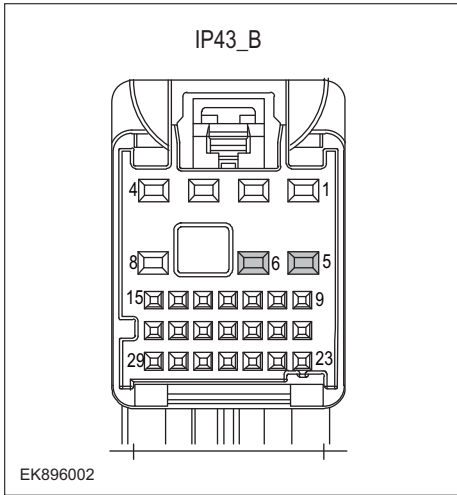
Troubleshooting steps	
Steps1	General inspection.
	<ol style="list-style-type: none"> 1 Check fuses U-FS12、 I-FS23 for damage. 2 Check battery capacity. 3 Check the harness plug of FICM for damage, poor contact, aging and looseness. 4 Check whether the result is normal or not?
	NO → Repair or replace the faulted parts.
YES ↓	
Steps2	Check fault codes.
	<ol style="list-style-type: none"> 1 Connect the fault diagnosis instrument to the diagnosis interface. 2 Turn the ignition switch to ON position. 3 Diagnose the FICM with diagnostic apparatus. 4 If there is any fault code except for B1A10-12、 B1A10-11、 B1A10-13、 B1A10-19?
	YES → Refer to: DTC Summary List (FICM) - left.
NO ↓	
Steps3	Check the FICMBattery power supply voltage.
	<ol style="list-style-type: none"> 1 Turn the ignition switch to OFF. 2 Disconnect the harness plug IP43_B of FICM module. 3 Measure the voltage between the FICM harness terminal and ground. Measuring circuit: IP43_ The voltage between terminal 5 of plug B and the grounding. Measuring circuit: IP43_ The voltage between terminal 6 of plug B and the grounding. Standard value:10~14V 4 Check whether the result is normal or not?
	NO → Repair or replace the faulted parts.
YES ↓	

FICM

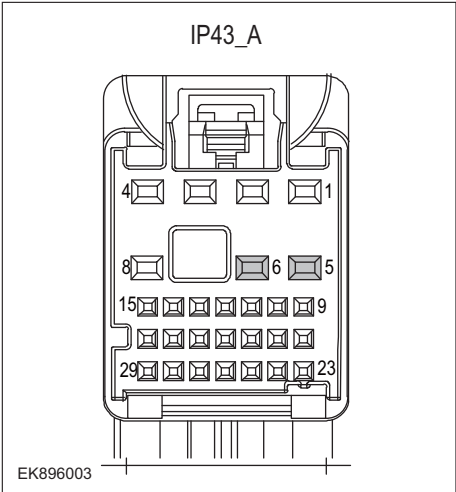
Steps4	Check the power voltage when the FICM is started or operating
	<ol style="list-style-type: none"> 1 Turn the ignition switch to OFF. 2 Disconnect the FICM harness plug IP43_ A. 3 Measure the resistance between the FICM harness plug and ground. Measuring circuit: IP43_ The resistance between terminal 5 of plug A and the grounding. Measuring circuit: IP43_ The resistance between terminal 6 of plug A and the grounding. Standard value: < 1Ω 4 Test whether the resistance is less than 1Ω?
NO → Repair or replace the faulted parts.	
YES ↓	
Steps5	Test whether FICM is norm.
	<ol style="list-style-type: none"> 1 Turn the ignition switch to OFF. 2 Disconnect and check the FICM harness plug IP43_ A, IP43_ B. 3 Check and repair. <ul style="list-style-type: none"> • Corrosion(install new adapting piece or terminal-cleaning module and pin). • Pin damaged or bent-install new terminal/pin. 4 Fly out of pins-install new pins as needed. 5 Reconnect the FICM plug and all other previously disconnected plug. Make sure the pin is properly positioned and fixed. 6 Run the system and determine if the problem persists?
YES → Change the FICM Module	
NO ↓	
At this point the system is functioning normally. The problem may be caused by module connections. Address the root cause of any connector or pin problems.	
Next Step ↓	
Diagnosis end.	

U0237-87

Fault diagnosis code
U0237-87: Lost Communication With PEPS Module
Detection tools
1 Multimeter and diagnostic apparatus
Possible causes
<ul style="list-style-type: none"> • Circuit, terminal and adapting piece • FICM • GWM
Conditions for fault code operation
Turn the ignition switch to the ON position
Conditions for fault code setting
U0237-87
To set the effect of a fault code condition
Description of circuit diagram
<p>The device is connected to the serial data circuit and monitors the serial data communication during normal vehicle operation. Devices exchange operational information and instructions with each other. The device has programming information that needs to be exchanged on the serial data circuit. The receiver device also monitors this information; In addition, some regular information is used to indicate the availability of the transmitter device.</p>

Circuit diagram

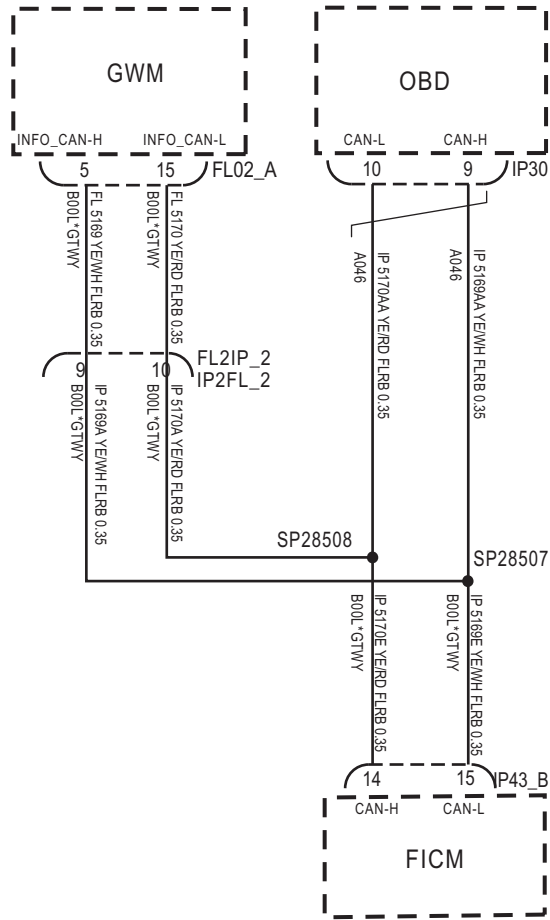

IP43_B

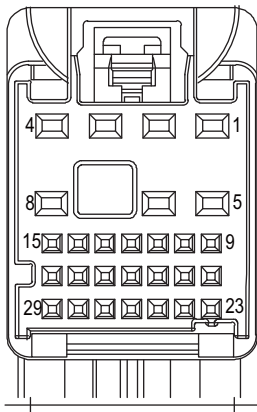

EK896004

FL02_A

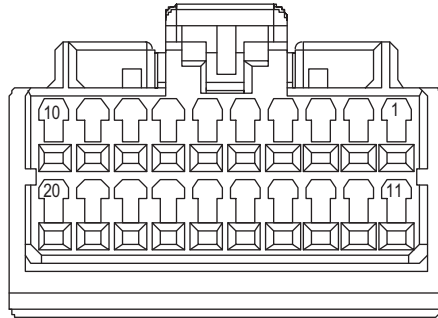

IP30

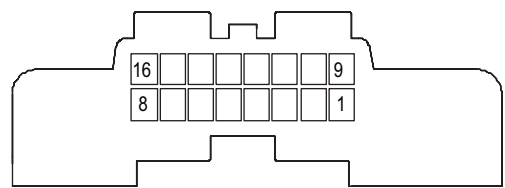

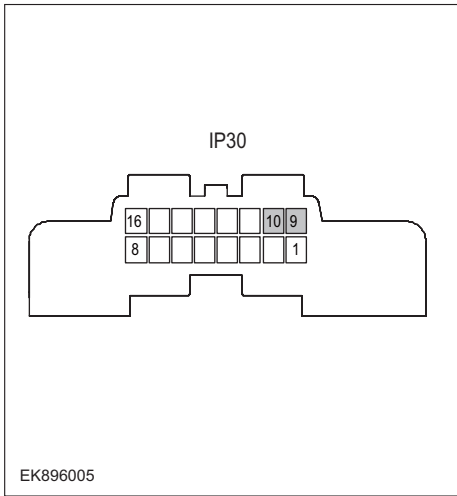
Troubleshooting steps	
Steps1	General inspection.
	<ol style="list-style-type: none"> 1 Check if the Insurance fuse is damaged. 2 Check battery capacity. 3 Check the GWM harness plug for damage, poor contact, aging, and looseness. 4 Check whether the result is normal or not?
	NO → Repair or replace the faulted parts.
YES ↓	
Steps2	Check fault codes.
	<ol style="list-style-type: none"> 1 Connect the fault diagnosis instrument to the diagnosis interface. 2 Turn the ignition switch to ON position. 3 Diagnose the GWM with diagnostic apparatus. 4 If there is any fault code except for U0237-87?
	YES → Refer to: DTC Summary List (FICM) - left .
NO ↓	
Steps3	Check the integrity of the CAN communication network.
	<ol style="list-style-type: none"> 1 Turn the ignition switch to OFF. 2 Measure the resistance between the diagnostic interface harness terminals. Measuring circuit: The resistance between terminal 9 and terminal 10 of IP30 plug. Standard value: $\approx 60 \Omega$ 3 Check whether the result is normal or not?
	NO → Repair or replace the faulted parts.
YES ↓	

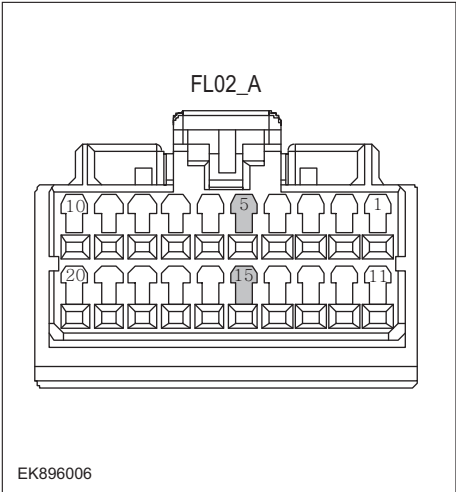
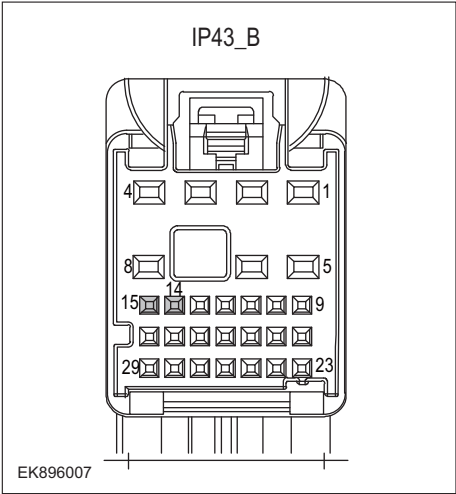
Steps4	Check the terminal resistance of GWM and FICM.
<div style="text-align: center;">  <p>FL02_A</p> <p>EK896006</p> </div> <div style="text-align: center; margin-top: 20px;">  <p>IP43_B</p> <p>EK896007</p> </div>	<ol style="list-style-type: none"> 1 Turn the ignition switch to OFF. 2 Disconnect the GWM harness plug FL02_ A. 3 Measure the resistance between the GWM harness terminals. Measuring circuit: FL02_ The resistance between terminal 5 and terminal 15 of plug A. Standard value: 110~130 Ω 4 Connect GWM harness plug FL02_ A. 5 Disconnect the harness plug IP43_ B of FICM module. 6 Measure the resistance between the FICM harness terminals. Measuring circuit: IP43_ The resistance between terminal 14 and terminal 15 of plug B. Standard value: 110~130 Ω 7 Check whether the result is normal or not?
	<p>NO → Repair or replace the faulted parts.</p>
<p>YES ↓</p>	

Steps5	Test whether FICM is norm.
	<ol style="list-style-type: none"> 1 Turn the ignition switch to OFF. 2 Disconnect and check the FICM harness plug IP43_ A, IP43_ B. 3 Check and repair. <ul style="list-style-type: none"> • Corrosion(install new adapting piece or terminal-cleaning module and pin). • Pin damaged or bent-install new terminal/pin. • Fly out of pins-install new pins as needed. 4 Reconnect the FICM plug and all other previously disconnected plug. Make sure the pin is properly positioned and fixed. 5 Run the system and determine if the problem persists?
	YES → Change the FICM Module
NO ↓	
At this point the system is functioning normally. The problem may be caused by module connections. Address the root cause of any connector or pin problems.	
Next Step ↓	
Diagnosis end.	

U0236-87

Fault diagnosis code
U0236-87: Lost Communication With LDW Module
Detection tools
1 Multimeter and diagnostic apparatus
Possible causes
<ul style="list-style-type: none"> • Circuit, terminal and adapting piece • FICM • GWM
Conditions for fault code operation
Turn the ignition switch to the ON position
Conditions for fault code setting
U0236-87
To set the effect of a fault code condition
Description of circuit diagram
<p>The device is connected to the serial data circuit and monitors the serial data communication during normal vehicle operation. Devices exchange operational information and instructions with each other. The device has programming information that needs to be exchanged on the serial data circuit. The receiver device also monitors this information; In addition, some regular information is used to indicate the availability of the transmitter device.</p>

Circuit diagram

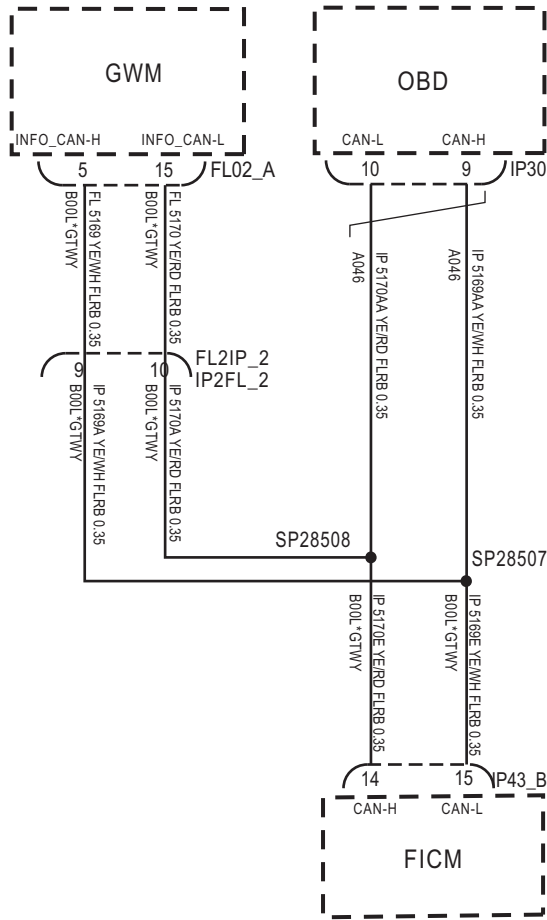

IP43_B

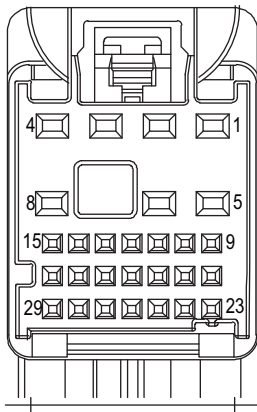

EK896004

FL02_A

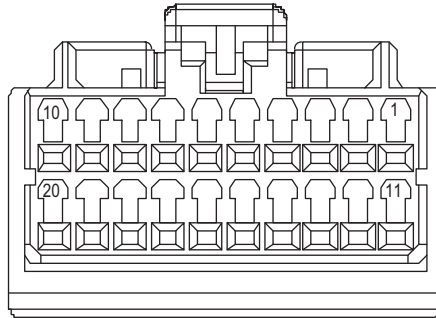

IP30

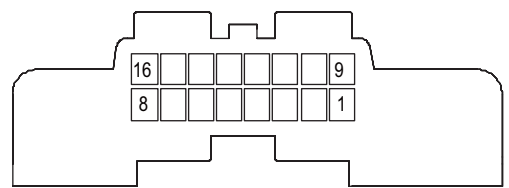

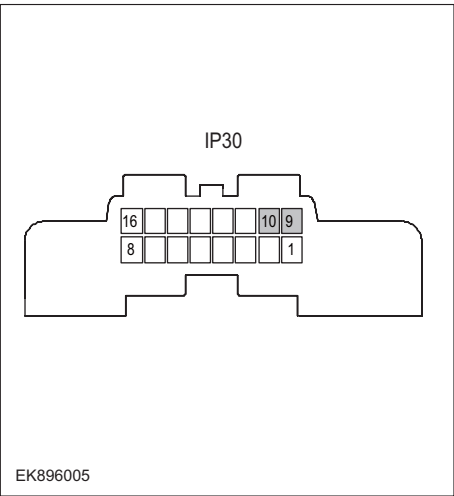
Troubleshooting steps	
Steps1	General inspection.
	<ol style="list-style-type: none"> 1 Check if the Insurance fuse is damaged. 2 Check battery capacity. 3 Check the GWM harness plug for damage, poor contact, aging, and looseness. 4 Check whether the result is normal or not?
NO → Repair or replace the faulted parts.	
YES ↓	
Steps2	Check fault codes.
	<ol style="list-style-type: none"> 1 Connect the fault diagnosis instrument to the diagnosis interface. 2 Turn the ignition switch to ON position. 3 Diagnose the GWM with diagnostic apparatus. 4 If there is any fault code except for U0236-87?
YES → Refer to: DTC Summary List (FICM) - left .	
NO ↓	
Steps3	Check the integrity of the CAN communication network.
 <p style="text-align: center;">IP30</p> <p style="text-align: center;">EK896005</p>	<ol style="list-style-type: none"> 1 Turn the ignition switch to OFF. 2 Measure the resistance between the diagnostic interface harness terminals. Measuring circuit: The resistance between terminal 9 and terminal 10 of IP30 plug. Standard value: $\approx 60 \Omega$ 3 Check whether the result is normal or not?
NO → Repair or replace the faulted parts.	
YES ↓	

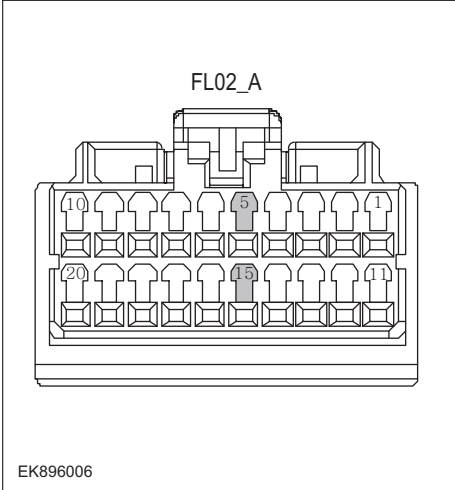
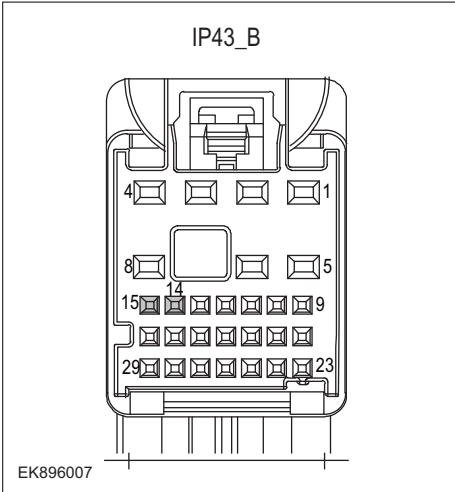
Steps4	Check the terminal resistance of GWM and FICM.
<div style="text-align: center;">  <p>FL02_A</p> <p>EK896006</p> </div> <div style="text-align: center; margin-top: 20px;">  <p>IP43_B</p> <p>EK896007</p> </div>	<ol style="list-style-type: none"> 1 Turn the ignition switch to OFF. 2 Disconnect the GWM harness plug FL02_ A. 3 Measure the resistance between the GWM harness terminals. Measuring circuit: FL02_ The resistance between terminal 5 and terminal 15 of plug A. Standard value: 110~130 Ω 4 Connect GWM harness plug FL02_ A. 5 Disconnect the harness plug IP43_ B of FICM module. 6 Measure the resistance between the FICM harness terminals. Measuring circuit: IP43_ The resistance between terminal 14 and terminal 15 of plug B. Standard value: 110~130 Ω 7 Check whether the result is normal or not?
<p>YES ↓</p>	<p>NO → Repair or replace the faulted parts.</p>

FICM

Steps5	Test whether FICM is norm.
	<ol style="list-style-type: none">1 Turn the ignition switch to OFF.2 Disconnect and check the FICM harness plug IP43_ A, IP43_ B.3 Check and repair.<ul style="list-style-type: none">• Corrosion(install new adapting piece or terminal-cleaning module and pin).• Pin damaged or bent-install new terminal/pin.• Fly out of pins-install new pins as needed.4 Reconnect the FICM plug and all other previously disconnected plug. Make sure the pin is properly positioned and fixed.5 Run the system and determine if the problem persists?
	YES → Change the FICM Module
NO ↓	
At this point the system is functioning normally. The problem may be caused by module connections. Address the root cause of any connector or pin problems.	
Next Step ↓	
Diagnosis end.	

B1A20-11、 B1A20-12、 B1A20-1A、 B1A20-1B

Fault diagnosis code
B1A20-11: Speaker FrontRight Short to Ground
B1A20-12: Speaker FrontRight circuit short to battery
B1A20-1A: Speaker FrontRight circuit short
B1A20-1B: Speaker FrontRight circuit open
Detection tools
1 Multimeter and diagnostic apparatus
Possible causes
<ul style="list-style-type: none"> • Circuit,terminal and adapting piece • FICM • Passenger door speaker malfunction
Conditions for fault code operation
Turn the ignition switch to the ON position
Conditions for fault code setting
B1A20-11
B1A20-12
B1A20-1A
B1A20-1B
To set the effect of a fault code condition
1
Description of circuit diagram
FICM monitors speakers through low-level reference and signal circuits.

Circuit diagram

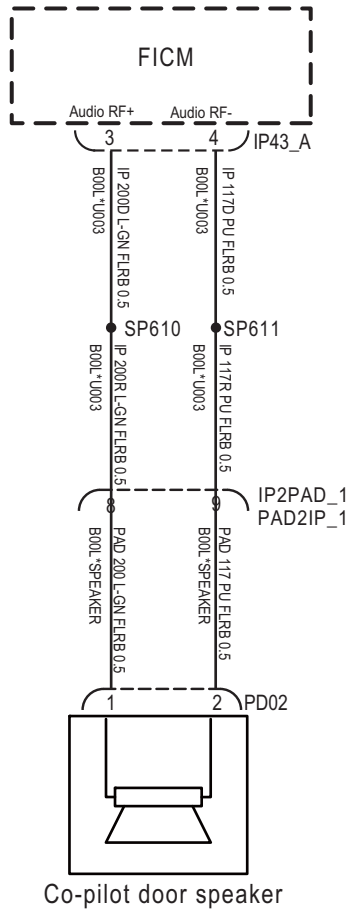

IP43_A

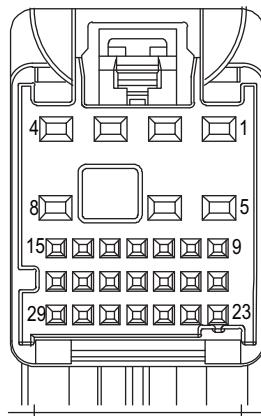

EK896008

Troubleshooting steps	
Steps1	General inspection.
	<ol style="list-style-type: none"> 1 Check if the Insurance fuse is damaged. 2 Check battery capacity. 3 Check the front passenger door speaker and FICM harness plug for damage, poor contact, aging, and looseness. 4 Check whether the result is normal or not?
	NO → Repair or replace the faulted parts.
YES ↓	
Steps2	Check fault codes.
	<ol style="list-style-type: none"> 1 Connect the fault diagnosis instrument to the diagnosis interface. 2 Turn the ignition switch to ON position. 3 Diagnose the FICM with diagnostic apparatus. 4 If there is any fault code except for B1A20-11、 B1A20-12、 B1A20-1A、 B1A20-1B?
	YES → Refer to: DTC Summary List (FICM) - left .
NO ↓	
Steps3	Check the power supply circuit of the passenger door speaker circuit.
	<ol style="list-style-type: none"> 1 Turn the ignition switch to OFF. 2 Disconnect the passenger door speaker harness plug PD02. 3 Turn on the ignition. 4 Measure the voltage between the passenger door speaker harness terminal and ground. Measuring circuit: The voltage between terminal 1 of PD02 plug and the grounding. Standard value:10~14V 5 Check whether the result is normal or not?
	NO → Repair or replace the faulted parts.
YES ↓	

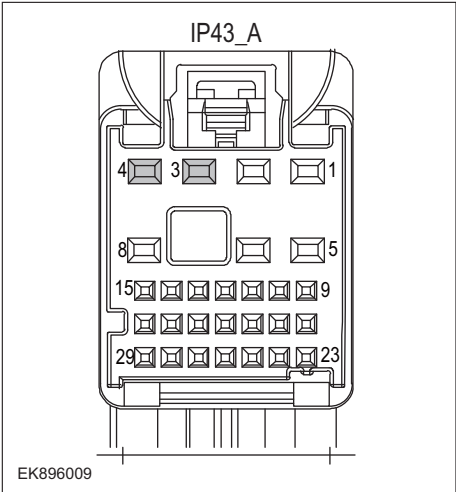
Steps4	Check the front passenger door speaker circuit (open circuit).
	<ol style="list-style-type: none"> 1 Turn the ignition switch to OFF. 2 Disconnect the FICM harness plug IP43_ A. 3 Measure the resistance between the passenger door speaker harness terminal and the FICM harness terminal. Measuring circuit: PD02 plug terminal 1 and IP43_ The resistance between terminal 3 of plug A. Measuring circuit: PD02 plug terminal 2 and IP43_ The resistance between terminal 4 of plug A. Standard value: $\approx 0 \Omega$ 4 Check whether the result is normal or not?
NO → Repair or replace the faulted parts.	
YES ↓	
Steps5	Check the front passenger door speaker circuit (short circuit).
	<ol style="list-style-type: none"> 1 Turn the ignition switch to OFF. 2 Measure the resistance between the harness plug of the passenger door speaker and ground. Measuring circuit: The resistance between terminal 1 of PD02 plug and the grounding. Measuring circuit: The resistance between terminal 2 of PD02 plug and the grounding. Standard value: infinity 3 Measure the voltage between the harness plug of the passenger door speaker and ground. Measuring circuit: The voltage between terminal 1 of PD02 plug and the grounding. Measuring circuit: The voltage between terminal 2 of PD02 plug and the grounding. Standard value: $\approx 0V$ 4 Check whether the result is normal or not?
NO → Repair or replace the faulted parts.	
YES ↓	

Steps6	Check the passenger door speaker (component inspection).
	<p>1 Measure the resistance of the passenger door speaker terminal directly.</p> <p>Measuring circuit: The resistance between terminal 1 and terminal 2 of PD02 plug.</p> <p>Standard value:</p> <p>2 Measure the resistance between the passenger door speaker terminal and the housing.</p> <p>Measuring circuit: The resistance between terminal 1 of PD02 plug and the housing.</p> <p>Measuring circuit: The resistance between terminal 2 of PD02 plug and the housing.</p> <p>Standard value: infinity</p> <p>3 Check whether the result is normal or not?</p>
	NO → Replace the passenger door speaker.
YES ↓	
Steps7	Test whether FICM is norm.
	<p>1 Turn the ignition switch to OFF.</p> <p>2 Disconnect and check the FICM harness plug IP43_ A, P55_ B.</p> <p>3 Check and repair.</p> <ul style="list-style-type: none"> • Corrosion(install new adapting piece or terminal-cleaning module and pin). • Pin damaged or bent-install new terminal/pin. • Fly out of pins-install new pins as needed. <p>4 Reconnect the FICM plug and all other previously disconnected plug. Make sure the pin is properly positioned and fixed.</p> <p>5 Run the system and determine if the problem persists?</p>
	YES → Change the FICM Module
NO ↓	
At this point the system is functioning normally. The problem may be caused by module connections. Address the root cause of any connector or pin problems.	
Next Step ↓	
Diagnosis end.	

FICM

B1A21-11、 B1A21-12、 B1A21-1A、 B1A21-1B

Fault diagnosis code
B1A21-11: Speaker FrontLeft Short to Ground
B1A21-12: Speaker FrontLeft circuit short to battery
B1A21-1A: Speaker FrontLeft circuit short
B1A21-1B: Speaker FrontLeft circuit open
Detection tools
1 Multimeter and diagnostic apparatus
Possible causes
<ul style="list-style-type: none">• Circuit,terminal and adapting piece• FICM• Driver's door speaker malfunction
Conditions for fault code operation
Turn the ignition switch to the ON position
Conditions for fault code setting
B1A21-11
B1A21-12
B1A21-1A
B1A21-1B
To set the effect of a fault code condition
1
Description of circuit diagram
FICM monitors speakers through low-level reference and signal circuits.

Circuit diagram

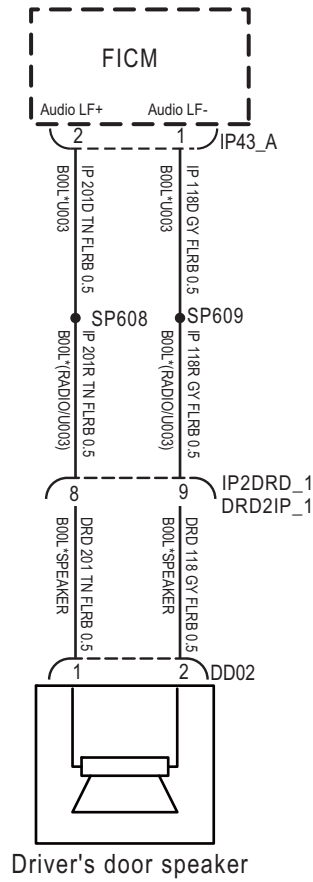

IP43_A

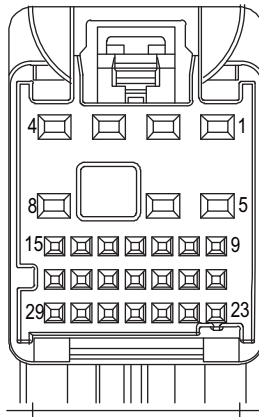

EK896010

FICM

Troubleshooting steps	
Steps1	General inspection.
	<ol style="list-style-type: none"> 1 Check if the Insurance fuse is damaged. 2 Check battery capacity. 3 Check the driver's door speaker and FICM harness plug for damage, poor contact, aging, and looseness. 4 Check whether the result is normal or not?
	NO → Repair or replace the faulted parts.
YES ↓	
Steps2	Check fault codes.
	<ol style="list-style-type: none"> 1 Connect the fault diagnosis instrument to the diagnosis interface. 2 Turn the ignition switch to ON position. 3 Diagnose the FICM with diagnostic apparatus. 4 If there is any fault code except for B1A21-11、 B1A21-12、 B1A21-1A、 B1A21-1B?
	YES → Refer to: DTC Summary List (FICM) - left .
NO ↓	
Steps3	Check the power supply circuit of the driver's door speaker circuit.
	<ol style="list-style-type: none"> 1 Turn the ignition switch to OFF. 2 Disconnect the driver's door speaker harness plug DD02. 3 Turn on the ignition. 4 Measure the voltage between the driver's door speaker harness terminal and ground. Measuring circuit: The voltage between terminal 1 of DD02 plug and the grounding. Standard value:10~14V 5 Check whether the result is normal or not?
	NO → Repair or replace the faulted parts.
YES ↓	

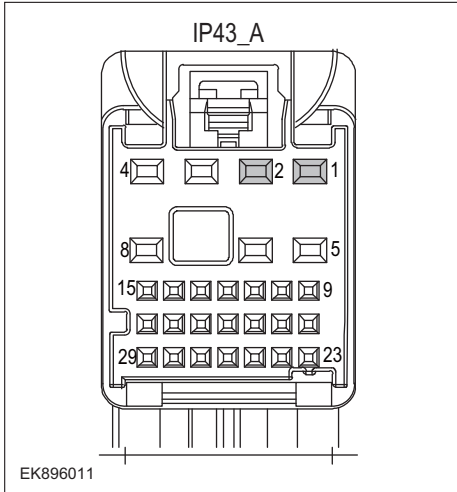
Steps4	Check the driver's door speaker circuit (open circuit).
	<ol style="list-style-type: none"> 1 Turn the ignition switch to OFF. 2 Disconnect the FICM harness plug IP43_ A. 3 Measure the resistance between the driver's door speaker harness terminal and the FICM harness terminal. Measuring circuit: DD02 plug terminal 1 and IP43_ The resistance between terminal 2 of plug A. Measuring circuit: DD02 plug terminal 2 and IP43_ The resistance between terminal 1 of plug A. Standard value: $\approx 0 \Omega$ 4 Check whether the result is normal or not?
NO → Repair or replace the faulted parts.	
YES ↓	
Steps5	Check the driver's door speaker circuit (short circuit).
	<ol style="list-style-type: none"> 1 Turn the ignition switch to OFF. 2 Measure the resistance between the driver's door speaker harness plug and ground. Measuring circuit: The resistance between terminal 1 of DD02 plug and the grounding. Measuring circuit: The resistance between terminal 2 of DD02 plug and the grounding. Standard value: infinity 3 Measure the voltage between the driver's door speaker harness plug and ground. Measuring circuit: The voltage between terminal 1 of DD02 plug and the grounding. Measuring circuit: The voltage between terminal 2 of DD02 plug and the grounding. Standard value: $\approx 0V$ 4 Check whether the result is normal or not?
NO → Repair or replace the faulted parts.	
YES ↓	

FICM

Steps6	Check the driver's door speaker (component inspection).
	<p>1 Measure the resistance of the driver's door speaker terminal directly.</p> <p>Measuring circuit: The resistance between terminal 1 and terminal 2 of plug DD02.</p> <p>Standard value:</p> <p>2 Measure the resistance between the driver's door speaker terminal and the housing.</p> <p>Measuring circuit: The resistance between terminal 1 of DD02 plug and the housing.</p> <p>Measuring circuit: The resistance between terminal 2 of DD02 plug and the housing.</p> <p>Standard value: infinity</p> <p>3 Check whether the result is normal or not?</p>
	NO → Replace the driver's door speaker.
YES ↓	
Steps7	Test whether FICM is norm.
	<p>1 Turn the ignition switch to OFF.</p> <p>2 Disconnect and check the FICM harness plug IP43_ A、P55_ B.</p> <p>3 Check and repair.</p> <ul style="list-style-type: none"> • Corrosion(install new adapting piece or terminal-cleaning module and pin). • Pin damaged or bent-install new terminal/pin. • Fly out of pins-install new pins as needed. <p>4 Reconnect the FICM plug and all other previously disconnected plug. Make sure the pin is properly positioned and fixed.</p> <p>5 Run the system and determine if the problem persists?</p>
	YES → Change the FICM Module
NO ↓	
At this point the system is functioning normally. The problem may be caused by module connections. Address the root cause of any connector or pin problems.	
Next Step ↓	
Diagnosis end.	

B1A22-11、 B1A22-12、 B1A22-1A、 B1A22-1B

Fault diagnosis code
B1A22-11: Speaker RearRight Short to Ground
B1A22-12: Speaker RearRight circuit short to battery
B1A22-1A: Speaker RearRight circuit short
B1A22-1B: Speaker RearRight circuit open
Detection tools
1 Multimeter and diagnostic apparatus
Possible causes
<ul style="list-style-type: none"> • Circuit,terminal and adapting piece • FICM • Driver's door speaker malfunction
Conditions for fault code operation
Turn the ignition switch to the ON position
Conditions for fault code setting
B1A22-11
B1A22-12
B1A22-1A
B1A22-1B
To set the effect of a fault code condition
1
Description of circuit diagram
FICM monitors speakers through low-level reference and signal circuits.

Circuit diagram

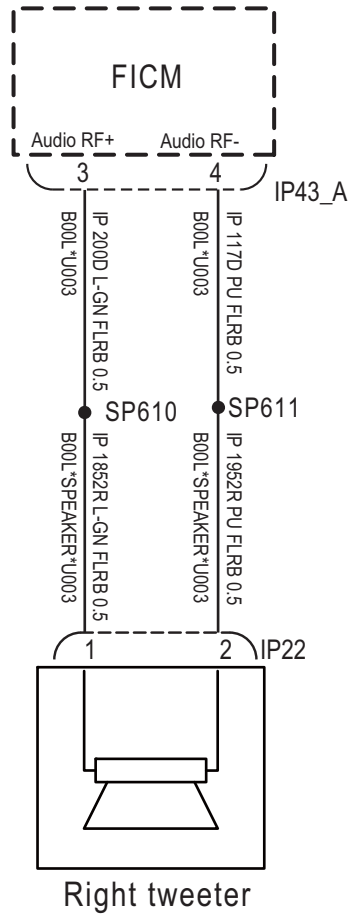

IP43_A

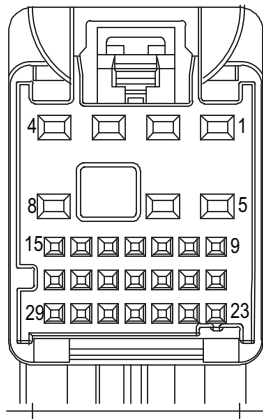

IP22

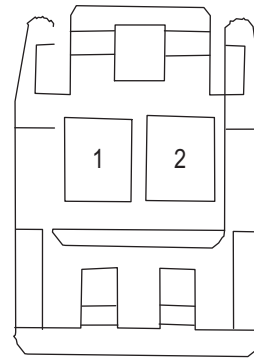

EK896012

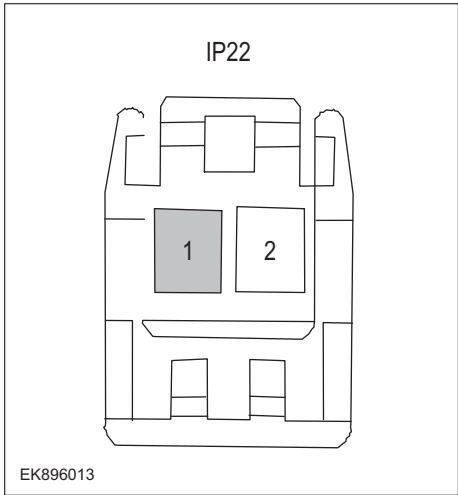
Troubleshooting steps	
Steps1	General inspection.
	<ol style="list-style-type: none"> 1 Check if the Insurance fuse is damaged. 2 Check battery capacity. 3 Check the right tweeter speaker and FICM harness plug for damage, poor contact, aging, and looseness. 4 Check whether the result is normal or not?
	NO → Repair or replace the faulted parts.
YES ↓	
Steps2	Check fault codes.
	<ol style="list-style-type: none"> 1 Connect the fault diagnosis instrument to the diagnosis interface. 2 Turn the ignition switch to ON position. 3 Diagnose the FICM with diagnostic apparatus. 4 If there is any fault code except for B1A22-11、 B1A22-12、 B1A22-1A、 B1A22-1B?
	YES → Refer to: DTC Summary List (FICM) - left.
NO ↓	
Steps3	Check the power supply circuit of the right tweeter speaker circuit.
 <p style="text-align: center;">IP22</p> <p style="text-align: center;">1 2</p> <p>EK896013</p>	<ol style="list-style-type: none"> 1 Turn the ignition switch to OFF. 2 Disconnect the right tweeter harness plug IP22. 3 Turn on the ignition. 4 Measure the voltage between the right tweeter speaker harness terminal and ground. Measuring circuit: The voltage between terminal 1 of IP22 plug and the grounding. Standard value:10~14V 5 Check whether the result is normal or not?
	NO → Repair or replace the faulted parts.
YES ↓	

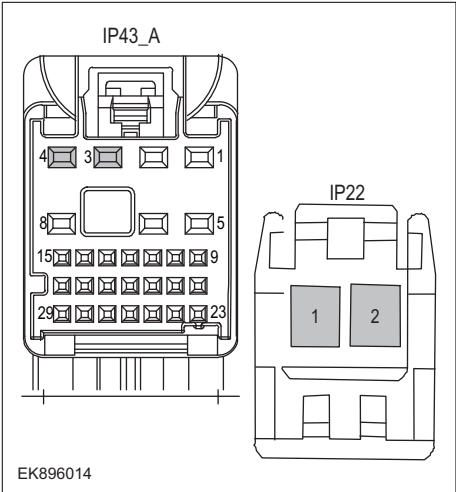
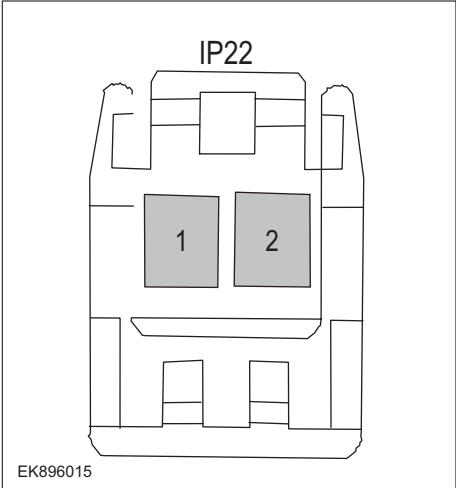
Steps4	Check the circuit of the right tweeter speaker (open circuit).
 <p>EK896014</p>	<ol style="list-style-type: none"> 1 Turn the ignition switch to OFF. 2 Disconnect the FICM harness plug IP43_ A. 3 Measure the resistance between the right tweeter speaker harness terminal and the FICM harness terminal. Measuring circuit: IP22 plug terminal 1 and IP43_ The resistance between terminal 3 of plug A. Measuring circuit: IP22 plug terminal 2 and IP43_ The resistance between terminal 4 of plug A. Standard value: $\approx 0 \Omega$ 4 Check whether the result is normal or not?
NO → Repair or replace the faulted parts.	
YES ↓	
Steps5	Check the circuit of the right tweeter speaker (short circuit).
 <p>EK896015</p>	<ol style="list-style-type: none"> 1 Turn the ignition switch to OFF. 2 Measure the resistance between the harness plug of the right tweeter speaker and ground. Measuring circuit: The resistance between terminal 1 of IP22 plug and the grounding. Measuring circuit: The resistance between terminal 2 of IP22 plug and the grounding. Standard value: infinity 3 Measure the voltage between the harness plug of the right tweeter speaker and ground. Measuring circuit: voltage between terminal 1 of IP22 plug and ground. Measuring circuit: The voltage between terminal 2 of IP22 plug and the grounding. Standard value: $\approx 0V$ 4 Check whether the result is normal or not?
NO → Repair or replace the faulted parts.	
YES ↓	

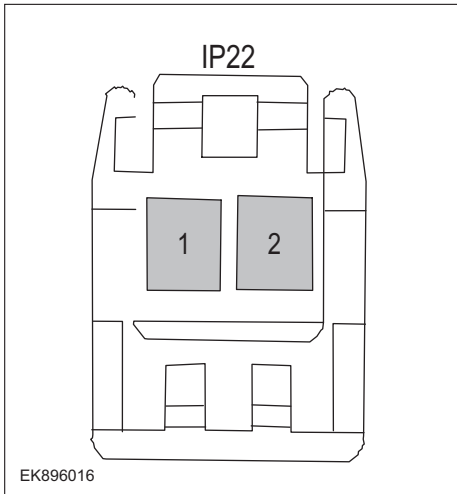
Steps6	Check the right tweeter speaker (component inspection).
 <p>EK896016</p>	<ol style="list-style-type: none"> 1 Measure the resistance of the right tweeter speaker terminal directly. Measuring circuit: The resistance between terminal 1 and terminal 2 of IP22 plug. Standard value: 2 Measure the resistance between the right tweeter speaker terminal and the housing. Measuring circuit: The resistance between terminal 1 of IP22 plug and the housing. Measuring circuit: The resistance between terminal 2 of IP22 plug and the housing. Standard value: infinity 3 Check whether the result is normal or not?
<p>NO → Replace the right tweeter speaker.</p>	
<p>YES ↓</p>	
Steps7	Test whether FICM is norm.
	<ol style="list-style-type: none"> 1 Turn the ignition switch to OFF. 2 Disconnect and check the FICM harness plug IP43_ A, P55_ B. 3 Check and repair. <ul style="list-style-type: none"> • Corrosion(install new adapting piece or terminal-cleaning module and pin). • Pin damaged or bent-install new terminal/pin. • Fly out of pins-install new pins as needed. 4 Reconnect the FICM plug and all other previously disconnected plug. Make sure the pin is properly positioned and fixed. 5 Run the system and determine if the problem persists?
<p>YES → Change the FICM Module</p>	
<p>NO ↓</p>	
<p>At this point the system is functioning normally. The problem may be caused by module connections. Address the root cause of any connector or pin problems.</p>	
<p>Next Step ↓</p>	
<p>Diagnosis end.</p>	

FICM

B1A23-11、 B1A23-12、 B1A23-1A、 B1A23-1B

Fault diagnosis code
B1A23-11: Speaker RearLeft Short to Ground
B1A23-12: Speaker RearLeft circuit short to battery
B1A23-1A: Speaker RearLeft circuit short
B1A23-1B: Speaker RearLeft circuit open
Detection tools
1 Multimeter and diagnostic apparatus
Possible causes
<ul style="list-style-type: none">• Circuit,terminal and adapting piece• FICM• Driver's door speaker malfunction
Conditions for fault code operation
Turn the ignition switch to the ON position
Conditions for fault code setting
B1A23-11
B1A23-12
B1A23-1A
B1A23-1B
To set the effect of a fault code condition
1
Description of circuit diagram
FICM monitors speakers through low-level reference and signal circuits.

Circuit diagram

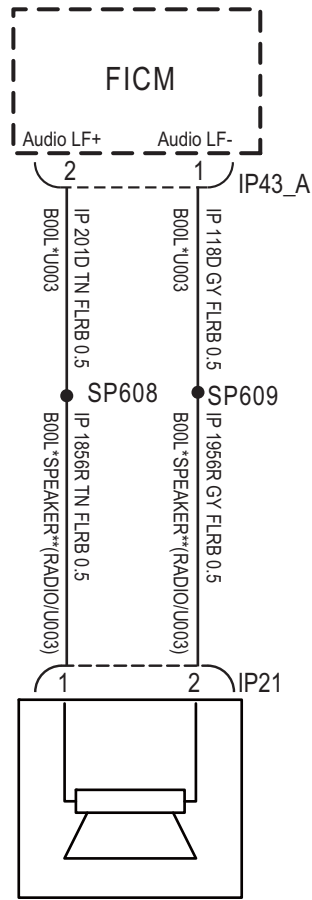

Left tweeter

IP43_A

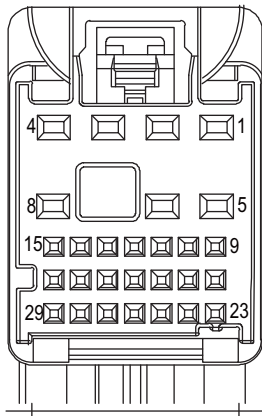

IP21

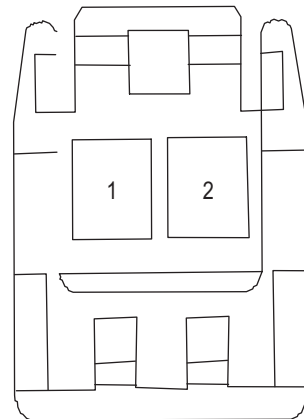

EK896017

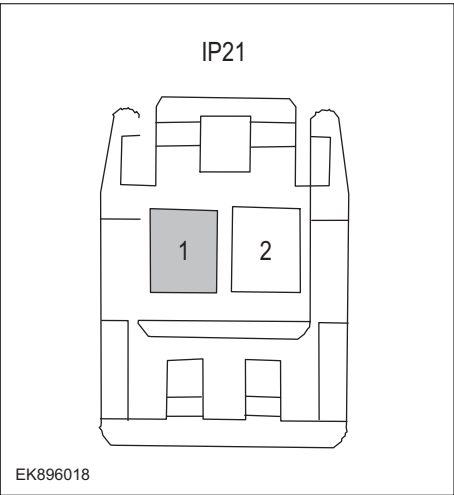
Troubleshooting steps	
Steps1	General inspection.
	<ol style="list-style-type: none"> 1 Check if the Insurance fuse is damaged. 2 Check battery capacity. 3 Check the left tweeter speaker and FICM harness plugs for damage, poor contact, aging, and looseness. 4 Check whether the result is normal or not?
NO → Repair or replace the faulted parts.	
YES ↓	
Steps2	Check fault codes.
	<ol style="list-style-type: none"> 1 Connect the fault diagnosis instrument to the diagnosis interface. 2 Turn the ignition switch to ON position. 3 Diagnose the FICM with diagnostic apparatus. 4 If there is any fault code except for B1A23-11、 B1A23-12、 B1A23-1A、 B1A23-1B?
YES → Refer to: DTC Summary List (FICM) - left .	
NO ↓	
Steps3	Check the power supply circuit of the left tweeter speaker circuit.
	<ol style="list-style-type: none"> 1 Turn the ignition switch to OFF. 2 Disconnect the left tweeter speaker harness plug IP21. 3 Turn on the ignition. 4 Measure the voltage between the right tweeter speaker harness terminal and ground. Measuring circuit: The voltage between terminal 1 of IP21 plug and the grounding. Standard value:10~14V 5 Check whether the result is normal or not?
NO → Repair or replace the faulted parts.	
YES ↓	

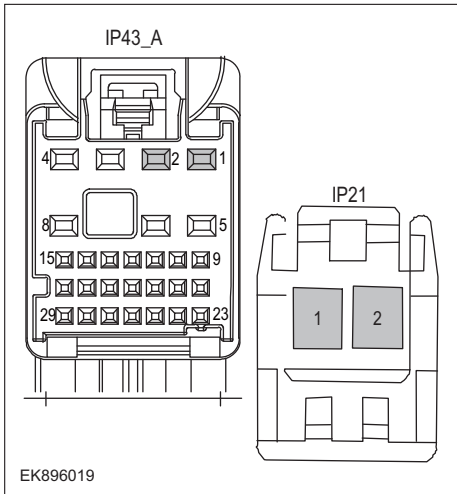
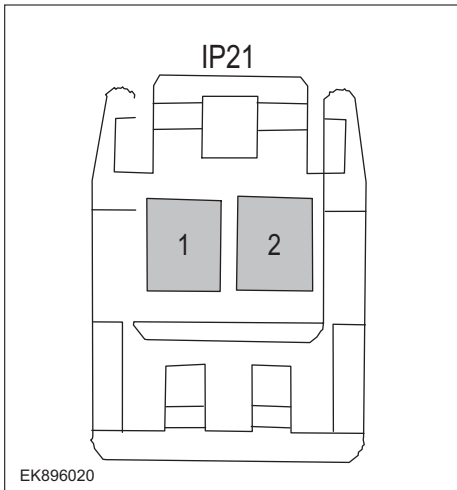
Steps4	Check the left tweeter speaker circuit (open circuit).
 <p>EK896019</p>	<ol style="list-style-type: none"> 1 Turn the ignition switch to OFF. 2 Disconnect the FICM harness plug IP43_ A. 3 Measure the resistance between the left tweeter speaker harness terminal and the FICM harness terminal. Measuring circuit: IP21 plug terminal 1 and IP43_ The resistance between terminal 2 of plug A. Measuring circuit: IP21 plug terminal 2 and IP43_ The resistance between terminal 1 of plug A. Standard value: $\approx 0 \Omega$ 4 Check whether the result is normal or not?
<p>NO → Repair or replace the faulted parts.</p>	
<p>YES ↓</p>	
Steps5	Check the left tweeter speaker circuit (short circuit).
 <p>EK896020</p>	<ol style="list-style-type: none"> 1 Turn the ignition switch to OFF. 2 Measure the resistance between the harness plug of the left tweeter speaker and ground. Measuring circuit: The resistance between terminal 1 of IP21 plug and the grounding. Measuring circuit: The resistance between terminal 2 of IP21 plug and the grounding. Standard value: infinity 3 Measure the voltage between the harness plug of the right tweeter speaker and ground. Measuring circuit: The voltage between terminal 1 of IP21 plug and the grounding. Measuring circuit: The voltage between terminal 2 of IP21 plug and the grounding. Standard value: $\approx 0V$ 4 Check whether the result is normal or not?
<p>NO → Repair or replace the faulted parts.</p>	
<p>YES ↓</p>	

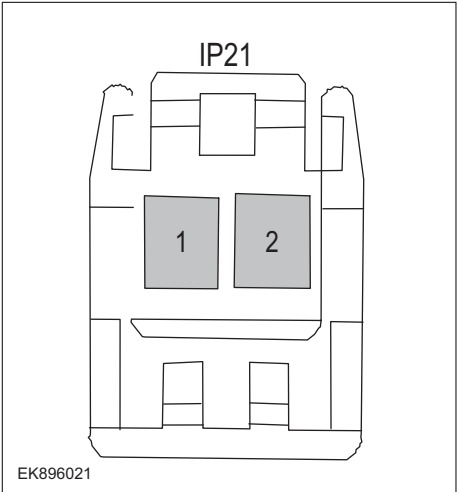
Steps6	Check the left tweeter speaker (component inspection).
	<ol style="list-style-type: none"> 1 Measure the resistance of the left tweeter speaker terminal directly. Measuring circuit: The resistance between terminal 1 and terminal 2 of IP21 plug. Standard value: 2 Measure the resistance between the left tweeter speaker terminal and the housing. Measuring circuit: The resistance between terminal 1 of IP21 plug and the housing. Measuring circuit: The resistance between terminal 2 of IP21 plug and the housing. Standard value: infinity 3 Check whether the result is normal or not?
<p>NO → Replace the left tweeter speaker.</p>	
<p>YES ↓</p>	
Steps7	Test whether FICM is norm.
	<ol style="list-style-type: none"> 1 Turn the ignition switch to OFF. 2 Disconnect and check the FICM harness plug IP43_ A、P55_ B. 3 Check and repair. <ul style="list-style-type: none"> • Corrosion(install new adapting piece or terminal-cleaning module and pin). • Pin damaged or bent-install new terminal/pin. • Fly out of pins-install new pins as needed. 4 Reconnect the FICM plug and all other previously disconnected plug. Make sure the pin is properly positioned and fixed. 5 Run the system and determine if the problem persists?
<p>YES → Change the FICM Module</p>	
<p>NO ↓</p>	
<p>At this point the system is functioning normally. The problem may be caused by module connections. Address the root cause of any connector or pin problems.</p>	
<p>Next Step ↓</p>	
<p>Diagnosis end.</p>	

B1A27-01

Fault diagnosis code
B1A27-01: Power of USB port for TBOX Error
Detection tools
1 Multimeter and diagnostic apparatus
Possible causes
<ul style="list-style-type: none"> • Circuit,terminal and adapting piece • Battery • FICM • Charging system • Insurance fuse
Conditions for fault code operation
Turn the ignition switch to the ON position
Conditions for fault code setting
B1A27-01
To set the effect of a fault code condition
Description of circuit diagram
The FICM will monitor whether all sensors and actuators are within normal range all the time. Meanwhile,it will check the connector for virtual connection, short circuit, open circuit and the connection rationality with other signals. When fault occurs, the FICM module will save the fault code corresponding to that fault and enable safety mode.

Circuit diagram

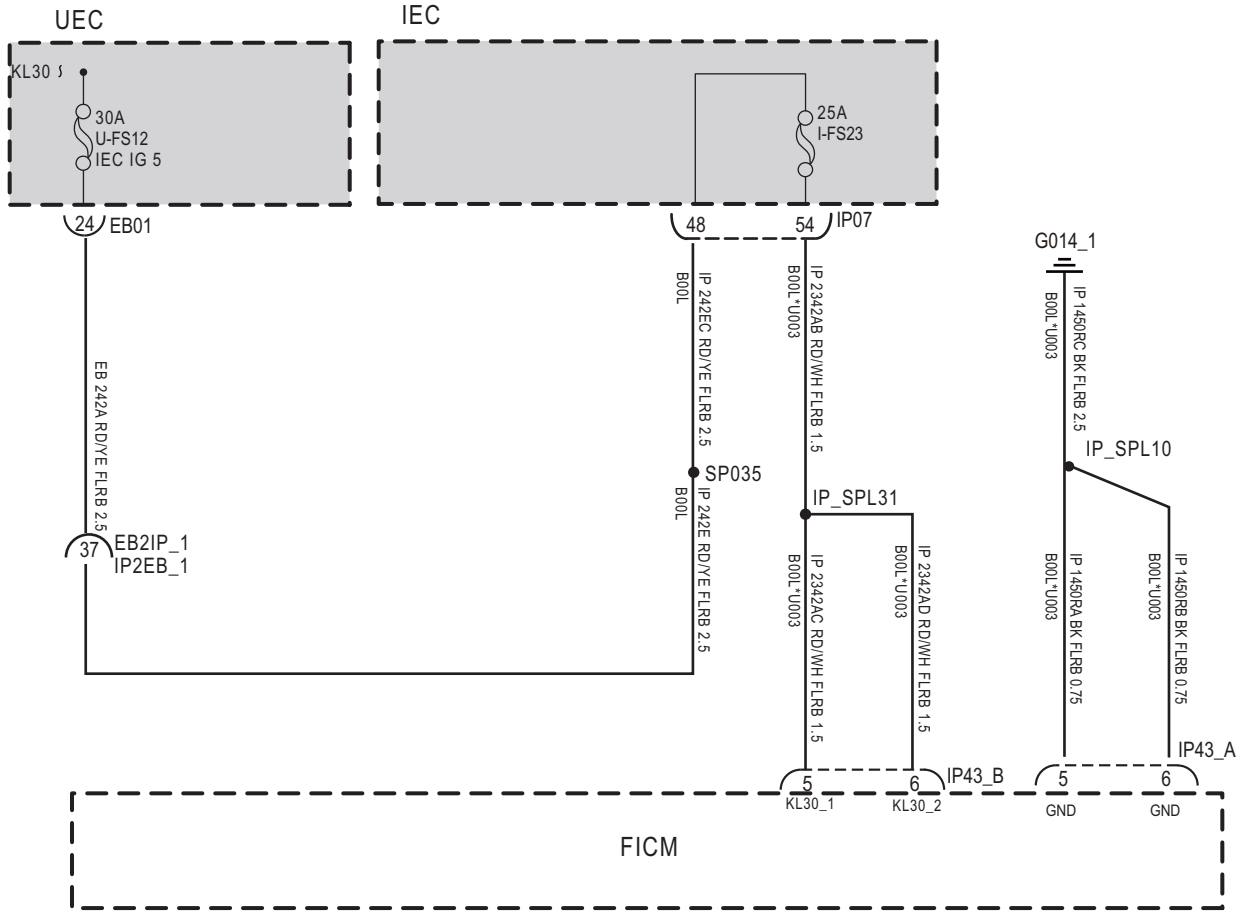

IP43_A

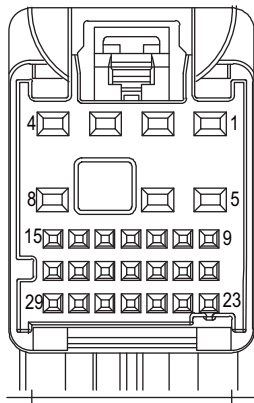

IP43_B

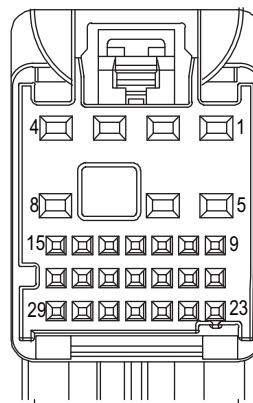

EK896001

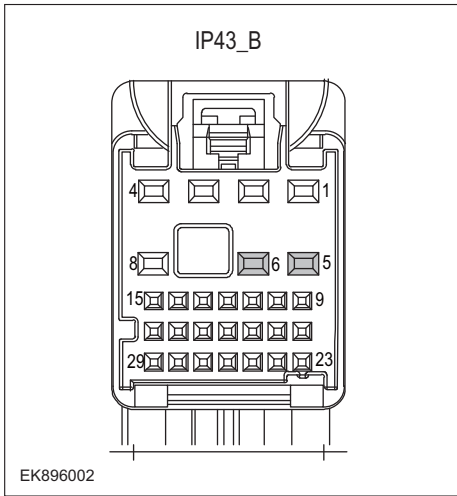
Troubleshooting steps	
Steps1	General inspection.
	<ol style="list-style-type: none"> 1 Check fusesU-FS12、 I-FS23 for damage. 2 Check battery capacity. 3 Check the harness plug of FICM for damage, poor contact, aging and looseness. 4 Check whether the result is normal or not?
	NO → Repair or replace the faulted parts.
YES ↓	
Steps2	Check fault codes.
	<ol style="list-style-type: none"> 1 Connect the fault diagnosis instrument to the diagnosis interface. 2 Turn the ignition switch to ON position. 3 Diagnose the FICM with diagnostic apparatus. 4 If there is any fault code except for B1A27-01?
	YES → Refer to: DTC Summary List (FICM) - left .
NO ↓	
Steps3	Check the FICMBattery power supply voltage.
	<ol style="list-style-type: none"> 1 Turn the ignition switch to OFF. 2 Disconnect the harness plug IP43_B of FICM module. 3 Measure the voltage between the FICM harness terminal and ground. Measuring circuit: IP43_ The voltage between terminal 5 of plug B and the grounding. Measuring circuit: IP43_ The voltage between terminal 6 of plug B and the grounding. Standard value:10~14V 4 Check whether the result is normal or not?
	NO → Repair or replace the faulted parts.
YES ↓	

FICM

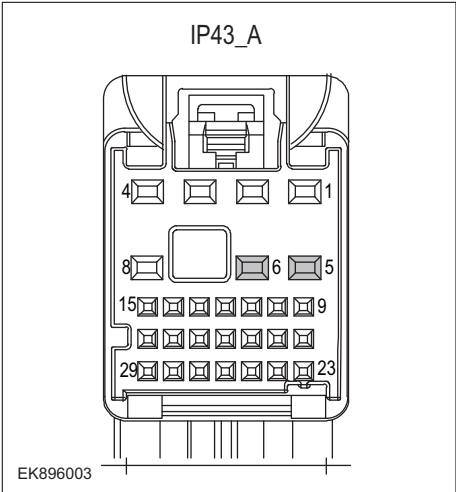
Steps4	Check the power voltage when the FICM is started or operating
	<ol style="list-style-type: none"> 1 Turn the ignition switch to OFF. 2 Disconnect the FICM harness plug IP43_ A. 3 Measure the resistance between the FICM harness plug and ground. Measuring circuit: IP43_ The resistance between terminal 5 of plug A and the grounding. Measuring circuit: IP43_ The resistance between terminal 6 of plug A and the grounding. Standard value: < 1Ω 4 Test whether the resistance is less than 1Ω?
NO → Repair or replace the faulted parts.	
YES ↓	
Steps5	Test whether FICM is norm.
	<ol style="list-style-type: none"> 1 Turn the ignition switch to OFF. 2 Disconnect and check the FICM harness plug IP43_ A, IP43_ B. 3 Check and repair. <ul style="list-style-type: none"> • Corrosion(install new adapting piece or terminal-cleaning module and pin). • Pin damaged or bent-install new terminal/pin. 4 Fly out of pins-install new pins as needed. 5 Reconnect the FICM plug and all other previously disconnected plug. Make sure the pin is properly positioned and fixed. 6 Run the system and determine if the problem persists?
YES → Change the FICM Module	
NO ↓	
At this point the system is functioning normally. The problem may be caused by module connections. Address the root cause of any connector or pin problems.	
Next Step ↓	
Diagnosis end.	

B1A24-01

Fault diagnosis code
B1A24-01: Power of USB1 port Error
Detection tools
1 Multimeter and diagnostic apparatus
Possible causes
<ul style="list-style-type: none"> • Circuit, terminal and adapting piece • FICM • USB1 interface failure
Conditions for fault code operation
Turn the ignition switch to the ON position
Conditions for fault code setting
B1A24-01
To set the effect of a fault code condition
1
2
Description of circuit diagram
FICM monitors the USB interface through low-level reference and signal circuits.

Circuit diagram

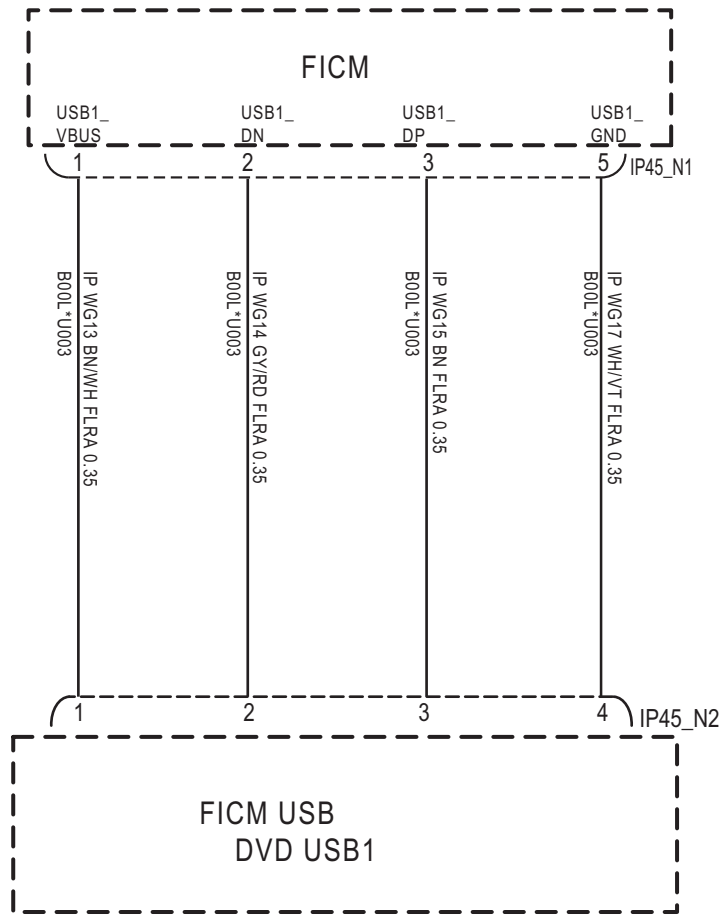

IP45_N1

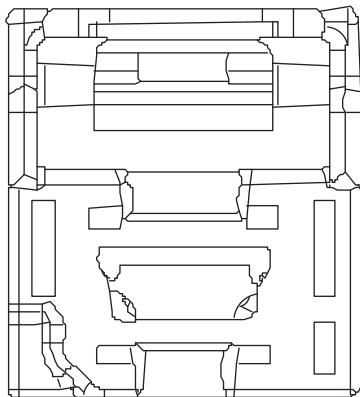

IP45_N2

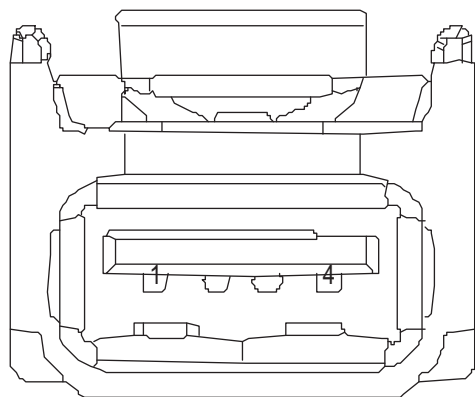

EK896022

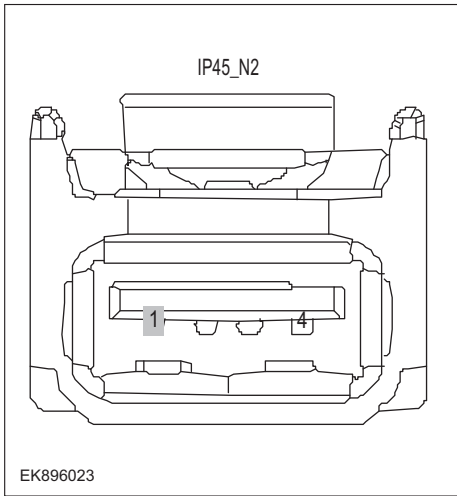
Troubleshooting steps	
Steps1	General inspection.
	<ol style="list-style-type: none"> 1 Check if the Insurance fuse is damaged. 2 Check battery capacity. 3 Check the USB1 interface and FICM harness plug for damage, poor contact, aging, and looseness. 4 Check whether the result is normal or not?
	NO → Repair or replace the faulted parts.
YES ↓	
Steps2	Check fault codes.
	<ol style="list-style-type: none"> 1 Connect the fault diagnosis instrument to the diagnosis interface. 2 Turn the ignition switch to ON position. 3 Diagnose the FICM with diagnostic apparatus. 4 If there is any fault code except for B1A24-01?
	YES → Refer to: DTC Summary List (FICM) - left .
NO ↓	
Steps3	Check the power supply circuit of the USB1 interface circuit.
	<ol style="list-style-type: none"> 1 Turn the ignition switch to OFF. 2 Disconnect the USB1 interface harness plug IP45-N2. 3 Turn on the ignition. 4 Measure the voltage between the USB1 interface harness terminal and ground. Measuring circuit: The voltage between terminal 1 of IP45-N2 plug and the grounding. Standard value: 4.8~5.2V 5 Check whether the result is normal or not?
	NO → Repair or replace the faulted parts.
YES ↓	

FICM

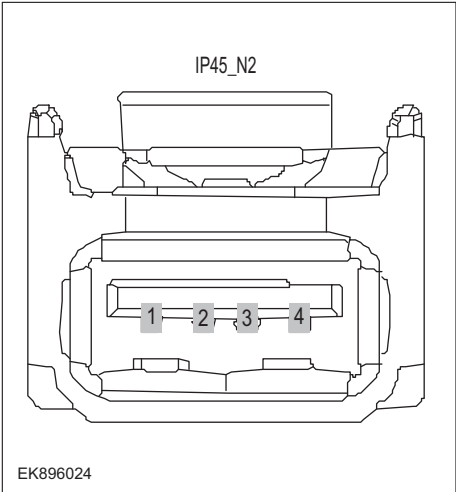
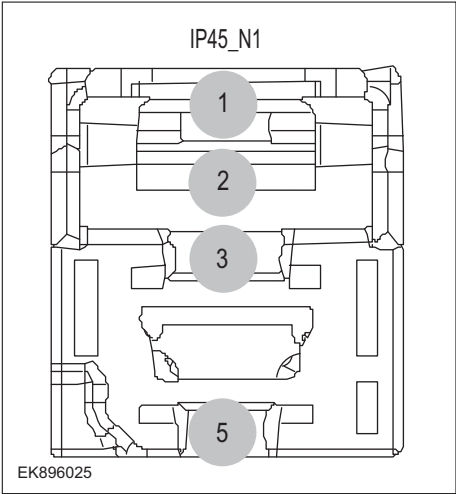
Steps4	Check the USB1 interface circuit (open circuit).
 <p>IP45_N2</p> <p>EK896024</p>  <p>IP45_N1</p> <p>EK896025</p>	<ol style="list-style-type: none">1 Turn the ignition switch to OFF.2 Disconnect the FICM harness plug IP45_ N1.3 Measure the resistance between the USB1 interface harness terminal and the FICM harness terminal. Measuring circuit: IP45-N2 plug terminal 1 and IP45_ The resistance between terminal 1 of the N1 plug. Measuring circuit: IP45-N2 plug terminal 2 and IP45_ The resistance between terminal 2 of the N1 plug. Measuring circuit: IP45-N2 plug terminal 3 and IP45_ The resistance between terminal 3 of the N1 plug. Measuring circuit: IP45-N2 plug terminal 4 and IP45_ The resistance between terminal 5 of the N1 plug.4 Check whether the result is normal or not?
	NO → Repair or replace the faulted parts.
YES ↓	

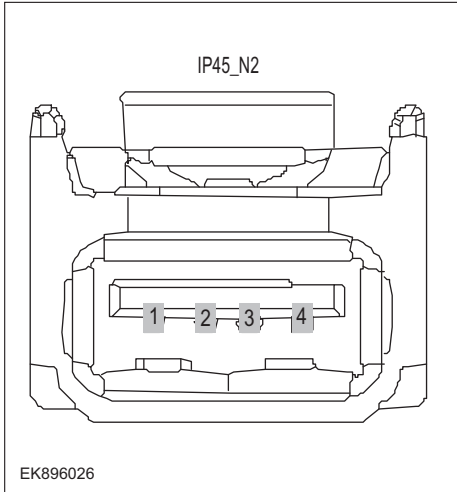
Steps5	Check the USB1 interface circuit (short circuit).
	<ol style="list-style-type: none"> 1 Turn the ignition switch to OFF. 2 Measure the resistance between the USB1 interface harness plug and ground. Measuring circuit: The resistance between terminal 1 of IP45-N2 plug and the grounding. Measuring circuit: The resistance between terminal 2 of IP45-N2 plug and the grounding. Measuring circuit: The resistance between terminal 3 of IP45-N2 plug and the grounding. Measuring circuit: The resistance between terminal 4 of IP45-N2 plug and the grounding. Standard value: infinity 3 Measure the voltage between the USB1 interface harness plug and ground. Measuring circuit: The voltage between terminal 1 of IP45-N2 plug and the grounding. Measuring circuit: The voltage between terminal 2 of IP45-N2 plug and the grounding. Measuring circuit: The voltage between terminal 3 of IP45-N2 plug and the grounding. Measuring circuit: The voltage between terminal 4 of IP45-N2 plug and the grounding. Standard value: ≈ 0V 4 Check whether the result is normal or not?
NO → Repair or replace the faulted parts.	
YES ↓	
Steps6	Check the USB1 interface (component inspection).

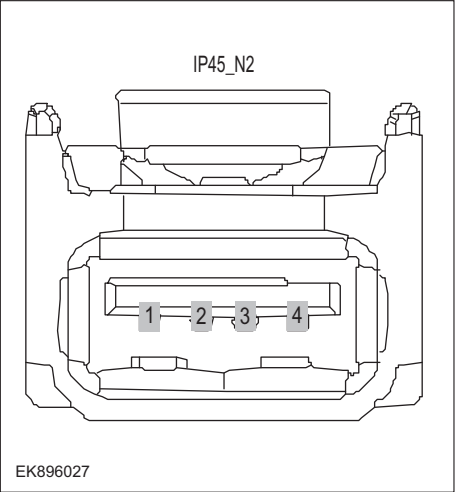
	<ol style="list-style-type: none"> 1 Measure the resistance of the USB1 interface terminal directly. Measuring circuit: The resistance between terminal 2 and terminal 3 of IP45-N2 plug. Standard value: 2 Measure the resistance between the USB1 interface harness plug and ground. Measuring circuit: The resistance between terminal 1 of IP45-N2 plug and the housing. Measuring circuit: The resistance between terminal 2 of IP45-N2 plug and the housing. Measuring circuit: The resistance between terminal 3 of IP45-N2 plug and the housing. Measuring circuit: The resistance between terminal 4 of IP45-N2 plug and the housing. Standard value: infinity 3 Check whether the result is normal or not?
	<p>NO → Replace the USB1 interface.</p>
<p>YES ↓</p>	

Steps7	Test whether FICM is norm.
	<ol style="list-style-type: none"> 1 Turn the ignition switch to OFF. 2 Disconnect and check the FICM harness plug IP43_ A、IP43_ B. 3 Check and repair. <ul style="list-style-type: none"> • Corrosion(install new adapting piece or terminal-cleaning module and pin). • Pin damaged or bent-install new terminal/pin. • Fly out of pins-install new pins as needed. 4 Reconnect the FICM plug and all other previously disconnected plug. Make sure the pin is properly positioned and fixed. 5 Run the system and determine if the problem persists?
	YES → Change the FICM Module
NO ↓	
At this point the system is functioning normally. The problem may be caused by module connections. Address the root cause of any connector or pin problems.	
Next Step ↓	
Diagnosis end.	

B1A26-01

Fault diagnosis code
B1A26-01: Powerof USB2 portError
Detection tools
1 Multimeter and diagnostic apparatus
Possible causes
<ul style="list-style-type: none"> • Circuit,terminal and adapting piece • FICM • USB1 interface failure
Conditions for fault code operation
Turn the ignition switch to the ON position
Conditions for fault code setting
B1A26-01
To set the effect of a fault code condition
1
2
Description of circuit diagram
FICM monitors the USB interface through low-level reference and signal circuits.

Circuit diagram

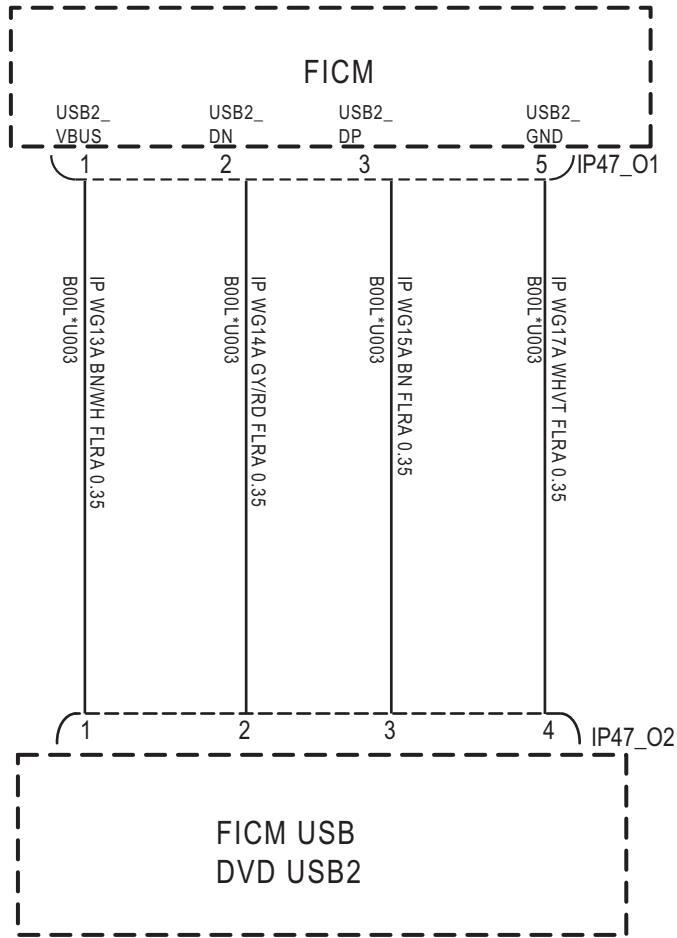

IP47_01

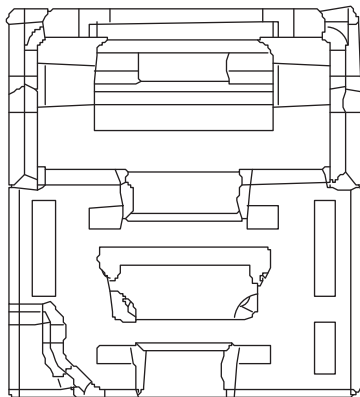

IP47_02

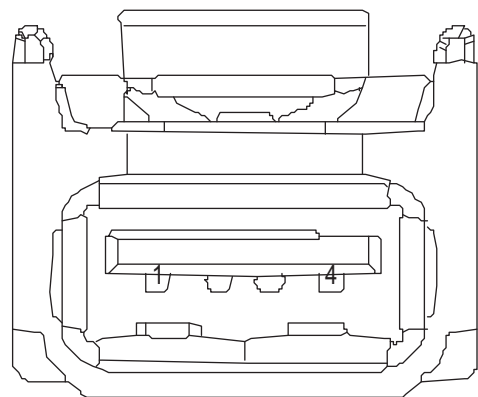

EK896028

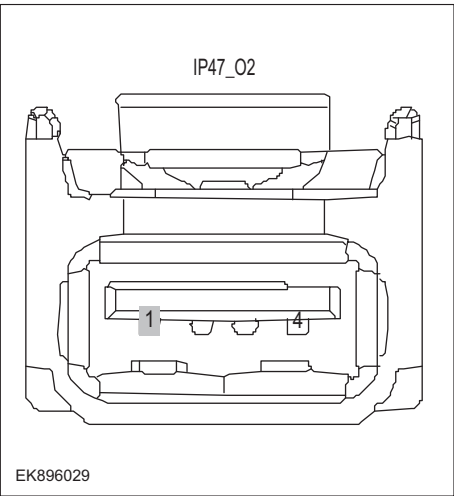
Troubleshooting steps	
Steps1	General inspection.
	<ol style="list-style-type: none"> 1 Check if the Insurance fuse is damaged. 2 Check battery capacity. 3 Check the USB2 interface and FICM harness plug for damage, poor contact, aging, and looseness. 4 Check whether the result is normal or not?
	NO → Repair or replace the faulted parts.
YES ↓	
Steps2	Check fault codes.
	<ol style="list-style-type: none"> 1 Connect the fault diagnosis instrument to the diagnosis interface. 2 Turn the ignition switch to ON position. 3 Diagnose the FICM with diagnostic apparatus. 4 If there is any fault code except for B1A26-01?
	YES → Refer to: DTC Summary List (FICM) - left .
NO ↓	
Steps3	Check the power supply circuit of the USB2 interface circuit.
	<ol style="list-style-type: none"> 1 Turn the ignition switch to OFF. 2 Disconnect the USB2 interface harness plug IP47-02. 3 Turn on the ignition. 4 Measure the voltage between the USB2 interface harness terminal and ground. Measuring circuit: The voltage between terminal 1 of IP47-02 plug and the grounding. Standard value: 4.8~5.2V 5 Check whether the result is normal or not?
	NO → Repair or replace the faulted parts.
YES ↓	

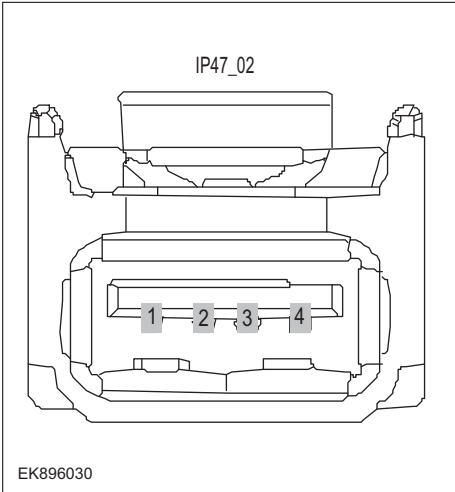
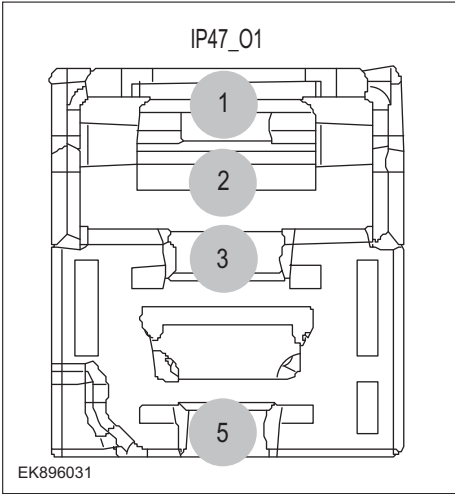
<p>Steps4</p>	<p>Check the USB2 interface circuit (open circuit).</p>
<div style="text-align: center;">  <p>IP47_02</p> <p>EK896030</p> </div> <div style="text-align: center; margin-top: 20px;">  <p>IP47_01</p> <p>EK896031</p> </div>	<ol style="list-style-type: none"> 1 Turn the ignition switch to OFF. 2 Disconnect the FICM harness plug IP47-O1. 3 Measure the resistance between the USB2 interface harness terminal and the FICM harness terminal. <ul style="list-style-type: none"> Measuring circuit: The resistance between terminal 1 of IP47-O2 plug and terminal 1 of IP47-O1 plug. Measuring circuit: The resistance between terminal 2 of IP47-O2 plug and terminal 2 of IP47-O1 plug. Measuring circuit: The resistance between terminal 3 of IP47-O2 plug and terminal 3 of IP47-O1 plug. Measuring circuit: The resistance between terminal 4 of IP47-O2 plug and terminal 5 of IP47-O1 plug. 4 Check whether the result is normal or not?
	<p>NO → Repair or replace the faulted parts.</p>
<p>YES ↓</p>	

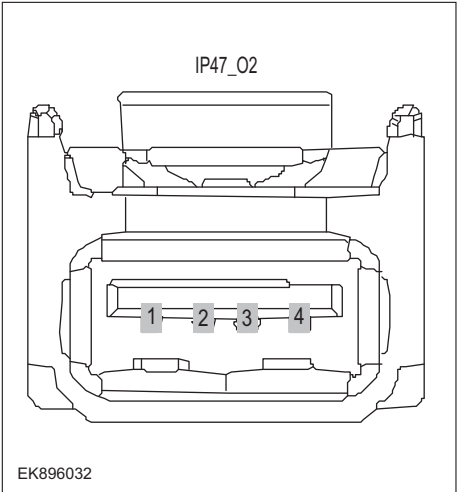
Steps5	Check the USB2 interface circuit (short circuit).
 <p>IP47_O2</p> <p>EK896032</p>	<ol style="list-style-type: none"> 1 Turn the ignition switch to OFF. 2 Measure the resistance between the USB2 interface harness plug and ground. <ul style="list-style-type: none"> Measuring circuit: The resistance between terminal 1 of IP47-O2 plug and the grounding. Measuring circuit: The resistance between terminal 2 of IP47-O2 plug and the grounding. Measuring circuit: The resistance between terminal 3 of IP47-O2 plug and the grounding. Measuring circuit: The resistance between terminal 4 of IP47-O2 plug and the grounding. <p>Standard value: infinity</p> 3 Measure the voltage between the USB1 interface harness plug and ground. <ul style="list-style-type: none"> Measuring circuit: The voltage between terminal 1 of IP47-O2 plug and the grounding. Measuring circuit: The voltage between terminal 2 of IP47-O2 plug and the grounding. Measuring circuit: The voltage between terminal 3 of IP47-O2 plug and the grounding. Measuring circuit: The voltage between terminal 4 of IP47-O2 plug and the grounding. <p>Standard value: ≈ 0V</p> 4 Check whether the result is normal or not?
NO → Repair or replace the faulted parts.	
YES ↓	
Steps6	Check the USB2 interface (component inspection).

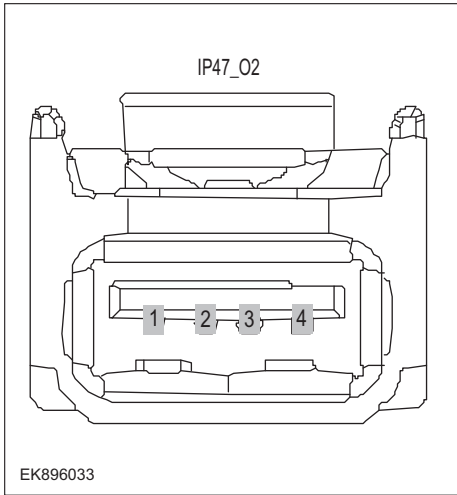
 <p style="text-align: center;">IP47_O2</p> <p style="text-align: center;">EK896033</p>	<ol style="list-style-type: none"> 1 Measure the resistance of the USB2 interface terminal directly. Measuring circuit: The resistance between terminal 2 and terminal 3 of IP47-O2 plug. Standard value: 2 Measure the resistance between the USB2 interface harness plug and ground. Measuring circuit: The resistance between terminal 1 of IP47-O2 plug and the housing. Measuring circuit: The resistance between terminal 2 of IP47-O2 plug and the housing. Measuring circuit: The resistance between terminal 3 of IP47-O2 plug and the housing. Measuring circuit: The resistance between terminal 4 of IP47-O2 plug and the housing. Standard value: infinity 3 Check whether the result is normal or not?
	<p>NO → Replace the USB2 interface.</p>
<p>YES ↓</p>	

FICM

Steps7	Test whether FICM is norm.
	<ol style="list-style-type: none"> 1 Turn the ignition switch to OFF. 2 Disconnect and check the FICM harness plug IP43_ A, IP43_ B. 3 Check and repair. <ul style="list-style-type: none"> • Corrosion(install new adapting piece or terminal-cleaning module and pin). • Pin damaged or bent-install new terminal/pin. • Fly out of pins-install new pins as needed. 4 Reconnect the FICM plug and all other previously disconnected plug. Make sure the pin is properly positioned and fixed. 5 Run the system and determine if the problem persists?
	YES → Change the FICM Module
NO ↓	
At this point the system is functioning normally. The problem may be caused by module connections. Address the root cause of any connector or pin problems.	
Next Step ↓	
Diagnosis end.	

B1A25-12、 B1A25-11、 B1A25-13、 B1A28-12、 B1A28-11、 B1A28-13

Fault diagnosis code
B1A25-12: MIC1 short to Battery
B1A25-11: MIC1 short to GND
B1A25-13: MIC1 circuit open
B1A28-12: MIC2 short to Battery
B1A28-11: MIC2 short to GND
B1A28-13: MIC2 circuit open
Detection tools
1 Multimeter and diagnostic apparatus
Possible causes
<ul style="list-style-type: none"> • Circuit,terminal and adapting piece • FICM • Microphone malfunction
Conditions for fault code operation
Turn the ignition switch to the ON position
Conditions for fault code setting
B1A25-12
B1A25-11
B1A25-13
B1A28-12
B1A28-11
B1A28-13
To set the effect of a fault code condition
1
2
Description of circuit diagram
FICM monitors the microphone through low-level reference and signal circuits.

Circuit diagram

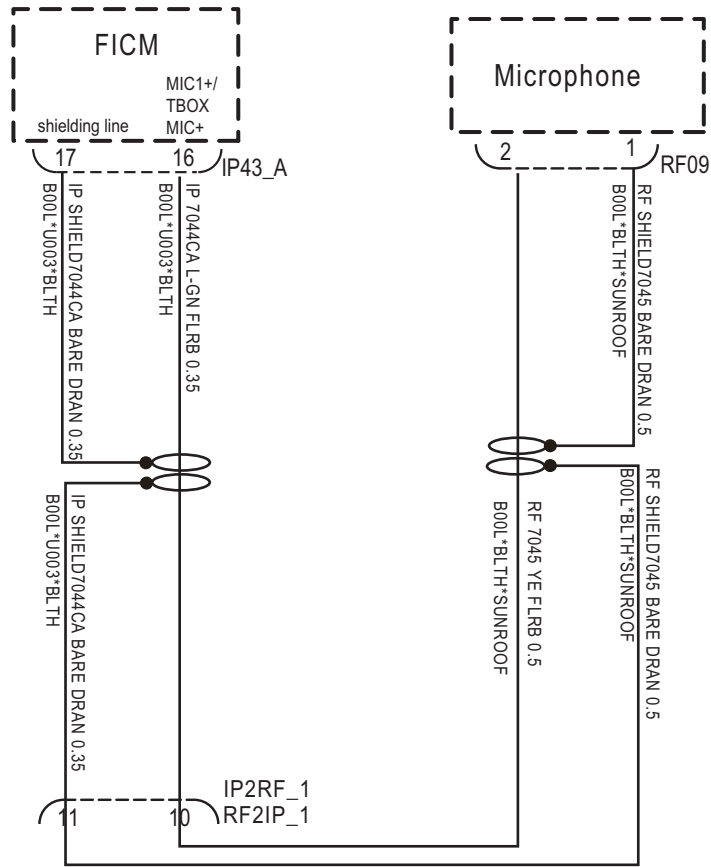

IP43_A

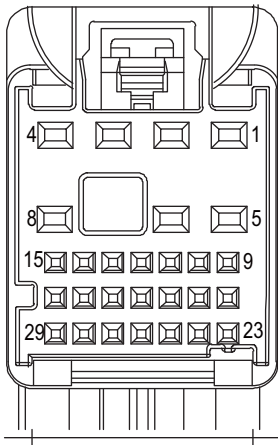

RF09

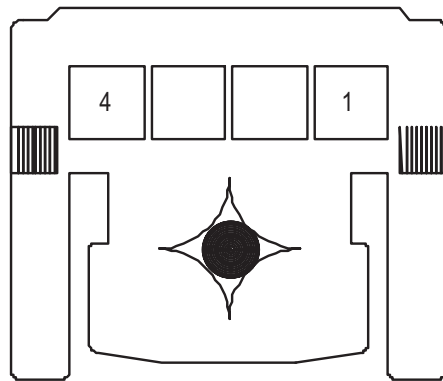

EK896034

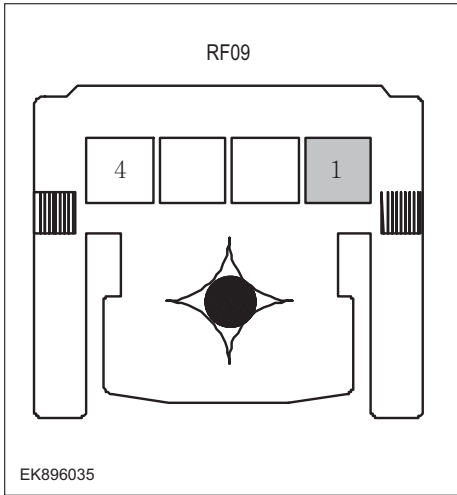
Troubleshooting steps	
Steps1	General inspection.
	<ol style="list-style-type: none"> 1 Check if the Insurance fuse is damaged. 2 Check battery capacity. 3 Check the microphone and FICM harness plugs for damage, poor contact, aging, and looseness. 4 Check whether the result is normal or not?
	NO → Repair or replace the faulted parts.
YES ↓	
Steps2	Check fault codes.
	<ol style="list-style-type: none"> 1 Connect the fault diagnosis instrument to the diagnosis interface. 2 Turn the ignition switch to ON position. 3 Diagnose the FICM with diagnostic apparatus. 4 If there is any fault code except for B1A25-12、 B1A25-11、 B1A25-13、 B1A28-12、 B1A28-11、 B1A28-13?
	YES → Refer to: DTC Summary List (FICM) - left .
NO ↓	
Steps3	Check the power supply circuit of the microphone circuit.
	<ol style="list-style-type: none"> 1 Turn the ignition switch to OFF. 2 Disconnect the microphone harness plug RF09. 3 Turn on the ignition. 4 Measure the voltage between the microphone harness terminal and ground. Measuring circuit: The voltage between terminal 1 of RF09 plug and the grounding. Standard value: 4.8~5.2V 5 Check whether the result is normal or not?
	NO → Repair or replace the faulted parts.
YES ↓	

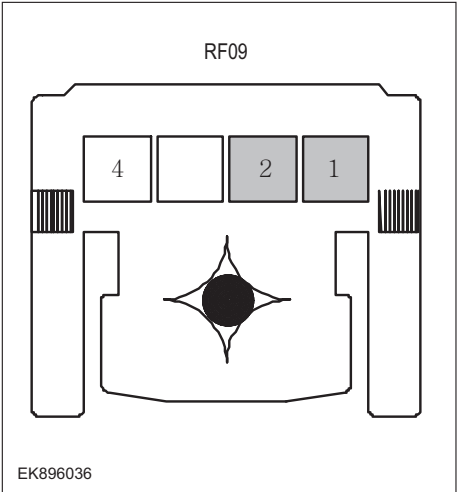
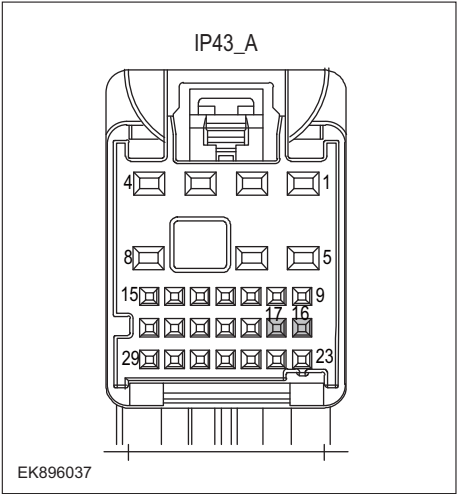
Steps4	Check the microphone circuit (open circuit).
<div style="text-align: center;">  <p>RF09</p> <p>EK896036</p> </div> <div style="text-align: center; margin-top: 20px;">  <p>IP43_A</p> <p>EK896037</p> </div>	<ol style="list-style-type: none"> 1 Turn the ignition switch to OFF. 2 Disconnect the FICM harness plug IP43_A. 3 Measure the resistance between the microphone harness terminal and the FICM harness terminal. Measuring circuit: The resistance between terminal 1 of RF09 plug and terminal 16 of IP43-A plug. Measuring circuit: The resistance between terminal 2 of RF09 plug and terminal 17 of IP43-A plug. 4 Check whether the result is normal or not?
	<p>NO → Repair or replace the faulted parts.</p>
<p>YES ↓</p>	

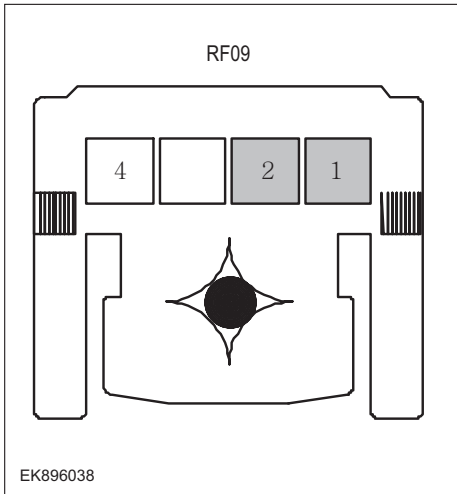
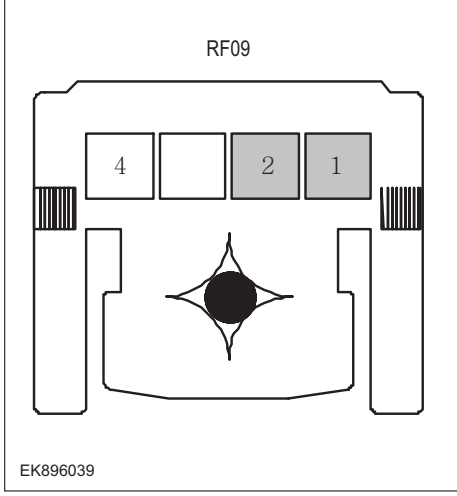
Steps5	Check the microphone circuit (short circuit).
	<ol style="list-style-type: none"> 1 Turn the ignition switch to OFF. 2 Measure the resistance between the microphone harness plug and ground. Measuring circuit: The resistance between terminal 1 of RF09 plug and the grounding. Measuring circuit: The resistance between terminal 2 of RF09 plug and the grounding. Standard value: infinity 3 Measure the voltage between the microphone harness plug and ground. Measuring circuit: The voltage between terminal 1 of RF09 plug and the grounding. Measuring circuit: The voltage between terminal 2 of RF09 plug and the grounding. Standard value: ≈ 0V 4 Check whether the result is normal or not?
NO → Repair or replace the faulted parts.	
YES ↓	
Steps6	Check the microphone (component inspection).
	<ol style="list-style-type: none"> 1 Measure the resistance of the microphone terminals directly. Measuring circuit: The resistance between terminal 1 and terminal 2 of RF09 plug. Standard value: 2 Measure the resistance between the microphone harness plug and ground. Measuring circuit: The resistance between terminal 1 of RF09 plug and the housing. Measuring circuit: The resistance between terminal 2 of RF09 plug and the housing. Standard value: infinity 3 Check whether the result is normal or not?
NO → Replace the microphone.	
YES ↓	

FICM

Steps7	Test whether FICM is norm.
	<ol style="list-style-type: none"> 1 Turn the ignition switch to OFF. 2 Disconnect and check the FICM harness plug IP43_ A, IP43_ B. 3 Check and repair. <ul style="list-style-type: none"> • Corrosion(install new adapting piece or terminal-cleaning module and pin). • Pin damaged or bent-install new terminal/pin. • Fly out of pins-install new pins as needed. 4 Reconnect the FICM plug and all other previously disconnected plug. Make sure the pin is properly positioned and fixed. 5 Run the system and determine if the problem persists?
	YES → Change the FICM Module
NO ↓	
At this point the system is functioning normally. The problem may be caused by module connections. Address the root cause of any connector or pin problems.	
Next Step ↓	
Diagnosis end.	

B1A4E-71、 B1A50-11、 B1A4C-71、 B1A4D-71 、 B1A39-71、 B1A3A-71

Fault diagnosis code
B1A4E-71: Music or 360 Switch-faceplate stuck
B1A50-11: Separate Infotainment Faceplate short to Ground
B1A4C-71: Car Switch-faceplate stuck
B1A4D-71: Music Switch-faceplate stuck
B1A39-71: Volume Up Switch-faceplate stuck
B1A3A-71: Volume Down Switch-faceplate stuck
Detection tools
1 Multimeter and diagnostic apparatus
Possible causes
<ul style="list-style-type: none"> • Circuit,terminal and adapting piece • Battery • FICM • Charging system • Insurance fuse
Conditions for fault code operation
Turn the ignition switch to the ON position
Conditions for fault code setting
B1A4E-71
B1A50-11
B1A4C-71
B1A4D-71
B1A39-71
B1A3A-71
To set the effect of a fault code condition
Description of circuit diagram

FICM

The FICM will monitor whether all sensors and actuators are within normal range all the time. Meanwhile, it will check the connector for virtual connection, short circuit, open circuit and the connection rationality with other signals. When fault occurs, the FICM module will save the fault code corresponding to that fault and enable safety mode.

Circuit diagram

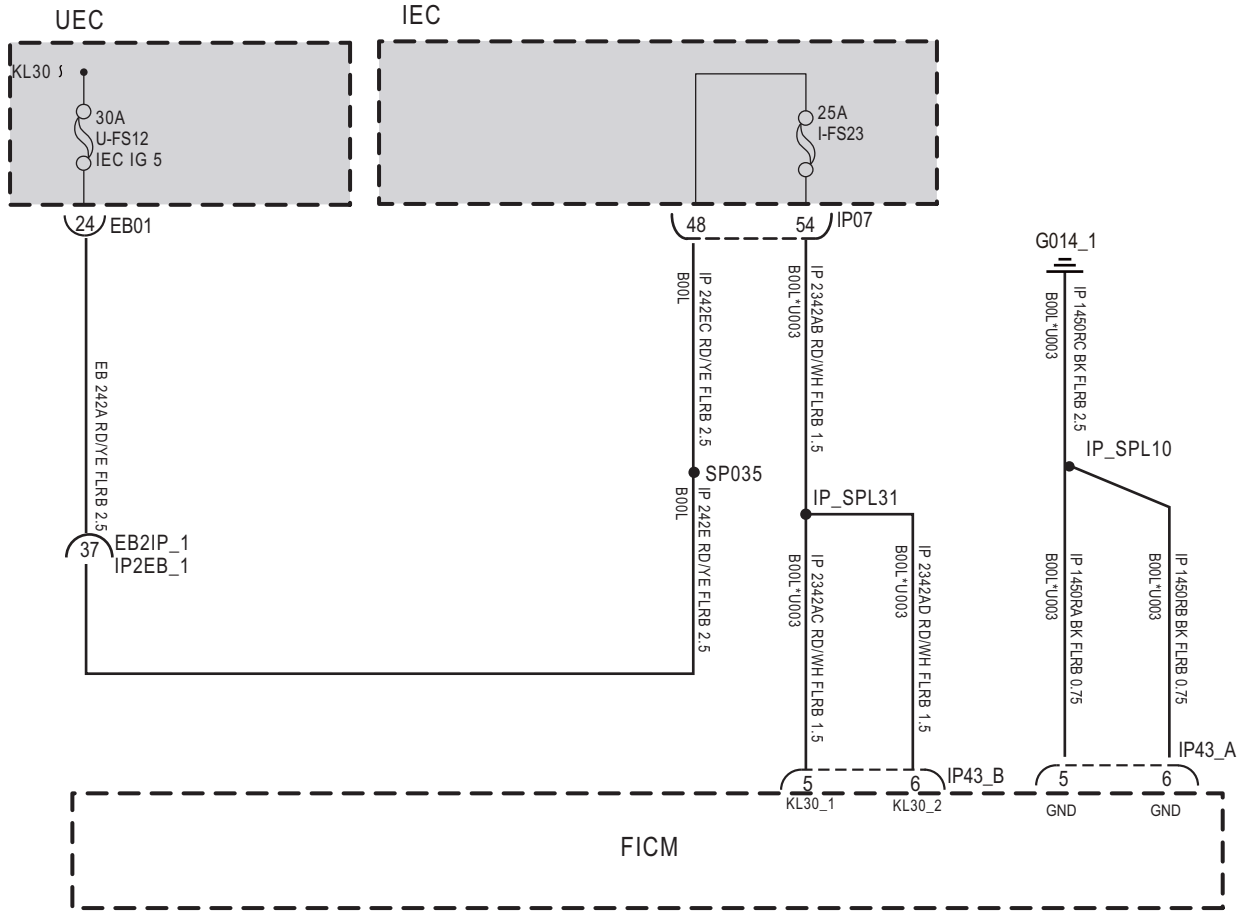

IP43_A

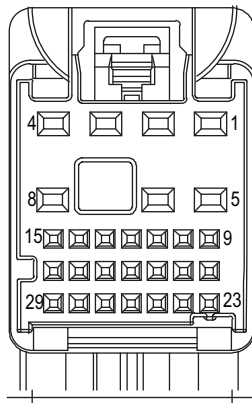

IP43_B

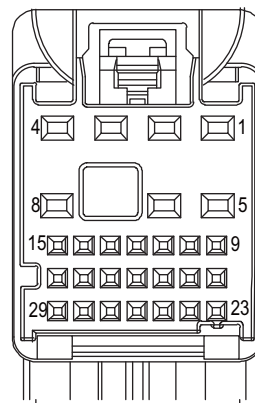

EK896001

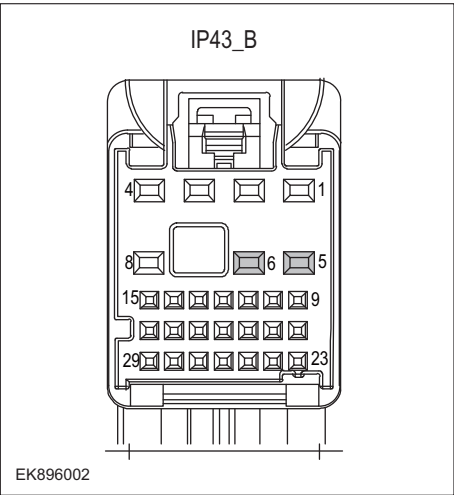
Troubleshooting steps	
Steps1	General inspection.
	<ol style="list-style-type: none"> 1 Check fusesU-FS12、 I-FS23 for damage. 2 Check battery capacity. 3 Check the harness plug of FICM for damage, poor contact, aging and looseness. 4 Check whether the result is normal or not?
	NO → Repair or replace the faulted parts.
YES ↓	
Steps2	Check fault codes.
	<ol style="list-style-type: none"> 1 Connect the fault diagnosis instrument to the diagnosis interface. 2 Turn the ignition switch to ON position. 3 Diagnose the FICM with diagnostic apparatus. 4 If there is any fault code except for B1A4E-71、 B1A50-11、 B1A4C-71、 B1A4D-71 、 B1A39-71、 B1A3A-71?
	YES → Refer to: DTC Summary List (FICM) - left .
NO ↓	
Steps3	Check the FICMBattery power supply voltage.
	<ol style="list-style-type: none"> 1 Turn the ignition switch to OFF. 2 Disconnect the harness plug IP43_B of FICM module.5 3 Measure the voltage between the FICM harness terminal and ground. Measuring circuit: IP43_ The voltage between terminal 5 of plug B and the grounding. Measuring circuit: IP43_ The voltage between terminal 6 of plug B and the grounding. Standard value:10~14V 4 Check whether the result is normal or not?
	NO → Repair or replace the faulted parts.
YES ↓	

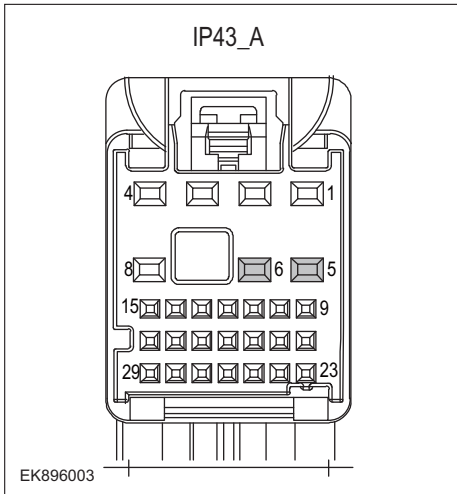
Steps4	Check the power voltage when the FICM is started or operating
	<ol style="list-style-type: none"> 1 Turn the ignition switch to OFF. 2 Disconnect the FICM harness plug IP43_ A. 3 Measure the resistance between the FICM harness plug and ground. Measuring circuit: IP43_ The resistance between terminal 5 of plug A and the grounding. Measuring circuit: IP43_ The resistance between terminal 6 of plug A and the grounding. Standard value: < 1Ω 4 Test whether the resistance is less than 1Ω?
NO → Repair or replace the faulted parts.	
YES ↓	
Steps5	Test whether FICM is norm.
	<ol style="list-style-type: none"> 1 Turn the ignition switch to OFF. 2 Disconnect and check the FICM harness plug IP43_ A, IP43_ B. 3 Check and repair. <ul style="list-style-type: none"> • Corrosion(install new adapting piece or terminal-cleaning module and pin). • Pin damaged or bent-install new terminal/pin. 4 Fly out of pins-install new pins as needed. 5 Reconnect the FICM plug and all other previously disconnected plug. Make sure the pin is properly positioned and fixed. 6 Run the system and determine if the problem persists?
YES → Change the FICM Module	
NO ↓	
At this point the system is functioning normally. The problem may be caused by module connections. Address the root cause of any connector or pin problems.	
Next Step ↓	
Diagnosis end.	

FICM

B1AA0-12、 B1AA0-11、 B1A50-15

Fault diagnosis code
B1AA0-12: Infotainment Faceplate Enable Circuit Short to Battery
B1AA0-11: Infotainment Faceplate Enable Circuit Short to Ground
B1A50-15: Separate Infotainment Faceplate short to Battery or Open
Detection tools
1 Multimeter and diagnostic apparatus
Possible causes
<ul style="list-style-type: none">• Circuit,terminal and adapting piece• FICM• Infotainment panel malfunction
Conditions for fault code operation
Turn the ignition switch to the ON position
Conditions for fault code setting
B1AA0-12
B1AA0-11
B1A50-15
To set the effect of a fault code condition
1
2
Description of circuit diagram
FICM monitors the infotainment panel through low-level reference and signal circuits.

Circuit diagram

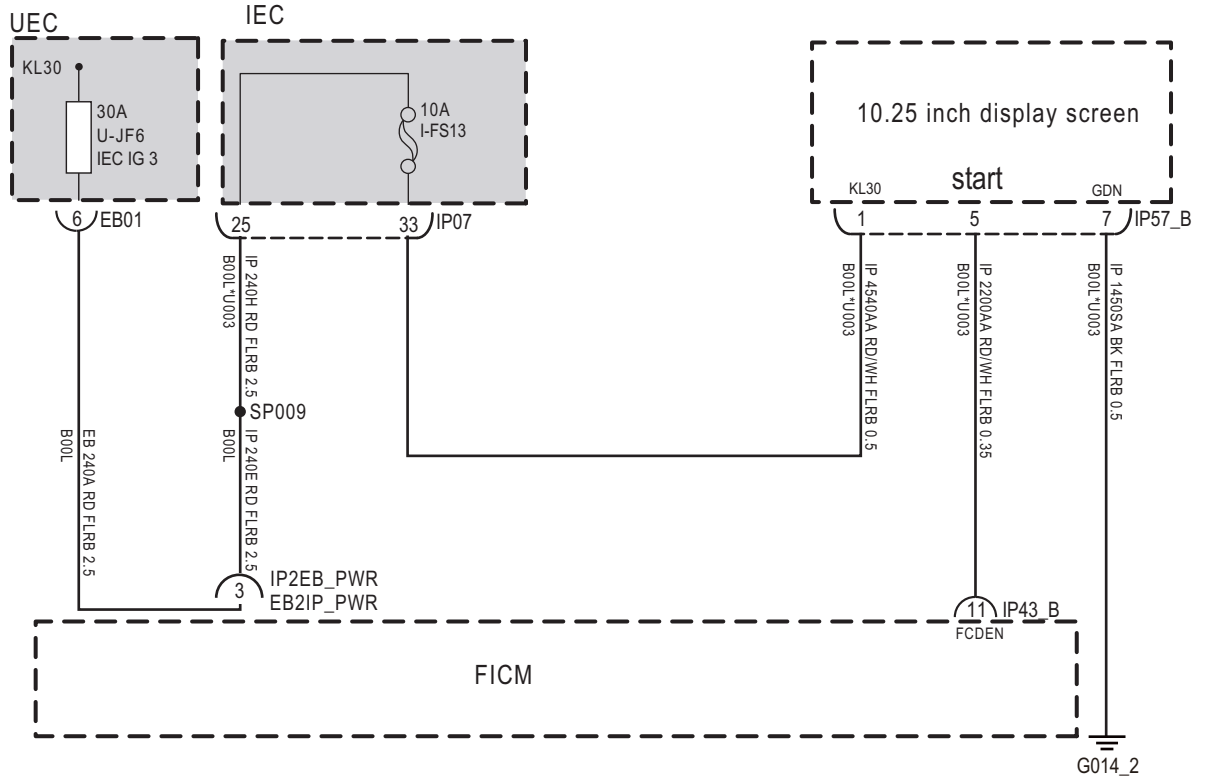

IP43_B

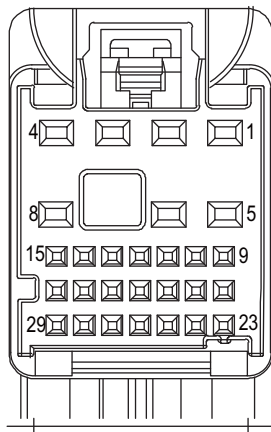

IP57_B

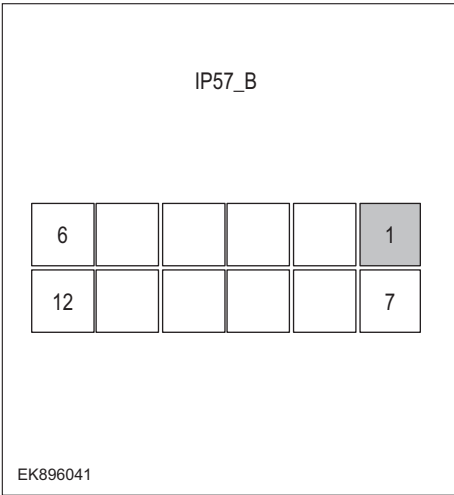

EK896040

Troubleshooting steps											
Steps1	General inspection.										
	<ol style="list-style-type: none"> 1 Check if the Insurance fuse is damaged. 2 Check battery capacity. 3 Check the infotainment panel and FICM harness plugs for damage, poor contact, aging, and looseness. 4 Check whether the result is normal or not? 										
NO → Repair or replace the faulted parts.											
YES ↓											
Steps2	Check fault codes.										
	<ol style="list-style-type: none"> 1 Connect the fault diagnosis instrument to the diagnosis interface. 2 Turn the ignition switch to ON position. 3 Diagnose the FICM with diagnostic apparatus. 4 If there is any fault code except for B1AA0-12、 B1AA0-11、 B1A50-15? 										
YES → Refer to: DTC Summary List (FICM) - left .											
NO ↓											
Steps3	Check the power supply circuit of the display screen circuit.										
 <p style="text-align: center;">IP57_B</p> <table border="1" style="margin-left: auto; margin-right: auto;"> <tr> <td>6</td> <td></td> <td></td> <td></td> <td style="background-color: #cccccc;">1</td> </tr> <tr> <td>12</td> <td></td> <td></td> <td></td> <td>7</td> </tr> </table> <p>EK896041</p>	6				1	12				7	<ol style="list-style-type: none"> 1 Turn the ignition switch to OFF. 2 Disconnect the display screen harness plug IP57_ B. 3 Turn on the ignition. 4 Measure the voltage between the microphone harness terminal and ground. Measuring circuit: IP57_ The voltage between terminal 1 of plug B and the grounding. Standard value: 4.8~5.2V 5 Check whether the result is normal or not?
6				1							
12				7							
NO → Repair or replace the faulted parts.											
YES ↓											

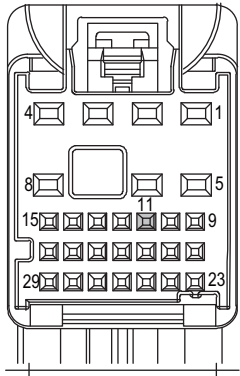
Steps4	Check the display circuit (open circuit).												
<div style="text-align: center;">IP57_B</div> <table border="1" style="margin: auto;"> <tr> <td style="width: 20px; height: 20px;">6</td> <td style="width: 20px; height: 20px; background-color: #cccccc;">5</td> <td style="width: 20px; height: 20px;"></td> <td style="width: 20px; height: 20px;"></td> <td style="width: 20px; height: 20px;"></td> <td style="width: 20px; height: 20px;">1</td> </tr> <tr> <td style="width: 20px; height: 20px;">12</td> <td style="width: 20px; height: 20px;"></td> <td style="width: 20px; height: 20px;"></td> <td style="width: 20px; height: 20px;"></td> <td style="width: 20px; height: 20px;"></td> <td style="width: 20px; height: 20px;">7</td> </tr> </table> <p style="font-size: small; margin-top: 10px;">EK896042</p> <div style="text-align: center;">IP43_B</div>  <p style="font-size: small; margin-top: 10px;">EK896043</p>	6	5				1	12					7	<ol style="list-style-type: none"> 1 Turn the ignition switch to OFF. 2 Disconnect the FICM harness plug IP43-B. 3 Measure the resistance between the display screen harness terminal and the FICM harness terminal. Measuring circuit: IP57_ The resistance between terminal 5 of plug B and terminal 11 of plug IP43-B. 4 Check whether the result is normal or not?
6	5				1								
12					7								
<p>NO → Repair or replace the faulted parts.</p>													
<p>YES ↓</p>													

Steps5	Check the display circuit (short circuit).												
<div style="border: 1px solid black; padding: 10px; text-align: center;"> <p>IP57_B</p> <table border="1" style="margin: auto;"> <tr> <td style="width: 20px; height: 20px;">6</td> <td style="width: 20px; height: 20px; background-color: #cccccc;">5</td> <td style="width: 20px; height: 20px;"></td> <td style="width: 20px; height: 20px;"></td> <td style="width: 20px; height: 20px;"></td> <td style="width: 20px; height: 20px; background-color: #cccccc;">1</td> </tr> <tr> <td style="width: 20px; height: 20px;">12</td> <td style="width: 20px; height: 20px;"></td> <td style="width: 20px; height: 20px;"></td> <td style="width: 20px; height: 20px;"></td> <td style="width: 20px; height: 20px;"></td> <td style="width: 20px; height: 20px; background-color: #cccccc;">7</td> </tr> </table> <p style="font-size: small; margin-top: 10px;">EK896044</p> </div>	6	5				1	12					7	<ol style="list-style-type: none"> 1 Turn the ignition switch to OFF. 2 Measure the resistance between the display screen harness plug and ground. Measuring circuit: IP57_ The resistance between terminal 1 of plug B and the grounding. Measuring circuit: IP57_ The resistance between terminal 5 of plug B and the grounding. Measuring circuit: IP57_ The resistance between terminal 7 of plug B and the grounding. Standard value: infinity 3 Measure the voltage between the display screen harness plug and ground. Measuring circuit: IP57_ The voltage between terminal 1 of plug B and the grounding. Measuring circuit: IP57_ The voltage between terminal 5 of plug B and the grounding. Measuring circuit: IP57_ The voltage between terminal 7 of plug B and the grounding. Standard value: ≈ 0V 4 Check whether the result is normal or not?
6	5				1								
12					7								
NO → Repair or replace the faulted parts.													
YES ↓													
Steps6	Check the display screen circuit for an open ground.												
<div style="border: 1px solid black; padding: 10px; text-align: center;"> <p>IP57_B</p> <table border="1" style="margin: auto;"> <tr> <td style="width: 20px; height: 20px;">6</td> <td style="width: 20px; height: 20px;">5</td> <td style="width: 20px; height: 20px;"></td> <td style="width: 20px; height: 20px;"></td> <td style="width: 20px; height: 20px;"></td> <td style="width: 20px; height: 20px;">1</td> </tr> <tr> <td style="width: 20px; height: 20px;">12</td> <td style="width: 20px; height: 20px;"></td> <td style="width: 20px; height: 20px;"></td> <td style="width: 20px; height: 20px;"></td> <td style="width: 20px; height: 20px;"></td> <td style="width: 20px; height: 20px; background-color: #cccccc;">7</td> </tr> </table> <p style="font-size: small; margin-top: 10px;">EK896045</p> </div>	6	5				1	12					7	<ol style="list-style-type: none"> 1 Turn the ignition switch to OFF. 2 Disconnect the display screen harness plug IP57_ B. 3 Measure the resistance between the display screen harness plug and ground. Measuring circuit: IP57_ The resistance between terminal 7 of plug B and the grounding. Standard value: < 1Ω 4 Is the resistance less than 1 Ω
6	5				1								
12					7								
NO → Repair or replace the faulted parts.													
YES ↓													

Steps7	Test whether FICM is norm.
	<ol style="list-style-type: none"> 1 Turn the ignition switch to OFF. 2 Disconnect and check the FICM harness plug IP43_ A, IP43_ B. 3 Check and repair. <ul style="list-style-type: none"> • Corrosion(install new adapting piece or terminal-cleaning module and pin). • Pin damaged or bent-install new terminal/pin. • Fly out of pins-install new pins as needed. 4 Reconnect the FICM plug and all other previously disconnected plug. Make sure the pin is properly positioned and fixed. 5 Run the system and determine if the problem persists?
	YES → Change the FICM Module
NO ↓	
At this point the system is functioning normally. The problem may be caused by module connections. Address the root cause of any connector or pin problems.	
Next Step ↓	
Diagnosis end.	

FICM

B1A3E-71, B1A3F-71, B1A01-71, B1A02-71, B1A05-71, B1A06-71, B1A07-71, B1A08-71, B1A4B-71

Fault diagnosis code
B1A3E-71: Seek Up Switch-SWC stuck
B1A01-71: Call/RejectSwitch-SWCstuck
B1A02-71: MuteSwitch-SWCstuck
B1A05-71: VolumeUpSwitch-SWCstuck
B1A06-71: VolumeDownSwitch-SWCstuck
B1A07-71: SourceSwitch-SWCstuck
B1A08-71: VoiceSwitch-SWCstuck
B1A4B-71: CustomSwitch-SWCstuck
B1A3F-71: SeekDownSwitch-SWCstuck
Detection tools
1 Multimeter and diagnostic apparatus
Possible causes
<ul style="list-style-type: none">• Circuit,terminal and adapting piece• FICM• Clock spring failure
Conditions for fault code operation
Turn the ignition switch to the ON position
Conditions for fault code setting
B1A3E-71
B1A3F-71
B1A01-71
B1A02-71
B1A05-71
B1A06-71
B1A07-71
B1A08-71

B1A4B-71
To set the effect of a fault code condition
1
2
Description of circuit diagram
FICM monitors the USB interface through low-level reference and signal circuits.

Circuit diagram

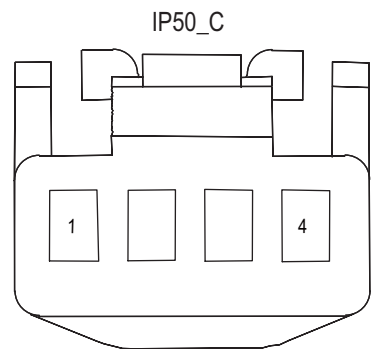
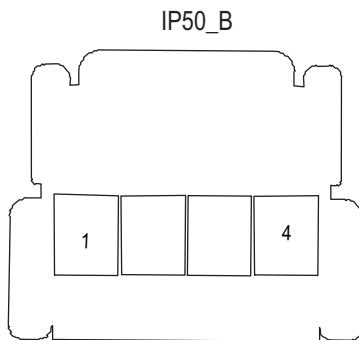
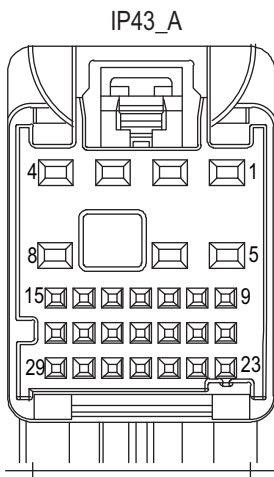
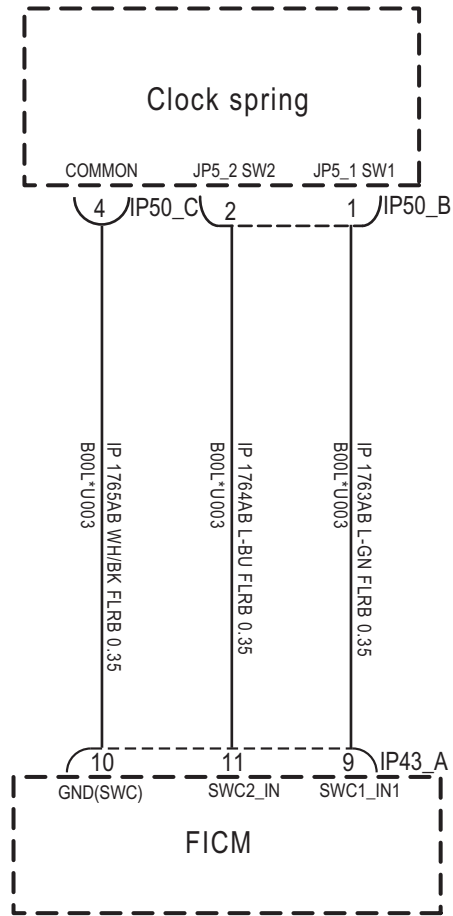

EK896046

Troubleshooting steps	
Steps1	General inspection.
	<ol style="list-style-type: none"> 1 Check if the Insurance fuse is damaged. 2 Check battery capacity. 3 Check the clock spring and FICM harness plug for damage, poor contact, aging, and looseness. 4 Check whether the result is normal or not?
	NO → Repair or replace the faulted parts.
YES ↓	
Steps2	Check fault codes.
	<ol style="list-style-type: none"> 1 Connect the fault diagnosis instrument to the diagnosis interface. 2 Turn the ignition switch to ON position. 3 Diagnose the FICM with diagnostic apparatus. 4 If there is any fault code except for B1A3E-71、 B1A3F-71、 B1A01-71、 B1A02-71、 B1A05-71、 B1A06-71、 B1A07-71、 B1A08-71、 B1A4B-71?
	YES → Refer to: DTC Summary List (FICM) - left .
NO ↓	

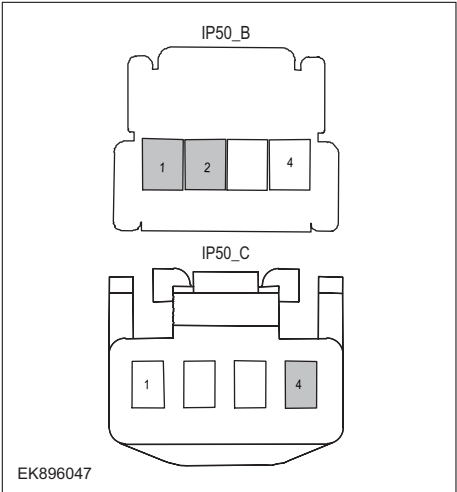
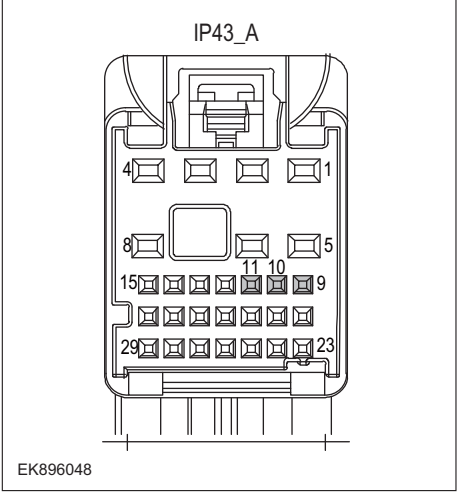
Steps3	Check the clock spring circuit (open circuit).
<div style="text-align: center;">  <p>EK896047</p> </div> <div style="text-align: center; margin-top: 20px;">  <p>EK896048</p> </div>	<ol style="list-style-type: none"> 1 Turn the ignition switch to OFF. 2 Disconnect the FICM harness plug IP43_ A. 3 Measure the resistance between the clock spring harness terminal and the FICM harness terminal. <ul style="list-style-type: none"> Measuring circuit: IP50-B plug terminal 1 and IP43_ The resistance between terminal 9 of plug A. Measuring circuit: IP50-B plug terminal 2 and IP43_ The resistance between terminal 11 of plug A. Measuring circuit: IP50-C plug terminal 4 and IP43_ The resistance between terminal 10 of plug A. 4 Check whether the result is normal or not?
	<p>NO → Repair or replace the faulted parts.</p>
<p>YES ↓</p>	

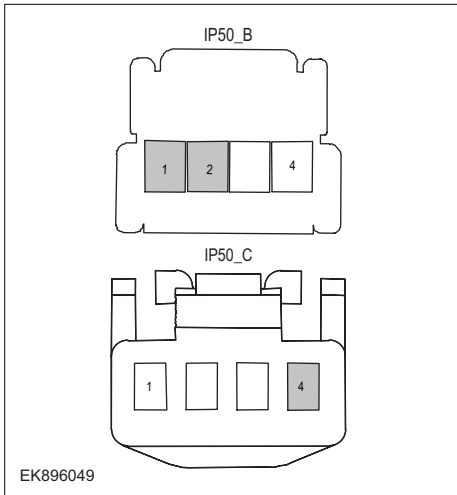
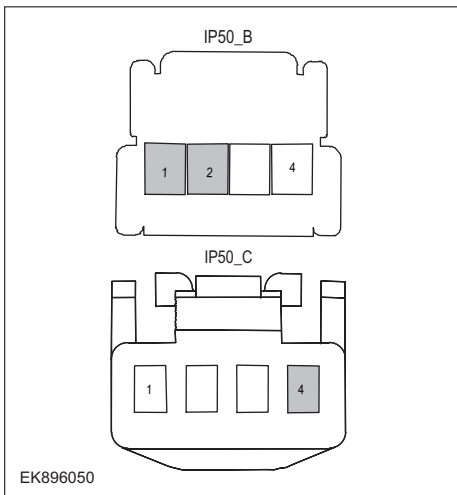
Steps4	Check the clock spring circuit (short circuit).
	<ol style="list-style-type: none"> 1 Turn the ignition switch to OFF. 2 Measure the resistance between the clock spring harness plug and ground. Measuring circuit: The resistance between terminal 1 of IP50-B plug and the grounding. Measuring circuit: The resistance between terminal 2 of IP50-B plug and the grounding. Measuring circuit: The resistance between terminal 4 of IP50-C plug and the grounding. Standard value: infinity 3 Measure the voltage between the clock spring harness plug and ground. Measuring circuit: The voltage between terminal 1 of IP50-B plug and the grounding. Measuring circuit: The voltage between terminal 2 of IP50-B plug and the grounding. Measuring circuit: The voltage between terminal 4 of IP50-C plug and the grounding. Standard value: ≈ 0V 4 Check whether the result is normal or not?
NO → Repair or replace the faulted parts.	
YES ↓	
Steps6	Check the clock spring (component inspection).
	<ol style="list-style-type: none"> 1 Measure the resistance of the clock spring terminal directly. Measuring circuit: The resistance between terminal 1 and terminal 2 of IP50-B plug. Standard value: 2 Measure the resistance between the clock spring harness plug and ground. Measuring circuit: The resistance between terminal 1 of IP50-B plug and the housing. Measuring circuit: The resistance between terminal 2 of IP50-B plug and the housing. Measuring circuit: The resistance between terminal 4 of IP50-C plug and the housing. Standard value: infinity 3 Check whether the result is normal or not?
NO → Replace the clock spring.	
YES ↓	

FICM

Steps7	Test whether FICM is norm.
	<ol style="list-style-type: none"> 1 Turn the ignition switch to OFF. 2 Disconnect and check the FICM harness plug IP43_ A, IP43_ B. 3 Check and repair. <ul style="list-style-type: none"> • Corrosion(install new adapting piece or terminal-cleaning module and pin). • Pin damaged or bent-install new terminal/pin. • Fly out of pins-install new pins as needed. 4 Reconnect the FICM plug and all other previously disconnected plug. Make sure the pin is properly positioned and fixed. 5 Run the system and determine if the problem persists?
	YES → Change the FICM Module
NO ↓	
At this point the system is functioning normally. The problem may be caused by module connections. Address the root cause of any connector or pin problems.	
Next Step ↓	
Diagnosis end.	

B1AE4-12、 B1AE9-12、 B1AE9-11

Fault diagnosis code
B1AE4-12: RearcameraVideoSignalCircuitShorttoBattery
B1AE9-12: CameraPowershorttobattery
B1AE9-11: CameraPowershorttoGND
Detection tools
1 Multimeter and diagnostic apparatus
Possible causes
<ul style="list-style-type: none"> • Circuit,terminal and adapting piece • FICM • Camera malfunction
Conditions for fault code operation
Turn the ignition switch to the ON position
Conditions for fault code setting
B1AE4-12
B1AE9-12
B1AE9-11
To set the effect of a fault code condition
1
2
Description of circuit diagram
FICM monitors the USB interface through low-level reference and signal circuits.

Circuit diagram

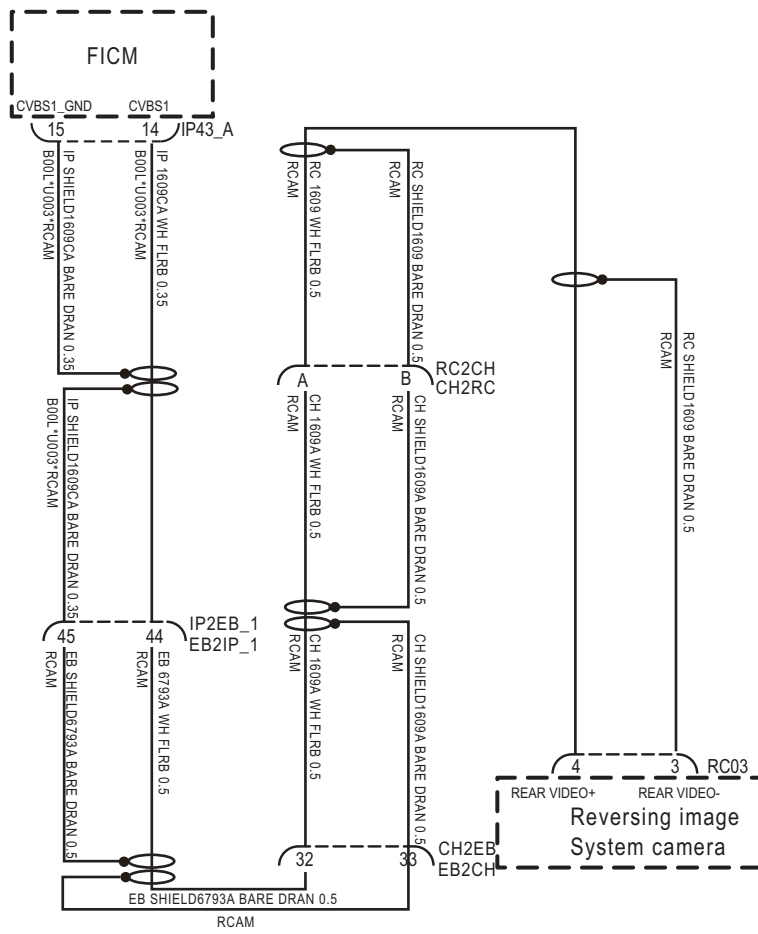

IP43_A

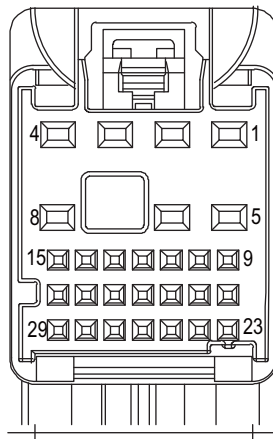

EK896051

Troubleshooting steps	
Steps1	General inspection.
	<ol style="list-style-type: none"> 1 Check if the Insurance fuse is damaged. 2 Check battery capacity. 3 Check the camera and FICM harness plugs for damage, poor contact, aging, and looseness. 4 Check whether the result is normal or not?
	NO → Repair or replace the faulted parts.
YES ↓	
Steps2	Check fault codes.
	<ol style="list-style-type: none"> 1 Connect the fault diagnosis instrument to the diagnosis interface. 2 Turn the ignition switch to ON position. 3 Diagnose the FICM with diagnostic apparatus. 4 If there is any fault code except for B1AE4-12、 B1AE9-12、 B1AE9-11?
	YES → Refer to: DTC Summary List (FICM) - left .
NO ↓	
Steps3	Check the power supply circuit of the camera circuit.
	<ol style="list-style-type: none"> 1 Turn the ignition switch to OFF. 2 Disconnect the camera harness plug RC03. 3 Turn on the ignition. 4 Measure the voltage between the camera harness terminal and ground. Measuring circuit: voltage between terminal 4 of RC03 plug and ground . Standard value: 4.8~5.2V 5 Check whether the result is normal or not?
	NO → Repair or replace the faulted parts.
YES ↓	

FICM

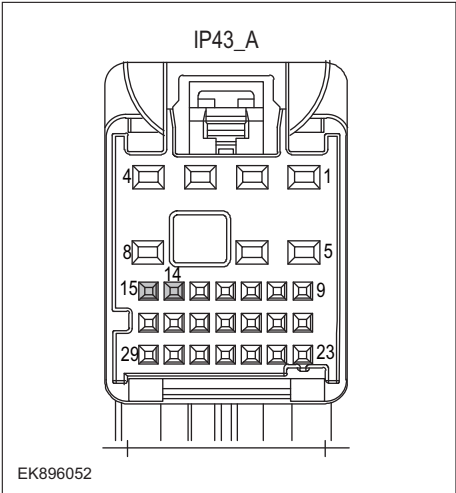
Steps4	Check the camera circuit (open circuit).
 <p>IP43_A</p> <p>EK896052</p>	<ol style="list-style-type: none">1 Turn the ignition switch to OFF.2 Disconnect the FICM harness plug IP43_A.3 Measure the resistance between the camera harness terminal and the FICM harness terminal. Measuring circuit: RC03 plug terminal 3 and IP43_ The resistance between terminal 15 of plug A. Measuring circuit: RC03 plug terminal 4 and IP43_ The resistance between terminal 14 of plug A.4 Check whether the result is normal or not?
NO → Repair or replace the faulted parts.	
YES ↓	

Steps5	Check the camera circuit (short circuit).
	<ol style="list-style-type: none"> 1 Turn the ignition switch to OFF. 2 Measure the resistance between the camera harness plug and ground. Measuring circuit: The resistance between terminal 3 of RC03 plug and the grounding. Measuring circuit: The resistance between terminal 4 of RC03 plug and the grounding. Standard value: infinity 3 Measure the voltage between the harness plug of the camera interface and ground. Measuring circuit: The voltage between terminal 3 of IRC03 plug and the grounding. Measuring circuit: The voltage between terminal 4 of RC03 plug and the grounding. Standard value: ≈ 0V 4 Check whether the result is normal or not?
NO → Repair or replace the faulted parts.	
YES ↓	
Steps6	Check the camera (component inspection).
	<ol style="list-style-type: none"> 1 Measure the resistance of the camera terminals directly. Measuring circuit: The resistance between terminal 3 and terminal 4 of plug RC03. Standard value: 2 Measure the resistance between the camera harness plug and ground. Measuring circuit: The resistance between terminal 3 of RC03 plug and the housing. Measuring circuit: The resistance between terminal 4 of RC03 plug and the housing. Standard value: infinity 3 Check whether the result is normal or not?
NO → Replace the camera.	
YES ↓	

FICM

Steps7	Test whether FICM is norm.
	<ol style="list-style-type: none"> 1 Turn the ignition switch to OFF. 2 Disconnect and check the FICM harness plug IP43_ A, IP43_ B. 3 Check and repair. <ul style="list-style-type: none"> • Corrosion(install new adapting piece or terminal-cleaning module and pin). • Pin damaged or bent-install new terminal/pin. • Fly out of pins-install new pins as needed. 4 Reconnect the FICM plug and all other previously disconnected plug. Make sure the pin is properly positioned and fixed. 5 Run the system and determine if the problem persists?
	YES → Change the FICM Module
NO ↓	
At this point the system is functioning normally. The problem may be caused by module connections. Address the root cause of any connector or pin problems.	
Next Step ↓	
Diagnosis end.	

DTC Summary List (FICM)-Right

DTC	English descriptions	Reference page
B1117-16	Power Supply Voltage out of range	B1117-16、 B1117-17
B1117-17	Power Supply Voltage out of range	
U0073-88	CAN BUS OFF	U0073-88
B13B7-11	Tuner Antenna Connection Failures	B13B7-11
B1AE0-14	360 Left Camera Video Signal Circuit Short to Ground or Open	
B1AE0-12	360 Left Camera Video Signal Circuit Short to Battery	
B1AE1-14	360 Right Camera Video Signal Circuit Short to Ground or Open	
B1AE1-12	360 Right Camera Video Signal Circuit Short to Battery	
B1AE2-14	360 Front Camera Video Signal Circuit Short to Ground or Open	
B1AE2-12	360 Front Camera Video Signal Circuit Short to Battery	
B1AE3-14	360 Rear Camera Video Signal Circuit Short to Ground or Open	
B1AE3-12	360 Rear Camera Video Signal Circuit Short to Battery	
B13B9-11	Mic1 Connection circuit Open or Short to GND	B13B9-11、 B13B9-14
B13B9-14	Mic1 Connection circuit Short to PowerSupply	
B1A1B-87	Lost Communication With Camera Module via CVBS	B1A1B-87
B1A1A-87	Lost Communication With Module LVDS	B1A1A-87
U0140-87	Lost commulication with BCM	U0140-87
U0141-87	Lost communication with ESC	U0141-87
U0254-87	Lost communication with SAS	U0254-87
U0255-87	Lost commulication with IPK	U0255-87
U0257-87	Lost communication with HVAC	U0257-87
U0266-87	Lost commulication with LDW	U0266-87
U0267-87	Lost commulication with BSD	U0267-87

FICM

B1117-16、 B1117-17

Fault diagnosis code
B1117-16: Circuit voltage below threshold
B1117-17: Circuit voltage above threshold
Detection tools
1 Multimeter and diagnostic apparatus
Possible causes
<ul style="list-style-type: none">• Circuit,terminal and adapting piece• Battery• FICM• Charging system• Insurance fuse
Conditions for fault code operation
Turn the ignition switch to the ON position
Conditions for fault code setting
B1117-16
If the power supply voltage continuously drops below 9V for 1 second, record it.
B1117-17
If the power supply voltage continuously exceeds 16V for 1 second, record it.
To set the effect of a fault code condition
Description of circuit diagram
The FICM will monitor whether all sensors and actuators are within normal range all the time. Meanwhile,it will check the connector for virtual connection, short circuit, open circuit and the connection rationality with other signals. When fault occurs, the FICM module will save the fault code corresponding to that fault and enable safety mode.

Circuit diagram

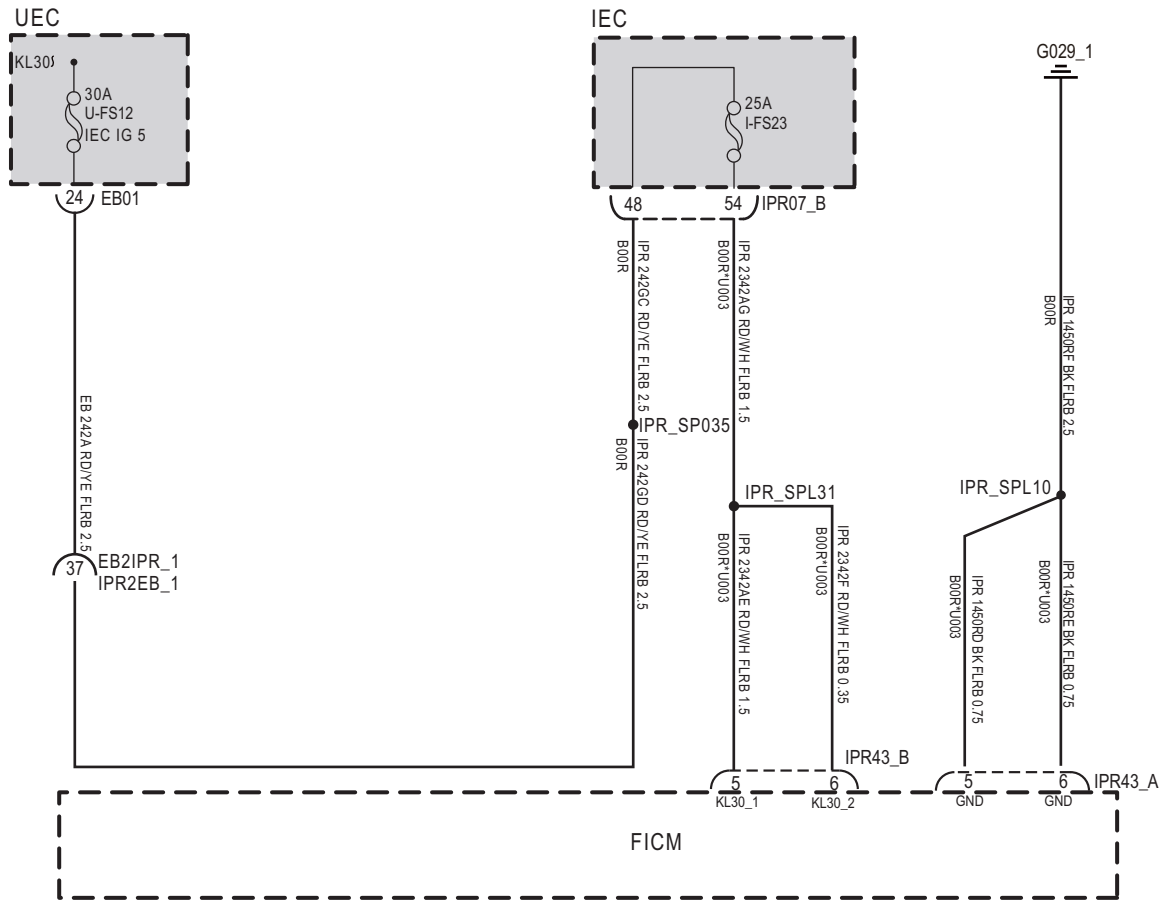

IPR43_A

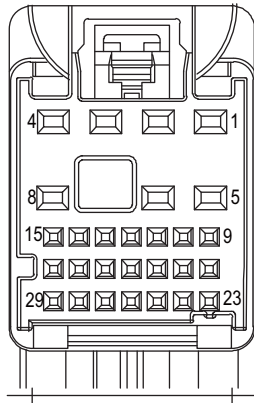

IPR43_B

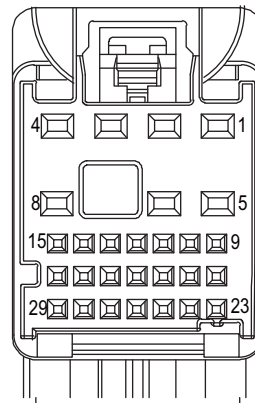

EK896053

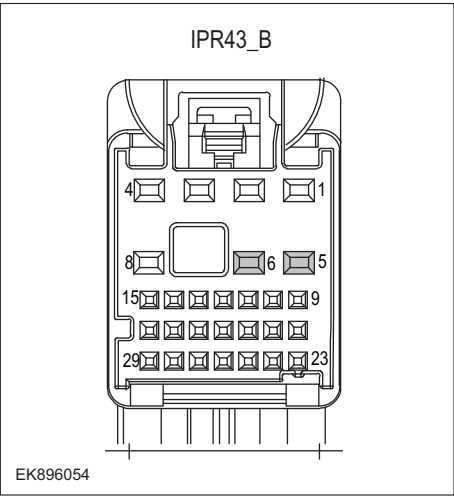
Troubleshooting steps	
Steps1	General inspection.
	<ol style="list-style-type: none"> 1 Check fusesU-FS12、 I-FS23 for damage. 2 Check battery capacity. 3 Check the harness plug of FICM for damage, poor contact, aging and looseness. 4 Check whether the result is normal or not?
	NO → Repair or replace the faulted parts.
YES ↓	
Steps2	Check fault codes.
	<ol style="list-style-type: none"> 1 Connect the fault diagnosis instrument to the diagnosis interface. 2 Turn the ignition switch to ON position. 3 Diagnose the FICM with diagnostic apparatus. 4 If there is any fault code except for B1117-16、 B1117-17 之外?
	YES → Refer to: DTC Summary List (FICM)-Right .
NO ↓	
Steps3	Check the FICMBattery power supply voltage.
	<ol style="list-style-type: none"> 1 Turn the ignition switch to OFF. 2 Disconnect the FICM harness plug IPR43_ B. 3 Measure the voltage between the FICM harness terminal and ground. Measuring circuit: IPR43_ The voltage between terminal 5 of plug B and the grounding. Measuring circuit: IPR43_ The voltage between terminal 6 of plug B and the grounding. Standard value:10~14V 4 Check whether the result is normal or not?
	NO → Repair or replace the faulted parts.
YES ↓	

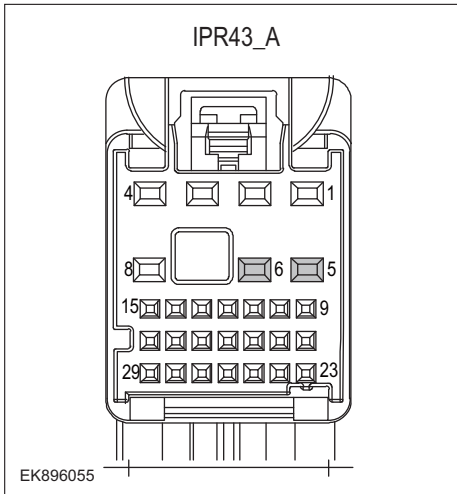
Steps4	Check the power voltage when the FICM is started or operating
	<ol style="list-style-type: none"> 1 Turn the ignition switch to OFF. 2 Disconnect the FICM harness plug IPR43_ A. 3 Measure the resistance between the FICM harness plug and ground. Measuring circuit: IPR43_ The resistance between terminal 5 of plug A and the grounding. Measuring circuit: IPR43_ The resistance between terminal 6 of plug A and the grounding. Standard value: < 1Ω 4 Test whether the resistance is less than 1Ω?
NO → Repair or replace the faulted parts.	
YES ↓	
Steps5	Test whether FICM is norm.
	<ol style="list-style-type: none"> 1 Turn the ignition switch to OFF. 2 Disconnect and check the harness plug IPR43_ A, IPR43_ B of FICM module. 3 Check and repair. <ul style="list-style-type: none"> • Corrosion (install new adapting piece or terminal-cleaning module and pin). • Pin damaged or bent - install new terminal/pin. 4 Fly out of pins - install new pins as needed. 5 Reconnect the FICM plug and all other previously disconnected plug. Make sure the pin is properly positioned and fixed. 6 Run the system and determine if the problem persists?
YES → Change the FICM Module	
NO ↓	
At this point the system is functioning normally. The problem may be caused by module connections. Address the root cause of any connector or pin problems.	
Next Step ↓	
Diagnosis end.	

U0073-88

Fault diagnosis code
U0073-88: CAN BUS OFF
Detection tools
1 Multimeter and diagnostic apparatus
Possible causes
<ul style="list-style-type: none"> • Circuit, terminal and adapting piece • FICM • GWM
Conditions for fault code operation
Turn the ignition switch to the ON position
Conditions for fault code setting
U0073-88
The transmission error counter (TEC) exceeded the value of 255 three times.
To set the effect of a fault code condition
Description of circuit diagram
<p>The device is connected to the serial data circuit and monitors the serial data communication during normal vehicle operation. Devices exchange operational information and instructions with each other. The device has programming information that needs to be exchanged on the serial data circuit. The receiver device also monitors this information; In addition, some regular information is used to indicate the availability of the transmitter device.</p>

Circuit diagram

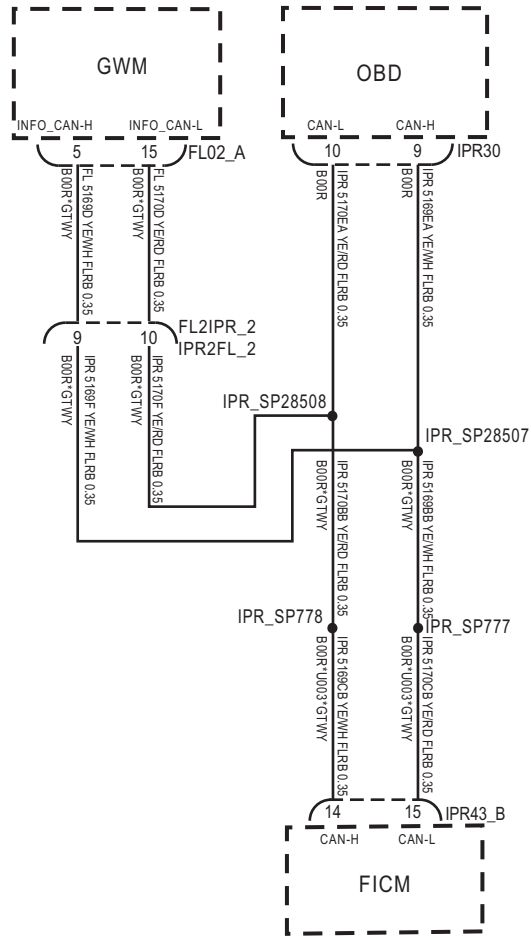

IPR43_B

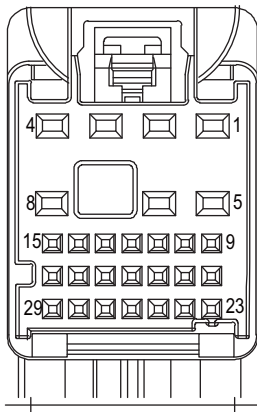

EK896056

FL02_A

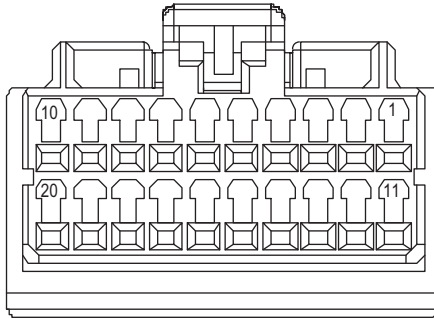

IPR30

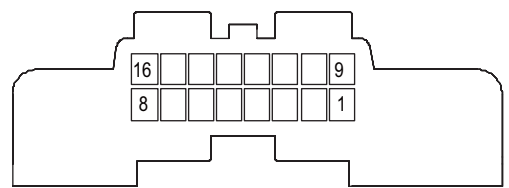

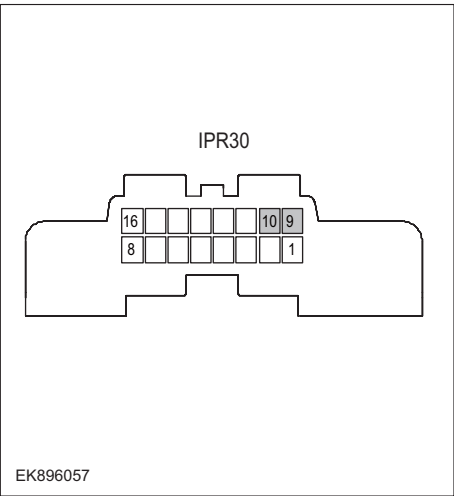
Troubleshooting steps	
Steps1	General inspection.
	<ol style="list-style-type: none"> 1 Check if the Insurance fuse is damaged. 2 Check battery capacity. 3 Check the GWM harness plug for damage, poor contact, aging, and looseness. 4 Check whether the result is normal or not?
NO → Repair or replace the faulted parts.	
YES ↓	
Steps2	Check fault codes.
	<ol style="list-style-type: none"> 1 Connect the fault diagnosis instrument to the diagnosis interface. 2 Turn the ignition switch to ON position. 3 Diagnose the GWM with diagnostic apparatus. 4 If there is any fault code except for U0073-88?
YES → Refer to: DTC Summary List (FICM)-Right .	
NO ↓	
Steps3	Check the integrity of the CAN communication network.
	<ol style="list-style-type: none"> 1 Turn the ignition switch to OFF. 2 Measure the resistance between the diagnostic interface harness terminals. Measuring circuit: The resistance between terminal 9 and terminal 10 of the IPR30 plug. Standard value: $\approx 60 \Omega$ 3 Check whether the result is normal or not?
NO → Repair or replace the faulted parts.	
YES ↓	

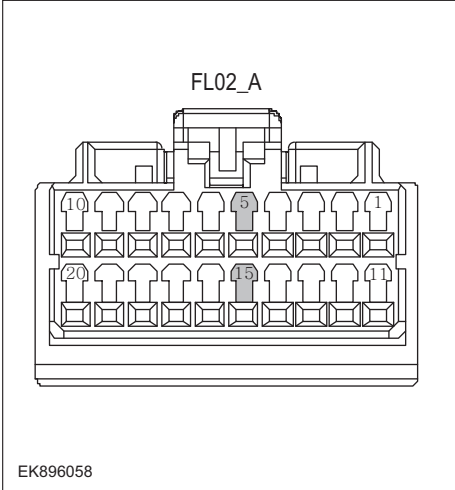
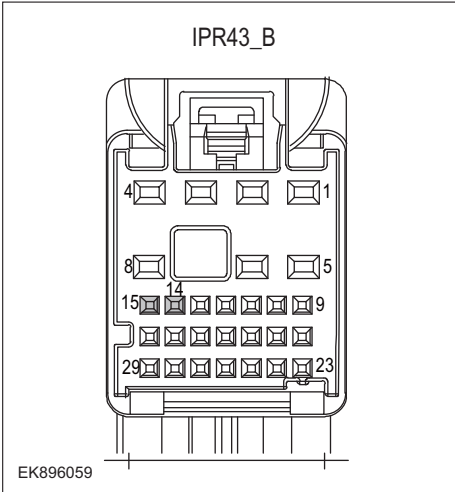
Steps4	Check the terminal resistance of GWM and FICM.
<div style="text-align: center;">  <p>FL02_A</p> <p>EK896058</p> </div> <div style="text-align: center; margin-top: 20px;">  <p>IPR43_B</p> <p>EK896059</p> </div>	<ol style="list-style-type: none"> 1 Turn the ignition switch to OFF. 2 Disconnect the GWM harness plug FL02_ A. 3 Measure the resistance between the GWM harness terminals. Measuring circuit: FL02_ The resistance between terminal 5 and terminal 15 of plug A. Standard value: 110~130 Ω 4 Connect GWM harness plug FL02_ A. 5 Disconnect the FICM harness plug IPR43_ B. 6 Measure the resistance between the FICM harness terminals. Measuring circuit: IPR43_ The resistance between terminal 14 and terminal 15 of plug B. Standard value: 110~130 Ω 7 Check whether the result is normal or not?
<p>YES ↓</p>	<p>NO → Repair or replace the faulted parts.</p>

FICM

Steps5	Test whether FICM is norm.
	<ol style="list-style-type: none">1 Turn the ignition switch to OFF.2 Disconnect and check the harness plug IPR43_A, IPR43_B of FICM module.3 Check and repair.<ul style="list-style-type: none">• Corrosion(install new adapting piece or terminal-cleaning module and pin).• Pin damaged or bent-install new terminal/pin.• Fly out of pins-install new pins as needed.4 Reconnect the FICM plug and all other previously disconnected plug. Make sure the pin is properly positioned and fixed.5 Run the system and determine if the problem persists?
	YES → Change the FICM Module
NO ↓	
At this point the system is functioning normally. The problem may be caused by module connections. Address the root cause of any connector or pin problems.	
Next Step ↓	
Diagnosis end.	

B13B7-11

Fault diagnosis code
B13B7-11: Circuit voltage below threshold
Detection tools
1 Multimeter and diagnostic apparatus
Possible causes
<ul style="list-style-type: none"> • Circuit,terminal and adapting piece • Battery • FICM • Charging system • Insurance fuse
Conditions for fault code operation
Turn the ignition switch to the ON position
Conditions for fault code setting
B13B7-11
Tuner ANT connection circuit open or shorted to GND
To set the effect of a fault code condition
Description of circuit diagram
The FICM will monitor whether all sensors and actuators are within normal range all the time. Meanwhile,it will check the connector for virtual connection, short circuit, open circuit and the connection rationality with other signals. When fault occurs, the FICM module will save the fault code corresponding to that fault and enable safety mode.

Circuit diagram

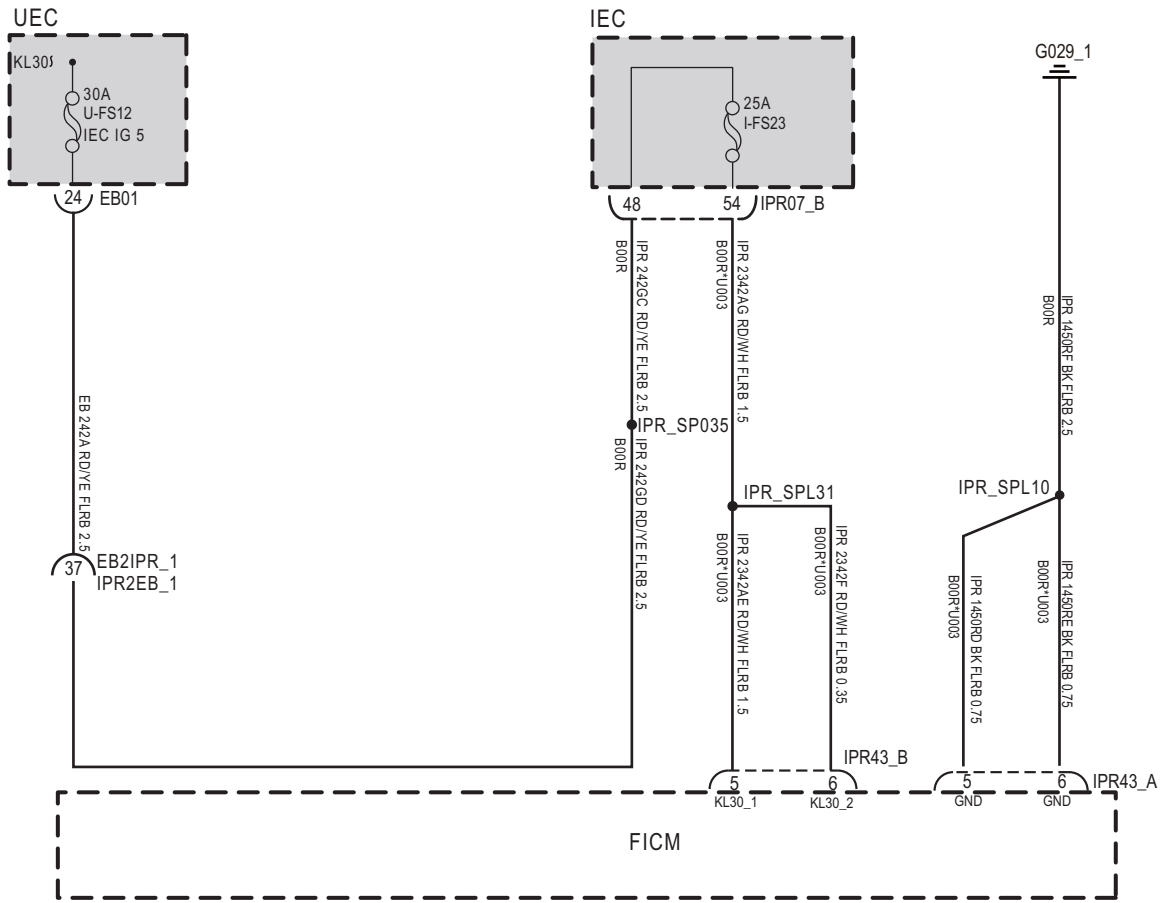

IPR43_A

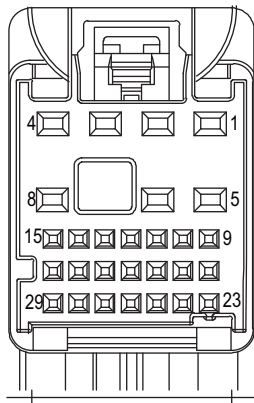

IPR43_B

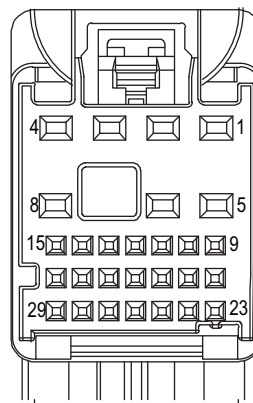

EK896053

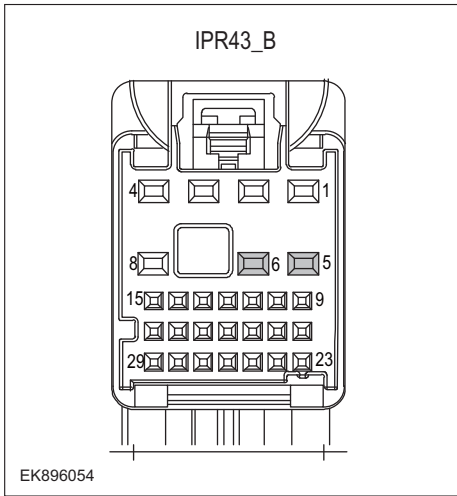
Troubleshooting steps	
Steps1	General inspection.
	<ol style="list-style-type: none"> 1 Check fusesU-FS12、 I-FS23 for damage. 2 Check battery capacity. 3 Check the harness plug of FICM for damage, poor contact, aging and looseness. 4 Check whether the result is normal or not?
	NO → Repair or replace the faulted parts.
YES ↓	
Steps2	Check fault codes.
	<ol style="list-style-type: none"> 1 Connect the fault diagnosis instrument to the diagnosis interface. 2 Turn the ignition switch to ON position. 3 Diagnose the FICM with diagnostic apparatus. 4 If there is any fault code except for B13B7-11?
	YES → Refer to: DTC Summary List (FICM)-Right .
NO ↓	
Steps3	Check the FICMBattery power supply voltage.
	<ol style="list-style-type: none"> 1 Turn the ignition switch to OFF. 2 Disconnect the FICM harness plug IPR43_ B. 3 Measure the voltage between the FICM harness terminal and ground. Measuring circuit: IPR43_ The voltage between terminal 5 of plug B and the grounding. Measuring circuit: IPR43_ The voltage between terminal 6 of plug B and the grounding. Standard value:10~14V 4 Check whether the result is normal or not?
	NO → Repair or replace the faulted parts.
YES ↓	

FICM

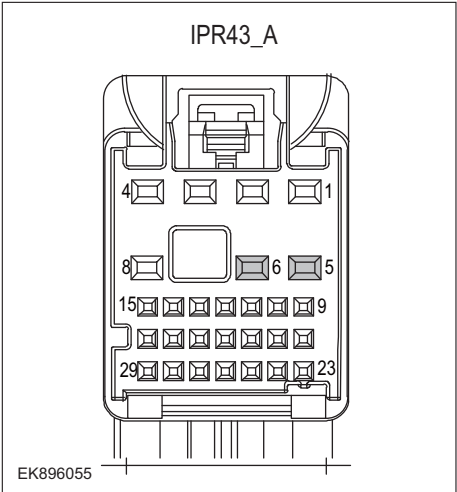
Steps4	Check the power voltage when the FICM is started or operating
	<ol style="list-style-type: none"> 1 Turn the ignition switch to OFF. 2 Disconnect the FICM harness plug IPR43_ A. 3 Measure the resistance between the FICM harness plug and ground. Measuring circuit: IPR43_ The resistance between terminal 5 of plug A and the grounding. Measuring circuit: IPR43_ The resistance between terminal 6 of plug A and the grounding. Standard value: < 1Ω 4 Test whether the resistance is less than 1Ω?
NO → Repair or replace the faulted parts.	
YES ↓	
Steps5	Test whether FICM is norm.
	<ol style="list-style-type: none"> 1 Turn the ignition switch to OFF. 2 Disconnect and check the harness plug IPR43_ A, IPR43_ B of FICM module. 3 Check and repair. <ul style="list-style-type: none"> • Corrosion(install new adapting piece or terminal-cleaning module and pin). • Pin damaged or bent-install new terminal/pin. 4 Fly out of pins-install new pins as needed. 5 Reconnect the FICM plug and all other previously disconnected plug. Make sure the pin is properly positioned and fixed. 6 Run the system and determine if the problem persists?
YES → Change the FICM Module	
NO ↓	
At this point the system is functioning normally. The problem may be caused by module connections. Address the root cause of any connector or pin problems.	
Next Step ↓	
Diagnosis end.	

B13B9-11、 B13B9-14

Fault diagnosis code
B13B9-11: Mic1 Connection circuit Open or Short to GND
B13B9-14: Mic1 Connection circuit Short to PowerSupply
Detection tools
1 Multimeter and diagnostic apparatus
Possible causes
<ul style="list-style-type: none"> • Circuit,terminal and adapting piece • FICM • Microphone malfunction
Conditions for fault code operation
Turn the ignition switch to the ON position
Conditions for fault code setting
B13B9-11
Mic1 connection circuit short circuit to power or open circuit or short circuit to ground
B13B9-14
Mic1 connection circuit short circuit to power or open circuit or short circuit to ground
To set the effect of a fault code condition
1
2
Description of circuit diagram
FICM monitors the microphone through low-level reference and signal circuits.

Circuit diagram

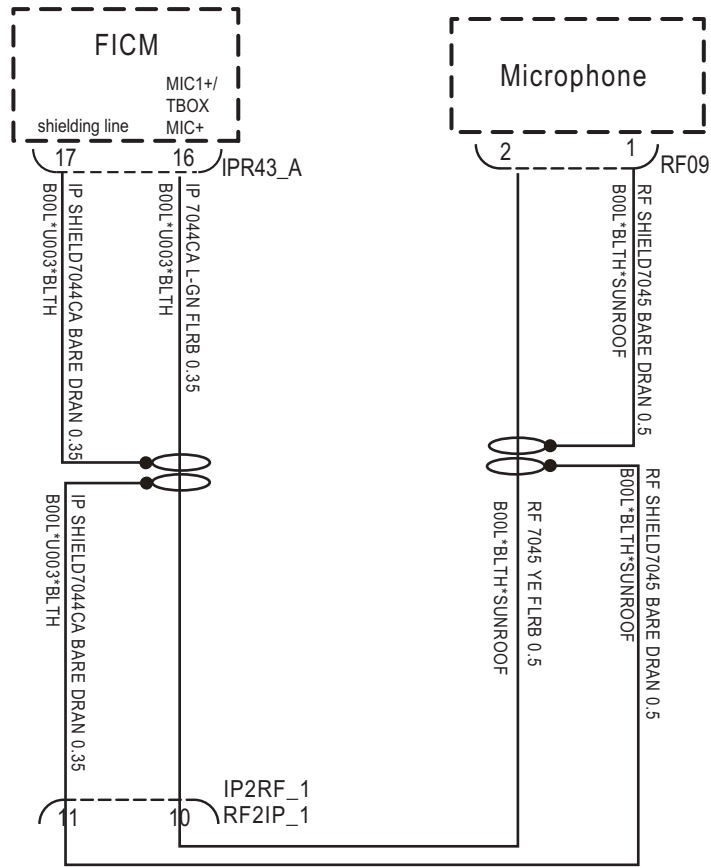

IPR43_A

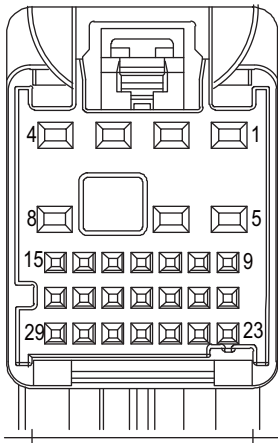

RF09

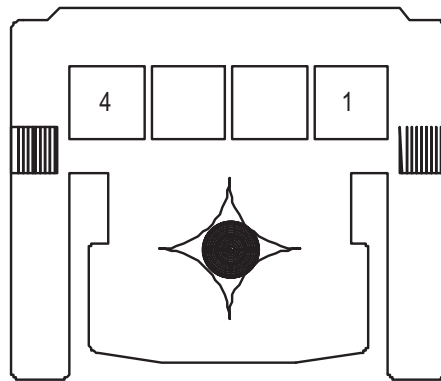

EK896060

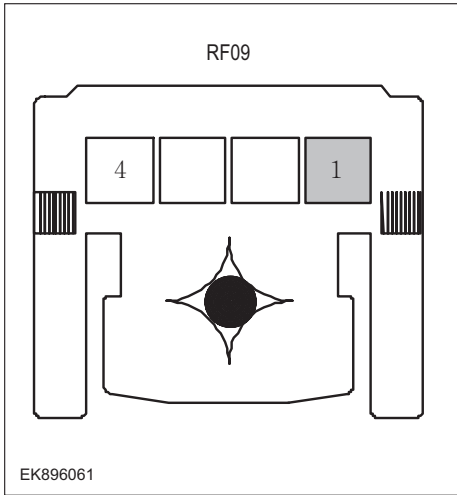
Troubleshooting steps	
Steps1	General inspection.
	<ol style="list-style-type: none"> 1 Check if the Insurance fuse is damaged. 2 Check battery capacity. 3 Check the microphone and FICM harness plugs for damage, poor contact, aging, and looseness. 4 Check whether the result is normal or not?
	NO → Repair or replace the faulted parts.
YES ↓	
Steps2	Check fault codes.
	<ol style="list-style-type: none"> 1 Connect the fault diagnosis instrument to the diagnosis interface. 2 Turn the ignition switch to ON position. 3 Diagnose the FICM with diagnostic apparatus. 4 If there is any fault code except for B13B9-11、 B13B9-14?
	YES → Refer to: DTC Summary List (FICM)-Right.
NO ↓	
Steps3	Check the power supply circuit of the microphone circuit.
	<ol style="list-style-type: none"> 1 Turn the ignition switch to OFF. 2 Disconnect the microphone harness plug RF09. 3 Turn on the ignition. 4 Measure the voltage between the microphone harness terminal and ground. Measuring circuit: The voltage between terminal 1 of RF09 plug and the grounding. Standard value: 4.8~5.2V 5 Check whether the result is normal or not?
	NO → Repair or replace the faulted parts.
YES ↓	

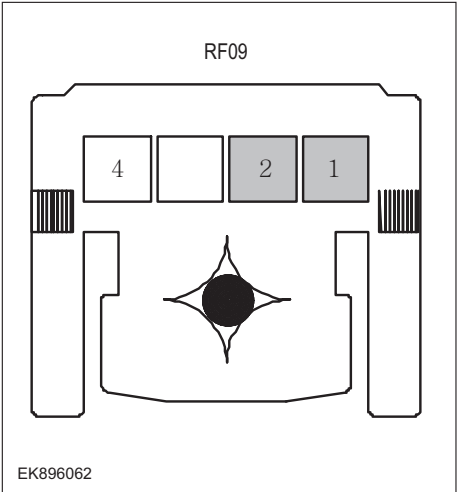
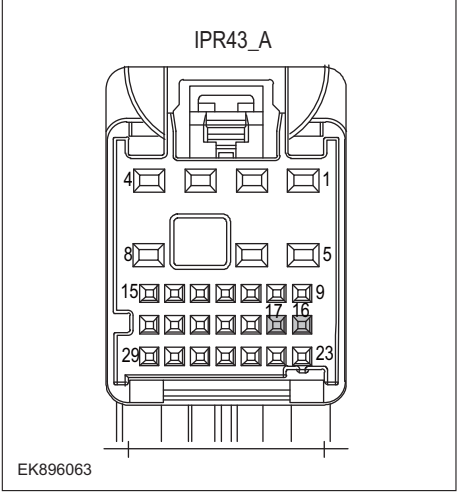
Steps4	Check the microphone circuit (open circuit).
<div style="text-align: center;">  <p>RF09</p> <p>EK896062</p> </div> <div style="text-align: center; margin-top: 20px;">  <p>IPR43_A</p> <p>EK896063</p> </div>	<ol style="list-style-type: none"> 1 Turn the ignition switch to OFF. 2 Disconnect the FICM harness plug IPR43_A. 3 Measure the resistance between the microphone harness terminal and the FICM harness terminal. Measuring circuit: The resistance between terminal 1 of RF09 plug and terminal 16 of IPR43-A plug. Measuring circuit: The resistance between terminal 2 of RF09 plug and terminal 17 of IPR43-A plug. 4 Check whether the result is normal or not?
	<p>NO → Repair or replace the faulted parts.</p>
<p>YES ↓</p>	

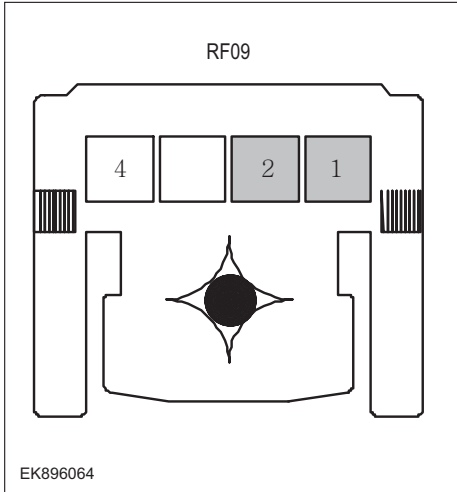
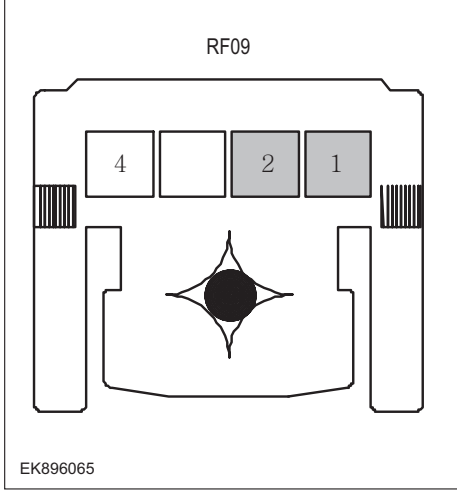
Steps5	Check the microphone circuit (short circuit).
	<ol style="list-style-type: none"> 1 Turn the ignition switch to OFF. 2 Measure the resistance between the microphone harness plug and ground. Measuring circuit: The resistance between terminal 1 of RF09 plug and the grounding. Measuring circuit: The resistance between terminal 2 of RF09 plug and the grounding. Standard value: infinity 3 Measure the voltage between the microphone harness plug and ground. Measuring circuit: The voltage between terminal 1 of RF09 plug and the grounding. Measuring circuit: The voltage between terminal 2 of RF09 plug and the grounding. Standard value: ≈ 0V 4 Check whether the result is normal or not?
NO → Repair or replace the faulted parts.	
YES ↓	
Steps6	Check the microphone (component inspection).
	<ol style="list-style-type: none"> 1 Measure the resistance of the microphone terminals directly. Measuring circuit: The resistance between terminal 1 and terminal 2 of RF09 plug. Standard value: 2 Measure the resistance between the microphone harness plug and ground. Measuring circuit: The resistance between terminal 1 of RF09 plug and the housing. Measuring circuit: The resistance between terminal 2 of RF09 plug and the housing. Standard value: infinity 3 Check whether the result is normal or not?
NO → Replace the microphone.	
YES ↓	

FICM

Steps7	Test whether FICM is norm.
	<ol style="list-style-type: none"> 1 Turn the ignition switch to OFF. 2 Disconnect and check the harness plug IPR43_A, IPR43_B of FICM module. 3 Check and repair. <ul style="list-style-type: none"> • Corrosion(install new adapting piece or terminal-cleaning module and pin). • Pin damaged or bent-install new terminal/pin. • Fly out of pins-install new pins as needed. 4 Reconnect the FICM plug and all other previously disconnected plug. Make sure the pin is properly positioned and fixed. 5 Run the system and determine if the problem persists?
	YES → Change the FICM Module
NO ↓	
At this point the system is functioning normally. The problem may be caused by module connections. Address the root cause of any connector or pin problems.	
Next Step ↓	
Diagnosis end.	

B1A1B-87

Fault diagnosis code
B1A1B-87: Lost Communication With Camera Module via CVBS
Detection tools
1 Multimeter and diagnostic apparatus
Possible causes
<ul style="list-style-type: none"> • Circuit, terminal and adapting piece • FICM • GWM
Conditions for fault code operation
Turn the ignition switch to the ON position
Conditions for fault code setting
B1A1B-87
Lost communication with camera module through CVBS
To set the effect of a fault code condition
Description of circuit diagram
<p>The device is connected to the serial data circuit and monitors the serial data communication during normal vehicle operation. Devices exchange operational information and instructions with each other. The device has programming information that needs to be exchanged on the serial data circuit. The receiver device also monitors this information; In addition, some regular information is used to indicate the availability of the transmitter device.</p>

Circuit diagram

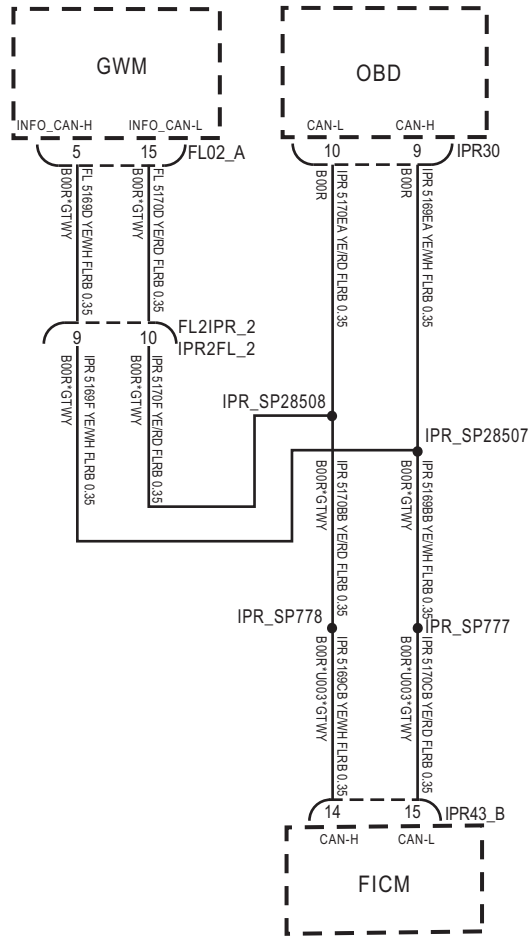

IPR43_B

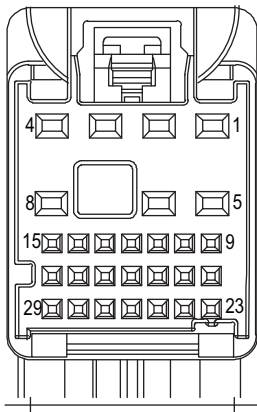

FL02_A

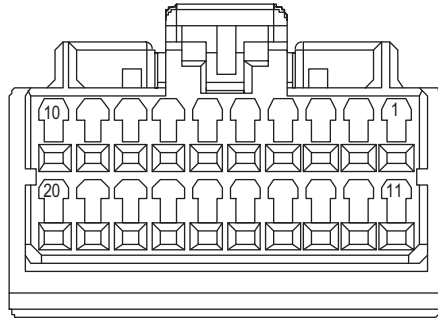

IPR30

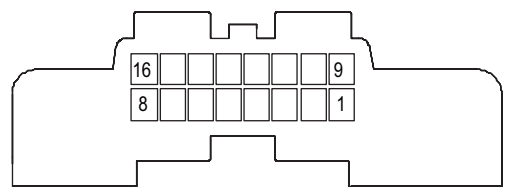

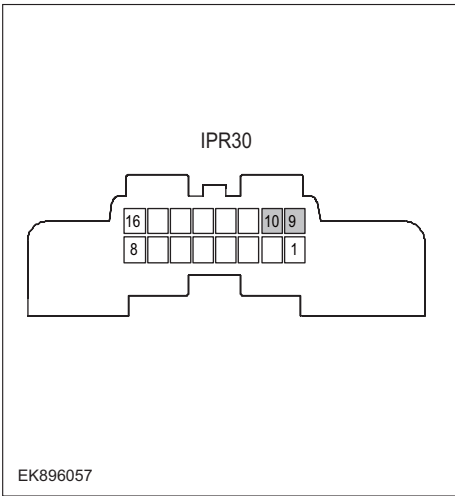
Troubleshooting steps	
Steps1	General inspection.
	<ol style="list-style-type: none"> 1 Check if the Insurance fuse is damaged. 2 Check battery capacity. 3 Check the GWM harness plug for damage, poor contact, aging, and looseness. 4 Check whether the result is normal or not?
	NO → Repair or replace the faulted parts.
YES ↓	
Steps2	Check fault codes.
	<ol style="list-style-type: none"> 1 Connect the fault diagnosis instrument to the diagnosis interface. 2 Turn the ignition switch to ON position. 3 Diagnose the GWM with diagnostic apparatus. 4 If there is any fault code except for B1A1B-87?
	YES → Refer to: DTC Summary List (FICM)-Right .
NO ↓	
Steps3	Check the integrity of the CAN communication network.
 <p style="text-align: center;">IPR30</p> <p style="text-align: center;">EK896057</p>	<ol style="list-style-type: none"> 1 Turn the ignition switch to OFF. 2 Measure the resistance between the diagnostic interface harness terminals. <p>Measuring circuit: The resistance between terminal 9 and terminal 10 of the IPR30 plug.</p> <p>Standard value: ≈ 60 Ω</p> <ol style="list-style-type: none"> 3 Check whether the result is normal or not?
	NO → Repair or replace the faulted parts.
YES ↓	

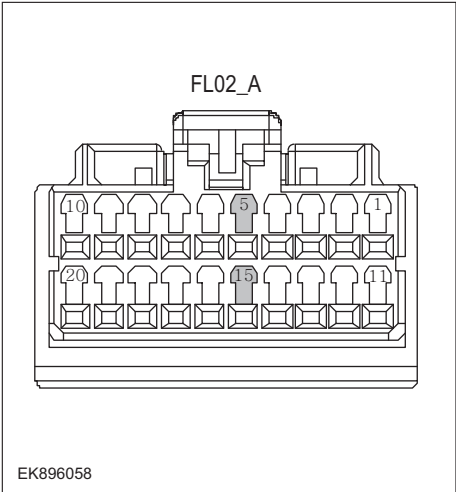
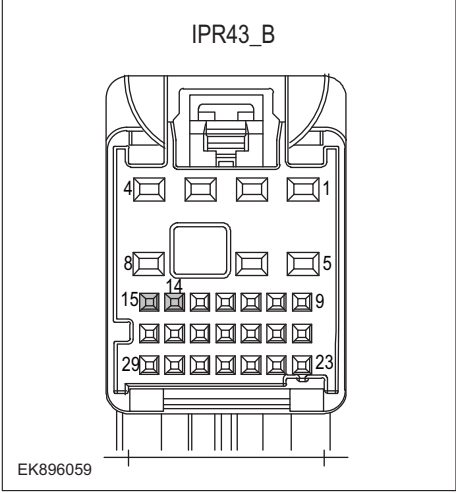
Steps4	Check the terminal resistance of GWM and FICM.
<div style="text-align: center;">  <p>FL02_A</p> <p>EK896058</p> </div> <div style="text-align: center; margin-top: 20px;">  <p>IPR43_B</p> <p>EK896059</p> </div>	<ol style="list-style-type: none"> 1 Turn the ignition switch to OFF. 2 Disconnect the GWM harness plug FL02_ A. 3 Measure the resistance between the GWM harness terminals. Measuring circuit: FL02_ The resistance between terminal 5 and terminal 15 of plug A. Standard value: 110~130 Ω 4 Connect GWM harness plug FL02_ A. 5 Disconnect the FICM harness plug IPR43_ B. 6 Measure the resistance between the FICM harness terminals. Measuring circuit: IPR43_ The resistance between terminal 14 and terminal 15 of plug B. Standard value: 110~130 Ω 7 Check whether the result is normal or not?
	<p>NO → Repair or replace the faulted parts.</p>
<p>YES ↓</p>	

Steps5	Test whether FICM is norm.
	<ol style="list-style-type: none"> 1 Turn the ignition switch to OFF. 2 Disconnect and check the harness plug IPR43_A, IPR43_B of FICM module. 3 Check and repair. <ul style="list-style-type: none"> • Corrosion (install new adapting piece or terminal-cleaning module and pin). • Pin damaged or bent - install new terminal/pin. • Fly out of pins - install new pins as needed. 4 Reconnect the FICM plug and all other previously disconnected plug. Make sure the pin is properly positioned and fixed. 5 Run the system and determine if the problem persists?
	YES → Change the FICM Module
NO ↓	
At this point the system is functioning normally. The problem may be caused by module connections. Address the root cause of any connector or pin problems.	
Next Step ↓	
Diagnosis end.	

B1A1A-87

Fault diagnosis code
B1A1A-87: Lost Communication With Module LVDS
Detection tools
1 Multimeter and diagnostic apparatus
Possible causes
<ul style="list-style-type: none"> • Circuit, terminal and adapting piece • FICM • GWM
Conditions for fault code operation
Turn the ignition switch to the ON position
Conditions for fault code setting
B1A1A-87
Lost communication with module LVDS
To set the effect of a fault code condition
Description of circuit diagram
<p>The device is connected to the serial data circuit and monitors the serial data communication during normal vehicle operation. Devices exchange operational information and instructions with each other. The device has programming information that needs to be exchanged on the serial data circuit. The receiver device also monitors this information; In addition, some regular information is used to indicate the availability of the transmitter device.</p>

Circuit diagram

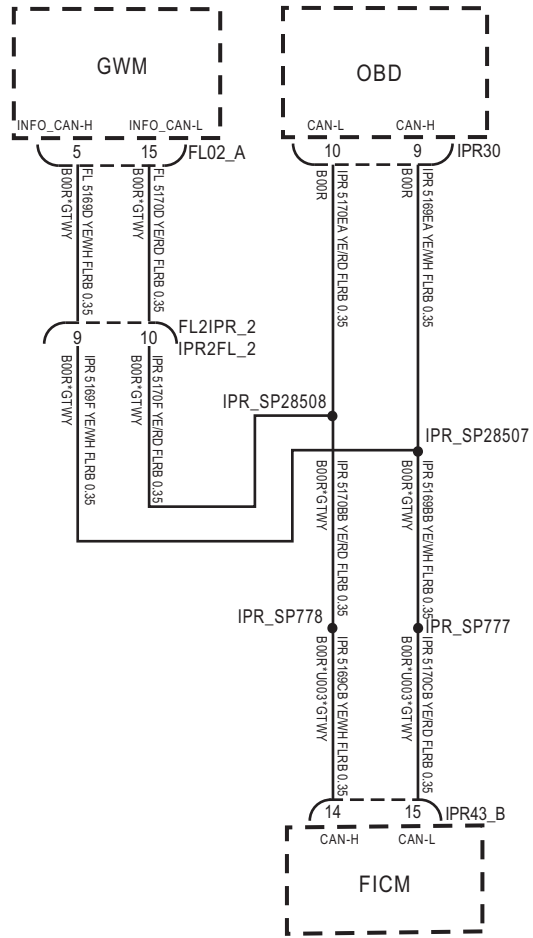

IPR43_B

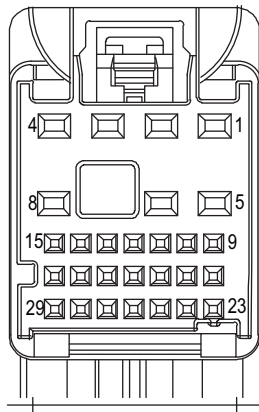

EK896056

FL02_A

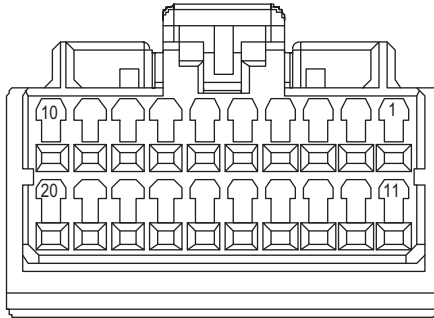

IPR30

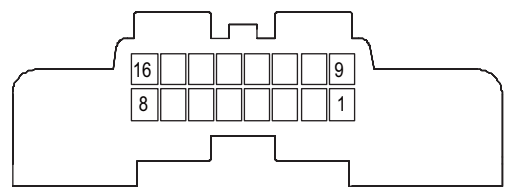

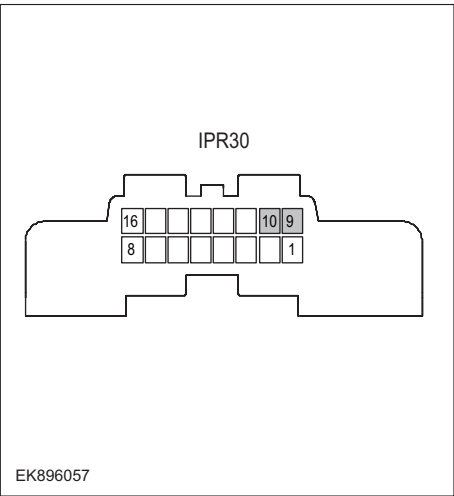
Troubleshooting steps	
Steps1	General inspection.
	<ol style="list-style-type: none"> 1 Check if the Insurance fuse is damaged. 2 Check battery capacity. 3 Check the GWM harness plug for damage, poor contact, aging, and looseness. 4 Check whether the result is normal or not?
NO → Repair or replace the faulted parts.	
YES ↓	
Steps2	Check fault codes.
	<ol style="list-style-type: none"> 1 Connect the fault diagnosis instrument to the diagnosis interface. 2 Turn the ignition switch to ON position. 3 Diagnose the GWM with diagnostic apparatus. 4 If there is any fault code except for B1A1A-87?
YES → Refer to: DTC Summary List (FICM)-Right .	
NO ↓	
Steps3	Check the integrity of the CAN communication network.
	<ol style="list-style-type: none"> 1 Turn the ignition switch to OFF. 2 Measure the resistance between the diagnostic interface harness terminals. Measuring circuit: The resistance between terminal 9 and terminal 10 of the IPR30 plug. Standard value: $\approx 60 \Omega$ 3 Check whether the result is normal or not?
NO → Repair or replace the faulted parts.	
YES ↓	

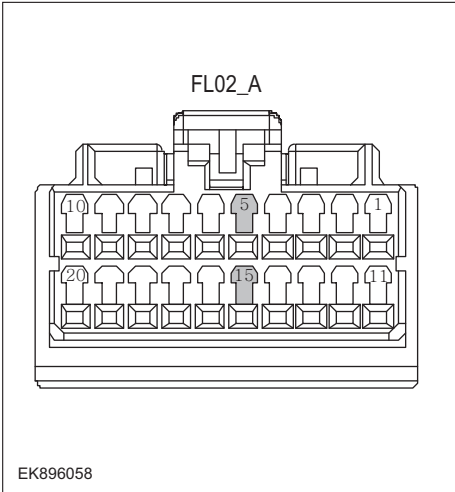
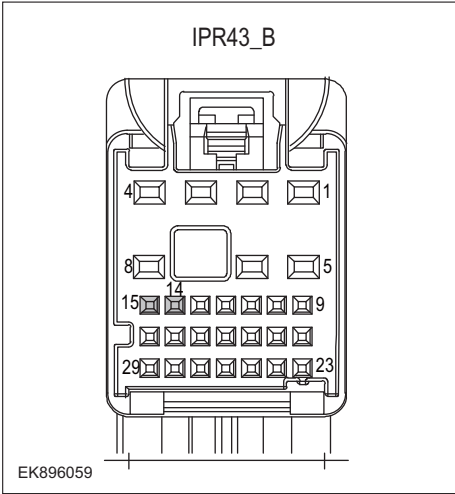
<p>Steps4</p>	<p>Check the terminal resistance of GWM and FICM.</p>
<div style="text-align: center;">  <p>FL02_A</p> <p>EK896058</p> </div> <div style="text-align: center; margin-top: 20px;">  <p>IPR43_B</p> <p>EK896059</p> </div>	<ol style="list-style-type: none"> 1 Turn the ignition switch to OFF. 2 Disconnect the GWM harness plug FL02_ A. 3 Measure the resistance between the GWM harness terminals. Measuring circuit: FL02_ The resistance between terminal 5 and terminal 15 of plug A. Standard value: 110~130 Ω 4 Connect GWM harness plug FL02_ A. 5 Disconnect the FICM harness plug IPR43_ B. 6 Measure the resistance between the FICM harness terminals. Measuring circuit: IPR43_ The resistance between terminal 14 and terminal 15 of plug B. Standard value: 110~130 Ω 7 Check whether the result is normal or not?
<p>YES ↓</p>	<p>NO → Repair or replace the faulted parts.</p>

FICM

Steps5	Test whether FICM is norm.
	<ol style="list-style-type: none">1 Turn the ignition switch to OFF.2 Disconnect and check the harness plug IPR43_A, IPR43_B of FICM module.3 Check and repair.<ul style="list-style-type: none">• Corrosion(install new adapting piece or terminal-cleaning module and pin).• Pin damaged or bent-install new terminal/pin.• Fly out of pins-install new pins as needed.4 Reconnect the FICM plug and all other previously disconnected plug. Make sure the pin is properly positioned and fixed.5 Run the system and determine if the problem persists?
	YES → Change the FICM Module
NO ↓	
At this point the system is functioning normally. The problem may be caused by module connections. Address the root cause of any connector or pin problems.	
Next Step ↓	
Diagnosis end.	

U0140-87

Fault diagnosis code
U0140-87: Lost Communication With Module BCM
Detection tools
1 Multimeter and diagnostic apparatus
Possible causes
<ul style="list-style-type: none"> • Circuit, terminal and adapting piece • FICM • GWM
Conditions for fault code operation
Turn the ignition switch to the ON position
Conditions for fault code setting
U0140-87
With iCGM_ BCM_ 581h message lost communication for at least 2000 milliseconds.
To set the effect of a fault code condition
Description of circuit diagram
The device is connected to the serial data circuit and monitors the serial data communication during normal vehicle operation. Devices exchange operational information and instructions with each other. The device has programming information that needs to be exchanged on the serial data circuit. The receiver device also monitors this information; In addition, some regular information is used to indicate the availability of the transmitter device.

Circuit diagram

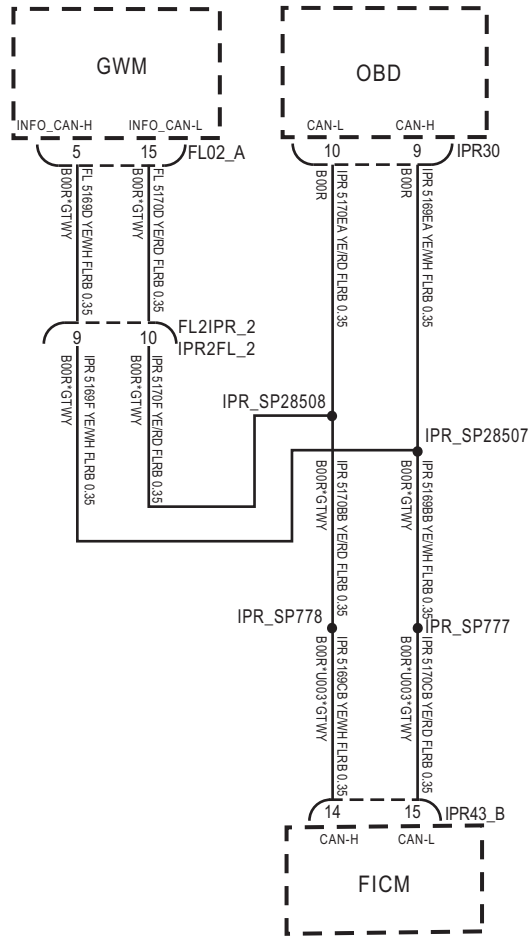

IPR43_B

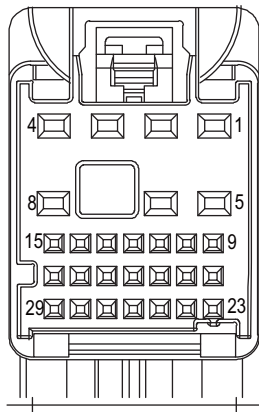

FL02_A

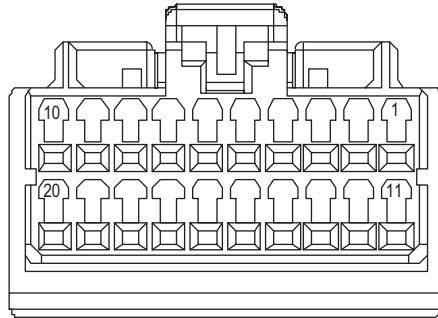

IPR30

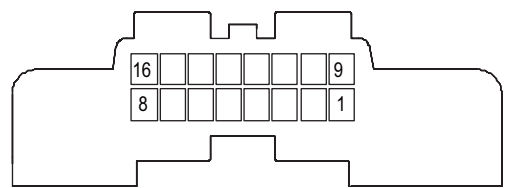

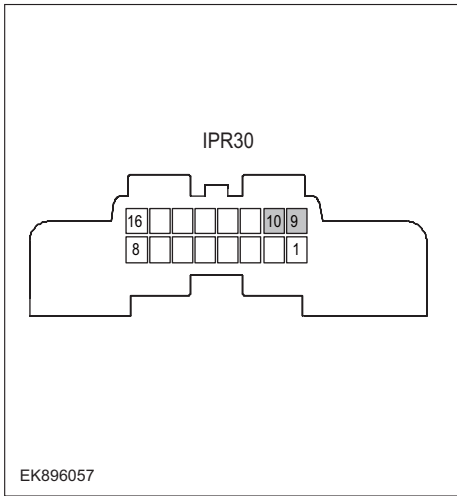
Troubleshooting steps	
Steps1	General inspection.
	<ol style="list-style-type: none"> 1 Check if the Insurance fuse is damaged. 2 Check battery capacity. 3 Check the GWM harness plug for damage, poor contact, aging, and looseness. 4 Check whether the result is normal or not?
	NO → Repair or replace the faulted parts.
YES ↓	
Steps2	Check fault codes.
	<ol style="list-style-type: none"> 1 Connect the fault diagnosis instrument to the diagnosis interface. 2 Turn the ignition switch to ON position. 3 Diagnose the GWM with diagnostic apparatus. 4 If there is any fault code except for U0140-87?
	YES → Refer to: DTC Summary List (FICM)-Right .
NO ↓	
Steps3	Check the integrity of the CAN communication network.
 <p style="text-align: center;">IPR30</p> <p style="text-align: center;">EK896057</p>	<ol style="list-style-type: none"> 1 Turn the ignition switch to OFF. 2 Measure the resistance between the diagnostic interface harness terminals. Measuring circuit: The resistance between terminal 9 and terminal 10 of the IPR30 plug. Standard value: ≈ 60 Ω 3 Check whether the result is normal or not?
	NO → Repair or replace the faulted parts.
YES ↓	

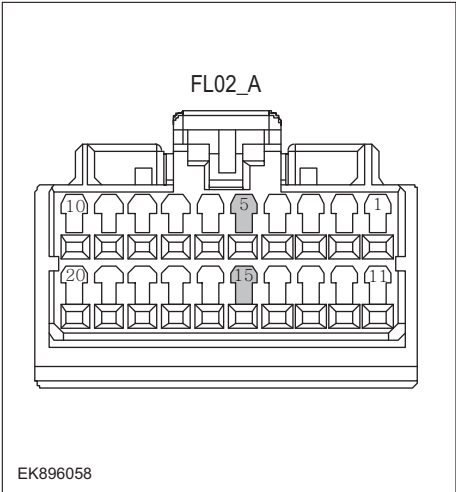
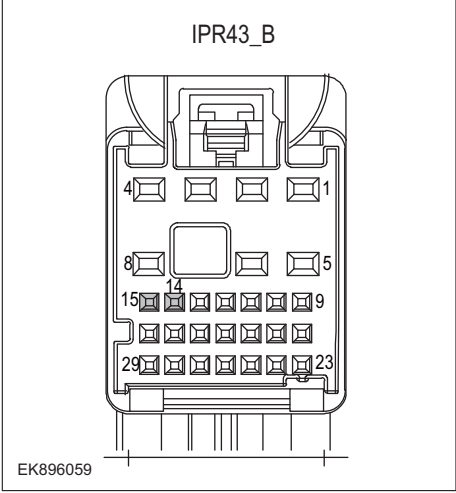
Steps4	Check the terminal resistance of GWM and FICM.
<div style="text-align: center;">  <p>FL02_A</p> <p>EK896058</p> </div> <div style="text-align: center; margin-top: 20px;">  <p>IPR43_B</p> <p>EK896059</p> </div>	<ol style="list-style-type: none"> 1 Turn the ignition switch to OFF. 2 Disconnect the GWM harness plug FL02_ A. 3 Measure the resistance between the GWM harness terminals. Measuring circuit: FL02_ The resistance between terminal 5 and terminal 15 of plug A. Standard value: 110~130 Ω 4 Connect GWM harness plug FL02_ A. 5 Disconnect the FICM harness plug IPR43_ B. 6 Measure the resistance between the FICM harness terminals. Measuring circuit: IPR43_ The resistance between terminal 14 and terminal 15 of plug B. Standard value: 110~130 Ω 7 Check whether the result is normal or not?
	<p>NO → Repair or replace the faulted parts.</p>
<p>YES ↓</p>	

Steps5	Test whether FICM is norm.
	<ol style="list-style-type: none"> 1 Turn the ignition switch to OFF. 2 Disconnect and check the harness plug IPR43_A, IPR43_B of FICM module. 3 Check and repair. <ul style="list-style-type: none"> • Corrosion (install new adapting piece or terminal-cleaning module and pin). • Pin damaged or bent - install new terminal/pin. • Fly out of pins - install new pins as needed. 4 Reconnect the FICM plug and all other previously disconnected plug. Make sure the pin is properly positioned and fixed. 5 Run the system and determine if the problem persists?
	YES → Change the FICM Module
NO ↓	
At this point the system is functioning normally. The problem may be caused by module connections. Address the root cause of any connector or pin problems.	
Next Step ↓	
Diagnosis end.	

U0141-87

Fault diagnosis code
U0141-87: Lost communication with ESC
Detection tools
1 Multimeter and diagnostic apparatus
Possible causes
<ul style="list-style-type: none"> • Circuit, terminal and adapting piece • FICM • GWM
Conditions for fault code operation
Turn the ignition switch to the ON position
Conditions for fault code setting
U0141-87
With iCGM_ ESC_ 269h message lost communication for at least 250 milliseconds
To set the effect of a fault code condition
Description of circuit diagram
<p>The device is connected to the serial data circuit and monitors the serial data communication during normal vehicle operation. Devices exchange operational information and instructions with each other. The device has programming information that needs to be exchanged on the serial data circuit. The receiver device also monitors this information; In addition, some regular information is used to indicate the availability of the transmitter device.</p>

Circuit diagram

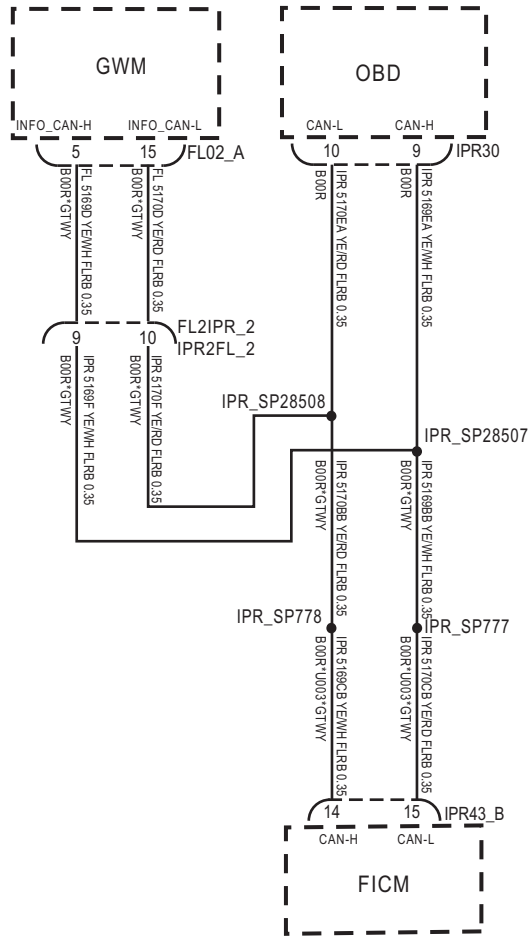

IPR43_B

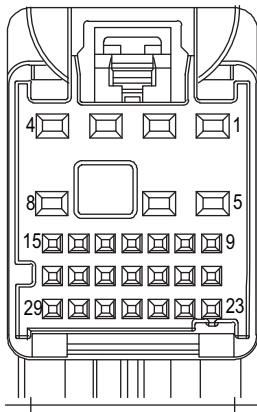

EK896056

FL02_A

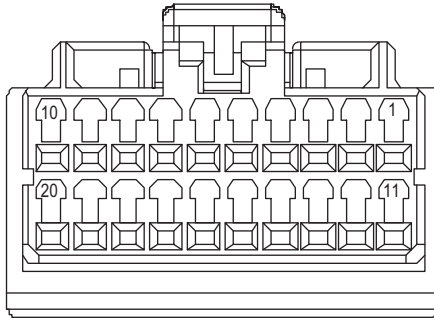

IPR30

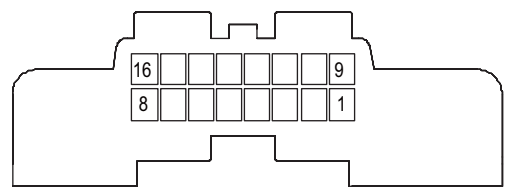

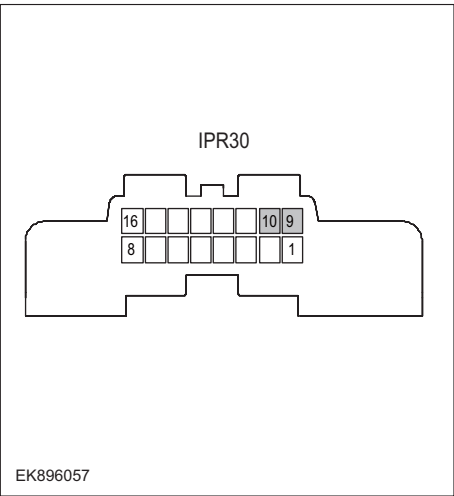
Troubleshooting steps	
Steps1	General inspection.
	<ol style="list-style-type: none"> 1 Check if the Insurance fuse is damaged. 2 Check battery capacity. 3 Check the GWM harness plug for damage, poor contact, aging, and looseness. 4 Check whether the result is normal or not?
NO → Repair or replace the faulted parts.	
YES ↓	
Steps2	Check fault codes.
	<ol style="list-style-type: none"> 1 Connect the fault diagnosis instrument to the diagnosis interface. 2 Turn the ignition switch to ON position. 3 Diagnose the GWM with diagnostic apparatus. 4 If there is any fault code except for U0141-87?
YES → Refer to: DTC Summary List (FICM)-Right .	
NO ↓	
Steps3	Check the integrity of the CAN communication network.
	<ol style="list-style-type: none"> 1 Turn the ignition switch to OFF. 2 Measure the resistance between the diagnostic interface harness terminals. Measuring circuit: The resistance between terminal 9 and terminal 10 of the IPR30 plug. Standard value: $\approx 60 \Omega$ 3 Check whether the result is normal or not?
NO → Repair or replace the faulted parts.	
YES ↓	

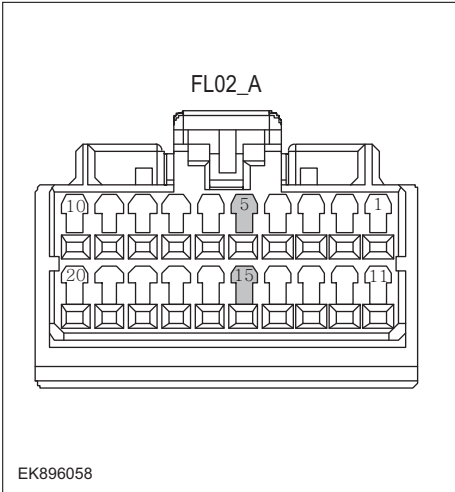
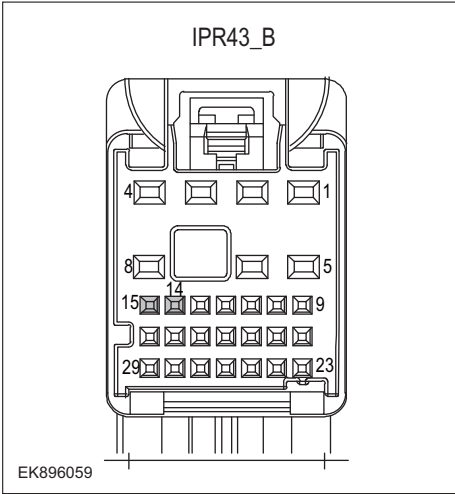
Steps4	Check the terminal resistance of GWM and FICM.
<div style="text-align: center;">  <p>FL02_A</p> <p>EK896058</p> </div> <div style="text-align: center; margin-top: 20px;">  <p>IPR43_B</p> <p>EK896059</p> </div>	<ol style="list-style-type: none"> 1 Turn the ignition switch to OFF. 2 Disconnect the GWM harness plug FL02_ A. 3 Measure the resistance between the GWM harness terminals. Measuring circuit: FL02_ The resistance between terminal 5 and terminal 15 of plug A. Standard value: 110~130 Ω 4 Connect GWM harness plug FL02_ A. 5 Disconnect the FICM harness plug IPR43_ B. 6 Measure the resistance between the FICM harness terminals. Measuring circuit: IPR43_ The resistance between terminal 14 and terminal 15 of plug B. Standard value: 110~130 Ω 7 Check whether the result is normal or not?
<p>YES ↓</p>	<p>NO → Repair or replace the faulted parts.</p>

FICM

Steps5	Test whether FICM is norm.
	<ol style="list-style-type: none">1 Turn the ignition switch to OFF.2 Disconnect and check the harness plug IPR43_A, IPR43_B of FICM module.3 Check and repair.<ul style="list-style-type: none">• Corrosion(install new adapting piece or terminal-cleaning module and pin).• Pin damaged or bent-install new terminal/pin.• Fly out of pins-install new pins as needed.4 Reconnect the FICM plug and all other previously disconnected plug. Make sure the pin is properly positioned and fixed.5 Run the system and determine if the problem persists?
	YES → Change the FICM Module
NO ↓	
At this point the system is functioning normally. The problem may be caused by module connections. Address the root cause of any connector or pin problems.	
Next Step ↓	
Diagnosis end.	

U0254-87

Fault diagnosis code
U0254-87: Lost communication with SAS
Detection tools
1 Multimeter and diagnostic apparatus
Possible causes
<ul style="list-style-type: none"> • Circuit, terminal and adapting piece • FICM • GWM
Conditions for fault code operation
Turn the ignition switch to the ON position
Conditions for fault code setting
U0254-87
With iCGM_ SAS_ 266h message lost communication for at least 250 milliseconds
To set the effect of a fault code condition
Description of circuit diagram
The device is connected to the serial data circuit and monitors the serial data communication during normal vehicle operation. Devices exchange operational information and instructions with each other. The device has programming information that needs to be exchanged on the serial data circuit. The receiver device also monitors this information; In addition, some regular information is used to indicate the availability of the transmitter device.

Circuit diagram

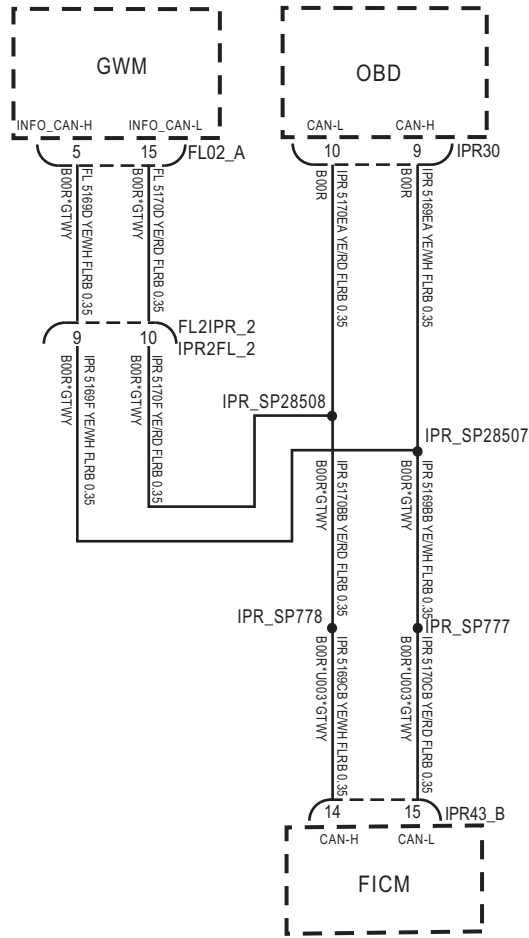

IPR43_B

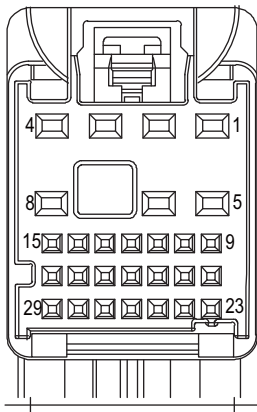

EK896056

FL02_A

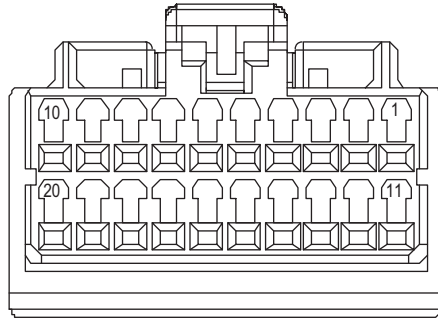

IPR30

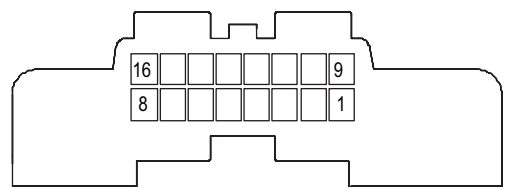

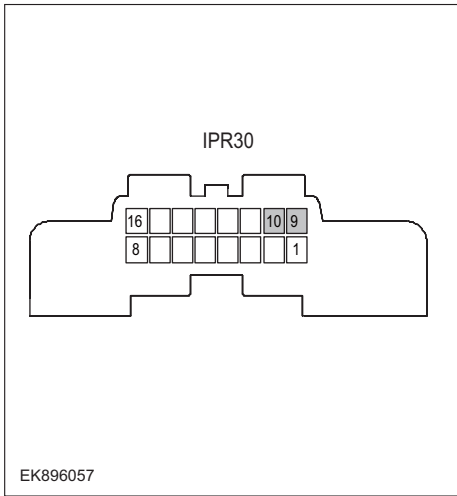
Troubleshooting steps	
Steps1	General inspection.
	<ol style="list-style-type: none"> 1 Check if the Insurance fuse is damaged. 2 Check battery capacity. 3 Check the GWM harness plug for damage, poor contact, aging, and looseness. 4 Check whether the result is normal or not?
	NO → Repair or replace the faulted parts.
YES ↓	
Steps2	Check fault codes.
	<ol style="list-style-type: none"> 1 Connect the fault diagnosis instrument to the diagnosis interface. 2 Turn the ignition switch to ON position. 3 Diagnose the GWM with diagnostic apparatus. 4 If there is any fault code except for U0254-87?
	YES → Refer to: DTC Summary List (FICM)-Right .
NO ↓	
Steps3	Check the integrity of the CAN communication network.
	<ol style="list-style-type: none"> 1 Turn the ignition switch to OFF. 2 Measure the resistance between the diagnostic interface harness terminals. Measuring circuit: The resistance between terminal 9 and terminal 10 of the IPR30 plug. Standard value: ≈ 60 Ω 3 Check whether the result is normal or not?
	NO → Repair or replace the faulted parts.
YES ↓	

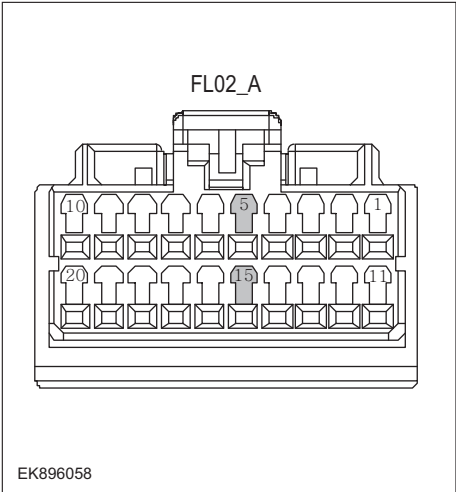
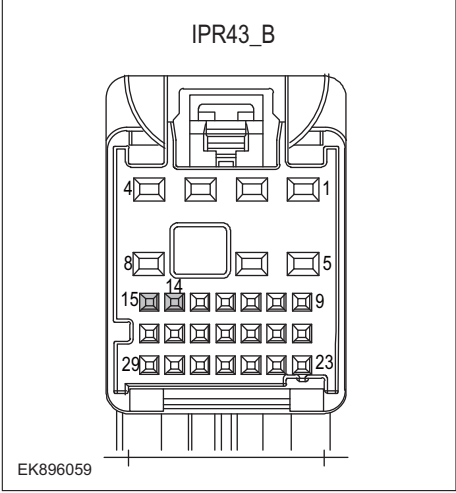
Steps4	Check the terminal resistance of GWM and FICM.
<div style="text-align: center;">  <p>FL02_A</p> <p>EK896058</p> </div> <div style="text-align: center; margin-top: 20px;">  <p>IPR43_B</p> <p>EK896059</p> </div>	<ol style="list-style-type: none"> 1 Turn the ignition switch to OFF. 2 Disconnect the GWM harness plug FL02_ A. 3 Measure the resistance between the GWM harness terminals. Measuring circuit: FL02_ The resistance between terminal 5 and terminal 15 of plug A. Standard value: 110~130 Ω 4 Connect GWM harness plug FL02_ A. 5 Disconnect the FICM harness plug IPR43_ B. 6 Measure the resistance between the FICM harness terminals. Measuring circuit: IPR43_ The resistance between terminal 14 and terminal 15 of plug B. Standard value: 110~130 Ω 7 Check whether the result is normal or not?
	<p>NO → Repair or replace the faulted parts.</p>
<p>YES ↓</p>	

Steps5	Test whether FICM is norm.
	<ol style="list-style-type: none"> 1 Turn the ignition switch to OFF. 2 Disconnect and check the harness plug IPR43_A, IPR43_B of FICM module. 3 Check and repair. <ul style="list-style-type: none"> • Corrosion (install new adapting piece or terminal-cleaning module and pin). • Pin damaged or bent - install new terminal/pin. • Fly out of pins - install new pins as needed. 4 Reconnect the FICM plug and all other previously disconnected plug. Make sure the pin is properly positioned and fixed. 5 Run the system and determine if the problem persists?
	YES → Change the FICM Module
NO ↓	
At this point the system is functioning normally. The problem may be caused by module connections. Address the root cause of any connector or pin problems.	
Next Step ↓	
Diagnosis end.	

U0255-87

Fault diagnosis code
U0255-87: Lost communication with IPK
Detection tools
1 Multimeter and diagnostic apparatus
Possible causes
<ul style="list-style-type: none"> • Circuit, terminal and adapting piece • FICM • GWM
Conditions for fault code operation
Turn the ignition switch to the ON position
Conditions for fault code setting
U0255-87
With ICU_ IPK_ 6F1h message lost communication for at least 5000 milliseconds
To set the effect of a fault code condition
Description of circuit diagram
<p>The device is connected to the serial data circuit and monitors the serial data communication during normal vehicle operation. Devices exchange operational information and instructions with each other. The device has programming information that needs to be exchanged on the serial data circuit. The receiver device also monitors this information; In addition, some regular information is used to indicate the availability of the transmitter device.</p>

Circuit diagram

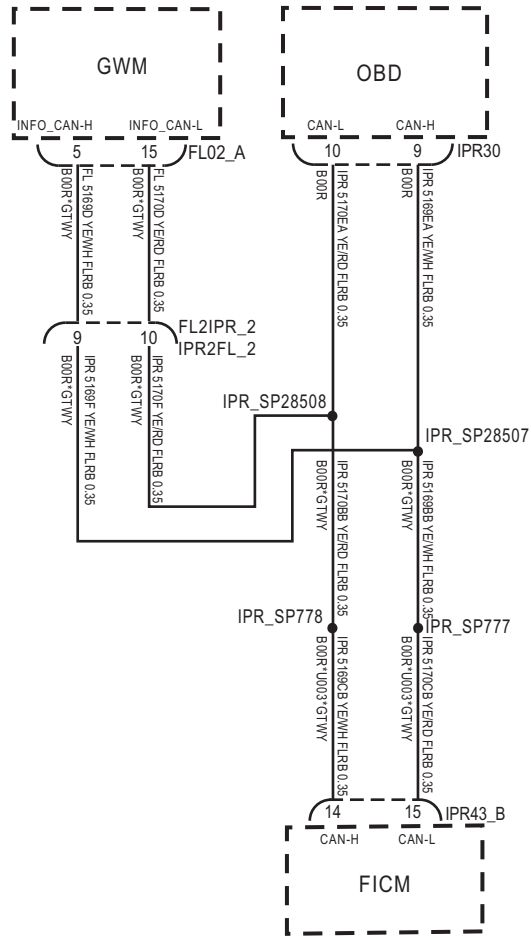

IPR43_B

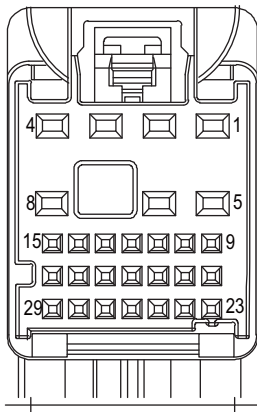

EK896056

FL02_A

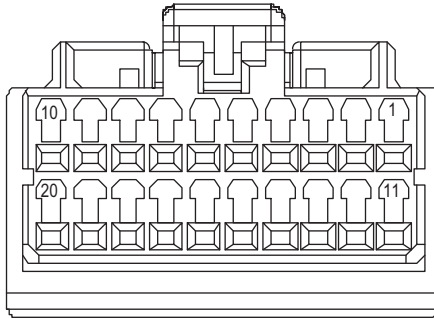

IPR30

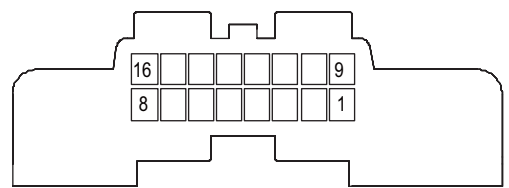

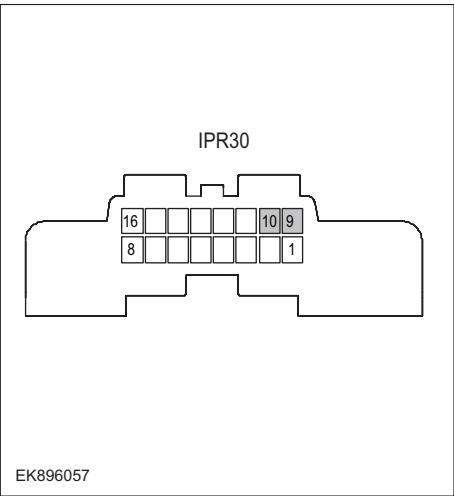
Troubleshooting steps	
Steps1	General inspection.
	<ol style="list-style-type: none"> 1 Check if the Insurance fuse is damaged. 2 Check battery capacity. 3 Check the GWM harness plug for damage, poor contact, aging, and looseness. 4 Check whether the result is normal or not?
NO → Repair or replace the faulted parts.	
YES ↓	
Steps2	Check fault codes.
	<ol style="list-style-type: none"> 1 Connect the fault diagnosis instrument to the diagnosis interface. 2 Turn the ignition switch to ON position. 3 Diagnose the GWM with diagnostic apparatus. 4 If there is any fault code except for U0255-87?
YES → Refer to: DTC Summary List (FICM)-Right .	
NO ↓	
Steps3	Check the integrity of the CAN communication network.
	<ol style="list-style-type: none"> 1 Turn the ignition switch to OFF. 2 Measure the resistance between the diagnostic interface harness terminals. Measuring circuit: The resistance between terminal 9 and terminal 10 of the IPR30 plug. Standard value: $\approx 60 \Omega$ 3 Check whether the result is normal or not?
NO → Repair or replace the faulted parts.	
YES ↓	

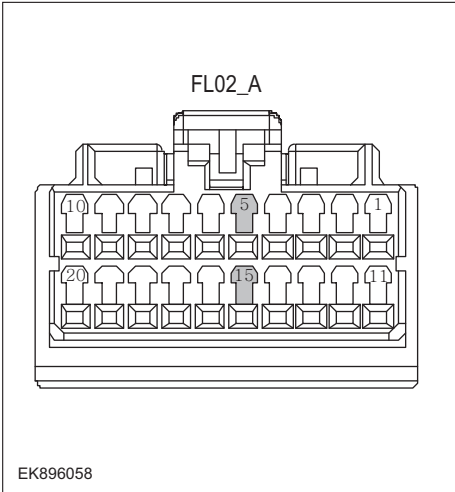
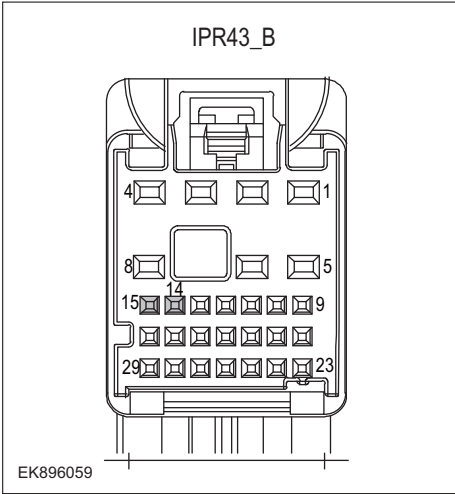
<p>Steps4</p>	<p>Check the terminal resistance of GWM and FICM.</p>
<div style="text-align: center;">  <p>FL02_A</p> <p>EK896058</p> </div> <div style="text-align: center; margin-top: 20px;">  <p>IPR43_B</p> <p>EK896059</p> </div>	<ol style="list-style-type: none"> 1 Turn the ignition switch to OFF. 2 Disconnect the GWM harness plug FL02_ A. 3 Measure the resistance between the GWM harness terminals. Measuring circuit: FL02_ The resistance between terminal 5 and terminal 15 of plug A. Standard value: 110~130 Ω 4 Connect GWM harness plug FL02_ A. 5 Disconnect the FICM harness plug IPR43_ B. 6 Measure the resistance between the FICM harness terminals. Measuring circuit: IPR43_ The resistance between terminal 14 and terminal 15 of plug B. Standard value: 110~130 Ω 7 Check whether the result is normal or not?
<p>YES ↓</p>	<p>NO → Repair or replace the faulted parts.</p>

FICM

Steps5	Test whether FICM is norm.
	<ol style="list-style-type: none"> 1 Turn the ignition switch to OFF. 2 Disconnect and check the harness plug IPR43_A, IPR43_B of FICM module. 3 Check and repair. <ul style="list-style-type: none"> • Corrosion(install new adapting piece or terminal-cleaning module and pin). • Pin damaged or bent-install new terminal/pin. • Fly out of pins-install new pins as needed. 4 Reconnect the FICM plug and all other previously disconnected plug. Make sure the pin is properly positioned and fixed. 5 Run the system and determine if the problem persists?
	YES → Change the FICM Module
NO ↓	
At this point the system is functioning normally. The problem may be caused by module connections. Address the root cause of any connector or pin problems.	
Next Step ↓	
Diagnosis end.	

U0257-87

Fault diagnosis code
U0257-87: Lost communication with HVAC
Detection tools
1 Multimeter and diagnostic apparatus
Possible causes
<ul style="list-style-type: none"> • Circuit, terminal and adapting piece • FICM • GWM
Conditions for fault code operation
Turn the ignition switch to the ON position
Conditions for fault code setting
U0257-87
With iCGM_ HVAC_ 510h message lost communication for at least 250 milliseconds
To set the effect of a fault code condition
Description of circuit diagram
The device is connected to the serial data circuit and monitors the serial data communication during normal vehicle operation. Devices exchange operational information and instructions with each other. The device has programming information that needs to be exchanged on the serial data circuit. The receiver device also monitors this information; In addition, some regular information is used to indicate the availability of the transmitter device.

Circuit diagram

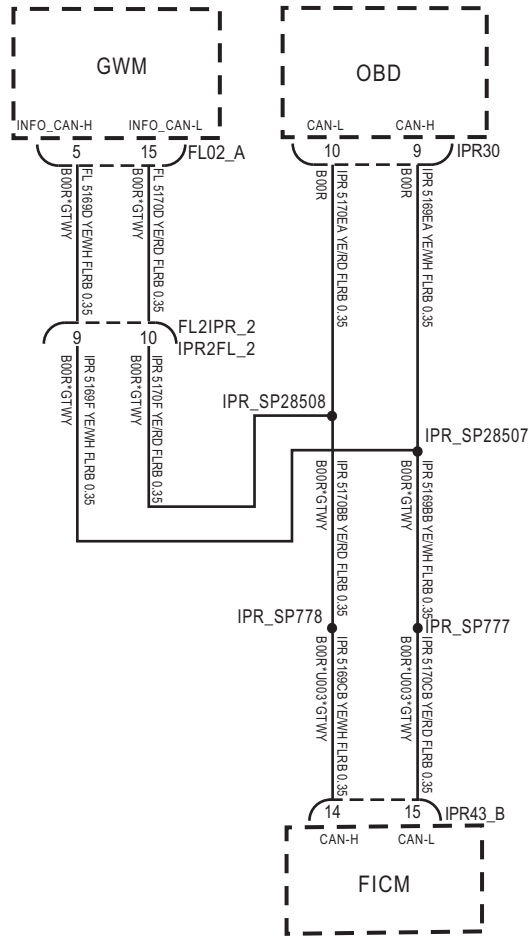

IPR43_B

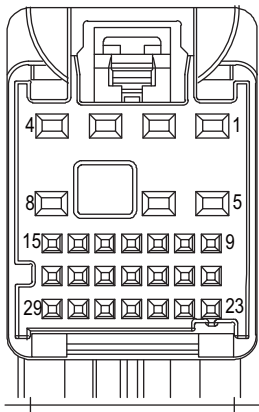

EK896056

FL02_A

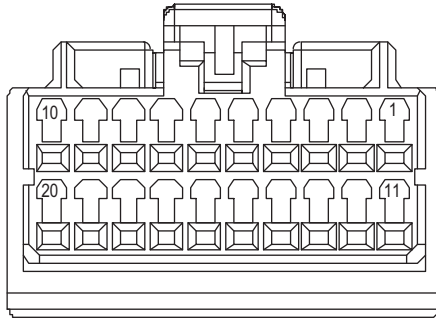

IPR30

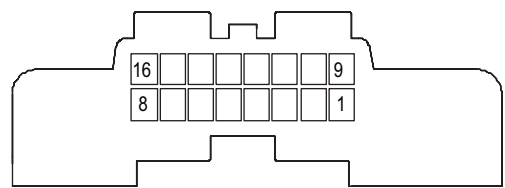

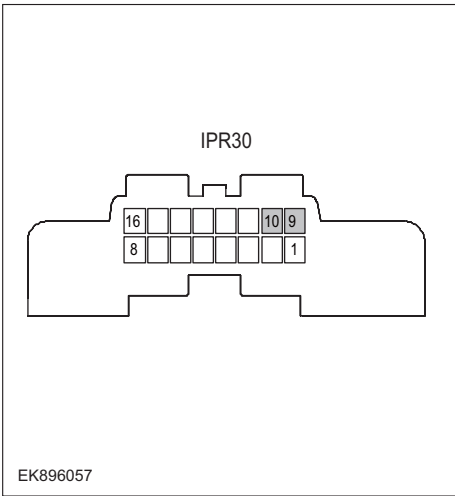
Troubleshooting steps	
Steps1	General inspection.
	<ol style="list-style-type: none"> 1 Check if the Insurance fuse is damaged. 2 Check battery capacity. 3 Check the GWM harness plug for damage, poor contact, aging, and looseness. 4 Check whether the result is normal or not?
	NO → Repair or replace the faulted parts.
YES ↓	
Steps2	Check fault codes.
	<ol style="list-style-type: none"> 1 Connect the fault diagnosis instrument to the diagnosis interface. 2 Turn the ignition switch to ON position. 3 Diagnose the GWM with diagnostic apparatus. 4 If there is any fault code except for U0257-87?
	YES → Refer to: DTC Summary List (FICM)-Right .
NO ↓	
Steps3	Check the integrity of the CAN communication network.
 <p style="text-align: center;">IPR30</p> <p style="text-align: left; margin-left: 10px;">EK896057</p>	<ol style="list-style-type: none"> 1 Turn the ignition switch to OFF. 2 Measure the resistance between the diagnostic interface harness terminals. Measuring circuit: The resistance between terminal 9 and terminal 10 of the IPR30 plug. Standard value: ≈ 60 Ω 3 Check whether the result is normal or not?
	NO → Repair or replace the faulted parts.
YES ↓	

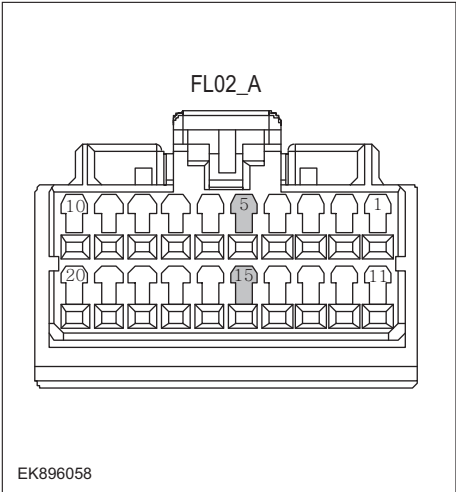
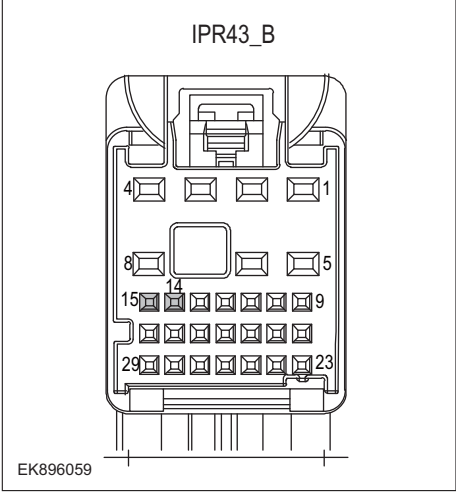
Steps4	Check the terminal resistance of GWM and FICM.
<div style="text-align: center;">  <p>FL02_A</p> <p>EK896058</p> </div> <div style="text-align: center; margin-top: 20px;">  <p>IPR43_B</p> <p>EK896059</p> </div>	<ol style="list-style-type: none"> 1 Turn the ignition switch to OFF. 2 Disconnect the GWM harness plug FL02_ A. 3 Measure the resistance between the GWM harness terminals. Measuring circuit: FL02_ The resistance between terminal 5 and terminal 15 of plug A. Standard value: 110~130 Ω 4 Connect GWM harness plug FL02_ A. 5 Disconnect the FICM harness plug IPR43_ B. 6 Measure the resistance between the FICM harness terminals. Measuring circuit: IPR43_ The resistance between terminal 14 and terminal 15 of plug B. Standard value: 110~130 Ω 7 Check whether the result is normal or not?
	<p>NO → Repair or replace the faulted parts.</p>
<p>YES ↓</p>	

Steps5	Test whether FICM is norm.
	<ol style="list-style-type: none"> 1 Turn the ignition switch to OFF. 2 Disconnect and check the harness plug IPR43_A, IPR43_B of FICM module. 3 Check and repair. <ul style="list-style-type: none"> • Corrosion(install new adapting piece or terminal-cleaning module and pin). • Pin damaged or bent-install new terminal/pin. • Fly out of pins-install new pins as needed. 4 Reconnect the FICM plug and all other previously disconnected plug. Make sure the pin is properly positioned and fixed. 5 Run the system and determine if the problem persists?
	YES → Change the FICM Module
NO ↓	
At this point the system is functioning normally. The problem may be caused by module connections. Address the root cause of any connector or pin problems.	
Next Step ↓	
Diagnosis end.	

U0266-87

Fault diagnosis code
U0266-87: Lost communication with LDW
Detection tools
1 Multimeter and diagnostic apparatus
Possible causes
<ul style="list-style-type: none"> • Circuit, terminal and adapting piece • FICM • GWM
Conditions for fault code operation
Turn the ignition switch to the ON position
Conditions for fault code setting
U0266-87
With iCGM_ LDW_ 3F2h message lost communication for at least 1000 milliseconds
To set the effect of a fault code condition
Description of circuit diagram
<p>The device is connected to the serial data circuit and monitors the serial data communication during normal vehicle operation. Devices exchange operational information and instructions with each other. The device has programming information that needs to be exchanged on the serial data circuit. The receiver device also monitors this information; In addition, some regular information is used to indicate the availability of the transmitter device.</p>

Circuit diagram

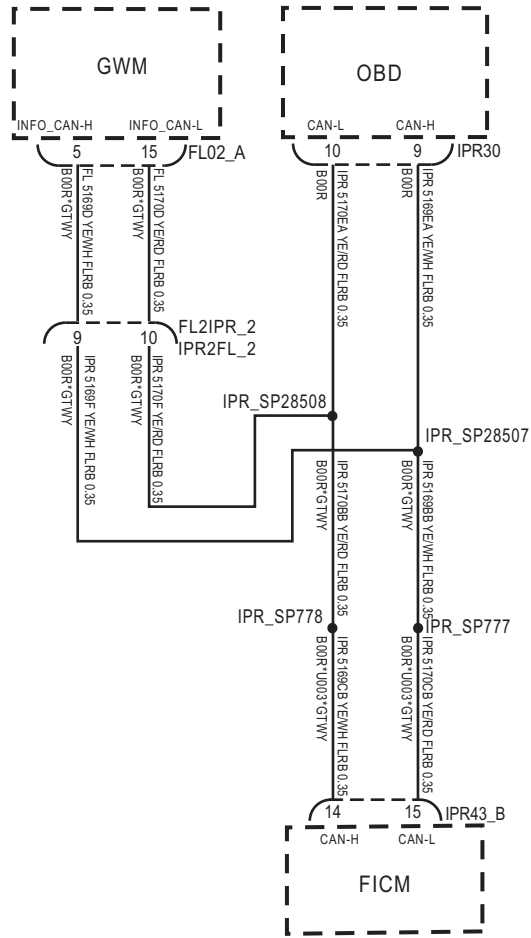

IPR43_B

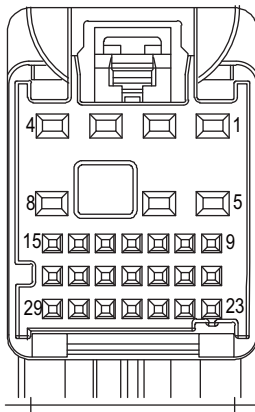

EK896056

FL02_A

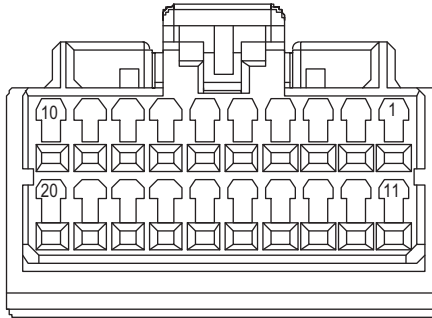

IPR30

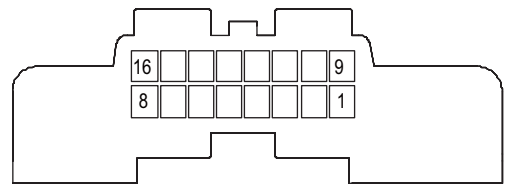

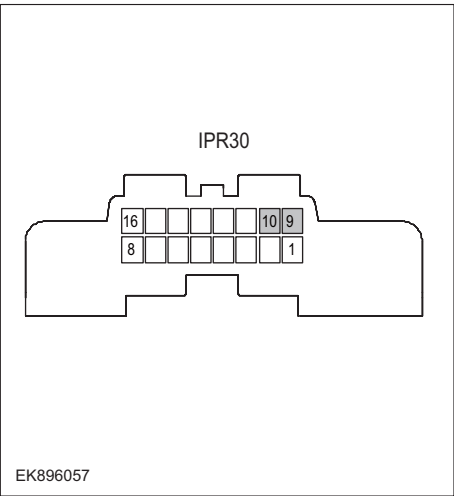
Troubleshooting steps	
Steps1	General inspection.
	<ol style="list-style-type: none"> 1 Check if the Insurance fuse is damaged. 2 Check battery capacity. 3 Check the GWM harness plug for damage, poor contact, aging, and looseness. 4 Check whether the result is normal or not?
NO → Repair or replace the faulted parts.	
YES ↓	
Steps2	Check fault codes.
	<ol style="list-style-type: none"> 1 Connect the fault diagnosis instrument to the diagnosis interface. 2 Turn the ignition switch to ON position. 3 Diagnose the GWM with diagnostic apparatus. 4 If there is any fault code except for U0266-87?
YES → Refer to: DTC Summary List (FICM)-Right .	
NO ↓	
Steps3	Check the integrity of the CAN communication network.
	<ol style="list-style-type: none"> 1 Turn the ignition switch to OFF. 2 Measure the resistance between the diagnostic interface harness terminals. Measuring circuit: The resistance between terminal 9 and terminal 10 of the IPR30 plug. Standard value: $\approx 60 \Omega$ 3 Check whether the result is normal or not?
NO → Repair or replace the faulted parts.	
YES ↓	

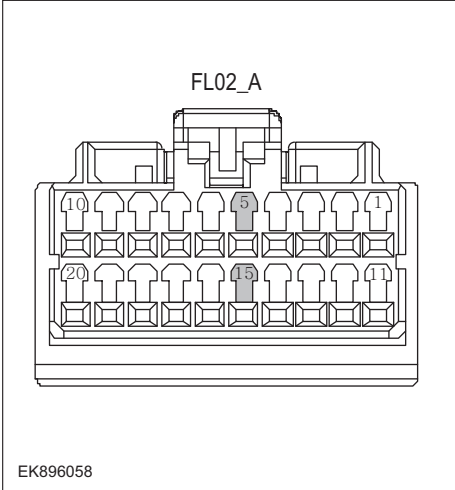
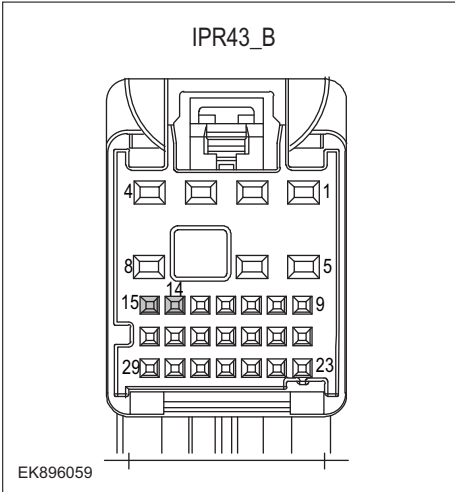
<p>Steps4</p>	<p>Check the terminal resistance of GWM and FICM.</p>
<div style="text-align: center;">  <p>FL02_A</p> <p>EK896058</p> </div> <div style="text-align: center; margin-top: 20px;">  <p>IPR43_B</p> <p>EK896059</p> </div>	<ol style="list-style-type: none"> 1 Turn the ignition switch to OFF. 2 Disconnect the GWM harness plug FL02_ A. 3 Measure the resistance between the GWM harness terminals. Measuring circuit: FL02_ The resistance between terminal 5 and terminal 15 of plug A. Standard value: 110~130 Ω 4 Connect GWM harness plug FL02_ A. 5 Disconnect the FICM harness plug IPR43_ B. 6 Measure the resistance between the FICM harness terminals. Measuring circuit: IPR43_ The resistance between terminal 14 and terminal 15 of plug B. Standard value: 110~130 Ω 7 Check whether the result is normal or not?
<p>YES ↓</p>	<p>NO → Repair or replace the faulted parts.</p>

FICM

Steps5	Test whether FICM is norm.
	<ol style="list-style-type: none">1 Turn the ignition switch to OFF.2 Disconnect and check the harness plug IPR43_A, IPR43_B of FICM module.3 Check and repair.<ul style="list-style-type: none">• Corrosion(install new adapting piece or terminal-cleaning module and pin).• Pin damaged or bent-install new terminal/pin.• Fly out of pins-install new pins as needed.4 Reconnect the FICM plug and all other previously disconnected plug. Make sure the pin is properly positioned and fixed.5 Run the system and determine if the problem persists?
	YES → Change the FICM Module
NO ↓	
At this point the system is functioning normally. The problem may be caused by module connections. Address the root cause of any connector or pin problems.	
Next Step ↓	
Diagnosis end.	

U0267-87

Fault diagnosis code
U0267-87: Lost communication with BSD
Detection tools
1 Multimeter and diagnostic apparatus
Possible causes
<ul style="list-style-type: none"> • Circuit, terminal and adapting piece • FICM • GWM
Conditions for fault code operation
Turn the ignition switch to the ON position
Conditions for fault code setting
U0267-87
With iCGM_ BSD_ 516h message lost communication for at least 2000 milliseconds
To set the effect of a fault code condition
Description of circuit diagram
The device is connected to the serial data circuit and monitors the serial data communication during normal vehicle operation. Devices exchange operational information and instructions with each other. The device has programming information that needs to be exchanged on the serial data circuit. The receiver device also monitors this information; In addition, some regular information is used to indicate the availability of the transmitter device.

Circuit diagram

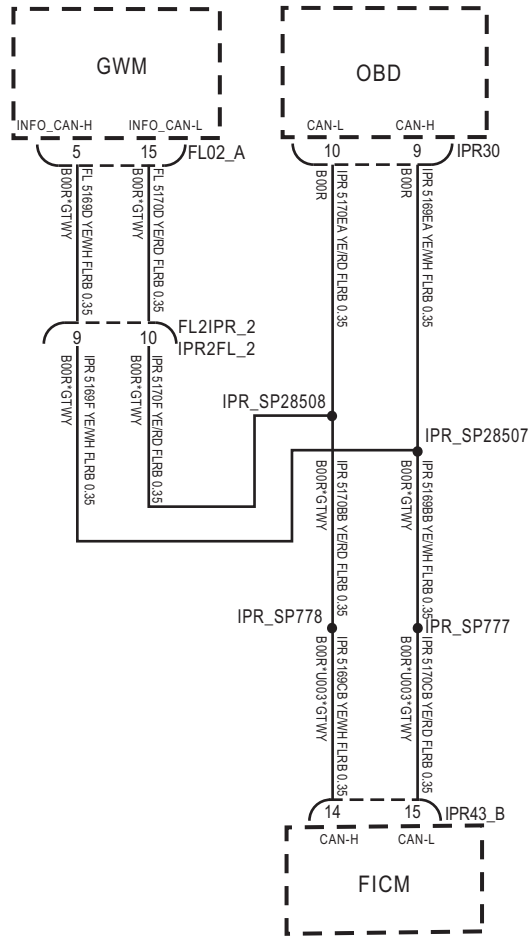

IPR43_B

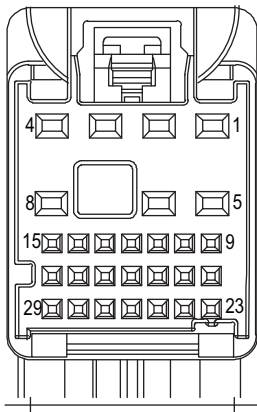

EK896056

FL02_A

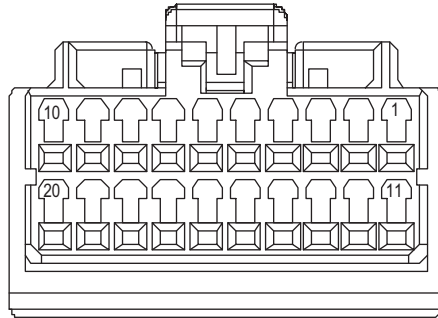

IPR30

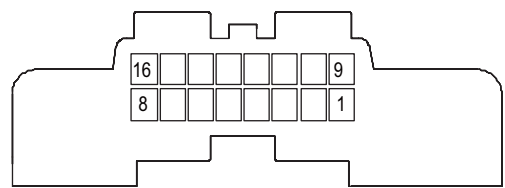

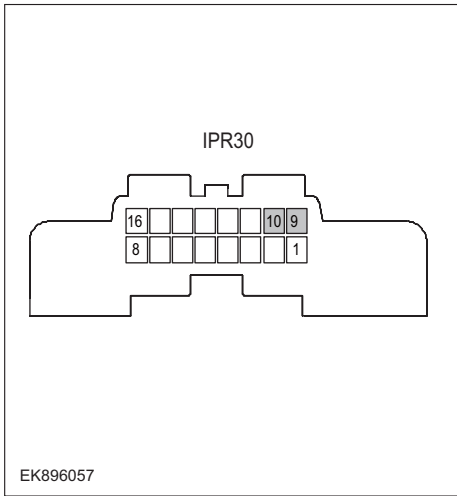
Troubleshooting steps	
Steps1	General inspection.
	<ol style="list-style-type: none"> 1 Check if the Insurance fuse is damaged. 2 Check battery capacity. 3 Check the GWM harness plug for damage, poor contact, aging, and looseness. 4 Check whether the result is normal or not?
	NO → Repair or replace the faulted parts.
YES ↓	
Steps2	Check fault codes.
	<ol style="list-style-type: none"> 1 Connect the fault diagnosis instrument to the diagnosis interface. 2 Turn the ignition switch to ON position. 3 Diagnose the GWM with diagnostic apparatus. 4 If there is any fault code except for U0267-87?
	YES → Refer to: DTC Summary List (FICM)-Right .
NO ↓	
Steps3	Check the integrity of the CAN communication network.
 <p style="text-align: center;">IPR30</p> <p style="text-align: center;">EK896057</p>	<ol style="list-style-type: none"> 1 Turn the ignition switch to OFF. 2 Measure the resistance between the diagnostic interface harness terminals. Measuring circuit: The resistance between terminal 9 and terminal 10 of the IPR30 plug. Standard value: ≈ 60 Ω 3 Check whether the result is normal or not?
	NO → Repair or replace the faulted parts.
YES ↓	

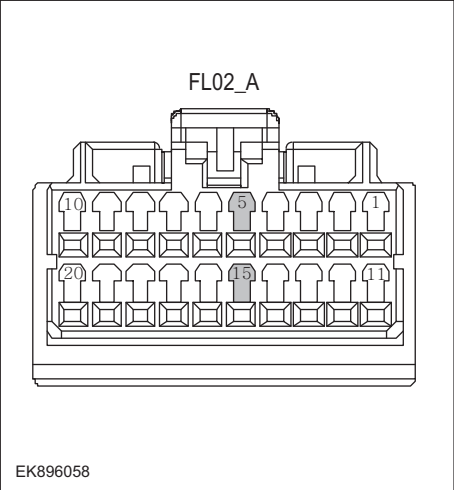
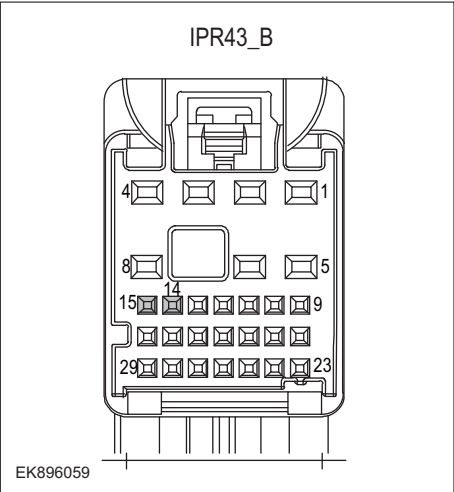
Steps4	Check the terminal resistance of GWM and FICM.
<div style="text-align: center;">  <p>FL02_A</p> <p>EK896058</p> </div> <div style="text-align: center; margin-top: 20px;">  <p>IPR43_B</p> <p>EK896059</p> </div>	<ol style="list-style-type: none"> 1 Turn the ignition switch to OFF. 2 Disconnect the GWM harness plug FL02_ A. 3 Measure the resistance between the GWM harness terminals. Measuring circuit: FL02_ The resistance between terminal 5 and terminal 15 of plug A. Standard value: 110~130 Ω 4 Connect GWM harness plug FL02_ A. 5 Disconnect the FICM harness plug IPR43_ B. 6 Measure the resistance between the FICM harness terminals. Measuring circuit: IPR43_ The resistance between terminal 14 and terminal 15 of plug B. Standard value: 110~130 Ω 7 Check whether the result is normal or not?
	<p>NO → Repair or replace the faulted parts.</p>
<p>YES ↓</p>	

Steps5	Test whether FICM is norm.
	<ol style="list-style-type: none"> 1 Turn the ignition switch to OFF. 2 Disconnect and check the harness plug IPR43_A, IPR43_B of FICM module. 3 Check and repair. <ul style="list-style-type: none"> • Corrosion (install new adapting piece or terminal-cleaning module and pin). • Pin damaged or bent - install new terminal/pin. • Fly out of pins - install new pins as needed. 4 Reconnect the FICM plug and all other previously disconnected plug. Make sure the pin is properly positioned and fixed. 5 Run the system and determine if the problem persists?
	YES → Change the FICM Module
NO ↓	
At this point the system is functioning normally. The problem may be caused by module connections. Address the root cause of any connector or pin problems.	
Next Step ↓	
Diagnosis end.	

DTC Summary list (GWM)

DTC	English descriptions	Reference page
U1562-17	Battery voltage is too high	U1562-17 , U1563-16
U1563-16	Battery voltage is too low	
U0073-88	Control Module Communication Bus Off on PT(Power) CAN	U0073-88
U0074-88	Control Module Communication Bus Off on CH(Chassis) CAN	U0074-88
U0075-88	Control Module Communication Bus Off on BD(Body) CAN	U0075-88
U0076-88	Control Module Communication Bus Off on Info CAN	U0076-88
U0140-87	Lost Communication With BCM	U0140-87
U0100-87	Lost Communication With BMS	U0100-87
U0101-87	Lost Communication With SCU	U0101-87
U0155-87	Lost Communication With IPK	U0155-87
U0151-87	Lost Communication With SAS	U0151-87
U0116-87	Lost Communication With HVAC	U0116-87
U0118-87	Lost Communication With VCU	U0118-87
U0119-87	Lost Communication With SRS	U0119-87
U0125-87	Lost Communication With FICM	U0125-87
U0126-87	Lost Communication With ABS	U0126-87
U0132-87	Lost Communication With MCU	U0132-87
U0133-87	Lost Communication With EPS	U0133-87
U2001-41	ECU EEPROM Checksum Error	U2001-41 , U2002-42 , B162F-42
U2002-42	ECU RAM Error	
B162F-42	EEPROM(NVM) Error	

U1562-17、 U1563-16

Fault diagnosis code
U1562-17: Battery voltage is too high
U1563-16: Battery voltage is too low
Detection tools
1 Multimeter, diagnostic instrument
Possible causes
<ul style="list-style-type: none"> • Circuit,terminal and adapting piece fault • storage battery • GWM • Charging System • fuse
Conditions for fault code operation
Turn the ignition switch to ON position.
Conditions for fault code setting
U1562-17
U1563-16
To set the effect of a fault code condition
Description of circuit diagram
The GWM module will monitor whether all sensors and actuators are within normal range all the time. Meanwhile,it will check the connector for virtual connection, short circuit, open circuit and the connection rationality with other signals. When fault occurs, the GWM module will save the fault code corresponding to that fault and enable safety mode.

Circuit diagram

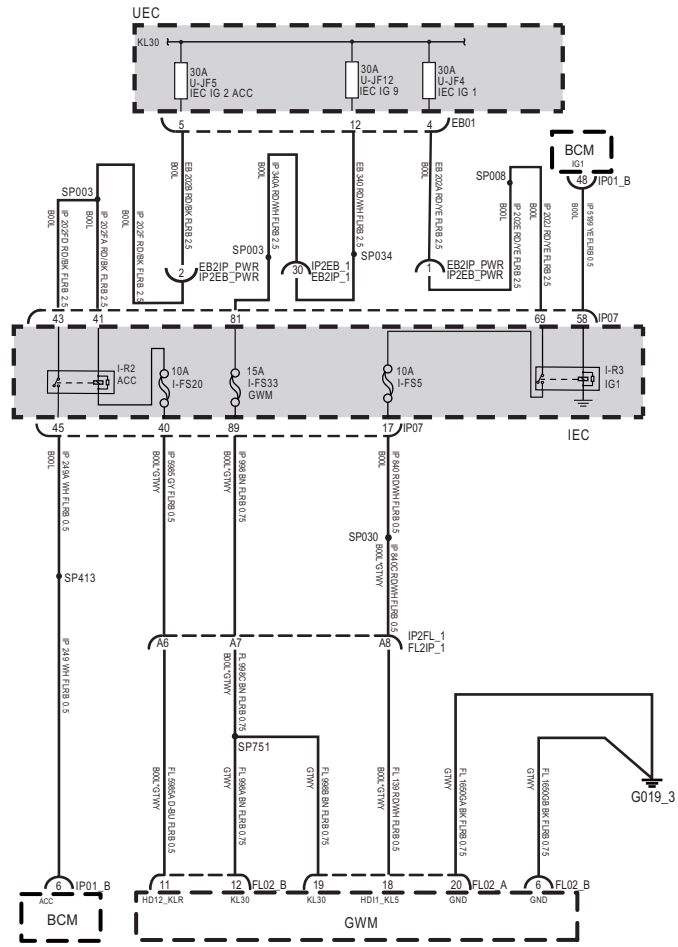

FL02_A

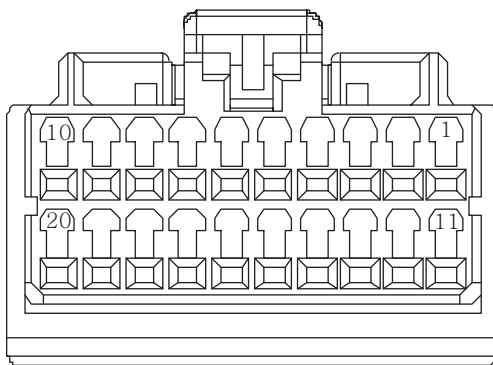

FL02_B

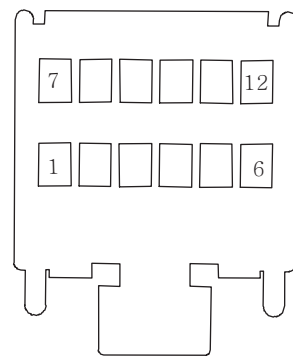

EK897001

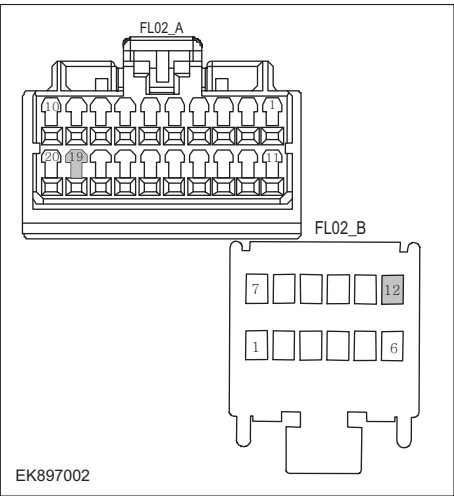
Troubleshooting steps	
Steps1	General inspection.
	<ol style="list-style-type: none"> 1 Check fuses U-JF5、 U-JF12、 U-JF4 for damage. 2 Check battery capacity. 3 Check the harness plug of GWM module for damage, poor contact, aging and looseness. 4 Check whether the result is normal or not?
NO → Repair or replace the faulted parts.	
YES ↓	
Steps2	Check fault codes.
	<ol style="list-style-type: none"> 1 Connect the fault diagnosis instrument to the diagnosis interface. 2 Turn the ignition switch to ON position.. 3 Diagnose the GWM module with diagnostic apparatus. 4 Is there any fault code other than U1562-17、 U1563-16?
YES → Refer to: DTC Summary list (GWM) .	
NO ↓	
Steps3	Check the battery of GWM .
	<ol style="list-style-type: none"> 1 Turn the ignition switch to OFF. 2 Disconnect the GWM harness plug FL02_ A、 FL02_ B. 3 Measure the voltage between the GWM harness terminal and ground. Measuring circuit: FL02_ The voltage between terminal 19 of plug A and the grounding. Measuring circuit: FL02_ The voltage between terminal 12 of plug B and the grounding. Standard value: 10-14V 4 Check whether the result is normal or not?
NO → Please repair the circuit.	
YES ↓	

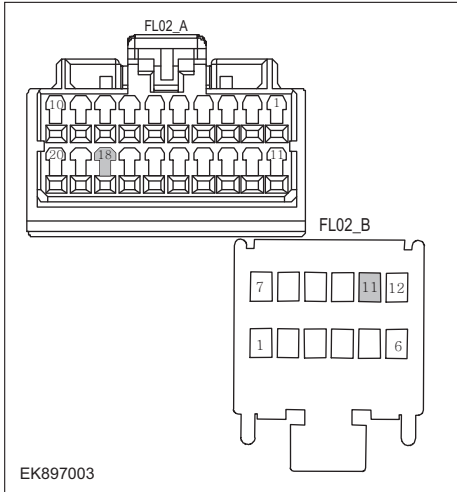
Steps4	Check the power supply voltage of GWM during startup or operation.
	<ol style="list-style-type: none"> 1 Turn on the ignition. 2 Measure the voltage between the GWM harness terminal and ground. Measuring circuit: FL02_ The voltage between terminal 11 of plug B and the grounding. Measuring circuit: FL02_ The voltage between terminal 18 of plug A and the grounding. Standard value: 10-14V 3 Check whether the result is normal or not?

NO → Please repair the circuit.

YES ↓

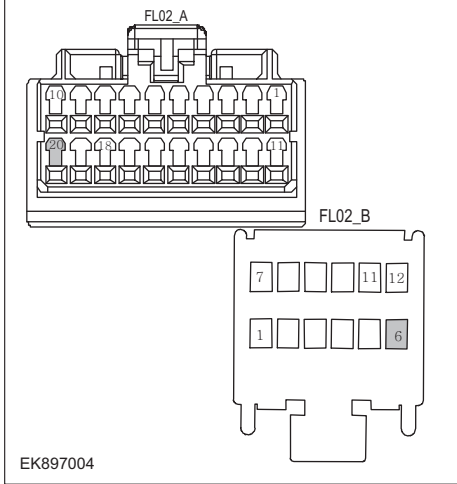
Steps5	Check the GWM ground circuit for an open.
	<ol style="list-style-type: none"> 1 Turn the ignition switch to OFF. 2 Disconnect the GWM harness plug FL02_ A、 FL02_ B. 3 Measure the resistance between the GWM harness plug and ground. Measuring circuit: FL02_ The resistance between terminal 20 of plug A and the grounding. Measuring circuit: FL02_ The resistance between terminal 6 of plug B and the grounding. Standard value:<1 Ω 4 Is the resistance less than 1 Ω?

NO → Please repair the circuit.

YES ↓

GWM

Steps6	Check if GWM is normal.
	<ol style="list-style-type: none"> 1 Turn the ignition switch to OFF. 2 Disconnect and inspect the GWM harness plug FL02_ A, FL02_ B. 3 Inspection and maintenance: <ul style="list-style-type: none"> • Corrosion (installing new connectors or terminals - cleaning module pins). • Damaged or bent pins - install new terminals/pins. • Pin flying - Install new pins as needed. 4 Reconnect the GWM plug and all other previously disconnected plugs. Ensure that the pin position and fixation are appropriate. 5 Run the system and determine if the problem still exists?
	YES → Replace GWM.
NO ↓	
At this point, the system is operating normally. The possible cause of the problem may be module connection. Address the root cause of any connector or pin issues.	
Next Step ↓	
Diagnosis completed.	

U0073-88

Fault diagnosis code
U0073-88: Control Module Communication Bus Off on PT(Power) CAN
Detection tools
1 Multimeter, diagnostic instrument
Possible causes
<ul style="list-style-type: none"> • Circuit,terminal and adapting piece fault • GWM
Conditions for fault code operation
Turn the ignition switch to ON position.
Conditions for fault code setting
U0073-88
To set the effect of a fault code condition
Description of circuit diagram
The device is connected to the serial data circuit and monitors the serial data communication during normal vehicle operation. Devices exchange operational information and instructions with each other. The device has programming information that needs to be exchanged on the serial data circuit. The receiver device also monitors this information; In addition, some regular information is used to indicate the availability of the transmitter device.

Circuit diagram

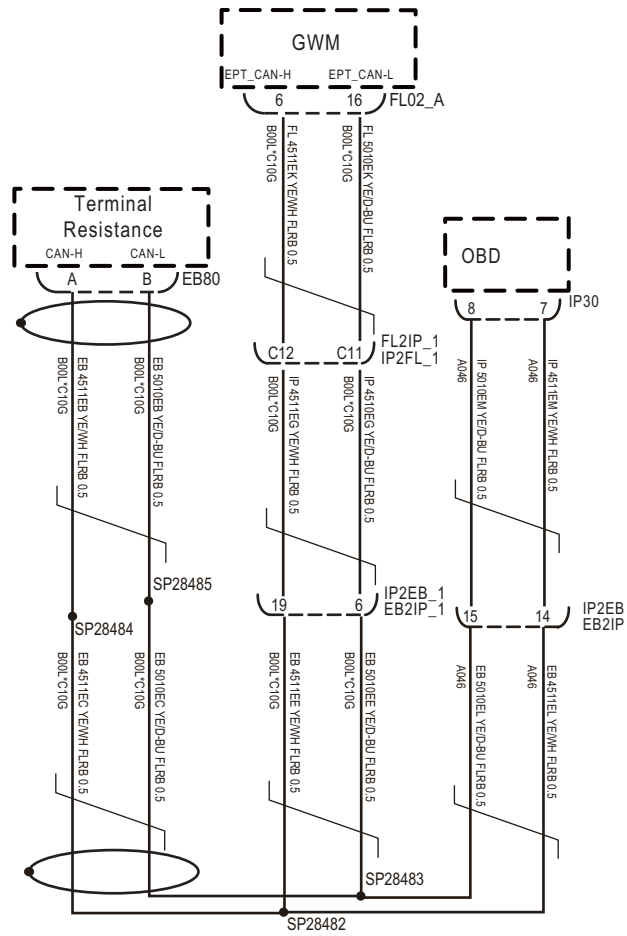

FL02_A

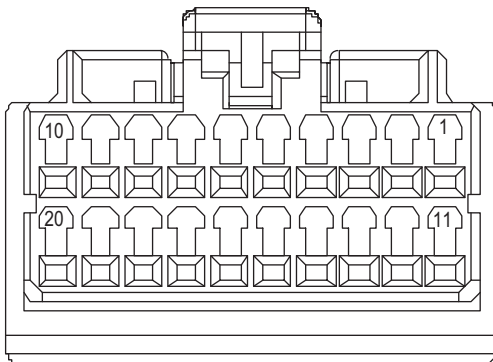

IP30

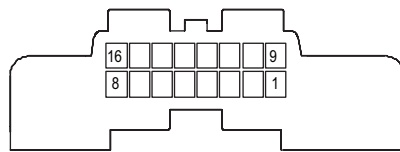

EB80

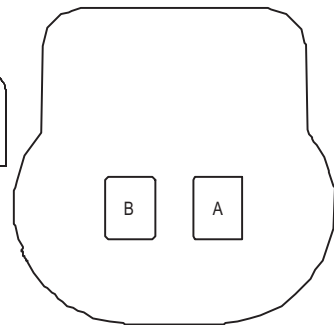

EK897005

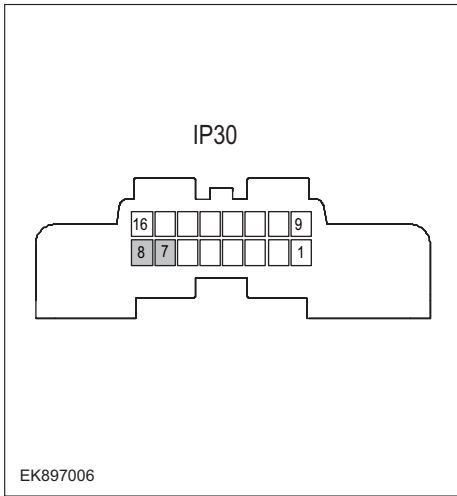
Troubleshooting steps	
Steps1	General inspection.
	<ol style="list-style-type: none"> 1 Check fuses for damage. 2 Check battery capacity. 3 Check the harness plug of GWM module for damage, poor contact, aging and looseness. 4 Check whether the result is normal or not?
	NO → Repair or replace the faulted parts.
YES ↓	
Steps2	Check fault codes.
	<ol style="list-style-type: none"> 1 Connect the fault diagnosis instrument to the diagnosis interface. 2 Turn the ignition switch to ON position.. 3 Diagnose the GWM module with diagnostic apparatus. 4 Is there any fault code other than U0073-88?
	YES → Refer to: DTC Summary list (GWM) .
NO ↓	
Steps3	Check the integrity of the CAN communication network.
	<ol style="list-style-type: none"> 1 Turn the ignition switch to OFF. 2 Measure the resistance between the diagnostic interface harness terminals. Measure the resistance between terminal 7 and terminal 8 of the IP30 plug. Standard value: $\approx 60 \Omega$ 3 Check whether the result is normal or not?
	NO → Repair or replace the faulted parts.
YES ↓	

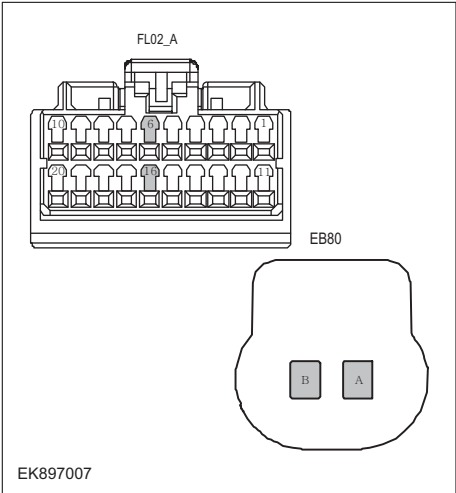
Steps4	Check the GWM and terminal resistance.
	<ol style="list-style-type: none"> 1 Turn the ignition switch to OFF. 2 Disconnect the GWM harness plug FL02_ A. 3 Measure the resistance between the GWM harness terminals. Measuring circuit FL02_ The resistance between terminal 6 and terminal 16 of plug A. Standard value: 110~130 Ω 4 Connect GWM harness plug FL02_ A. 5 Disconnect the terminal resistor harness plug EB80. 6 Measure the resistance between the terminals of the terminal resistance harness. Measuring circuit: The resistance between terminal A and terminal B of EB80 plug. Standard value: 110~130 Ω 7 Check whether the result is normal or not?
<p>NO → Repair or replace the faulted parts.</p>	
<p>YES ↓</p>	
Steps5	Check if GWM is normal.
	<ol style="list-style-type: none"> 1 Turn the ignition switch to OFF. 2 Disconnect and inspect the GWM harness plug FL02_ A. 3 Inspection and maintenance: <ul style="list-style-type: none"> • Corrosion (installing new connectors or terminals - cleaning module pins). • Damaged or bent pins - install new terminals/pins. • Pin flying - Install new pins as needed. 4 Reconnect the GWM plug and all other previously disconnected plugs. Ensure that the pin position and fixation are appropriate. 5 Run the system and determine if the problem still exists?
<p>YES → Replace GWM.</p>	
<p>NO ↓</p>	
<p>At this point, the system is operating normally. The possible cause of the problem may be module connection. Address the root cause of any connector or pin issues.</p>	
<p>Next Step ↓</p>	
<p>Diagnosis completed.</p>	

U0074-88

Fault diagnosis code
U0074-88: Control Module Communication Bus Off on CH(Chassis) CAN
Detection tools
1 Multimeter, diagnostic instrument
Possible causes
<ul style="list-style-type: none"> • Circuit,terminal and adapting piece fault • GWM
Conditions for fault code operation
Turn the ignition switch to ON position.
Conditions for fault code setting
U0074-88
To set the effect of a fault code condition
Description of circuit diagram
The device is connected to the serial data circuit and monitors the serial data communication during normal vehicle operation. Devices exchange operational information and instructions with each other. The device has programming information that needs to be exchanged on the serial data circuit. The receiver device also monitors this information; In addition, some regular information is used to indicate the availability of the transmitter device.

Circuit diagram

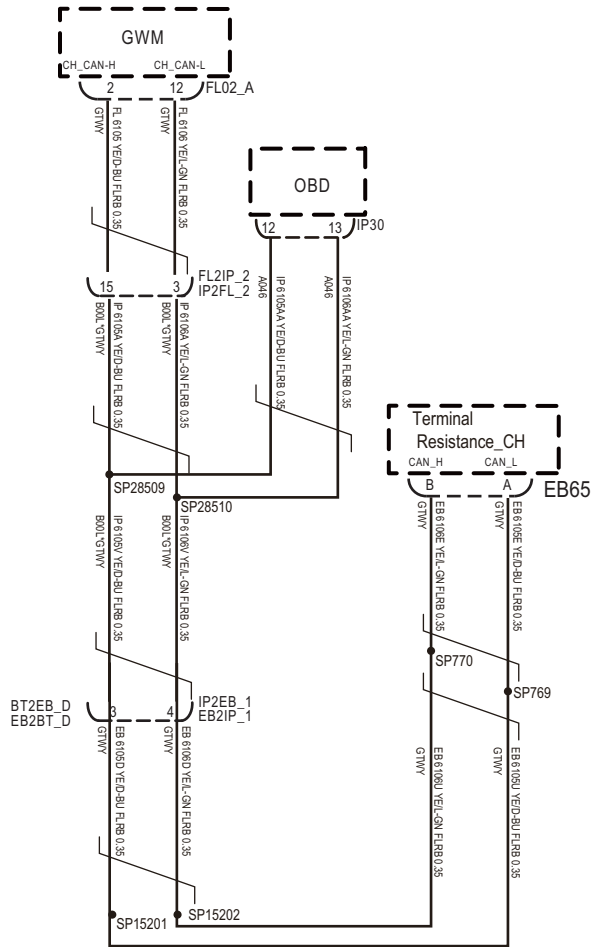

FL02_A

IP30

EB65

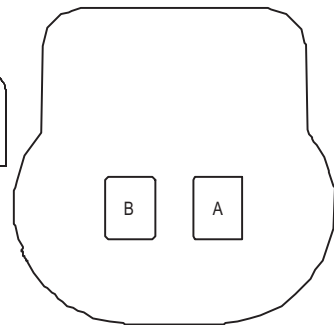
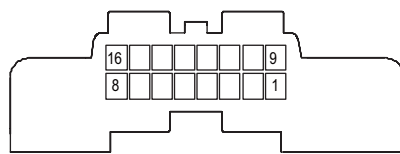
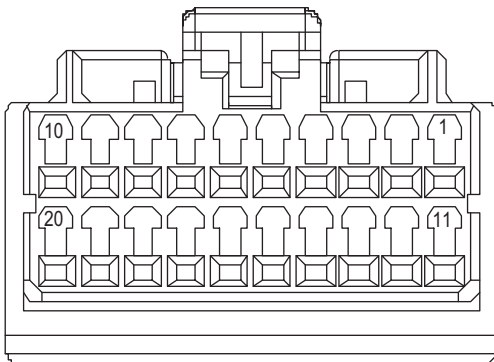

EK897008

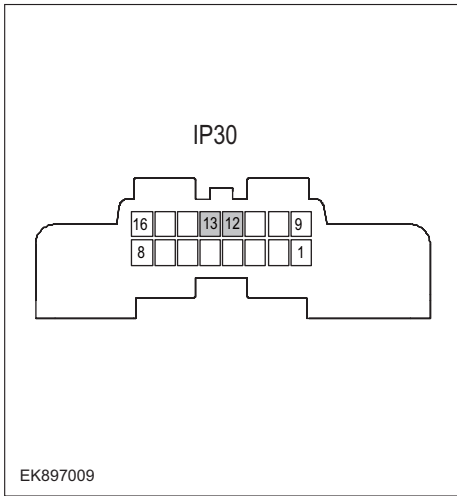
Troubleshooting steps	
Steps1	General inspection.
	<ol style="list-style-type: none"> 1 Check fuses for damage. 2 Check battery capacity. 3 Check the harness plug of GWM module for damage, poor contact, aging and looseness. 4 Check whether the result is normal or not?
	NO → Repair or replace the faulted parts.
YES ↓	
Steps2	Check fault codes.
	<ol style="list-style-type: none"> 1 Connect the fault diagnosis instrument to the diagnosis interface. 2 Turn the ignition switch to ON position.. 3 Diagnose the GWM module with diagnostic apparatus. 4 Is there any fault code other than U0074-88?
	YES → Refer to: DTC Summary list (GWM) .
NO ↓	
Steps3	Check the integrity of the CAN communication network.
	<ol style="list-style-type: none"> 1 Turn the ignition switch to OFF. 2 Measure the resistance between the diagnostic interface harness terminals. Measuring circuit: The resistance between terminal 12 and terminal 13 of IP30 plug. Standard value: $\approx 60 \Omega$ 3 Check whether the result is normal or not?
	NO → Repair or replace the faulted parts.
YES ↓	

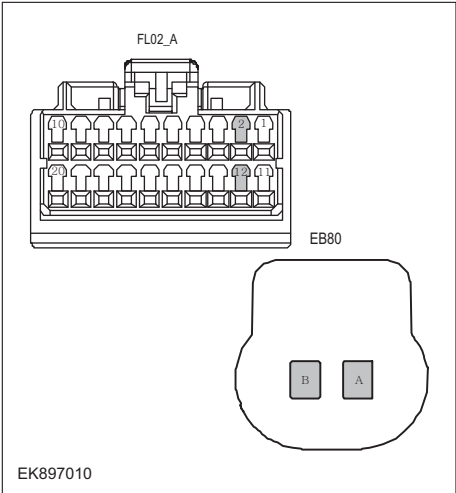
Steps4	Check the terminal resistance of the GWM and CH CAN resistors.
	<ol style="list-style-type: none"> 1 Turn the ignition switch to OFF. 2 Disconnect the GWM harness plug FL02_ A. 3 Measure the resistance between the GWM harness terminals. Measuring circuit FL02_ The resistance between terminal 2 and terminal 12 of plug A. Standard value: 110~130 Ω 4 Connect GWM harness plug FL02_ A. 5 Disconnect the CH CAN resistor harness plug EB65. 6 Measure the resistance between the CH CAN resistor harness terminals. Measuring circuit: The resistance between terminal A and terminal B of EB65 plug. Standard value: 110~130 Ω 7 Check whether the result is normal or not?
NO → Repair or replace the faulted parts.	
YES ↓	
Steps5	Check if GWM is normal.
	<ol style="list-style-type: none"> 1 Turn the ignition switch to OFF. 2 Disconnect and inspect the GWM harness plug FL02_ A. 3 Inspection and maintenance: <ul style="list-style-type: none"> • Corrosion (installing new connectors or terminals - cleaning module pins). • Damaged or bent pins - install new terminals/pins. • Pin flying - Install new pins as needed. 4 Reconnect the GWM plug and all other previously disconnected plugs. Ensure that the pin position and fixation are appropriate. 5 Run the system and determine if the problem still exists?
YES → Replace GWM.	
NO ↓	
At this point, the system is operating normally. The possible cause of the problem may be module connection. Address the root cause of any connector or pin issues.	
Next Step ↓	
Diagnosis completed.	

U0075-88

Fault diagnosis code
U0075-88: Control Module Communication Bus Off on BD(Body) CAN
Detection tools
1 Multimeter, diagnostic instrument
Possible causes
<ul style="list-style-type: none"> • Circuit,terminal and adapting piece fault • GWM
Conditions for fault code operation
Turn the ignition switch to ON position.
Conditions for fault code setting
U0075-88
To set the effect of a fault code condition
Description of circuit diagram
The device is connected to the serial data circuit and monitors the serial data communication during normal vehicle operation. Devices exchange operational information and instructions with each other. The device has programming information that needs to be exchanged on the serial data circuit. The receiver device also monitors this information; In addition, some regular information is used to indicate the availability of the transmitter device.

Circuit diagram

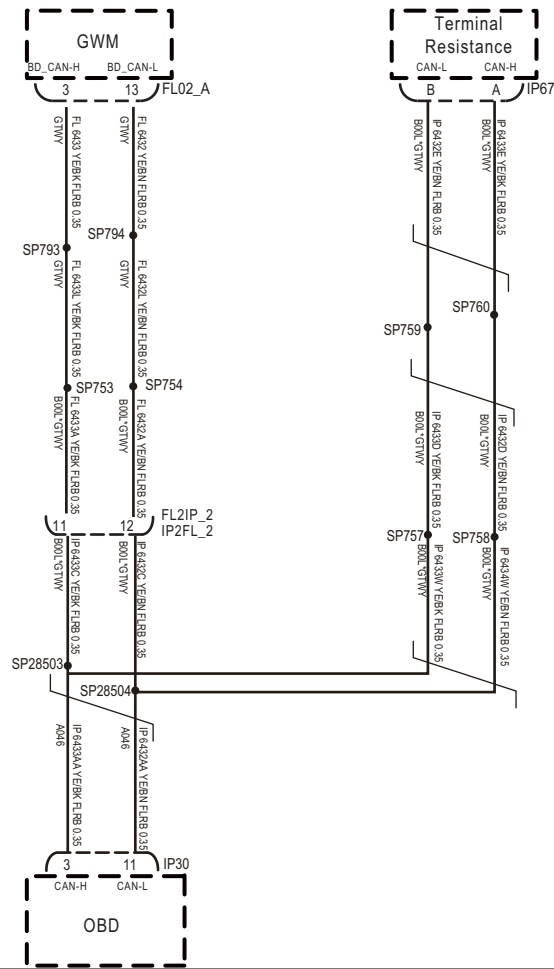

FL02_A

IP30

IP67

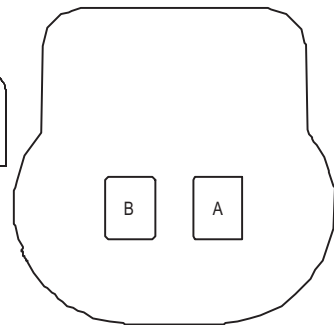
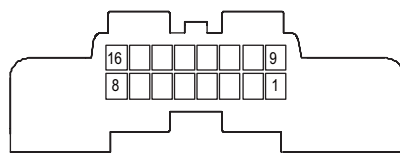
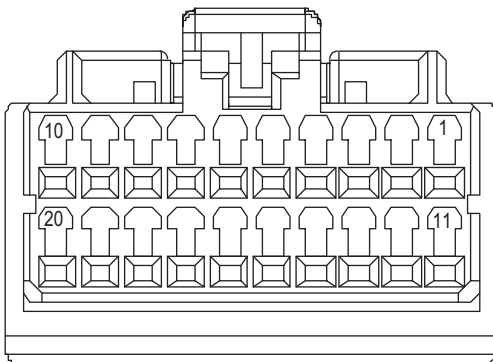

EK897011

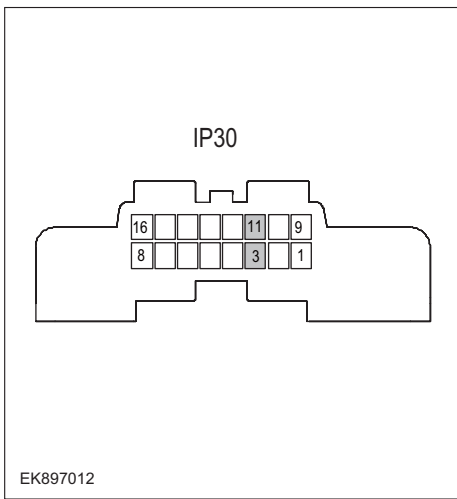
Troubleshooting steps	
Steps1	General inspection.
	<ol style="list-style-type: none"> 1 Check fuses for damage. 2 Check battery capacity. 3 Check the harness plug of GWM module for damage, poor contact, aging and looseness. 4 Check whether the result is normal or not?
	NO → Repair or replace the faulted parts.
YES ↓	
Steps2	Check fault codes.
	<ol style="list-style-type: none"> 1 Connect the fault diagnosis instrument to the diagnosis interface. 2 Turn the ignition switch to ON position.. 3 Diagnose the GWM module with diagnostic apparatus. 4 Is there any fault code other than U0075-88?
	YES → Refer to: DTC Summary list (GWM) .
NO ↓	
Steps3	Check the integrity of the CAN communication network.
	<ol style="list-style-type: none"> 1 Turn the ignition switch to OFF. 2 Measure the resistance between the diagnostic interface harness terminals. Measuring circuit: The resistance between terminal 3 and terminal 11 of IP30 plug. Standard value: $\approx 60 \Omega$ 3 Check whether the result is normal or not?
	NO → Repair or replace the faulted parts.
YES ↓	

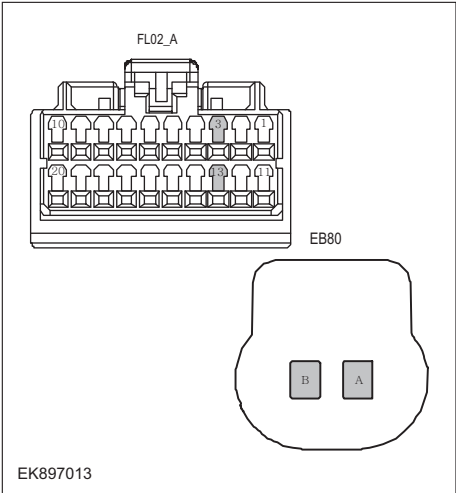
Steps4	Check the GWM and terminal resistor terminal resistance.
	<ol style="list-style-type: none"> 1 Turn the ignition switch to OFF. 2 Disconnect the GWM harness plug FL02_ A. 3 Measure the resistance between the GWM harness terminals. Measuring circuit: FL02_ The resistance between terminal 3 and terminal 13 of plug A. Standard value: 110~130 Ω 4 Connect GWM harness plug FL02_ A. 5 Disconnect the terminal resistor harness plug IP67. 6 Measure the resistance between the terminals of the terminal resistor harness. Measuring circuit: The resistance between terminal A and terminal B of IP67 plug. Standard value: 110~130 Ω 7 Check whether the result is normal or not?
<p>NO → Repair or replace the faulted parts.</p>	
<p>YES ↓</p>	
Steps5	Check if GWM is normal.
	<ol style="list-style-type: none"> 1 Turn the ignition switch to OFF. 2 Disconnect and inspect the GWM harness plug FL02_ A. 3 Inspection and maintenance: <ul style="list-style-type: none"> • Corrosion (installing new connectors or terminals - cleaning module pins). • Damaged or bent pins - install new terminals/pins. • Pin flying - Install new pins as needed. 4 Reconnect the GWM plug and all other previously disconnected plugs. Ensure that the pin position and fixation are appropriate. 5 Run the system and determine if the problem still exists?
<p>YES → Replace GWM.</p>	
<p>NO ↓</p>	
<p>At this point, the system is operating normally. The possible cause of the problem may be module connection. Address the root cause of any connector or pin issues.</p>	
<p>Next Step ↓</p>	
<p>Diagnosis completed.</p>	

U0076-88

Fault diagnosis code
U0076-88: Control Module Communication Bus Off on Info CAN
Detection tools
1 Multimeter, diagnostic instrument
Possible causes
<ul style="list-style-type: none"> • Circuit, terminal and adapting piece fault • GWM
Conditions for fault code operation
Turn the ignition switch to ON position.
Conditions for fault code setting
U0076-88
To set the effect of a fault code condition
Description of circuit diagram
<p>The device is connected to the serial data circuit and monitors the serial data communication during normal vehicle operation. Devices exchange operational information and instructions with each other. The device has programming information that needs to be exchanged on the serial data circuit. The receiver device also monitors this information; In addition, some regular information is used to indicate the availability of the transmitter device.</p>

Circuit diagram

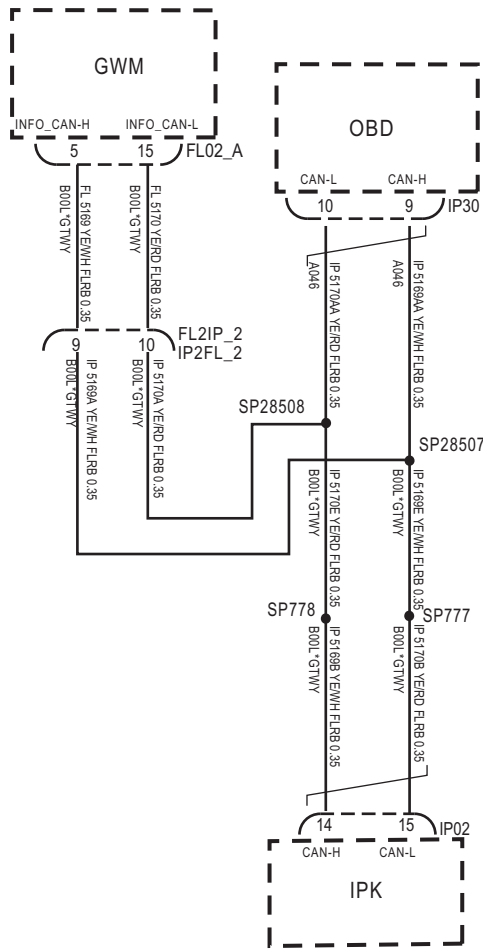

FL02_A

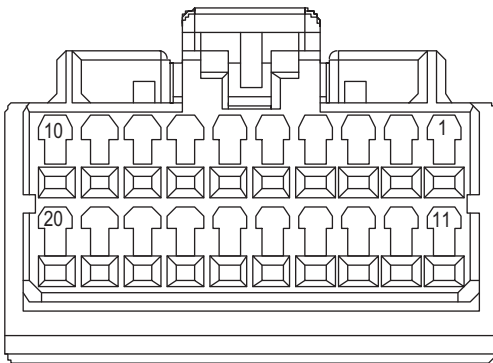

IP30

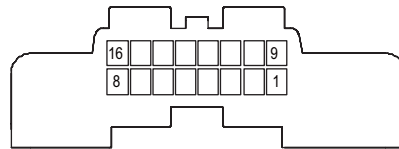

IP02

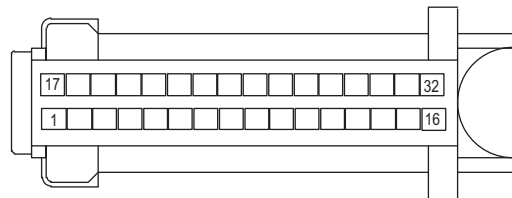

EK897014

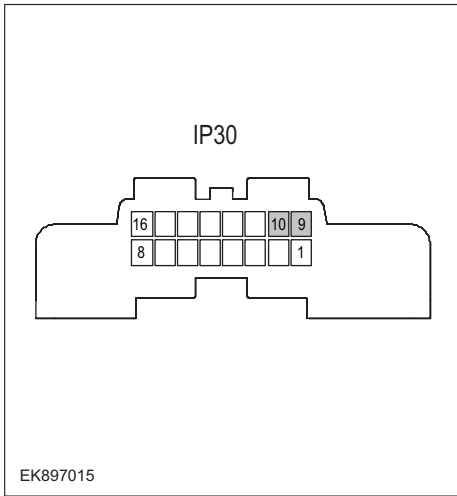
Troubleshooting steps	
Steps1	General inspection.
	<ol style="list-style-type: none"> 1 Check fuses for damage. 2 Check battery capacity. 3 Check the harness plug of GWM module for damage, poor contact, aging and looseness. 4 Check whether the result is normal or not?
	NO → Repair or replace the faulted parts.
YES ↓	
Steps2	Check fault codes.
	<ol style="list-style-type: none"> 1 Connect the fault diagnosis instrument to the diagnosis interface. 2 Turn the ignition switch to ON position.. 3 Diagnose the GWM module with diagnostic apparatus. 4 Is there any fault code other than U0076-88?
	YES → Refer to: DTC Summary list (GWM) .
NO ↓	
Steps3	Check the integrity of the CAN communication network.
	<ol style="list-style-type: none"> 1 Turn the ignition switch to OFF. 2 Measure the resistance between the diagnostic interface harness terminals. Measuring circuit: The resistance between terminal 9 and terminal 10 of IP30 plug. Standard value: $\approx 60 \Omega$ 3 Check whether the result is normal or not?
	NO → Repair or replace the faulted parts.
YES ↓	

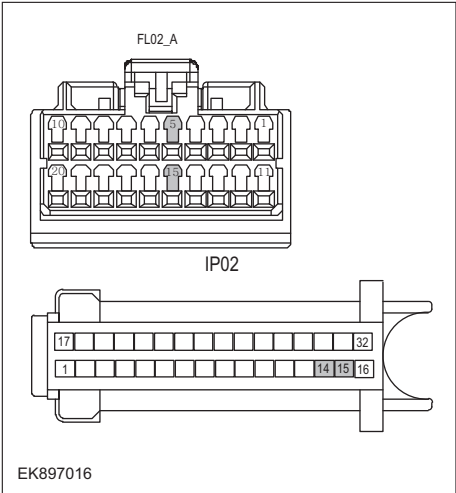
Steps4	Check the terminal resistance of GWM and combination instrument.
	<ol style="list-style-type: none"> 1 Turn the ignition switch to OFF. 2 Disconnect the GWM harness plug FL02_ A. 3 Measure the resistance between the GWM harness terminals. Measuring circuit: FL02_ The resistance between terminal 5 and terminal 15 of plug A. Standard value: 110~130 Ω 4 Connect GWM harness plug FL02_ A. 5 Disconnect the combination instrument harness plug IP02. 6 Measure the resistance between the harness terminals of the combination instrument. Measuring circuit: The resistance between terminal 14 and terminal 15 of IP02 plug. Standard value: 110~130 Ω 7 Check whether the result is normal or not?
NO → Repair or replace the faulted parts.	
YES ↓	
Steps5	Check if GWM is normal.
	<ol style="list-style-type: none"> 1 Turn the ignition switch to OFF. 2 Disconnect and inspect the GWM harness plug FL02_ A. 3 Inspection and maintenance: <ul style="list-style-type: none"> • Corrosion (installing new connectors or terminals - cleaning module pins). • Damaged or bent pins - install new terminals/pins. • Pin flying - Install new pins as needed. 4 Reconnect the GWM plug and all other previously disconnected plugs. Ensure that the pin position and fixation are appropriate. 5 Run the system and determine if the problem still exists?
YES → Replace GWM.	
NO ↓	
At this point, the system is operating normally. The possible cause of the problem may be module connection. Address the root cause of any connector or pin issues.	
Next Step ↓	
Diagnosis completed.	

U0140-87

Fault diagnosis code
U0140-87: Lost Communication With BCM
Detection tools
1 Multimeter, diagnostic instrument
Possible causes
<ul style="list-style-type: none"> • Circuit, terminal and adapting piece fault • GWM
Conditions for fault code operation
Turn the ignition switch to ON position.
Conditions for fault code setting
U0140-87
To set the effect of a fault code condition
Description of circuit diagram
<p>The device is connected to the serial data circuit and monitors the serial data communication during normal vehicle operation. Devices exchange operational information and instructions with each other. The device has programming information that needs to be exchanged on the serial data circuit. The receiver device also monitors this information; In addition, some regular information is used to indicate the availability of the transmitter device.</p>

Circuit diagram

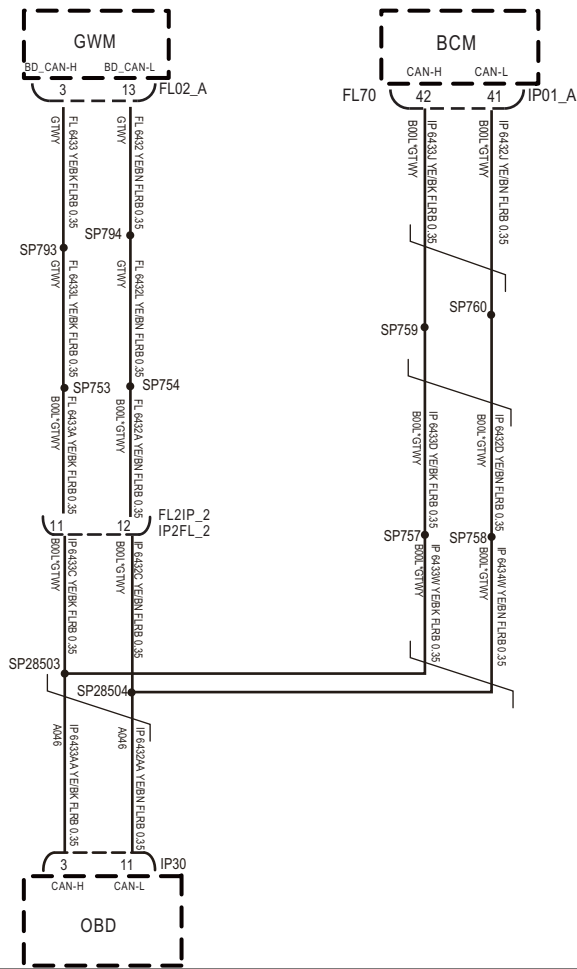

FL02_A

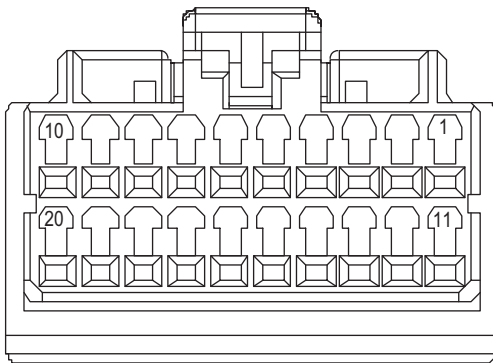

IP30

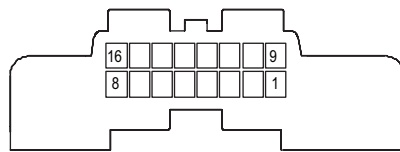

IP01_A

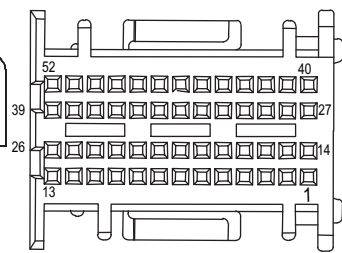

EK897017

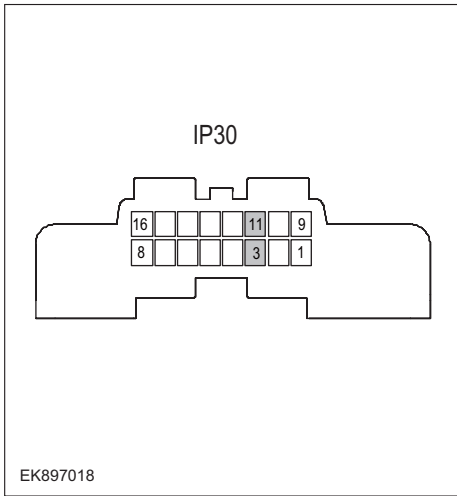
Troubleshooting steps	
Steps1	General inspection.
	<ol style="list-style-type: none"> 1 Check fuses for damage. 2 Check battery capacity. 3 Check the harness plug of GWM module for damage, poor contact, aging and looseness. 4 Check whether the result is normal or not?
	NO → Repair or replace the faulted parts.
YES ↓	
Steps2	Check fault codes.
	<ol style="list-style-type: none"> 1 Connect the fault diagnosis instrument to the diagnosis interface. 2 Turn the ignition switch to ON position.. 3 Diagnose the GWM module with diagnostic apparatus. 4 Is there any fault code other than U0140-87?
	YES → Refer to: DTC Summary list (GWM) .
NO ↓	
Steps3	Check the integrity of the CAN communication network.
 <p style="text-align: center;">IP30</p> <p style="text-align: center;">EK897018</p>	<ol style="list-style-type: none"> 1 Turn the ignition switch to OFF. 2 Measure the resistance between the diagnostic interface harness terminals. Measuring circuit: The resistance between terminal 3 and terminal 11 of IP30 plug. Standard value: $\approx 60 \Omega$ 3 Check whether the result is normal or not?
	NO → Repair or replace the faulted parts.
YES ↓	

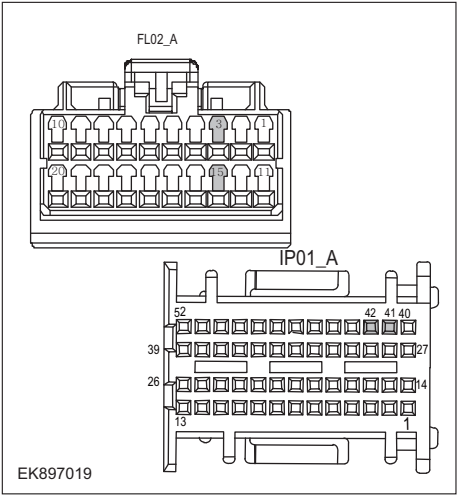
Steps4	Check the resistance of GWM and BCM.
	<ol style="list-style-type: none"> 1 Turn the ignition switch to OFF. 2 Disconnect the GWM harness plug FL02_ A. 3 Measure the resistance between the GWM harness terminals. Measuring circuit: FL02_ The resistance between terminal 3 and terminal 13 of plug A. Standard value: 110~130 Ω 4 Connect GWM harness plug FL02_ A. 5 Disconnect the BCM harness plug IP01_ A. 6 Measure the resistance between BCM harness terminals Measuring circuit: IP01_ The resistance between terminal 42 and terminal 41 of plug A Standard value: 110~130 Ω 7 Check whether the result is normal or not?
<p>NO → Repair or replace the faulted parts.</p>	
<p>YES ↓</p>	
Steps5	Check if GWM is normal.
	<ol style="list-style-type: none"> 1 Turn the ignition switch to OFF. 2 Disconnect and inspect the GWM harness plug FL02_ A. 3 Inspection and maintenance: <ul style="list-style-type: none"> • Corrosion (installing new connectors or terminals - cleaning module pins). • Damaged or bent pins - install new terminals/pins. • Pin flying - Install new pins as needed. 4 Reconnect the GWM plug and all other previously disconnected plugs. Ensure that the pin position and fixation are appropriate. 5 Run the system and determine if the problem still exists?
<p>YES → Replace GWM.</p>	
<p>NO ↓</p>	
<p>At this point, the system is operating normally. The possible cause of the problem may be module connection. Address the root cause of any connector or pin issues.</p>	
<p>Next Step ↓</p>	
<p>Diagnosis completed.</p>	

U0100-87

Fault diagnosis code
1 U0140-87: Lost Communication With BMS
Detection tools
1 Multimeter, diagnostic instrument
Possible causes
<ul style="list-style-type: none"> • Circuit,terminal and adapting piece fault • GWM
Conditions for fault code operation
Turn the ignition switch to ON position.
Conditions for fault code setting
U0100-87
To set the effect of a fault code condition
Description of circuit diagram
<p>The device is connected to the serial data circuit and monitors the serial data communication during normal vehicle operation. Devices exchange operational information and instructions with each other. The device has programming information that needs to be exchanged on the serial data circuit. The receiver device also monitors this information; In addition, some regular information is used to indicate the availability of the transmitter device.</p>

Circuit diagram

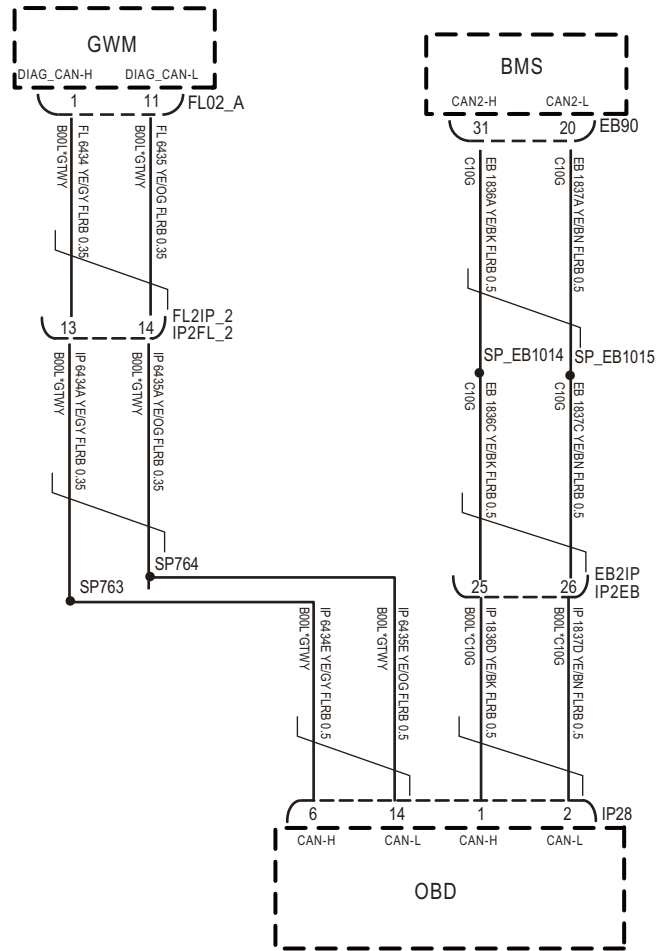

FL02_A

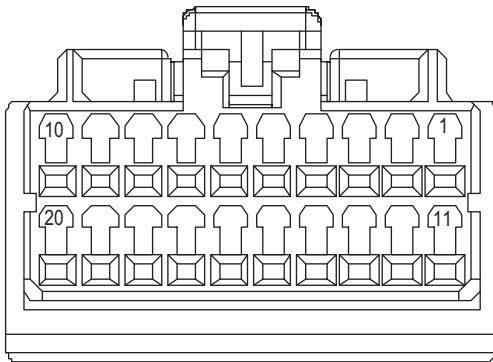

IP28

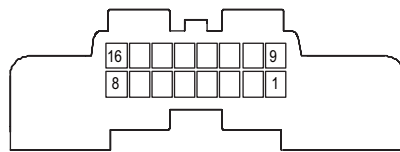

EB90

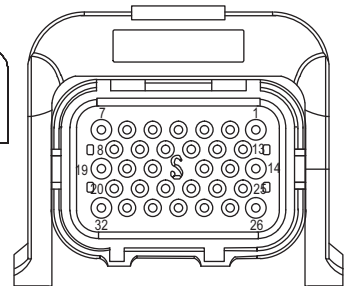

EK897020

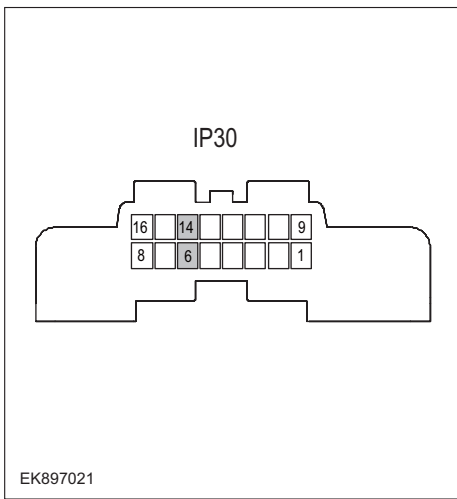
Troubleshooting steps	
Steps1	General inspection.
	<ol style="list-style-type: none"> 1 Check fuses for damage. 2 Check battery capacity. 3 Check the harness plug of GWM module for damage, poor contact, aging and looseness. 4 Check whether the result is normal or not?
	NO → Repair or replace the faulted parts.
YES ↓	
Steps2	Check fault codes.
	<ol style="list-style-type: none"> 1 Connect the fault diagnosis instrument to the diagnosis interface. 2 Turn the ignition switch to ON position.. 3 Diagnose the GWM module with diagnostic apparatus. 4 Is there any fault code other than U0100-87?
	YES → Refer to: DTC Summary list (GWM) .
NO ↓	
Steps3	Check the integrity of the CAN communication network.
	<ol style="list-style-type: none"> 1 Turn the ignition switch to OFF. 2 Measure the resistance between the diagnostic interface harness terminals. Measuring circuit: The resistance between terminal 6 and terminal 14 of IP28 plug. Standard value: $\approx 60 \Omega$ 3 Check whether the result is normal or not?
	NO → Repair or replace the faulted parts.
YES ↓	

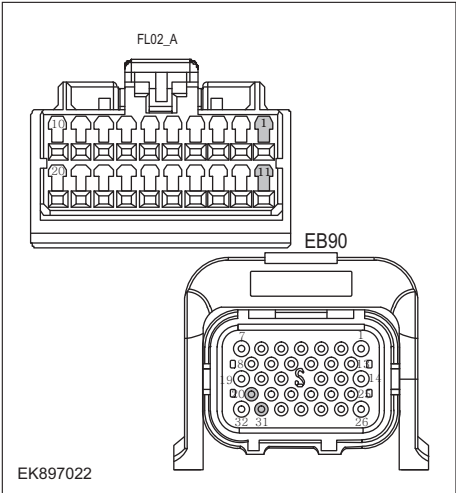
Steps4	Check the resistance of GWM and BMS.
	<ol style="list-style-type: none"> 1 Turn the ignition switch to OFF. 2 Disconnect the GWM harness plug FL02_ A. 3 Measure the resistance between the GWM harness terminals. Measuring circuit: FL02_ The resistance between terminal 1 and terminal 11 of plug A. Standard value: 110~130 Ω 4 Connect GWM harness plug FL02_ A. 5 Disconnect the BMS harness plug EB90. 6 Measure the resistance between the BMS harness terminals. Measuring circuit: resistance between terminal 20 and terminal 31 of EB90 plug. Standard value: 110~130 Ω 7 Check whether the result is normal or not?
NO → Repair or replace the faulted parts.	
YES ↓	
Steps5	Check if GWM is normal.
	<ol style="list-style-type: none"> 1 Turn the ignition switch to OFF. 2 Disconnect and inspect the GWM harness plug FL02_ A. 3 Inspection and maintenance: <ul style="list-style-type: none"> • Corrosion (installing new connectors or terminals - cleaning module pins). • Damaged or bent pins - install new terminals/pins. • Pin flying - Install new pins as needed. 4 Reconnect the GWM plug and all other previously disconnected plugs. Ensure that the pin position and fixation are appropriate. 5 Run the system and determine if the problem still exists?
YES → Replace GWM.	
NO ↓	
At this point, the system is operating normally. The possible cause of the problem may be module connection. Address the root cause of any connector or pin issues.	
Next Step ↓	
Diagnosis completed.	

U0101-87

Fault diagnosis code
U0101-87: Lost Communication With SCU
Detection tools
1 Multimeter, diagnostic instrument
Possible causes
<ul style="list-style-type: none"> • Circuit,terminal and adapting piece fault • GWM
Conditions for fault code operation
Turn the ignition switch to ON position.
Conditions for fault code setting
U0101-87
To set the effect of a fault code condition
Description of circuit diagram
The device is connected to the serial data circuit and monitors the serial data communication during normal vehicle operation. Devices exchange operational information and instructions with each other. The device has programming information that needs to be exchanged on the serial data circuit. The receiver device also monitors this information; In addition, some regular information is used to indicate the availability of the transmitter device.

Circuit diagram

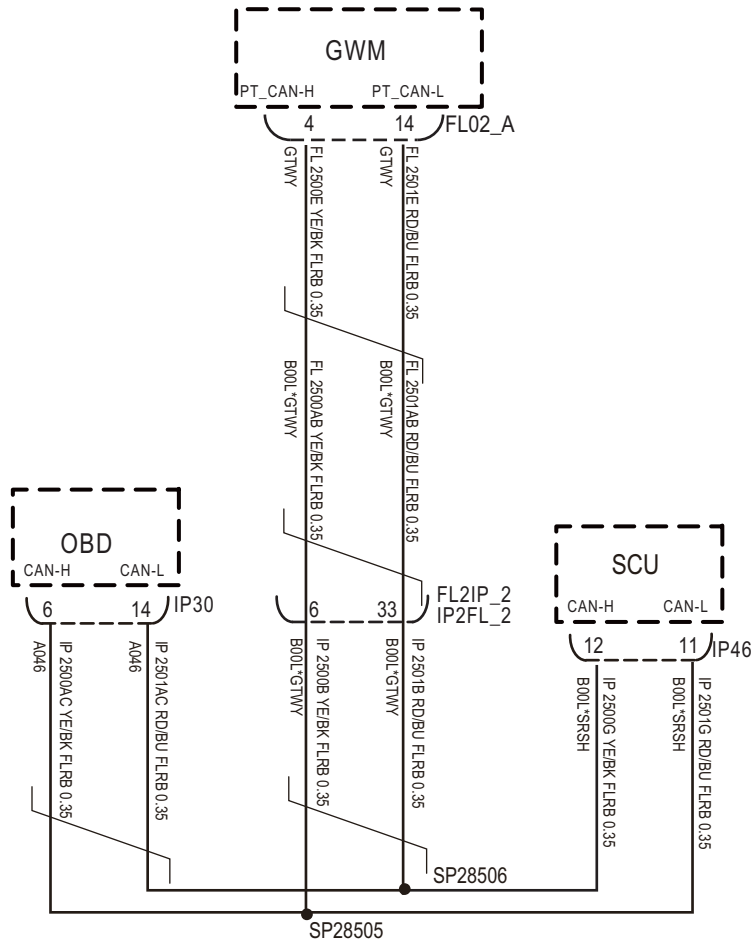

FL02_A

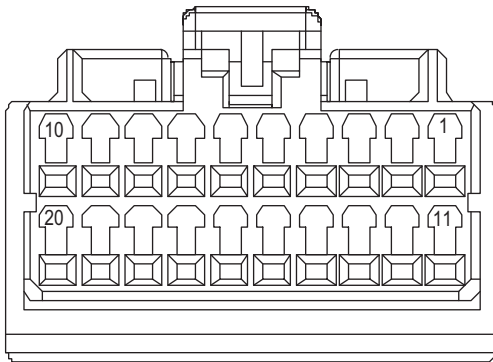

IP30

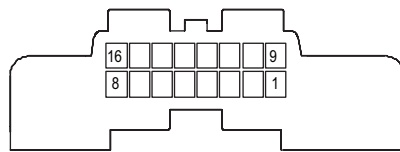

IP46

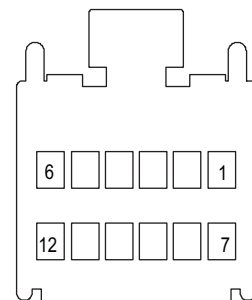

EK897023

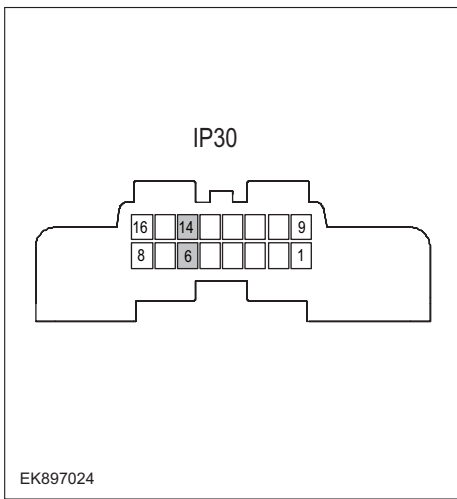
Troubleshooting steps	
Steps1	General inspection.
	<ol style="list-style-type: none"> 1 Check fuses for damage. 2 Check battery capacity. 3 Check the harness plug of GWM module for damage, poor contact, aging and looseness. 4 Check whether the result is normal or not?
	NO → Repair or replace the faulted parts.
YES ↓	
Steps2	Check fault codes.
	<ol style="list-style-type: none"> 1 Connect the fault diagnosis instrument to the diagnosis interface. 2 Turn the ignition switch to ON position.. 3 Diagnose the GWM module with diagnostic apparatus. 4 Is there any fault code other than U0101-87?
	YES → Refer to: DTC Summary list (GWM) .
NO ↓	
Steps3	Check the integrity of the CAN communication network.
	<ol style="list-style-type: none"> 1 Turn the ignition switch to OFF. 2 Measure the resistance between the diagnostic interface harness terminals. Measuring circuit: resistance between terminal 6 and terminal 14 of IP30 plug. Standard value: $\approx 60 \Omega$ 3 Check whether the result is normal or not?
	NO → Repair or replace the faulted parts.
YES ↓	

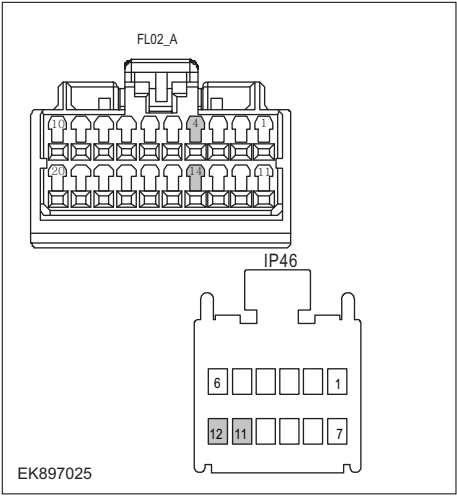
Steps4	Check the resistance of GWM and SCU.
 <p>EK897025</p>	<ol style="list-style-type: none"> 1 Turn the ignition switch to OFF. 2 Disconnect the GWM harness plug FL02_ A. 3 Measure the resistance between the GWM harness terminals. Measuring circuit: FL02_ The resistance between terminal 4 and terminal 14 of plug A. Standard value: 110~130 Ω 4 Connect GWM harness plug FL02_ A. 5 Disconnect the SCU harness plug IP46. 6 Measure the resistance between the SCU harness terminals. Measuring circuit: resistance between terminal 11 and terminal 12 of IP46 plug. Standard value: 110~130 Ω 7 Check whether the result is normal or not?
<p>NO → Repair or replace the faulted parts.</p>	
<p>YES ↓</p>	
Steps5	Check if GWM is normal.
	<ol style="list-style-type: none"> 1 Turn the ignition switch to OFF. 2 Disconnect and inspect the GWM harness plug FL02_ A. 3 Inspection and maintenance: <ul style="list-style-type: none"> • Corrosion (installing new connectors or terminals - cleaning module pins). • Damaged or bent pins - install new terminals/pins. • Pin flying - Install new pins as needed. 4 Reconnect the GWM plug and all other previously disconnected plugs. Ensure that the pin position and fixation are appropriate. 5 Run the system and determine if the problem still exists?
<p>YES → Replace GWM.</p>	
<p>NO ↓</p>	
<p>At this point, the system is operating normally. The possible cause of the problem may be module connection. Address the root cause of any connector or pin issues.</p>	
<p>Next Step ↓</p>	
<p>Diagnosis completed.</p>	

U0155-87

Fault diagnosis code
U0155-87: Lost Communication With IPK
Detection tools
1 Multimeter, diagnostic instrument
Possible causes
<ul style="list-style-type: none"> • Circuit,terminal and adapting piece fault • GWM
Conditions for fault code operation
Turn the ignition switch to ON position.
Conditions for fault code setting
U0155-87
To set the effect of a fault code condition
Description of circuit diagram
<p>The device is connected to the serial data circuit and monitors the serial data communication during normal vehicle operation. Devices exchange operational information and instructions with each other. The device has programming information that needs to be exchanged on the serial data circuit. The receiver device also monitors this information; In addition, some regular information is used to indicate the availability of the transmitter device.</p>

Circuit diagram

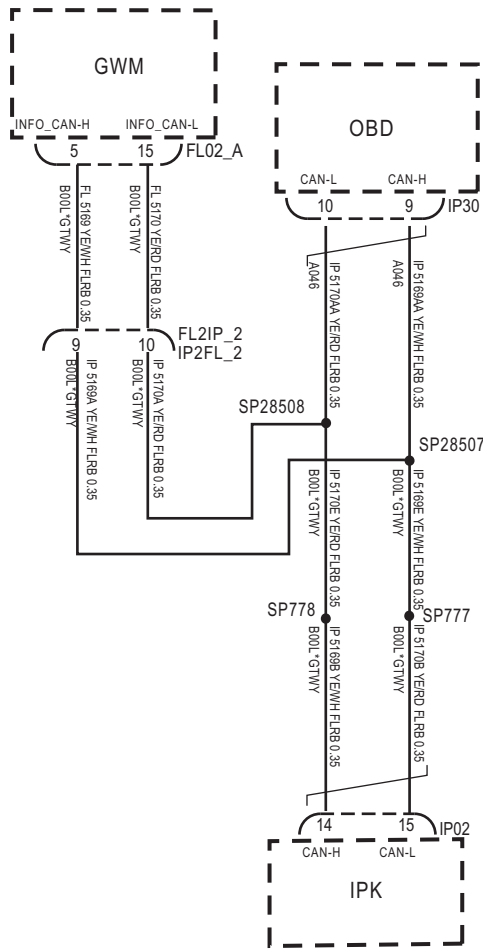

FL02_A

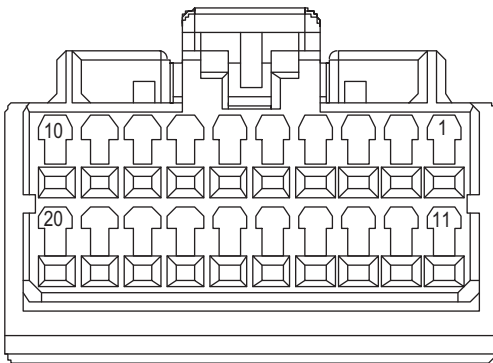

IP30

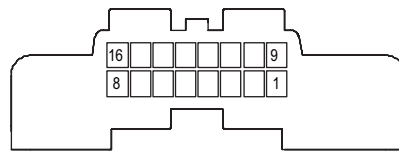

IP02

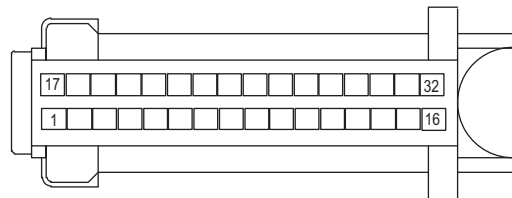

EK897026

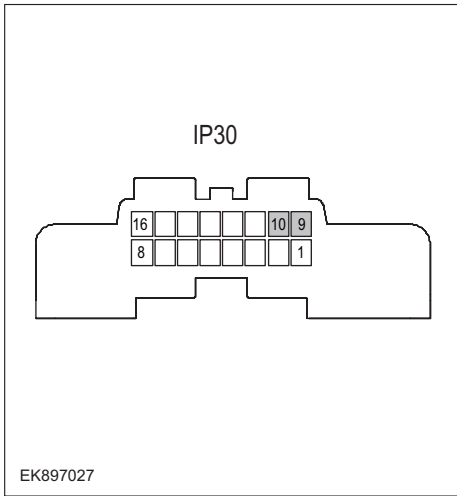
Troubleshooting steps	
Steps1	General inspection.
	<ol style="list-style-type: none"> 1 Check fuses for damage. 2 Check battery capacity. 3 Check the harness plug of GWM module for damage, poor contact, aging and looseness. 4 Check whether the result is normal or not?
	NO → Repair or replace the faulted parts.
YES ↓	
Steps2	Check fault codes.
	<ol style="list-style-type: none"> 1 Connect the fault diagnosis instrument to the diagnosis interface. 2 Turn the ignition switch to ON position.. 3 Diagnose the GWM module with diagnostic apparatus. 4 Is there any fault code other than U0155-87?
	YES → Refer to: DTC Summary list (GWM) .
NO ↓	
Steps3	Check the integrity of the CAN communication network.
	<ol style="list-style-type: none"> 1 Turn the ignition switch to OFF. 2 Measure the resistance between the diagnostic interface harness terminals. Measuring circuit: resistance between terminal 10 and terminal 9 of IP30 plug. Standard value: $\approx 60 \Omega$ 3 Check whether the result is normal or not?
	NO → Repair or replace the faulted parts.
YES ↓	

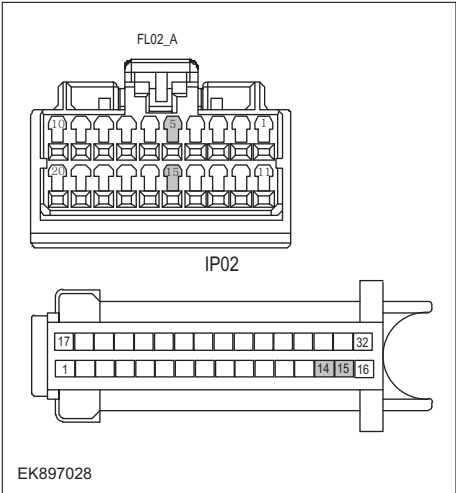
Steps4	Check GWM and IPK resistance.
	<ol style="list-style-type: none"> 1 Turn the ignition switch to OFF. 2 Disconnect the GWM harness plug FL02_ A. 3 Measure the resistance between the GWM harness terminals. Measuring circuit: FL02_ The resistance between terminal 5 and terminal 15 of plug A. Standard value: 110~130 Ω 4 Connect GWM harness plug FL02_ A. 5 Disconnect the IPK harness plug IP02. 6 Measure the resistance between the IPK harness terminals. Measuring circuit: Resistance between terminal 14 and terminal 15 of IP02 plug. Standard value: 110~130 Ω 7 Check whether the result is normal or not?
NO → Repair or replace the faulted parts.	
YES ↓	
Steps5	Check if GWM is normal.
	<ol style="list-style-type: none"> 1 Turn the ignition switch to OFF. 2 Disconnect and inspect the GWM harness plug FL02_ A. 3 Inspection and maintenance: <ul style="list-style-type: none"> • Corrosion (installing new connectors or terminals - cleaning module pins). • Damaged or bent pins - install new terminals/pins. • Pin flying - Install new pins as needed. 4 Reconnect the GWM plug and all other previously disconnected plugs. Ensure that the pin position and fixation are appropriate. 5 Run the system and determine if the problem still exists?
YES → Replace GWM.	
NO ↓	
At this point, the system is operating normally. The possible cause of the problem may be module connection. Address the root cause of any connector or pin issues.	
Next Step ↓	
Diagnosis completed.	

U0151-87

Fault diagnosis code
U0151-87 : Lost Communication With SAS
Detection tools
1 Multimeter, diagnostic instrument
Possible causes
<ul style="list-style-type: none"> • Circuit, terminal and adapting piece fault • GWM
Conditions for fault code operation
Turn the ignition switch to ON position.
Conditions for fault code setting
U0151-87
To set the effect of a fault code condition
Description of circuit diagram
<p>The device is connected to the serial data circuit and monitors the serial data communication during normal vehicle operation. Devices exchange operational information and instructions with each other. The device has programming information that needs to be exchanged on the serial data circuit. The receiver device also monitors this information; In addition, some regular information is used to indicate the availability of the transmitter device.</p>

Circuit diagram

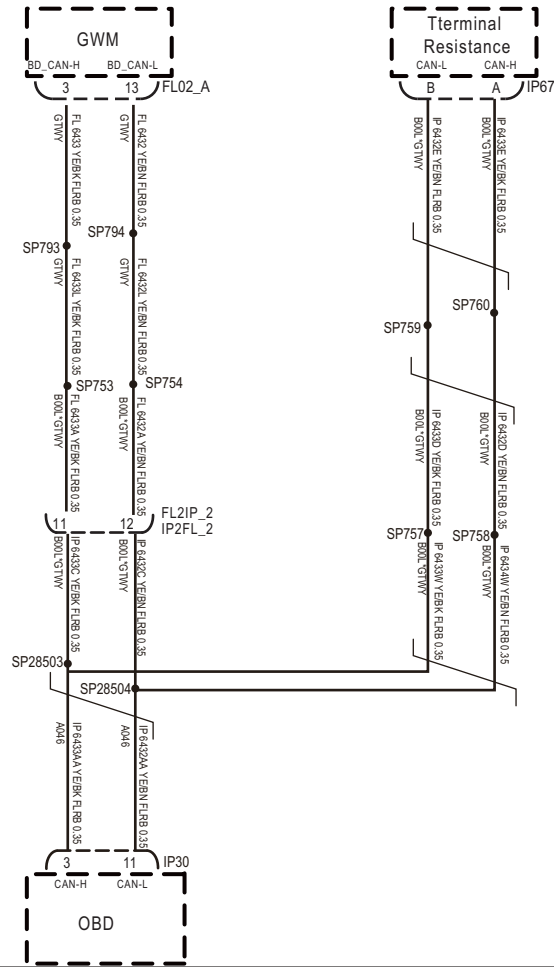

FL02_A

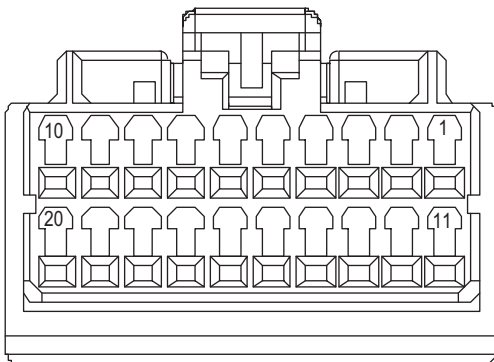

IP30

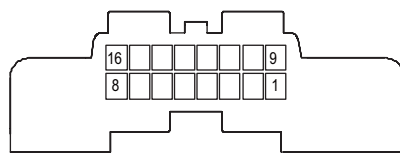

IP67

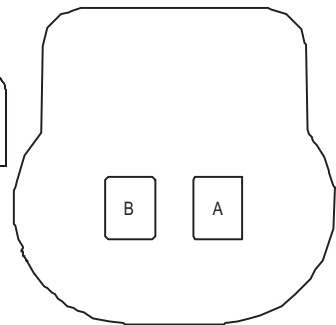

EK897029

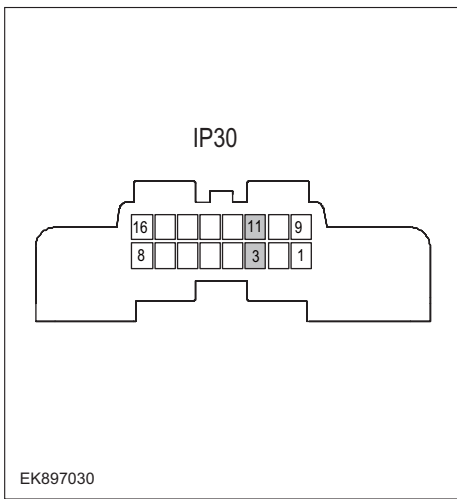
Troubleshooting steps	
Steps1	General inspection.
	<ol style="list-style-type: none"> 1 Check fuses for damage. 2 Check battery capacity. 3 Check the harness plug of GWM module for damage, poor contact, aging and looseness. 4 Check whether the result is normal or not?
	NO → Repair or replace the faulted parts.
YES ↓	
Steps2	Check fault codes.
	<ol style="list-style-type: none"> 1 Connect the fault diagnosis instrument to the diagnosis interface. 2 Turn the ignition switch to ON position.. 3 Diagnose the GWM module with diagnostic apparatus. 4 Is there any fault code other than U0151-87 ?
	YES → Refer to: DTC Summary list (GWM) .
NO ↓	
Steps3	Check the integrity of the CAN communication network.
	<ol style="list-style-type: none"> 1 Turn the ignition switch to OFF. 2 Measure the resistance between the diagnostic interface harness terminals. Measuring circuit: resistance between terminal 3 and terminal 11 of IP30 plug. Standard value: $\approx 60 \Omega$ 3 Check whether the result is normal or not?
	NO → Repair or replace the faulted parts.
YES ↓	

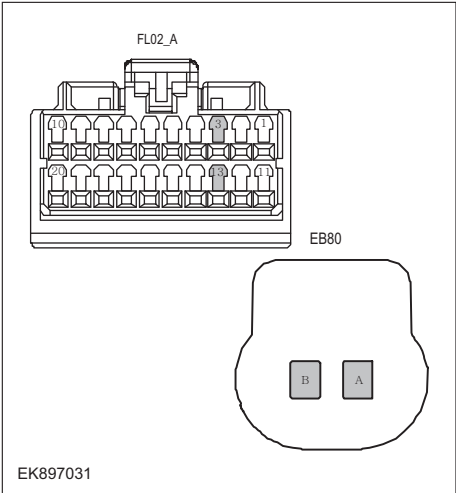
Steps4	Check the GWM and terminal resistance.
	<ol style="list-style-type: none"> 1 Turn the ignition switch to OFF. 2 Disconnect the GWM harness plug FL02_ A. 3 Measure the resistance between the GWM harness terminals. Measuring circuit: FL02_ The resistance between terminal 3 and terminal 13 of plug A. Standard value: 110~130 Ω 4 Connect GWM harness plug FL02_ A. 5 Disconnect the terminal resistor harness plug IP167. 6 Measure the resistance between the terminals of the terminal resistance harness. Measuring circuit: The resistance between terminal A and terminal B of IP167 plug. Standard value: 110~130 Ω 7 Check whether the result is normal or not?
NO → Repair or replace the faulted parts.	
YES ↓	
Steps5	Check if GWM is normal.
	<ol style="list-style-type: none"> 1 Turn the ignition switch to OFF. 2 Disconnect and inspect the GWM harness plug FL02_ A. 3 Inspection and maintenance: <ul style="list-style-type: none"> • Corrosion (installing new connectors or terminals - cleaning module pins). • Damaged or bent pins - install new terminals/pins. • Pin flying - Install new pins as needed. 4 Reconnect the GWM plug and all other previously disconnected plugs. Ensure that the pin position and fixation are appropriate. 5 Run the system and determine if the problem still exists?
YES → Replace GWM.	
NO ↓	
At this point, the system is operating normally. The possible cause of the problem may be module connection. Address the root cause of any connector or pin issues.	
Next Step ↓	
Diagnosis completed.	

U0116-87

Fault diagnosis code
U0116-87: Lost Communication With HVAC
Detection tools
1 Multimeter, diagnostic instrument
Possible causes
<ul style="list-style-type: none"> • Circuit, terminal and adapting piece fault • GWM
Conditions for fault code operation
Turn the ignition switch to ON position.
Conditions for fault code setting
U0116-87
To set the effect of a fault code condition
Description of circuit diagram
<p>The device is connected to the serial data circuit and monitors the serial data communication during normal vehicle operation. Devices exchange operational information and instructions with each other. The device has programming information that needs to be exchanged on the serial data circuit. The receiver device also monitors this information; In addition, some regular information is used to indicate the availability of the transmitter device.</p>

Circuit diagram

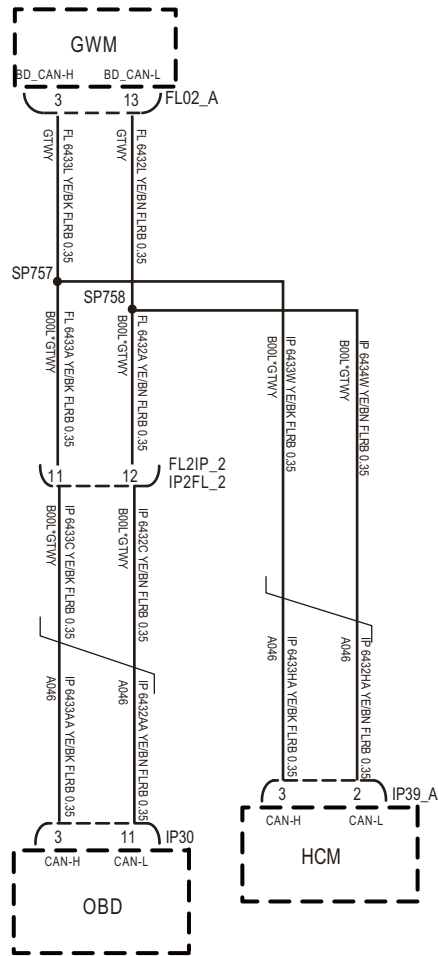

FL02_A

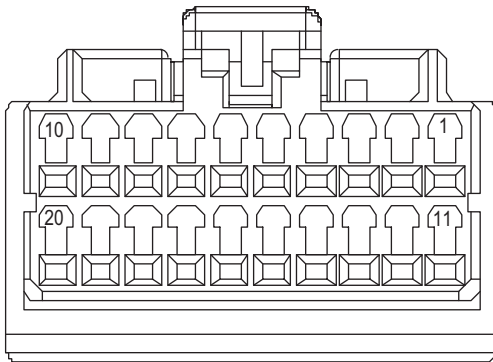

IP30

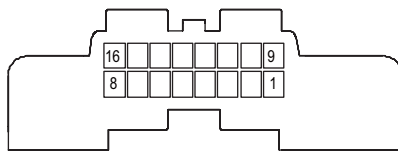

IP39_A

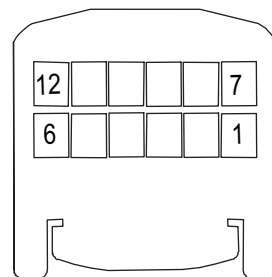

EK897032

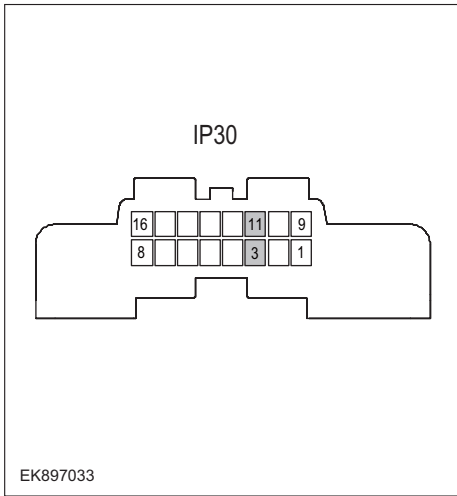
Troubleshooting steps	
Steps1	General inspection.
	<ol style="list-style-type: none"> 1 Check fuses for damage. 2 Check battery capacity. 3 Check the harness plug of GWM module for damage, poor contact, aging and looseness. 4 Check whether the result is normal or not?
	NO → Repair or replace the faulted parts.
YES ↓	
Steps2	Check fault codes.
	<ol style="list-style-type: none"> 1 Connect the fault diagnosis instrument to the diagnosis interface. 2 Turn the ignition switch to ON position.. 3 Diagnose the GWM module with diagnostic apparatus. 4 Is there any fault code other than U0116-87?
	YES → Refer to: DTC Summary list (GWM) .
NO ↓	
Steps3	Check the integrity of the CAN communication network.
	<ol style="list-style-type: none"> 1 Turn the ignition switch to OFF. 2 Measure the resistance between the diagnostic interface harness terminals. Measuring circuit: resistance between terminal 3 and terminal 11 of IP30 plug. Standard value: $\approx 60 \Omega$ 3 Check whether the result is normal or not?
	NO → Repair or replace the faulted parts.
YES ↓	

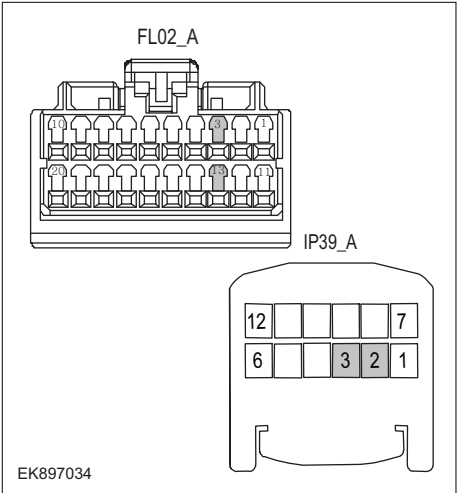
Steps4	Check the resistance of GWM and air conditioning control panel.
	<ol style="list-style-type: none"> 1 Turn the ignition switch to OFF. 2 Disconnect the GWM harness plug FL02_ A. 3 Measure the resistance between the GWM harness terminals. Measuring circuit: FL02_ The resistance between terminal 3 and terminal 13 of plug A. Standard value: 110~130 Ω 4 Connect GWM harness plug FL02_ A. 5 Disconnect the air conditioning control panel harness plug IP39_ A. 6 Measure the resistance between the harness terminals of the air conditioning control panel. Measuring circuit: IP39_ The resistance between terminal 2 and terminal 3 of plug A. Standard value: 110~130 Ω 7 Check whether the result is normal or not?
NO → Repair or replace the faulted parts.	
YES ↓	
Steps5	Check if GWM is normal.
	<ol style="list-style-type: none"> 1 Turn the ignition switch to OFF. 2 Disconnect and inspect the GWM harness plug FL02_ A. 3 Inspection and maintenance: <ul style="list-style-type: none"> • Corrosion (installing new connectors or terminals - cleaning module pins). • Damaged or bent pins - install new terminals/pins. • Pin flying - Install new pins as needed. 4 Reconnect the GWM plug and all other previously disconnected plugs. Ensure that the pin position and fixation are appropriate. 5 Run the system and determine if the problem still exists?
YES → Replace GWM.	
NO ↓	
At this point, the system is operating normally. The possible cause of the problem may be module connection. Address the root cause of any connector or pin issues.	
Next Step ↓	
Diagnosis completed.	

U0118-87

Fault diagnosis code
U0118-87: Lost Communication With VCU
Detection tools
1 Multimeter, diagnostic instrument
Possible causes
<ul style="list-style-type: none"> • Circuit, terminal and adapting piece fault • GWM
Conditions for fault code operation
Turn the ignition switch to ON position.
Conditions for fault code setting
U0118-87
To set the effect of a fault code condition
Description of circuit diagram
<p>The device is connected to the serial data circuit and monitors the serial data communication during normal vehicle operation. Devices exchange operational information and instructions with each other. The device has programming information that needs to be exchanged on the serial data circuit. The receiver device also monitors this information; In addition, some regular information is used to indicate the availability of the transmitter device.</p>

Circuit diagram

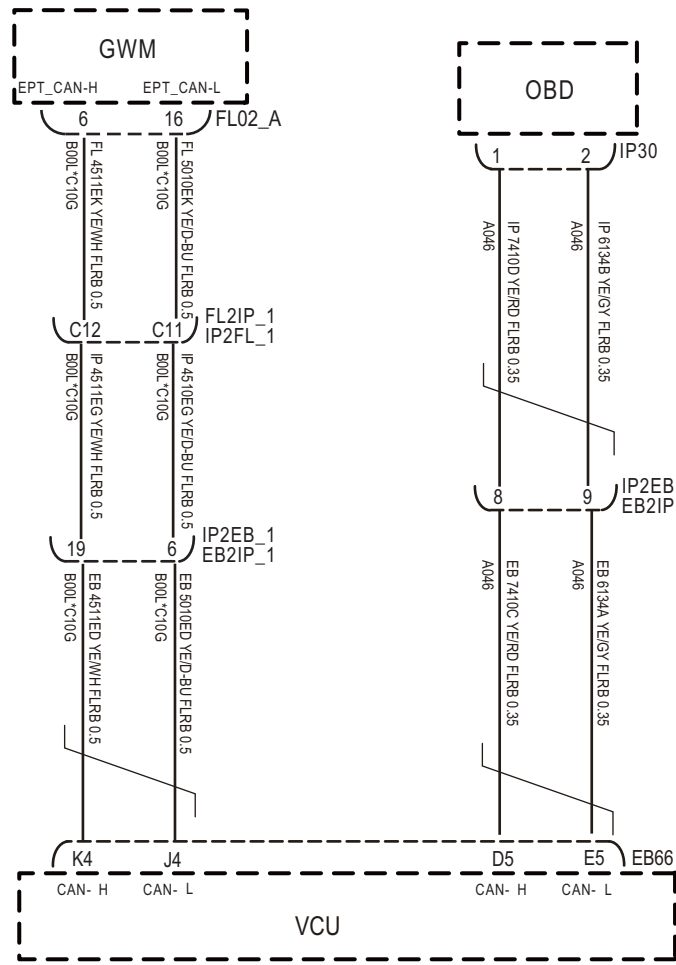

FL02_A

IP30

EB66

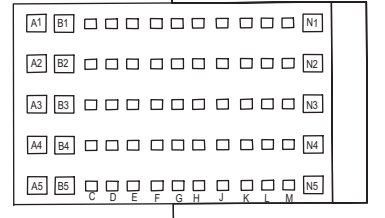
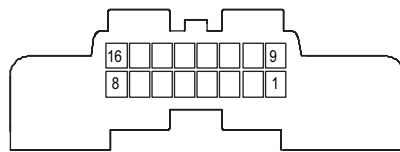
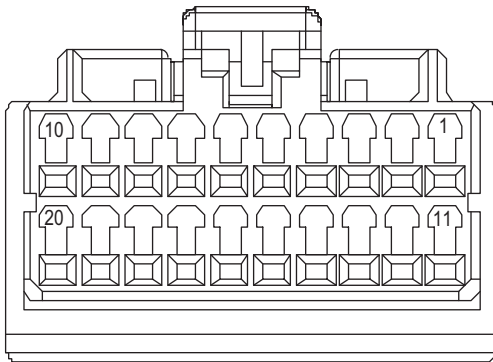

EK897035

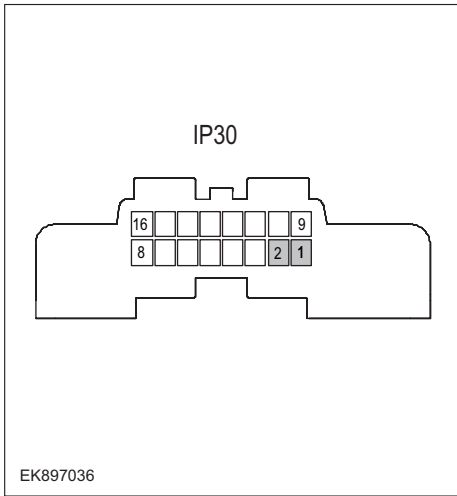
Troubleshooting steps	
Steps1	General inspection.
	<ol style="list-style-type: none"> 1 Check fuses for damage. 2 Check battery capacity. 3 Check the harness plug of GWM module for damage, poor contact, aging and looseness. 4 Check whether the result is normal or not?
	NO → Repair or replace the faulted parts.
YES ↓	
Steps2	Check fault codes.
	<ol style="list-style-type: none"> 1 Connect the fault diagnosis instrument to the diagnosis interface. 2 Turn the ignition switch to ON position.. 3 Diagnose the GWM module with diagnostic apparatus. 4 Is there any fault code other than U0118-87?
	YES → Refer to: DTC Summary list (GWM) .
NO ↓	
Steps3	Check the integrity of the CAN communication network.
 <p style="text-align: center;">IP30</p> <p style="text-align: center;">EK897036</p>	<ol style="list-style-type: none"> 1 Turn the ignition switch to OFF. 2 Measure the resistance between the diagnostic interface harness terminals. Measuring circuit: resistance between terminal 1 and terminal 2 of IP28 plug. Standard value: $\approx 60 \Omega$ 3 Check whether the result is normal or not?
	NO → Repair or replace the faulted parts.
YES ↓	

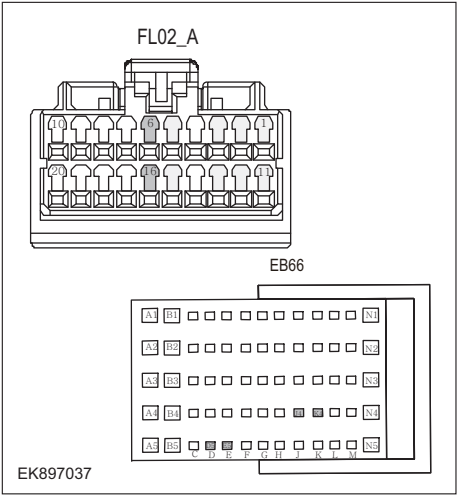
Steps4	Check the resistance of GWM and VCU.
	<ol style="list-style-type: none"> 1 Turn the ignition switch to OFF. 2 Disconnect the GWM harness plug FL02_ A. 3 Measure the resistance between the GWM harness terminals. Measuring circuit: FL02_ The resistance between terminal 6 and terminal 16 of plug A. Standard value: 110~130 Ω 4 Connect GWM harness plug FL02_ A. 5 Disconnect the VCU module harness plug EB66. 6 Measure the resistance between the VCU module harness terminals. Measuring circuit: resistance between terminal K4 and terminal J4 of EB66 plug. Measuring circuit: resistance between terminal D5 and terminal E5 of EB66 plug. Standard value: 110~130 Ω 7 Check whether the result is normal or not?
NO → Repair or replace the faulted parts.	
YES ↓	
Steps5	Check if GWM is normal.
	<ol style="list-style-type: none"> 1 Turn the ignition switch to OFF. 2 Disconnect and inspect the GWM harness plug FL02_ A. 3 Inspection and maintenance: <ul style="list-style-type: none"> • Corrosion (installing new connectors or terminals - cleaning module pins). • Damaged or bent pins - install new terminals/pins. • Pin flying - Install new pins as needed. 4 Reconnect the GWM plug and all other previously disconnected plugs. Ensure that the pin position and fixation are appropriate. 5 Run the system and determine if the problem still exists?
YES → Replace GWM.	
NO ↓	
At this point, the system is operating normally. The possible cause of the problem may be module connection. Address the root cause of any connector or pin issues.	
Next Step ↓	
Diagnosis completed.	

U0119-87

Fault diagnosis code
U0119-87: Lost Communication With SRS
Detection tools
1 Multimeter, diagnostic instrument
Possible causes
<ul style="list-style-type: none"> • Circuit, terminal and adapting piece fault • GWM
Conditions for fault code operation
Turn the ignition switch to ON position.
Conditions for fault code setting
U0119-87
To set the effect of a fault code condition
Description of circuit diagram
<p>The device is connected to the serial data circuit and monitors the serial data communication during normal vehicle operation. Devices exchange operational information and instructions with each other. The device has programming information that needs to be exchanged on the serial data circuit. The receiver device also monitors this information; In addition, some regular information is used to indicate the availability of the transmitter device.</p>

Circuit diagram

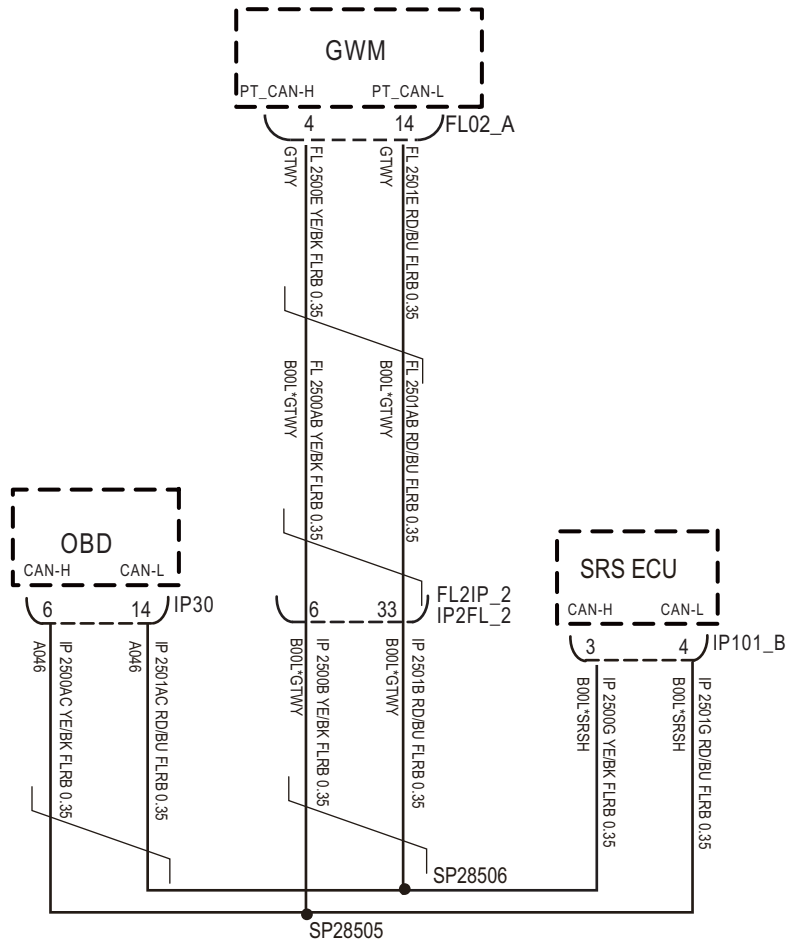

FL02_A

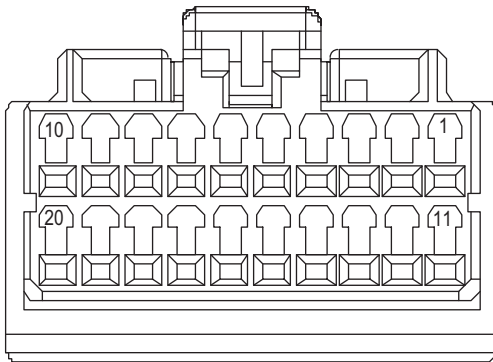

IP30

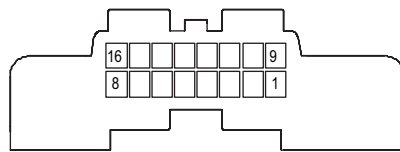

IP101_B

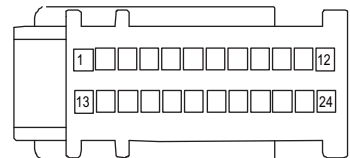

EK897038

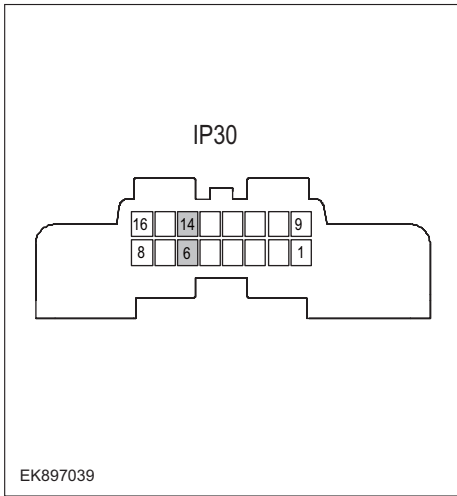
Troubleshooting steps	
Steps1	General inspection.
	<ol style="list-style-type: none"> 1 Check fuses for damage. 2 Check battery capacity. 3 Check the harness plug of GWM module for damage, poor contact, aging and looseness. 4 Check whether the result is normal or not?
	NO → Repair or replace the faulted parts.
YES ↓	
Steps2	Check fault codes.
	<ol style="list-style-type: none"> 1 Connect the fault diagnosis instrument to the diagnosis interface. 2 Turn the ignition switch to ON position.. 3 Diagnose the GWM module with diagnostic apparatus. 4 Is there any fault code other than U0119-87?
	YES → Refer to: DTC Summary list (GWM) .
NO ↓	
Steps3	Check the integrity of the CAN communication network.
	<ol style="list-style-type: none"> 1 Turn the ignition switch to OFF. 2 Measure the resistance between the diagnostic interface harness terminals. Measuring circuit: resistance between terminal 6 and terminal 14 of IP30 plug. Standard value: $\approx 60 \Omega$ 3 Check whether the result is normal or not?
	NO → Repair or replace the faulted parts.
YES ↓	

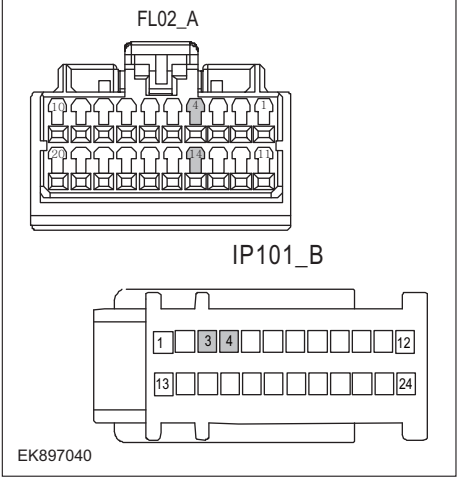
Steps4	Check GWM and SRS resistance.
	<ol style="list-style-type: none"> 1 Turn the ignition switch to OFF. 2 Disconnect the GWM harness plug FL02_ A. 3 Measure the resistance between the GWM harness terminals. Measuring circuit: FL02_ The resistance between terminal 4 and terminal 14 of plug A. Standard value: 110~130 Ω 4 Connect GWM harness plug FL02_ A. 5 Disconnect the SRS harness plug IP101_ B. 6 Measure the resistance between the SRS harness terminals. Measuring circuit: IP101_ Resistance between terminal 3 and terminal 4 of plug B. Standard value: 110~130 Ω 7 Check whether the result is normal or not?
<p>NO → Repair or replace the faulted parts.</p>	
<p>YES ↓</p>	
Steps5	Check if GWM is normal.
	<ol style="list-style-type: none"> 1 Turn the ignition switch to OFF. 2 Disconnect and inspect the GWM harness plug FL02_ A. 3 Inspection and maintenance: <ul style="list-style-type: none"> • Corrosion (installing new connectors or terminals - cleaning module pins). • Damaged or bent pins - install new terminals/pins. • Pin flying - Install new pins as needed. 4 Reconnect the GWM plug and all other previously disconnected plugs. Ensure that the pin position and fixation are appropriate. 5 Run the system and determine if the problem still exists?
<p>YES → Replace GWM.</p>	
<p>NO ↓</p>	
<p>At this point, the system is operating normally. The possible cause of the problem may be module connection. Address the root cause of any connector or pin issues.</p>	
<p>Next Step ↓</p>	
<p>Diagnosis completed.</p>	

U0125-87

Fault diagnosis code
U0125-87: Lost Communication With FICM
Detection tools
1 Multimeter, diagnostic instrument
Possible causes
<ul style="list-style-type: none"> • Circuit, terminal and adapting piece fault • GWM
Conditions for fault code operation
Turn the ignition switch to ON position.
Conditions for fault code setting
U0125-87
To set the effect of a fault code condition
Description of circuit diagram
<p>The device is connected to the serial data circuit and monitors the serial data communication during normal vehicle operation. Devices exchange operational information and instructions with each other. The device has programming information that needs to be exchanged on the serial data circuit. The receiver device also monitors this information; In addition, some regular information is used to indicate the availability of the transmitter device.</p>

Circuit diagram

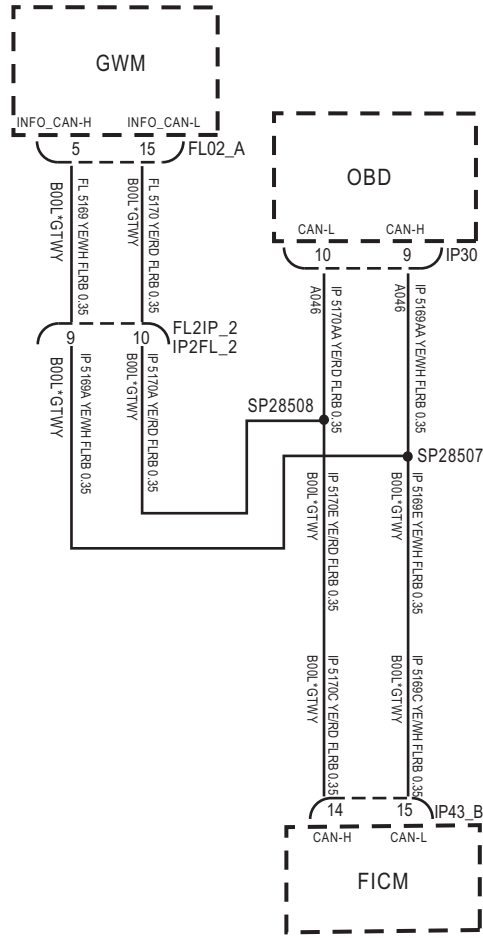

FL02_A

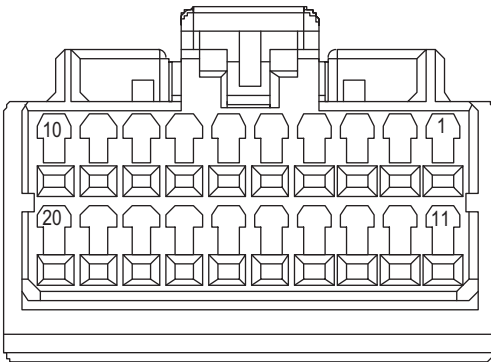

IP30

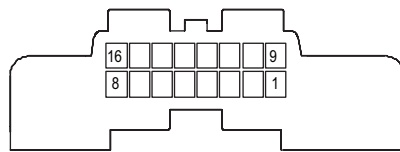

IP43_B

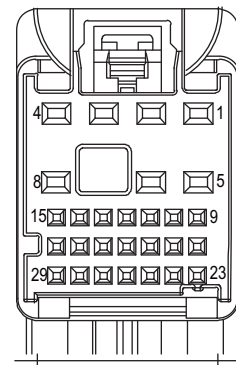

EK897041

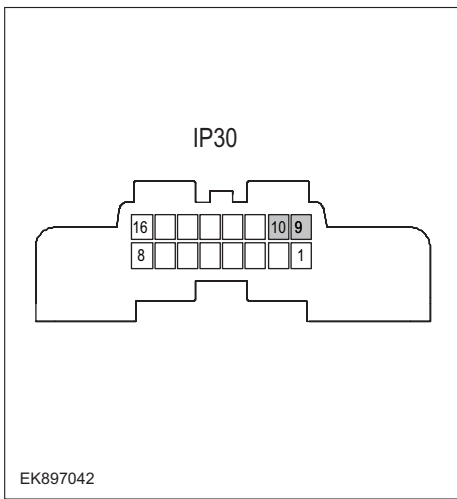
Troubleshooting steps	
Steps1	General inspection.
	<ol style="list-style-type: none"> 1 Check fuses for damage. 2 Check battery capacity. 3 Check the harness plug of GWM module for damage, poor contact, aging and looseness. 4 Check whether the result is normal or not?
	NO → Repair or replace the faulted parts.
YES ↓	
Steps2	Check fault codes.
	<ol style="list-style-type: none"> 1 Connect the fault diagnosis instrument to the diagnosis interface. 2 Turn the ignition switch to ON position.. 3 Diagnose the GWM module with diagnostic apparatus. 4 Is there any fault code other than U0125-87?
	YES → Refer to: DTC Summary list (GWM) .
NO ↓	
Steps3	Check the integrity of the CAN communication network.
 <p style="text-align: center;">IP30</p> <p style="text-align: center;">EK897042</p>	<ol style="list-style-type: none"> 1 Turn the ignition switch to OFF. 2 Measure the resistance between the diagnostic interface harness terminals. Measuring circuit: resistance between terminal 9 and terminal 10 of IP30 plug. Standard value: $\approx 60 \Omega$ 3 Check whether the result is normal or not?
	NO → Repair or replace the faulted parts.
YES ↓	

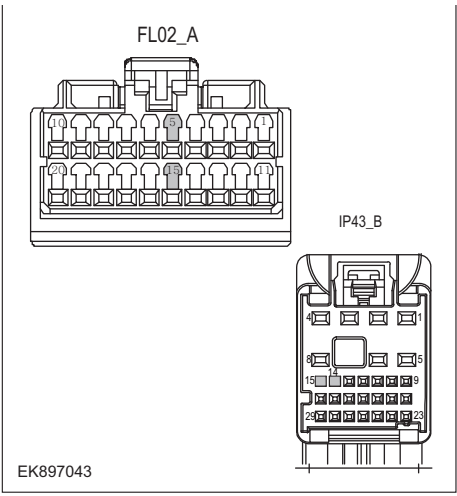
Steps4	Check the resistance of GWM and entertainment host.
 <p>FL02_A</p> <p>IP43_B</p> <p>EK897043</p>	<ol style="list-style-type: none"> 1 Turn the ignition switch to OFF. 2 Disconnect the GWM harness plug FL02_ A. 3 Measure the resistance between the GWM harness terminals. Measuring circuit: FL02_ The resistance between terminal 5 and terminal 15 of plug A. Standard value: 110~130 Ω 4 Connect GWM harness plug FL02_ A. 5 Disconnect the entertainment host harness plug IP55_ B. 6 Measure the resistance between the entertainment host harness terminals. Measuring circuit: IP55_ Resistance between terminal 14 and terminal 15 of plug B. Standard value: 110~130 Ω 7 Check whether the result is normal or not?
<p>NO → Repair or replace the faulted parts.</p>	
<p>YES ↓</p>	
Steps5	Check if GWM is normal.
	<ol style="list-style-type: none"> 1 Turn the ignition switch to OFF. 2 Disconnect and inspect the GWM harness plug FL02_ A. 3 Inspection and maintenance: <ul style="list-style-type: none"> • Corrosion (installing new connectors or terminals - cleaning module pins). • Damaged or bent pins - install new terminals/pins. • Pin flying - Install new pins as needed. 4 Reconnect the GWM plug and all other previously disconnected plugs. Ensure that the pin position and fixation are appropriate. 5 Run the system and determine if the problem still exists?
<p>YES → Replace GWM.</p>	
<p>NO ↓</p>	
<p>At this point, the system is operating normally. The possible cause of the problem may be module connection. Address the root cause of any connector or pin issues.</p>	
<p>Next Step ↓</p>	
<p>Diagnosis completed.</p>	

U0126-87

Fault diagnosis code
U0126-87: Lost Communication With ABS
Detection tools
1 Multimeter, diagnostic instrument
Possible causes
<ul style="list-style-type: none"> • Circuit, terminal and adapting piece fault • GWM
Conditions for fault code operation
Turn the ignition switch to ON position.
Conditions for fault code setting
U0126-87
To set the effect of a fault code condition
Description of circuit diagram
<p>The device is connected to the serial data circuit and monitors the serial data communication during normal vehicle operation. Devices exchange operational information and instructions with each other. The device has programming information that needs to be exchanged on the serial data circuit. The receiver device also monitors this information; In addition, some regular information is used to indicate the availability of the transmitter device.</p>

Circuit diagram

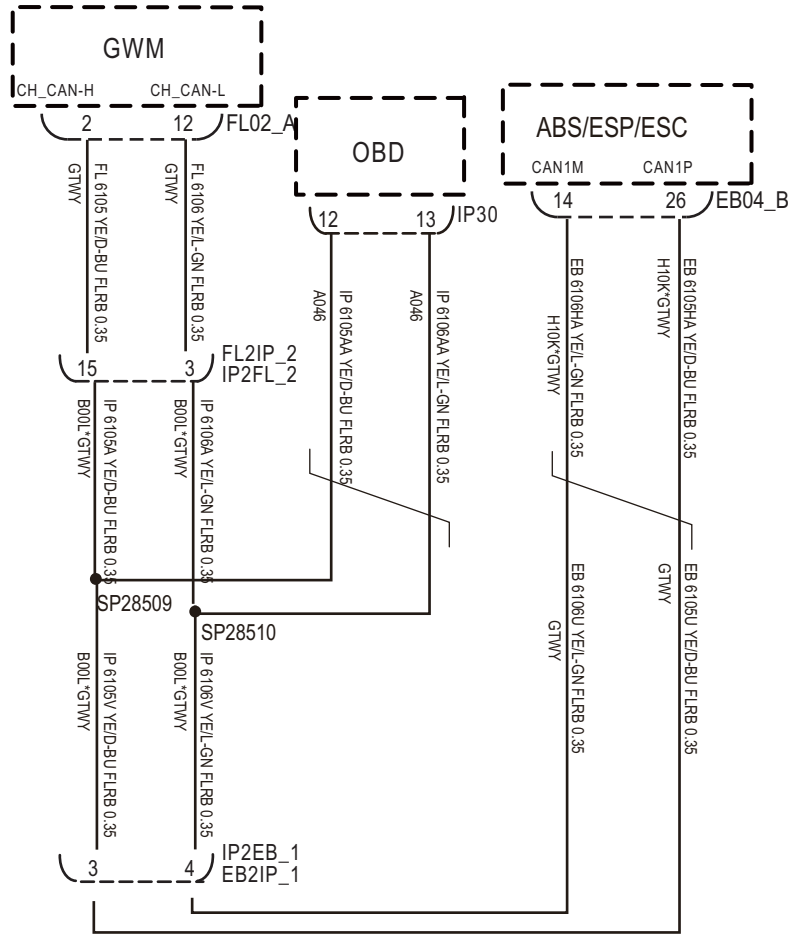

FL02_A

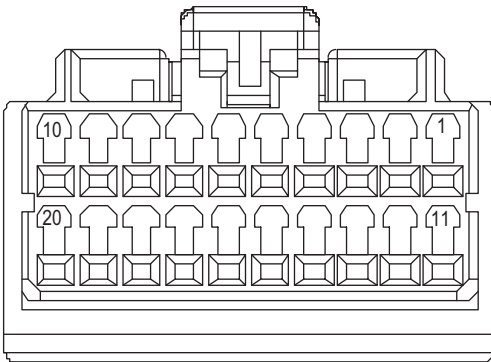

IP30

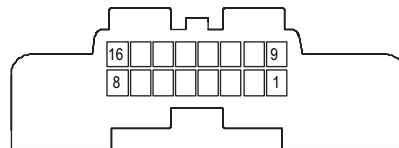

EB04_B

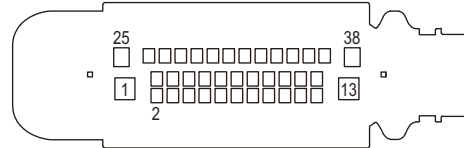

EK897044

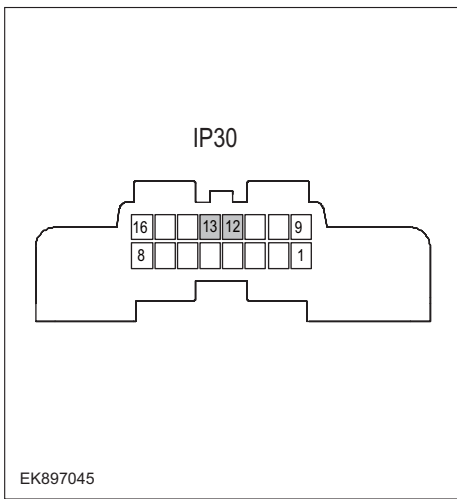
Troubleshooting steps	
Steps1	General inspection.
	<ol style="list-style-type: none"> 1 Check fuses for damage. 2 Check battery capacity. 3 Check the harness plug of GWM module for damage, poor contact, aging and looseness. 4 Check whether the result is normal or not?
	NO → Repair or replace the faulted parts.
YES ↓	
Steps2	Check fault codes.
	<ol style="list-style-type: none"> 1 Connect the fault diagnosis instrument to the diagnosis interface. 2 Turn the ignition switch to ON position.. 3 Diagnose the GWM module with diagnostic apparatus. 4 Is there any fault code other than U0126-87?
	YES → Refer to: DTC Summary list (GWM) .
NO ↓	
Steps3	Check the integrity of the CAN communication network.
	<ol style="list-style-type: none"> 1 Turn the ignition switch to OFF. 2 Measure the resistance between the diagnostic interface harness terminals. Measuring circuit: The resistance between terminal 12 and terminal 13 of IP30 plug. Standard value: $\approx 60 \Omega$ 3 Check whether the result is normal or not?
	NO → Repair or replace the faulted parts.
YES ↓	

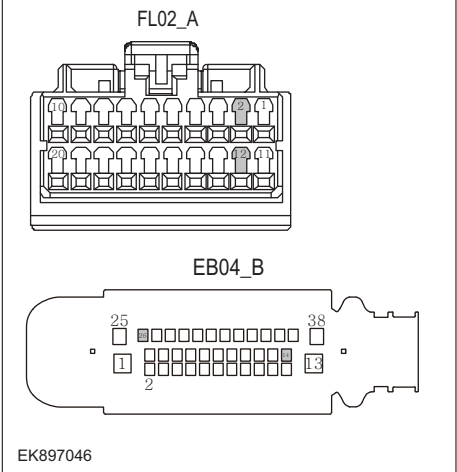
Steps4	Check the resistance of GWM and ABS.
	<ol style="list-style-type: none"> 1 Turn the ignition switch to OFF. 2 Disconnect the GWM harness plug FL02_ A. 3 Measure the resistance between the GWM harness terminals. Measuring circuit: FL02_ The resistance between terminal 2 and terminal 12 of plug A. Standard value: 110~130 Ω 4 Connect GWM harness plug FL02_ A. 5 Disconnect the ABS harness plug EB04_ B. 6 Measure the resistance between ABS harness terminals. Measuring circuit: EB04_ The resistance between terminal 14 and terminal 26 of plug B. Standard value: 110~130 Ω 7 Check whether the result is normal or not?
<p>NO → Repair or replace the faulted parts.</p>	
<p>YES ↓</p>	
Steps5	Check if GWM is normal.
	<ol style="list-style-type: none"> 1 Turn the ignition switch to OFF. 2 Disconnect and inspect the GWM harness plug FL02_ A. 3 Inspection and maintenance: <ul style="list-style-type: none"> • Corrosion (installing new connectors or terminals - cleaning module pins). • Damaged or bent pins - install new terminals/pins. • Pin flying - Install new pins as needed. 4 Reconnect the GWM plug and all other previously disconnected plugs. Ensure that the pin position and fixation are appropriate. 5 Run the system and determine if the problem still exists?
<p>YES → Replace GWM.</p>	
<p>NO ↓</p>	
<p>At this point, the system is operating normally. The possible cause of the problem may be module connection. Address the root cause of any connector or pin issues.</p>	
<p>Next Step ↓</p>	
<p>Diagnosis completed.</p>	

U0132-87

Fault diagnosis code
U0132-87: Lost Communication With MCU
Detection tools
1 Multimeter, diagnostic instrument
Possible causes
<ul style="list-style-type: none"> • Circuit, terminal and adapting piece fault • GWM
Conditions for fault code operation
Turn the ignition switch to ON position.
Conditions for fault code setting
U0132-87
To set the effect of a fault code condition
Description of circuit diagram
The device is connected to the serial data circuit and monitors the serial data communication during normal vehicle operation. Devices exchange operational information and instructions with each other. The device has programming information that needs to be exchanged on the serial data circuit. The receiver device also monitors this information; In addition, some regular information is used to indicate the availability of the transmitter device.
Circuit diagram

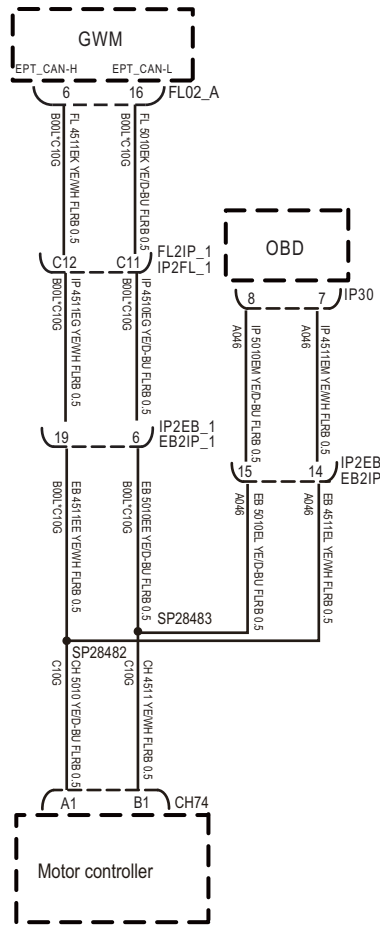

FL02_A

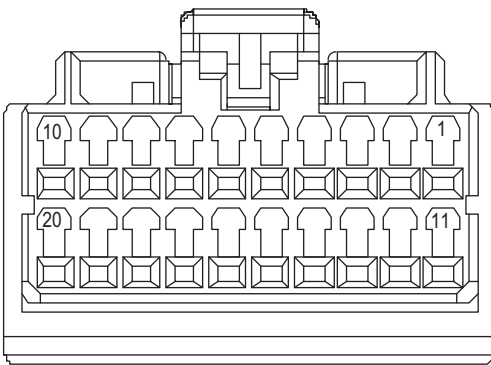

IP30

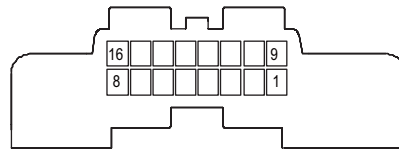

CH74

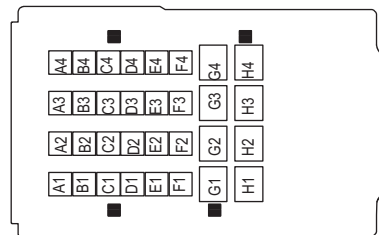

EK897047

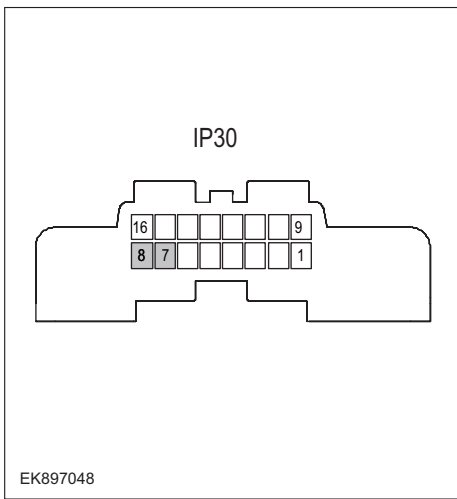
Troubleshooting steps	
Steps1	General inspection.
	<ol style="list-style-type: none"> 1 Check fuses for damage. 2 Check battery capacity. 3 Check the harness plug of GWM module for damage, poor contact, aging and looseness. 4 Check whether the result is normal or not?
	NO → Repair or replace the faulted parts.
YES ↓	
Steps2	Check fault codes.
	<ol style="list-style-type: none"> 1 Connect the fault diagnosis instrument to the diagnosis interface. 2 Turn the ignition switch to ON position.. 3 Diagnose the GWM module with diagnostic apparatus. 4 Is there any fault code other than U0132-87?
	YES → Refer to: DTC Summary list (GWM) .
NO ↓	
Steps3	Check the integrity of the CAN communication network.
	<ol style="list-style-type: none"> 1 Turn the ignition switch to OFF. 2 Measure the resistance between the diagnostic interface harness terminals. Measuring circuit: resistance between terminal 7 and terminal 8 of IP30 plug. Standard value: $\approx 60 \Omega$ 3 Check whether the result is normal or not?
	NO → Repair or replace the faulted parts.
YES ↓	

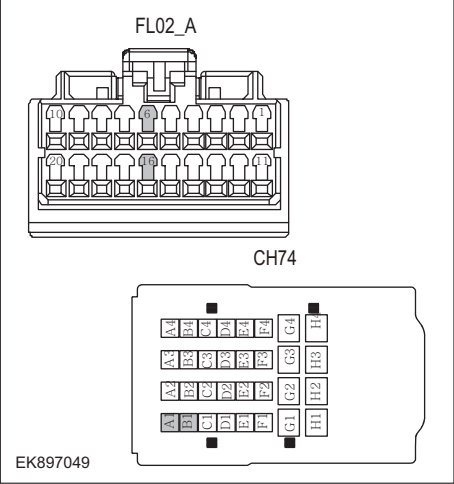
Steps4	Check the resistance of GWM and MCU.
	<ol style="list-style-type: none"> 1 Turn the ignition switch to OFF. 2 Disconnect the GWM harness plug FL02_ A. 3 Measure the resistance between the GWM harness terminals. Measuring circuit: FL02_ The resistance between terminal 6 and terminal 16 of plug A. Standard value: 110~130 Ω 4 Connect GWM harness plug FL02_ A. 5 Disconnect the MCU harness plug CH74. 6 Measure the resistance between MCU harness terminals. Measuring circuit: Resistance between terminal A1 and terminal B1 of plug CH74. Standard value: 110~130 Ω 7 Check whether the result is normal or not?
<p>NO → Repair or replace the faulted parts.</p>	
<p>YES ↓</p>	
Steps5	Check if GWM is normal.
	<ol style="list-style-type: none"> 1 Turn the ignition switch to OFF. 2 Disconnect and inspect the GWM harness plug FL02_ A. 3 Inspection and maintenance: <ul style="list-style-type: none"> • Corrosion (installing new connectors or terminals - cleaning module pins). • Damaged or bent pins - install new terminals/pins. • Pin flying - Install new pins as needed. 4 Reconnect the GWM plug and all other previously disconnected plugs. Ensure that the pin position and fixation are appropriate. 5 Run the system and determine if the problem still exists?
<p>YES → Replace GWM.</p>	
<p>NO ↓</p>	
<p>At this point, the system is operating normally. The possible cause of the problem may be module connection. Address the root cause of any connector or pin issues.</p>	
<p>Next Step ↓</p>	
<p>Diagnosis completed.</p>	

U0133-87

Fault diagnosis code
U0133-87: Lost Communication With EPS
Detection tools
1 Multimeter, diagnostic instrument
Possible causes
<ul style="list-style-type: none"> • Circuit, terminal and adapting piece fault • GWM
Conditions for fault code operation
Turn the ignition switch to ON position.
Conditions for fault code setting
U0133-87
To set the effect of a fault code condition
Description of circuit diagram
<p>The device is connected to the serial data circuit and monitors the serial data communication during normal vehicle operation. Devices exchange operational information and instructions with each other. The device has programming information that needs to be exchanged on the serial data circuit. The receiver device also monitors this information; In addition, some regular information is used to indicate the availability of the transmitter device.</p>

Circuit diagram

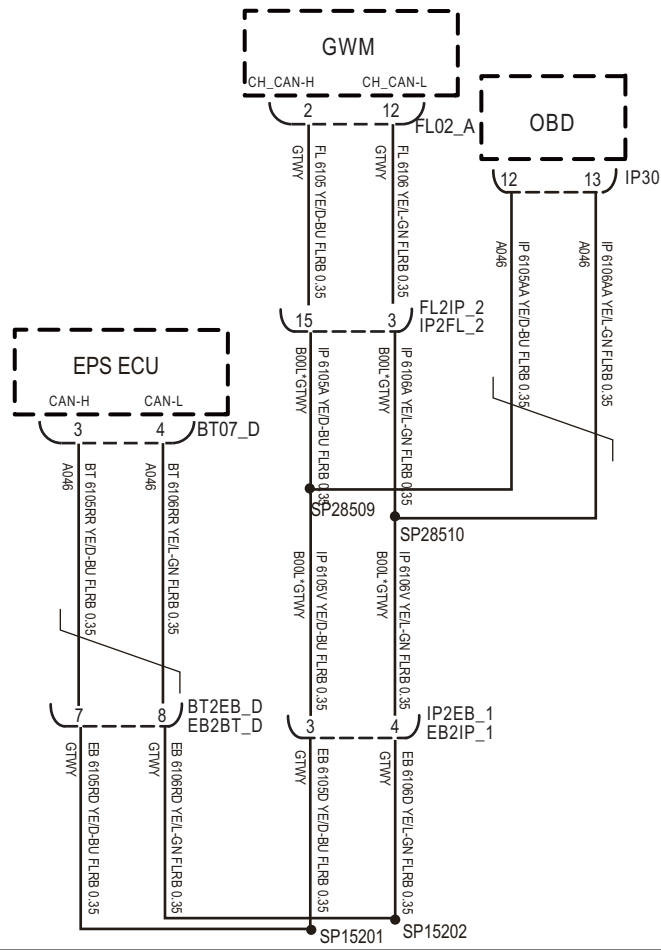

FL02_A

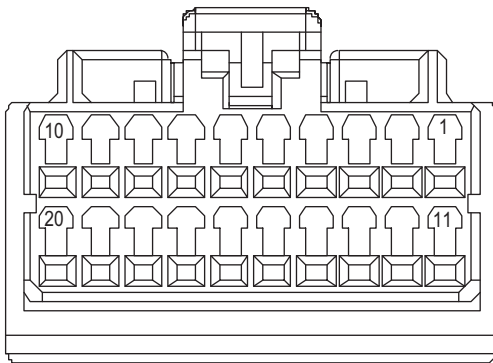

IP30

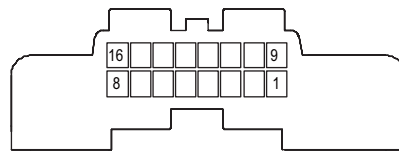

BT07_D

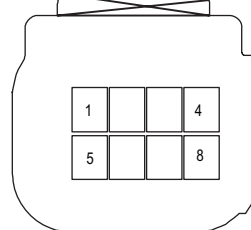

EK897050

6813247

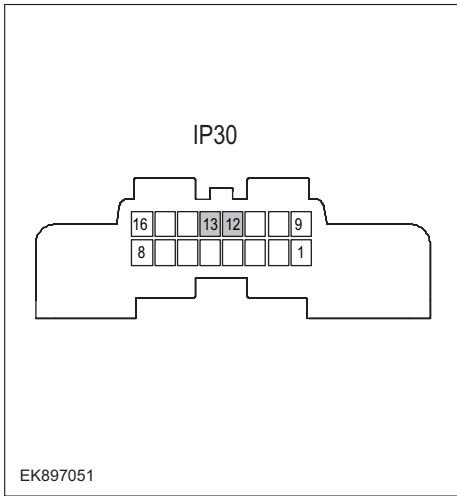
Troubleshooting steps	
Steps1	General inspection.
	<ol style="list-style-type: none"> 1 Check fuses for damage. 2 Check battery capacity. 3 Check the harness plug of GWM module for damage, poor contact, aging and looseness. 4 Check whether the result is normal or not?
	NO → Repair or replace the faulted parts.
YES ↓	
Steps2	Check fault codes.
	<ol style="list-style-type: none"> 1 Connect the fault diagnosis instrument to the diagnosis interface. 2 Turn the ignition switch to ON position.. 3 Diagnose the GWM module with diagnostic apparatus. 4 Is there any fault code other than U0133-87?
	YES → Refer to: DTC Summary list (GWM) .
NO ↓	
Steps3	Check the integrity of the CAN communication network.
	<ol style="list-style-type: none"> 1 Turn the ignition switch to OFF. 2 Measure the resistance between the diagnostic interface harness terminals. Measuring circuit: The resistance between terminal 12 and terminal 13 of IP30 plug. Standard value: $\approx 60 \Omega$ 3 Check whether the result is normal or not?
	NO → Repair or replace the faulted parts.
YES ↓	

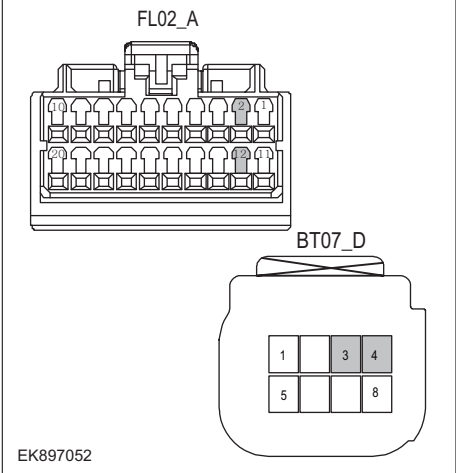
Steps4	Check the resistance of GWM and EPS.
 <p>EK897052</p>	<ol style="list-style-type: none"> 1 Turn the ignition switch to OFF. 2 Disconnect the GWM harness plug FL02_ A. 3 Measure the resistance between the GWM harness terminals. Measuring circuit: FL02_ The resistance between terminal 2 and terminal 12 of plug A. Standard value: 110~130 Ω 4 Connect GWM harness plug FL02_ A. 5 Disconnect the EPS harness plug BT07_ D. 6 Measure the resistance between the EPS harness terminals. Measuring circuit: BT07_ The resistance between terminal 3 and terminal 4 of plug D. Standard value: 110~130 Ω 7 Check whether the result is normal or not?
<p>NO → Repair or replace the faulted parts.</p>	
<p>YES ↓</p>	
Steps5	Check if GWM is normal.
	<ol style="list-style-type: none"> 1 Turn the ignition switch to OFF. 2 Disconnect and inspect the GWM harness plug FL02_ A. 3 Inspection and maintenance: <ul style="list-style-type: none"> • Corrosion (installing new connectors or terminals - cleaning module pins). • Damaged or bent pins - install new terminals/pins. • Pin flying - Install new pins as needed. 4 Reconnect the GWM plug and all other previously disconnected plugs. Ensure that the pin position and fixation are appropriate. 5 Run the system and determine if the problem still exists?
<p>YES → Replace GWM.</p>	
<p>NO ↓</p>	
<p>At this point, the system is operating normally. The possible cause of the problem may be module connection. Address the root cause of any connector or pin issues.</p>	
<p>Next Step ↓</p>	
<p>Diagnosis completed.</p>	

U2001-41、 U2002-42、 B162F-42

Fault diagnosis code
U2001-41: ECU EEPROM Checksum Error
U2002-42: ECU RAM Error
B162F-42: EEPROM(NVM) Error
Detection tools
1 Multimeter, diagnostic instrument
Possible causes
<ul style="list-style-type: none"> • Circuit,terminal and adapting piece fault • GWM
Conditions for fault code operation
Turn the ignition switch to ON position.
Conditions for fault code setting
U2001-41
U2002-42
B162F-42
To set the effect of a fault code condition
1
2
Description of circuit diagram
The GWM module will monitor whether all sensors and actuators are within normal range all the time. Meanwhile,it will check the connector for virtual connection, short circuit, open circuit and the connection rationality with other signals. When fault occurs, the GWM module will save the fault code corresponding to that fault and enable safety mode.

Circuit diagram

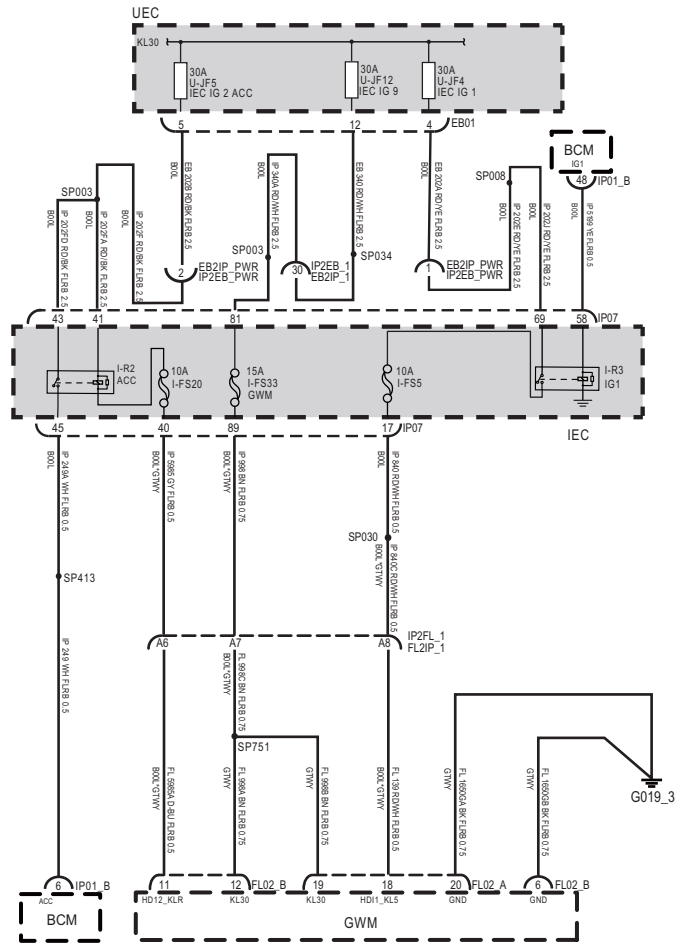

FL02_A

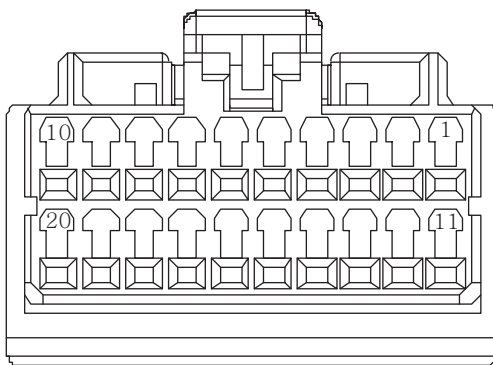

FL02_B

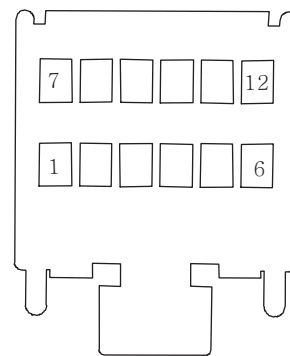

EK897001

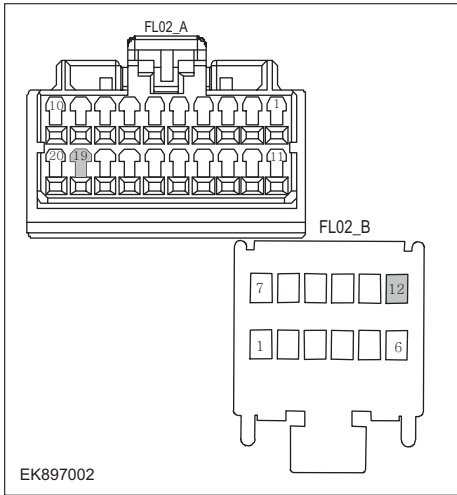
Troubleshooting steps	
Steps1	General inspection.
	<ol style="list-style-type: none"> 1 Check fuses U-JF5、 U-JF12、 U-JF4 for damage. 2 Check battery capacity. 3 Check the harness plug of GWM module for damage, poor contact, aging and looseness. 4 Check whether the result is normal or not?
	NO → Repair or replace the faulted parts.
YES ↓	
Steps2	Check fault codes.
	<ol style="list-style-type: none"> 1 Connect the fault diagnosis instrument to the diagnosis interface. 2 Turn the ignition switch to ON position.. 3 Diagnose the GWM module with diagnostic apparatus. 4 Is there any fault code other than U2001-41、 U2002-42、 B162F-42?
	YES → Refer to: DTC Summary list (GWM) .
NO ↓	
Steps3	Check the battery of GWM .
	<ol style="list-style-type: none"> 1 Turn the ignition switch to OFF. 2 Disconnect the GWM harness plug FLO2_ A、 FLO2_ B. 3 Measure the voltage between the GWM harness terminal and ground. Measuring circuit: FLO2_ Voltage between terminal 19 of plug A and ground. Measuring circuit: FLO2_ Voltage between terminal 12 of plug B and ground. Standard value: 10-14V 4 Check whether the result is normal or not?
	NO → Please repair the circuit.
YES ↓	

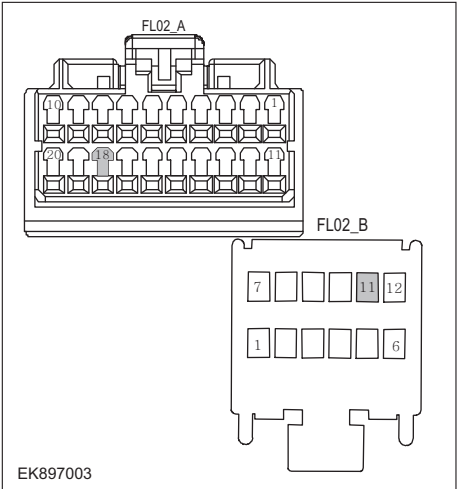
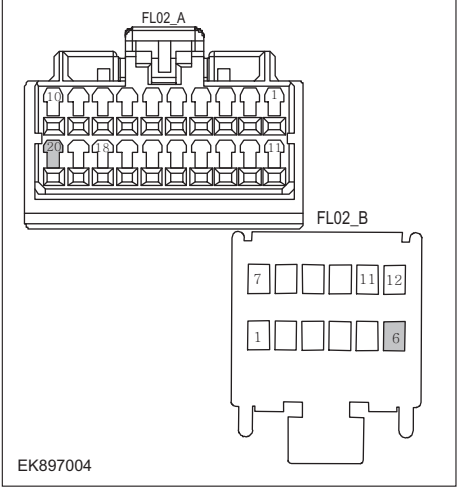
Steps4	Check the power supply voltage of GWM during startup or operation.
 <p>EK897003</p>	<ol style="list-style-type: none"> 1 Turn on the ignition. 2 Measure the voltage between the GWM harness terminal and ground. Measuring circuit: FLO2_ The voltage between terminal 11 of plug B and the grounding. Measuring circuit: FLO2_ The voltage between terminal 18 of plug A and the grounding. Standard value: 10-14V 3 Check whether the result is normal or not?
NO → Please repair the circuit.	
YES ↓	
Steps5	Check the GWM ground circuit for an open.
 <p>EK897004</p>	<ol style="list-style-type: none"> 1 Turn the ignition switch to OFF. 2 Disconnect the GWM harness plug FLO2_ A、 FLO2_ B. 3 Measure the resistance between the GWM harness plug and ground. Measuring circuit: FLO2_ The resistance between terminal 20 of plug A and the grounding. Measuring circuit: FLO2_ The resistance between terminal 6 of plug B and the grounding. Standard value:<1 Ω 4 Is the resistance less than 1 Ω?
NO → Please repair the circuit.	
YES ↓	

Steps6	Check if GWM is normal.
	<ol style="list-style-type: none"> 1 Turn the ignition switch to OFF. 2 Disconnect and check the GWM harness plug FLO2_ A, FLO2_ B. 3 Inspection and maintenance: <ul style="list-style-type: none"> • Corrosion (installing new connectors or terminals - cleaning module pins). • Damaged or bent pins - install new terminals/pins. • Pin flying - Install new pins as needed. 4 Reconnect the GWM plug and all other previously disconnected plugs. Ensure that the pin position and fixation are appropriate. 5 Run the system and determine if the problem still exists?
	YES → Replace GWM.
NO ↓	
At this point, the system is operating normally. The possible cause of the problem may be module connection. Address the root cause of any connector or pin issues.	
Next Step ↓	
Diagnosis completed.	

DTC Summary List (HCM)

DTC	English descriptions	Reference page
B1602-1C	Evaporator sensor short or open	B1602-1C
B1603-1C	PRESS sensor short or open	B1603-1C
B1604-1C	Mode motor short or open	B1604-1C
B1606-1C	Temp motor short or open	B1606-1C
B1608-1C	Compressor error	B1608-1C 、 B1611-1C
B1611-1C	COMP Error	
B1612-1C	PTC Error	B1612-1C 、 B1613-1C 、 B1614-1C
B1613-1C	COMP LIN message no receive	
B1614-1C	PTC LIN message no receive	
U3003-17	Voltage High	U3003-17 、 U3003-16
U3003-16	Voltage Low	
U0120-87	VCU CAN message no receive	U0120-87
U0155-87	IPK CAN message no receive	U0155-87
U0315-87	ABS CAN message no receive	U0315-87
U0140-87	BCM CAN message no receive	U0140-87
U0073-88	Bus Off	U0073-88

HCM

B1602-1C

Fault diagnosis code
B1602-1C: Evaporator sensor short or open
Detection tools
1 Multimeter and diagnostic apparatus
Possible causes
<ul style="list-style-type: none">• Circuit, terminal and adapting piece fault• HCM• Evaporator temperature sensor malfunction
Conditions for fault code operation
Turn the ignition switch to ON position.
Conditions for fault code setting
B1602-1C
Feedback voltage below 0.1v or above 4.9v
To set the effect of a fault code condition
Abnormal compressor control
Description of circuit diagram
The HCM monitors the evaporator temperature sensor through a low-level reference circuit and a signal circuit. The HCM detects the voltage value on the sensor that is inversely proportional to temperature. When the ambient temperature is low, the sensor resistance is high. When the ambient temperature is high, the sensor resistance is low.

Circuit diagram

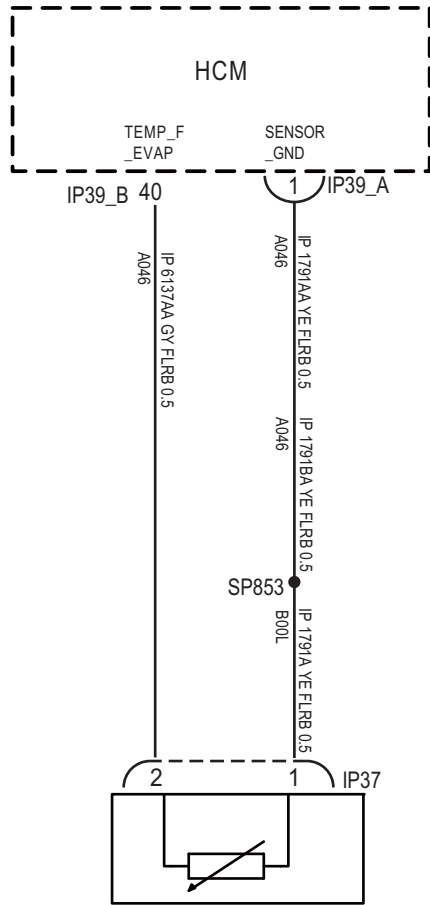

Front evaporation temperature sensor

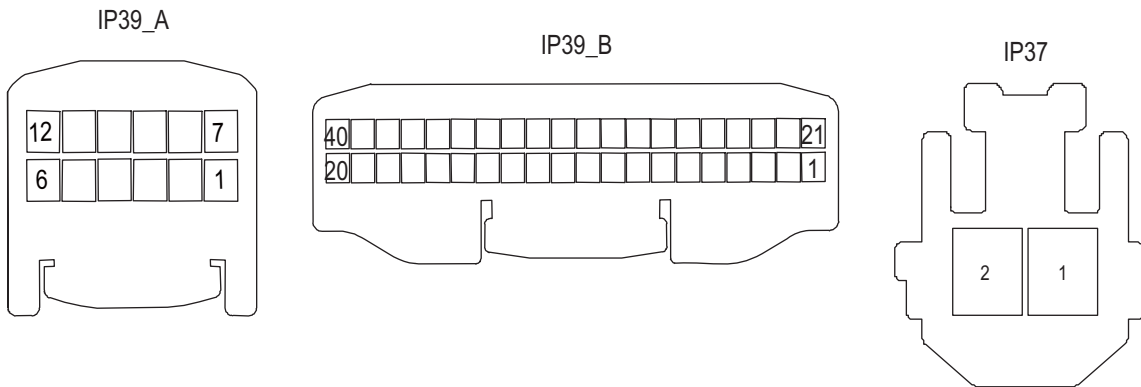

EK898001

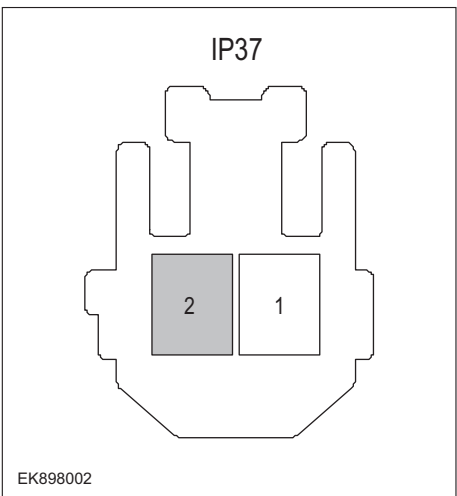
Troubleshooting procedures	
Step1	General inspection.
	<ol style="list-style-type: none"> 1 Check the fuse for damage. 2 Check battery capacity. 3 Check the evaporator temperature sensor and HCM harness plug for damage, poor contact, aging, and looseness. 4 Check whether the result is normal or not?
NO → Repair or replace the detected faulty parts.	
YES ↓	
Step2	Check fault codes.
	<ol style="list-style-type: none"> 1 Connect the fault diagnosis instrument to the diagnosis interface. 2 Turn the ignition switch to ON position. 3 Use a diagnostic tool to diagnose HCM. 4 Is there any other fault code except for B1602-1C?
YES → Refer to: DTC Summary List (HCM) .	
NO ↓	
Step3	Check the power supply circuit of the evaporator temperature sensor circuit.
	<ol style="list-style-type: none"> 1 Turn off the ignition switch. 2 Disconnect the evaporator temperature sensor harness plug. 3 Turn on the ignition. 4 Measure the voltage between the evaporator temperature sensor harness terminal and ground. Measuring circuit: The voltage between terminal 2 of the evaporator temperature sensor plug and the grounding. Standard value: 4.8~5.2V 5 Check whether the result is normal or not?
NO → Repair or replace the faulted parts.	
YES ↓	

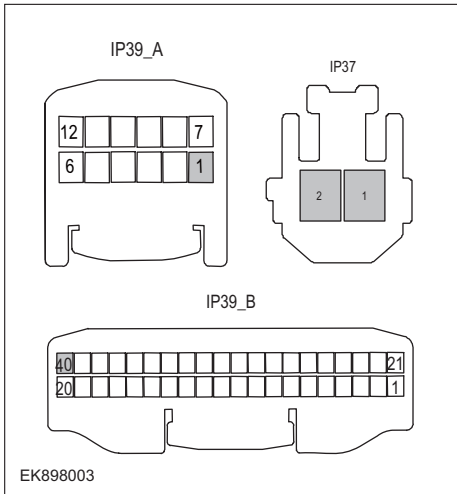
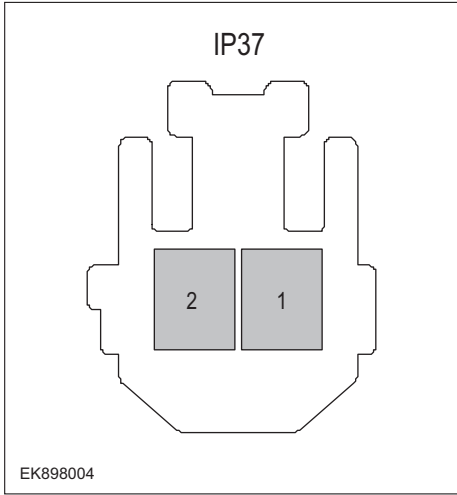
Step4	Check the evaporator temperature sensor circuit (open circuit).
	<ol style="list-style-type: none"> 1 Turn off the ignition switch. 2 Disconnect the harness plug of the air conditioning module. 3 Measure the resistance between the evaporator temperature sensor harness terminal and the air conditioning module harness terminal. Measuring circuit: The resistance between terminal 1 of the evaporator temperature sensor plug and terminal 1 of the air conditioning module plug (IP39_A). Measuring circuit: The resistance between terminal 2 of the evaporator temperature sensor plug and terminal 40 of the air conditioning module plug (IP39_B). Standard value: $\approx 0 \Omega$ 4 Check whether the result is normal or not?
NO → Repair or replace the faulted parts.	
YES ↓	
Step5	Check the evaporator temperature sensor circuit (short circuit).
	<ol style="list-style-type: none"> 1 Turn off the ignition switch. 2 Measure the resistance between the harness plug of the evaporator temperature sensor and ground. Measuring circuit: The resistance between terminal 1 of the evaporator temperature sensor plug and the grounding. Measuring circuit: The resistance between terminal 2 of the evaporator temperature sensor plug and the grounding. Standard value: infinity 3 Measure the voltage between the harness plug of the evaporator temperature sensor and ground. Measuring circuit: The voltage between terminal 1 of the evaporator temperature sensor plug and the grounding. Measuring circuit: The voltage between terminal 2 of the evaporator temperature sensor plug and the grounding. Standard value: $\approx 0V$ 4 Check whether the result is normal or not?
NO → Repair or replace the faulted parts.	
YES ↓	

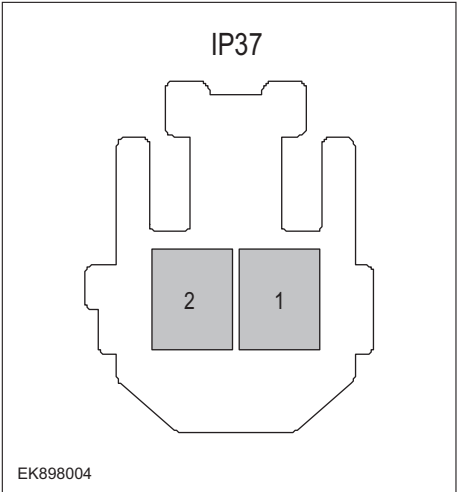
Step6	Check the evaporator temperature sensor (component inspection).
	<ol style="list-style-type: none"> 1 Measure the resistance of the evaporator temperature sensor terminal directly. Measuring circuit: The resistance between terminal 1 and terminal 2 of the evaporator temperature sensor plug. Standard value: 2 Measure the resistance between the evaporator temperature sensor terminal and the housing. Measuring circuit: The resistance between terminal 1 of the evaporator temperature sensor plug and the housing. Measuring circuit: The resistance between terminal 2 of the evaporator temperature sensor plug and the housing. Standard value: infinity 3 Check whether the result is normal or not?
<p>NO → Replace the temperature sensor.</p>	
<p>YES ↓</p>	
Step7	Check if there are any abnormalities in the HCM.
	<ol style="list-style-type: none"> 1 Turn off the ignition switch. 2 Disconnect and inspect the HCM harness plug. 3 Inspection and maintenance: <ul style="list-style-type: none"> • Corrosion (installing new connectors or terminals - cleaning module pins). • Damaged or bent pins - install new terminals/pins. • Pin flying - Install new pins as needed. 4 Reconnect the HCM plug and all other previously disconnected plugs. Ensure that the pin position and fixation are appropriate. 5 Run the system and determine if the problem still exists?
<p>YES → Replace the HCM.</p>	
<p>NO ↓</p>	
<p>At this point, the system is operating normally. The possible cause of the problem may be module connection. Address the root cause of any connector or pin issues.</p>	
<p>Next Step ↓</p>	
<p>Diagnosis completed.</p>	

B1603-1C

Fault diagnosis code
B1603-1C: PRESS sensor short or open
Detection tools
1 Multimeter and diagnostic apparatus
Possible causes
<ul style="list-style-type: none"> • Circuit, terminal and adapting piece fault • HCM • Evaporator temperature sensor malfunction
Conditions for fault code operation
Turn the ignition switch to ON position.
Conditions for fault code setting
B1603-1C
To set the effect of a fault code condition
Abnormal compressor control
Description of circuit diagram
The HCM monitors the evaporator temperature sensor through a low-level reference circuit and a signal circuit. The HCM detects the voltage value on the sensor that is inversely proportional to temperature. When the ambient temperature is low, the sensor resistance is high. When the ambient temperature is high, the sensor resistance is low.

Circuit diagram

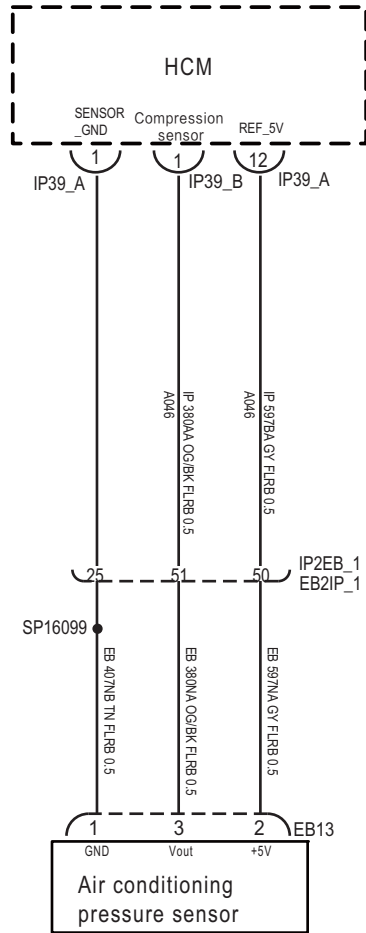

IP39_A

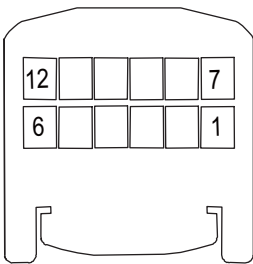

IP39_B

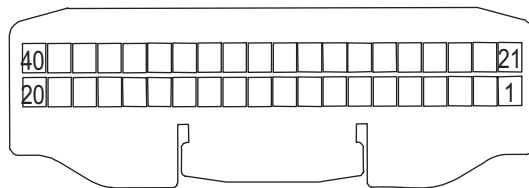

EB13

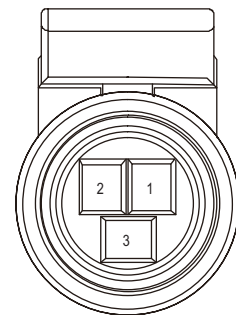

EK898005

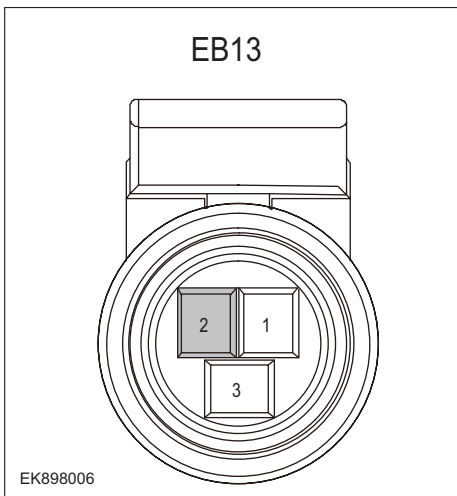
Troubleshooting procedures	
Step1	General inspection.
	<ol style="list-style-type: none"> 1 Check the fuse for damage. 2 Check battery capacity. 3 Check the evaporator temperature sensor and HCM harness plug for damage, poor contact, aging, and looseness. 4 Check whether the result is normal or not?
	NO → Repair or replace the detected faulty parts.
YES ↓	
Step2	Check fault codes.
	<ol style="list-style-type: none"> 1 Connect the fault diagnosis instrument to the diagnosis interface. 2 Turn the ignition switch to ON position. 3 Use a diagnostic tool to diagnose HCM. 4 Is there any other fault code except for B1603-1C?
	YES → Refer to: DTC Summary List (HCM) .
NO ↓	
Step3	Check the power supply circuit of the pressure sensor circuit.
	<ol style="list-style-type: none"> 1 Turn off the ignition switch. 2 Disconnect the pressure sensor harness plug. 3 Turn on the ignition. 4 Measure the voltage between the pressure sensor harness terminal and ground. Measuring circuit: The voltage between terminal 2 of the pressure sensor plug and the grounding. Standard value: 4.8~5.2V 5 Check whether the result is normal or not?
	NO → Repair or replace the faulted parts.
YES ↓	

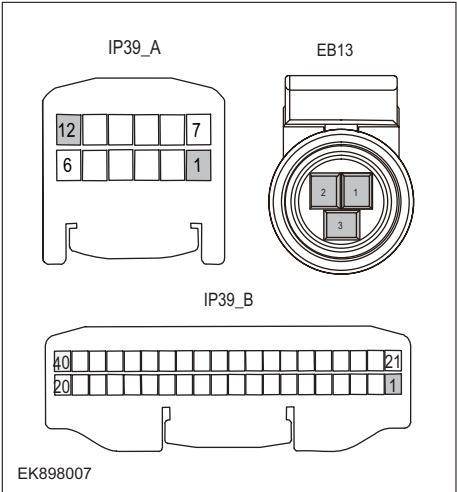
Step4	Check the evaporator temperature sensor circuit (open circuit).
 <p>IP39_A</p> <p>EB13</p> <p>IP39_B</p> <p>EK898007</p>	<ol style="list-style-type: none"> 1 Turn off the ignition switch. 2 Disconnect the harness plug of the air conditioning module. 3 Measure the resistance between the pressure sensor harness terminal and the air conditioning module harness terminal. <ul style="list-style-type: none"> Measuring circuit: The resistance between terminal 1 of the pressure sensor plug and terminal 1 of the air conditioning module plug (IP39_A). Measuring circuit: The resistance between terminal 2 of the pressure sensor plug and terminal 12 of the air conditioning module plug (IP39_A). Measuring circuit: The resistance between terminal 3 of the pressure sensor plug and terminal 1 of the air conditioning module plug (IP39_B). <p>Standard value: $\approx 0 \Omega$</p> 4 Check whether the result is normal or not?
	<p>NO → Repair or replace the faulted parts.</p>
<p>YES ↓</p>	

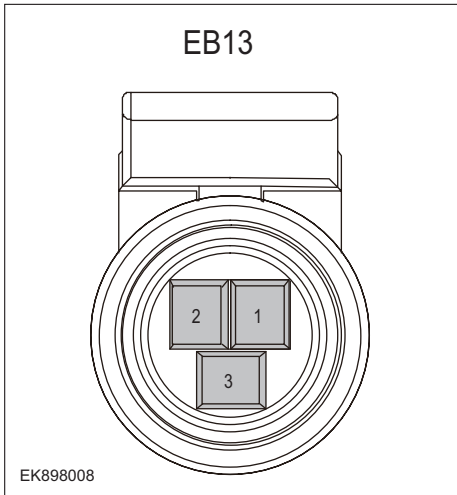
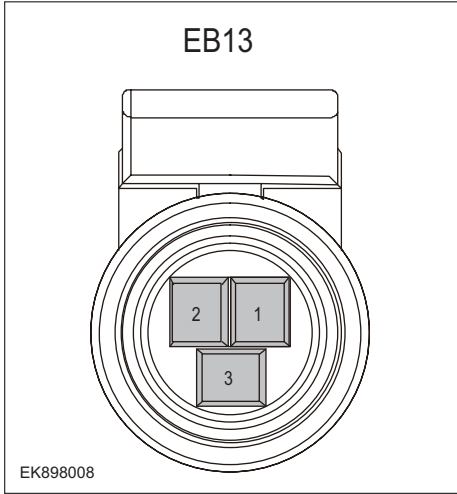
Step5	Check the pressure sensor circuit (short circuit).
 <p>EB13</p> <p>EK898008</p>	<ol style="list-style-type: none"> 1 Turn off the ignition switch. 2 Measure the resistance between the pressure sensor harness plug and ground. Measuring circuit: The resistance between terminal 1 of the pressure sensor plug and the grounding. Measuring circuit: The resistance between terminal 2 of the pressure sensor plug and the grounding. Measuring circuit: The resistance between terminal 3 of the pressure sensor plug and the grounding. Standard value: infinity 3 Measure the voltage between the pressure sensor harness plug and ground. Measuring circuit: The voltage between terminal 1 of the pressure sensor plug and the grounding. Measuring circuit: The voltage between terminal 2 of the pressure sensor plug and the grounding. Measuring circuit: The voltage between terminal 3 of the pressure sensor plug and the grounding. Standard value: ≈ 0V 4 Check whether the result is normal or not?
NO → Repair or replace the faulted parts.	
YES ↓	
Step6	Check the evaporator temperature sensor (component inspection).
 <p>EB13</p> <p>EK898008</p>	<ol style="list-style-type: none"> 1 Measure the resistance of the pressure sensor terminals directly. Measuring circuit: The resistance between terminal 1 and terminal 2 of the pressure sensor plug. Standard value: 2 Measure the resistance between the pressure sensor terminal and the housing. Measuring circuit: The resistance between terminal 1 of the pressure sensor plug and the housing. Measuring circuit: The resistance between terminal 2 of the pressure sensor plug and the housing. Measuring circuit: The resistance between terminal 3 of the pressure sensor plug and the housing. Standard value: infinity 3 Check whether the result is normal or not?
NO → Replace the temperature sensor.	
YES ↓	

HCM

Step7	Check if there are any abnormalities in the HCM.
	<ol style="list-style-type: none">1 Turn off the ignition switch.2 Disconnect and inspect the HCM harness plug.3 Inspection and maintenance:<ul style="list-style-type: none">• Corrosion (installing new connectors or terminals - cleaning module pins).• Damaged or bent pins - install new terminals/pins.• Pin flying - Install new pins as needed.4 Reconnect the HCM plug and all other previously disconnected plugs. Ensure that the pin position and fixation are appropriate.5 Run the system and determine if the problem still exists?
	YES → Replace the HCM.
NO ↓	
At this point, the system is operating normally. The possible cause of the problem may be module connection. Address the root cause of any connector or pin issues.	
Next Step ↓	
Diagnosis completed.	

B1604-1C

Fault diagnosis code
B1604-1C: Mode motor short or open
Detection tools
1 Multimeter and diagnostic apparatus
Possible causes
<ul style="list-style-type: none"> • Circuit, terminal and adapting piece fault • HCM • Mode motor failure
Conditions for fault code operation
Turn the ignition switch to ON position.
Conditions for fault code setting
B1604-1C
Feedback voltage below 0.1v or above 4.9v
To set the effect of a fault code condition
Abnormal adjustment of air conditioning mode
Description of circuit diagram
The mode motor is supplied with power through the air conditioning controller, and the air conditioning controller module monitors the condition of the mode motor through the connection harness and controls it.

Circuit diagram

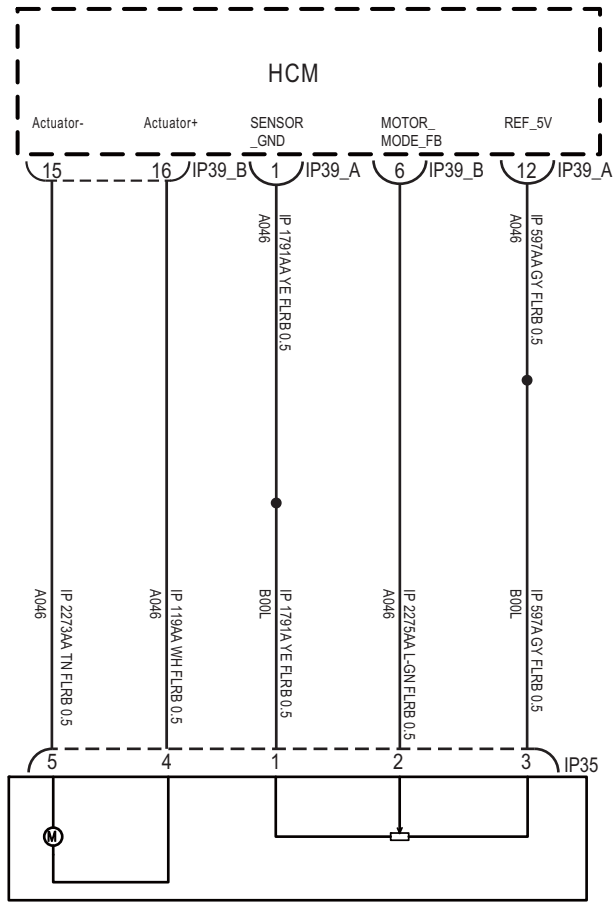

Mode damper actuator

IP39_A

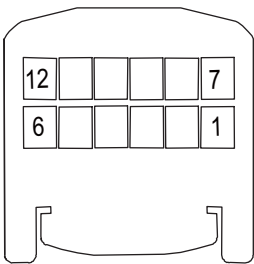

IP39_B

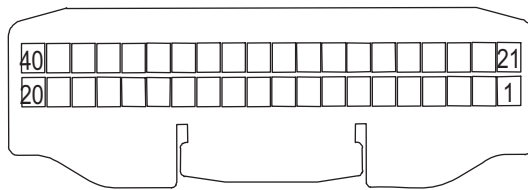

IP35

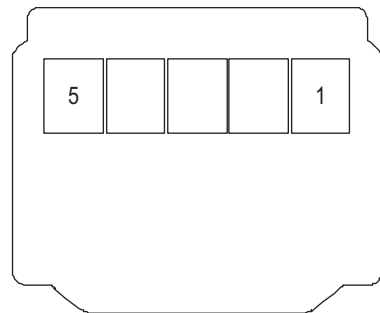

EK898009

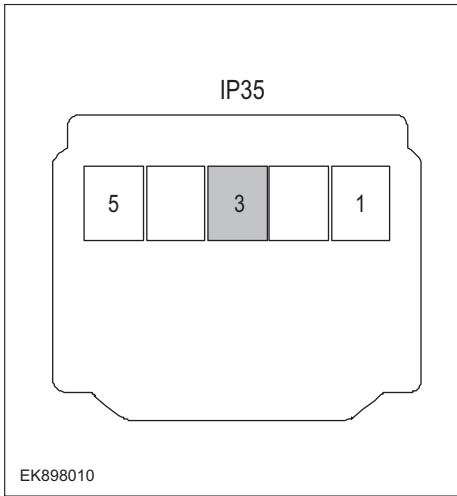
Troubleshooting procedures	
Step1	General inspection.
	<ol style="list-style-type: none"> 1 Check the fuse for damage. 2 Check battery capacity. 3 Check the mode motor and HCM harness plugs for damage, poor contact, aging, and looseness. 4 Check whether the result is normal or not?
	NO → Repair or replace the detected faulty parts.
YES ↓	
Step2	Check fault codes.
	<ol style="list-style-type: none"> 1 Connect the fault diagnosis instrument to the diagnosis interface. 2 Turn the ignition switch to ON position. 3 Use a diagnostic tool to diagnose HCM. 4 Is there any other fault code except for B1604-1C?
	YES → Refer to: DTC Summary List (HCM) .
NO ↓	
Step3	Check the power supply circuit of the mode motor circuit.
	<ol style="list-style-type: none"> 1 Turn off the ignition switch. 2 Disconnect the mode motor harness plug. 3 Turn on the ignition. 4 Measure the voltage between the harness terminal of the mode motor and ground. Measuring circuit: The voltage between terminal 3 of the mode motor plug and the grounding. Standard value: 4.8~5.2V 5 Check whether the result is normal or not?
	NO → Repair or replace the faulted parts.
YES ↓	

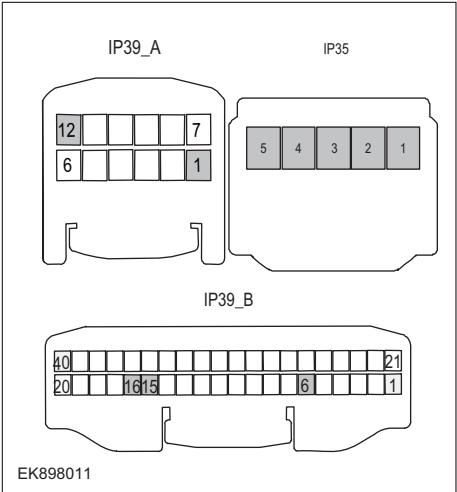
Step4	Check the mode motor circuit (open circuit).
 <p data-bbox="212 719 288 736">EK898011</p>	<ol style="list-style-type: none"> 1 Turn off the ignition switch. 2 Disconnect the harness plug of the air conditioning module. 3 Measure the resistance between the harness terminals of the mode motor and the harness terminals of the air conditioning module. <ul style="list-style-type: none"> Measuring circuit: The resistance between terminal 1 of the mode motor plug and terminal 1 of the air conditioning module plug (IP39_A). Measuring circuit: The resistance between terminal 2 of the mode motor plug and terminal 6 of the air conditioning module plug (IP39_B). Measuring circuit: The resistance between terminal 3 of the mode motor plug and terminal 12 of the air conditioning module plug (IP39_A). Measuring circuit: The resistance between terminal 4 of the mode motor plug and terminal 16 of the air conditioning module plug (IP39_B). Measuring circuit: The resistance between terminal 5 of the mode motor plug and terminal 15 of the air conditioning module plug (IP39_B). <p>Standard value: $\approx 0 \Omega$</p> 4 Check whether the result is normal or not?
NO → Repair or replace the faulted parts.	
YES ↓	
Step5	Check the mode motor circuit (short circuit).

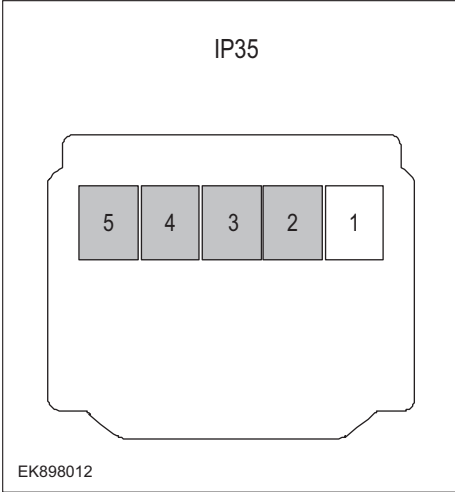
 <p style="text-align: center;">IP35</p> <p style="text-align: center;">EY898012</p>	<ol style="list-style-type: none"> 1 Turn off the ignition switch. 2 Measure the resistance between the harness plug of the mode motor and ground. <ul style="list-style-type: none"> Measuring circuit: The resistance between terminal 2 of the mode motor plug and the grounding. Measuring circuit: The resistance between terminal 3 of the mode motor plug and the grounding. Measuring circuit: The resistance between terminal 4 of the mode motor plug and the grounding. Measuring circuit: The resistance between terminal 5 of the mode motor plug and the grounding. <p>Standard value: infinity</p> 3 Measure the voltage between the harness plug of the mode motor and ground. <ul style="list-style-type: none"> Measuring circuit: The voltage between terminal 2 of the mode motor plug and the grounding. Measuring circuit: The voltage between terminal 3 of the mode motor plug and the grounding. Measuring circuit: The voltage between terminal 4 of the mode motor plug and the grounding. Measuring circuit: The voltage between terminal 5 of the mode motor plug and the grounding. <p>Standard value: ≈ 0V</p> 4 Check whether the result is normal or not?
<p>YES ↓</p>	<p>NO → Repair or replace the faulted parts.</p>

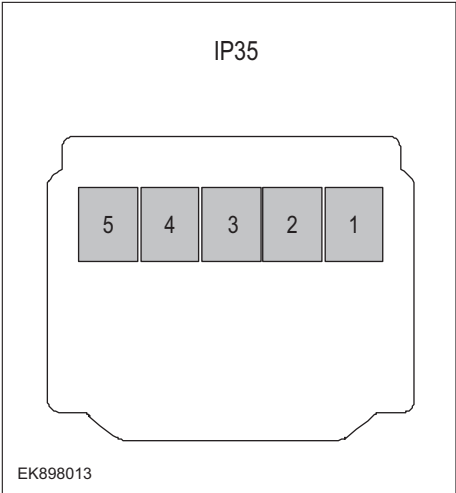
Step6	Check the mode motor (component inspection).
<div style="text-align: center;"> <p>IP35</p>  <p>EK898013</p> </div>	<ol style="list-style-type: none"> 1 Measure the resistance of the mode motor terminals directly. Measuring circuit: The resistance between terminal 2 and terminal 3 of the mode motor plug. Standard value: Measuring circuit: The resistance between terminal 4 and terminal 5 of the mode motor plug. Standard value: 2 Measure the resistance between the terminal of the mode motor and the housing. Measuring circuit: The resistance between terminal 1 of the mode motor plug and the housing. Measuring circuit: The resistance between terminal 2 of the mode motor plug and the housing. Measuring circuit: The resistance between terminal 3 of the mode motor plug and the housing. Measuring circuit: The resistance between terminal 4 of the mode motor plug and the housing. Measuring circuit: The resistance between terminal 5 of the mode motor plug and the housing. Standard value: infinity 3 Check whether the result is normal or not?
	<p>NO → Replace the mode motor.</p>
<p>YES ↓</p>	

Step7	Check if there are any abnormalities in the HCM.
	<ol style="list-style-type: none"> 1 Turn off the ignition switch. 2 Disconnect and inspect the HCM harness plug. 3 Inspection and maintenance: <ul style="list-style-type: none"> • Corrosion (installing new connectors or terminals - cleaning module pins). • Damaged or bent pins - install new terminals/pins. • Pin flying - Install new pins as needed. 4 Reconnect the HCM plug and all other previously disconnected plugs. Ensure that the pin position and fixation are appropriate. 5 Run the system and determine if the problem still exists?
	YES → Replace the HCM.
NO ↓	
At this point, the system is operating normally. The possible cause of the problem may be module connection. Address the root cause of any connector or pin issues.	
Next Step ↓	
Diagnosis completed.	

HCM

B1606-1C

Fault diagnosis code
B1606-1C: Temp motor short or open
Detection tools
1 Multimeter and diagnostic apparatus
Possible causes
<ul style="list-style-type: none">• Circuit, terminal and adapting piece fault• HCM• Cooling and heating motor malfunction
Conditions for fault code operation
Turn the ignition switch to ON position.
Conditions for fault code setting
B1606-1C
The feedback voltage of the temperature motor deviates greatly from the target value
To set the effect of a fault code condition
Abnormal air conditioning temperature setting
Description of circuit diagram
The temperature motor is supplied with power through the air conditioning controller, and the air conditioning controller module monitors the condition of the heating and cooling motor through the connection harness and controls it.

Circuit diagram

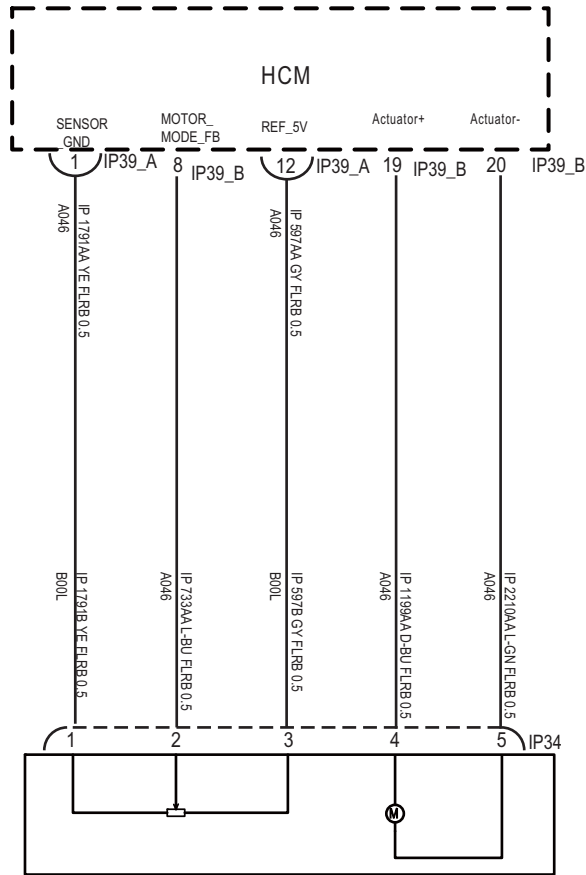

Temperature damper actuator

IP39_A

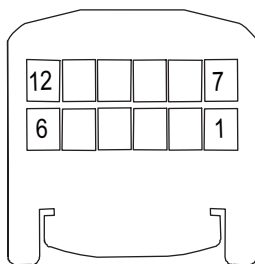

IP39_B

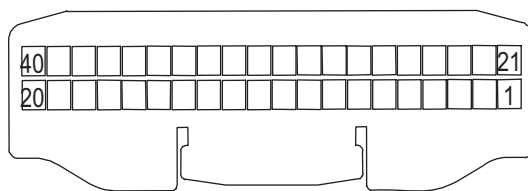

IP34

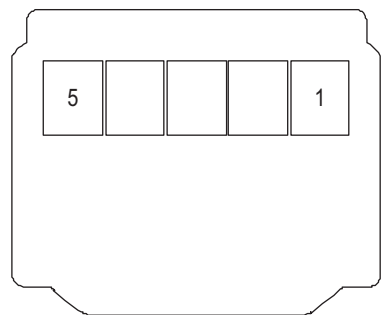

EK898014

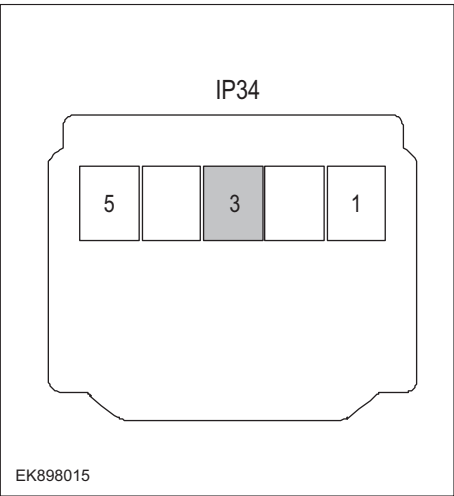
Troubleshooting procedures	
Step1	General inspection.
	<ol style="list-style-type: none"> 1 Check the fuse for damage. 2 Check battery capacity. 3 Check the temperature motor and HCM harness plugs for damage, poor contact, aging, and looseness. 4 Check whether the result is normal or not?
<p>NO → Repair or replace the detected faulty parts.</p>	
<p>YES ↓</p>	
Step2	Check fault codes.
	<ol style="list-style-type: none"> 1 Connect the fault diagnosis instrument to the diagnosis interface. 2 Turn the ignition switch to ON position. 3 Use a diagnostic tool to diagnose HCM. 4 Is there any other fault code except for B1605-1C?
<p>YES → Refer to: DTC Summary List (HCM).</p>	
<p>NO ↓</p>	
Step3	Check the power supply circuit of the cooling and heating motor circuit.
	<ol style="list-style-type: none"> 1 Turn off the ignition switch. 2 Disconnect the wiring harness plug of the heating and cooling motor. 3 Turn on the ignition. 4 Measure the voltage between the harness terminal of the heating and cooling motor and the grounding. Measuring circuit: The voltage between terminal 3 of the cooling and heating motor plug and the grounding. Standard value: 4.8~5.2V 5 Check whether the result is normal or not?
<p>NO → Repair or replace the faulted parts.</p>	
<p>YES ↓</p>	

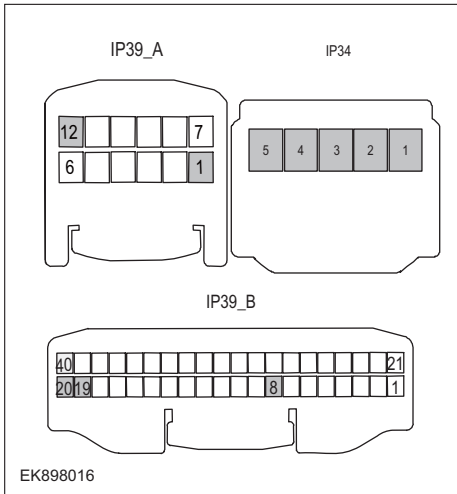
Step4	Check the cooling and heating motor circuit (open circuit).
	<ol style="list-style-type: none"> 1 Turn off the ignition switch. 2 Disconnect the harness plug of the air conditioning module. 3 Measure the resistance between the harness terminals of the heating and cooling motor and the harness terminals of the air conditioning module. <ul style="list-style-type: none"> Measuring circuit: The resistance between terminal 1 of the cooling and heating motor plug and terminal 1 of the air conditioning module plug (IP39_A). Measuring circuit: The resistance between terminal 2 of the cooling and heating motor plug and terminal 8 of the air conditioning module plug (IP39_B). Measuring circuit: The resistance between terminal 3 of the cooling and heating motor plug and terminal 12 of the air conditioning module plug (IP39_A). Measuring circuit: The resistance between terminal 4 of the cooling and heating motor plug and terminal 19 of the air conditioning module plug (IP39_B). Measuring circuit: The resistance between terminal 5 of the cooling and heating motor plug and terminal 20 of the air conditioning module plug (IP39_B). <p>Standard value: $\approx 0 \Omega$</p> 4 Check whether the result is normal or not?
<p>NO → Repair or replace the faulted parts.</p>	
<p>YES ↓</p>	
Step5	Check the cooling and heating motor circuit (short circuit).

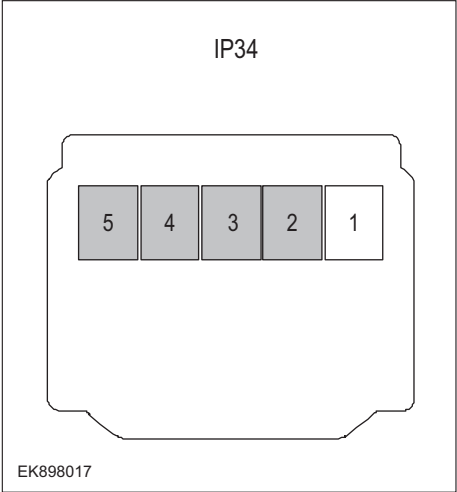
 <p>IP34</p> <p>EK898017</p>	<ol style="list-style-type: none"> 1 Turn off the ignition switch. 2 Measure the resistance between the harness plug of the heating and cooling motor and ground. <ul style="list-style-type: none"> Measuring circuit: The resistance between terminal 2 of the cooling and heating motor plug and the grounding. Measuring circuit: The resistance between terminal 3 of the cooling and heating motor plug and the grounding. Measuring circuit: The resistance between terminal 4 of the cooling and heating motor plug and the grounding. Measuring circuit: The resistance between terminal 5 of the cooling and heating motor plug and the grounding. <p>Standard value: infinity</p> 3 Measure the voltage between the harness plug of the heating and cooling motor and the grounding. <ul style="list-style-type: none"> Measuring circuit: The voltage between terminal 2 of the cooling and heating motor plug and the grounding. Measuring circuit: The voltage between terminal 3 of the cooling and heating motor plug and the grounding. Measuring circuit: The voltage between terminal 4 of the cooling and heating motor plug and the grounding. Measuring circuit: The voltage between terminal 5 of the cooling and heating motor plug and the grounding. <p>Standard value: ≈ 0V</p> 4 Check whether the result is normal or not?
<p>NO → Repair or replace the faulted parts.</p>	
<p>YES ↓</p>	
<p>Step6</p>	<p>Check the heating and cooling motor (component inspection).</p>

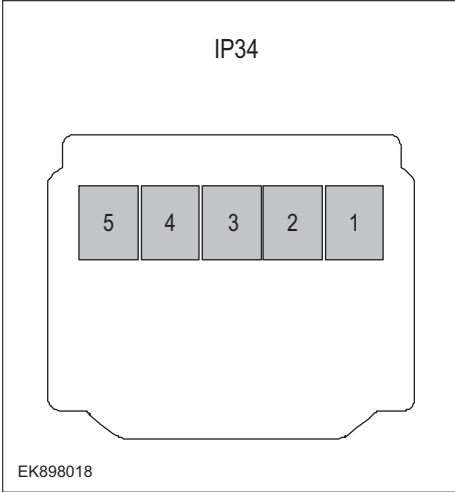
<div style="text-align: center;"> <p>IP34</p>  <p>EK898018</p> </div>	<ol style="list-style-type: none"> 1 Measure the resistance of the cooling and heating motor terminals directly. Measuring circuit: The resistance between terminal 2 and terminal 3 of the cooling and heating motor plug. Standard value: Measuring circuit: The resistance between terminal 4 and terminal 5 of the cooling and heating motor plug. Standard value: 2 Measure the resistance between the terminals of the heating and cooling motor and the housing. Measuring circuit: The resistance between terminal 1 of the cooling and heating motor plug and the housing. Measuring circuit: The resistance between terminal 2 of the cooling and heating motor plug and the housing. Measuring circuit: The resistance between terminal 3 of the cooling and heating motor plug and the housing. Measuring circuit: The resistance between terminal 4 of the cooling and heating motor plug and the housing. Measuring circuit: The resistance between terminal 5 of the cooling and heating motor plug and the housing. Standard value: infinity 3 Check whether the result is normal or not?
	<p>NO → Replace the heating and cooling motor.</p>
<p>YES ↓</p>	

HCM

Step7	Check if there are any abnormalities in the HCM.
	<ol style="list-style-type: none">1 Turn off the ignition switch.2 Disconnect and inspect the HCM harness plug.3 Inspection and maintenance:<ul style="list-style-type: none">• Corrosion (installing new connectors or terminals - cleaning module pins).• Damaged or bent pins - install new terminals/pins.• Pin flying - Install new pins as needed.4 Reconnect the HCM plug and all other previously disconnected plugs. Ensure that the pin position and fixation are appropriate.5 Run the system and determine if the problem still exists?
	YES → Replace the HCM.
NO ↓	
At this point, the system is operating normally. The possible cause of the problem may be module connection. Address the root cause of any connector or pin issues.	
Next Step ↓	
Diagnosis completed.	

B1608-1C、 B1611-1C

Fault diagnosis code
B1608-1C: Compressor error
B1611-1C: COMP Error
Detection tools
1 Multimeter and diagnostic apparatus
Possible causes
<ul style="list-style-type: none"> • Circuit,terminal and adapting piece fault • HCM • Air conditioning compressor malfunction • fuse
Conditions for fault code operation
Turn the ignition switch to ON position.
Conditions for fault code setting
B1608-1C
Compressor error
B1611-1C
To set the effect of a fault code condition
Abnormal air conditioning cooling
Description of circuit diagram

Circuit diagram

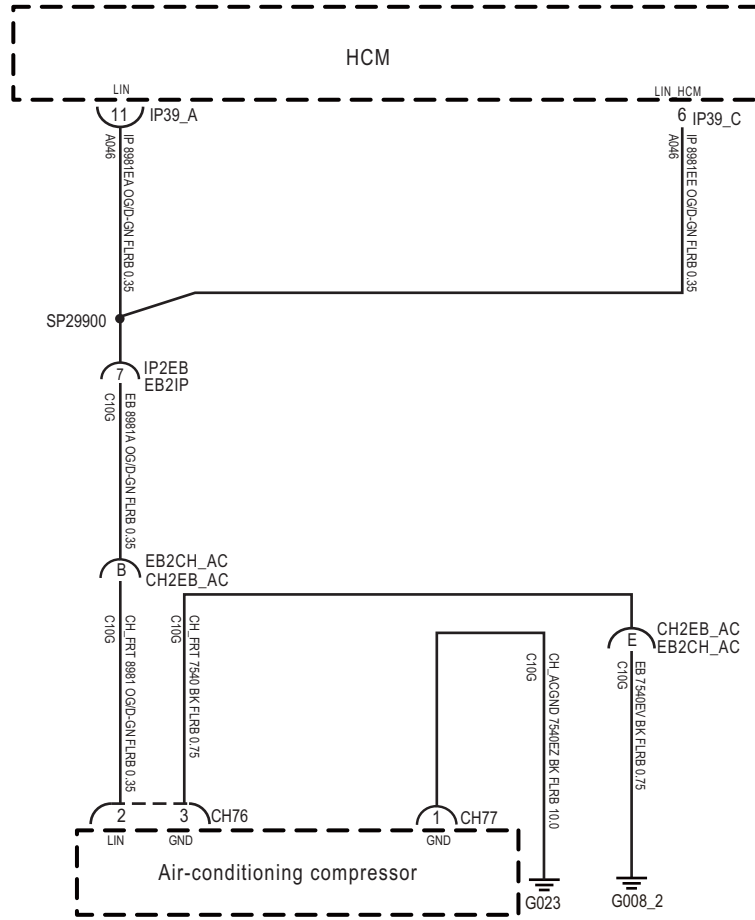

IP39_A

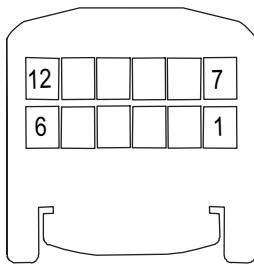

IP39_C

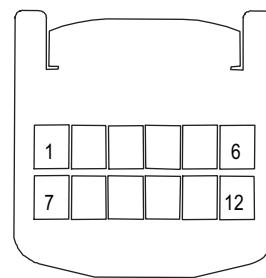

EK898019

Troubleshooting procedures	
Step1	General inspection.
	<ol style="list-style-type: none"> 1 Check the fuse for damage. 2 Check battery capacity. 3 Check the air conditioning compressor and HCM harness plugs for damage, poor contact, aging, and looseness. 4 Check whether the result is normal or not?
	NO → Repair or replace the detected faulty parts.
YES ↓	
Step2	Check fault codes.
	<ol style="list-style-type: none"> 1 Connect the fault diagnosis instrument to the diagnosis interface. 2 Turn the ignition switch to ON position. 3 Use a diagnostic tool to diagnose HCM. 4 Is there any other fault code except for B1608-1C、B1611-1C?
	YES → Refer to: DTC Summary List (HCM) .
NO ↓	
Step3	Check the power supply voltage of the air conditioning compressor during startup or operation.
	<ol style="list-style-type: none"> 1 Turn on the ignition. 2 Measure the voltage between the harness terminal of the air conditioning compressor and ground. Measuring circuit: The voltage between terminal 1 of the air conditioning compressor plug and the grounding. Standard value:10~14V 3 Check whether the result is normal or not?
	NO → Repair or replace the faulted parts.
YES ↓	

Step4	Check the ground circuit of the air conditioning compressor for an open circuit.	
	<ol style="list-style-type: none"> 1 Turn off the ignition switch. 2 Disconnect the wiring harness plug of the air conditioning compressor. 3 Measure the resistance between the harness plug of the air conditioning compressor and ground. Measuring circuit: The resistance between terminal 3 of the air conditioning compressor plug and the grounding. Standard value:< 1Ω 4 Is the resistance less than 1 Ω? 	
		NO → Repair or replace the faulted parts.
YES ↓		
Step5	Check the LIN communication circuit between the air conditioning module and the air conditioning compressor (open circuit).	
	<ol style="list-style-type: none"> 1 Turn off the ignition switch. 2 Disconnect the harness plug of the air conditioning module. 3 Measure the resistance between the harness terminals of the air conditioning compressor and the harness terminals of the air conditioning module. Measuring circuit: The resistance between terminal 2 of the air conditioning compressor plug and terminal 11 of the air conditioning module plug. Standard value: ≈ 0 Ω 4 Check whether the result is normal or not? 	
		NO → Repair or replace the faulted parts.
YES ↓		

Step6	Check the LIN communication circuit of the air conditioning compressor (short circuit).
	<ol style="list-style-type: none"> 1 Turn off the ignition switch. 2 Measure the resistance between the harness plug of the air conditioning compressor and ground. Measuring circuit: The resistance between terminal 2 of the air conditioning compressor plug and the grounding. Standard value: infinity 3 Measure the voltage between the harness plug of the mode motor and ground. Measuring circuit: The voltage between terminal 2 of the air conditioning compressor plug and the grounding. Standard value: ≈ 0V 4 Check whether the result is normal or not?
NO → Repair or replace the faulted parts.	
YES ↓	
Step7	Check if there are any abnormalities in the HCM.
	<ol style="list-style-type: none"> 1 Turn off the ignition switch. 2 Disconnect and inspect the HCM harness plug. 3 Inspection and maintenance: <ul style="list-style-type: none"> • Corrosion (installing new connectors or terminals - cleaning module pins). • Damaged or bent pins - install new terminals/pins. • Pin flying - Install new pins as needed. 4 Reconnect the HCM plug and all other previously disconnected plugs. Ensure that the pin position and fixation are appropriate. 5 Run the system and determine if the problem still exists?
YES → Replace the HCM.	
NO ↓	
At this point, the system is operating normally. The possible cause of the problem may be module connection. Address the root cause of any connector or pin issues.	
Next Step ↓	
Diagnosis completed.	

HCM

B1612-1C、 B1613-1C、 B1614-1C

Fault diagnosis code
B1612-1C: PTC Error
B1613-1C: COMP LIN message no receive
B1614-1C: PTC LIN message no receive
Detection tools
1 Multimeter and diagnostic apparatus
Possible causes
<ul style="list-style-type: none">• Circuit,terminal and adapting piece fault• HCM• Air conditioning compressor malfunction• fuse
Conditions for fault code operation
Turn the ignition switch to ON position.
Conditions for fault code setting
B1612-1C
B1613-1C
B1614-1C
To set the effect of a fault code condition
Abnormal air conditioning cooling
Description of circuit diagram

Circuit diagram

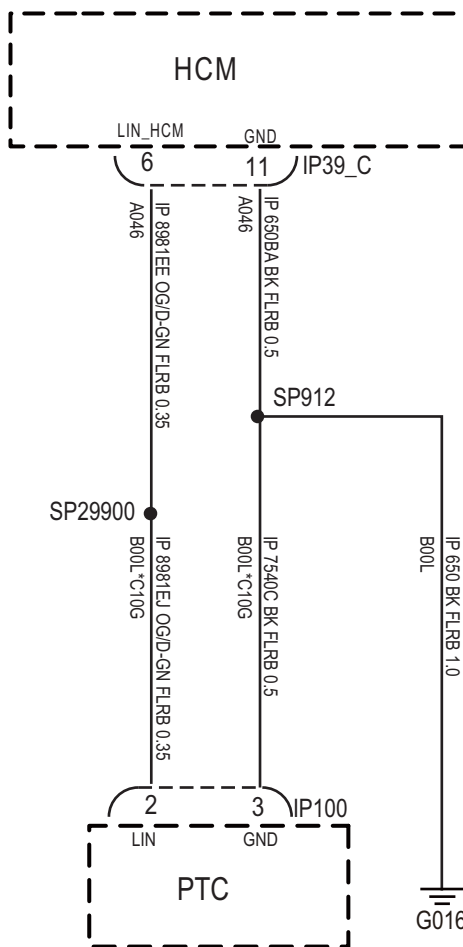

IP39_C

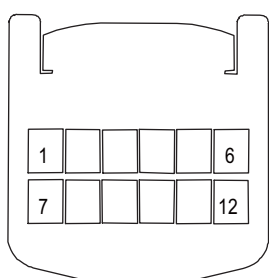

IP100

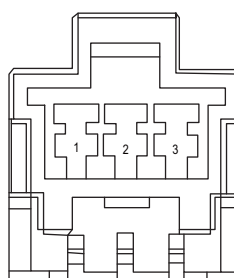

EK898020

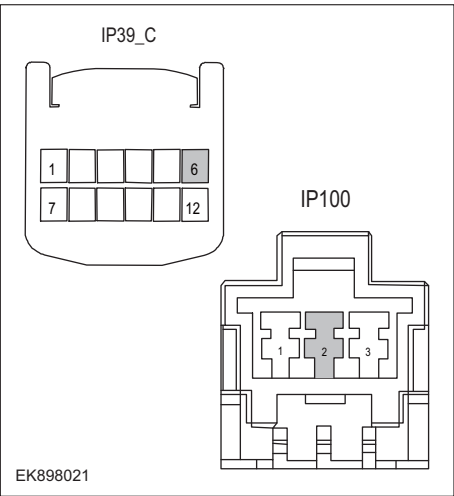
Troubleshooting procedures	
Step1	General inspection.
	<ol style="list-style-type: none"> 1 Check the fuse for damage. 2 Check battery capacity. 3 Check the air conditioning compressor and HCM harness plugs for damage, poor contact, aging, and looseness. 4 Check whether the result is normal or not?
NO → Repair or replace the detected faulty parts.	
YES ↓	
Step2	Check fault codes.
	<ol style="list-style-type: none"> 1 Connect the fault diagnosis instrument to the diagnosis interface. 2 Turn the ignition switch to ON position. 3 Use a diagnostic tool to diagnose HCM. 4 Is there any other fault code except for B1612-1C、B1613-1C、B1614-1C?
YES → Refer to: DTC Summary List (HCM) .	
NO ↓	
Step5	Check communication circuit between air conditioning module and air conditioning PTC LIN (open circuit).
	<ol style="list-style-type: none"> 1 Turn off the ignition switch. 2 Disconnect harness plug of air conditioning module. 3 Disconnect PTC harness plug of air conditioner. 4 Measure the resistance between air conditioner PTC harness terminal and air conditioner module harness terminal. Measuring circuit: resistance between terminal 2 of air conditioner PTC plug and terminal 6 of air conditioner module plug. Standard value: $\approx 0 \Omega$ 5 Check whether the result is normal or not?
NO → Repair or replace the faulted parts.	
YES ↓	

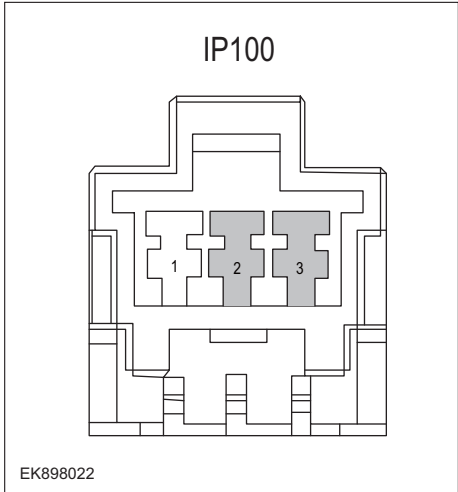
Step6	Check air conditioner PTC LIN communication circuit (short circuit).
	<ol style="list-style-type: none"> 1 Turn off the ignition switch. 2 Measure the resistance between air conditioner PTC harness plug and ground. Measuring circuit: resistance between terminal 2 of PTC plug of air conditioner and ground. Standard value: infinity 3 Measure the voltage between mode motor harness plug and ground. Measuring circuit: voltage between terminal 3 of PTC plug of air conditioner and ground. Standard value: ≈ 0V 4 Check whether the result is normal or not?
NO → Repair or replace the faulted parts.	
YES ↓	
Step7	Check if there are any abnormalities in the HCM.
	<ol style="list-style-type: none"> 1 Turn off the ignition switch. 2 Disconnect and inspect the HCM harness plug. 3 Inspection and maintenance: <ul style="list-style-type: none"> • Corrosion (installing new connectors or terminals - cleaning module pins). • Damaged or bent pins - install new terminals/pins. • Pin flying - Install new pins as needed. 4 Reconnect the HCM plug and all other previously disconnected plugs. Ensure that the pin position and fixation are appropriate. 5 Run the system and determine if the problem still exists?
YES → Replace the HCM.	
NO ↓	
At this point, the system is operating normally. The possible cause of the problem may be module connection. Address the root cause of any connector or pin issues.	
Next Step ↓	
Diagnosis completed.	

HCM

U3003-17、U3003-16

Fault diagnosis code
U3003-17: Voltage High
U3003-16: Voltage Low
Detection tools
1 Multimeter and diagnostic apparatus
Possible causes
<ul style="list-style-type: none">• Circuit,terminal and adapting piece fault• storage battery• HCM• Charging system• fuse
Conditions for fault code operation
Turn the ignition switch to ON position.
Conditions for fault code setting
U3003-17
The voltage is greater than 16.5v v.
U3003-16
The voltage is lower than 8.5v
To set the effect of a fault code condition
The air conditioner is not working properly.
Description of circuit diagram
HCM will always monitor whether the sensors and actuators are within the normal range. At the same time, it will also test the rationality of virtual connection, short circuit, open circuit and other signals. When a fault occurs, HCM will store the fault code corresponding to this fault and enable the safe mode.

Circuit diagram

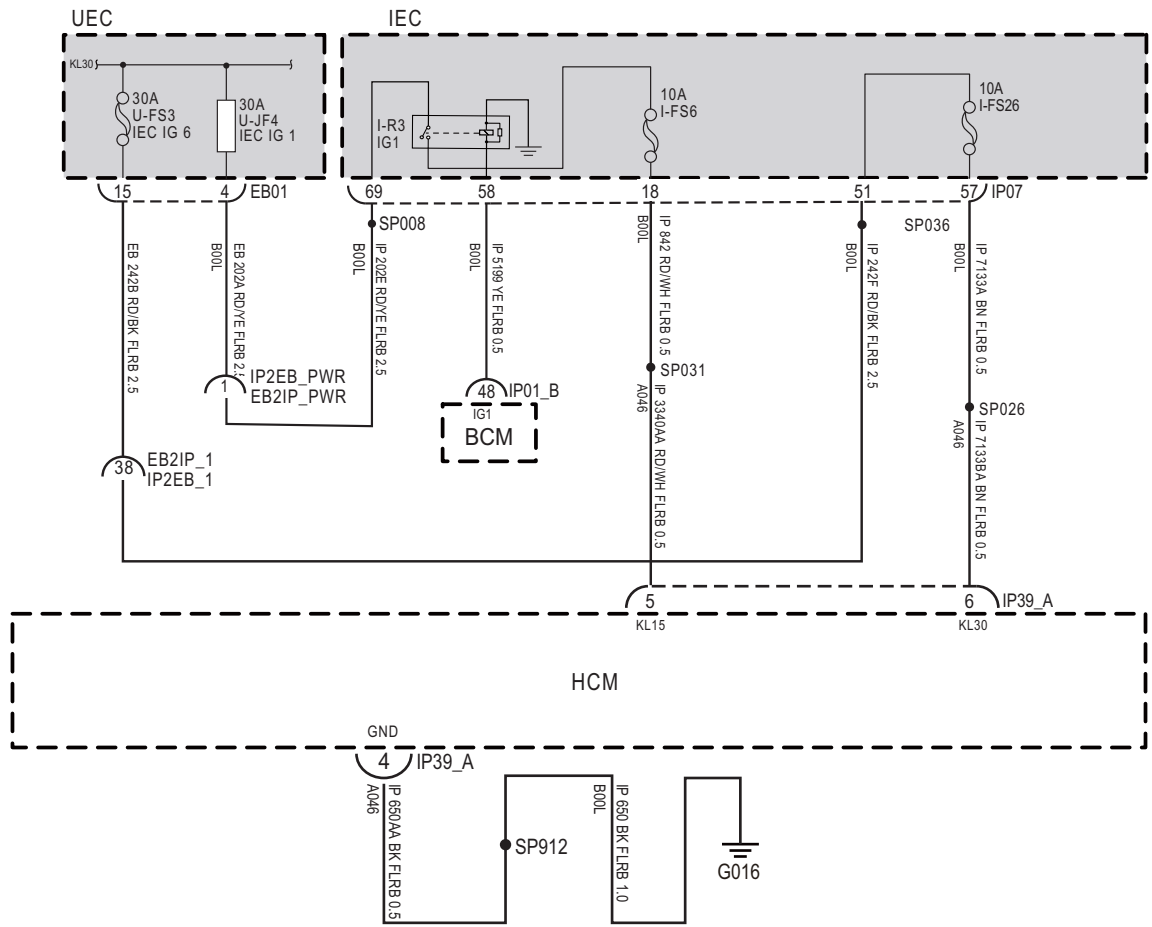

IP39_A

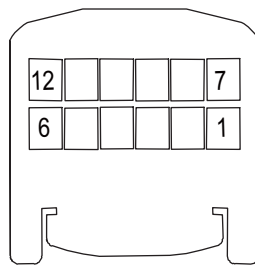

EK898023

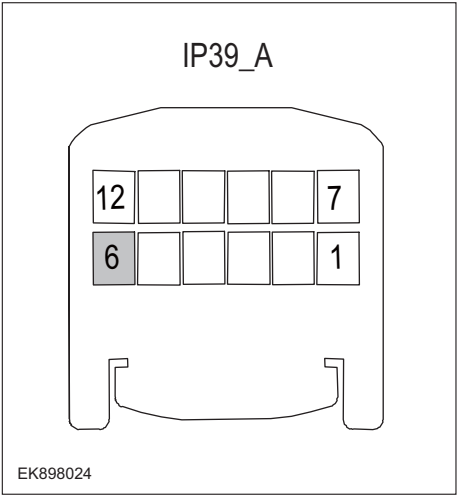
Troubleshooting procedures	
Step1	General inspection.
	<ol style="list-style-type: none"> 1 Check fuse U-FS3、 U-JF4、 I-FS6、 I-FS26Whether it is damaged. 2 Check battery capacity. 3 Check the HCM harness plug for damage, poor contact, aging, and looseness. 4 Check whether the result is normal or not?
NO → Repair or replace the detected faulty parts.	
YES ↓	
Step2	Check fault codes.
	<ol style="list-style-type: none"> 1 Connect the fault diagnosis instrument to the diagnosis interface. 2 Turn the ignition switch to ON position. 3 Use a diagnostic tool to diagnose HCM. 4 Is there any other fault code except for U3003-17、 U3003-16?
YES → Refer to: DTC Summary List (HCM) .	
NO ↓	
Step3	Check the supply voltage of HCM battery.
	<ol style="list-style-type: none"> 1 Turn off the ignition switch. 2 Disconnect HCM harness plug. 3 Measure the voltage between HCM harness terminal and ground. Measuring circuit: voltage between terminal 6 of air conditioning module plug and ground. Standard value:10~14V 4 Check whether the result is normal or not?
NO → Repair or replace the faulted parts.	
YES ↓	

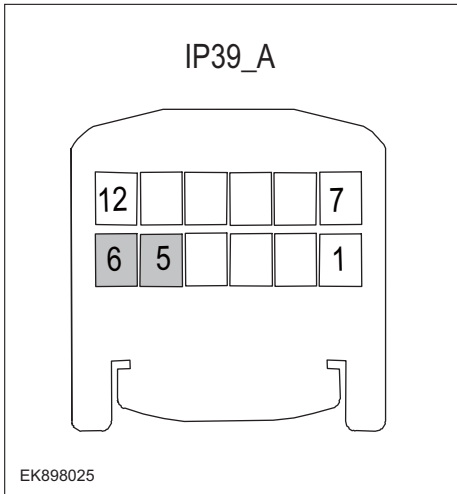
Step4	Check the power supply voltage when HCM is started or running.
 <p>IP39_A</p> <p>EK898025</p>	<ol style="list-style-type: none"> 1 Turn on the ignition. 2 Measure the voltage between HCM harness terminal and ground. Measuring circuit: voltage between terminal 5 of air conditioning module plug and ground. Measuring circuit: voltage between terminal 6 of air conditioning module plug and ground. Standard value:10~14V 3 Check whether the result is normal or not?

NO → Repair or replace the faulted parts.

YES ↓

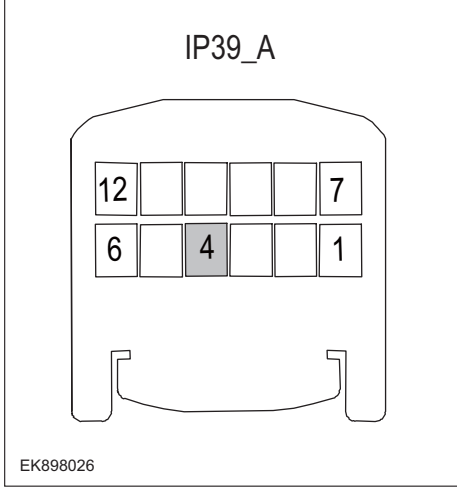
Step5	Check the HCM ground circuit for an open circuit.
 <p>IP39_A</p> <p>EK898026</p>	<ol style="list-style-type: none"> 1 Turn off the ignition switch. 2 Disconnect HCM harness plug. 3 Disconnect HCM harness plug. Measuring circuit: resistance between terminal 4 of air conditioning module plug and ground. Standard value:< 1Ω 4 Is the resistance less than 1 ω?

NO → Repair or replace the faulted parts.

YES ↓

HCM

Step6	Check if there are any abnormalities in the HCM.
	<ol style="list-style-type: none">1 Turn off the ignition switch.2 Disconnect and inspect the HCM harness plug.3 Inspection and maintenance:<ul style="list-style-type: none">• Corrosion (installing new connectors or terminals - cleaning module pins).• Damaged or bent pins - install new terminals/pins.• Pin flying - Install new pins as needed.4 Reconnect the HCM plug and all other previously disconnected plugs. Ensure that the pin position and fixation are appropriate.5 Run the system and determine if the problem still exists?
	YES → Replace the HCM.
NO ↓	
At this point, the system is operating normally. The possible cause of the problem may be module connection. Address the root cause of any connector or pin issues.	
Next Step ↓	
Diagnosis completed.	

U0120-87

Fault diagnosis code
U0120-87: VCU CAN message no receive
Detection tools
1 Multimeter and diagnostic apparatus
Possible causes
<ul style="list-style-type: none"> • Circuit,terminal and adapting piece fault • HCM
Conditions for fault code operation
Turn the ignition switch to ON position.
Conditions for fault code setting
U0120-87
To set the effect of a fault code condition
Abnormal operation of air conditioner
Description of circuit diagram
<p>The device is connected to the serial data circuit to monitor the serial data communication when the vehicle works normally. Devices exchange operation information and instructions with each other. The device has programming information that needs to be exchanged on the serial data circuit. The receiver device also monitors this information; In addition, some periodic information is used to indicate the availability of the transmitter device.</p>

Circuit diagram

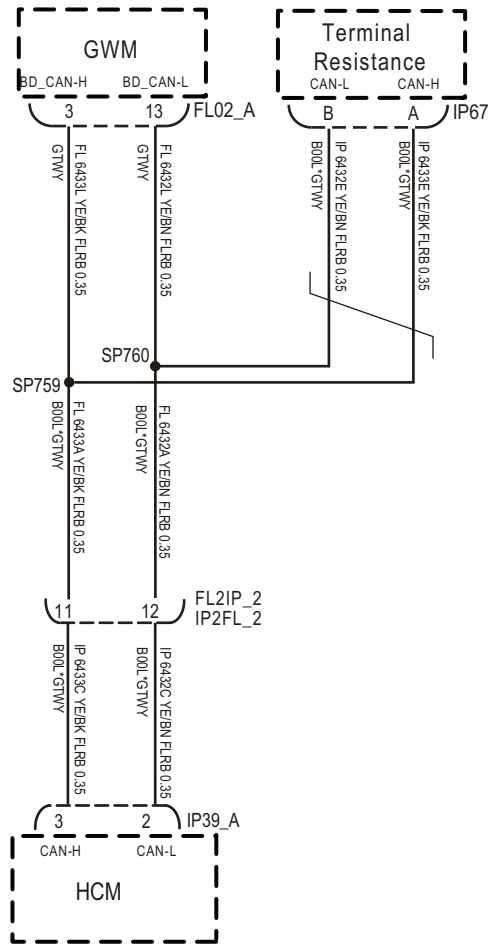

FL02_A

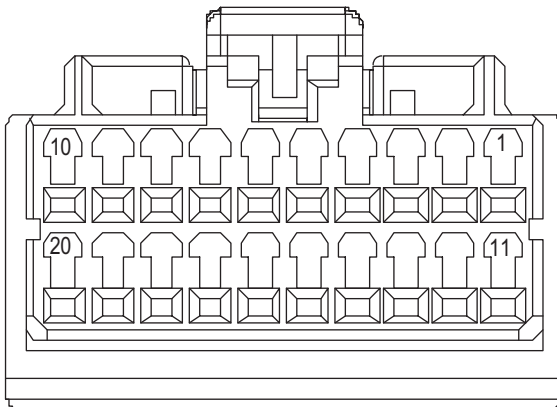

IP67

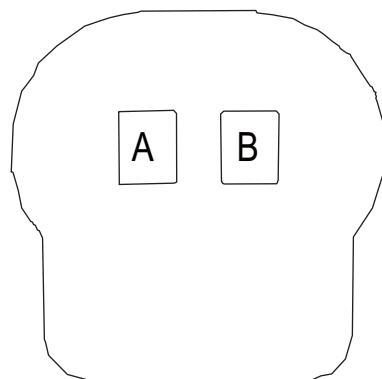

EK898027

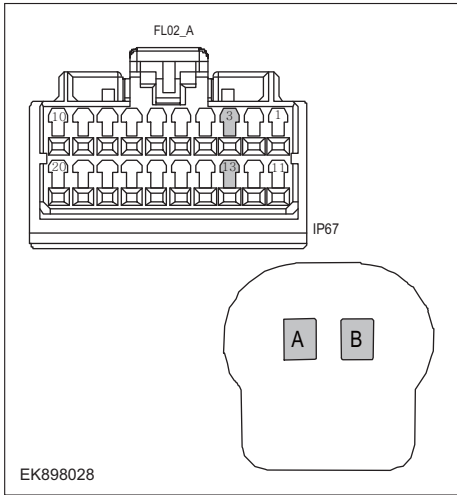
Troubleshooting procedures	
Step1	General inspection.
	<ol style="list-style-type: none"> 1 Check the fuse for damage. 2 Check battery capacity. 3 Check the HCM harness plug for damage, poor contact, aging, and looseness. 4 Check whether the result is normal or not?
	NO → Repair or replace the detected faulty parts.
YES ↓	
Step2	Check fault codes.
	<ol style="list-style-type: none"> 1 Connect the fault diagnosis instrument to the diagnosis interface. 2 Turn the ignition switch to ON position. 3 Use a diagnostic tool to diagnose HCM. 4 Is there any other fault code except for U0120-87?
	YES → Refer to: DTC Summary List (HCM) .
NO ↓	
Step3	Check the terminal resistance of the gateway module and BD resistor.
	<ol style="list-style-type: none"> 1 Turn off the ignition switch. 2 Disconnect the gateway module harness plug. 3 Measure the resistance between the gateway module harness terminals. Measuring circuit: resistance between terminal 3 and terminal 13 of gateway module plug. Standard value:110~130Ω 4 Connect the gateway module harness plug. 5 Disconnect BD resistor harness plug IP67. 6 Measure the resistance between BD resistor harness terminals. Measuring circuit: resistance between terminal A and terminal B of IP67 plug. Standard value:110~130Ω 7 Check whether the result is normal or not?
	NO → Repair or replace the faulted parts.
YES ↓	

HCM

Step4	Check if there are any abnormalities in the HCM.
	<ol style="list-style-type: none">1 Turn off the ignition switch.2 Disconnect and inspect the HCM harness plug.3 Inspection and maintenance:<ul style="list-style-type: none">• Corrosion (installing new connectors or terminals - cleaning module pins).• Damaged or bent pins - install new terminals/pins.• Pin flying - Install new pins as needed.4 Reconnect the HCM plug and all other previously disconnected plugs. Ensure that the pin position and fixation are appropriate.5 Run the system and determine if the problem still exists?
	YES → Replace the HCM.
NO ↓	
At this point, the system is operating normally. The possible cause of the problem may be module connection. Address the root cause of any connector or pin issues.	
Next Step ↓	
Diagnosis completed.	

U0155-87

Fault diagnosis code
U0155-87: IPK CAN message no receive
Detection tools
1 Multimeter and diagnostic apparatus
Possible causes
<ul style="list-style-type: none"> • Circuit,terminal and adapting piece fault • HCM
Conditions for fault code operation
Turn the ignition switch to ON position.
Conditions for fault code setting
U0155-87
To set the effect of a fault code condition
Abnormal operation of air conditioner
Description of circuit diagram
The device is connected to the serial data circuit to monitor the serial data communication when the vehicle works normally. Devices exchange operation information and instructions with each other. The device has programming information that needs to be exchanged on the serial data circuit. The receiver device also monitors this information; In addition, some periodic information is used to indicate the availability of the transmitter device.

Circuit diagram

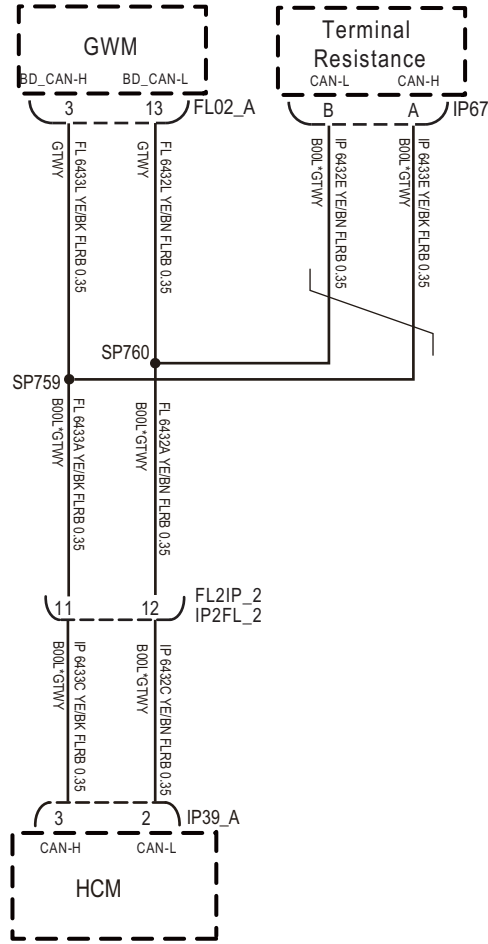

FL02_A

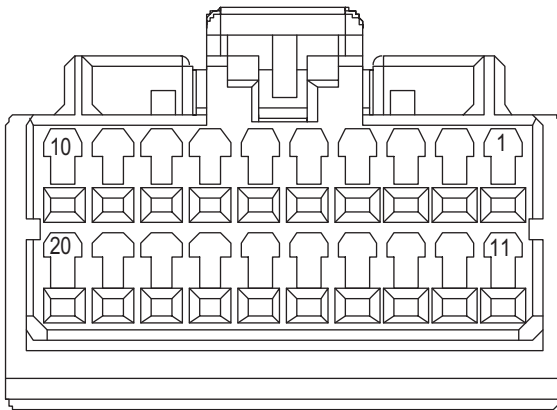

IP67

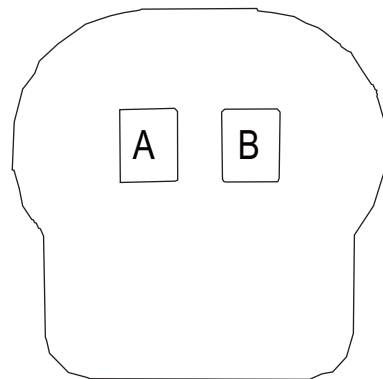

EK898027

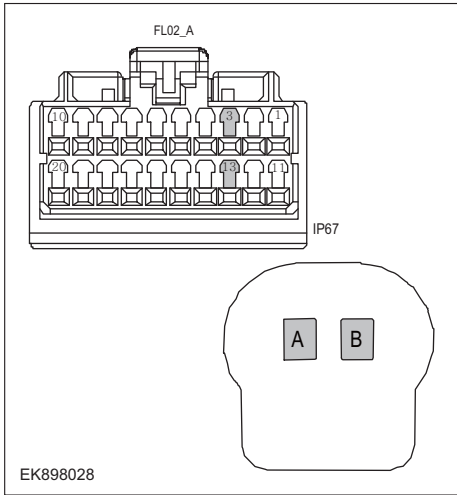
Troubleshooting procedures	
Step1	General inspection.
	<ol style="list-style-type: none"> 1 Check the fuse for damage. 2 Check battery capacity. 3 Check the HCM harness plug for damage, poor contact, aging, and looseness. 4 Check whether the result is normal or not?
	NO → Repair or replace the detected faulty parts.
YES ↓	
Step2	Check fault codes.
	<ol style="list-style-type: none"> 1 Connect the fault diagnosis instrument to the diagnosis interface. 2 Turn the ignition switch to ON position. 3 Use a diagnostic tool to diagnose HCM. 4 Is there any other fault code except for U0155-87?
	YES → Refer to: DTC Summary List (HCM) .
NO ↓	
Step3	Check the terminal resistance of the gateway module and BD resistor.
	<ol style="list-style-type: none"> 1 Turn off the ignition switch. 2 Disconnect the gateway module harness plug. 3 Measure the resistance between the gateway module harness terminals. Measuring circuit: resistance between terminal 3 and terminal 13 of gateway module plug. Standard value:110~130Ω 4 Connect the gateway module harness plug. 5 Disconnect BD resistor harness plug IP67. 6 Measure the resistance between BD resistor harness terminals. Measuring circuit: resistance between terminal A and terminal B of IP67 plug. Standard value:110~130Ω 7 Check whether the result is normal or not?
	NO → Repair or replace the faulted parts.
YES ↓	

HCM

Step4	Check if there are any abnormalities in the HCM.
	<ol style="list-style-type: none">1 Turn off the ignition switch.2 Disconnect and inspect the HCM harness plug.3 Inspection and maintenance:<ul style="list-style-type: none">• Corrosion (installing new connectors or terminals - cleaning module pins).• Damaged or bent pins - install new terminals/pins.• Pin flying - Install new pins as needed.4 Reconnect the HCM plug and all other previously disconnected plugs. Ensure that the pin position and fixation are appropriate.5 Run the system and determine if the problem still exists?
	YES → Replace the HCM.
NO ↓	
At this point, the system is operating normally. The possible cause of the problem may be module connection. Address the root cause of any connector or pin issues.	
Next Step ↓	
Diagnosis completed.	

U0315-87

Fault diagnosis code
U0315-87: ABS CAN message no receive
Detection tools
1 Multimeter and diagnostic apparatus
Possible causes
<ul style="list-style-type: none"> • Circuit,terminal and adapting piece fault • HCM
Conditions for fault code operation
Turn the ignition switch to ON position.
Conditions for fault code setting
U0315-87
To set the effect of a fault code condition
Abnormal operation of air conditioner
Description of circuit diagram
<p>The device is connected to the serial data circuit to monitor the serial data communication when the vehicle works normally. Devices exchange operation information and instructions with each other. The device has programming information that needs to be exchanged on the serial data circuit. The receiver device also monitors this information; In addition, some periodic information is used to indicate the availability of the transmitter device.</p>

Circuit diagram

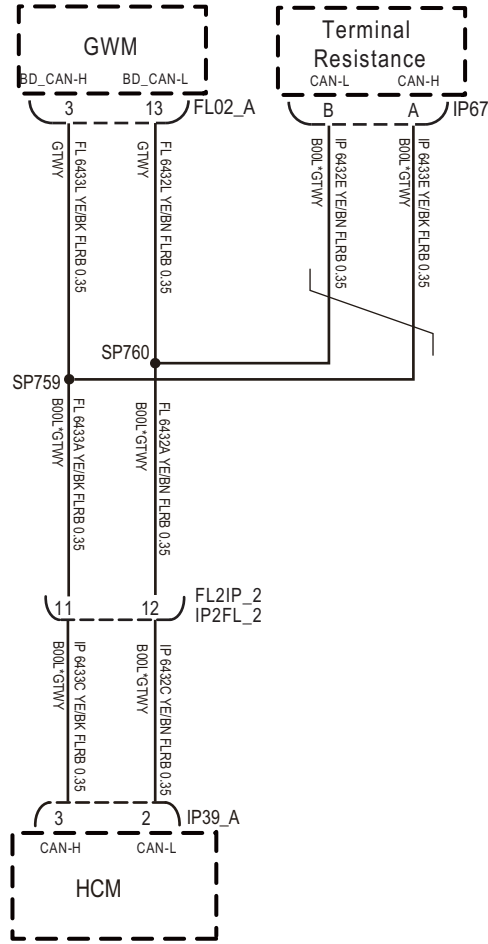

FL02_A

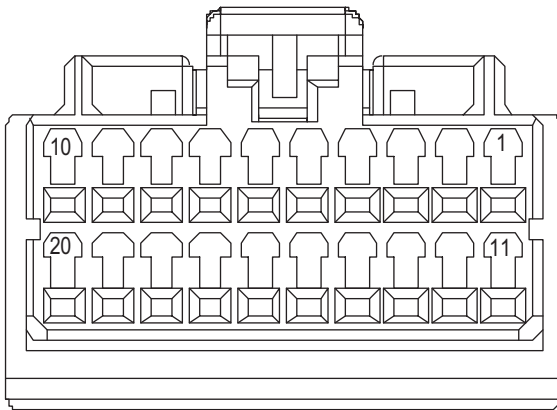

IP67

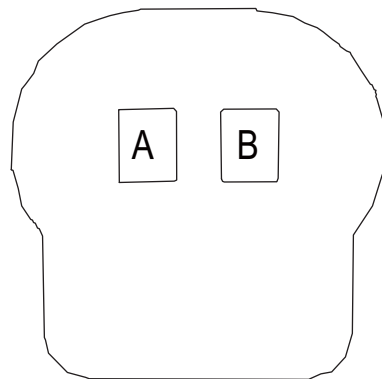

EK898027

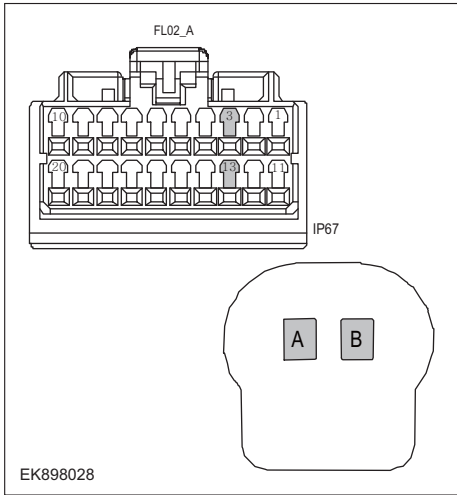
Troubleshooting procedures	
Step1	General inspection.
	<ol style="list-style-type: none"> 1 Check the fuse for damage. 2 Check battery capacity. 3 Check the HCM harness plug for damage, poor contact, aging, and looseness. 4 Check whether the result is normal or not?
	NO → Repair or replace the detected faulty parts.
YES ↓	
Step2	Check fault codes.
	<ol style="list-style-type: none"> 1 Connect the fault diagnosis instrument to the diagnosis interface. 2 Turn the ignition switch to ON position. 3 Use a diagnostic tool to diagnose HCM. 4 Is there any other fault code except for U0315-87?
	YES → Refer to: DTC Summary List (HCM) .
NO ↓	
Step3	Check the terminal resistance of the gateway module and BD resistor.
	<ol style="list-style-type: none"> 1 Turn off the ignition switch. 2 Disconnect the gateway module harness plug. 3 Measure the resistance between the gateway module harness terminals. Measuring circuit: resistance between terminal 3 and terminal 13 of gateway module plug. Standard value: 110~130Ω 4 Connect the gateway module harness plug. 5 Disconnect BD resistor harness plug IP67. 6 Measure the resistance between BD resistor harness terminals. Measuring circuit: resistance between terminal A and terminal B of IP67 plug. Standard value: 110~130Ω 7 Check whether the result is normal or not?
	NO → Repair or replace the faulted parts.
YES ↓	

HCM

Step4	Check if there are any abnormalities in the HCM.
	<ol style="list-style-type: none">1 Turn off the ignition switch.2 Disconnect and inspect the HCM harness plug.3 Inspection and maintenance:<ul style="list-style-type: none">• Corrosion (installing new connectors or terminals - cleaning module pins).• Damaged or bent pins - install new terminals/pins.• Pin flying - Install new pins as needed.4 Reconnect the HCM plug and all other previously disconnected plugs. Ensure that the pin position and fixation are appropriate.5 Run the system and determine if the problem still exists?
	YES → Replace the HCM.
NO ↓	
At this point, the system is operating normally. The possible cause of the problem may be module connection. Address the root cause of any connector or pin issues.	
Next Step ↓	
Diagnosis completed.	

U0140-87

Fault diagnosis code
U0140-87: BCM CAN message no receive
Detection tools
1 Multimeter and diagnostic apparatus
Possible causes
<ul style="list-style-type: none"> • Circuit,terminal and adapting piece fault • HCM
Conditions for fault code operation
Turn the ignition switch to ON position.
Conditions for fault code setting
U0140-87
To set the effect of a fault code condition
Abnormal operation of air conditioner
Description of circuit diagram
<p>The device is connected to the serial data circuit to monitor the serial data communication when the vehicle works normally. Devices exchange operation information and instructions with each other. The device has programming information that needs to be exchanged on the serial data circuit. The receiver device also monitors this information; In addition, some periodic information is used to indicate the availability of the transmitter device.</p>

Circuit diagram

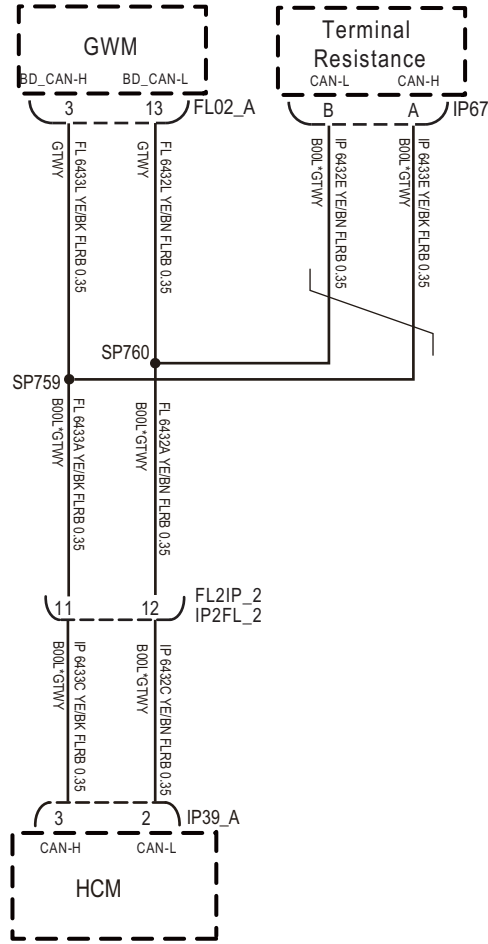

FL02_A

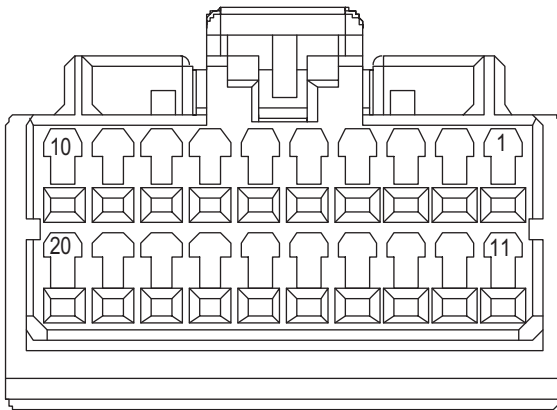

IP67

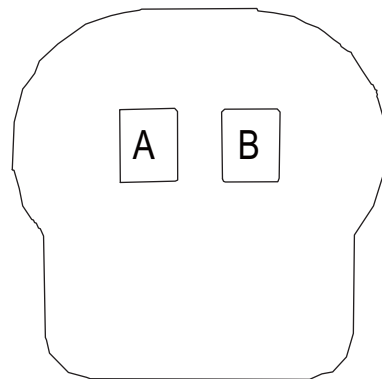

EK898027

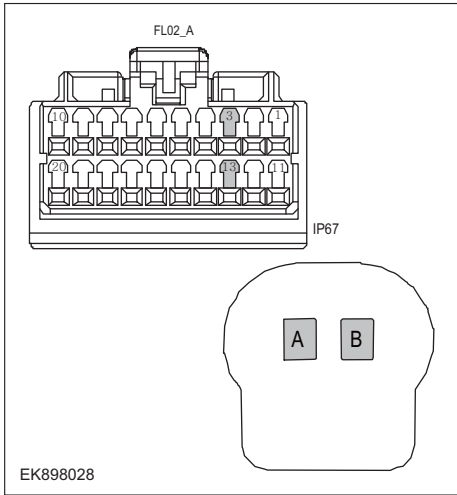
Troubleshooting procedures	
Step1	General inspection.
	<ol style="list-style-type: none"> 1 Check the fuse for damage. 2 Check battery capacity. 3 Check the HCM harness plug for damage, poor contact, aging, and looseness. 4 Check whether the result is normal or not?
	NO → Repair or replace the detected faulty parts.
YES ↓	
Step2	Check fault codes.
	<ol style="list-style-type: none"> 1 Connect the fault diagnosis instrument to the diagnosis interface. 2 Turn the ignition switch to ON position. 3 Use a diagnostic tool to diagnose HCM. 4 Is there any other fault code except for U0140-87?
	YES → Refer to: DTC Summary List (HCM) .
NO ↓	
Step3	Check the terminal resistance of the gateway module and BD resistor.
	<ol style="list-style-type: none"> 1 Turn off the ignition switch. 2 Disconnect the gateway module harness plug. 3 Measure the resistance between the gateway module harness terminals. Measuring circuit: resistance between terminal 3 and terminal 13 of gateway module plug. Standard value:110~130Ω 4 Connect the gateway module harness plug. 5 Disconnect BD resistor harness plug IP67. 6 Measure the resistance between BD resistor harness terminals. Measuring circuit: resistance between terminal A and terminal B of IP67 plug. Standard value:110~130Ω 7 Check whether the result is normal or not?
	NO → Repair or replace the faulted parts.
YES ↓	

HCM

Step4	Check if there are any abnormalities in the HCM.
	<ol style="list-style-type: none">1 Turn off the ignition switch.2 Disconnect and inspect the HCM harness plug.3 Inspection and maintenance:<ul style="list-style-type: none">• Corrosion (installing new connectors or terminals - cleaning module pins).• Damaged or bent pins - install new terminals/pins.• Pin flying - Install new pins as needed.4 Reconnect the HCM plug and all other previously disconnected plugs. Ensure that the pin position and fixation are appropriate.5 Run the system and determine if the problem still exists?
	YES → Replace the HCM.
NO ↓	
At this point, the system is operating normally. The possible cause of the problem may be module connection. Address the root cause of any connector or pin issues.	
Next Step ↓	
Diagnosis completed.	

U0073-88

Fault diagnosis code
U0073-88: trunk bus off
Detection tools
1 Multimeter and diagnostic apparatus
Possible causes
<ul style="list-style-type: none"> • Circuit, terminal and adapting piece fault • HCM
Conditions for fault code operation
Turn the ignition switch to ON position.
Conditions for fault code setting
U0073-88
To set the effect of a fault code condition
Abnormal operation of air conditioner
Description of circuit diagram
<p>The device is connected to the serial data circuit to monitor the serial data communication when the vehicle works normally. Devices exchange operation information and instructions with each other. The device has programming information that needs to be exchanged on the serial data circuit. The receiver device also monitors this information; In addition, some periodic information is used to indicate the availability of the transmitter device.</p>

Circuit diagram

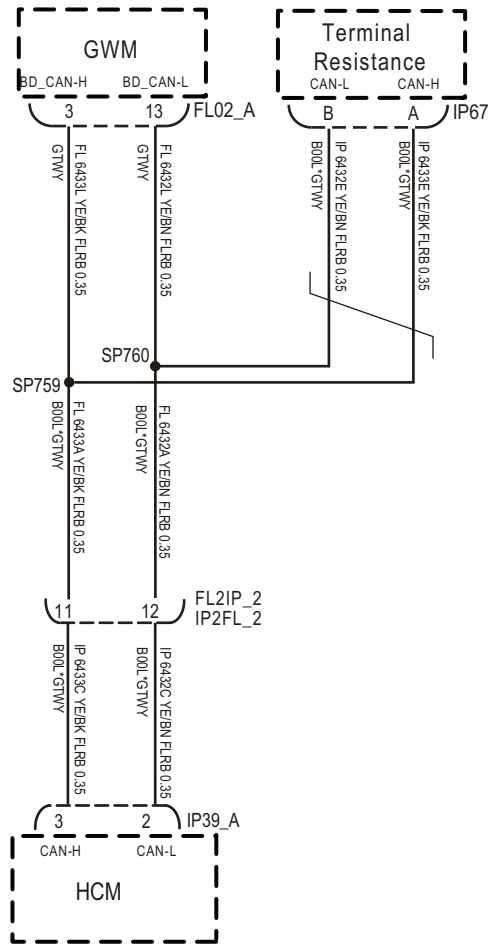

FL02_A

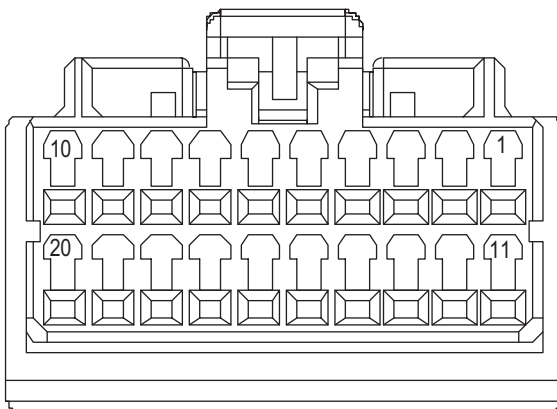

IP67

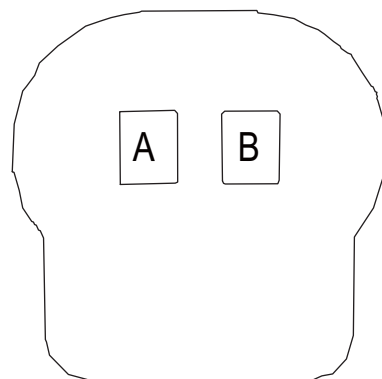

EK898027

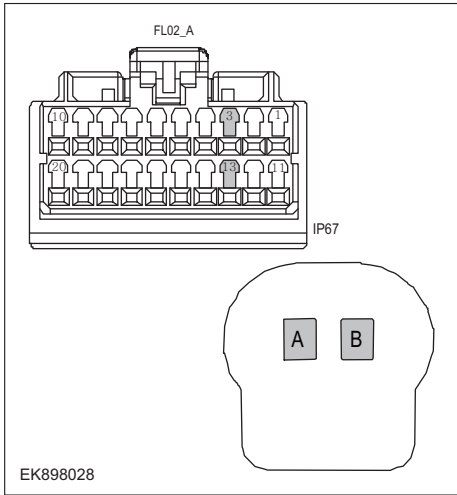
Troubleshooting procedures	
Step1	General inspection.
	<ol style="list-style-type: none"> 1 Check the fuse for damage. 2 Check battery capacity. 3 Check the HCM harness plug for damage, poor contact, aging, and looseness. 4 Check whether the result is normal or not?
	NO → Repair or replace the detected faulty parts.
YES ↓	
2	Check fault codes.
	<ol style="list-style-type: none"> 1 Connect the fault diagnosis instrument to the diagnosis interface. 2 Turn the ignition switch to ON position. 3 Use a diagnostic tool to diagnose HCM. 4 Is there any other fault code except for U0073-88?
	YES → Refer to: DTC Summary List (HCM) .
NO ↓	
Step3	Check the terminal resistance of the gateway module and BD resistor.
	<ol style="list-style-type: none"> 1 Turn off the ignition switch. 2 Disconnect the gateway module harness plug. 3 Measure the resistance between the gateway module harness terminals. Measuring circuit: resistance between terminal 3 and terminal 13 of gateway module plug. Standard value:110~130Ω 4 Connect the gateway module harness plug. 5 Disconnect BD resistor harness plug IP67. 6 Measure the resistance between BD resistor harness terminals. Measuring circuit: resistance between terminal A and terminal B of IP67 plug. Standard value:110~130Ω 7 Check whether the result is normal or not?
	NO → Repair or replace the faulted parts.
YES ↓	

HCM

Step4	Check if there are any abnormalities in the HCM.
	<ol style="list-style-type: none">1 Turn off the ignition switch.2 Disconnect and inspect the HCM harness plug.3 Inspection and maintenance:<ul style="list-style-type: none">• Corrosion (installing new connectors or terminals - cleaning module pins).• Damaged or bent pins - install new terminals/pins.• Pin flying - Install new pins as needed.4 Reconnect the HCM plug and all other previously disconnected plugs. Ensure that the pin position and fixation are appropriate.5 Run the system and determine if the problem still exists?
	YES → Replace the HCM.
NO ↓	
At this point, the system is operating normally. The possible cause of the problem may be module connection. Address the root cause of any connector or pin issues.	
Next Step ↓	
Diagnosis completed.	

DTC Summary list (IPK)

DTC	English descriptions	Reference page
0x9117-16	Circuit voltage below threshold	0x9117-16 , 0x9117-17
0x9117-17	Circuit voltage above threshold	
0xC140-87	BCM communication lost	0xC140-87
0xC122-87	ABS communication lost	0xC122-87
0xC123-87	SRS communication lost	0xC123-87
0xC127-87	TPMS communication lost	0xC127-87
0xC126-87	PEPS communication lost	0xC126-87
0xC073-87	CAN in bus off state	0xC073-87
0xD005-87	Bus communication exception	0xD005-87
0xC210-00	ODO backup VIN code error	0xC210-00
0xC132-87	EPS communication lost	0xC132-87
0xC136-87	VCU communication lost	0xC136-87
0xC137-87	BMS communication lost	0xC137-87
0xC138-87	PEU communication lost	0xC138-87

0x9117-16、 0x9117-17

Fault diagnosis code
0x9117-16: Circuit voltage below threshold
0x9117-17: Circuit voltage above threshold
Detection tools
1 Multimeter and diagnostic apparatus
Possible causes
<ul style="list-style-type: none"> • Circuit,terminal and adapting piece fault • Battery • IPK • Charging system • Insurance fuse
Conditions for fault code operation
Turn the ignition switch to ON position.
Conditions for fault code setting
0x9117-16
The voltage is less than 7.5V and the duration reaches 1s.
0x9117-17
Voltage > 18V and duration up to 1s.
To set the effect of a fault code condition
Description of circuit diagram
The IPK will monitor whether all sensors and actuators are within normal range all the time. Meanwhile,it will check the connector for virtual connection, short circuit, open circuit and the connection rationality with other signals. When fault occurs, the IPK module will save the fault code corresponding to that fault and enable safety mode.

Circuit diagram

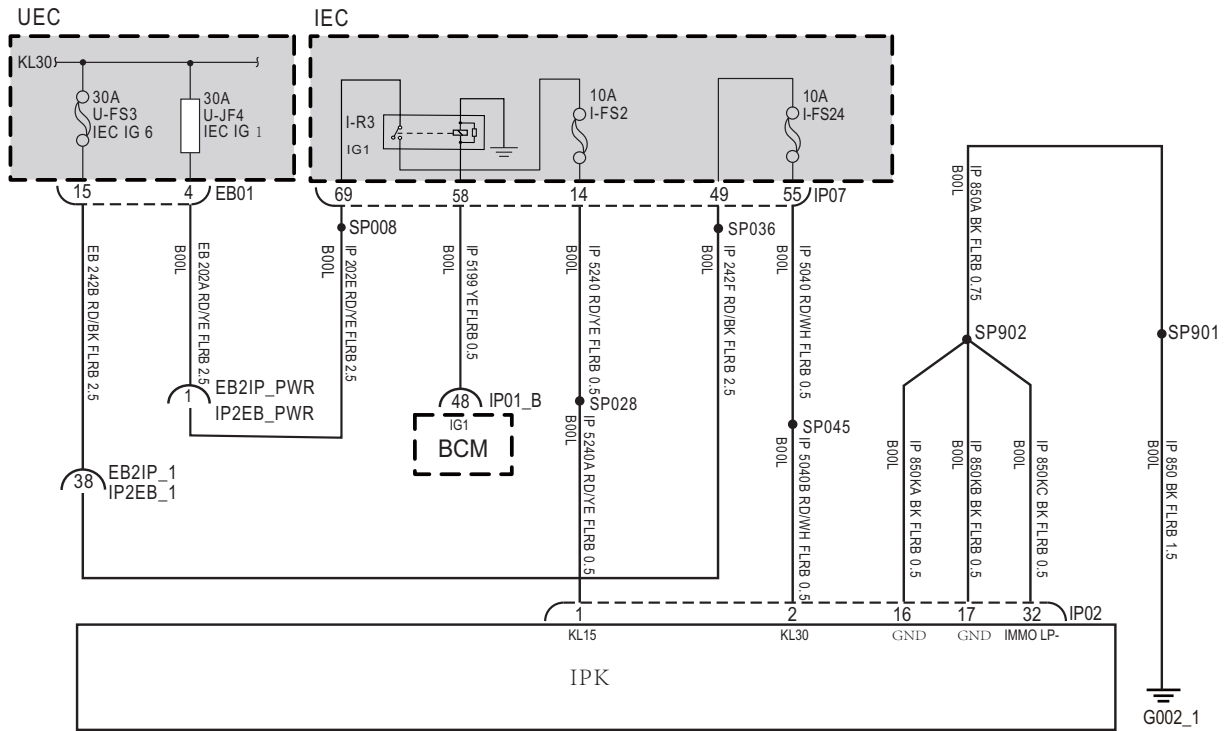

IP02

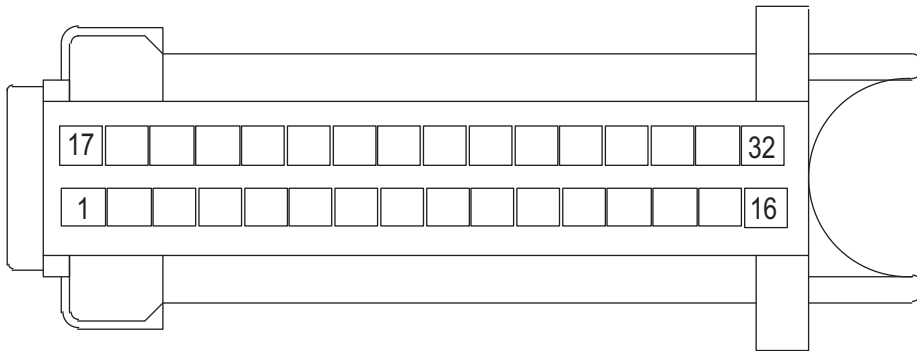

EK899001

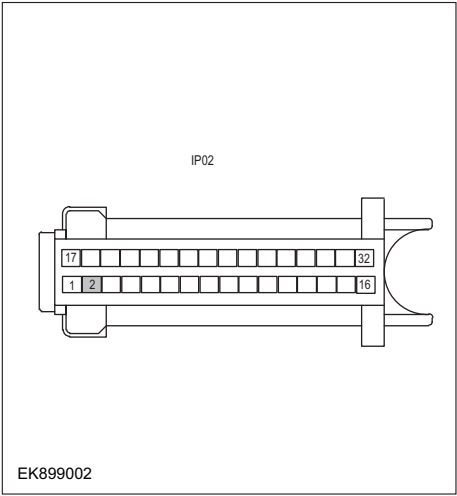
Troubleshooting steps	
Step1	General inspection.
	<ol style="list-style-type: none"> 1 Check fuses U-FS3、 U-JF4、 I-FS2、 I-FS24for damage. 2 Check battery capacity. 3 Check the harness plug of IPK for damage, poor contact, aging and looseness. 4 Check whether the result is normal or not?
NO → Repair or replace the faulted parts.	
YES ↓	
Step2	Check fault codes.
	<ol style="list-style-type: none"> 1 Connect the fault diagnosis instrument to the diagnosis interface. 2 Turn the ignition switch to ON position. 3 Diagnose the IPK module with diagnostic apparatus. 4 Is there a fault code other than 0x9117-16、 0x9117-17?
YES → Refer to: DTC Summary list (IPK) .	
NO ↓	
Step3	Check the power voltage of IPK battery.
	<ol style="list-style-type: none"> 1 Turn the ignition switch to OFF. 2 Disconnect IPK harness plug IP02. 3 Measure the resistance between harness terminals on IPK. Measuring circuit: voltage between terminal 2 of IP02 plug and ground. Standard value:10~14V 4 Check whether the result is normal or not?
NO → Repair the circuit.	
YES ↓	

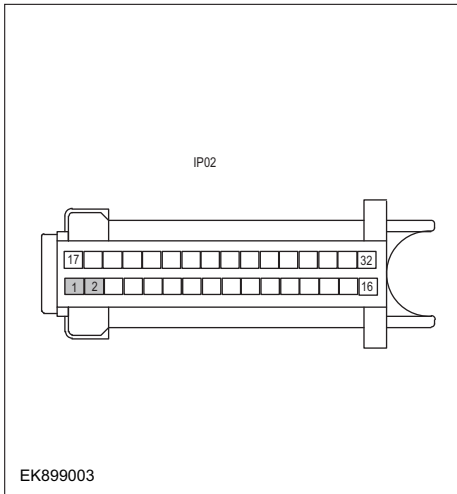
Step4	Check the power voltage when the IPK module is started or operating
	<ol style="list-style-type: none"> 1 Turn the ignition switch to ON. 2 Measure the resistance between harness terminals on IPK. Measuring circuit: voltage between terminal 1 of IP02 plug and ground. Measuring circuit: voltage between terminal 2 of IP02 plug and ground. Standard value: 10~14V 3 Check whether the result is normal or not?

NO → Repair the circuit.

YES ↓

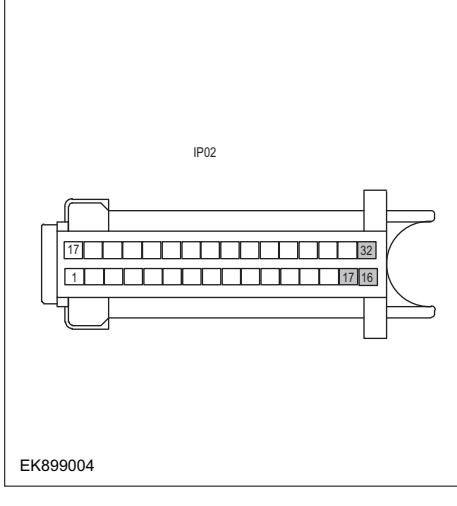
Step5	Test whether the grounding circuit of IPK module is open.
	<ol style="list-style-type: none"> 1 Turn the ignition switch to OFF. 2 Disconnect IPK harness plug IP02. 3 Measure the resistance between IPK harness plug and ground. Measuring circuit: resistance between terminal 16 of IP02 plug and ground. Measuring circuit: resistance between terminal 17 of IP02 plug and ground. Measuring circuit: resistance between terminal 32 of IP02 plug and ground. Standard value: < 1Ω 4 Test whether the resistance is less than 1Ω?

NO → Repair the circuit.

YES ↓

IPK

Step6	Check whether IPK is abnormal.
	<ol style="list-style-type: none">1 Turn the ignition switch to OFF.2 Disconnect and check IPK harness plug IP02.3 Check and repair.<ul style="list-style-type: none">• Corrosion(install new adapting piece or terminal-cleaning module and pin).• Pin damaged or bent-install new terminal/pin.• Fly out of pins-install new pins as needed.4 Reconnect the IPK plug and all other previously disconnected plug. Make sure the pin is properly positioned and fixed.5 Run the system and determine if the problem persists?
	YES → Repair the IPK.
NO ↓	
At this point the system is functioning normally. The problem may be caused by module connections. Address the root cause of any connector or pin problems,	
Next Step ↓	
Diagnosis end.	

0xC140-87

Fault diagnosis code
0xC140-87: BCM communication lost
Detection tools
1 Multimeter and diagnostic apparatus
Possible causes
<ul style="list-style-type: none"> • Circuit, terminal and adapting piece fault • CAN • IPK
Conditions for fault code operation
Turn the ignition switch to ON position.
Conditions for fault code setting
0xC140-87
BCM message is lost for more than 10 cycles.
To set the effect of a fault code condition
Description of circuit diagram
<p>The device is connected to the serial data circuit to monitor the serial data communication when the vehicle works normally. Devices exchange operation information and instructions with each other. The device has programming information that needs to be exchanged on the serial data circuit. The receiver device also monitors this information; In addition, some periodic information is used to indicate the availability of the transmitter device.</p>

Circuit diagram

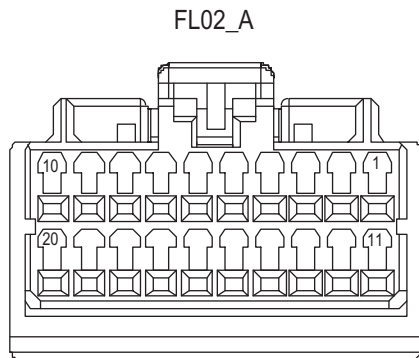
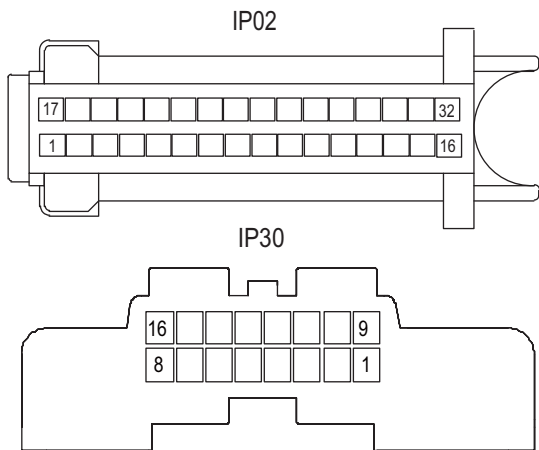
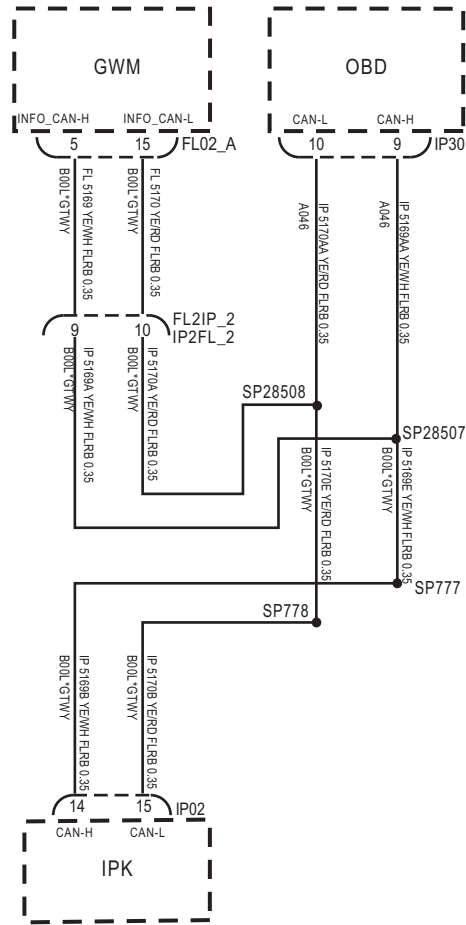

EK899005

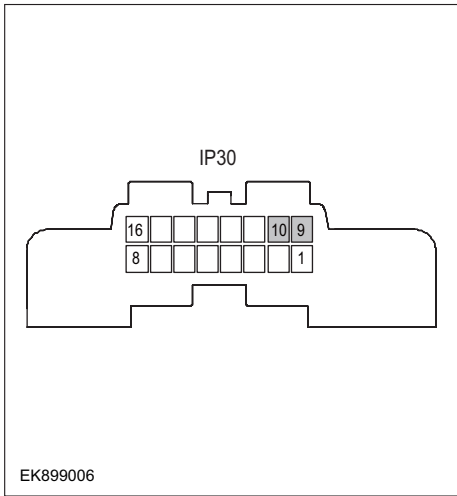
Troubleshooting steps	
Step1	General inspection.
	<ol style="list-style-type: none"> 1 Check fuses for damage. 2 Check battery capacity. 3 Check the harness plug of IPK for damage, poor contact, aging and looseness. 4 Check whether the result is normal or not?
	NO → Repair or replace the faulted parts.
YES ↓	
Step2	Check fault codes.
	<ol style="list-style-type: none"> 1 Connect the fault diagnosis instrument to the diagnosis interface. 2 Turn the ignition switch to ON position. 3 Diagnose the IPK module with diagnostic apparatus. 4 Is there a fault code other than 0xC140-87?
	YES → Refer to: DTC Summary list (IPK) .
NO ↓	
Step3	Inspection for CAN communication network completeness.
 <p style="text-align: center;">IP30</p> <p style="text-align: left;">EK899006</p>	<ol style="list-style-type: none"> 1 Turn the ignition switch to OFF. 2 Measure the resistance between the harness terminals of diagnose interface. Measuring circuit: resistance between terminal 9 and terminal 10 of IP30 plug. Standard value: ≈ 60Ω 3 Check whether the result is normal or not?
	NO → Repair or replace the faulted parts.
YES ↓	

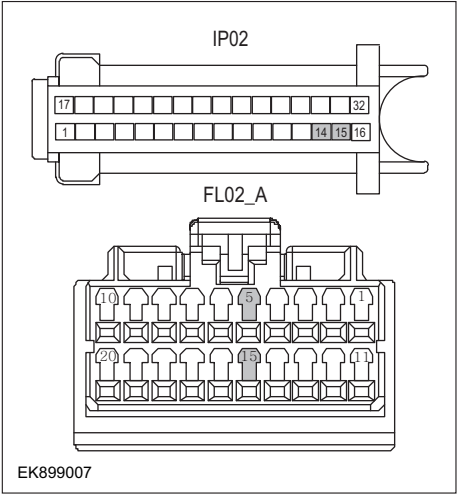
Step4	Check the resistance of gateway module and IPK terminal.。
	<ol style="list-style-type: none"> 1 Turn the ignition switch to OFF. 2 Disconnect the gateway module harness plug FL02 _ A. 3 Measure the resistance between the gateway module harness terminals. Measuring circuit: resistance between terminal 5 and terminal 15 of FL02_A plug. Standard value: 110~130Ω 4 Connect the gateway module harness plug FL02 _ A. 5 Disconnect IPK harness plug IP02. 6 Measure the resistance between IPK harness terminals. Measuring circuit: resistance between terminal 14 and terminal 15 of IP02 plug. Standard value: 110~130Ω 7 Check whether the result is normal or not?
NO → Repair or replace the faulted parts.	
YES ↓	
Step5	Check whether IPK is abnormal.
	<ol style="list-style-type: none"> 1 Turn the ignition switch to OFF. 2 Disconnect and check IPK harness plug IP02. 3 Check and repair. <ul style="list-style-type: none"> • Corrosion(install new adapting piece or terminal-cleaning module and pin). • Pin damaged or bent-install new terminal/pin. • Fly out of pins-install new pins as needed. 4 Reconnect the IPK plug and all other previously disconnected plug. Make sure the pin is properly positioned and fixed. 5 Run the system and determine if the problem persists?
YES → Repair the IPK.	
NO ↓	
At this point the system is functioning normally. The problem may be caused by module connections. Address the root cause of any connector or pin problems,	
Next Step ↓	
Diagnosis end.	

0xC122-87

Fault diagnosis code
0xC122-87: ABS communication lost
Detection tools
1 Multimeter and diagnostic apparatus
Possible causes
<ul style="list-style-type: none"> • Circuit, terminal and adapting piece fault • CAN • IPK
Conditions for fault code operation
Turn the ignition switch to ON position.
Conditions for fault code setting
0xC122-87
ABS message lost for more than 10 weeks.
To set the effect of a fault code condition
Description of circuit diagram
<p>The device is connected to the serial data circuit to monitor the serial data communication when the vehicle works normally. Devices exchange operation information and instructions with each other. The device has programming information that needs to be exchanged on the serial data circuit. The receiver device also monitors this information; In addition, some periodic information is used to indicate the availability of the transmitter device.</p>

Circuit diagram

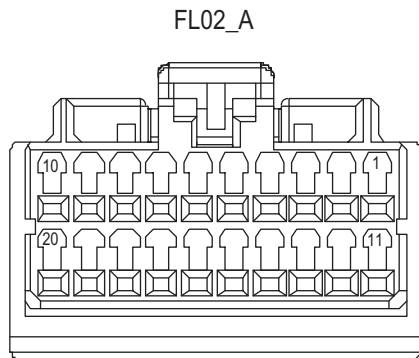
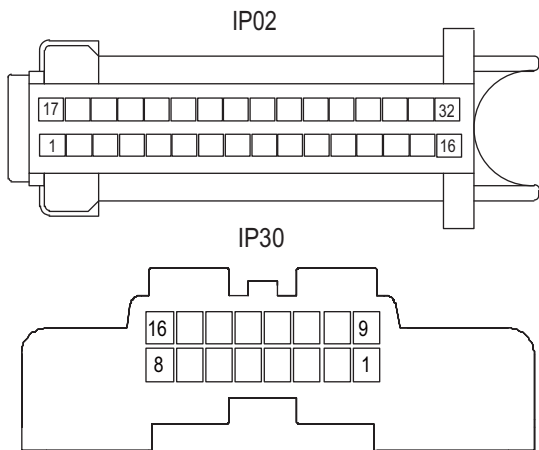
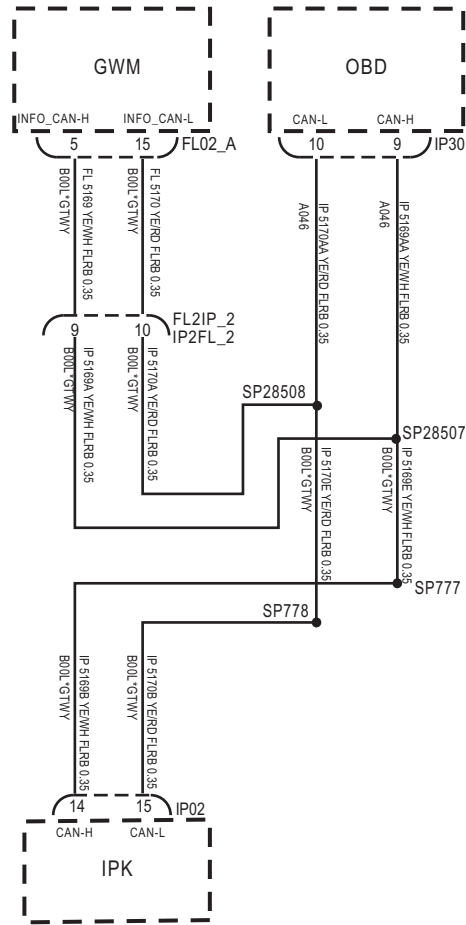

EK899005

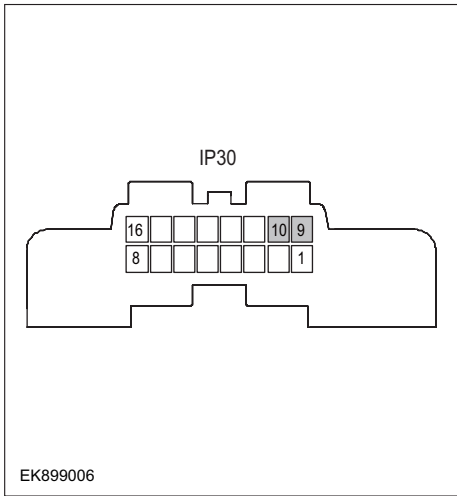
Troubleshooting steps	
Step1	General inspection.
	<ol style="list-style-type: none"> 1 Check fuses for damage. 2 Check battery capacity. 3 Check the harness plug of IPK for damage, poor contact, aging and looseness. 4 Check whether the result is normal or not?
	NO → Repair or replace the faulted parts.
YES ↓	
Step2	Check fault codes.
	<ol style="list-style-type: none"> 1 Connect the fault diagnosis instrument to the diagnosis interface. 2 Turn the ignition switch to ON position. 3 Diagnose the IPK module with diagnostic apparatus. 4 Is there a fault code other than 0xC122-87?
	YES → Refer to: DTC Summary list (IPK) .
NO ↓	
Step3	Inspection for CAN communication network completeness.
 <p style="text-align: center;">IP30</p> <p style="text-align: left;">EK899006</p>	<ol style="list-style-type: none"> 1 Turn the ignition switch to OFF. 2 Measure the resistance between the harness terminals of diagnose interface. Measuring circuit: resistance between terminal 9 and terminal 10 of IP30 plug. Standard value: ≈ 60Ω 3 Check whether the result is normal or not?
	NO → Repair or replace the faulted parts.
YES ↓	

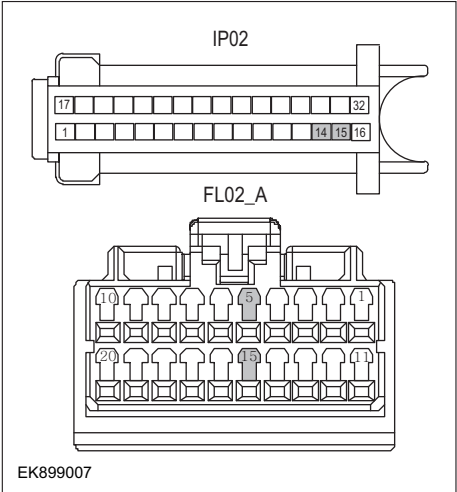
Step4	Check the resistance of gateway module and IPK terminal.。
	<ol style="list-style-type: none"> 1 Turn the ignition switch to OFF. 2 Disconnect the gateway module harness plug FL02 _ A. 3 Measure the resistance between the gateway module harness terminals. Measuring circuit: resistance between terminal 5 and terminal 15 of FL02_A plug. Standard value: 110~130Ω 4 Connect the gateway module harness plug FL02 _ A. 5 Disconnect IPK harness plug IP02. 6 Measure the resistance between IPK harness terminals. Measuring circuit: resistance between terminal 14 and terminal 15 of IP02 plug. Standard value: 110~130Ω 7 Check whether the result is normal or not?
NO → Repair or replace the faulted parts.	
YES ↓	
Step5	Check whether IPK is abnormal.
	<ol style="list-style-type: none"> 1 Turn the ignition switch to OFF. 2 Disconnect and check IPK harness plug IP02. 3 Check and repair. <ul style="list-style-type: none"> • Corrosion(install new adapting piece or terminal-cleaning module and pin). • Pin damaged or bent-install new terminal/pin. • Fly out of pins-install new pins as needed. 4 Reconnect the IPK plug and all other previously disconnected plug. Make sure the pin is properly positioned and fixed. 5 Run the system and determine if the problem persists?
YES → Repair the IPK.	
NO ↓	
At this point the system is functioning normally. The problem may be caused by module connections. Address the root cause of any connector or pin problems,	
Next Step ↓	
Diagnosis end.	

0xC123-87

Fault diagnosis code
0xC123-87: SRS communication lost
Detection tools
1 Multimeter and diagnostic apparatus
Possible causes
<ul style="list-style-type: none"> • Circuit, terminal and adapting piece fault • CAN • IPK
Conditions for fault code operation
Turn the ignition switch to ON position.
Conditions for fault code setting
0xC123-87
SRS message lost for more than 10 weeks.
To set the effect of a fault code condition
Description of circuit diagram
<p>The device is connected to the serial data circuit to monitor the serial data communication when the vehicle works normally. Devices exchange operation information and instructions with each other. The device has programming information that needs to be exchanged on the serial data circuit. The receiver device also monitors this information; In addition, some periodic information is used to indicate the availability of the transmitter device.</p>

Circuit diagram

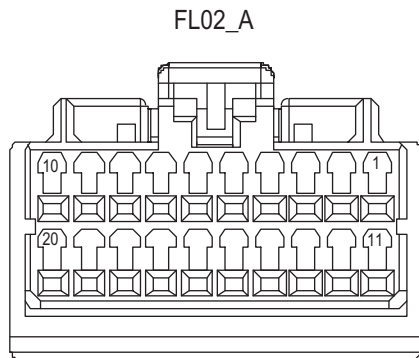
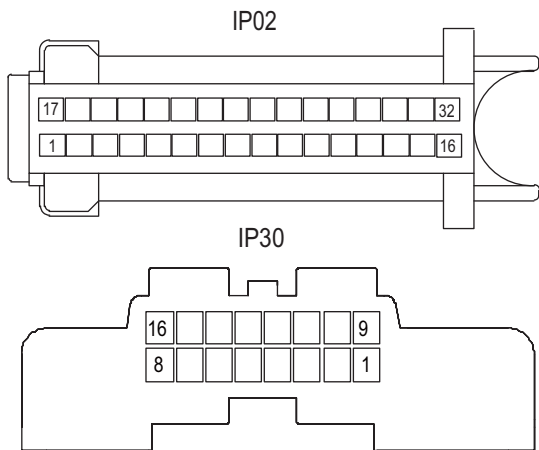
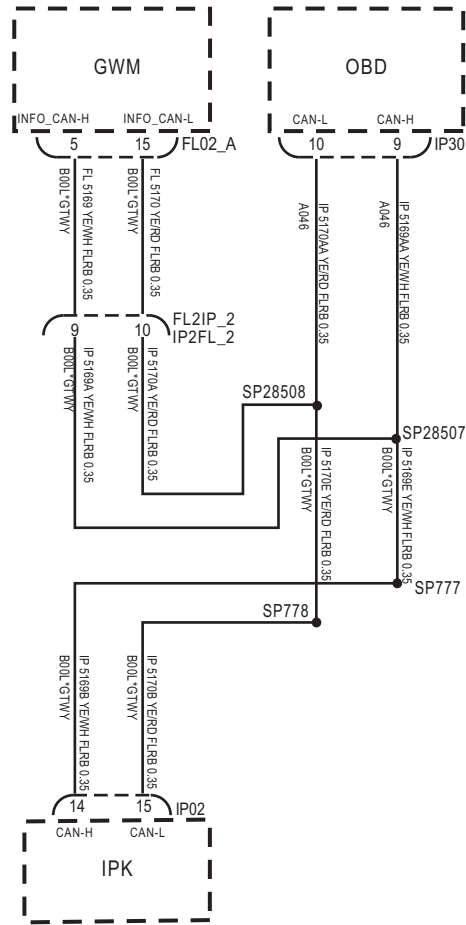

EK899005

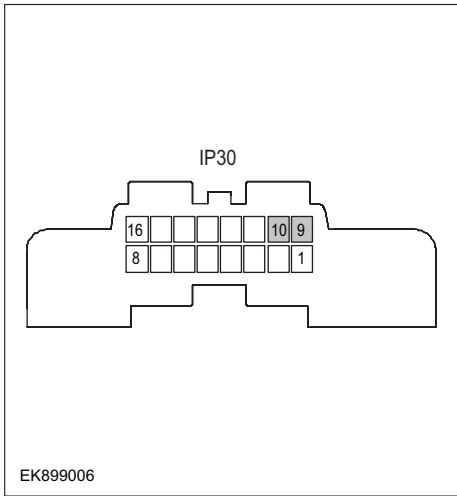
Troubleshooting steps	
Step1	General inspection.
	<ol style="list-style-type: none"> 1 Check fuses for damage. 2 Check battery capacity. 3 Check the harness plug of IPK for damage, poor contact, aging and looseness. 4 Check whether the result is normal or not?
	NO → Repair or replace the faulted parts.
YES ↓	
Step2	Check fault codes.
	<ol style="list-style-type: none"> 1 Connect the fault diagnosis instrument to the diagnosis interface. 2 Turn the ignition switch to ON position. 3 Diagnose the IPK module with diagnostic apparatus. 4 Is there a fault code other than 0xC123-87?
	YES → Refer to: DTC Summary list (IPK) .
NO ↓	
Step3	Inspection for CAN communication network completeness.
	<ol style="list-style-type: none"> 1 Turn the ignition switch to OFF. 2 Measure the resistance between the harness terminals of diagnose interface. Measuring circuit: resistance between terminal 9 and terminal 10 of IP30 plug. Standard value: $\approx 60\Omega$ 3 Check whether the result is normal or not?
	NO → Repair or replace the faulted parts.
YES ↓	

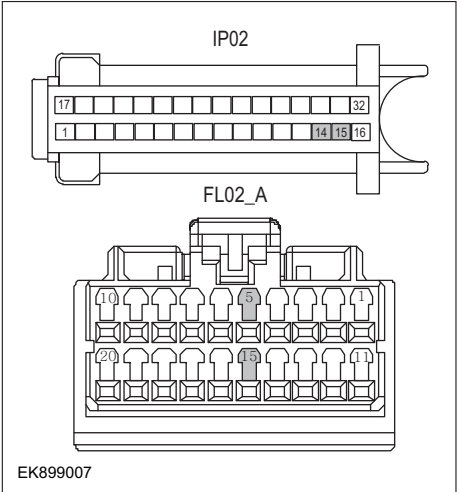
Step4	Check the resistance of gateway module and IPK terminal.。
	<ol style="list-style-type: none"> 1 Turn the ignition switch to OFF. 2 Disconnect the gateway module harness plug FL02 _ A. 3 Measure the resistance between the gateway module harness terminals. Measuring circuit: resistance between terminal 5 and terminal 15 of FL02_A plug. Standard value: 110~130Ω 4 Connect the gateway module harness plug FL02 _ A. 5 Disconnect IPK harness plug IP02. 6 Measure the resistance between IPK harness terminals. Measuring circuit: resistance between terminal 14 and terminal 15 of IP02 plug. Standard value: 110~130Ω 7 Check whether the result is normal or not?
NO → Repair or replace the faulted parts.	
YES ↓	
Step5	Check whether IPK is abnormal.
	<ol style="list-style-type: none"> 1 Turn the ignition switch to OFF. 2 Disconnect and check IPK harness plug IP02. 3 Check and repair. <ul style="list-style-type: none"> • Corrosion(install new adapting piece or terminal-cleaning module and pin). • Pin damaged or bent-install new terminal/pin. • Fly out of pins-install new pins as needed. 4 Reconnect the IPK plug and all other previously disconnected plug. Make sure the pin is properly positioned and fixed. 5 Run the system and determine if the problem persists?
YES → Repair the IPK.	
NO ↓	
At this point the system is functioning normally. The problem may be caused by module connections. Address the root cause of any connector or pin problems,	
Next Step ↓	
Diagnosis end.	

0xC127-87

Fault diagnosis code
0xC127-87: TPMS communication lost
Detection tools
1 Multimeter and diagnostic apparatus
Possible causes
<ul style="list-style-type: none"> • Circuit, terminal and adapting piece fault • CAN • IPK
Conditions for fault code operation
Turn the ignition switch to ON position.
Conditions for fault code setting
0xC127-87
TPMS message is lost for more than 10 cycles.
To set the effect of a fault code condition
Description of circuit diagram
<p>The device is connected to the serial data circuit to monitor the serial data communication when the vehicle works normally. Devices exchange operation information and instructions with each other. The device has programming information that needs to be exchanged on the serial data circuit. The receiver device also monitors this information; In addition, some periodic information is used to indicate the availability of the transmitter device.</p>

Circuit diagram

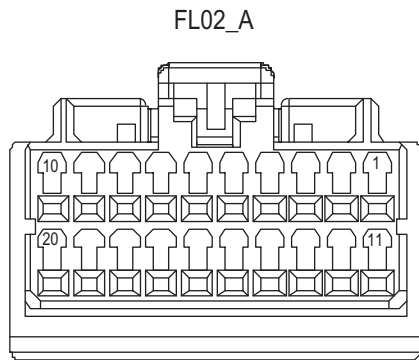
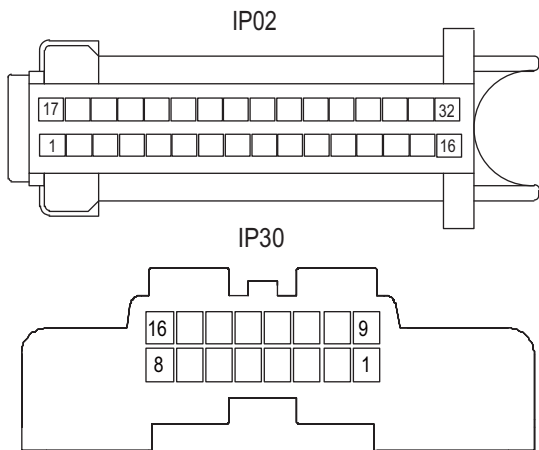
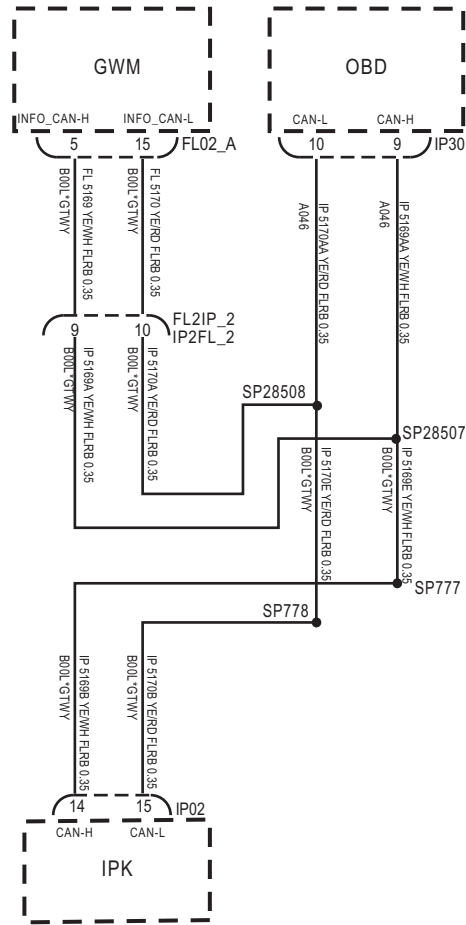

EK899005

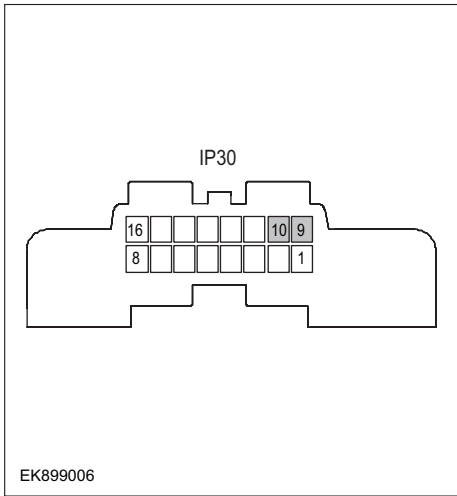
Troubleshooting steps	
Step1	General inspection.
	<ol style="list-style-type: none"> 1 Check fuses for damage. 2 Check battery capacity. 3 Check the harness plug of IPK for damage, poor contact, aging and looseness. 4 Check whether the result is normal or not?
	NO → Repair or replace the faulted parts.
YES ↓	
Step2	Check fault codes.
	<ol style="list-style-type: none"> 1 Connect the fault diagnosis instrument to the diagnosis interface. 2 Turn the ignition switch to ON position. 3 Diagnose the IPK module with diagnostic apparatus. 4 Is there a fault code other than 0xC127-87?
	YES → Refer to: DTC Summary list (IPK) .
NO ↓	
Step3	Inspection for CAN communication network completeness.
 <p style="text-align: center;">IP30</p> <p style="text-align: center;">EK899006</p>	<ol style="list-style-type: none"> 1 Turn the ignition switch to OFF. 2 Measure the resistance between the harness terminals of diagnose interface. Measuring circuit: resistance between terminal 9 and terminal 10 of IP30 plug. Standard value: ≈ 60Ω 3 Check whether the result is normal or not?
	NO → Repair or replace the faulted parts.
YES ↓	

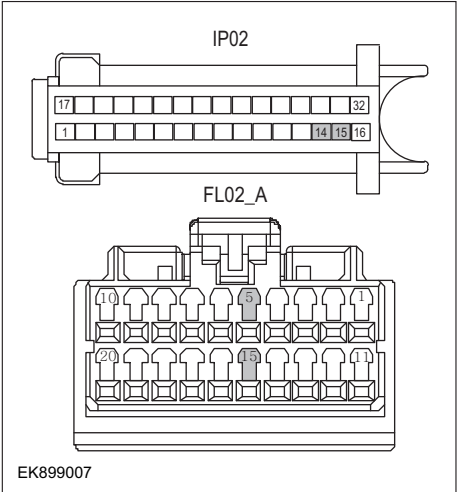
Step4	Check the resistance of gateway module and IPK terminal.。
	<ol style="list-style-type: none"> 1 Turn the ignition switch to OFF. 2 Disconnect the gateway module harness plug FL02 _ A. 3 Measure the resistance between the gateway module harness terminals. Measuring circuit: resistance between terminal 5 and terminal 15 of FL02_A plug. Standard value: 110~130Ω 4 Connect the gateway module harness plug FL02 _ A. 5 Disconnect IPK harness plug IP02. 6 Measure the resistance between IPK harness terminals. Measuring circuit: resistance between terminal 14 and terminal 15 of IP02 plug. Standard value: 110~130Ω 7 Check whether the result is normal or not?
NO → Repair or replace the faulted parts.	
YES ↓	
Step5	Check whether IPK is abnormal.
	<ol style="list-style-type: none"> 1 Turn the ignition switch to OFF. 2 Disconnect and check IPK harness plug IP02. 3 Check and repair. <ul style="list-style-type: none"> • Corrosion(install new adapting piece or terminal-cleaning module and pin). • Pin damaged or bent-install new terminal/pin. • Fly out of pins-install new pins as needed. 4 Reconnect the IPK plug and all other previously disconnected plug. Make sure the pin is properly positioned and fixed. 5 Run the system and determine if the problem persists?
YES → Repair the IPK.	
NO ↓	
At this point the system is functioning normally. The problem may be caused by module connections. Address the root cause of any connector or pin problems,	
Next Step ↓	
Diagnosis end.	

0xC126-87

Fault diagnosis code
0xC126-87: PEPS communication lost
Detection tools
1 Multimeter and diagnostic apparatus
Possible causes
<ul style="list-style-type: none"> • Circuit, terminal and adapting piece fault • CAN • IPK
Conditions for fault code operation
Turn the ignition switch to ON position.
Conditions for fault code setting
0xC126-87
PEPS message is lost for more than 10 cycles.
To set the effect of a fault code condition
Description of circuit diagram
<p>The device is connected to the serial data circuit to monitor the serial data communication when the vehicle works normally. Devices exchange operation information and instructions with each other. The device has programming information that needs to be exchanged on the serial data circuit. The receiver device also monitors this information; In addition, some periodic information is used to indicate the availability of the transmitter device.</p>

Circuit diagram

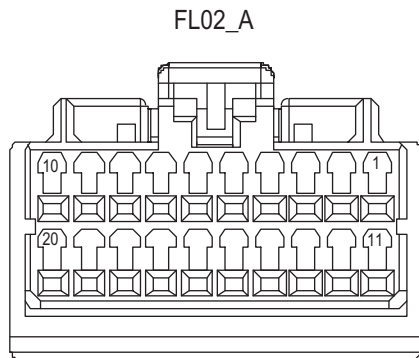
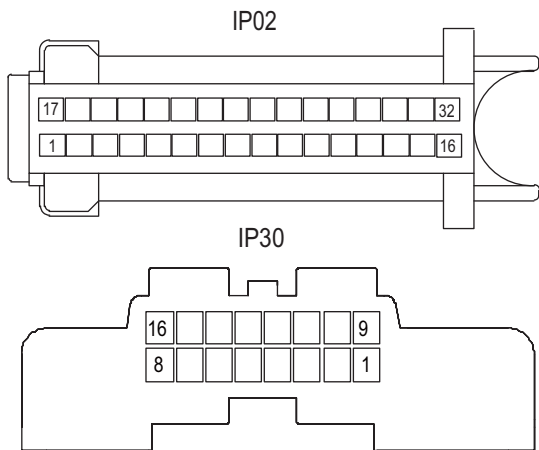
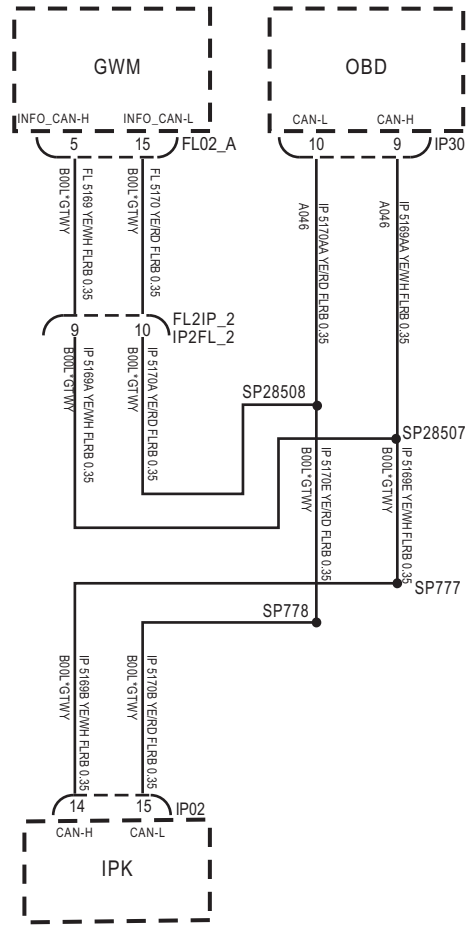

EK899005

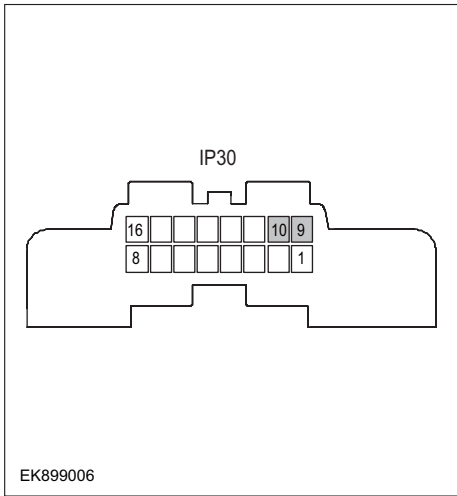
Troubleshooting steps	
Step1	General inspection.
	<ol style="list-style-type: none"> 1 Check fuses for damage. 2 Check battery capacity. 3 Check the harness plug of IPK for damage, poor contact, aging and looseness. 4 Check whether the result is normal or not?
	NO → Repair or replace the faulted parts.
YES ↓	
Step2	Check fault codes.
	<ol style="list-style-type: none"> 1 Connect the fault diagnosis instrument to the diagnosis interface. 2 Turn the ignition switch to ON position. 3 Diagnose the IPK module with diagnostic apparatus. 4 Is there a fault code other than 0xC126-87?
	YES → Refer to: DTC Summary list (IPK) .
NO ↓	
Step3	Inspection for CAN communication network completeness.
 <p style="text-align: center;">IP30</p> <p style="text-align: left;">EK899006</p>	<ol style="list-style-type: none"> 1 Turn the ignition switch to OFF. 2 Measure the resistance between the harness terminals of diagnose interface. Measuring circuit: resistance between terminal 9 and terminal 10 of IP30 plug. Standard value: ≈ 60Ω 3 Check whether the result is normal or not?
	NO → Repair or replace the faulted parts.
YES ↓	

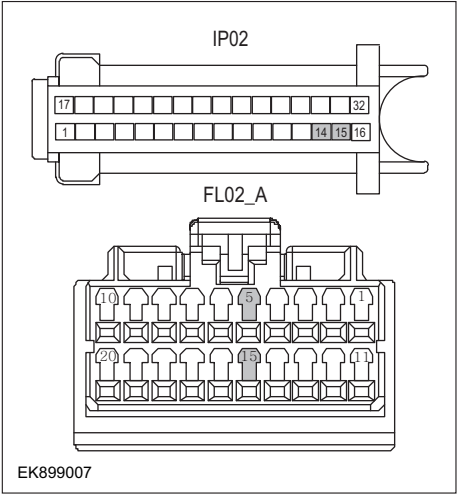
Step4	Check the resistance of gateway module and IPK terminal.。
	<ol style="list-style-type: none"> 1 Turn the ignition switch to OFF. 2 Disconnect the gateway module harness plug FL02 _ A. 3 Measure the resistance between the gateway module harness terminals. Measuring circuit: resistance between terminal 5 and terminal 15 of FL02_A plug. Standard value: 110~130Ω 4 Connect the gateway module harness plug FL02 _ A. 5 Disconnect IPK harness plug IP02. 6 Measure the resistance between IPK harness terminals. Measuring circuit: resistance between terminal 14 and terminal 15 of IP02 plug. Standard value: 110~130Ω 7 Check whether the result is normal or not?
NO → Repair or replace the faulted parts.	
YES ↓	
Step5	Check whether IPK is abnormal.
	<ol style="list-style-type: none"> 1 Turn the ignition switch to OFF. 2 Disconnect and check IPK harness plug IP02. 3 Check and repair. <ul style="list-style-type: none"> • Corrosion(install new adapting piece or terminal-cleaning module and pin). • Pin damaged or bent-install new terminal/pin. • Fly out of pins-install new pins as needed. 4 Reconnect the IPK plug and all other previously disconnected plug. Make sure the pin is properly positioned and fixed. 5 Run the system and determine if the problem persists?
YES → Repair the IPK.	
NO ↓	
At this point the system is functioning normally. The problem may be caused by module connections. Address the root cause of any connector or pin problems,	
Next Step ↓	
Diagnosis end.	

0xC073-87

Fault diagnosis code
0xC073-87: CAN in bus off state
Detection tools
1 Multimeter and diagnostic apparatus
Possible causes
<ul style="list-style-type: none"> • Circuit, terminal and adapting piece fault • CAN • IPK
Conditions for fault code operation
Turn the ignition switch to ON position.
Conditions for fault code setting
0xC073-87
The bus is in the BUSOFF state.
To set the effect of a fault code condition
Description of circuit diagram
<p>The device is connected to the serial data circuit to monitor the serial data communication when the vehicle works normally. Devices exchange operation information and instructions with each other. The device has programming information that needs to be exchanged on the serial data circuit. The receiver device also monitors this information; In addition, some periodic information is used to indicate the availability of the transmitter device.</p>

Circuit diagram

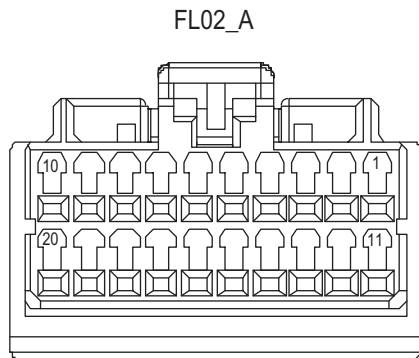
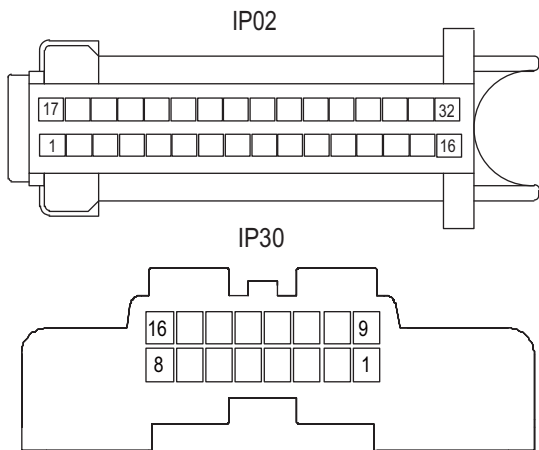
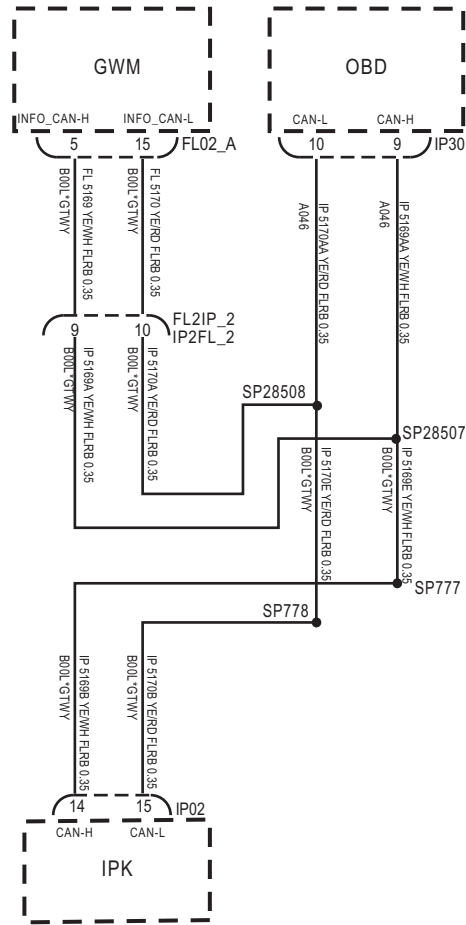

EK899005

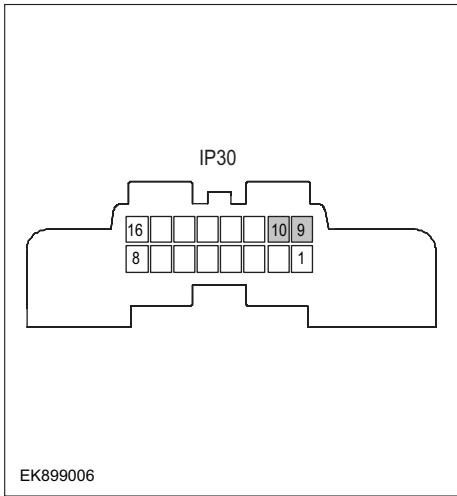
Troubleshooting steps	
Step1	General inspection.
	<ol style="list-style-type: none"> 1 Check fuses for damage. 2 Check battery capacity. 3 Check the harness plug of IPK for damage, poor contact, aging and looseness. 4 Check whether the result is normal or not?
	NO → Repair or replace the faulted parts.
YES ↓	
Step2	Check fault codes.
	<ol style="list-style-type: none"> 1 Connect the fault diagnosis instrument to the diagnosis interface. 2 Turn the ignition switch to ON position. 3 Diagnose the IPK module with diagnostic apparatus. 4 Is there a fault code other than 0xC073-87?
	YES → Refer to: DTC Summary list (IPK) .
NO ↓	
Step3	Inspection for CAN communication network completeness.
 <p style="text-align: center;">IP30</p> <p style="text-align: center;">EK899006</p>	<ol style="list-style-type: none"> 1 Turn the ignition switch to OFF. 2 Measure the resistance between the harness terminals of diagnose interface. Measuring circuit: resistance between terminal 9 and terminal 10 of IP30 plug. Standard value: ≈ 60Ω 3 Check whether the result is normal or not?
	NO → Repair or replace the faulted parts.
YES ↓	

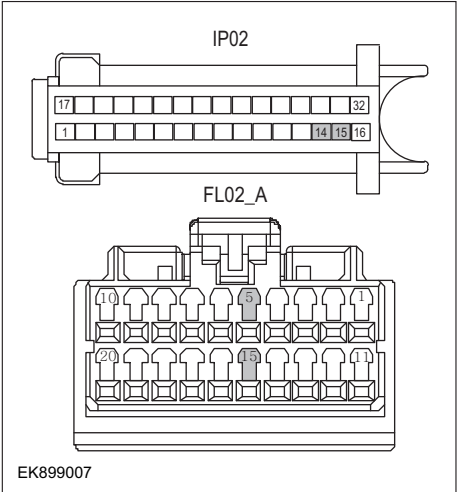
Step4	Check the resistance of gateway module and IPK terminal.。
	<ol style="list-style-type: none"> 1 Turn the ignition switch to OFF. 2 Disconnect the gateway module harness plug FL02 _ A. 3 Measure the resistance between the gateway module harness terminals. Measuring circuit: resistance between terminal 5 and terminal 15 of FL02_A plug. Standard value: 110~130Ω 4 Connect the gateway module harness plug FL02 _ A. 5 Disconnect IPK harness plug IP02. 6 Measure the resistance between IPK harness terminals. Measuring circuit: resistance between terminal 14 and terminal 15 of IP02 plug. Standard value: 110~130Ω 7 Check whether the result is normal or not?
NO → Repair or replace the faulted parts.	
YES ↓	
Step5	Check whether IPK is abnormal.
	<ol style="list-style-type: none"> 1 Turn the ignition switch to OFF. 2 Disconnect and check IPK harness plug IP02. 3 Check and repair. <ul style="list-style-type: none"> • Corrosion(install new adapting piece or terminal-cleaning module and pin). • Pin damaged or bent-install new terminal/pin. • Fly out of pins-install new pins as needed. 4 Reconnect the IPK plug and all other previously disconnected plug. Make sure the pin is properly positioned and fixed. 5 Run the system and determine if the problem persists?
YES → Repair the IPK.	
NO ↓	
At this point the system is functioning normally. The problem may be caused by module connections. Address the root cause of any connector or pin problems,	
Next Step ↓	
Diagnosis end.	

0xD005-87

Fault diagnosis code
0xD005-87: Bus communication exception
Detection tools
1 Multimeter and diagnostic apparatus
Possible causes
<ul style="list-style-type: none"> • Circuit, terminal and adapting piece fault • CAN • IPK
Conditions for fault code operation
Turn the ignition switch to ON position.
Conditions for fault code setting
0xD005-87
Bus fault
To set the effect of a fault code condition
Description of circuit diagram
<p>The device is connected to the serial data circuit to monitor the serial data communication when the vehicle works normally. Devices exchange operation information and instructions with each other. The device has programming information that needs to be exchanged on the serial data circuit. The receiver device also monitors this information; In addition, some periodic information is used to indicate the availability of the transmitter device.</p>

Circuit diagram

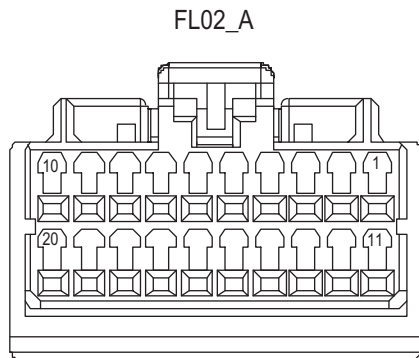
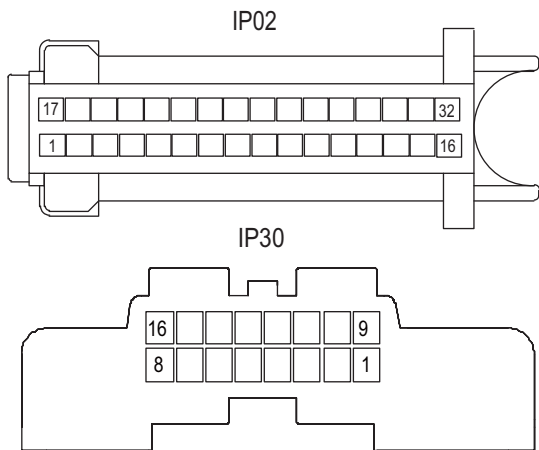
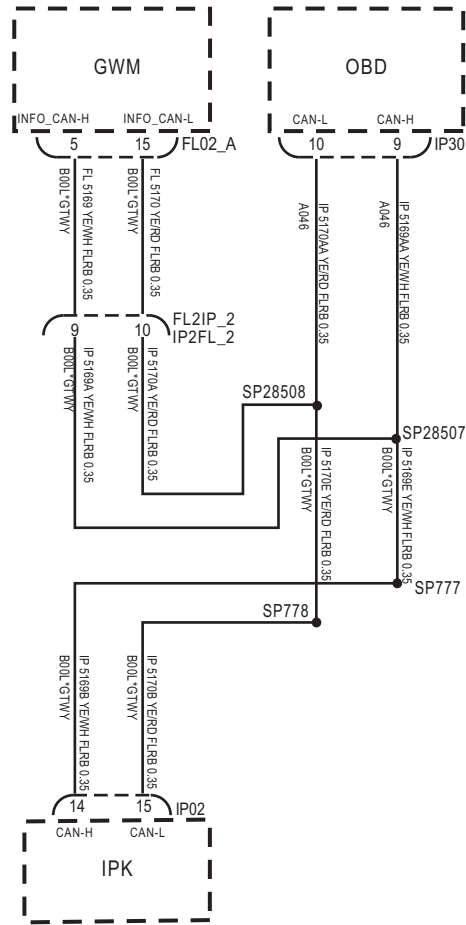

EK899005

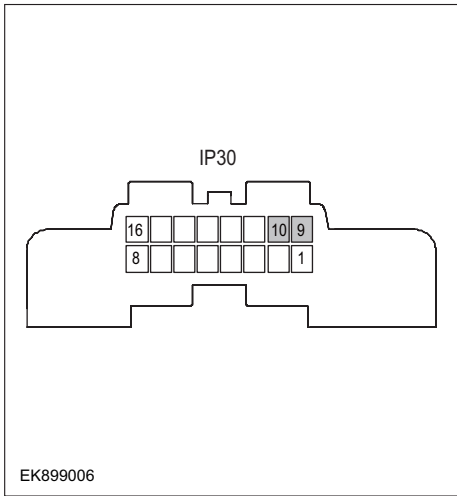
Troubleshooting steps	
Step1	General inspection.
	<ol style="list-style-type: none"> 1 Check fuses for damage. 2 Check battery capacity. 3 Check the harness plug of IPK for damage, poor contact, aging and looseness. 4 Check whether the result is normal or not?
	NO → Repair or replace the faulted parts.
YES ↓	
Step2	Check fault codes.
	<ol style="list-style-type: none"> 1 Connect the fault diagnosis instrument to the diagnosis interface. 2 Turn the ignition switch to ON position. 3 Diagnose the IPK module with diagnostic apparatus. 4 Is there a fault code other than 0xD005-87?
	YES → Refer to: DTC Summary list (IPK) .
NO ↓	
Step3	Inspection for CAN communication network completeness.
 <p style="text-align: center;">IP30</p> <p style="text-align: left;">EK899006</p>	<ol style="list-style-type: none"> 1 Turn the ignition switch to OFF. 2 Measure the resistance between the harness terminals of diagnose interface. Measuring circuit: resistance between terminal 9 and terminal 10 of IP30 plug. Standard value: ≈ 60Ω 3 Check whether the result is normal or not?
	NO → Repair or replace the faulted parts.
YES ↓	

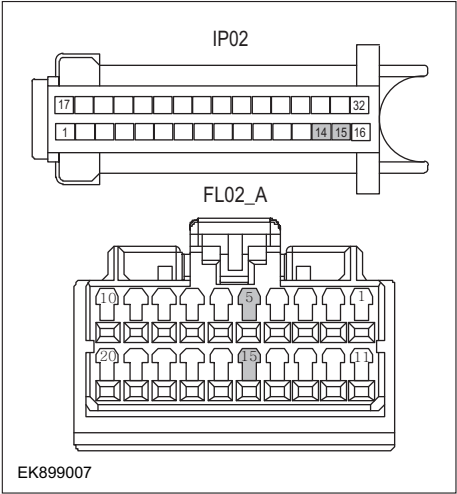
Step4	Check the resistance of gateway module and IPK terminal.。
	<ol style="list-style-type: none"> 1 Turn the ignition switch to OFF. 2 Disconnect the gateway module harness plug FL02 _ A. 3 Measure the resistance between the gateway module harness terminals. Measuring circuit: resistance between terminal 5 and terminal 15 of FL02_A plug. Standard value: 110~130Ω 4 Connect the gateway module harness plug FL02 _ A. 5 Disconnect IPK harness plug IP02. 6 Measure the resistance between IPK harness terminals. Measuring circuit: resistance between terminal 14 and terminal 15 of IP02 plug. Standard value: 110~130Ω 7 Check whether the result is normal or not?
NO → Repair or replace the faulted parts.	
YES ↓	
Step5	Check whether IPK is abnormal.
	<ol style="list-style-type: none"> 1 Turn the ignition switch to OFF. 2 Disconnect and check IPK harness plug IP02. 3 Check and repair. <ul style="list-style-type: none"> • Corrosion(install new adapting piece or terminal-cleaning module and pin). • Pin damaged or bent-install new terminal/pin. • Fly out of pins-install new pins as needed. 4 Reconnect the IPK plug and all other previously disconnected plug. Make sure the pin is properly positioned and fixed. 5 Run the system and determine if the problem persists?
YES → Repair the IPK.	
NO ↓	
At this point the system is functioning normally. The problem may be caused by module connections. Address the root cause of any connector or pin problems,	
Next Step ↓	
Diagnosis end.	

0xC210-00

Fault diagnosis code
0xC210-00: ODO backup VIN code error
Detection tools
1 Multimeter and diagnostic apparatus
Possible causes
<ul style="list-style-type: none"> • Circuit, terminal and adapting piece fault • CAN • IPK
Conditions for fault code operation
Turn the ignition switch to ON position.
Conditions for fault code setting
0xC210-00
Error in VIN code of mileage backup.
To set the effect of a fault code condition
Description of circuit diagram
<p>The device is connected to the serial data circuit to monitor the serial data communication when the vehicle works normally. Devices exchange operation information and instructions with each other. The device has programming information that needs to be exchanged on the serial data circuit. The receiver device also monitors this information; In addition, some periodic information is used to indicate the availability of the transmitter device.</p>

Circuit diagram

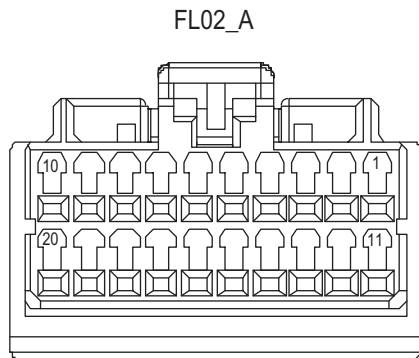
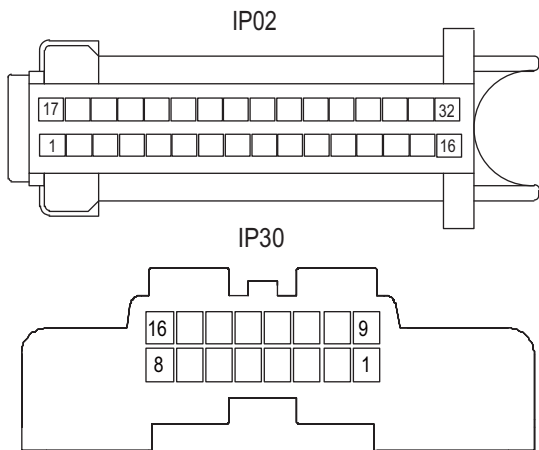
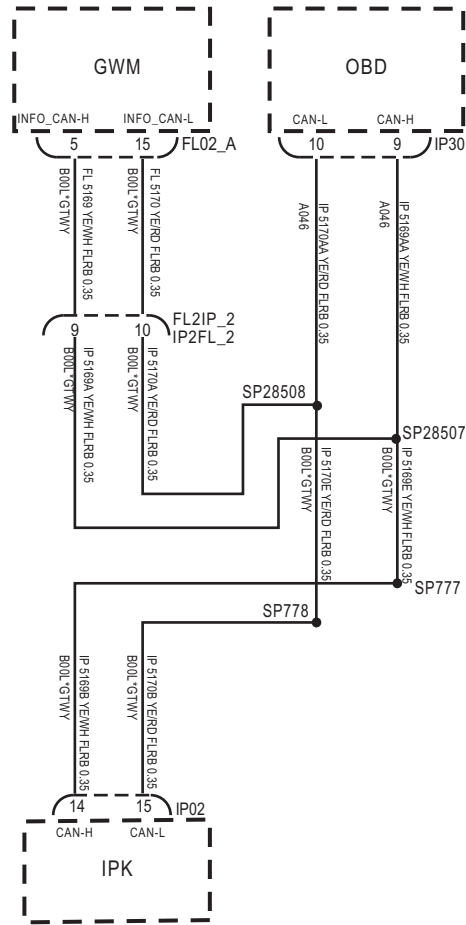

EK899005

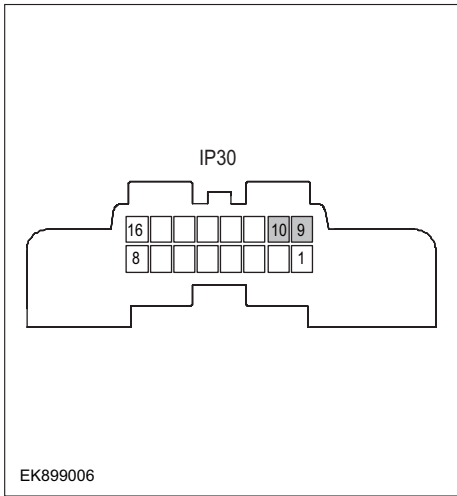
Troubleshooting steps	
Step1	General inspection.
	<ol style="list-style-type: none"> 1 Check fuses for damage. 2 Check battery capacity. 3 Check the harness plug of IPK for damage, poor contact, aging and looseness. 4 Check whether the result is normal or not?
	NO → Repair or replace the faulted parts.
YES ↓	
Step2	Check fault codes.
	<ol style="list-style-type: none"> 1 Connect the fault diagnosis instrument to the diagnosis interface. 2 Turn the ignition switch to ON position. 3 Diagnose the IPK module with diagnostic apparatus. 4 Is there a fault code other than 0xC210-00?
	YES → Refer to: DTC Summary list (IPK) .
NO ↓	
Step3	Inspection for CAN communication network completeness.
 <p style="text-align: center;">IP30</p> <p style="text-align: center;">EK899006</p>	<ol style="list-style-type: none"> 1 Turn the ignition switch to OFF. 2 Measure the resistance between the harness terminals of diagnose interface. Measuring circuit: resistance between terminal 9 and terminal 10 of IP30 plug. Standard value: ≈ 60Ω 3 Check whether the result is normal or not?
	NO → Repair or replace the faulted parts.
YES ↓	

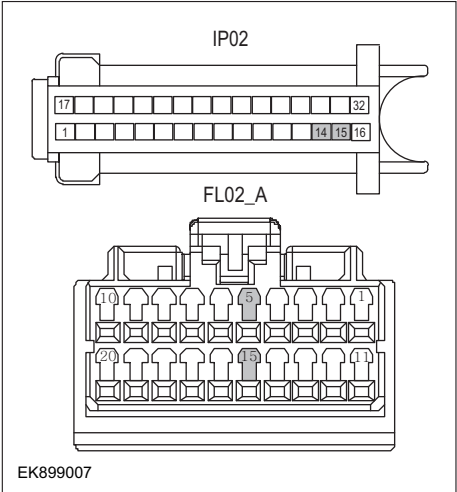
Step4	Check the resistance of gateway module and IPK terminal.。
	<ol style="list-style-type: none"> 1 Turn the ignition switch to OFF. 2 Disconnect the gateway module harness plug FL02 _ A. 3 Measure the resistance between the gateway module harness terminals. Measuring circuit: resistance between terminal 5 and terminal 15 of FL02_A plug. Standard value: 110~130Ω 4 Connect the gateway module harness plug FL02 _ A. 5 Disconnect IPK harness plug IP02. 6 Measure the resistance between IPK harness terminals. Measuring circuit: resistance between terminal 14 and terminal 15 of IP02 plug. Standard value: 110~130Ω 7 Check whether the result is normal or not?
NO → Repair or replace the faulted parts.	
YES ↓	
Step5	Check whether IPK is abnormal.
	<ol style="list-style-type: none"> 1 Turn the ignition switch to OFF. 2 Disconnect and check IPK harness plug IP02. 3 Check and repair. <ul style="list-style-type: none"> • Corrosion(install new adapting piece or terminal-cleaning module and pin). • Pin damaged or bent-install new terminal/pin. • Fly out of pins-install new pins as needed. 4 Reconnect the IPK plug and all other previously disconnected plug. Make sure the pin is properly positioned and fixed. 5 Run the system and determine if the problem persists?
YES → Repair the IPK.	
NO ↓	
At this point the system is functioning normally. The problem may be caused by module connections. Address the root cause of any connector or pin problems,	
Next Step ↓	
Diagnosis end.	

0xC132-87

Fault diagnosis code
0xC132-87: EPS communication lost
Detection tools
1 Multimeter and diagnostic apparatus
Possible causes
<ul style="list-style-type: none"> • Circuit, terminal and adapting piece fault • CAN • IPK
Conditions for fault code operation
Turn the ignition switch to ON position.
Conditions for fault code setting
0xC132-87
The EPS message is lost for more than 10 cycles.
To set the effect of a fault code condition
Description of circuit diagram
The device is connected to the serial data circuit to monitor the serial data communication when the vehicle works normally. Devices exchange operation information and instructions with each other. The device has programming information that needs to be exchanged on the serial data circuit. The receiver device also monitors this information; In addition, some periodic information is used to indicate the availability of the transmitter device.

Circuit diagram

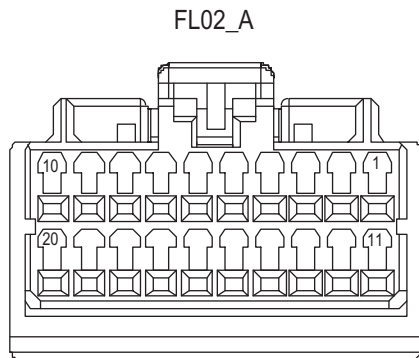
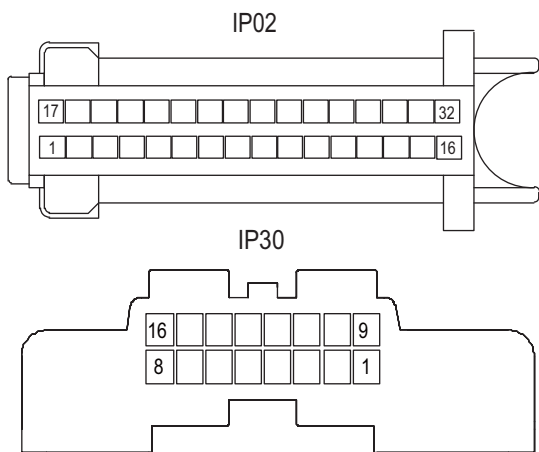
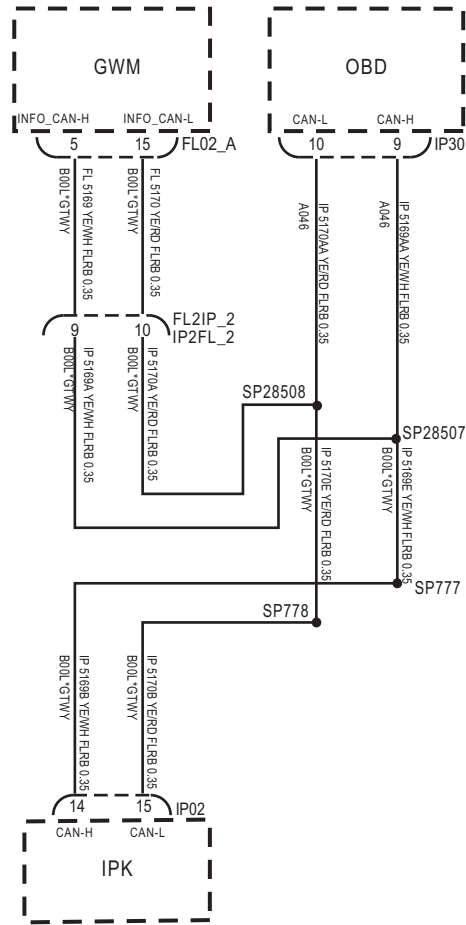

EK899005

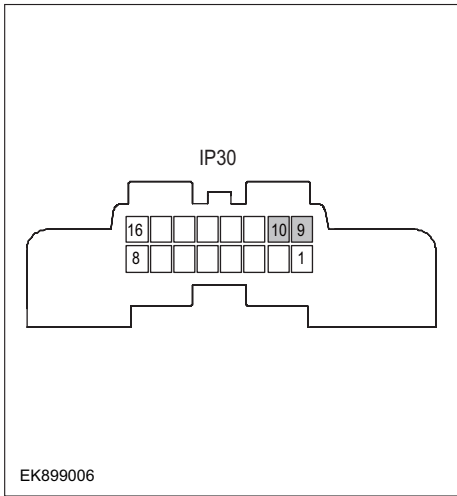
Troubleshooting steps	
Step1	General inspection.
	<ol style="list-style-type: none"> 1 Check fuses for damage. 2 Check battery capacity. 3 Check the harness plug of IPK for damage, poor contact, aging and looseness. 4 Check whether the result is normal or not?
	NO → Repair or replace the faulted parts.
YES ↓	
Step2	Check fault codes.
	<ol style="list-style-type: none"> 1 Connect the fault diagnosis instrument to the diagnosis interface. 2 Turn the ignition switch to ON position. 3 Diagnose the IPK module with diagnostic apparatus. 4 Is there a fault code other than 0xC132-87?
	YES → Refer to: DTC Summary list (IPK) .
NO ↓	
Step3	Inspection for CAN communication network completeness.
 <p style="text-align: center;">IP30</p> <p style="text-align: left;">EK899006</p>	<ol style="list-style-type: none"> 1 Turn the ignition switch to OFF. 2 Measure the resistance between the harness terminals of diagnose interface. Measuring circuit: resistance between terminal 9 and terminal 10 of IP30 plug. Standard value: ≈ 60Ω 3 Check whether the result is normal or not?
	NO → Repair or replace the faulted parts.
YES ↓	

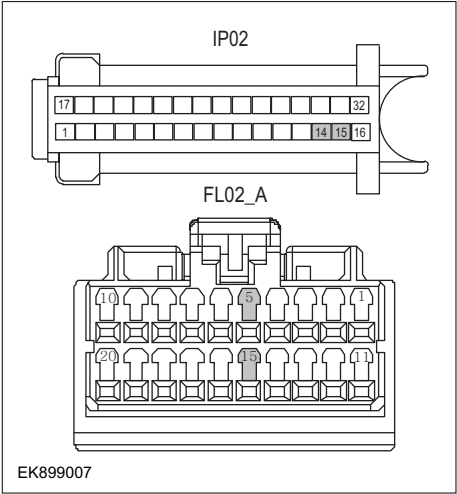
Step4	Check the resistance of gateway module and IPK terminal.。
	<ol style="list-style-type: none"> 1 Turn the ignition switch to OFF. 2 Disconnect the gateway module harness plug FL02 _ A. 3 Measure the resistance between the gateway module harness terminals. Measuring circuit: resistance between terminal 5 and terminal 15 of FL02_A plug. Standard value: 110~130Ω 4 Connect the gateway module harness plug FL02 _ A. 5 Disconnect IPK harness plug IP02. 6 Measure the resistance between IPK harness terminals. Measuring circuit: resistance between terminal 14 and terminal 15 of IP02 plug. Standard value: 110~130Ω 7 Check whether the result is normal or not?
NO → Repair or replace the faulted parts.	
YES ↓	
Step5	Check whether IPK is abnormal.
	<ol style="list-style-type: none"> 1 Turn the ignition switch to OFF. 2 Disconnect and check IPK harness plug IP02. 3 Check and repair. <ul style="list-style-type: none"> • Corrosion(install new adapting piece or terminal-cleaning module and pin). • Pin damaged or bent-install new terminal/pin. • Fly out of pins-install new pins as needed. 4 Reconnect the IPK plug and all other previously disconnected plug. Make sure the pin is properly positioned and fixed. 5 Run the system and determine if the problem persists?
YES → Repair the IPK.	
NO ↓	
At this point the system is functioning normally. The problem may be caused by module connections. Address the root cause of any connector or pin problems,	
Next Step ↓	
Diagnosis end.	

0xC136-87

Fault diagnosis code
0xC136-87: VCU communication lost
Detection tools
1 Multimeter and diagnostic apparatus
Possible causes
<ul style="list-style-type: none"> • Circuit, terminal and adapting piece fault • CAN • IPK
Conditions for fault code operation
Turn the ignition switch to ON position.
Conditions for fault code setting
0xC136-87
VCU message lost for more than 10 cycles.
To set the effect of a fault code condition
Description of circuit diagram
<p>The device is connected to the serial data circuit to monitor the serial data communication when the vehicle works normally. Devices exchange operation information and instructions with each other. The device has programming information that needs to be exchanged on the serial data circuit. The receiver device also monitors this information; In addition, some periodic information is used to indicate the availability of the transmitter device.</p>

Circuit diagram

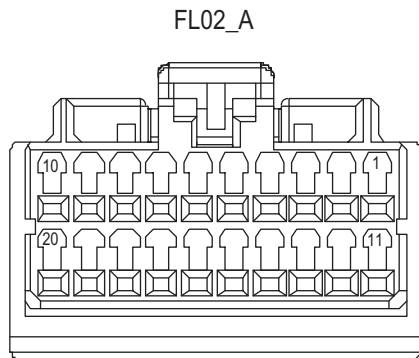
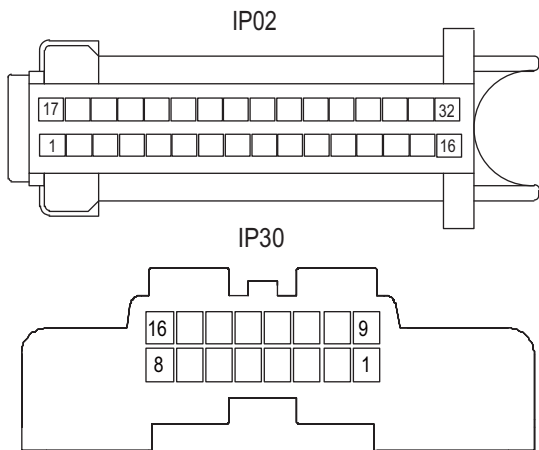
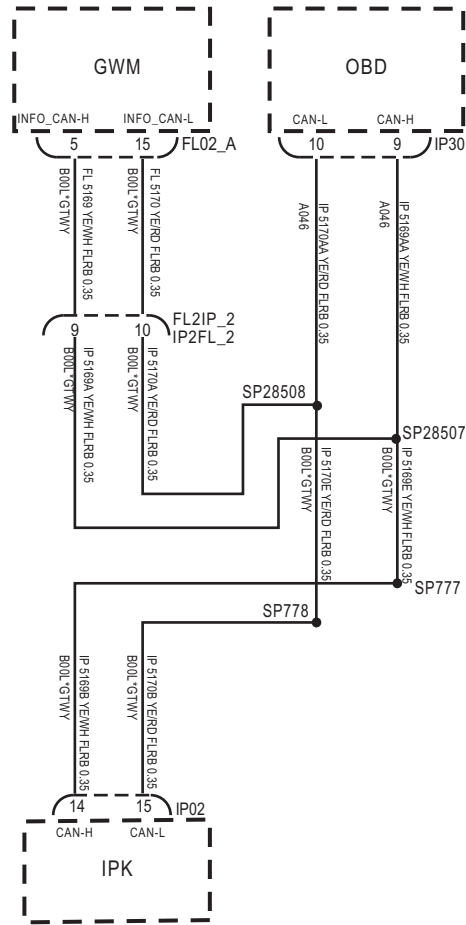

EK899005

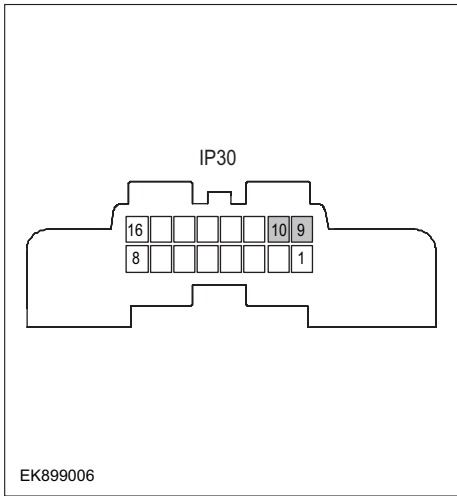
Troubleshooting steps	
Step1	General inspection.
	<ol style="list-style-type: none"> 1 Check fuses for damage. 2 Check battery capacity. 3 Check the harness plug of IPK for damage, poor contact, aging and looseness. 4 Check whether the result is normal or not?
NO → Repair or replace the faulted parts.	
YES ↓	
Step2	Check fault codes.
	<ol style="list-style-type: none"> 1 Connect the fault diagnosis instrument to the diagnosis interface. 2 Turn the ignition switch to ON position. 3 Diagnose the IPK module with diagnostic apparatus. 4 Is there a fault code other than 0xC136-87?
YES → Refer to: DTC Summary list (IPK) .	
NO ↓	
Step3	Inspection for CAN communication network completeness.
 <p style="text-align: center;">IP30</p> <p style="text-align: left;">EK899006</p>	<ol style="list-style-type: none"> 1 Turn the ignition switch to OFF. 2 Measure the resistance between the harness terminals of diagnose interface. Measuring circuit: resistance between terminal 9 and terminal 10 of IP30 plug. Standard value: ≈ 60Ω 3 Check whether the result is normal or not?
NO → Repair or replace the faulted parts.	
YES ↓	

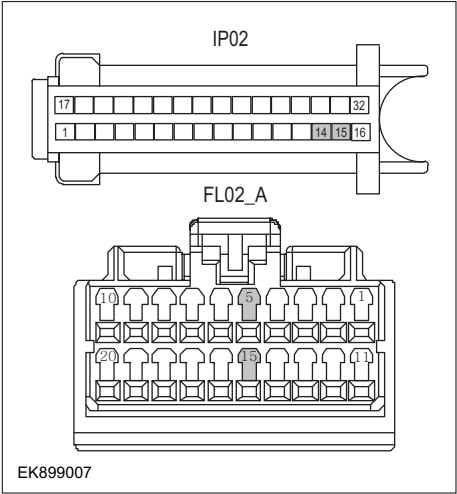
Step4	Check the resistance of gateway module and IPK terminal.。
	<ol style="list-style-type: none"> 1 Turn the ignition switch to OFF. 2 Disconnect the gateway module harness plug FL02 _ A. 3 Measure the resistance between the gateway module harness terminals. Measuring circuit: resistance between terminal 5 and terminal 15 of FL02_A plug. Standard value: 110~130Ω 4 Connect the gateway module harness plug FL02 _ A. 5 Disconnect IPK harness plug IP02. 6 Measure the resistance between IPK harness terminals. Measuring circuit: resistance between terminal 14 and terminal 15 of IP02 plug. Standard value: 110~130Ω 7 Check whether the result is normal or not?
NO → Repair or replace the faulted parts.	
YES ↓	
Step5	Check whether IPK is abnormal.
	<ol style="list-style-type: none"> 1 Turn the ignition switch to OFF. 2 Disconnect and check IPK harness plug IP02. 3 Check and repair. <ul style="list-style-type: none"> • Corrosion(install new adapting piece or terminal-cleaning module and pin). • Pin damaged or bent-install new terminal/pin. • Fly out of pins-install new pins as needed. 4 Reconnect the IPK plug and all other previously disconnected plug. Make sure the pin is properly positioned and fixed. 5 Run the system and determine if the problem persists?
YES → Repair the IPK.	
NO ↓	
At this point the system is functioning normally. The problem may be caused by module connections. Address the root cause of any connector or pin problems,	
Next Step ↓	
Diagnosis end.	

0xC137-87

Fault diagnosis code
0xC137-87: BMS communication lost
Detection tools
1 Multimeter and diagnostic apparatus
Possible causes
<ul style="list-style-type: none"> • Circuit, terminal and adapting piece fault • CAN • IPK
Conditions for fault code operation
Turn the ignition switch to ON position.
Conditions for fault code setting
0xC137-87
BMS message lost for more than 10 cycles.
To set the effect of a fault code condition
Description of circuit diagram
<p>The device is connected to the serial data circuit to monitor the serial data communication when the vehicle works normally. Devices exchange operation information and instructions with each other. The device has programming information that needs to be exchanged on the serial data circuit. The receiver device also monitors this information; In addition, some periodic information is used to indicate the availability of the transmitter device.</p>

Circuit diagram

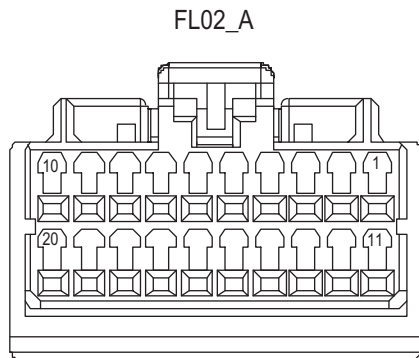
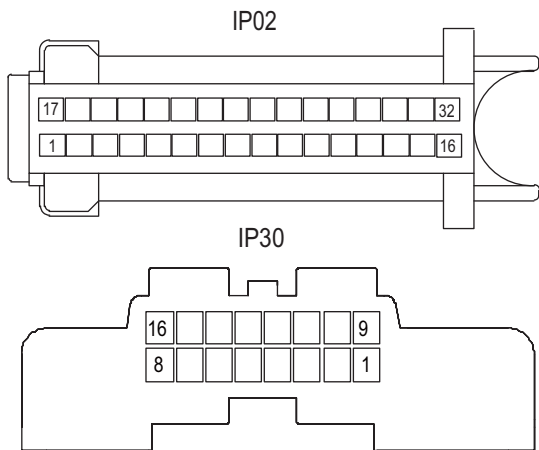
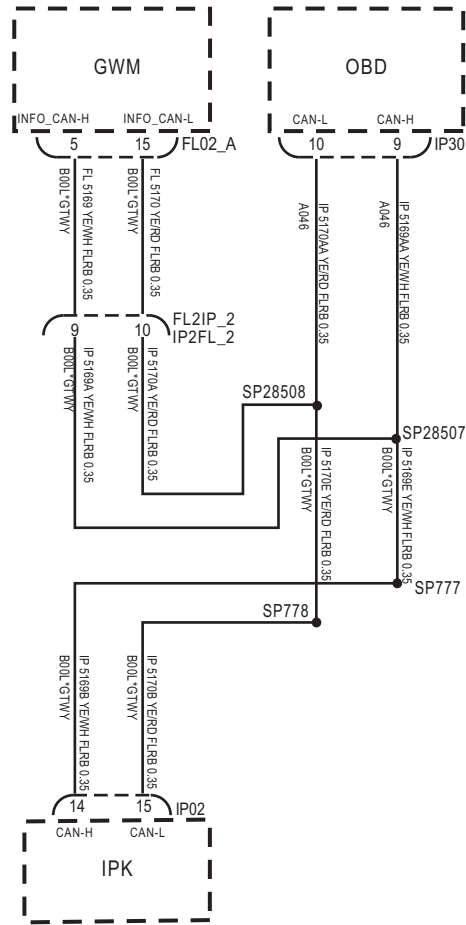

EK899005

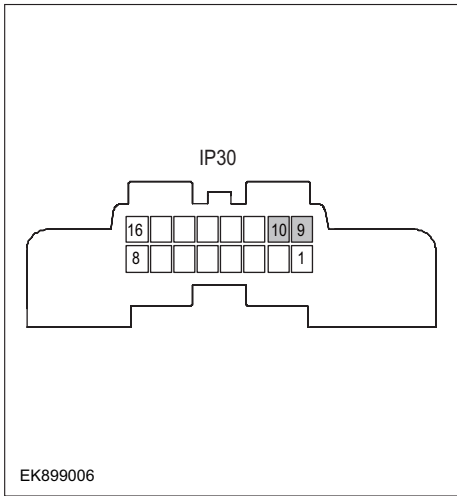
Troubleshooting steps	
Step1	General inspection.
	<ol style="list-style-type: none"> 1 Check fuses for damage. 2 Check battery capacity. 3 Check the harness plug of IPK for damage, poor contact, aging and looseness. 4 Check whether the result is normal or not?
	NO → Repair or replace the faulted parts.
YES ↓	
Step2	Check fault codes.
	<ol style="list-style-type: none"> 1 Connect the fault diagnosis instrument to the diagnosis interface. 2 Turn the ignition switch to ON position. 3 Diagnose the IPK module with diagnostic apparatus. 4 Is there a fault code other than 0xC137-87?
	YES → Refer to: DTC Summary list (IPK) .
NO ↓	
Step3	Inspection for CAN communication network completeness.
 <p style="text-align: center;">IP30</p> <p style="text-align: center;">EK899006</p>	<ol style="list-style-type: none"> 1 Turn the ignition switch to OFF. 2 Measure the resistance between the harness terminals of diagnose interface. Measuring circuit: resistance between terminal 9 and terminal 10 of IP30 plug. Standard value: ≈ 60Ω 3 Check whether the result is normal or not?
	NO → Repair or replace the faulted parts.
YES ↓	

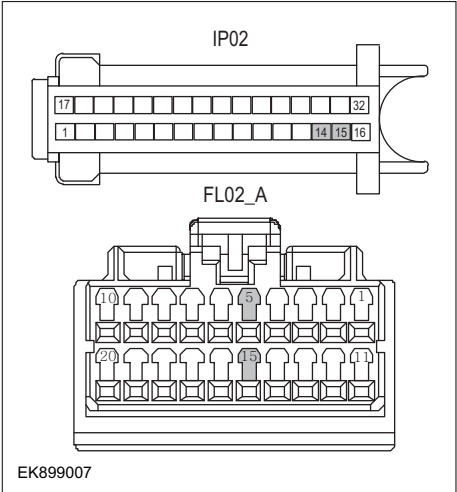
Step4	Check the resistance of gateway module and IPK terminal.。
	<ol style="list-style-type: none"> 1 Turn the ignition switch to OFF. 2 Disconnect the gateway module harness plug FL02 _ A. 3 Measure the resistance between the gateway module harness terminals. Measuring circuit: resistance between terminal 5 and terminal 15 of FL02_A plug. Standard value: 110~130Ω 4 Connect the gateway module harness plug FL02 _ A. 5 Disconnect IPK harness plug IP02. 6 Measure the resistance between IPK harness terminals. Measuring circuit: resistance between terminal 14 and terminal 15 of IP02 plug. Standard value: 110~130Ω 7 Check whether the result is normal or not?
NO → Repair or replace the faulted parts.	
YES ↓	
Step5	Check whether IPK is abnormal.
	<ol style="list-style-type: none"> 1 Turn the ignition switch to OFF. 2 Disconnect and check IPK harness plug IP02. 3 Check and repair. <ul style="list-style-type: none"> • Corrosion(install new adapting piece or terminal-cleaning module and pin). • Pin damaged or bent-install new terminal/pin. • Fly out of pins-install new pins as needed. 4 Reconnect the IPK plug and all other previously disconnected plug. Make sure the pin is properly positioned and fixed. 5 Run the system and determine if the problem persists?
YES → Repair the IPK.	
NO ↓	
At this point the system is functioning normally. The problem may be caused by module connections. Address the root cause of any connector or pin problems,	
Next Step ↓	
Diagnosis end.	

0xC138-87

Fault diagnosis code
0xC138-87: BMS communication lost
Detection tools
1 Multimeter and diagnostic apparatus
Possible causes
<ul style="list-style-type: none"> • Circuit, terminal and adapting piece fault • CAN • IPK
Conditions for fault code operation
Turn the ignition switch to ON position.
Conditions for fault code setting
0xC138-87
PEU message is lost for more than 10 cycles.
To set the effect of a fault code condition
Description of circuit diagram
<p>The device is connected to the serial data circuit to monitor the serial data communication when the vehicle works normally. Devices exchange operation information and instructions with each other. The device has programming information that needs to be exchanged on the serial data circuit. The receiver device also monitors this information; In addition, some periodic information is used to indicate the availability of the transmitter device.</p>

Circuit diagram

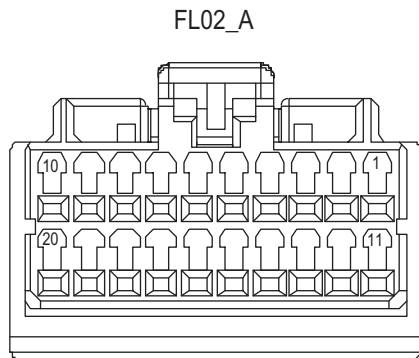
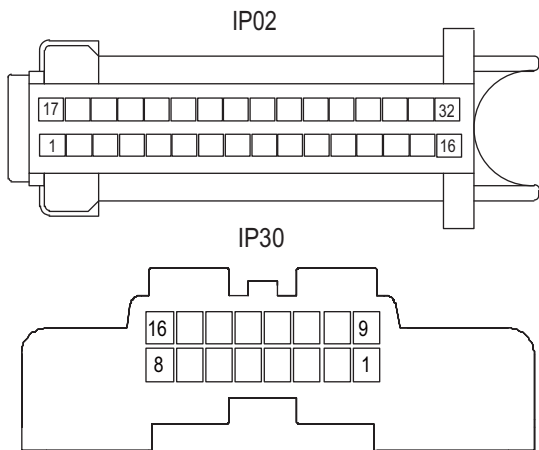
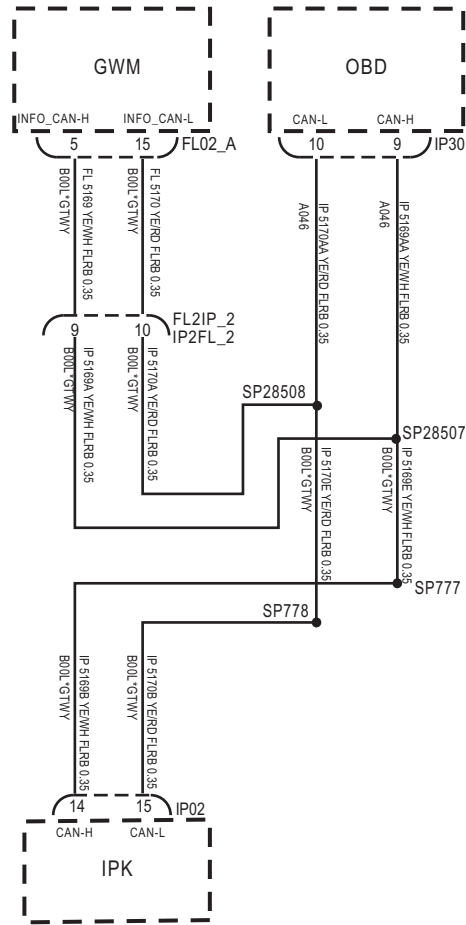

EK899005

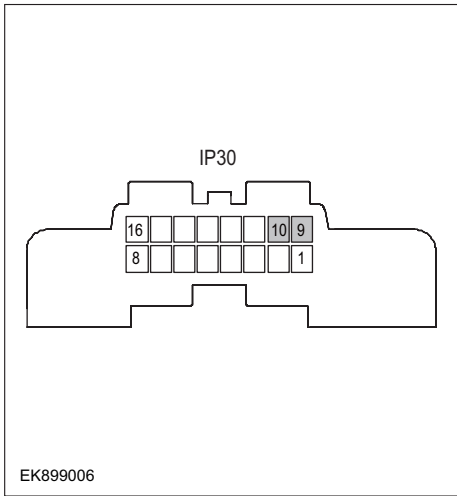
Troubleshooting steps	
Step1	General inspection.
	<ol style="list-style-type: none"> 1 Check fuses for damage. 2 Check battery capacity. 3 Check the harness plug of IPK for damage, poor contact, aging and looseness. 4 Check whether the result is normal or not?
	NO → Repair or replace the faulted parts.
YES ↓	
Step2	Check fault codes.
	<ol style="list-style-type: none"> 1 Connect the fault diagnosis instrument to the diagnosis interface. 2 Turn the ignition switch to ON position. 3 Diagnose the IPK module with diagnostic apparatus. 4 Is there a fault code other than 0xC138-87?
	YES → Refer to: DTC Summary list (IPK) .
NO ↓	
Step3	Inspection for CAN communication network completeness.
 <p style="text-align: center;">IP30</p> <p style="text-align: left;">EK899006</p>	<ol style="list-style-type: none"> 1 Turn the ignition switch to OFF. 2 Measure the resistance between the harness terminals of diagnose interface. Measuring circuit: resistance between terminal 9 and terminal 10 of IP30 plug. Standard value: ≈ 60Ω 3 Check whether the result is normal or not?
	NO → Repair or replace the faulted parts.
YES ↓	

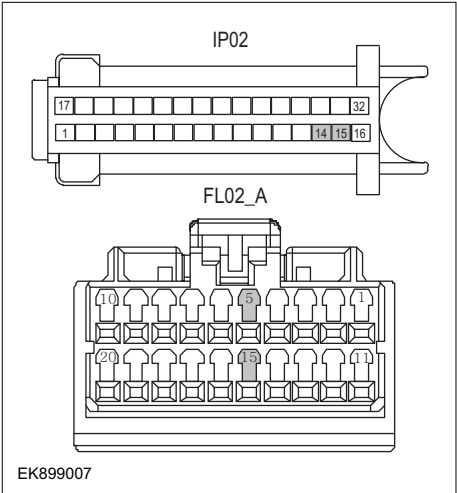
Step4	Check the resistance of gateway module and IPK terminal.
	<ol style="list-style-type: none"> 1 Turn the ignition switch to OFF. 2 Disconnect the gateway module harness plug FL02 _ A. 3 Measure the resistance between the gateway module harness terminals. Measuring circuit: resistance between terminal 5 and terminal 15 of FL02_A plug. Standard value: 110~130Ω 4 Connect the gateway module harness plug FL02 _ A. 5 Disconnect IPK harness plug IP02. 6 Measure the resistance between IPK harness terminals. Measuring circuit: resistance between terminal 14 and terminal 15 of IP02 plug. Standard value: 110~130Ω 7 Check whether the result is normal or not?
<p>NO → Repair or replace the faulted parts.</p>	
<p>YES ↓</p>	
Step5	Check whether IPK is abnormal.
	<ol style="list-style-type: none"> 1 Turn the ignition switch to OFF. 2 Disconnect and check IPK harness plug IP02. 3 Check and repair. <ul style="list-style-type: none"> • Corrosion(install new adapting piece or terminal-cleaning module and pin). • Pin damaged or bent-install new terminal/pin. • Fly out of pins-install new pins as needed. 4 Reconnect the IPK plug and all other previously disconnected plug Make sure the pin is properly positioned and fixed. 5 Run the system and determine if the problem persists?
<p>YES → Repair the IPK.</p>	
<p>NO ↓</p>	
<p>At this point the system is functioning normally. The problem may be caused by module connections. Address the root cause of any connector or pin problems,</p>	
<p>Next Step ↓</p>	
<p>Diagnosis end.</p>	

DTC Summary list(PEU)

Notes for high voltage maintenance:

On the premise of wearing and preparing protective equipment in strict accordance with the requirements of high-voltage maintenance operations, the following points should also be paid attention to:

- 1 The orange wire harness in the cabin is a high-voltage wire harness. Do not touch it without discharge treatment or wearing insulation tools.
- 2 In all maintenance operations involving vehicle electrical and high-voltage wiring harness areas, the high-voltage wiring harness plugs connected with power batteries should be disconnected, and the high-voltage wiring harness and electrical discharge operation.
- 3 Maintenance personnel shall place insulating objects (such as insulation sticks) beside them, and be equipped with safety supervision personnel to avoid inadvertent electric shock.
- 4 Turn off the ignition switch and do not perform other operations within 3 minutes of disconnecting the negative electrode of the battery.
- 5 After the power failure, keep the key of the vehicle and forbid others to operate it.
- 6 If the power battery has a maintenance switch, remove the maintenance switch first and then disconnect the power battery wiring harness.
- 7 For the power battery harness plug, disconnect the low-voltage control harness first and then the high-voltage connection harness (the red harness is positive and the black harness is negative).
- 8 Discharge the wiring harness connecting the positive and negative high voltage terminals of the battery box.
- 9 Discharge high voltage electrical appliances and wire harness terminals. Use a multimeter to measure the voltage at both ends and check that the voltage is zero before performing related operations.
- 10 The disassembled and disconnected connectors of high-voltage electrical appliances shall be sealed with black tape to prevent sundries from entering.
- 11 The wiring harness connectors should be kept dry. If cooling water and oil are accidentally spilled into the high-voltage wiring harness or electrical interior, they should be cleaned and dried with compressed air. And use Megohm meter to measure the insulation resistance of high-voltage electrical appliances or wiring harness to meet the standard before installation.
- 12 Before opening the cover of the engine room of the electric vehicle, the key should be turned to the OFF gear; It is strictly prohibited to touch the devices marked with high pressure danger warning signs in the cabin of the electric vehicle directly; Spraying water or washing is prohibited in the engine room of the vehicle; Do not open the front hatch cover in the rain to prevent electrical leakage.

DTC	English descriptions	Reference page
P0A44-37	Motor overspeed	P0A44-37
P0C79-F0	waring of VDC high	P0C79-F0 、 P1A60-16 、 P0C79-17
P1A60-16	waring of VDC low	
P0C79-17	VDC instantaneous overvoltage	
P0C01-F0	Output short-time overcurrent	P0C01-F0 、 P0C01-19
P0C01-19	Output instantaneous overcurrent	
P0563-A3	Low voltage power supply overvoltage	P0563-A3 、 P0562-A2
P0562-A2	Low voltage power supply undervoltage	
P0A3C-F0	Drive overtemperature	P0A3C-F0
P0A2F-98	Motor overtemperature	P0A2F-98

DTC	English descriptions	Reference page
U0073-88	CAN BusOff	
U0293-87	VCU communication abnormality	U0073-88 , U0293-87 , U0111-87
U0111-87	BMS communication abnormality	
P1A6A-22	Drive internal communication failure	Initialize the module. If it cannot be recovered, replace it.
P0BFD-00	Output unbalanced	P0BFD-00
P1AA2-55	Data logging failed	Initialize the module. If it cannot be recovered, replace it.
P0BE6-1C	Abnormal current sensor	P0BE6-1C
P0AEE-1C	The drive temperature sensor is abnormal	P0AEE-1C , P0A2B-1C , P0A2F-F0 , P0AEE-F0
P0A2B-1C	Motor temperature sensor failure	
P0A2F-F0	Motor over temperature derating	
P0AEE-F0	Driver Overtemperature Derating	
P0D2E-1C	VDC voltage sensor failure	P0D2E-1C
P0A3F-01	Position sensor detection circuit failure	P0A3F-01
P1A69-22	Active discharge circuit fault	P1A69-22 , P1AB4-63
P1AB4-63	Active discharge fault	
P0A3C-98	IGBT OC/OT fault	P0A3C-98
P1A83-22	Drive power failure	Initialize the module. If it cannot be recovered, replace it.
P1ABD-05	Wave verification failed	Initialize and reconfigure parameters.
P1ABF-05	High voltage interlock failure	P1ABF-05
P1ABE-05	Torque Calibration Fault	Initialize the module. If it cannot be recovered, replace it.
P1ABC-05	Self-test failed	
P1A7B-98	Single board overtemperature	P1A7B-98
P0633-00	Drive has no key information	Initialize and reconfigure parameters.
P0513-00	SIM answer error	
P1ABA-02	Invalid SIM response	
P1AB1-05	Anti-theft authentication timeout	
P1ABB-81	SIM teaching request is invalid	
P0C17-54	Resolver offset angle calibration failed	P0C17-54
P0C79-A3	VDC bus overvoltage derating	P0C79-A3 , P1A60-F0
P1A60-F0	VDC bus undervoltage derating	
P0A44-F0	Motor forward over speed derating	P0A44-F0 , P0A44-F1 , P1A92-F0
P0A44-F1	Motor reverse overspeed derating	
P1A92-F0	Motor overload derating	

DTC	English descriptions	Reference page
P1AF0-00	Level 3 reset fault alarm	P1AF0-00

P0A44-37

Fault diagnosis code
P0A44-37: motor over speed
Detection tools
1 Multimeter and diagnostic apparatus
Possible causes
<ul style="list-style-type: none">• Circuit, terminal and adapting piece fault• PEU fault• High voltage insulation fault
Conditions for fault code operation
Turn the ignition switch to ON position.
Conditions for fault code setting
P0A44-37
The actual speed of the motor is greater than the threshold (upper limit 11330rpm, lower limit -5000rpm)
To set the effect of a fault code condition
Derated operation

Troubleshooting procedures	
Step 1	General inspection.
	<ol style="list-style-type: none"> 1 Check the fuse for damage. 2 Check battery capacity. 3 Check the harness plug of PEU for damage, poor contact, aging and looseness. 4 Check whether the result is normal or not?
	NO → Repair or replace the faulted parts.
YES ↓	
Step 2	Check fault codes.
	<ol style="list-style-type: none"> 1 Connect the fault diagnosis instrument to the diagnosis interface. 2 Turn the ignition switch to ON position. 3 Diagnose the GAW module with diagnostic apparatus. 4 If there is any fault code except for P0A44-37?
	YES → Refer to: DTC Summary list(PEU) .
NO ↓	
Step 3	Check BMS.
	<ol style="list-style-type: none"> 1 Turn the ignition switch to OFF. 2 Connect the fault diagnosis instrument to the diagnosis interface. 3 Turn the ignition switch to ON position. 4 Diagnose the BMS with diagnostic apparatus. 5 Test whether the faulted code is existed.
	YES → DTC diagnosis is performed based on fault codes.
NO ↓	
Step 4	Check the connecting cable of PEU.
	<ol style="list-style-type: none"> 1 Turn the ignition switch to OFF. 2 Make protective preparations according to the safety operation specifications of the high voltage voltage in the maintenance manual. 3 Disconnect the harness plug battery pack high voltage. 4 Disconnect the high voltage harness plug of PEU. 5 Check whether the PEU connection cable is rotten, damaged, and water enters. 6 Check whether the result is normal or not?

PEU

		NO → Repair or replace the faulted parts.
YES ↓		
Step 5	Check the insulation of PEU.	
	1	Use a megohm meter to check the insulation resistance of the PEU housing and grounding according to the procedure in the maintenance manual. Standard value: >20MΩ
	2	Check whether the result is normal or not?
		NO → Repair or replace the faulted parts.
YES ↓		
Step 5	Check the insulation of driving motor.	
	1	Use a megohm meter to check the insulation resistance of the driving motor housing and grounding according to the procedure in the maintenance manual. Standard value: >20MΩ
	2	Check whether the result is normal or not?
		NO → Repair or replace the faulted parts.
YES ↓		
Step 6	Check the high voltage relay.	
	1	Turn the ignition switch to OFF.
	2	Make protective preparations according to the safety operation specifications of the high voltage voltage in the maintenance manual.
	3	Open the PEU end cover.
	4	Check whether the high voltage relay works.
	5	Check whether the result is normal or not?
		NO → Repair or replace the faulted parts.
YES ↓		
Step 7	Perform initialization.	
	1	Turn the ignition switch to OFF.
	2	Connect the fault diagnosis instrument to the diagnosis interface.
	3	Turn the ignition switch to ON.
	4	The governor was initialized with the diagnostic instrument.
	5	Can the governor be initialized and is the governor restored?
		NO → Repair or change the governor.
YES ↓		

Step 8	Check PEU internal circuit.
	<ol style="list-style-type: none"> 1 Turn the ignition switch to OFF. 2 Make protective preparations according to the safety operation specifications of the high voltage voltage in the maintenance manual. 3 Open the PEU end cover. 4 Check the PEU internal circuit and components for obvious damage or . ablation. 5 Check whether the result is normal or not?
	NO → Repair or replace the faulted parts.
YES ↓	
Step 9	Test whether PEU is norm.
	<ol style="list-style-type: none"> 1 Turn the ignition switch to OFF. 2 Disconnect and check the harness plug of PEU. 3 Check and repair: <ul style="list-style-type: none"> • Corrosion(install new adapting piece or terminal-cleaning module and pin). • Pin damaged or bent-install new terminal/pin. 4 Fly out of pins-install new pins as needed. 5 Reconnect the PEU plug and all other previously disconnected plug. Make sure the pin is properly positioned and fixed. 6 Run the system and determine if the problem persists?
	YES → Change the PEU Module
NO ↓	
At this point the system is functioning normally. The problem may be caused by module connections. Address the root cause of any connector or pin problems.	
Next Step ↓	
Diagnosis end.	

PEU

P0C79-F0、 P1A60-16、 P0C79-17

Fault diagnosis code
P1A60-16: VDC low error
P0C79-F0: VDC high error
P0C79-17: VDC instantaneous overvoltage
Detection tools
1 Multimeter and diagnostic apparatus
Possible causes
<ul style="list-style-type: none">• Circuit,terminal and adapting piece fault• PEU fault• High voltage insulation fault• Bus voltage detection circuit in the PEU fault
Conditions for fault code operation
Turn the ignition switch to ON position.
Conditions for fault code setting
P1A60-16
The bus voltage is less than the undervoltage threshold (230V)
P0C79-F0
Greater than the protection threshold 505V
P0C79-17
To set the effect of a fault code condition
Shutdown, no AC output

Troubleshooting procedures	
Step 1	General inspection.
	<ol style="list-style-type: none"> 1 Check the fuse for damage. 2 Check battery capacity. 3 Check the harness plug of PEU for damage, poor contact, aging and looseness. 4 Check whether the result is normal or not?
	NO → Repair or replace the faulted parts.
YES ↓	
Step 2	Check fault codes.
	<ol style="list-style-type: none"> 1 Connect the fault diagnosis instrument to the diagnosis interface. 2 Turn the ignition switch to ON position. 3 Diagnose the GAW module with diagnostic apparatus. 4 Is there any other fault code except for P1A60-16,P0C79-F0,P0C79-17
	YES → Refer to: DTC Summary list(PEU) .
NO ↓	
Step 3	Check BMS.
	<ol style="list-style-type: none"> 1 Turn the ignition switch to OFF. 2 Connect the fault diagnosis instrument to the diagnosis interface. 3 Turn the ignition switch to ON position. 4 Diagnose the BMS with diagnostic apparatus. 5 Test whether the faulted code is existed.
	YES → DTC diagnosis is performed based on fault codes.
NO ↓	
Step 4	Check the connecting cable of PEU.
	<ol style="list-style-type: none"> 1 Turn the ignition switch to OFF. 2 Make protective preparations according to the safety operation specifications of the high voltage voltage in the maintenance manual. 3 Disconnect the harness plug battery pack high voltage. 4 Disconnect the high voltage harness plug of PEU. 5 Check whether the PEU connection cable is rotten, damaged, and water enters. 6 Check whether the result is normal or not?

PEU

		NO → Repair or replace the faulted parts.
YES ↓		
Step 5	Check the insulation of PEU.	
	1	Use a megohm meter to check the insulation resistance of the PEU housing and grounding according to the procedure in the maintenance manual. Standard value: >20MΩ
	2	Check whether the result is normal or not?
		NO → Repair or replace the faulted parts.
YES ↓		
Step 6	Check the insulation of driving motor.	
	1	Use a megohm meter to check the insulation resistance of the driving motor housing and grounding according to the procedure in the maintenance manual. Standard value: >20MΩ
	2	Check whether the result is normal or not?
		NO → Repair or replace the faulted parts.
YES ↓		
Step 7	Check the high voltage relay.	
	1	Turn the ignition switch to OFF.
	2	Make protective preparations according to the safety operation specifications of the high voltage voltage in the maintenance manual.
	3	Open the PEU end cover.
	4	Check whether the high voltage relay works.
	5	Check whether the result is normal or not?
		NO → Repair or replace the faulted parts.
YES ↓		

Step 8	Test whether PEU is norm.
	<ol style="list-style-type: none"> 1 Turn the ignition switch to OFF. 2 Disconnect and check the harness plug of PEU. 3 Check and repair: <ul style="list-style-type: none"> • Corrosion(install new adapting piece or terminal-cleaning module and pin). • Pin damaged or bent-install new terminal/pin. 4 Fly out of pins-install new pins as needed. 5 Reconnect the PEU plug and all other previously disconnected plug. Make sure the pin is properly positioned and fixed. 6 Run the system and determine if the problem persists?
	YES → Change the PEU Module
NO ↓	
At this point the system is functioning normally. The problem may be caused by module connections. Address the root cause of any connector or pin problems.	
Next Step ↓	
Diagnosis end.	

PEU

P0C01-F0、 P0C01-19

Fault diagnosis code
P0C01-F0: Output short-time overcurrent
P0C01-19: Output instantaneous overcurrent
Detection tools
1 Multimeter and diagnostic apparatus
Possible causes
<ul style="list-style-type: none">• Circuit, terminal and adapting piece fault• PEU module fault• High-voltage relay fault• PEU high-voltage relay circuit fault
Conditions for fault code operation
Turn the ignition switch to ON position.
Conditions for fault code setting
P0C01-F0
Greater than the protection threshold 780A
P0C01-19
Greater than the protection threshold 780A
To set the effect of a fault code condition
Shutdown, no AC output

Troubleshooting procedures	
Step 1	General inspection.
	<ol style="list-style-type: none"> 1 Check the fuse for damage. 2 Check battery capacity. 3 Check the harness plug of PEU for damage, poor contact, aging and looseness. 4 Check whether the result is normal or not?
	NO → Repair or replace the faulted parts.
YES ↓	
Step 2	Check fault codes.
	<ol style="list-style-type: none"> 1 Connect the fault diagnosis instrument to the diagnosis interface. 2 Turn the ignition switch to ON position. 3 Diagnose the PEU with diagnostic apparatus. 4 If there is any fault code except for P0C01-F0、 P0C01-19?
	YES → Refer to: DTC Summary list(PEU) .
NO ↓	
Step 3	Check BMS.
	<ol style="list-style-type: none"> 1 Turn the ignition switch to OFF. 2 Connect the fault diagnosis instrument to the diagnosis interface. 3 Turn the ignition switch to ON position. 4 Diagnose the BMS with diagnostic apparatus. 5 Test whether the faulted code is existed.
	YES → DTC diagnosis is performed based on fault codes.
NO ↓	
Step 4	Check the connecting cable of PEU.
	<ol style="list-style-type: none"> 1 Turn the ignition switch to OFF. 2 Make protective preparations according to the safety operation specifications of the high voltage voltage in the maintenance manual. 3 Disconnect the harness plug battery pack high voltage. 4 Disconnect the high voltage harness plug of PEU. 5 Check whether the PEU connection cable is rotten, damaged, and water enters. 6 Check whether the result is normal or not?

PEU

		NO → Repair or replace the faulted parts.
YES ↓		
Step 5	Perform initialization.	
	<ol style="list-style-type: none"> 1 Turn the ignition switch to OFF. 2 Connect the fault diagnosis instrument to the diagnosis interface. 3 Turn the ignition switch to ON. 4 The governor was initialized with the diagnostic instrument. 5 Can the governor be initialized and is the governor restored? 	
		NO → Repair or change the governor.
YES ↓		
Step 6	Check the insulation of PEU.	
	<ol style="list-style-type: none"> 1 Use a megohm meter to check the insulation resistance of the PEU housing and grounding according to the procedure in the maintenance manual. Standard value: >20MΩ 2 Check whether the result is normal or not? 	
		NO → Repair or replace the faulted parts.
YES ↓		
Step 7	Check the insulation of driving motor.	
	<ol style="list-style-type: none"> 1 Use a megohm meter to check the insulation resistance of the driving motor housing and grounding according to the procedure in the maintenance manual. Standard value: >20MΩ 2 Check whether the result is normal or not? 	
		NO → Repair or replace the faulted parts.
YES ↓		
Step 8	Check the high-voltage relay circuit.	
	<ol style="list-style-type: none"> 1 Turn the ignition switch to OFF. 2 Make protective preparations according to the safety operation specifications of the high voltage voltage in the maintenance manual. 3 Open the PEU end cover. 4 Check whether the high-voltage relay circuit exist the situation of open or short circuit. 5 Check whether the high-voltage relay circuit exist the situation of shorting to battery. 6 Check whether the result is normal or not? 	

		NO → Repair or replace the faulted parts.
YES ↓		
Step 9	Check the high-voltage relay monitoring module.	
	<ol style="list-style-type: none"> 1 Turn the ignition switch to OFF. 2 Make protective preparations according to the safety operation specifications of the high voltage voltage in the maintenance manual. 3 Open the PEU end cover. 4 Check the high-voltage relay monitoring module for damage. 5 Check whether the result is normal or not? 	
		NO → Repair or replace the faulted parts.
YES ↓		
Step 10	Test whether PEU is norm.	
	<ol style="list-style-type: none"> 1 Turn the ignition switch to OFF. 2 Disconnect and check the harness plug of PEU. 3 Check and repair: <ul style="list-style-type: none"> • Corrosion(install new adapting piece or terminal-cleaning module and pin). • Pin damaged or bent-install new terminal/pin. 4 Fly out of pins-install new pins as needed. 5 Reconnect the PEU plug and all other previously disconnected plug. Make sure the pin is properly positioned and fixed. 6 Run the system and determine if the problem persists? 	
		YES → Change the PEU Module
NO ↓		
At this point the system is functioning normally. The problem may be caused by module connections. Address the root cause of any connector or pin problems.		
Next Step ↓		
Diagnosis end.		

P0563-A3、 P0562-A2

Fault diagnosis code
P0563-A3: Low voltage power supply overvoltage
P0562-A2: Low voltage power supply undervoltage
Detection tools
1 Multimeter and diagnostic apparatus
Possible causes
<ul style="list-style-type: none"> • Circuit,terminal and adapting piece fault • Battery • PEU • Charging system • Insurance fuse
Conditions for fault code operation
Turn the ignition switch to ON position.
Conditions for fault code setting
P0563-A3
The low voltage supply voltage is greater than the overvoltage threshold. Threshold 1: >16.7V Hysteresis: 0.4V Threshold 2: >19V
P0562-A2
The low voltage supply voltage is less than the undervoltage threshold. Threshold 1: <8V Hysteresis: 0.4V Threshold 2: <4V
To set the effect of a fault code condition
Shutdown, no AC output

Circuit diagram

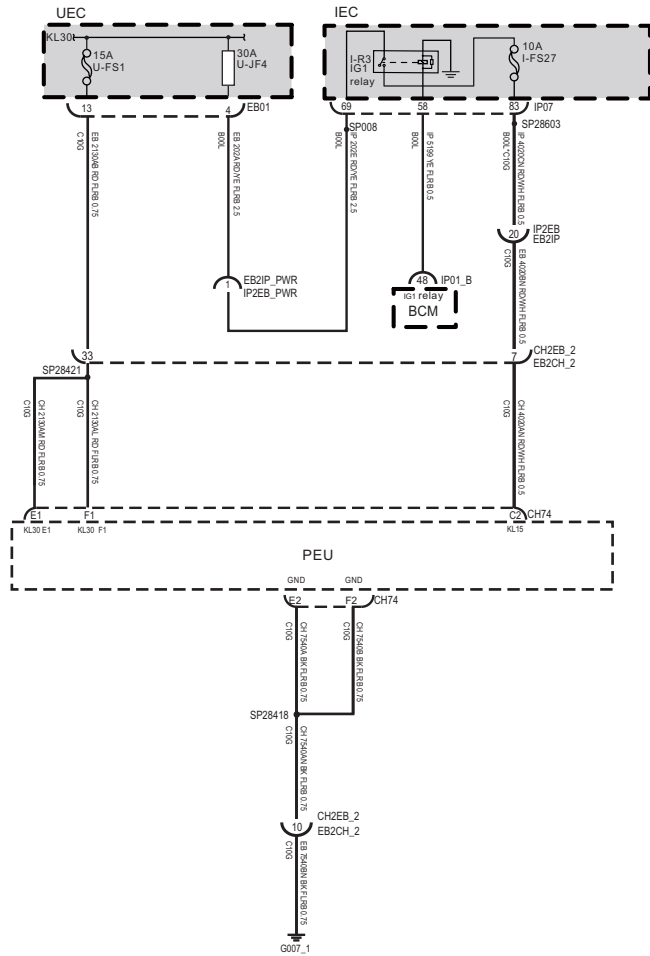

CH74

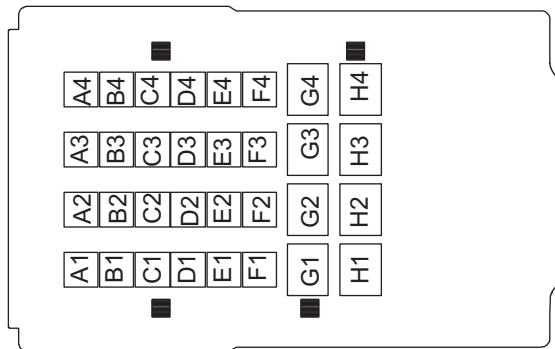

EK891001

Troubleshooting steps		
Step 1	General inspection.	
		<ol style="list-style-type: none"> 1 Check fuses U-FS1/U-JF4/I-FS27 for damage. 2 Check battery capacity. 3 Check the harness plug of air conditioning control module for damage, poor contact, aging and looseness. 4 Check whether the result is normal or not?
		NO → Repair or replace the faulted parts.
YES ↓		
Step 2	Check fault codes.	
		<ol style="list-style-type: none"> 1 Connect the fault diagnosis instrument to the diagnosis interface. 2 Turn the ignition switch to ON position. 3 Diagnose the PEU with diagnostic apparatus. 4 Is there any other fault code except for P0563-A3、P0562-A2?
		YES → Refer to: DTC Summary list(PEU) .
NO ↓		
Step 3	Check charging system	
		<ol style="list-style-type: none"> 1 Connect the fault diagnosis instrument to the diagnosis interface. 2 Turn the ignition switch to ON position. 3 Use the diagnostic apparatus to read DCDC charging parameters. 4 Check whether the charging voltage is normal?
		NO ↓ Check charging system
YES ↓		

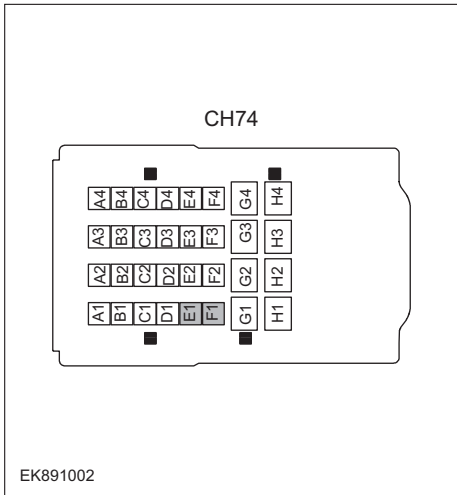
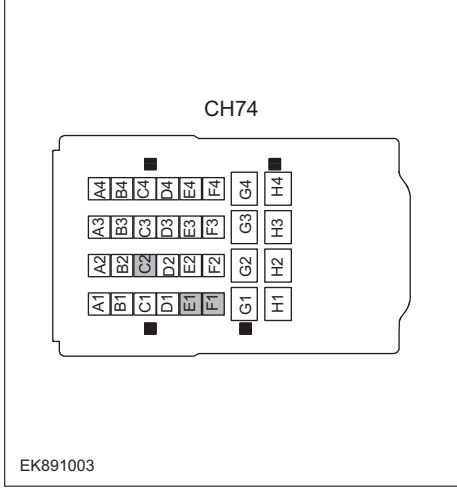
<p>Step 4</p>	<p>Check the power voltage of PEU battery.</p>
 <p>CH74</p> <p>EK891002</p>	<ol style="list-style-type: none"> 1 Turn the ignition switch to OFF. 2 Disconnect the harness plug CH74 of PEU. 3 Measure the voltage between the harness terminal of PEU and ground. Measuring circuit: voltage between terminal E1 on plug CH74 and ground. Measuring circuit: voltage between terminal F1 on plug CH74 and ground. Standard value:10~14V 4 Check whether the result is normal or not?
<p>NO → Repair the circuit.</p>	
<p>YES ↓</p>	
<p>Step 5</p>	<p>Check the power voltage when the PEU is started or operating</p>
 <p>CH74</p> <p>EK891003</p>	<ol style="list-style-type: none"> 1 Turn the ignition switch to ON. 2 Measure the voltage between the harness terminal of PEU and ground. Measuring circuit: voltage between terminal E1 on plug CH74 and ground. Measuring circuit: voltage between terminal F1 on plug CH74 and ground. Measuring circuit: voltage between terminal C2 on plug CH74 and ground. Standard value:10~14V 3 Check whether the result is normal or not?
<p>NO → Repair the circuit.</p>	
<p>YES ↓</p>	

PEU

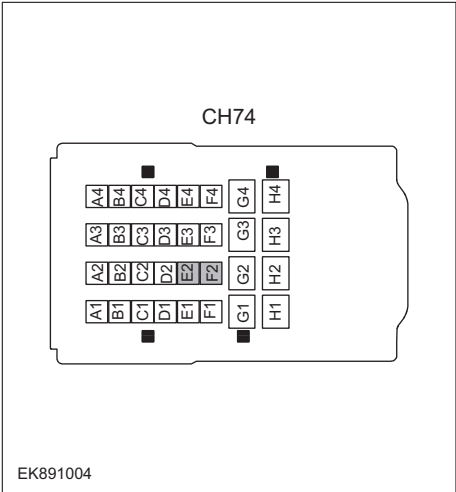
Step 6	Test whether the grounding circuit of PEU is open.
	<ol style="list-style-type: none"> 1 Turn the ignition switch to OFF. 2 Disconnect the harness plug CH74 of PEU. 3 Measure the resistance between the harness terminal of PEU and ground. Measuring circuit: resistance between terminal E2 on plug CH74 and ground. Measuring circuit: resistance between terminal F2 on plug CH74 and ground. Standard value: < 1Ω 4 Test whether the resistance is less than 1Ω?
NO → Repair the circuit.	
YES ↓	
Step 7	Test whether PEU is norm.
	<ol style="list-style-type: none"> 1 Turn the ignition switch to OFF. 2 Disconnect and check the harness plug CH74 of PEU. 3 Check and repair. <ul style="list-style-type: none"> • Corrosion(install new adapting piece or terminal-cleaning module and pin). • Pin damaged or bent-install new terminal/pin. • Fly out of pins-install new pins as needed. 4 Reconnect the PEU plug and all other previously disconnected plug. Make sure the pin is properly positioned and fixed. 5 Run the system and determine if the problem persists?
YES → Replace the PEU.	
NO ↓	
At this point the system is functioning normally. The problem may be caused by module connections. Address the root cause of any connector or pin problems.	
Next Step ↓	
Diagnosis end.	

P0A3C-F0

Fault diagnosis code
P0A3C-F0: Drive overtemperature
Detection tools
1 Multimeter and diagnostic apparatus
Possible causes
<ul style="list-style-type: none"> • Circuit, terminal and adapting piece fault • Cooling system fault • PEU internal circuit fault
Conditions for fault code operation
Turn the ignition switch to ON position.
Conditions for fault code setting
P0A3C-F0
Driver temperature is greater than the threshold (135°C)
To set the effect of a fault code condition
Shutdown, no AC output

Troubleshooting procedures	
Step 1	General inspection.
	<ol style="list-style-type: none"> 1 Check the fuse for damage. 2 Check battery capacity. 3 Check the harness plug of PEU for damage, poor contact, aging and looseness. 4 Check whether the result is normal or not?
	NO → Repair or replace the faulted parts.
YES ↓	
Step 2	Check fault codes.
	<ol style="list-style-type: none"> 1 Connect the fault diagnosis instrument to the diagnosis interface. 2 Turn the ignition switch to ON position. 3 Diagnose the PEU with diagnostic apparatus. 4 Is there any other fault code except for P0A3C-F0?
	YES → Refer to: DTC Summary list(PEU) .
NO ↓	
Step 3	Check cooling system.
	<ol style="list-style-type: none"> 1 Check whether there is leakage or poor heat dissipation in the cooling system. 2 Check whether the result is normal or not?
	NO → Repair the cooling system.
YES ↓	
Step 4	Check the connecting cable of PEU.
	<ol style="list-style-type: none"> 1 Turn the ignition switch to OFF. 2 Make protective preparations according to the safety operation specifications of the high voltage voltage in the maintenance manual. 3 Disconnect the harness plug battery pack high voltage. 4 Disconnect the high voltage harness plug of PEU. 5 Check whether the PEU connection cable is rotten, damaged, and water enters. 6 Check whether the result is normal or not?
	NO → Repair or replace the faulted parts.
YES ↓	
Step 5	Perform initialization.

	<ol style="list-style-type: none"> 1 Turn the ignition switch to OFF. 2 Connect the fault diagnosis instrument to the diagnosis interface. 3 Turn the ignition switch to ON. 4 The governor was initialized with the diagnostic instrument. 5 Can the governor be initialized and is the governor restored?
	NO → Repair or change the governor.
YES ↓	
Step 6	Check PEU internal circuit.
	<ol style="list-style-type: none"> 1 Turn the ignition switch to OFF. 2 Make protective preparations according to the safety operation specifications of the high voltage voltage in the maintenance manual. 3 Open the PEU end cover. 4 Check the PEU internal circuit and components for obvious damage or . ablation. 5 Check whether the result is normal or not?
	NO → Repair or replace the faulted parts.
YES ↓	
Step 7	Test whether PEU is norm.
	<ol style="list-style-type: none"> 1 Turn the ignition switch to OFF. 2 Disconnect and check the harness plug of PEU. 3 Check and repair: <ul style="list-style-type: none"> • Corrosion(install new adapting piece or terminal-cleaning module and pin). • Pin damaged or bent-install new terminal/pin. 4 Fly out of pins-install new pins as needed. 5 Reconnect the PEU plug and all other previously disconnected plug. Make sure the pin is properly positioned and fixed. 6 Run the system and determine if the problem persists?
	YES → Change the PEU Module
NO ↓	
At this point the system is functioning normally. The problem may be caused by module connections. Address the root cause of any connector or pin problems.	
Next Step ↓	
Diagnosis end.	

PEU

P0A2F-98

Fault diagnosis code
P0A2F-98: Motor overtemperature
Detection tools
1 Multimeter and diagnostic apparatus
Possible causes
<ul style="list-style-type: none">• Circuit,terminal and adapting piece fault• Cooling system fault• The winding temperature circuit of PEU fault
Conditions for fault code operation
Turn the ignition switch to ON position.
Conditions for fault code setting
P0A2F-98
The motor temperature value is greater than the threshold (170 °C)
To set the effect of a fault code condition
Shutdown, no AC output

Troubleshooting procedures	
Step 1	General inspection.
	<ol style="list-style-type: none"> 1 Check the fuse for damage. 2 Check battery capacity. 3 Check the harness plug of PEU for damage, poor contact, aging and looseness. 4 Check whether the result is normal or not?
	NO → Repair or replace the faulted parts.
YES ↓	
Step 2	Check fault codes.
	<ol style="list-style-type: none"> 1 Connect the fault diagnosis instrument to the diagnosis interface. 2 Turn the ignition switch to ON position. 3 Diagnose the PEU with diagnostic apparatus. 4 Is there any other fault code except for P0A2F-98?
	YES → Refer to: DTC Summary list(PEU) .
NO ↓	
Step 3	Check cooling system.
	<ol style="list-style-type: none"> 1 Check whether there is leakage or poor heat dissipation in the cooling system. 2 Check whether the result is normal or not?
	NO → Repair the cooling system.
YES ↓	
Step 4	Check the connecting cable of PEU.
	<ol style="list-style-type: none"> 1 Turn the ignition switch to OFF. 2 Make protective preparations according to the safety operation specifications of the high voltage voltage in the maintenance manual. 3 Disconnect the harness plug battery pack high voltage. 4 Disconnect the high voltage harness plug of PEU. 5 Check whether the PEU connection cable is rotten, damaged, and water enters. 6 Check whether the result is normal or not?
	NO → Repair or replace the faulted parts.
YES ↓	
Step 5	Perform initialization.

PEU

		<ol style="list-style-type: none"> 1 Turn the ignition switch to OFF. 2 Connect the fault diagnosis instrument to the diagnosis interface. 3 Turn the ignition switch to ON. 4 The governor was initialized with the diagnostic instrument. 5 Can the governor be initialized and is the governor restored?
		NO → Repair or change the governor.
YES ↓		
Step 6	Check PEU internal circuit.	
		<ol style="list-style-type: none"> 1 Turn the ignition switch to OFF. 2 Make protective preparations according to the safety operation specifications of the high voltage voltage in the maintenance manual. 3 Open the PEU end cover. 4 Check the PEU internal circuit and components for obvious damage or . ablation. 5 Check whether the result is normal or not?
		NO → Repair or replace the faulted parts.
YES ↓		
Step 7	Test whether PEU is norm.	
		<ol style="list-style-type: none"> 1 Turn the ignition switch to OFF. 2 Disconnect and check the harness plug of PEU. 3 Check and repair: <ul style="list-style-type: none"> • Corrosion(install new adapting piece or terminal-cleaning module and pin). • Pin damaged or bent-install new terminal/pin. 4 Fly out of pins-install new pins as needed. 5 Reconnect the PEU plug and all other previously disconnected plug. Make sure the pin is properly positioned and fixed. 6 Run the system and determine if the problem persists?
		YES → Change the PEU Module
NO ↓		
At this point the system is functioning normally. The problem may be caused by module connections. Address the root cause of any connector or pin problems.		
Next Step ↓		
Diagnosis end.		

U0073-88、 U0293-87、 U0111-87

Fault diagnosis code
U0073-88: CAN BusOff
U0293-87: VCU communication abnormality
U0111-87: BMS communication abnormality
Detection tools
1 Multimeter and diagnostic apparatus
Possible causes
<ul style="list-style-type: none"> • Circuit,terminal and adapting piece fault • PEU Module
Conditions for fault code operation
Turn the ignition switch to ON position.
Conditions for fault code setting
U0073-88
Power CAN busoff state detected
U0293-87
Power CAN triggers when any received frame times out (10 times the communication cycle) or the frame length is wrong
U0111-87
Power CAN triggers when any received frame times out (10 times the communication cycle) or the frame length is wrong
To set the effect of a fault code condition
Derating operation
Description of circuit diagram
The device is connected to serial data circuit, which is used to monitor the communication situation of serial data during normal operation of vehicle. The devices will exchange the operation information and commands mutually. The device has programming information required to be exchanged on the serial data circuit. The receiver device will also monitor such information; in addition, there are some regular information indication transmitter devices available.

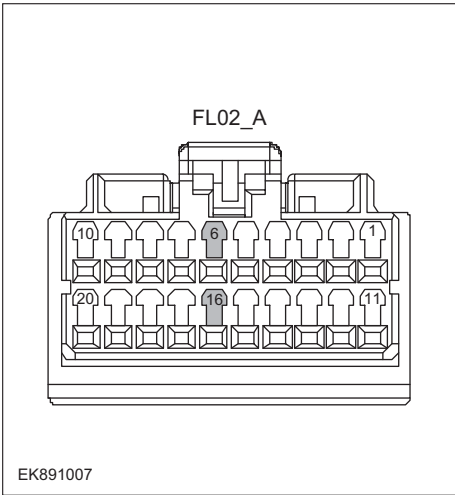
Troubleshooting procedures	
Step 1	General inspection.
	<ol style="list-style-type: none"> 1 Check the fuse for damage. 2 Check battery capacity. 3 Check the harness plug of PEU for damage, poor contact, aging and looseness. 4 Check whether the result is normal or not?
	NO → Repair or replace the faulted parts.
YES ↓	
Step 2	Check fault codes.
	<ol style="list-style-type: none"> 1 Connect the fault diagnosis instrument to the diagnosis interface. 2 Turn the ignition switch to ON position. 3 Diagnose the PEU with diagnostic apparatus. 4 Is there any other fault code except for U0073-88、U0293-87、U0111-87?
	YES → Refer to: DTC Summary list(PEU) .
NO ↓	
Step 4	Check the terminating resistance of GAW module.
 <p style="text-align: center;">FL02_A</p> <p style="text-align: left;">EK891007</p>	<ol style="list-style-type: none"> 1 Turn the ignition switch to OFF. 2 Disconnect the harness plug EB66 of VCU module. 3 Disconnect the harness plug FL02_A of network gateway module. 4 Measure the resistance between harness terminals on GAW module. Measuring circuit: the resistance between terminal 6 and 16 on plug FL02_A. Standard value: 110~130Ω 5 Check whether the result is normal or not?
	NO → Repair or replace the faulted parts.
YES ↓	

PEU

Step 5	Test whether PEU is norm.
	<ol style="list-style-type: none">1 Turn the ignition switch to OFF.2 Disconnect and check the harness plug of PEU.3 Check and repair:<ul style="list-style-type: none">• Corrosion(install new adapting piece or terminal-cleaning module and pin).• Pin damaged or bent-install new terminal/pin.4 Fly out of pins-install new pins as needed.5 Reconnect the PEU plug and all other previously disconnected plug. Make sure the pin is properly positioned and fixed.6 Run the system and determine if the problem persists?
	YES → Change the PEU Module
NO ↓	
At this point the system is functioning normally. The problem may be caused by module connections. Address the root cause of any connector or pin problems.	
Next Step ↓	
Diagnosis end.	

P0BFD-00

Fault diagnosis code
P0BFD-00: Output unbalanced
Detection tools
1 Multimeter and diagnostic apparatus
Possible causes
<ul style="list-style-type: none"> • Circuit, terminal and adapting piece fault • PEU fault • High voltage insulation fault • The current circuit of PEU fault
Conditions for fault code operation
Turn the ignition switch to ON position.
Conditions for fault code setting
P0BFD-00
When the IGBT is working, it is detected that the sum of the three-phase current exceeds the threshold value, the threshold value is equal to 10% of the given amplitude of the current, and the minimum value of the threshold value is 70A.
To set the effect of a fault code condition
Severe power reduction

Troubleshooting procedures	
Step 1	General inspection.
	<ol style="list-style-type: none"> 1 Check the fuse for damage. 2 Check battery capacity. 3 Check the harness plug of PEU for damage, poor contact, aging and looseness. 4 Check whether the result is normal or not?
	NO → Repair or replace the faulted parts.
YES ↓	
Step 2	Check fault codes.
	<ol style="list-style-type: none"> 1 Connect the fault diagnosis instrument to the diagnosis interface. 2 Turn the ignition switch to ON position. 3 Diagnose the PEU with diagnostic apparatus. 4 Is there any other fault code except for P0BFD-00?
	YES → Refer to: DTC Summary list(PEU) .
NO ↓	
Step 3	Check the connecting cable of PEU.
	<ol style="list-style-type: none"> 1 Turn the ignition switch to OFF. 2 Make protective preparations according to the safety operation specifications of the high voltage voltage in the maintenance manual. 3 Disconnect the harness plug battery pack high voltage. 4 Disconnect the high voltage harness plug of PEU. 5 Check whether the PEU connection cable is rotten, damaged, and water enters. 6 Check whether the result is normal or not?
	NO → Repair or replace the faulted parts.
YES ↓	
Step 4	Check the insulation of PEU.
	<ol style="list-style-type: none"> 1 Use a megohm meter to check the insulation resistance of the PEU housing and grounding according to the procedure in the maintenance manual. Standard value: >20MΩ 2 Check whether the result is normal or not?
	NO → Repair or replace the faulted parts.
YES ↓	
Step 5	Check the insulation of driving motor.

	<ol style="list-style-type: none"> 1 Use a megohm meter to check the insulation resistance of the driving motor housing and grounding according to the procedure in the maintenance manual. <p>Standard value: >20MΩ</p> <ol style="list-style-type: none"> 2 Check whether the result is normal or not?
	NO → Repair or replace the faulted parts.
YES ↓	
Step 6	Perform initialization.
	<ol style="list-style-type: none"> 1 Turn the ignition switch to OFF. 2 Connect the fault diagnosis instrument to the diagnosis interface. 3 Turn the ignition switch to ON. 4 The governor was initialized with the diagnostic instrument. 5 Can the governor be initialized and is the governor restored?
	NO → Repair or change the governor.
YES ↓	
Step 7	Check PEU internal circuit.
	<ol style="list-style-type: none"> 1 Turn the ignition switch to OFF. 2 Make protective preparations according to the safety operation specifications of the high voltage voltage in the maintenance manual. 3 Open the PEU end cover. 4 Check the PEU internal circuit and components for obvious damage or . ablation. 5 Check whether the result is normal or not?
	NO → Repair or replace the faulted parts.
YES ↓	

PEU

Step 8	Test whether PEU is norm.
	<ol style="list-style-type: none">1 Turn the ignition switch to OFF.2 Disconnect and check the harness plug of PEU.3 Check and repair:<ul style="list-style-type: none">• Corrosion(install new adapting piece or terminal-cleaning module and pin).• Pin damaged or bent-install new terminal/pin.4 Fly out of pins-install new pins as needed.5 Reconnect the PEU plug and all other previously disconnected plug. Make sure the pin is properly positioned and fixed.6 Run the system and determine if the problem persists?
	YES → Change the PEU Module
NO ↓	
At this point the system is functioning normally. The problem may be caused by module connections. Address the root cause of any connector or pin problems.	
Next Step ↓	
Diagnosis end.	

P0BE6-1C

Fault diagnosis code
P0BE6-1C: Abnormal current sensor
Detection tools
1 Multimeter and diagnostic apparatus
Possible causes
<ul style="list-style-type: none">• Circuit, terminal and adapting piece fault• PEU fault• High voltage insulation fault• The monitoring current circuit of PEU fault
Conditions for fault code operation
Turn the ignition switch to ON position.
Conditions for fault code setting
P0BE6-1C
To set the effect of a fault code condition

PEU

Troubleshooting steps	
Step 1	General inspection.
	<ol style="list-style-type: none"> 1 Check the fuse for damage. 2 Check battery capacity. 3 Check the harness plug of PEU for damage, poor contact, aging and looseness. 4 Check whether the result is normal or not?
	NO → Repair or replace the faulted parts.
YES ↓	
Step 2	Check fault codes.
	<ol style="list-style-type: none"> 1 Connect the fault diagnosis instrument to the diagnosis interface. 2 Turn the ignition switch to ON position. 3 Diagnose the PEU with diagnostic apparatus. 4 Is there any other fault code except for P0BE6-1C?
	YES → Refer to: DTC Summary list(PEU) .
NO ↓	
Step 3	Check the connecting cable of PEU.
	<ol style="list-style-type: none"> 1 Turn the ignition switch to OFF. 2 Make protective preparations according to the safety operation specifications of the high voltage voltage in the maintenance manual. 3 Disconnect the harness plug battery pack high voltage. 4 Disconnect the high voltage harness plug of PEU. 5 Check whether the PEU connection cable is rotten, damaged, and water enters. 6 Check whether the result is normal or not?
	NO → Repair or replace the faulted parts.
YES ↓	
Step 4	Check the insulation of PEU.
	<ol style="list-style-type: none"> 1 Use a megohm meter to check the insulation resistance of the PEU housing and grounding according to the procedure in the maintenance manual. Standard value: >20MΩ 2 Check whether the result is normal or not?
	NO → Repair or replace the faulted parts.
YES ↓	
Step 5	Check the insulation of driving motor.

	<ol style="list-style-type: none"> 1 Use a megohm meter to check the insulation resistance of the driving motor housing and grounding according to the procedure in the maintenance manual. Standard value: >20MΩ 2 Check whether the result is normal or not?
	NO → Repair or replace the faulted parts.
YES ↓	
Step 6	Perform initialization.
	<ol style="list-style-type: none"> 1 Turn the ignition switch to OFF. 2 Connect the fault diagnosis instrument to the diagnosis interface. 3 Turn the ignition switch to ON. 4 The governor was initialized with the diagnostic instrument. 5 Can the governor be initialized and is the governor restored?
	NO → Repair or change the governor.
YES ↓	
Step 7	Check PEU internal circuit.
	<ol style="list-style-type: none"> 1 Turn the ignition switch to OFF. 2 Make protective preparations according to the safety operation specifications of the high voltage voltage in the maintenance manual. 3 Open the PEU end cover. 4 Check the PEU internal circuit and components for obvious damage or . ablation. 5 Check whether the result is normal or not?
	NO → Repair or replace the faulted parts.
YES ↓	

PEU

Step 8	Test whether PEU is norm.
	<ol style="list-style-type: none">1 Turn the ignition switch to OFF.2 Disconnect and check the harness plug CH74 of PEU.3 Check and repair.<ul style="list-style-type: none">• Corrosion(install new adapting piece or terminal-cleaning module and pin).• Pin damaged or bent-install new terminal/pin.4 Fly out of pins-install new pins as needed.5 Reconnect the PEU plug and all other previously disconnected plug. Make sure the pin is properly positioned and fixed.6 Run the system and determine if the problem persists?
	YES → Change the PEU Module
NO ↓	
At this point the system is functioning normally. The problem may be caused by module connections. Address the root cause of any connector or pin problems.	
Next Step ↓	
Diagnosis end.	

P0AEE-1C、 P0A2B-1C、 P0A2F-F0、 P0AEE-F0

Fault diagnosis code
P0AEE-1C: The drive temperature sensor is abnormal
P0A2B-1C: Motor temperature sensor failure
P0A2F-F0: Motor over temperature derating
P0AEE-F0: Driver Overtemperature Derating
Detection tools
1 Multimeter and diagnostic apparatus
Possible causes
<ul style="list-style-type: none"> • Circuit, terminal and adapting piece fault • Cooling system fault • The winding temperature circuit of PEU fault
Conditions for fault code operation
Turn the ignition switch to ON position.
Conditions for fault code setting
P0AEE-1C
The collected value of the motor temperature is not within the reasonable range ($-\infty$, -50] U [200, $+\infty$)
P0A2B-1C
P0A2F-F0
P0AEE-F0
To set the effect of a fault code condition
Shutdown, no AC output

Troubleshooting procedures	
Step 1	General inspection.
	<ol style="list-style-type: none"> 1 Check the fuse for damage. 2 Check battery capacity. 3 Check the harness plug of PEU for damage, poor contact, aging and looseness. 4 Check whether the result is normal or not?
	NO → Repair or replace the faulted parts.
YES ↓	
Step 2	Check fault codes.
	<ol style="list-style-type: none"> 1 Connect the fault diagnosis instrument to the diagnosis interface. 2 Turn the ignition switch to ON position. 3 Diagnose the PEU with diagnostic apparatus. 4 Is there any other fault code except for P0AEE-1C、P0A2B-1C、P0A2F-F0、P0AEE-F0?
	YES → Refer to: DTC Summary list(PEU) .
NO ↓	
Step 3	Check cooling system.
	<ol style="list-style-type: none"> 1 Check whether there is leakage or poor heat dissipation in the cooling system. 2 Check whether the result is normal or not?
	NO → Repair the cooling system.
YES ↓	
Step 4	Check the connecting cable of PEU.
	<ol style="list-style-type: none"> 1 Turn the ignition switch to OFF. 2 Make protective preparations according to the safety operation specifications of the high voltage voltage in the maintenance manual. 3 Disconnect the harness plug battery pack high voltage. 4 Disconnect the high voltage harness plug of PEU. 5 Check whether the PEU connection cable is rotten, damaged, and water enters. 6 Check whether the result is normal or not?
	NO → Repair or replace the faulted parts.
YES ↓	
Step 5	Perform initialization.

	<ol style="list-style-type: none"> 1 Turn the ignition switch to OFF. 2 Connect the fault diagnosis instrument to the diagnosis interface. 3 Turn the ignition switch to ON. 4 The governor was initialized with the diagnostic instrument. 5 Can the governor be initialized and is the governor restored?
	NO → Repair or change the governor.
YES ↓	
Step 6	Check PEU internal circuit.
	<ol style="list-style-type: none"> 1 Turn the ignition switch to OFF. 2 Make protective preparations according to the safety operation specifications of the high voltage voltage in the maintenance manual. 3 Open the PEU end cover. 4 Check the PEU internal circuit and components for obvious damage or . ablation. 5 Check whether the result is normal or not?
	NO → Repair or replace the faulted parts.
YES ↓	
Step 7	Test whether PEU is norm.
	<ol style="list-style-type: none"> 1 Turn the ignition switch to OFF. 2 Disconnect and check the harness plug of PEU. 3 Check and repair: <ul style="list-style-type: none"> • Corrosion(install new adapting piece or terminal-cleaning module and pin). • Pin damaged or bent-install new terminal/pin. 4 Fly out of pins-install new pins as needed. 5 Reconnect the PEU plug and all other previously disconnected plug. Make sure the pin is properly positioned and fixed. 6 Run the system and determine if the problem persists?
	YES → Change the PEU Module
NO ↓	
At this point the system is functioning normally. The problem may be caused by module connections. Address the root cause of any connector or pin problems.	
Next Step ↓	
Diagnosis end.	

P0D2E-1C

Fault diagnosis code
P0D2E-1C: VDC detection error
Detection tools
1 Multimeter and diagnostic apparatus
Possible causes
<ul style="list-style-type: none">• Circuit, terminal and adapting piece fault• PEU fault• High voltage insulation fault• The current circuit of PEU fault
Conditions for fault code operation
Turn the ignition switch to ON position.
Conditions for fault code setting
P0D2E-1C
The deviation of the sampling value of the two-way bus voltage exceeds 40V, the two-way circuit samples, and the U-phase and V-phase two-way resistors divide the voltage and pass through the optocoupler
To set the effect of a fault code condition
Alarm prompt

Troubleshooting procedures	
Step 1	General inspection.
	<ol style="list-style-type: none"> 1 Check the fuse for damage. 2 Check battery capacity. 3 Check the harness plug of PEU for damage, poor contact, aging and looseness. 4 Check whether the result is normal or not?
	NO → Repair or replace the faulted parts.
YES ↓	
Step 2	Check fault codes.
	<ol style="list-style-type: none"> 1 Connect the fault diagnosis instrument to the diagnosis interface. 2 Turn the ignition switch to ON position. 3 Diagnose the PEU with diagnostic apparatus. 4 Is there any other fault code except for P0D2E-1C?
	YES → Refer to: DTC Summary list(PEU) .
NO ↓	
Step 3	Check the connecting cable of PEU.
	<ol style="list-style-type: none"> 1 Turn the ignition switch to OFF. 2 Make protective preparations according to the safety operation specifications of the high voltage voltage in the maintenance manual. 3 Disconnect the harness plug battery pack high voltage. 4 Disconnect the high voltage harness plug of PEU. 5 Check whether the PEU connection cable is rotten, damaged, and water enters. 6 Check whether the result is normal or not?
	NO → Repair or replace the faulted parts.
YES ↓	
Step 4	Check the insulation of PEU.
	<ol style="list-style-type: none"> 1 Use a megohm meter to check the insulation resistance of the PEU housing and grounding according to the procedure in the maintenance manual. Standard value: >20MΩ 2 Check whether the result is normal or not?
	NO → Repair or replace the faulted parts.
YES ↓	

PEU

Step 5	Check the insulation of driving motor.	
		<ol style="list-style-type: none"> 1 Use a megohm meter to check the insulation resistance of the driving motor housing and grounding according to the procedure in the maintenance manual. <p>Standard value: >20MΩ</p> <ol style="list-style-type: none"> 2 Check whether the result is normal or not?
		NO → Repair or replace the faulted parts.
YES ↓		
Step 6	Perform initialization.	
		<ol style="list-style-type: none"> 1 Turn the ignition switch to OFF. 2 Connect the fault diagnosis instrument to the diagnosis interface. 3 Turn the ignition switch to ON. 4 The governor was initialized with the diagnostic instrument. 5 Can the governor be initialized and is the governor restored?
		NO → Repair or change the governor.
YES ↓		
Step 7	Check PEU internal circuit.	
		<ol style="list-style-type: none"> 1 Turn the ignition switch to OFF. 2 Make protective preparations according to the safety operation specifications of the high voltage voltage in the maintenance manual. 3 Open the PEU end cover. 4 Check the PEU internal circuit and components for obvious damage or . ablation. 5 Check whether the result is normal or not?
		NO → Repair or replace the faulted parts.
YES ↓		

Step 8	Test whether PEU is norm.
	<ol style="list-style-type: none"> 1 Turn the ignition switch to OFF. 2 Disconnect and check the harness plug of PEU. 3 Check and repair: <ul style="list-style-type: none"> • Corrosion(install new adapting piece or terminal-cleaning module and pin). • Pin damaged or bent-install new terminal/pin. 4 Fly out of pins-install new pins as needed. 5 Reconnect the PEU plug and all other previously disconnected plug. Make sure the pin is properly positioned and fixed. 6 Run the system and determine if the problem persists?
	YES → Change the PEU Module
NO ↓	
At this point the system is functioning normally. The problem may be caused by module connections. Address the root cause of any connector or pin problems.	
Next Step ↓	
Diagnosis end.	

P0A3F-01

Fault diagnosis code
P0A3F-01: Position sensor detection circuit failure
Detection tools
1 Multimeter and diagnostic apparatus
Possible causes
<ul style="list-style-type: none">• Circuit, terminal and adapting piece fault• PEU module fault• Driving motor fault
Conditions for fault code operation
Turn the ignition switch to ON position.
Conditions for fault code setting
P0A3F-01
The resolver chip failure is detected, and the output pin status is set
To set the effect of a fault code condition
Stop without AC output
Description of circuit diagram
Shutdown, no AC output

Circuit diagram

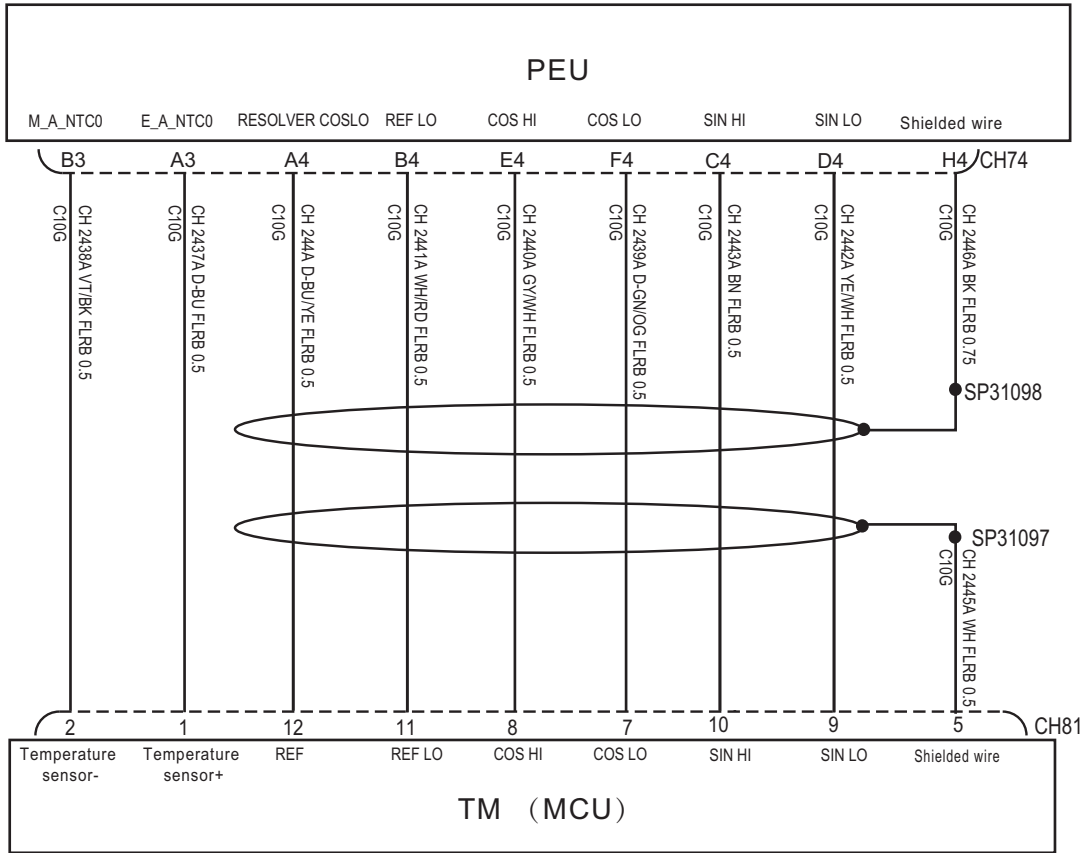

CH74

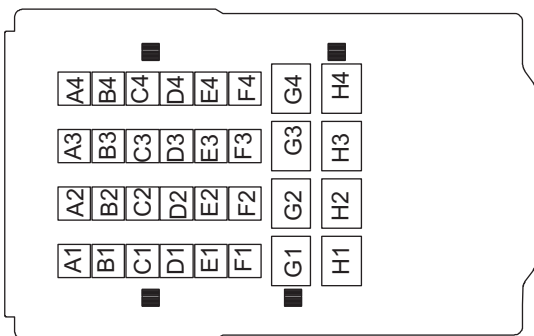

CH81

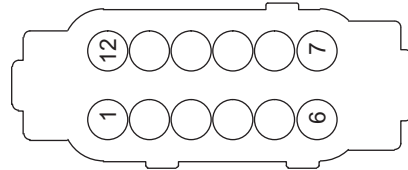

EK891008

Troubleshooting procedures		
Step 1	General inspection.	
		<ol style="list-style-type: none"> 1 Check the fuse for damage. 2 Check battery capacity. 3 Check the harness plug of driving motor, PEU for damage, poor contact, aging and looseness. 4 Check whether the result is normal or not?
		NO → Repair or replace the faulted parts.
YES ↓		
Step 2	Check fault codes.	
		<ol style="list-style-type: none"> 1 Connect the fault diagnosis instrument to the diagnosis interface. 2 Turn the ignition switch to ON position. 3 Diagnose the PEU with diagnostic apparatus. 4 If there is any fault code except for P0A3F-01?
		YES → Refer to: DTC Summary list(PEU) .
NO ↓		
Step 3	Check the connecting cable of driving motor.	
		<ol style="list-style-type: none"> 1 Turn the ignition switch to OFF. 2 Make protective preparations according to the safety operation specifications of the high voltage voltage in the maintenance manual. 3 Disconnect the harness plug battery pack high voltage. 4 Disconnect the harness plug driving motor high-voltage. 5 Check whether the driving motor connection cable is rotten, damaged, and water enters. 6 Check whether the result is normal or not?
		NO → Repair or replace the faulted parts.
YES ↓		

<p>Step 4</p>	<p>Check the circuit of driving motor (open circuit).</p>
<div style="text-align: center;"> <p>CH74</p> <p>CH81</p> <p>EK891009</p> </div>	<ol style="list-style-type: none"> 1 Turn the ignition switch to OFF. 2 Disconnect the harness plug of PEU module. 3 Disconnect the harness plug of driving motor. 4 Measure the resistance between the harness terminal of driving motor and the PEU. <ul style="list-style-type: none"> Measuring circuit: resistance between terminal 5 on plug driving motor and terminal H4 on plug PEU. Measuring circuit: resistance between terminal 7 on plug driving motor and terminal F4 on plug PEU. Measuring circuit: resistance between terminal 8 on plug driving motor and terminal E4 on plug PEU. Measuring circuit: resistance between terminal 9 on plug driving motor and terminal D4 on plug PEU. Measuring circuit: resistance between terminal 10 on plug driving motor and terminal C4 on plug PEU. Measuring circuit: resistance between terminal 11 on plug driving motor and terminal B4 on plug PEU. Measuring circuit: resistance between terminal 12 on plug driving motor and terminal A4 on plug PEU. <p>Standard value: $\approx 0\Omega$</p>
	<p>5 Check whether the result is normal or not?</p>
<p>YES ↓</p>	<p>NO → Repair or replace the faulted parts.</p>

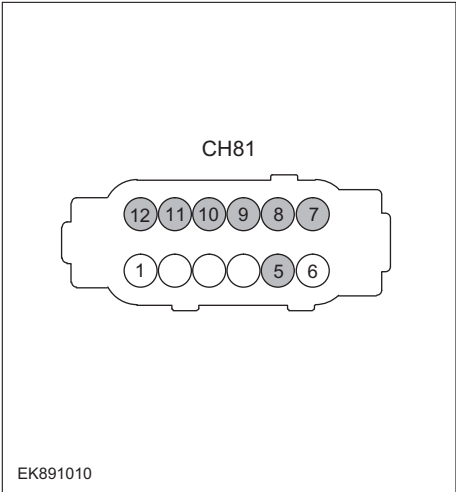
Step 5	Check the circuit of driving motor (short circuit).
<div style="text-align: center;">  <p>CH81</p> <p>EK891010</p> </div>	<ol style="list-style-type: none"> 1 Turn the ignition switch to OFF. 2 Measure the resistance between the harness plug of driving motor and ground. <ul style="list-style-type: none"> Measuring circuit: resistance between terminal 5 on plug driving motor and ground. Measuring circuit: resistance between terminal 7 on plug driving motor and ground. Measuring circuit: resistance between terminal 8 on plug driving motor and ground. Measuring circuit: resistance between terminal 9 on plug driving motor and ground. Measuring circuit: resistance between terminal 10 on plug driving motor and ground. Measuring circuit: resistance between terminal 12 on plug driving motor and ground. <p>Standard value: ∞</p> 3 Measure the voltage between the harness plug of driving motor and ground. <ul style="list-style-type: none"> Measuring circuit: voltage between terminal 5 on plug driving motor and ground. Measuring circuit: voltage between terminal 7 on plug driving motor and ground. Measuring circuit: voltage between terminal 8 on plug driving motor and ground. Measuring circuit: voltage between terminal 9 on plug driving motor and ground. Measuring circuit: voltage between terminal 10 on plug driving motor and ground. Measuring circuit: voltage between terminal 11 on plug driving motor and ground. Measuring circuit: voltage between terminal 12 on plug driving motor and ground. <p>Standard value: ≈ 0V</p> 4 Check whether the result is normal or not?
<p>NO → Repair or replace the faulted parts.</p>	
<p>YES ↓</p>	

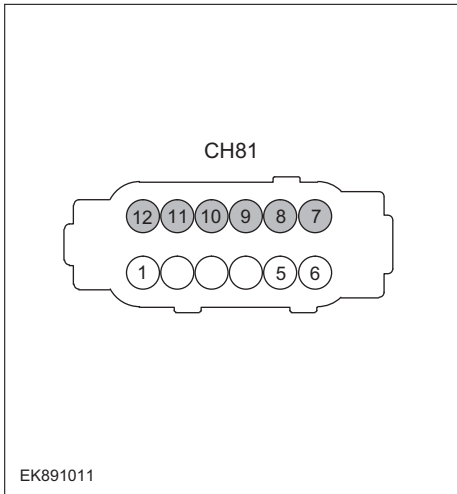
Step 6	Check the driving motor (parts).
	<ol style="list-style-type: none"> 1 Measure the SIN resistance of the driving motor resolver. Measuring circuit: resistance between terminal 9 and terminal 10 on plug driving motor. Standard value: 2 Measure the COS resistance of the driving motor resolver. Measuring circuit: resistance between terminal 7 and terminal 8 on plug driving motor. Standard value: 3 Measure the excitation resistance of the driving motor resolver. Measuring circuit: resistance between terminal 11 and terminal 12 on plug driving motor. Standard value: 4 Check whether the result is normal or not?
NO → Replace the driving motor.	
YES ↓	
Step 7	Test whether PEU is norm.
	<ol style="list-style-type: none"> 1 Turn the ignition switch to OFF. 2 Disconnect and check the harness plug of PEU. 3 Check and repair: <ul style="list-style-type: none"> • Corrosion(install new adapting piece or terminal-cleaning module and pin). • Pin damaged or bent-install new terminal/pin. • Fly out of pins-install new pins as needed. 4 Reconnect the PEU plug and all other previously disconnected plug. Make sure the pin is properly positioned and fixed. 5 Run the system and determine if the problem persists?
YES → Change the PEU Module	
NO ↓	
At this point the system is functioning normally. The problem may be caused by module connections. Address the root cause of any connector or pin problems.	
Next Step ↓	
Diagnosis end.	

PEU

P1A69-22、 P1AB4-63

Fault diagnosis code
P1A69-22: Active discharge circuit fault
P1AB4-63: Active discharge fault
Detection tools
1 Multimeter and diagnostic apparatus
Possible causes
<ul style="list-style-type: none">• Circuit,terminal and adapting piece fault• PEU module fault• High-voltage relay fault• PEU high-voltage relay circuit fault
Conditions for fault code operation
Turn the ignition switch to ON position.
Conditions for fault code setting
P1A69-22
The voltage is higher than 60V after the active discharge lasts for 3s
P1AB4-63
The voltage is higher than 60V after the active discharge lasts for 3s
To set the effect of a fault code condition
Abnormal when power off

Troubleshooting procedures	
Step 1	General inspection.
	<ol style="list-style-type: none"> 1 Check the fuse for damage. 2 Check battery capacity. 3 Check the harness plug of PEU for damage, poor contact, aging and looseness. 4 Check whether the result is normal or not?
	NO → Repair or replace the faulted parts.
YES ↓	
Step 2	Check fault codes.
	<ol style="list-style-type: none"> 1 Connect the fault diagnosis instrument to the diagnosis interface. 2 Turn the ignition switch to ON position. 3 Diagnose the PEU with diagnostic apparatus. 4 If there is any fault code except for P1A69-22、 P1AB4-63?
	YES → Refer to: DTC Summary list(PEU) .
NO ↓	
Step 3	Check BMS.
	<ol style="list-style-type: none"> 1 Turn the ignition switch to OFF. 2 Connect the fault diagnosis instrument to the diagnosis interface. 3 Turn the ignition switch to ON position. 4 Diagnose the BMS with diagnostic apparatus. 5 Test whether the faulted code is existed.
	YES → DTC diagnosis is performed based on fault codes.
NO ↓	
Step 4	Check the connecting cable of PEU.
	<ol style="list-style-type: none"> 1 Turn the ignition switch to OFF. 2 Make protective preparations according to the safety operation specifications of the high voltage voltage in the maintenance manual. 3 Disconnect the harness plug battery pack high voltage. 4 Disconnect the high voltage harness plug of PEU. 5 Check whether the PEU connection cable is rotten, damaged, and water enters. 6 Check whether the result is normal or not?

PEU

		NO → Repair or replace the faulted parts.
YES ↓		
Step 5	Perform initialization.	
	<ol style="list-style-type: none"> 1 Turn the ignition switch to OFF. 2 Connect the fault diagnosis instrument to the diagnosis interface. 3 Turn the ignition switch to ON. 4 The governor was initialized with the diagnostic instrument. 5 Can the governor be initialized and is the governor restored? 	
		NO → Repair or change the governor.
YES ↓		
Step 6	Check the insulation of PEU.	
	<ol style="list-style-type: none"> 1 Use a megohm meter to check the insulation resistance of the PEU housing and grounding according to the procedure in the maintenance manual. Standard value: >20MΩ 2 Check whether the result is normal or not? 	
		NO → Repair or replace the faulted parts.
YES ↓		
Step 7	Check the insulation of driving motor.	
	<ol style="list-style-type: none"> 1 Use a megohm meter to check the insulation resistance of the driving motor housing and grounding according to the procedure in the maintenance manual. Standard value: >20MΩ 2 Check whether the result is normal or not? 	
		NO → Repair or replace the faulted parts.
YES ↓		
Step 8	Check the high-voltage relay circuit.	
	<ol style="list-style-type: none"> 1 Turn the ignition switch to OFF. 2 Make protective preparations according to the safety operation specifications of the high voltage voltage in the maintenance manual. 3 Open the PEU end cover. 4 Check whether the high-voltage relay circuit exist the situation of open or short circuit. 5 Check whether the high-voltage relay circuit exist the situation of shorting to battery. 6 Check whether the result is normal or not? 	

		NO → Repair or replace the faulted parts.
YES ↓		
Step 9	Check the high-voltage relay monitoring module.	
	<ol style="list-style-type: none"> 1 Turn the ignition switch to OFF. 2 Make protective preparations according to the safety operation specifications of the high voltage voltage in the maintenance manual. 3 Open the PEU end cover. 4 Check the high-voltage relay monitoring module for damage. 5 Check whether the result is normal or not? 	
		NO → Repair or replace the faulted parts.
YES ↓		
Step 10	Test whether PEU is norm.	
	<ol style="list-style-type: none"> 1 Turn the ignition switch to OFF. 2 Disconnect and check the harness plug of PEU. 3 Check and repair: <ul style="list-style-type: none"> • Corrosion(install new adapting piece or terminal-cleaning module and pin). • Pin damaged or bent-install new terminal/pin. 4 Fly out of pins-install new pins as needed. 5 Reconnect the PEU plug and all other previously disconnected plug. Make sure the pin is properly positioned and fixed. 6 Run the system and determine if the problem persists? 	
		YES → Change the PEU Module
NO ↓		
At this point the system is functioning normally. The problem may be caused by module connections. Address the root cause of any connector or pin problems.		
Next Step ↓		
Diagnosis end.		

P0A3C-98

Fault diagnosis code
P0A3C-98: IGBT OC/OT fault
Detection tools
1 Multimeter and diagnostic apparatus
Possible causes
<ul style="list-style-type: none"> • Circuit, terminal and adapting piece fault • Cooling system fault • The IGBT of PEU fault
Conditions for fault code operation
Turn the ignition switch to ON position.
Conditions for fault code setting
P0A3C-98
Greater than the protection threshold 505V
To set the effect of a fault code condition
Shutdown, no AC output

Troubleshooting procedures	
Step 1	General inspection.
	<ol style="list-style-type: none"> 1 Check the fuse for damage. 2 Check battery capacity. 3 Check the harness plug of PEU for damage, poor contact, aging and looseness. 4 Check whether the result is normal or not?
	NO → Repair or replace the faulted parts.
YES ↓	
Step 2	Check fault codes.
	<ol style="list-style-type: none"> 1 Connect the fault diagnosis instrument to the diagnosis interface. 2 Turn the ignition switch to ON position. 3 Diagnose the PEU with diagnostic apparatus. 4 Is there any other fault code except for P0A3C-98?
	YES → Refer to: DTC Summary list(PEU) .
NO ↓	
Step 3	Check cooling system.
	<ol style="list-style-type: none"> 1 Check whether there is leakage or poor heat dissipation in the cooling system. 2 Check whether the result is normal or not?
	NO → Repair the cooling system.
YES ↓	
Step 4	Check the connecting cable of PEU.
	<ol style="list-style-type: none"> 1 Turn the ignition switch to OFF. 2 Make protective preparations according to the safety operation specifications of the high voltage voltage in the maintenance manual. 3 Disconnect the harness plug battery pack high voltage. 4 Disconnect the high voltage harness plug of PEU. 5 Check whether the PEU connection cable is rotten, damaged, and water enters. 6 Check whether the result is normal or not?
	NO → Repair or replace the faulted parts.
YES ↓	
Step 5	Perform initialization.

PEU

		<ol style="list-style-type: none"> 1 Turn the ignition switch to OFF. 2 Connect the fault diagnosis instrument to the diagnosis interface. 3 Turn the ignition switch to ON. 4 The governor was initialized with the diagnostic instrument. 5 Can the governor be initialized and is the governor restored?
		NO → Repair or change the governor.
YES ↓		
Step 6	Check PEU internal circuit.	
		<ol style="list-style-type: none"> 1 Turn the ignition switch to OFF. 2 Make protective preparations according to the safety operation specifications of the high voltage voltage in the maintenance manual. 3 Open the PEU end cover. 4 Check the PEU internal circuit and components for obvious damage or . ablation. 5 Check whether the result is normal or not?
		NO → Repair or replace the faulted parts.
YES ↓		
Step 7	Test whether PEU is norm.	
		<ol style="list-style-type: none"> 1 Turn the ignition switch to OFF. 2 Disconnect and check the harness plug of PEU. 3 Check and repair: <ul style="list-style-type: none"> • Corrosion(install new adapting piece or terminal-cleaning module and pin). • Pin damaged or bent-install new terminal/pin. 4 Fly out of pins-install new pins as needed. 5 Reconnect the PEU plug and all other previously disconnected plug. Make sure the pin is properly positioned and fixed. 6 Run the system and determine if the problem persists?
		YES → Change the PEU Module
NO ↓		
At this point the system is functioning normally. The problem may be caused by module connections. Address the root cause of any connector or pin problems.		
Next Step ↓		
Diagnosis end.		

P1ABF-05

Fault diagnosis code
P1ABF-05: High voltage interlock failure
Detection tools
1 Multimeter and diagnostic apparatus
Possible causes
<ul style="list-style-type: none">• Circuit, terminal and adapting piece fault• High voltage interlock circuit fault
Conditions for fault code operation
Turn the ignition switch to ON position.
Conditions for fault code setting
P1ABF-05
PEU reports a high voltage interlock fault
To set the effect of a fault code condition
High-voltage function fault

Troubleshooting steps	
Step 1	General inspection.
	<ol style="list-style-type: none"> 1 Check the fuse for damage. 2 Check battery capacity. 3 Check the harness plug of PEU for damage, poor contact, aging and looseness. 4 Check whether the result is normal or not?
	NO → Repair or replace the faulted parts.
YES ↓	
Step 2	Check fault codes.
	<ol style="list-style-type: none"> 1 Connect the fault diagnosis instrument to the diagnosis interface. 2 Turn the ignition switch to ON position. 3 Diagnose the PEU with diagnostic apparatus. 4 Is there any other fault code except for P1ABF-05?
	YES → Refer to: DTC Summary list(PEU) .
NO ↓	
Step 3	Check the driving motor high-voltage interlock circuit of PEU.
	<ol style="list-style-type: none"> 1 Turn the ignition switch to OFF. 2 Make protective preparations according to the safety operation specifications of the high voltage voltage in the maintenance manual. 3 Disconnect the harness plug battery pack high voltage. 4 Disconnect the harness plug driving motor high-voltage of PEU. 5 Check whether the PEU connection cable is rotten, damaged, and water enters. 6 Check whether the interlock circuit of PEU driving motor high-voltage exist the situation of open or short circuit. 7 Check whether the result is normal or not?
	NO → Repair or replace the faulted parts.
YES ↓	

Step 4	Check the driving motor high-voltage interlock circuit.
	<ol style="list-style-type: none"> 1 Turn the ignition switch to OFF. 2 Make protective preparations according to the safety operation specifications of the high voltage voltage in the maintenance manual. 3 Disconnect the harness plug driving motor high-voltage of PEU. 4 Disconnect the harness plug driving motor high-voltage of driving motor. 5 Check whether the driving motor high-voltage interlock circuit is open. 6 Check whether the result is normal or not?
	NO → Repair or replace the faulted parts.
YES ↓	
Step 5	Check the driving motor high-voltage cable interlock circuit.
	<ol style="list-style-type: none"> 1 Turn the ignition switch to OFF. 2 Make protective preparations according to the safety operation specifications of the high voltage voltage in the maintenance manual. 3 Disconnect the harness plug driving motor high-voltage of driving motor. 4 Check whether the interlock circuit of driving motor high-voltage cable exist the situation of open or short circuit. 5 Check whether the result is normal or not?
	NO → Repair or replace the faulted parts.
YES ↓	
At this point the system is functioning normally. The problem may be caused by module connections. Address the root cause of any connector or pin problems.	
Next Step ↓	
Diagnosis end.	

P1A7B-98

Fault diagnosis code
P1A7B-98: Single board overtemperature
Detection tools
1 Multimeter and diagnostic apparatus
Possible causes
<ul style="list-style-type: none">• Circuit,terminal and adapting piece fault• PEU internal circuit fault
Conditions for fault code operation
Turn the ignition switch to ON position.
Conditions for fault code setting
P1A7B-98
To set the effect of a fault code condition

Troubleshooting procedures	
Step 1	General inspection.
	<ol style="list-style-type: none"> 1 Check the fuse for damage. 2 Check battery capacity. 3 Check the harness plug of PEU for damage, poor contact, aging and looseness. 4 Check whether the result is normal or not?
	NO → Repair or replace the faulted parts.
YES ↓	
Step 2	Check fault codes.
	<ol style="list-style-type: none"> 1 Connect the fault diagnosis instrument to the diagnosis interface. 2 Turn the ignition switch to ON position. 3 Diagnose the PEU with diagnostic apparatus. 4 If there is any fault code except for P1A7B-98?
	YES → Refer to: DTC Summary list(PEU) .
NO ↓	
Step 3	Check the connecting cable of PEU.
	<ol style="list-style-type: none"> 1 Turn the ignition switch to OFF. 2 Make protective preparations according to the safety operation specifications of the high voltage voltage in the maintenance manual. 3 Disconnect the harness plug battery pack high voltage. 4 Disconnect the high voltage harness plug of PEU. 5 Check whether the PEU connection cable is rotten, damaged, and water enters. 6 Check whether the result is normal or not?
	NO → Repair or replace the faulted parts.
YES ↓	
Step 4	Perform initialization.
	<ol style="list-style-type: none"> 1 Turn the ignition switch to OFF. 2 Connect the fault diagnosis instrument to the diagnosis interface. 3 Turn the ignition switch to ON. 4 The governor was initialized with the diagnostic instrument. 5 Can the governor be initialized and is the governor restored?

PEU

		NO → Repair or change the governor.
YES ↓		
Step 5	Check PEU internal circuit.	
	<ol style="list-style-type: none"> 1 Turn the ignition switch to OFF. 2 Make protective preparations according to the safety operation specifications of the high voltage voltage in the maintenance manual. 3 Open the PEU end cover. 4 Check the PEU internal circuit and components for obvious damage or . ablation. 5 Check whether the result is normal or not? 	
		NO → Repair or replace the faulted parts.
YES ↓		
Step 6	Test whether PEU is norm.	
	<ol style="list-style-type: none"> 1 Turn the ignition switch to OFF. 2 Disconnect and check the harness plug of PEU. 3 Check and repair: <ul style="list-style-type: none"> • Corrosion(install new adapting piece or terminal-cleaning module and pin). • Pin damaged or bent-install new terminal/pin. 4 Fly out of pins-install new pins as needed. 5 Reconnect the PEU plug and all other previously disconnected plug. Make sure the pin is properly positioned and fixed. 6 Run the system and determine if the problem persists? 	
		YES → Change the PEU Module
NO ↓		
At this point the system is functioning normally. The problem may be caused by module connections. Address the root cause of any connector or pin problems.		
Next Step ↓		
Diagnosis end.		

P0C17-54

Fault diagnosis code
P0C17-54: Resolver offset angle calibration failed
Detection tools
1 Multimeter and diagnostic apparatus
Possible causes
<ul style="list-style-type: none"> • Circuit, terminal and adapting piece fault • PEU module fault • Driving motor fault
Conditions for fault code operation
Turn the ignition switch to ON position.
Conditions for fault code setting
P0C17-54
The resolver chip failure is detected, and the output pin status is set
To set the effect of a fault code condition
Stop without AC output
Description of circuit diagram
Shutdown, no AC output

Circuit diagram

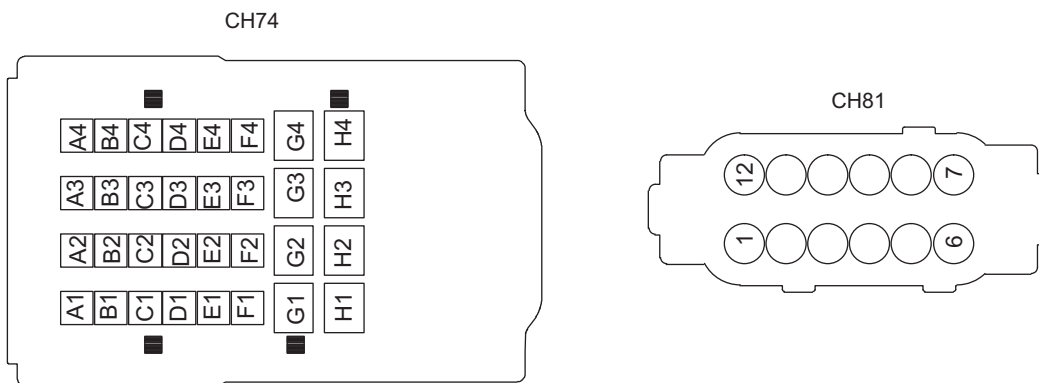
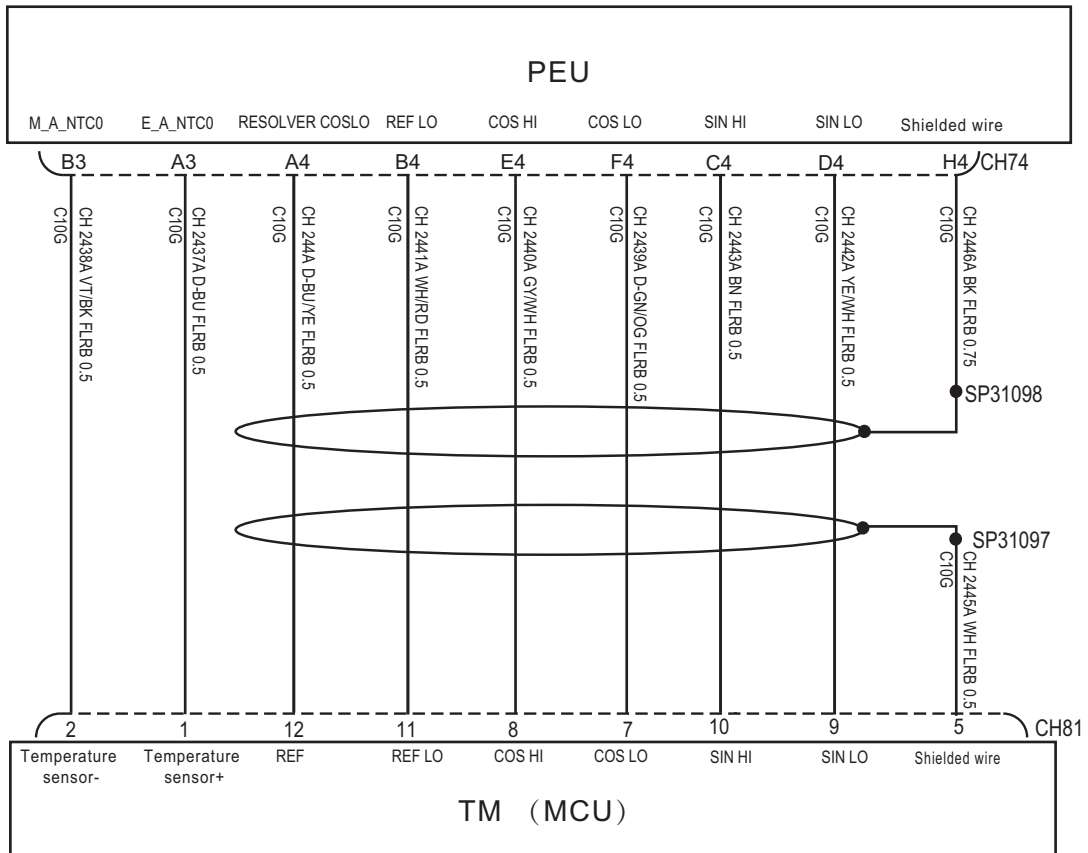

EK891008

Troubleshooting procedures	
Step 1	General inspection.
	<ol style="list-style-type: none"> 1 Check the fuse for damage. 2 Check battery capacity. 3 Check the harness plug of driving motor, PEU for damage, poor contact, aging and looseness. 4 Check whether the result is normal or not?
	NO → Repair or replace the faulted parts.
YES ↓	
Step 2	Check fault codes.
	<ol style="list-style-type: none"> 1 Connect the fault diagnosis instrument to the diagnosis interface. 2 Turn the ignition switch to ON position. 3 Diagnose the PEU with diagnostic apparatus. 4 If there is any fault code except for P0C17-54?
	YES → Refer to: DTC Summary list(PEU) .
NO ↓	
Step 3	Check the connecting cable of driving motor.
	<ol style="list-style-type: none"> 1 Turn the ignition switch to OFF. 2 Make protective preparations according to the safety operation specifications of the high voltage voltage in the maintenance manual. 3 Disconnect the harness plug battery pack high voltage. 4 Disconnect the harness plug driving motor high-voltage. 5 Check whether the driving motor connection cable is rotten, damaged, and water enters. 6 Check whether the result is normal or not?
	NO → Repair or replace the faulted parts.
YES ↓	

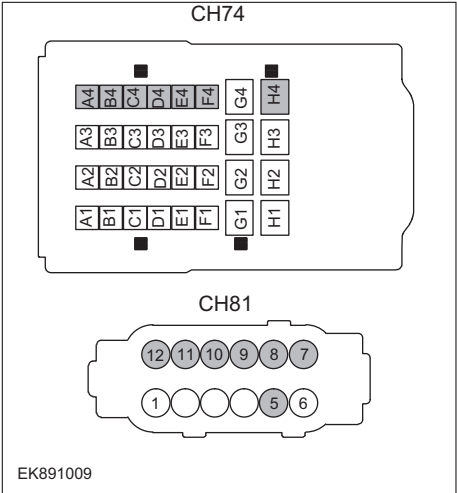
Step 4	Check the circuit of driving motor (open circuit).
	<ol style="list-style-type: none"> 1 Turn the ignition switch to OFF. 2 Disconnect the harness plug of PEU module. 3 Disconnect the harness plug of driving motor. 4 Measure the resistance between the harness terminal of driving motor and the PEU. <ul style="list-style-type: none"> Measuring circuit: resistance between terminal 5 on plug driving motor and terminal H4 on plug PEU. Measuring circuit: resistance between terminal 7 on plug driving motor and terminal F4 on plug PEU. Measuring circuit: resistance between terminal 8 on plug driving motor and terminal E4 on plug PEU. Measuring circuit: resistance between terminal 9 on plug driving motor and terminal D4 on plug PEU. Measuring circuit: resistance between terminal 10 on plug driving motor and terminal C4 on plug PEU. Measuring circuit: resistance between terminal 11 on plug driving motor and terminal B4 on plug PEU. Measuring circuit: resistance between terminal 12 on plug driving motor and terminal A4 on plug PEU. <p>Standard value: $\approx 0\Omega$</p>
	<p>5 Check whether the result is normal or not?</p> <p>NO → Repair or replace the faulted parts.</p>
<p>YES ↓</p>	

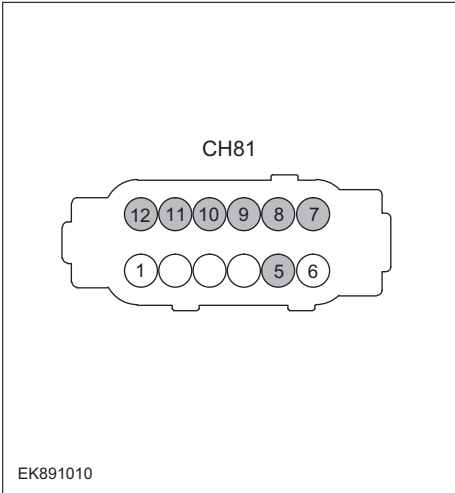
Step 5	Check the circuit of driving motor (short circuit).
<div style="text-align: center;">  <p>CH81</p> <p>EK891010</p> </div>	<ol style="list-style-type: none"> 1 Turn the ignition switch to OFF. 2 Measure the resistance between the harness plug of driving motor and ground. <ul style="list-style-type: none"> Measuring circuit: resistance between terminal 5 on plug driving motor and ground. Measuring circuit: resistance between terminal 7 on plug driving motor and ground. Measuring circuit: resistance between terminal 8 on plug driving motor and ground. Measuring circuit: resistance between terminal 9 on plug driving motor and ground. Measuring circuit: resistance between terminal 10 on plug driving motor and ground. Measuring circuit: resistance between terminal 11 on plug driving motor and ground. Measuring circuit: resistance between terminal 12 on plug driving motor and ground. <p>Standard value: ∞</p> 3 Measure the voltage between the harness plug of driving motor and ground. <ul style="list-style-type: none"> Measuring circuit: voltage between terminal 5 on plug driving motor and ground. Measuring circuit: voltage between terminal 7 on plug driving motor and ground. Measuring circuit: voltage between terminal 8 on plug driving motor and ground. Measuring circuit: voltage between terminal 9 on plug driving motor and ground. Measuring circuit: voltage between terminal 10 on plug driving motor and ground. Measuring circuit: voltage between terminal 11 on plug driving motor and ground. Measuring circuit: voltage between terminal 12 on plug driving motor and ground. <p>Standard value: ≈ 0V</p> 4 Check whether the result is normal or not?
	<p>NO → Repair or replace the faulted parts.</p>
<p>YES ↓</p>	

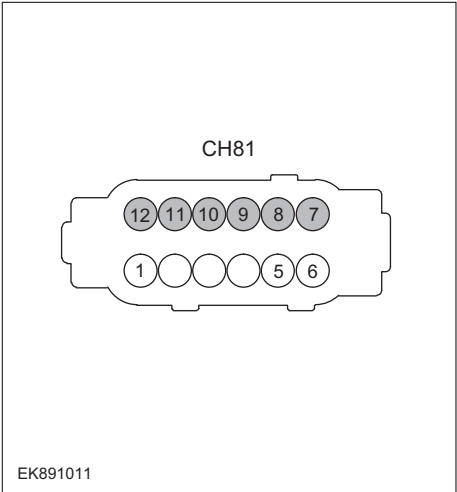
Step 6	Check the driving motor (parts).
	<ol style="list-style-type: none"> 1 Measure the SIN resistance of the driving motor resolver. Measuring circuit: resistance between terminal 9 and terminal 10 on plug driving motor. Standard value: 2 Measure the COS resistance of the driving motor resolver. Measuring circuit: resistance between terminal 7 and terminal 8 on plug driving motor. Standard value: 3 Measure the excitation resistance of the driving motor resolver. Measuring circuit: resistance between terminal 11 and terminal 12 on plug driving motor. Standard value: 4 Check whether the result is normal or not?
NO → Replace the driving motor.	
YES ↓	
Step 7	Test whether PEU is norm.
	<ol style="list-style-type: none"> 1 Turn the ignition switch to OFF. 2 Disconnect and check the harness plug of PEU. 3 Check and repair: <ul style="list-style-type: none"> • Corrosion(install new adapting piece or terminal-cleaning module and pin). • Pin damaged or bent-install new terminal/pin. • Fly out of pins-install new pins as needed. 4 Reconnect the PEU plug and all other previously disconnected plug. Make sure the pin is properly positioned and fixed. 5 Run the system and determine if the problem persists?
YES → Change the PEU Module	
NO ↓	
At this point the system is functioning normally. The problem may be caused by module connections. Address the root cause of any connector or pin problems.	
Next Step ↓	
Diagnosis end.	

P0C79-A3、 P1A60-F0

Fault diagnosis code
P0C79-A3: VDC bus overvoltage derating
P1A60-F0: VDC bus undervoltage derating
Detection tools
1 Multimeter and diagnostic apparatus
Possible causes
<ul style="list-style-type: none"> • Circuit,terminal and adapting piece fault • PEU fault • High voltage insulation fault • Bus voltage detection circuit in the PEU fault
Conditions for fault code operation
Turn the ignition switch to ON position.
Conditions for fault code setting
P0C79-A3
P1A60-F0
To set the effect of a fault code condition
Shutdown, no AC output

Troubleshooting procedures	
Step 1	General inspection.
	<ol style="list-style-type: none"> 1 Check the fuse for damage. 2 Check battery capacity. 3 Check the harness plug of PEU for damage, poor contact, aging and looseness. 4 Check whether the result is normal or not?
	NO → Repair or replace the faulted parts.
YES ↓	
Step 2	Check fault codes.
	<ol style="list-style-type: none"> 1 Connect the fault diagnosis instrument to the diagnosis interface. 2 Turn the ignition switch to ON position. 3 Diagnose the GAW module with diagnostic apparatus. 4 Is there any other fault code except for P0C79-A3, P1A60-F0?
	YES → Refer to: DTC Summary list(PEU) .
NO ↓	
Step 3	Check BMS.
	<ol style="list-style-type: none"> 1 Turn the ignition switch to OFF. 2 Connect the fault diagnosis instrument to the diagnosis interface. 3 Turn the ignition switch to ON position. 4 Diagnose the BMS with diagnostic apparatus. 5 Test whether the faulted code is existed.
	YES → DTC diagnosis is performed based on fault codes.
NO ↓	
Step 4	Check the connecting cable of PEU.
	<ol style="list-style-type: none"> 1 Turn the ignition switch to OFF. 2 Make protective preparations according to the safety operation specifications of the high voltage voltage in the maintenance manual. 3 Disconnect the harness plug battery pack high voltage. 4 Disconnect the high voltage harness plug of PEU. 5 Check whether the PEU connection cable is rotten, damaged, and water enters. 6 Check whether the result is normal or not?

		NO → Repair or replace the faulted parts.
YES ↓		
Step 5	Check the insulation of PEU.	
	1	Use a megohm meter to check the insulation resistance of the PEU housing and grounding according to the procedure in the maintenance manual. Standard value: >20MΩ
	2	Check whether the result is normal or not?
		NO → Repair or replace the faulted parts.
YES ↓		
Step 6	Check the insulation of driving motor.	
	1	Use a megohm meter to check the insulation resistance of the driving motor housing and grounding according to the procedure in the maintenance manual. Standard value: >20MΩ
	2	Check whether the result is normal or not?
		NO → Repair or replace the faulted parts.
YES ↓		
Step 7	Check the high voltage relay.	
	1	Turn the ignition switch to OFF.
	2	Make protective preparations according to the safety operation specifications of the high voltage voltage in the maintenance manual.
	3	Open the PEU end cover.
	4	Check whether the high voltage relay works.
	5	Check whether the result is normal or not?
		NO → Repair or replace the faulted parts.
YES ↓		

PEU

Step 8	Test whether PEU is norm.
	<ol style="list-style-type: none">1 Turn the ignition switch to OFF.2 Disconnect and check the harness plug of PEU.3 Check and repair:<ul style="list-style-type: none">• Corrosion(install new adapting piece or terminal-cleaning module and pin).• Pin damaged or bent-install new terminal/pin.4 Fly out of pins-install new pins as needed.5 Reconnect the PEU plug and all other previously disconnected plug. Make sure the pin is properly positioned and fixed.6 Run the system and determine if the problem persists?
	YES → Change the PEU Module
NO ↓	
At this point the system is functioning normally. The problem may be caused by module connections. Address the root cause of any connector or pin problems.	
Next Step ↓	
Diagnosis end.	

P0A44-F0、 P0A44-F1、 P1A92-F0

Fault diagnosis code
P0A44-F0: Motor forward over speed derating
P0A44-F1: Motor reverse overspeed derating
P1A92-F0: Motor overload derating
Detection tools
1 Multimeter and diagnostic apparatus
Possible causes
<ul style="list-style-type: none"> • Circuit,terminal and adapting piece fault • PEU fault • High voltage insulation fault
Conditions for fault code operation
Turn the ignition switch to ON position.
Conditions for fault code setting
P0A44-F0
P0A44-F1
P1A92-F0
To set the effect of a fault code condition
Derated operation

Troubleshooting procedures	
Step 1	General inspection.
	<ol style="list-style-type: none"> 1 Check the fuse for damage. 2 Check battery capacity. 3 Check the harness plug of PEU for damage, poor contact, aging and looseness. 4 Check whether the result is normal or not?
	NO → Repair or replace the faulted parts.
YES ↓	
Step 2	Check fault codes.
	<ol style="list-style-type: none"> 1 Connect the fault diagnosis instrument to the diagnosis interface. 2 Turn the ignition switch to ON position. 3 Diagnose the GAW module with diagnostic apparatus. 4 If there is any fault code except for P0A44-F0、 P0A44-F1、 P1A92-F0?
	YES → Refer to: DTC Summary list(PEU) .
NO ↓	
Step 3	Check BMS.
	<ol style="list-style-type: none"> 1 Turn the ignition switch to OFF. 2 Connect the fault diagnosis instrument to the diagnosis interface. 3 Turn the ignition switch to ON position. 4 Diagnose the BMS with diagnostic apparatus. 5 Test whether the faulted code is existed.
	YES → DTC diagnosis is performed based on fault codes.
NO ↓	
Step 4	Check the connecting cable of PEU.
	<ol style="list-style-type: none"> 1 Turn the ignition switch to OFF. 2 Make protective preparations according to the safety operation specifications of the high voltage voltage in the maintenance manual. 3 Disconnect the harness plug battery pack high voltage. 4 Disconnect the high voltage harness plug of PEU. 5 Check whether the PEU connection cable is rotten, damaged, and water enters. 6 Check whether the result is normal or not?

		NO → Repair or replace the faulted parts.
YES ↓		
Step 5	Check the insulation of PEU.	
	1	Use a megohm meter to check the insulation resistance of the PEU housing and grounding according to the procedure in the maintenance manual. Standard value: >20MΩ
	2	Check whether the result is normal or not?
		NO → Repair or replace the faulted parts.
YES ↓		
Step 5	Check the insulation of driving motor.	
	1	Use a megohm meter to check the insulation resistance of the driving motor housing and grounding according to the procedure in the maintenance manual. Standard value: >20MΩ
	2	Check whether the result is normal or not?
		NO → Repair or replace the faulted parts.
YES ↓		
Step 6	Check the high voltage relay.	
	1	Turn the ignition switch to OFF.
	2	Make protective preparations according to the safety operation specifications of the high voltage voltage in the maintenance manual.
	3	Open the PEU end cover.
	4	Check whether the high voltage relay works.
	5	Check whether the result is normal or not?
		NO → Repair or replace the faulted parts.
YES ↓		
Step 7	Perform initialization.	
	1	Turn the ignition switch to OFF.
	2	Connect the fault diagnosis instrument to the diagnosis interface.
	3	Turn the ignition switch to ON.
	4	The governor was initialized with the diagnostic instrument.
	5	Can the governor be initialized and is the governor restored?
		NO → Repair or change the governor.
YES ↓		

PEU

Step 8	Check PEU internal circuit.
	<ol style="list-style-type: none"> 1 Turn the ignition switch to OFF. 2 Make protective preparations according to the safety operation specifications of the high voltage voltage in the maintenance manual. 3 Open the PEU end cover. 4 Check the PEU internal circuit and components for obvious damage or . ablation. 5 Check whether the result is normal or not?
	NO → Repair or replace the faulted parts.
YES ↓	
Step 9	Test whether PEU is norm.
	<ol style="list-style-type: none"> 1 Turn the ignition switch to OFF. 2 Disconnect and check the harness plug of PEU. 3 Check and repair: <ul style="list-style-type: none"> • Corrosion(install new adapting piece or terminal-cleaning module and pin). • Pin damaged or bent-install new terminal/pin. 4 Fly out of pins-install new pins as needed. 5 Reconnect the PEU plug and all other previously disconnected plug. Make sure the pin is properly positioned and fixed. 6 Run the system and determine if the problem persists?
	YES → Change the PEU Module
NO ↓	
At this point the system is functioning normally. The problem may be caused by module connections. Address the root cause of any connector or pin problems.	
Next Step ↓	
Diagnosis end.	

P1AF0-00

Fault diagnosis code
P1AF0-00: Level 3 reset fault alarm
Detection tools
1 Multimeter and diagnostic apparatus
Possible causes
<ul style="list-style-type: none">• Circuit, terminal and adapting piece fault• PEU internal circuit fault
Conditions for fault code operation
Turn the ignition switch to ON position.
Conditions for fault code setting
P1AF0-00
To set the effect of a fault code condition

Troubleshooting procedures	
Step 1	General inspection.
	<ol style="list-style-type: none"> 1 Check the fuse for damage. 2 Check battery capacity. 3 Check the harness plug of PEU for damage, poor contact, aging and looseness. 4 Check whether the result is normal or not?
	NO → Repair or replace the faulted parts.
YES ↓	
Step 2	Check fault codes.
	<ol style="list-style-type: none"> 1 Connect the fault diagnosis instrument to the diagnosis interface. 2 Turn the ignition switch to ON position. 3 Diagnose the PEU with diagnostic apparatus. 4 If there is any fault code except for P1AF0-00?
	YES → Refer to: DTC Summary list(PEU) .
NO ↓	
Step 3	Check the connecting cable of PEU.
	<ol style="list-style-type: none"> 1 Turn the ignition switch to OFF. 2 Make protective preparations according to the safety operation specifications of the high voltage voltage in the maintenance manual. 3 Disconnect the harness plug battery pack high voltage. 4 Disconnect the high voltage harness plug of PEU. 5 Check whether the PEU connection cable is rotten, damaged, and water enters. 6 Check whether the result is normal or not?
	NO → Repair or replace the faulted parts.
YES ↓	
Step 4	Perform initialization.
	<ol style="list-style-type: none"> 1 Turn the ignition switch to OFF. 2 Connect the fault diagnosis instrument to the diagnosis interface. 3 Turn the ignition switch to ON. 4 The governor was initialized with the diagnostic instrument. 5 Can the governor be initialized and is the governor restored?

		NO → Repair or change the governor.
YES ↓		
Step 5	Check PEU internal circuit.	
	<ol style="list-style-type: none"> 1 Turn the ignition switch to OFF. 2 Make protective preparations according to the safety operation specifications of the high voltage voltage in the maintenance manual. 3 Open the PEU end cover. 4 Check the PEU internal circuit and components for obvious damage or . ablation. 5 Check whether the result is normal or not? 	
		NO → Repair or replace the faulted parts.
YES ↓		
Step 6	Test whether PEU is norm.	
	<ol style="list-style-type: none"> 1 Turn the ignition switch to OFF. 2 Disconnect and check the harness plug of PEU. 3 Check and repair: <ul style="list-style-type: none"> • Corrosion(install new adapting piece or terminal-cleaning module and pin). • Pin damaged or bent-install new terminal/pin. 4 Fly out of pins-install new pins as needed. 5 Reconnect the PEU plug and all other previously disconnected plug. Make sure the pin is properly positioned and fixed. 6 Run the system and determine if the problem persists? 	
		YES → Change the PEU Module
NO ↓		
At this point the system is functioning normally. The problem may be caused by module connections. Address the root cause of any connector or pin problems.		
Next Step ↓		
Diagnosis end.		

DTC Summary list (SRS)

DTC	English descriptions	Reference page
U0073-88	Control Module Communication Bus Off	U0073-88
U0153-87	BCM1 Node Missing	U0153-87
U0154-87	BCM2 Node Missing	U0154-87
U0155-87	ABS Node Missing	U0155-87
U0156-87	IPK Node Missing	U0156-87
U1562-17	Battery voltage is too high	U1562-17、 U1563-16
U1563-16	Battery voltage is too low	
B0001-11	Driver Frontal Airbag - Short to GND	B0001-11、 B0001-12、 B0001-1A、 B0001-1B、 B0001-56
B0001-12	Driver Frontal Airbag - Short to Battery	
B0001-1A	Driver Frontal Airbag - Resistance too Low	
B0001-1B	Driver Frontal Airbag - Resistance too High	
B0001-56	Driver Frontal Airbag - Incompatible Configuration	
B0010-11	Passenger Frontal Airbag - Short to GND	B0010-11、 B0010-12、 B0010-1A、 B0010-1B、 B0010-56
B0010-12	Passenger Frontal Airbag - Short to Battery	
B0010-1A	Passenger Frontal Airbag - Resistance too Low	
B0010-1B	Passenger Frontal Airbag- Resistance too High	
B0010-56	Passenger Frontal Airbag - Incompatible Configuration	
B0090-49	Left Front Satellite Sensor - Internal Fault	B0090-49、 B0090-87、 B0090-86、 B0091-56、
B0090-87	Left Front Satellite Sensor - Lost Communication	
B0090-86	Left Front Satellite Sensor – transmitted data invalid	
B0091-56	Left Front Satellite Sensor - Incompatible Configuration	
B0095-49	Right Side Satellite Sensor - Internal Fault	B0095-49、 B0095-87、 B0095-86、 B0095-56
B0095-87	Right Side Satellite Sensor - Lost Communication	
B0095-86	Right Side Satellite Sensor – transmitted data invalid	
B0095-56	Right Side Satellite Sensor - Incompatible Configuration	
B0091-49	Left B-Pillar Side Satellite Sensor - Internal Fault	B0091-49、 B0091-87、 B0091-86、 B0091-56
B0091-87	Left B-Pillar Side Satellite Sensor - Lost Communication	
B0091-86	Left B-Pillar Side Satellite Sensor – transmitted data invalid	
B0091-56	Left B-Pillar Side Satellite Sensor - Incompatible Configuration	
B0096-49	Righ B-Pillart Side Satellite Sensor - Internal Fault	B0096-49、 B0096-87、 B0096-86、 B0096-56
B0096-87	Right B-Pillar Side Satellite Sensor - Lost Communication	
B0096-86	Right B-Pillar Side Satellite Sensor – transmitted data invalid	
B0096-56	Right Side Satellite Sensor - Incompatible Configuration	

DTC	English descriptions	Reference page
B193A-14	Hardwired Crash Out - Shorted to Ground or Open	B193A-14 , B193A-12
B193A-12	Hardwired Crash Out - Shorted to Battery	
B0020-11	Left Hand Side Airbag -Short to GND	B0020-11 , B0020-12 , B0020-1A , B0020-1B , B0020-56
B0020-12	Left Hand Side Airbag -Short to Battery	
B0020-1A	Left Hand Side Airbag - Resistance too Low	
B0020-1B	Left Hand Side Airbag - Resistance too High	
B0020-56	Left Hand Side Airbag - Incompatible Configuration	
B0028-11	Right Hand Side Airbag -Short to GND	
B0028-12	Right Hand Side Airbag -Short to Battery	
B0028-1A	Right Hand Side Airbag - Resistance too Low	
B0028-1B	Right Hand Side Airbag - Resistance too High	
B0028-56	Right Hand Side Airbag - Incompatible Configuration	
B0021-11	Left Hand Curtain Airbag -Short to GND	B0021-11 , B0021-12 , B0021-1A , B0021-1B , B0021-56
B0021-12	Left Hand Curtain Airbag -Short to Battery	
B0021-1A	Left Hand Curtain Airbag - Resistance too Low	
B0021-1B	Left Hand Curtain Airbag - Resistance too High	
B0021-56	Left Hand Curtain Airbag - Incompatible Configuration	
B0029-11	Right Hand Curtain Airbag -Short to GND	B0029-11 , B0029-12 , B0029-1A , B0029-1B , B0029-56
B0029-12	Right Hand Curtain Airbag -Short to Battery	
B0029-1A	Right Hand Curtain Airbag - Resistance too Low	
B0029-1B	Right Hand Curtain Airbag - Resistance too High	
B0029-56	Right Hand Curtain Airbag - Incompatible Configuration	
B0050-12	Driver Buckle Switch Shorted to Battery	B0050-12
B0052-12	Passenger Buckle Switch Shorted to Battery	B0052-12
B0053-12	2nd Row Left Seat Belt buckle switch Circuit – Shorted to Battery	B0053-12
B0054-12	2nd Row Middle Seat Belt buckle switch Circuit – Shorted to Battery	B0054-12
B0055-12	2nd Row Right Seat Belt buckle switch Circuit – Shorted to Battery	B0055-12
B193E-00	Deployment Data Record Full: No over-write-able records exist	Replace SRS
B193F-49	SDM Internal Faults -- Power	B193F-49 , B193F-09 , B193F-96 , B193F-00 , B193F-00
B193F-09	SDM Internal Faults -- Acceleration Sensors	
B193F-96	SDM Internal Faults--Firing Circuit	
B193F-00	SDM Internal Faults -- Control Function Block	
B193C-56	System Configuration Mismatch	Clear the fault code, re-test DTC, and replace SRS if the fault code exists.
B1932-00	Frontal Deployment Data Record exist	Replace SRS

DTC	English descriptions	Reference page
B1933-00	Side Deployment Data Record exist	Replace SRS
B1934-00	Rear Deployment Data Record exist	Replace SRS
B1924-00	Front impact sensor configuration mismatch with CAL parameter	Clear the fault code, re-test the DTC, and if the fault code exists, replace it with a new front impact sensor.
B1941-00	deployed loops exits by SVD function	Clear the fault code, re-test DTC, and replace SRS if the fault code exists.

U0073-88

Fault diagnosis code
U0073-88: Control Module Communication Bus Off
Detection tools
1 Multimeter and diagnostic apparatus
Possible causes
<ul style="list-style-type: none">• Circuit,terminal and adapting piece fault• SRS• CAN• Terminal resistance fault
Conditions for fault code operation
Turn the ignition switch to the ON position
Conditions for fault code setting
U0073-88
If the supplier uses third-party software for network management (such as Mentor), the first strategy should be used for bus shutdown: if busoff_counter >= busoff_max or nwm_timer > busoff_time, please set bit 0 (test failed) of DTC status byte to 1.
To set the effect of a fault code condition
Description of circuit diagram

Circuit diagram

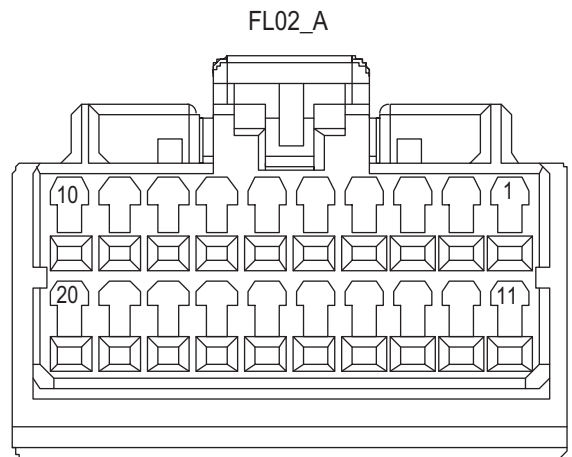
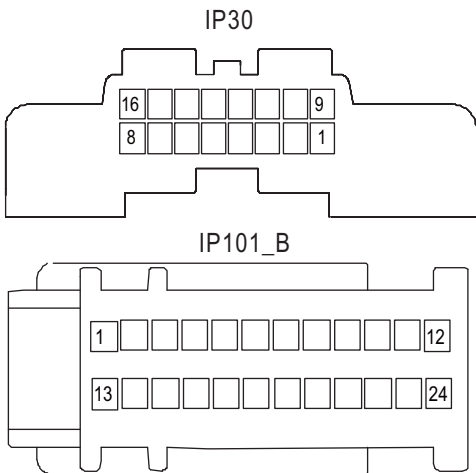
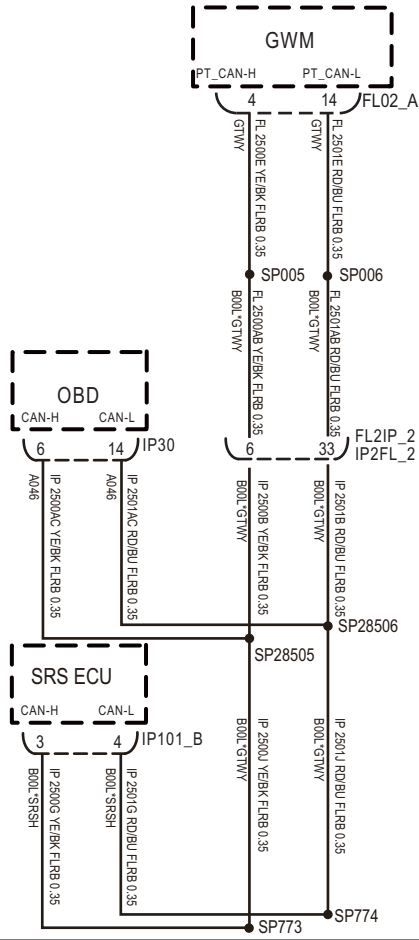

EK891301

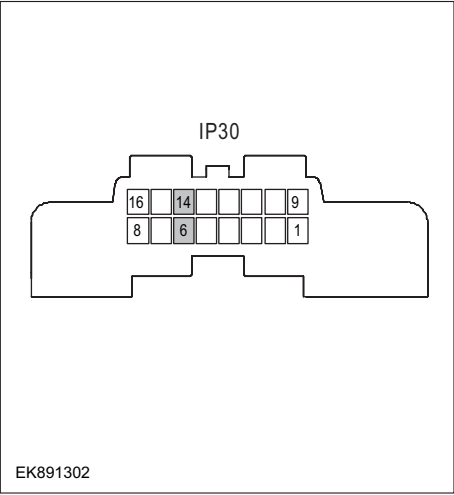
Troubleshooting steps	
Step1	General inspection.
	<ol style="list-style-type: none"> 1 Check fuse for damage. 2 Check battery capacity. 3 Check the harness plug of SRS for damage, poor contact, aging and looseness. 4 Check whether the result is normal or not?
NO → Repair or replace parts with detected faults.	
YES ↓	
Step2	Check fault codes.
	<ol style="list-style-type: none"> 1 Connect the scan tool to the diagnostic interface. 2 Turn the ignition switch to the on position. 3 Diagnose SRS module with diagnostic instrument. 4 Is there any other fault code except for U0073-88?
YES → Refer to: DTC Summary list (SRS) .	
NO ↓	
Step3	Check the integrity of CAN communication network.
	<ol style="list-style-type: none"> 1 Turn off the ignition switch. 2 Measure the resistance between diagnostic interface harness terminals. Measuring circuit: resistance between terminal 6 and terminal 14 of IP30 plug. Standard value: $\approx 60\Omega$ 3 Check whether the result is normal or not?
NO → Repair or replace parts with detected faults.	
YES ↓	

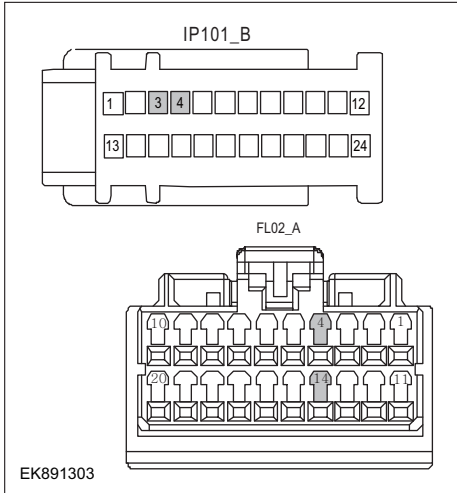
Step4	Check the resistance of gateway module and SRS terminal.
	<ol style="list-style-type: none"> 1 Turn off the ignition switch. 2 Disconnect the gateway module harness plug FL02 _ A. 3 Measure the resistance between the gateway module harness terminals. Measuring circuit: resistance between terminal 4 and terminal 14 of FL02_A plug. Standard value:110~130Ω 4 Connect the gateway module harness plug FL02 _ A. 5 Disconnect the SRS harness plug IP 101 _ B. 6 Measure the resistance between SRS harness terminals. Measuring circuit: resistance between terminal 3 and terminal 4 of IP101_B plug. Standard value:110~130Ω 7 Check whether the result is normal or not?
<p>NO → Repair or replace parts with detected faults.</p>	
<p>YES ↓</p>	
Step6	Check whether the SRS module is abnormal.
	<ol style="list-style-type: none"> 1 Turn off the ignition switch. 2 Disconnect and check the harness plug IP101_B of SRS module. 3 Inspection and maintenance: <ul style="list-style-type: none"> • Corrosion (install new connectors or terminals-clean module pins). • Damaged or bent pins-Install new terminals/pins. • Pin flying out-install new pins as needed. 4 Reconnect the SRS module plug and all other previously disconnected plugs. Make sure that the pins are properly positioned and fixed. 5 Run the system and determine if the problem still exists?
<p>YES → Replace SRS .</p>	
<p>NO ↓</p>	
<p>At this time, the system works normally. The cause of the problem may be module connection. Address the root cause of any connector or pin problem.</p>	
<p>Next Step ↓</p>	
<p>Diagnosis is over.</p>	

U0153-87

Fault diagnosis code
U0153-87: BCM1 Node Missing
Detection tools
1 Multimeter and diagnostic apparatus
Possible causes
<ul style="list-style-type: none">• Circuit,terminal and adapting piece fault• SRS• CAN• Terminal resistance fault
Conditions for fault code operation
Turn the ignition switch to the ON position
Conditions for fault code setting
U0153-87
0x281 message has not received 1 for 250ms continuously.
To set the effect of a fault code condition
Description of circuit diagram

Circuit diagram

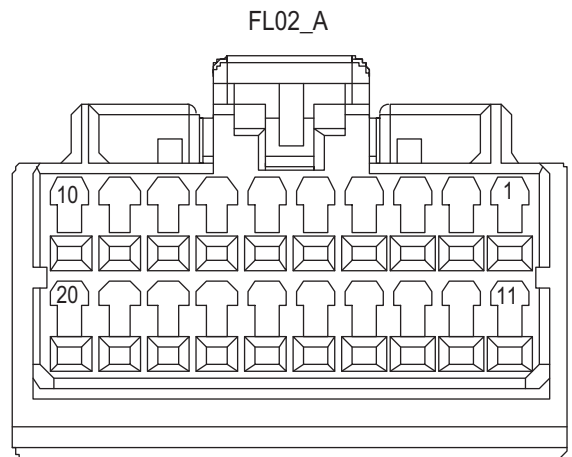
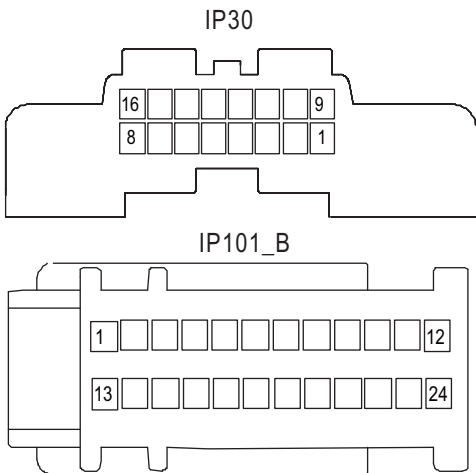
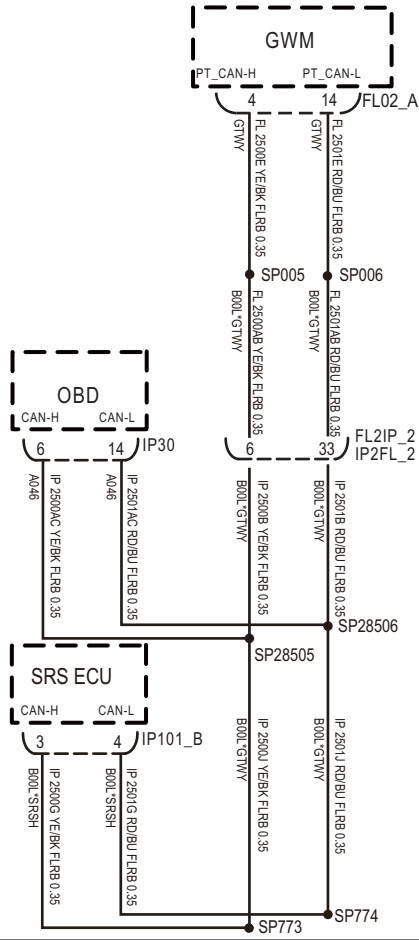

EK891301

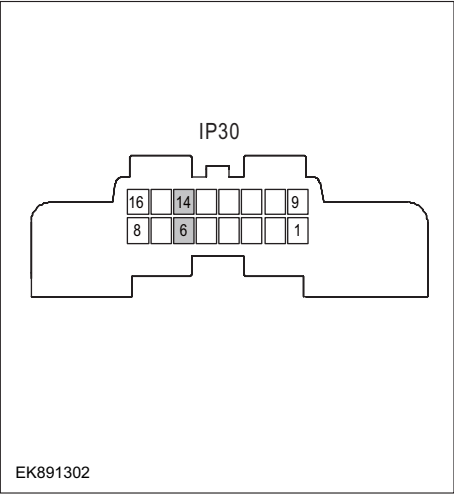
Troubleshooting steps	
Step1	General inspection.
	<ol style="list-style-type: none"> 1 Check fuse for damage. 2 Check battery capacity. 3 Check the harness plug of SRS for damage, poor contact, aging and looseness. 4 Check whether the result is normal or not?
NO → Repair or replace parts with detected faults.	
YES ↓	
Step2	Check fault codes.
	<ol style="list-style-type: none"> 1 Connect the scan tool to the diagnostic interface. 2 Turn the ignition switch to the on position. 3 Diagnose SRS module with diagnostic instrument. 4 Is there any other fault code except for U0153-87?
YES → Refer to: DTC Summary list (SRS) .	
NO ↓	
Step3	Check the integrity of CAN communication network.
 <p style="text-align: center;">IP30</p> <p style="text-align: center;">EK891302</p>	<ol style="list-style-type: none"> 1 Turn off the ignition switch. 2 Measure the resistance between diagnostic interface harness terminals. Measuring circuit: resistance between terminal 6 and terminal 14 of IP30 plug. Standard value: $\approx 60\Omega$ 3 Check whether the result is normal or not?
NO → Repair or replace parts with detected faults.	
YES ↓	

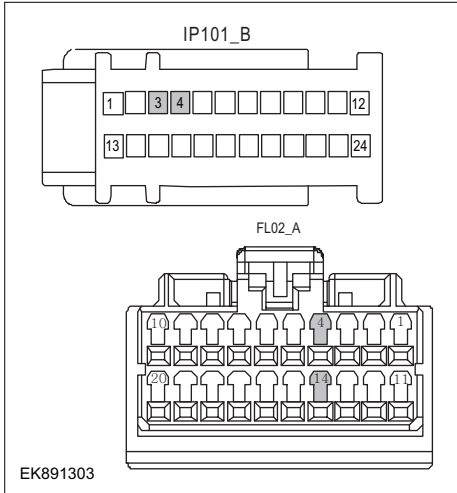
Step4	Check the resistance of gateway module and SRS terminal.
	<ol style="list-style-type: none"> 1 Turn off the ignition switch. 2 Disconnect the gateway module harness plug FL02 _ A. 3 Measure the resistance between the gateway module harness terminals. Measuring circuit: resistance between terminal 4 and terminal 14 of FL02_A plug. Standard value:110~130Ω 4 Connect the gateway module harness plug FL02 _ A. 5 Disconnect the SRS harness plug IP 101 _ B. 6 Measure the resistance between SRS harness terminals. Measuring circuit: resistance between terminal 3 and terminal 4 of IP101_B plug. Standard value:110~130Ω 7 Check whether the result is normal or not?
<p>NO → Repair or replace parts with detected faults.</p>	
<p>YES ↓</p>	
Step6	Check whether the SRS module is abnormal.
	<ol style="list-style-type: none"> 1 Turn off the ignition switch. 2 Disconnect and check the harness plug IP101_B of SRS module. 3 Inspection and maintenance: <ul style="list-style-type: none"> • Corrosion (install new connectors or terminals-clean module pins). • Damaged or bent pins-Install new terminals/pins. • Pin flying out-install new pins as needed. 4 Reconnect the SRS module plug and all other previously disconnected plugs. Make sure that the pins are properly positioned and fixed. 5 Run the system and determine if the problem still exists?
<p>YES → Replace SRS .</p>	
<p>NO ↓</p>	
<p>At this time, the system works normally. The cause of the problem may be module connection. Address the root cause of any connector or pin problem.</p>	
<p>Next Step ↓</p>	
<p>Diagnosis is over.</p>	

U0154-87

Fault diagnosis code
U0154-87: BCM2 Node Missing
Detection tools
1 Multimeter and diagnostic apparatus
Possible causes
<ul style="list-style-type: none">• Circuit,terminal and adapting piece fault• SRS• CAN• Terminal resistance fault
Conditions for fault code operation
Turn the ignition switch to the ON position
Conditions for fault code setting
U0154-87
0375 message has not been received for 2000ms continuously.
To set the effect of a fault code condition
Description of circuit diagram

Circuit diagram

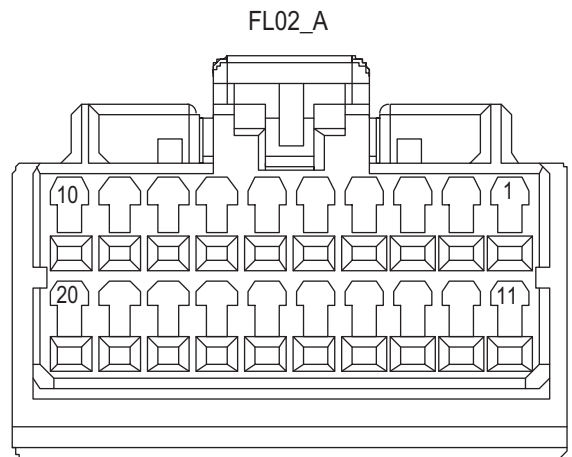
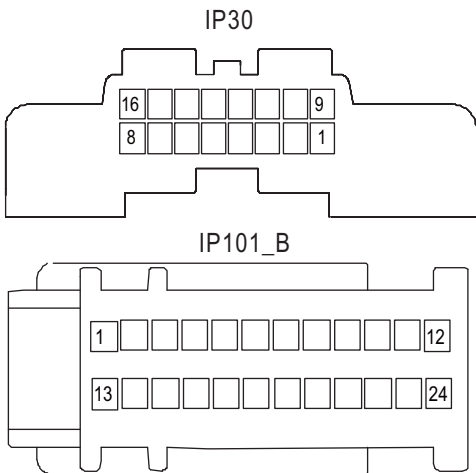
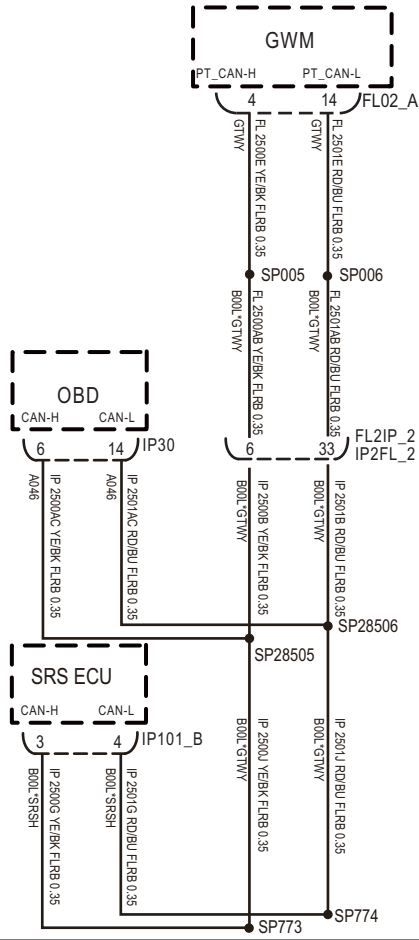

EK891301

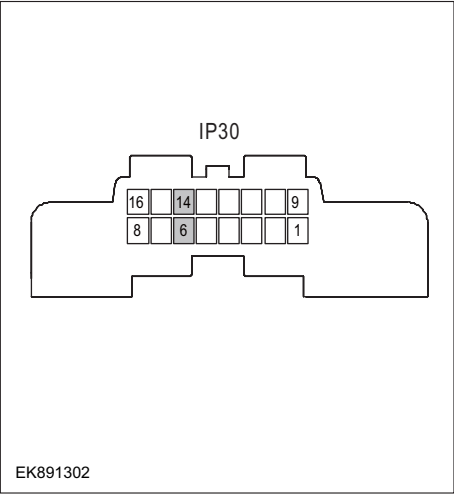
Troubleshooting steps	
Step1	General inspection.
	<ol style="list-style-type: none"> 1 Check fuse for damage. 2 Check battery capacity. 3 Check the harness plug of SRS for damage, poor contact, aging and looseness. 4 Check whether the result is normal or not?
NO → Repair or replace parts with detected faults.	
YES ↓	
Step2	Check fault codes.
	<ol style="list-style-type: none"> 1 Connect the scan tool to the diagnostic interface. 2 Turn the ignition switch to the on position. 3 Diagnose SRS module with diagnostic instrument. 4 Is there any other fault code except for U0154-87?
YES → Refer to: DTC Summary list (SRS) .	
NO ↓	
Step3	Check the integrity of CAN communication network.
	<ol style="list-style-type: none"> 1 Turn off the ignition switch. 2 Measure the resistance between diagnostic interface harness terminals. Measuring circuit: resistance between terminal 6 and terminal 14 of IP30 plug. Standard value: $\approx 60\Omega$ 3 Check whether the result is normal or not?
NO → Repair or replace parts with detected faults.	
YES ↓	

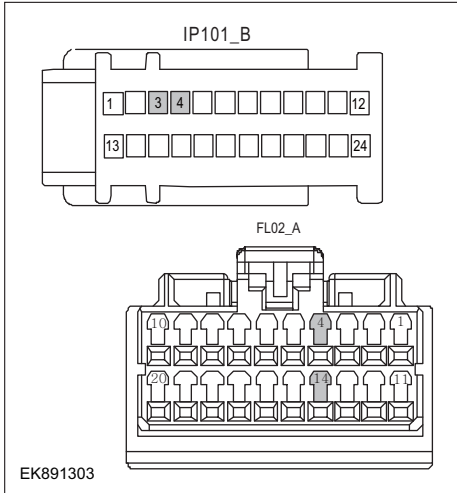
Step4	Check the resistance of gateway module and SRS terminal.
	<ol style="list-style-type: none"> 1 Turn off the ignition switch. 2 Disconnect the gateway module harness plug FL02 _ A. 3 Measure the resistance between the gateway module harness terminals. Measuring circuit: resistance between terminal 4 and terminal 14 of FL02_A plug. Standard value:110~130Ω 4 Connect the gateway module harness plug FL02 _ A. 5 Disconnect the SRS harness plug IP 101 _ B. 6 Measure the resistance between SRS harness terminals. Measuring circuit: resistance between terminal 3 and terminal 4 of IP101_B plug. Standard value:110~130Ω 7 Check whether the result is normal or not?
<p>NO → Repair or replace parts with detected faults.</p>	
<p>YES ↓</p>	
Step6	Check whether the SRS module is abnormal.
	<ol style="list-style-type: none"> 1 Turn off the ignition switch. 2 Disconnect and check the harness plug IP101_B of SRS module. 3 Inspection and maintenance: <ul style="list-style-type: none"> • Corrosion (install new connectors or terminals-clean module pins). • Damaged or bent pins-Install new terminals/pins. • Pin flying out-install new pins as needed. 4 Reconnect the SRS module plug and all other previously disconnected plugs. Make sure that the pins are properly positioned and fixed. 5 Run the system and determine if the problem still exists?
<p>YES → Replace SRS .</p>	
<p>NO ↓</p>	
<p>At this time, the system works normally. The cause of the problem may be module connection. Address the root cause of any connector or pin problem.</p>	
<p>Next Step ↓</p>	
<p>Diagnosis is over.</p>	

U0155-87

Fault diagnosis code
U0155-87: ABS Node Missing
Detection tools
1 Multimeter and diagnostic apparatus
Possible causes
<ul style="list-style-type: none">• Circuit, terminal and adapting piece fault• SRS• CAN• Terminal resistance fault
Conditions for fault code operation
Turn the ignition switch to the ON position
Conditions for fault code setting
U0155-87
0x269 message has not been received for 250 ms.
To set the effect of a fault code condition
Description of circuit diagram

Circuit diagram

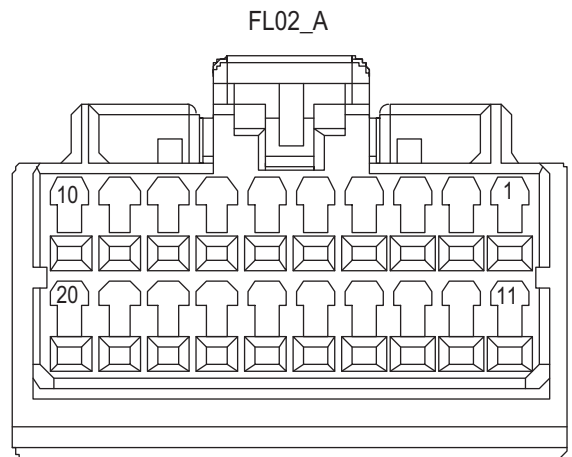
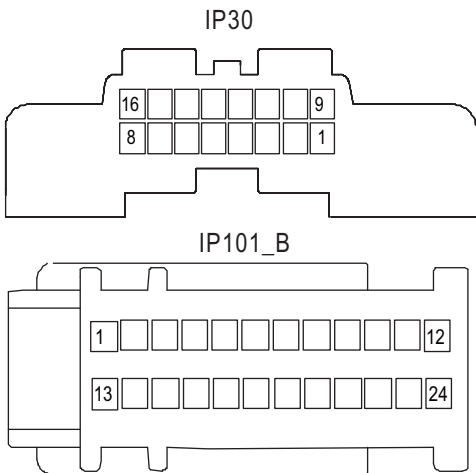
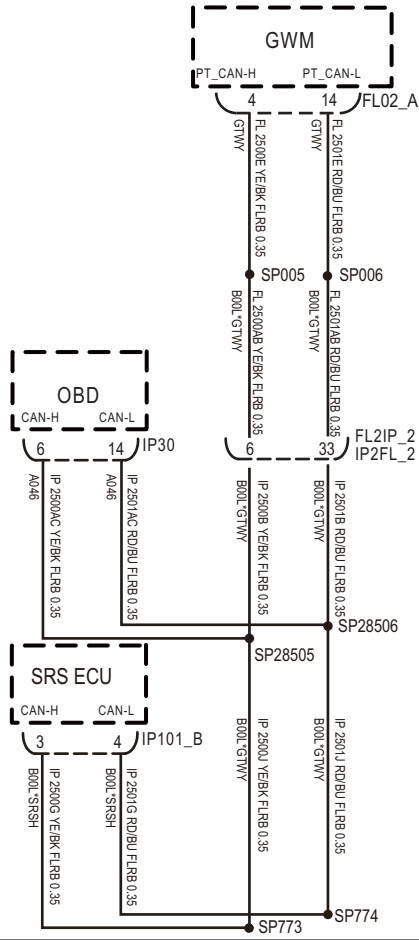

EK891301

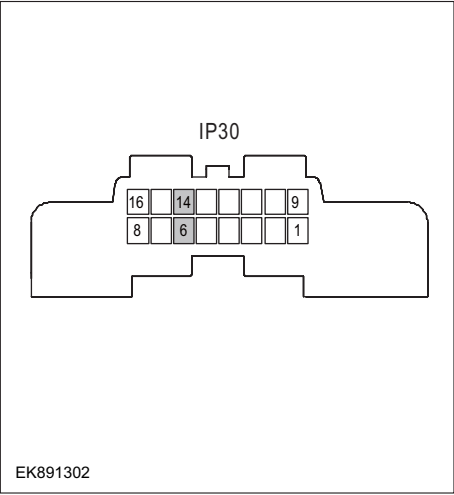
Troubleshooting steps	
Step1	General inspection.
	<ol style="list-style-type: none"> 1 Check fuse for damage. 2 Check battery capacity. 3 Check the harness plug of SRS for damage, poor contact, aging and looseness. 4 Check whether the result is normal or not?
	NO → Repair or replace parts with detected faults.
YES ↓	
Step2	Check fault codes.
	<ol style="list-style-type: none"> 1 Connect the scan tool to the diagnostic interface. 2 Turn the ignition switch to the on position. 3 Diagnose SRS module with diagnostic instrument. 4 Is there any other fault code except for U0155-87?
	YES → Refer to: DTC Summary list (SRS) .
NO ↓	
Step3	Check the integrity of CAN communication network.
	<ol style="list-style-type: none"> 1 Turn off the ignition switch. 2 Measure the resistance between diagnostic interface harness terminals. Measuring circuit: resistance between terminal 6 and terminal 14 of IP30 plug. Standard value: $\approx 60\Omega$ 3 Check whether the result is normal or not?
	NO → Repair or replace parts with detected faults.
YES ↓	

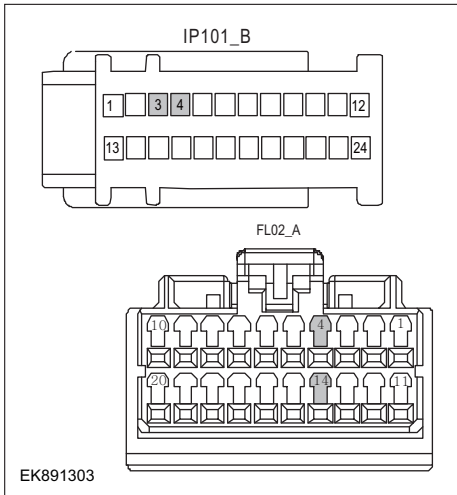
Step4	Check the resistance of gateway module and SRS terminal.
	<ol style="list-style-type: none"> 1 Turn off the ignition switch. 2 Disconnect the gateway module harness plug FL02 _ A. 3 Measure the resistance between the gateway module harness terminals. Measuring circuit: resistance between terminal 4 and terminal 14 of FL02_A plug. Standard value:110~130Ω 4 Connect the gateway module harness plug FL02 _ A. 5 Disconnect the SRS harness plug IP 101 _ B. 6 Measure the resistance between SRS harness terminals. Measuring circuit: resistance between terminal 3 and terminal 4 of IP101_B plug. Standard value:110~130Ω 7 Check whether the result is normal or not?
<p>NO → Repair or replace parts with detected faults.</p>	
<p>YES ↓</p>	
Step6	Check whether the SRS module is abnormal.
	<ol style="list-style-type: none"> 1 Turn off the ignition switch. 2 Disconnect and check the harness plug IP101_B of SRS module. 3 Inspection and maintenance: <ul style="list-style-type: none"> • Corrosion (install new connectors or terminals-clean module pins). • Damaged or bent pins-Install new terminals/pins. • Pin flying out-install new pins as needed. 4 Reconnect the SRS module plug and all other previously disconnected plugs. Make sure that the pins are properly positioned and fixed. 5 Run the system and determine if the problem still exists?
<p>YES → Replace SRS .</p>	
<p>NO ↓</p>	
<p>At this time, the system works normally. The cause of the problem may be module connection. Address the root cause of any connector or pin problem.</p>	
<p>Next Step ↓</p>	
<p>Diagnosis is over.</p>	

U0156-87

Fault diagnosis code
U0156-87: IPK Node Missing
Detection tools
1 Multimeter and diagnostic apparatus
Possible causes
<ul style="list-style-type: none">• Circuit,terminal and adapting piece fault• SRS• CAN• Terminal resistance fault
Conditions for fault code operation
Turn the ignition switch to the ON position
Conditions for fault code setting
U0156-87
0x362 message has not been received for 250ms continuously.
To set the effect of a fault code condition
Description of circuit diagram

Circuit diagram

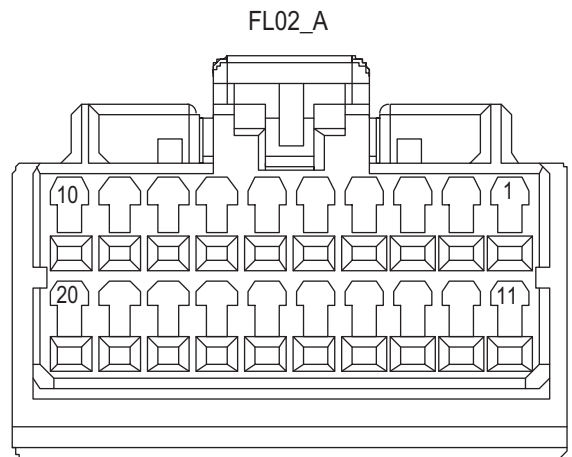
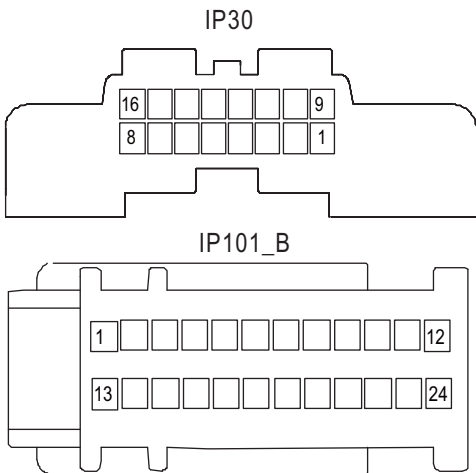
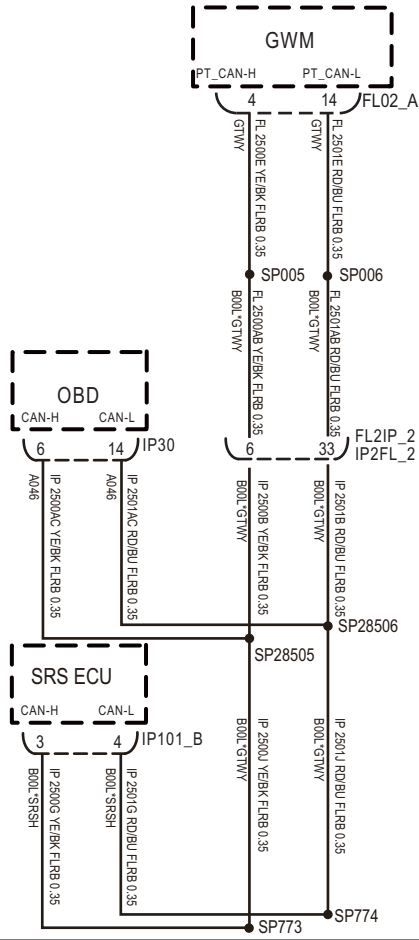

EK891301

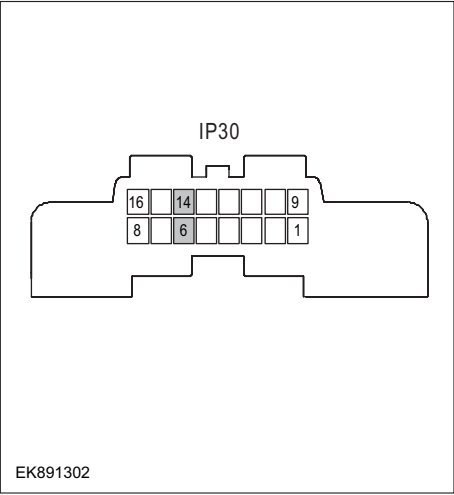
Troubleshooting steps	
Step1	General inspection.
	<ol style="list-style-type: none"> 1 Check fuse for damage. 2 Check battery capacity. 3 Check the harness plug of SRS for damage, poor contact, aging and looseness. 4 Check whether the result is normal or not?
NO → Repair or replace parts with detected faults.	
YES ↓	
Step2	Check fault codes.
	<ol style="list-style-type: none"> 1 Connect the scan tool to the diagnostic interface. 2 Turn the ignition switch to the on position. 3 Diagnose SRS module with diagnostic instrument. 4 Is there any other fault code except for U0156-87?
YES → Refer to: DTC Summary list (SRS) .	
NO ↓	
Step3	Check the integrity of CAN communication network.
	<ol style="list-style-type: none"> 1 Turn off the ignition switch. 2 Measure the resistance between diagnostic interface harness terminals. Measuring circuit: resistance between terminal 6 and terminal 14 of IP30 plug. Standard value: $\approx 60\Omega$ 3 Check whether the result is normal or not?
NO → Repair or replace parts with detected faults.	
YES ↓	

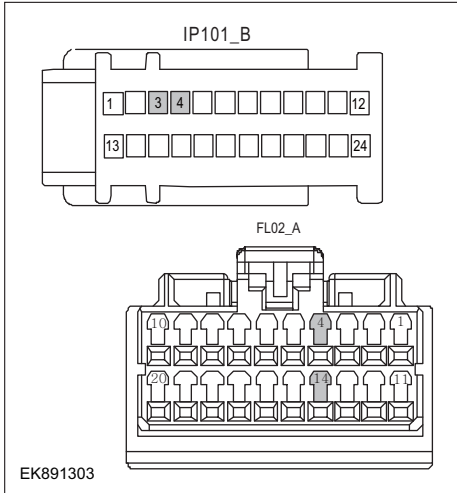
Step4	Check the resistance of gateway module and SRS terminal.
	<ol style="list-style-type: none"> 1 Turn off the ignition switch. 2 Disconnect the gateway module harness plug FL02 _ A. 3 Measure the resistance between the gateway module harness terminals. Measuring circuit: resistance between terminal 4 and terminal 14 of FL02_A plug. Standard value:110~130Ω 4 Connect the gateway module harness plug FL02 _ A. 5 Disconnect the SRS harness plug IP 101 _ B. 6 Measure the resistance between SRS harness terminals. Measuring circuit: resistance between terminal 3 and terminal 4 of IP101_B plug. Standard value:110~130Ω 7 Check whether the result is normal or not?
<p>NO → Repair or replace parts with detected faults.</p>	
<p>YES ↓</p>	
Step6	Check whether the SRS module is abnormal.
	<ol style="list-style-type: none"> 1 Turn off the ignition switch. 2 Disconnect and check the harness plug IP101_B of SRS module. 3 Inspection and maintenance: <ul style="list-style-type: none"> • Corrosion (install new connectors or terminals-clean module pins). • Damaged or bent pins-Install new terminals/pins. • Pin flying out-install new pins as needed. 4 Reconnect the SRS module plug and all other previously disconnected plugs. Make sure that the pins are properly positioned and fixed. 5 Run the system and determine if the problem still exists?
<p>YES → Replace SRS .</p>	
<p>NO ↓</p>	
<p>At this time, the system works normally. The cause of the problem may be module connection. Address the root cause of any connector or pin problem.</p>	
<p>Next Step ↓</p>	
<p>Diagnosis is over.</p>	

U1562-17、 U1563-16

Fault diagnosis code
U1562-17: Battery voltage is too high
U1563-16: Battery voltage is too low
Detection tools
1 Multimeter and diagnostic apparatus
Possible causes
<ul style="list-style-type: none"> • Circuit,terminal and adapting piece fault • storage battery • SRS • fuse
Conditions for fault code operation
Turn the ignition switch to the ON position
Conditions for fault code setting
U1562-17
If the power supply voltage is higher than 16V for 3 consecutive seconds, record it.
U1563-16
If the power supply voltage blows continuously at 9V for 3 seconds, it will be recorded, except at startup. This DTC will not be recorded in KL.50
To set the effect of a fault code condition
Description of circuit diagram
SRS will always monitor whether the sensors and actuators are in the normal range. At the same time, it will also test the rationality of virtual connection, short circuit, open circuit and other signals. When a fault occurs, SRS will store the fault code corresponding to this fault.

Circuit diagram

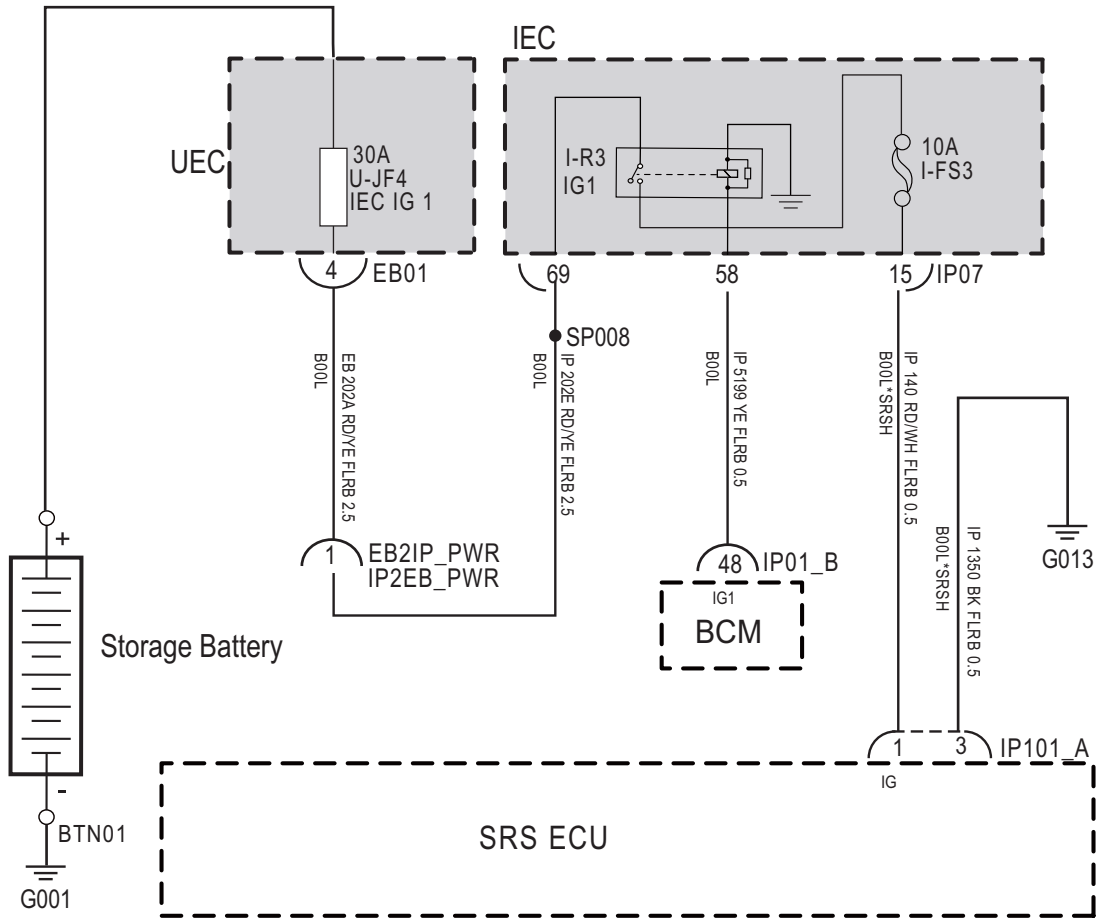

IP101_A

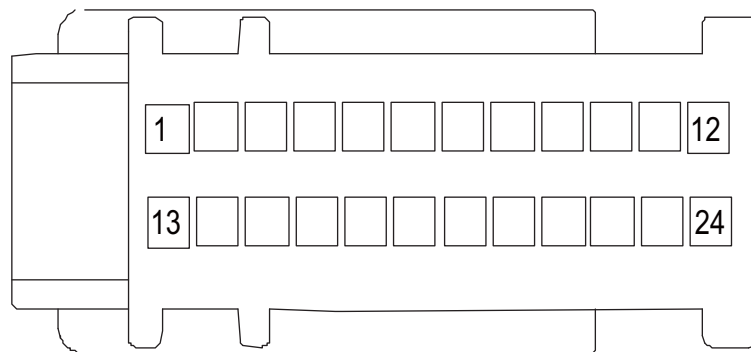

EK891304

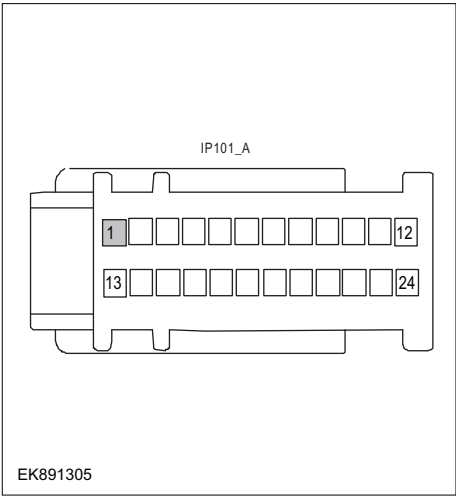
Troubleshooting steps	
Step1	General inspection.
	<ol style="list-style-type: none"> 1 Check fuse U-JF4、 I-FS3 for damage. 2 Check relay IG1 for damage. 3 Check battery capacity. 4 Check the harness plug of SRS for damage, poor contact, aging and looseness. 5 Check whether the result is normal or not?
<p>NO → Repair or replace parts with detected faults.</p>	
<p>YES ↓</p>	
Step2	Check fault codes.
	<ol style="list-style-type: none"> 1 Connect the scan tool to the diagnostic interface. 2 Turn the ignitiON switch to the on position. 3 Diagnose SRS module with diagnostic instrument. 4 Is there any other fault code except for U1562-17、 U1563-16?
<p>YES → Refer to:DTC Summary list (SRS).</p>	
<p>NO ↓</p>	
Step3	Check the power supply voltage of SCU module when it is started or running.
	<ol style="list-style-type: none"> 1 Turn on the ignition switch. 2 Measure the voltage between SRS module harness terminal and ground. Measuring circuit: voltage between terminal 1 of IP101_A plug and ground. Standard value:10~14V 3 Check whether the result is normal or not?
<p>NO → Repair or replace parts with detected faults.</p>	
<p>YES ↓</p>	

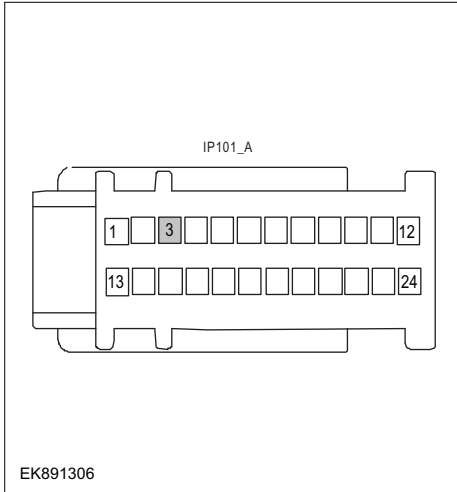
Step4	Check SRS module ground circuit for open circuit.
	<ol style="list-style-type: none"> 1 Turn off the ignition switch. 2 Measure the resistance between SRS module harness plug and ground. Measuring circuit: resistance between terminal 3 of IP101_A plug and ground. Standard value:< 1Ω 3 Is the resistance less than 1 ω?
NO → Repair or replace parts with detected faults.	
YES ↓	
Step5	Check whether the SCU module is abnormal.
	<ol style="list-style-type: none"> 1 Turn off the ignition switch. 2 Disconnect and check the harness plug IP101_A of SRS module. 3 Inspection and maintenance: <ul style="list-style-type: none"> • Corrosion (install new connectors or terminals-clean module pins). • Damaged or bent pins-Install new terminals/pins. • Pin flying out-install new pins as needed. 4 Reconnect the SRS module plug and all other previously disconnected plugs. Make sure that the pins are properly positioned and fixed. 5 Run the system and determine if the problem still exists?
YES → Replace SRS .	
NO ↓	
At this time, the system works normally. The cause of the problem may be module connection. Address the root cause of any connector or pin problem.	
Next Step ↓	
Diagnosis is over.	

B0001-11、 B0001-12、 B0001-1A、 B0001-1B、 B0001-56

Fault diagnosis code
B0001-11: Driver Frontal Airbag - Short to GND
B0001-12: Driver Frontal Airbag - Short to Battery
B0001-1A: Driver Frontal Airbag - Resistance too Low
B0001-1B: Driver Frontal Airbag - Resistance too High
B0001-56: Driver Frontal Airbag - Incompatible Configuration
Detection tools
1 Multimeter and diagnostic apparatus
Possible causes
<ul style="list-style-type: none"> • Circuit, terminal and adapting piece fault • SRS • Driver's front airbag failure
Conditions for fault code operation
Turn the ignition switch to the ON position
Conditions for fault code setting
B0001-11
The fault is detected when the leakage resistance value is less than 2.5 k ω , and it may be detected when the leakage resistance value is less than 6.5 k ω .
B0001-12
The fault is detected when the leakage resistance value is less than 1.8 k ω , and it may be detected when the leakage resistance value is less than 9.7 k ω .
B0001-1A
The fault is detected when the airbag resistance value is less than 1.1 ohms, and the fault may be detected when the airbag resistance value is less than 1.7 ohms.
B0001-1B
The fault is detected when the airbag resistance value is greater than 5.0 ohms, and it may be detected when the airbag resistance value is greater than 3.8 ohms.
B0001-56
A) Airbags that should not be configured are installed; B) The airbag does not exist, but the corresponding pin has leakage to power supply or ground.
To set the effect of a fault code condition
The airbag fault light is on, and it does not have the function of igniting the airbag.
Description of circuit diagram
SRS module monitors the driver's front airbag through the low-level reference circuit and signal circuit.

Circuit diagram

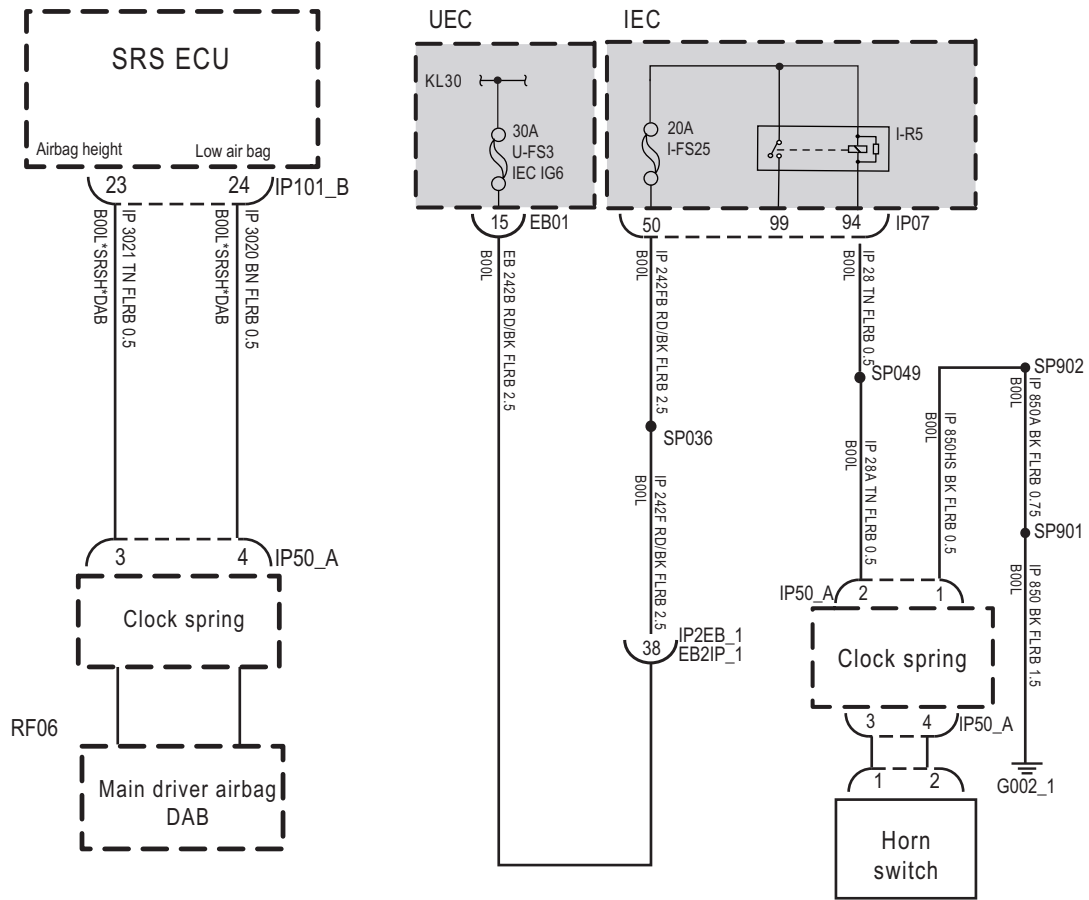

IP101_B

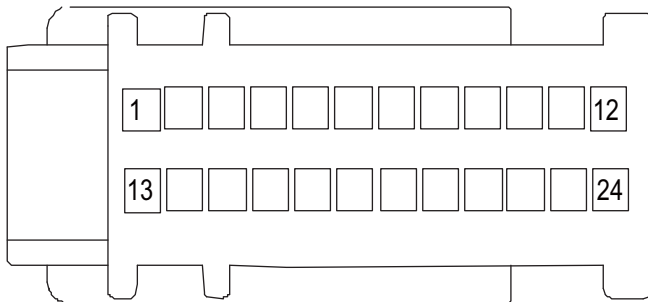

IP50_A

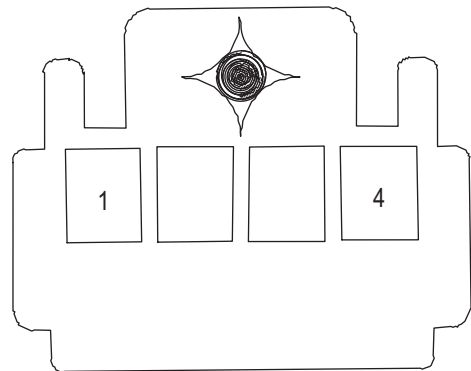

EK891307

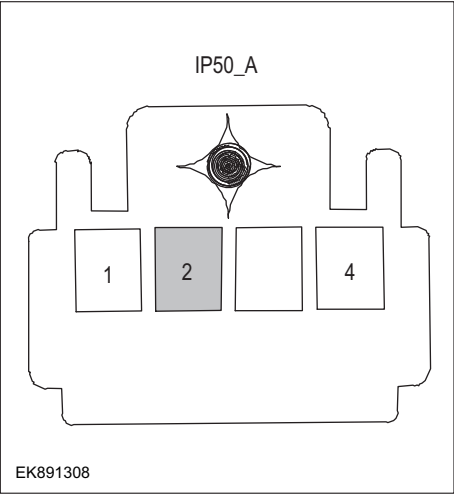
Troubleshooting steps	
Step1	General inspection.
	<ol style="list-style-type: none"> 1 Check fuse for damage. 2 Check battery capacity. 3 Check the driver's front airbag and SRS module harness plug for damage, poor contact, aging and looseness. 4 Check whether the result is normal or not?
	NO → Repair or replace parts with detected faults.
YES ↓	
Step2	Check fault codes.
	<ol style="list-style-type: none"> 1 Connect the scan tool to the diagnostic interface. 2 Turn the ignition switch to the on position. 3 Diagnose SRS module with diagnostic instrument. 4 Is there any other fault code except for B0001-11、 B0001-12、 B0001-1A、 B0001-1B、 B0001-56?
	YES → Refer to: DTC Summary list (SRS) .
NO ↓	
Step3	Check the driver's front airbag circuit power supply circuit.
	<ol style="list-style-type: none"> 1 Turn off the ignition switch. 2 Disconnect the clock spring harness plug IP50 _ A. 3 Turn on the ignition switch. 4 Measure the voltage between the clock spring harness terminal and ground. Measuring circuit: voltage between terminal 2 of IP50_A plug and ground. Standard value:10~14V 5 Check whether the result is normal or not?
	NO → Repair or replace parts with detected faults.
YES ↓	

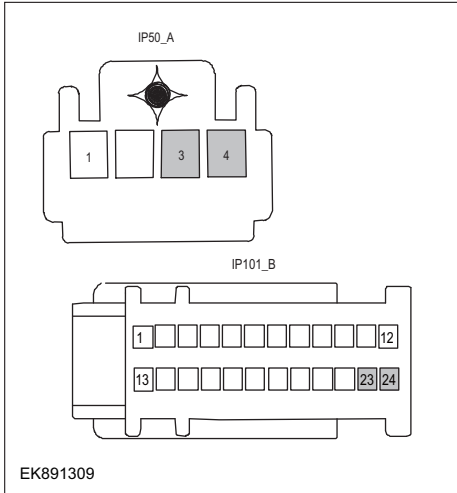
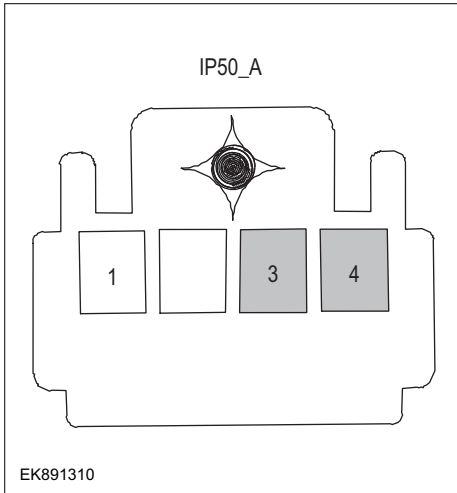
Step4	Check driver's front airbag circuit (open circuit).
 <p>EK891309</p>	<ol style="list-style-type: none"> 1 Turn off the ignition switch. 2 Disconnect SRS module harness plug. 3 Measure the resistance between the clock spring harness terminal and SRS module harness terminal. Measuring circuit: resistance between terminal 3 of IP50_A plug and terminal 23 of SRS module plug. Measuring circuit: resistance between terminal 4 of IP50_A plug and terminal 24 of SRS module plug. Standard value: $\approx 0\Omega$ 4 Check whether the result is normal or not?
NO → Repair or replace parts with detected faults.	
YES ↓	
Step5	Check driver's front airbag circuit (short circuit).
 <p>EK891310</p>	<ol style="list-style-type: none"> 1 Turn off the ignition switch. 2 Measure the resistance between clock spring harness plug and ground. Measuring circuit: resistance between terminal 3 of IP50_A plug and ground. Measuring circuit: resistance between terminal 4 of IP50_A plug and ground. Standard value: infinite 3 Measure the voltage between clock spring harness plug and ground. Measuring circuit: voltage between terminal 4 of IP50_A plug and ground. Standard value: $\approx 0V$ 4 Check whether the result is normal or not?
NO → Repair or replace parts with detected faults.	
YES ↓	

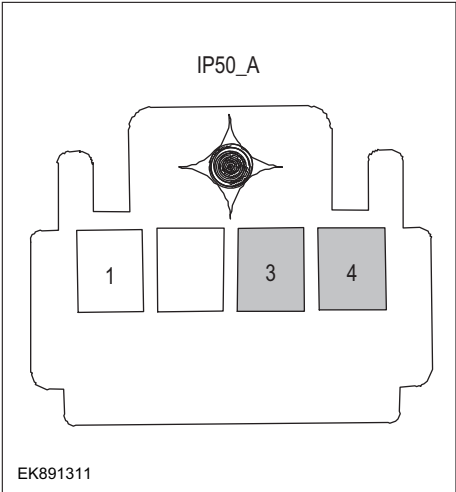
Step6	Check the driver's front airbag (component inspection).
	<ol style="list-style-type: none"> 1 Directly measure the resistance of the clock spring terminal. Measuring circuit: resistance between terminal 3 and terminal 4 of IP50_A plug. Standard value: 2 Measure the resistance between the clock spring terminal and the housing. Measuring circuit: the resistance between the No.3 terminal of IP50_A plug and the housing. Measuring circuit: resistance between terminal 4 of IP50_A plug and housing. Standard value:infinite 3 Check whether the result is normal or not?
<p>NO → Replace the driver's front airbag.</p>	
<p>YES ↓</p>	
Step7	Check whether the SRS module is abnormal.
	<ol style="list-style-type: none"> 1 Turn off the ignition switch. 2 Disconnect and check SRS module harness plug. 3 Inspection and maintenance: <ul style="list-style-type: none"> • Corrosion (install new connectors or terminals-clean module pins). • Damaged or bent pins-Install new terminals/pins. • Pin flying out-install new pins as needed. 4 Reconnect the SRS module plug and all other previously disconnected plugs. Make sure that the pins are properly positioned and fixed. 5 Run the system and determine if the problem still exists?
<p>YES → Replace SRS .</p>	
<p>NO ↓</p>	
<p>At this time, the system works normally. The cause of the problem may be module connection. Address the root cause of any connector or pin problem.</p>	
<p>Next Step ↓</p>	
<p>Diagnosis is over.</p>	

B0010-11、 B0010-12、 B0010-1A、 B0010-1B、 B0010-56

Fault diagnosis code
B0010-11: Passenger Frontal Airbag - Short to GND
B0010-12: Passenger Frontal Airbag - Short to Battery
B0010-1A: Passenger Frontal Airbag - Resistance too Low
B0010-1B: Passenger Frontal Airbag- Resistance too High
B0010-56: Passenger Frontal Airbag - Incompatible Configuration
Detection tools
1 Multimeter and diagnostic apparatus
Possible causes
<ul style="list-style-type: none"> • Circuit,terminal and adapting piece fault • SRS • Front passenger front airbag failure
Conditions for fault code operation
Turn the ignition switch to the ON position
Conditions for fault code setting
B0010-11
The fault is detected when the leakage resistance value is less than 2.5 k ω , and it may be detected when the leakage resistance value is less than 6.5 k ω .
B0010-12
The fault is detected when the leakage resistance value is less than 1.8 k ω , and it may be detected when the leakage resistance value is less than 9.7 k ω .
B0010-1A
The fault is detected when the airbag resistance value is less than 1.1 ohms, and the fault may be detected when the airbag resistance value is less than 1.7 ohms.
B0010-1B
The fault is detected when the airbag resistance value is greater than 5.0 ohms, and it may be detected when the airbag resistance value is greater than 3.8 ohms.
B0010-56
A) Airbags that should not be configured are installed; B) The airbag does not exist, but the corresponding pin has leakage to power supply or ground.
To set the effect of a fault code condition
The airbag fault light is on, and it does not have the function of igniting the airbag.
Description of circuit diagram
The SRS module monitors the front airbag of the front passenger through the low reference circuit and the signal circuit.

Circuit diagram

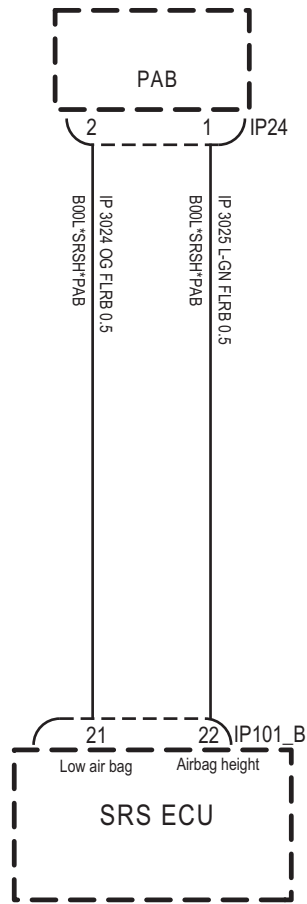

IP101_B

IP24

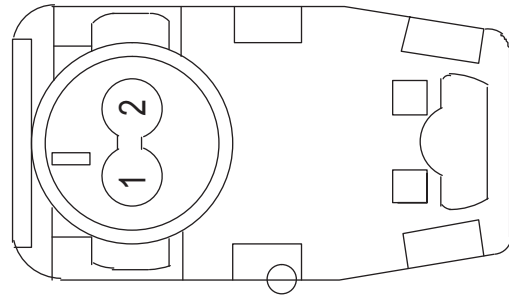
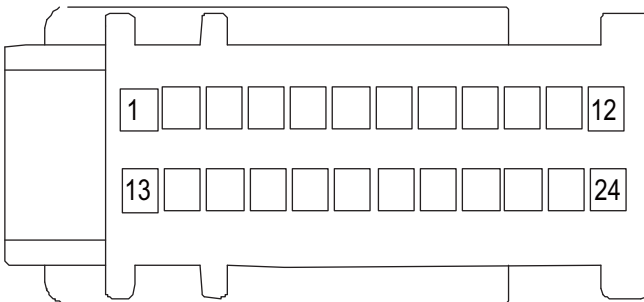

EK891312

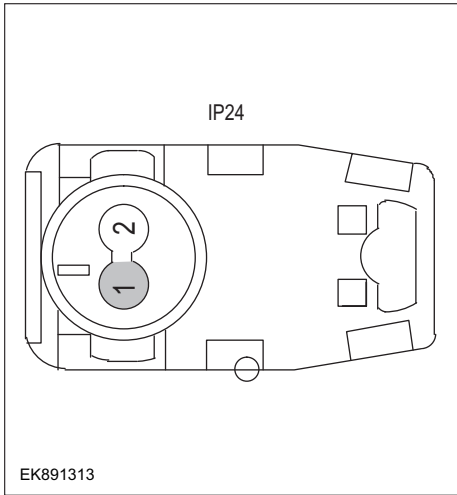
Troubleshooting steps	
Step1	General inspection.
	<ol style="list-style-type: none"> 1 Check fuse for damage. 2 Check battery capacity. 3 Check the front passenger airbag and SRS module harness plug for damage, poor contact, aging and looseness. 4 Check whether the result is normal or not?
NO → Repair or replace parts with detected faults.	
YES ↓	
Step2	Check fault codes.
	<ol style="list-style-type: none"> 1 Connect the scan tool to the diagnostic interface. 2 Turn the ignition switch to the on position. 3 Diagnose SRS module with diagnostic instrument. 4 Is there any other fault code except for B0010-11、B0010-12、B0010-1A、B0010-1B、B0010-56?
YES → Refer to: DTC Summary list (SRS) .	
NO ↓	
Step3	Check the power supply circuit of the front passenger airbag circuit.
	<ol style="list-style-type: none"> 1 Turn off the ignition switch. 2 Disconnect the front passenger's front airbag harness plug. 3 Turn on the ignition switch. 4 Measure the voltage between the front passenger airbag harness terminal and ground. Measuring circuit: voltage between No.1 terminal of front passenger airbag plug and ground. Standard value:10~14V 5 Check whether the result is normal or not?
NO → Repair or replace parts with detected faults.	
YES ↓	

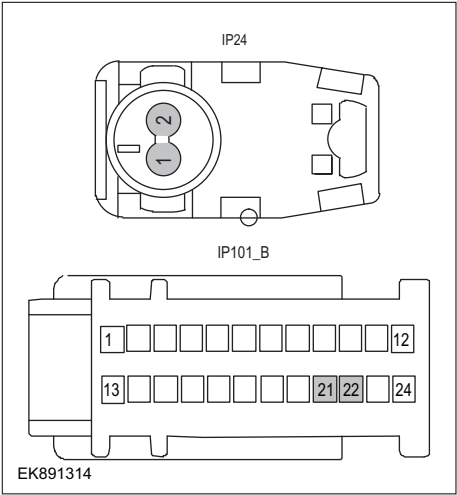
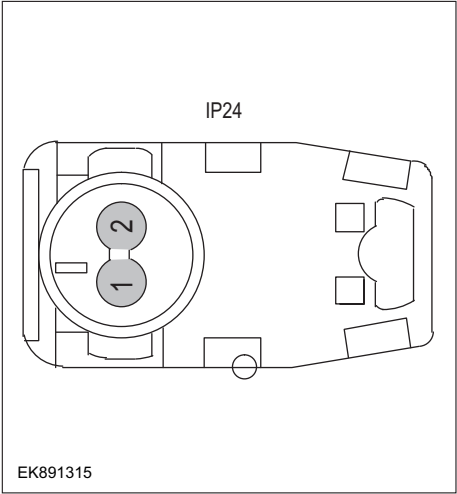
Step4	Check front passenger airbag circuit (open circuit).
	<ol style="list-style-type: none"> 1 Turn off the ignition switch. 2 Disconnect SRS module harness plug. 3 Measure the resistance between the front passenger airbag harness terminal and the SRS module harness terminal. Measuring circuit: resistance between No.1 terminal of front passenger airbag plug and No.22 terminal of SRS module plug. Measuring circuit: resistance between No.2 terminal of front passenger airbag plug and No.21 terminal of SRS module plug. Standard value: $\approx 0\Omega$ 4 Check whether the result is normal or not?
NO → Repair or replace parts with detected faults.	
YES ↓	
Step5	Check front passenger airbag circuit (short circuit).
	<ol style="list-style-type: none"> 1 Turn off the ignition switch. 2 Measure the resistance between front passenger airbag harness plug and ground. Measuring circuit: resistance between No.1 terminal of front passenger airbag plug and ground. Measuring circuit: resistance between No.2 terminal of front passenger airbag plug and ground. Standard value: infinite 3 Measure the voltage between front passenger airbag harness plug and ground. Measuring circuit: voltage between No.2 terminal of front passenger airbag plug and ground. Standard value: $\approx 0V$ 4 Check whether the result is normal or not?
NO → Repair or replace parts with detected faults.	
YES ↓	

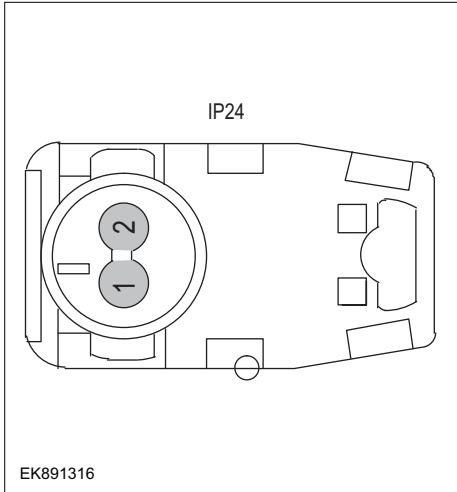
Step6	Check the front passenger airbag (component inspection).
 <p>The diagram shows a top-down view of the front passenger airbag plug. It features two circular terminals labeled '1' and '2'. The plug is housed in a rectangular casing with various mounting points and a small circular hole at the bottom. The text 'IP24' is printed above the plug, and 'EK891316' is printed at the bottom left of the diagram.</p>	<ol style="list-style-type: none"> 1 Directly measure the resistance of the front airbag terminal of the front passenger. <p>Measuring circuit: resistance between terminal 1 and terminal 2 of front passenger airbag plug.</p> <p>Standard value:</p> 2 Measure the resistance between the front airbag terminal of the front passenger and the housing. <p>Measuring circuit: resistance between No.1 terminal of front passenger airbag plug and housing.</p> <p>Measuring circuit: resistance between No.2 terminal of front passenger airbag plug and housing.</p> <p>Standard value:infinite</p> 3 Check whether the result is normal or not?
<p>NO → Replace the front airbag of the front passenger.</p>	
<p>YES ↓</p>	
Step7	Check whether the SRS module is abnormal.
	<ol style="list-style-type: none"> 1 Turn off the ignition switch. 2 Disconnect and check SRS module harness plug. 3 Inspection and maintenance: <ul style="list-style-type: none"> • Corrosion (install new connectors or terminals-clean module pins). • Damaged or bent pins-Install new terminals/pins. • Pin flying out-install new pins as needed. 4 Reconnect the SRS module plug and all other previously disconnected plugs. Make sure that the pins are properly positioned and fixed. 5 Run the system and determine if the problem still exists?
<p>YES → Replace SRS .</p>	
<p>NO ↓</p>	
<p>At this time, the system works normally. The cause of the problem may be module connection. Address the root cause of any connector or pin problem.</p>	
<p>Next Step ↓</p>	
<p>Diagnosis is over.</p>	

B0090-49、 B0090-87、 B0090-86、 B0091-56、

Fault diagnosis code
B0090-49: Left Front Satellite Sensor - Internal Fault
B0090-87: Left Front Satellite Sensor - Lost Communication
B0090-86: Left Front Satellite Sensor – transmitted data invalid
B0091-56: Left Front Satellite Sensor - Incompatible Configuration
Detection tools
1 Multimeter and diagnostic apparatus
Possible causes
<ul style="list-style-type: none"> • Circuit, terminal and adapting piece fault • SRS • Front impact sensor failure
Conditions for fault code operation
Turn the ignition switch to the ON position
Conditions for fault code setting
B0090-49
The sensor has self-checking function: once a fault is detected, the sensor will report the fault.
B0090-87
The external sensor is not connected or the harness is open.
B0090-86
Any communication error will cause the fault, such as wrong data frame, wrong data frame length, etc.
B0091-56
Not configured but connected with the wrong sensor.
To set the effect of a fault code condition
The airbag fault light is on, and it does not have the function of igniting the airbag.
Description of circuit diagram
The SRS module monitors the front impact sensor through the low reference circuit and the signal circuit.

Circuit diagram

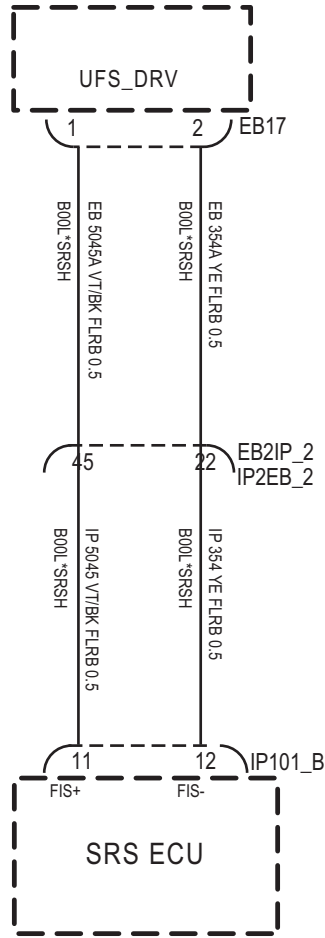

IP101_B

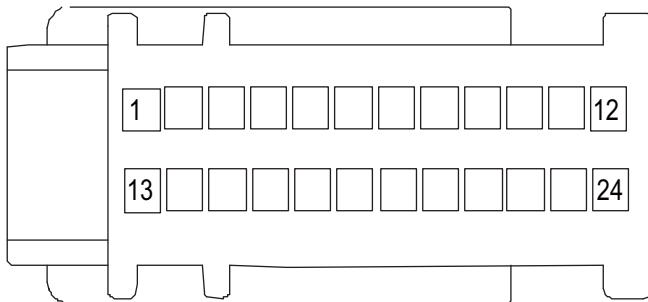

EB17

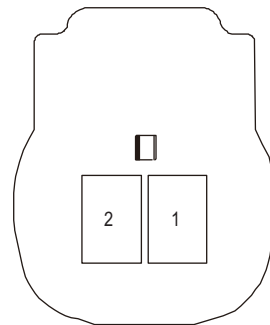

EK891317

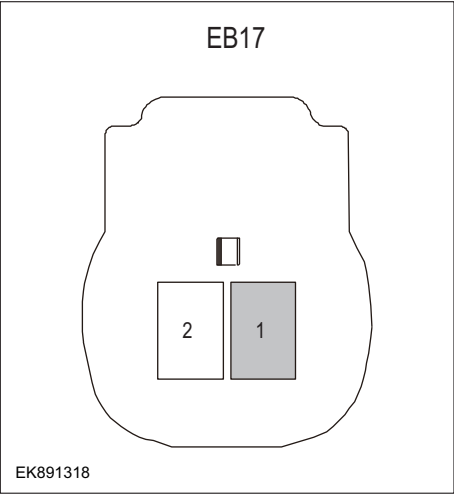
Troubleshooting steps	
Step1	General inspection.
	<ol style="list-style-type: none"> 1 Check fuse for damage. 2 Check battery capacity. 3 Check the left impact sensor and SRS module harness plug for damage, poor contact, aging and looseness. 4 Check whether the result is normal or not?
NO → Repair or replace parts with detected faults.	
YES ↓	
Step2	Check fault codes.
	<ol style="list-style-type: none"> 1 Connect the scan tool to the diagnostic interface. 2 Turn the ignition switch to the on position. 3 Diagnose SRS module with diagnostic instrument. 4 Is there any other fault code except for B0090-49, B0090-87, B0090-86, B0091-56, B0091-91?
YES → Refer to: DTC Summary list (SRS) .	
NO ↓	
Step3	Check the left impact sensor circuit supply circuit.
	<ol style="list-style-type: none"> 1 Turn off the ignition switch. 2 Disconnect the left impact sensor harness plug. 3 Turn on the ignition switch. 4 Measure the voltage between the left impact sensor harness terminal and ground. Measuring circuit: voltage between terminal 1 of left impact sensor plug and ground. Standard value:4.8~5.2V 5 Check whether the result is normal or not?
NO → Repair or replace parts with detected faults.	
YES ↓	

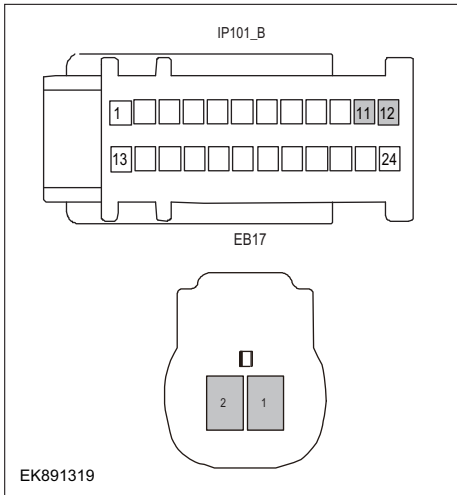
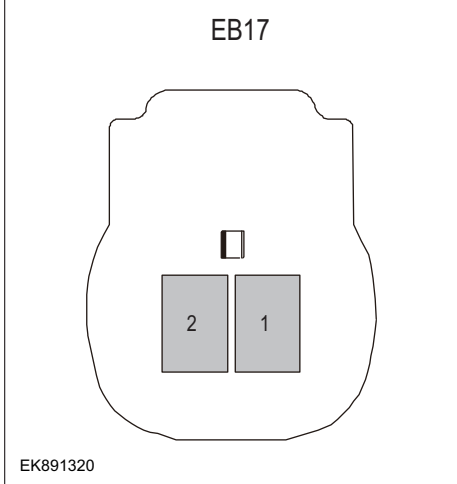
Step4	Check left impact sensor circuit (open circuit).
	<ol style="list-style-type: none"> 1 Turn off the ignition switch. 2 Disconnect SRS module harness plug. 3 Measure the resistance between the left impact sensor harness terminal and the SRS module harness terminal. Measuring circuit: resistance between terminal 1 of left impact sensor plug and terminal 11 of SRS module plug. Measuring circuit: resistance between terminal 2 of left impact sensor plug and terminal 12 of SRS module plug. Standard value: $\approx 0\Omega$ 4 Check whether the result is normal or not?
NO → Repair or replace parts with detected faults.	
YES ↓	
Step5	Check left impact sensor circuit (short circuit).
	<ol style="list-style-type: none"> 1 Turn off the ignition switch. 2 Measure the resistance between left impact sensor harness plug and ground. Measuring circuit: resistance between terminal 1 of left impact sensor plug and ground. Measuring circuit: resistance between terminal 2 of left impact sensor plug and ground. Standard value: infinite 3 Measure the voltage between left impact sensor harness plug and ground. Measuring circuit: voltage between terminal 2 of left impact sensor plug and ground. Standard value: $\approx 0V$ 4 Check whether the result is normal or not?
NO → Repair or replace parts with detected faults.	
YES ↓	

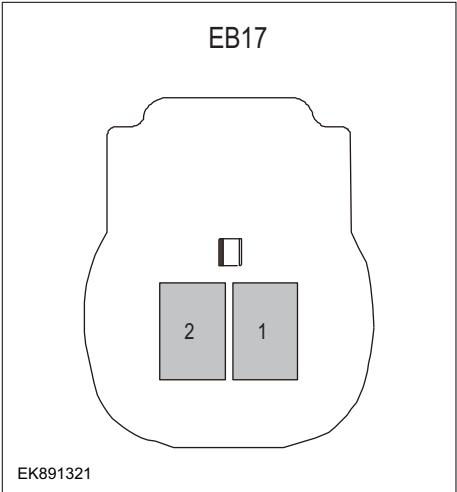
Step6	Check the left impact sensor (component inspection).
 <p>The diagram shows the left impact sensor EB17. It is a roughly rectangular component with rounded corners. In the center, there is a small rectangular terminal block with two terminals labeled '1' and '2'. Terminal '1' is on the right and terminal '2' is on the left. The sensor is mounted on a larger, irregularly shaped housing. The part number 'EB17' is printed at the top, and 'EK891321' is printed at the bottom left of the diagram.</p>	<ol style="list-style-type: none"> 1 Directly measure the resistance of the terminal of the left impact sensor. Measuring circuit: resistance between terminal 1 and terminal 2 of left impact sensor plug. Standard value: 2 Measure the resistance between the terminal of the left impact sensor and the housing. Measuring circuit: resistance between terminal 1 of left impact sensor plug and housing. Measuring circuit: resistance between terminal 2 of left impact sensor plug and housing. Standard value:infinite 3 Check whether the result is normal or not?
<p>NO → Replace the left impact sensor.</p>	
<p>YES ↓</p>	
Step7	Check whether the SRS module is abnormal.
	<ol style="list-style-type: none"> 1 Turn off the ignition switch. 2 Disconnect and check SRS module harness plug. 3 Inspection and maintenance: <ul style="list-style-type: none"> • Corrosion (install new connectors or terminals-clean module pins). • Damaged or bent pins-Install new terminals/pins. • Pin flying out-install new pins as needed. 4 Reconnect the SRS module plug and all other previously disconnected plugs. Make sure that the pins are properly positioned and fixed. 5 Run the system and determine if the problem still exists?
<p>YES → Replace SRS .</p>	
<p>NO ↓</p>	
<p>At this time, the system works normally. The cause of the problem may be module connection. Address the root cause of any connector or pin problem.</p>	
<p>Next Step ↓</p>	
<p>Diagnosis is over.</p>	

B0095-49、 B0095-87、 B0095-86、 B0095-56

Fault diagnosis code
B0096-49: Right Side Satellite Sensor - Internal Fault
B0096-87: Right Side Satellite Sensor - Lost Communication
B0096-86: Right Side Satellite Sensor – transmitted data invalid
B0095-56: Right Side Satellite Sensor - Incompatible Configuration
Detection tools
1 Multimeter and diagnostic apparatus
Possible causes
<ul style="list-style-type: none"> • Circuit,terminal and adapting piece fault • SRS • Right impact sensor failure.
Conditions for fault code operation
Turn the ignition switch to the ON position
Conditions for fault code setting
B0095-49
The sensor has self-checking function: once a fault is detected, the sensor will report the fault.
B0095-87
The external sensor is not connected or the harness is open.
B0095-86
Any communication error will cause the fault, such as wrong data frame, wrong data frame length, etc.
B0095-56
Not configured but connected with the wrong sensor.
To set the effect of a fault code condition
The airbag fault light is on, and it does not have the function of igniting the airbag.
Description of circuit diagram
The SRS module monitors the right impact sensor through the low reference circuit and the signal circuit.

Circuit diagram

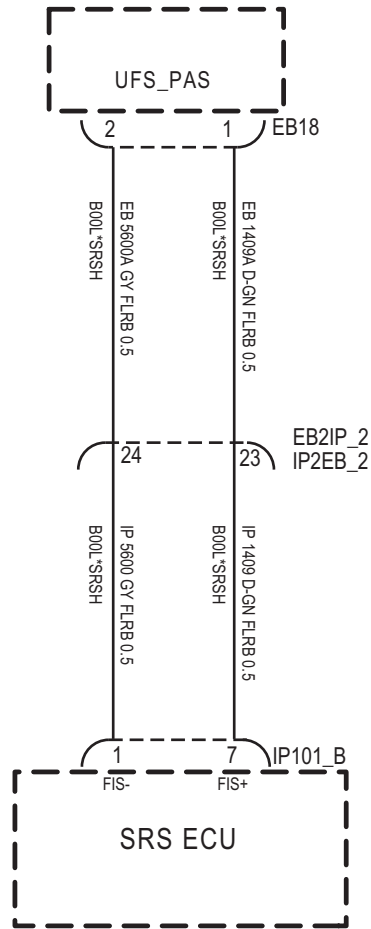

IP101_B

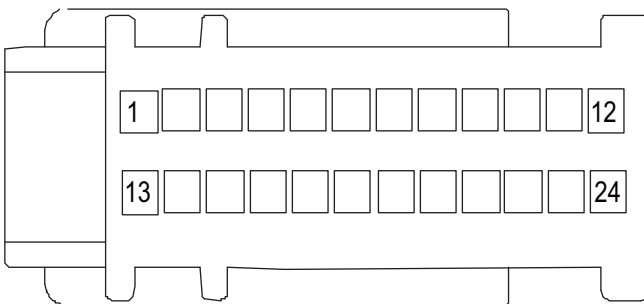

EB18

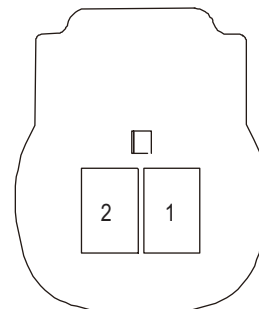

EK891322

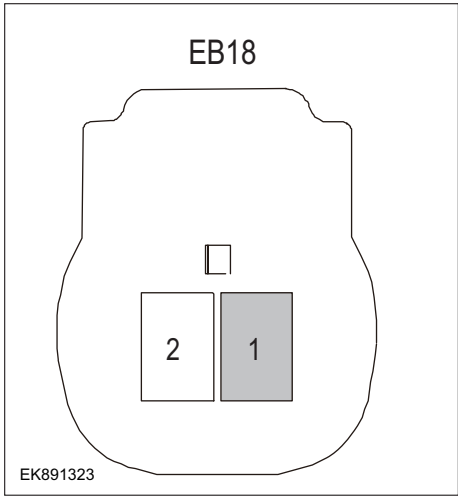
Troubleshooting steps	
Step1	General inspection.
	<ol style="list-style-type: none"> 1 Check fuse for damage. 2 Check battery capacity. 3 Check the right impact sensor and SRS module harness plug for damage, poor contact, aging and looseness. 4 Check whether the result is normal or not?
	NO → Repair or replace parts with detected faults.
YES ↓	
Step2	Check fault codes.
	<ol style="list-style-type: none"> 1 Connect the scan tool to the diagnostic interface. 2 Turn the ignition switch to the on position. 3 Diagnose SRS module with diagnostic instrument. 4 Is there any other fault code except for B0095-49、B0095-87、B0095-86、B0095-56、?
	YES → Refer to: DTC Summary list (SRS) .
NO ↓	
Step3	Check the right impact sensor circuit supply circuit.
	<ol style="list-style-type: none"> 1 Turn off the ignition switch. 2 Disconnect the right impact sensor harness plug. 3 Turn on the ignition switch. 4 Measure the voltage between the right impact sensor harness terminal and ground. Measuring circuit: voltage between No.1 terminal of right impact sensor plug and ground. Standard value:4.8~5.2V 5 Check whether the result is normal or not?
	NO → Repair or replace parts with detected faults.
YES ↓	

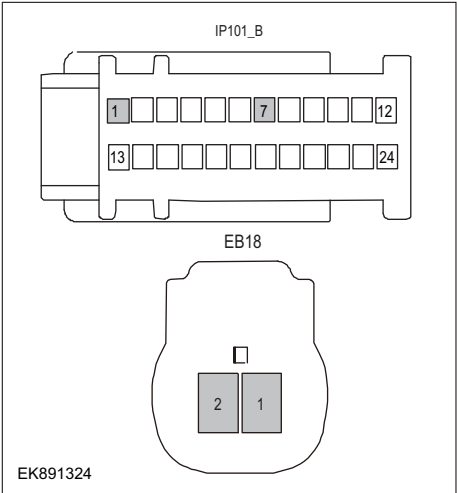
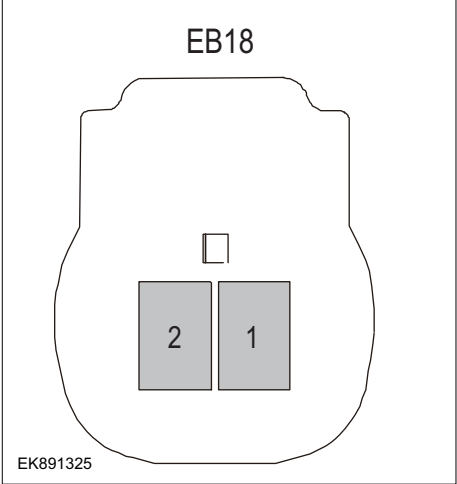
Step4	Check right impact sensor circuit (open circuit).
	<ol style="list-style-type: none"> 1 Turn off the ignition switch. 2 Disconnect SRS module harness plug. 3 Measure the resistance between the right impact sensor harness terminal and the SRS module harness terminal. Measuring circuit: resistance between No.1 terminal of right impact sensor plug and No.7 terminal of SRS module plug. Measuring circuit: resistance between terminal 2 of right impact sensor plug and terminal 1 of SRS module plug. Standard value: $\approx 0\Omega$ 4 Check whether the result is normal or not?
NO → Repair or replace parts with detected faults.	
YES ↓	
Step5	Check right impact sensor circuit (short circuit).
	<ol style="list-style-type: none"> 1 Turn off the ignition switch. 2 Measure the resistance between right impact sensor harness plug and ground. Measuring circuit: resistance between No.1 terminal of right impact sensor plug and ground. Measuring circuit: resistance between No.2 terminal of right impact sensor plug and ground. Standard value: infinite 3 Measure the voltage between right impact sensor harness plug and ground. Measuring circuit: voltage between terminal 2 of right impact sensor plug and ground. Standard value: $\approx 0V$ 4 Check whether the result is normal or not?
NO → Repair or replace parts with detected faults.	
YES ↓	

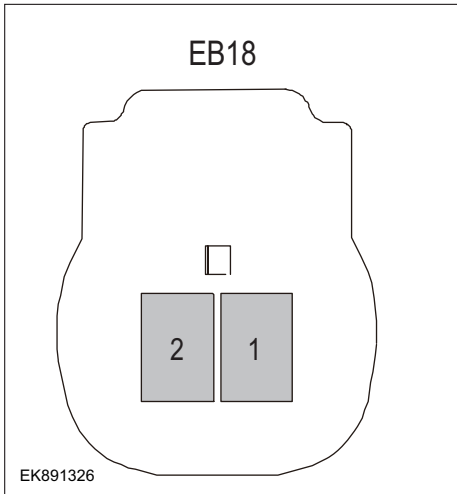
Step6	Check the right impact sensor (component inspection).
	<ol style="list-style-type: none"> 1 Directly measure the resistance of the terminal of the right impact sensor. Measuring circuit: resistance between terminal 1 and terminal 2 of right impact sensor plug. Standard value: 2 Measure the resistance between the terminal of the right impact sensor and the housing. Measuring circuit: resistance between No.1 terminal of right impact sensor plug and housing. Measuring circuit: resistance between No.2 terminal of right impact sensor plug and housing. Standard value:infinite 3 Check whether the result is normal or not?
<p>NO → Replace the right impact sensor.</p>	
<p>YES ↓</p>	
Step7	Check whether the SRS module is abnormal.
	<ol style="list-style-type: none"> 1 Turn off the ignition switch. 2 Disconnect and check SRS module harness plug. 3 Inspection and maintenance: <ul style="list-style-type: none"> • Corrosion (install new connectors or terminals-clean module pins). • Damaged or bent pins-Install new terminals/pins. • Pin flying out-install new pins as needed. 4 Reconnect the SRS module plug and all other previously disconnected plugs. Make sure that the pins are properly positioned and fixed. 5 Run the system and determine if the problem still exists?
<p>YES → Replace SRS .</p>	
<p>NO ↓</p>	
<p>At this time, the system works normally. The cause of the problem may be module connection. Address the root cause of any connector or pin problem.</p>	
<p>Next Step ↓</p>	
<p>Diagnosis is over.</p>	

B0091-49、 B0091-87、 B0091-86、 B0091-56

Fault diagnosis code
B0091-49: Left B-Pillar Side Satellite Sensor - Internal Fault
B0091-87: Left B-Pillar Side Satellite Sensor - Lost Communication
B0091-86: Left B-Pillar Side Satellite Sensor – transmitted data invalid
B0091-56: Left B-Pillar Side Satellite Sensor - Incompatible Configuration
Detection tools
1 Multimeter and diagnostic apparatus
Possible causes
<ul style="list-style-type: none"> • Circuit,terminal and adapting piece fault • SRS • Side impact sensor of left B-pillar
Conditions for fault code operation
Turn the ignition switch to the ON position
Conditions for fault code setting
B0091-49
Sensor internal electronic fault
B0091-87
The sensor detects a short circuit to the battery or a short circuit to GND one or more times during 200 ms. One or more sensor communication errors were detected during 200 ms
B0091-86
The sensor failed the offset test or the sensor failed the deflection test.
B0091-56
If RAS is not configured, but the sensor exists normally; Or if RAS is configured but physically disconnected; Or, if the RAS serial number does not match the sampling rate
To set the effect of a fault code condition
The airbag fault light is on, and it does not have the function of igniting the airbag.
Description of circuit diagram
The SRS module monitors the right impact sensor through the low reference circuit and the signal circuit.

Circuit diagram

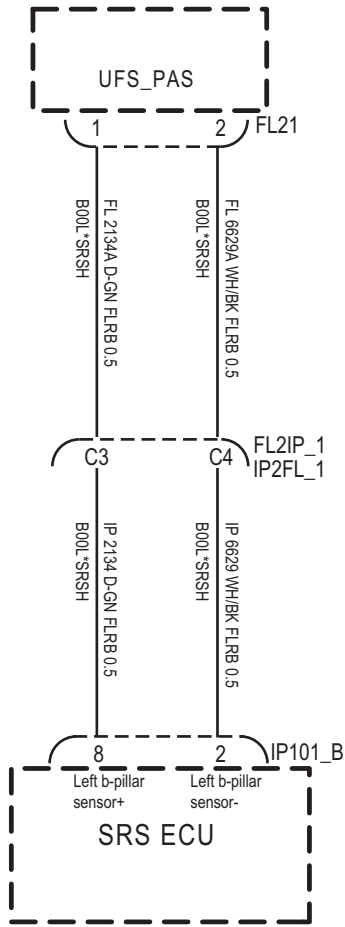

IP101_B

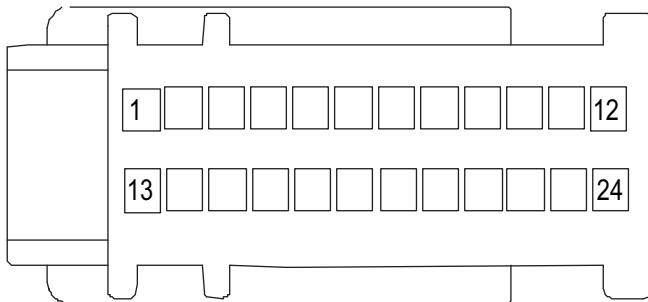

FL21

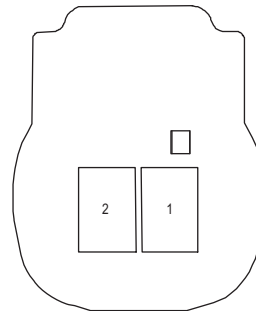

EK891327

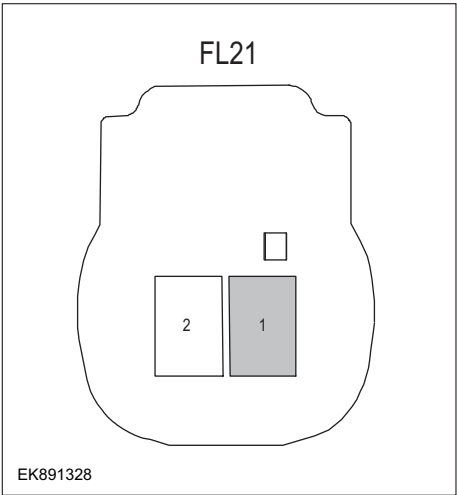
Troubleshooting steps	
Step1	General inspection.
	<ol style="list-style-type: none"> 1 Check fuse for damage. 2 Check battery capacity. 3 Check the left B-pillar side impact sensor and SRS module wiring harness plug for damage, poor contact, aging and looseness. 4 Check whether the result is normal or not?
NO → Repair or replace parts with detected faults.	
YES ↓	
Step2	Check fault codes.
	<ol style="list-style-type: none"> 1 Connect the scan tool to the diagnostic interface. 2 Turn the ignition switch to the on position. 3 Diagnose SRS module with diagnostic instrument. 4 Is there any other fault code except for B0091-49, B0091-87, B0091-86, B0091-56?
YES → Refer to: DTC Summary list (SRS) .	
NO ↓	
Step3	Check the power supply circuit of the left B-pillar side-impact sensor circuit.
	<ol style="list-style-type: none"> 1 Turn off the ignition switch. 2 Disconnect the left B-pillar side-impact sensor harness plug. 3 Turn on the ignition switch. 4 Measure the voltage between the harness terminal of the left B-pillar side-impact sensor and ground. Measuring circuit: voltage between No.1 terminal of left B-pillar side-impact sensor plug and ground. Standard value:4.8~5.2V 5 Check whether the result is normal or not?
NO → Repair or replace parts with detected faults.	
YES ↓	

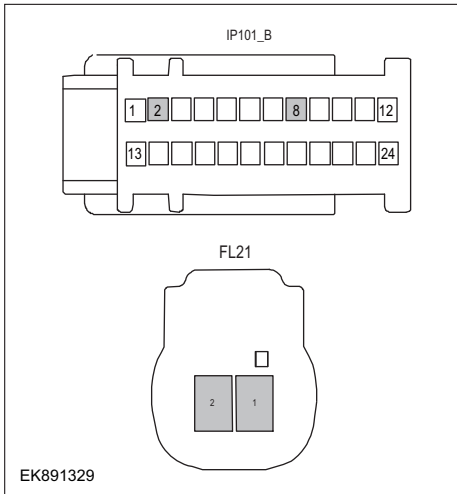
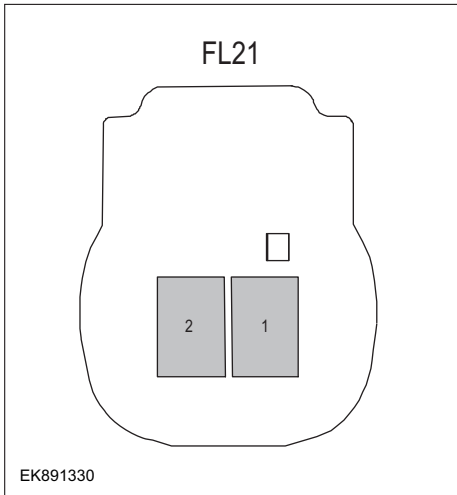
<p>Step4</p>	<p>Check left B-pillar side-impact sensor circuit (open circuit).</p>
 <p>IP101_B</p> <p>FL21</p> <p>EK891329</p>	<ol style="list-style-type: none"> 1 Turn off the ignition switch. 2 Disconnect SRS module harness plug. 3 Measure the resistance between the left B-pillar side-impact sensor harness terminal and SRS module harness terminal. Measuring circuit: resistance between terminal 1 of the left B-pillar side-impact sensor plug and terminal 8 of the SRS module plug. Measuring circuit: resistance between terminal 2 of the left B-pillar side-impact sensor plug and terminal 2 of the SRS module plug. Standard value: $\approx 0\Omega$ 4 Check whether the result is normal or not?
<p>NO → Repair or replace parts with detected faults.</p>	
<p>YES ↓</p>	
<p>Step5</p>	<p>Check left B-pillar side-impact sensor circuit (short circuit).</p>
 <p>FL21</p> <p>EK891330</p>	<ol style="list-style-type: none"> 1 Turn off the ignition switch. 2 Measure the resistance between the left B-pillar side-impact sensor harness plug and ground. Measuring circuit: resistance between No.1 terminal of left B-pillar side-impact sensor plug and ground. Measuring circuit: resistance between terminal 2 of left B-pillar side-impact sensor plug and ground. Standard value: infinite 3 Measure the voltage between the left B-pillar side-impact sensor harness plug and ground. Measuring circuit: voltage between terminal 2 of left B-pillar side-impact sensor plug and ground. Standard value: $\approx 0V$ 4 Check whether the result is normal or not?
<p>NO → Repair or replace parts with detected faults.</p>	
<p>YES ↓</p>	

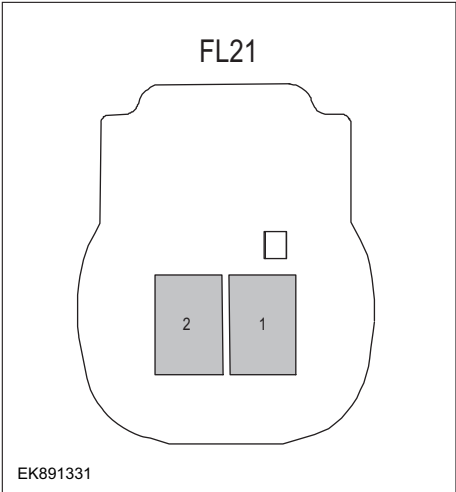
Step6	Check the left B-pillar side impact sensor (component inspection).
	<ol style="list-style-type: none"> 1 Directly measure the resistance of the left B-pillar against the sensor terminal. Measuring circuit: resistance between terminal 1 and terminal 2 of left B-pillar side-impact sensor plug. Standard value: 2 Measure the resistance between the left B-pillar side-impact sensor terminal and the housing. Measuring circuit: the resistance between the No.1 terminal of the left B-pillar side-impact sensor plug and the housing. Measuring circuit: the resistance between the No.2 terminal of the left B-pillar side-impact sensor plug and the housing. Standard value:infinite 3 Check whether the result is normal or not?
NO → Replace the left B-pillar side impact sensor.	
YES ↓	
Step7	Check whether the SRS module is abnormal.
	<ol style="list-style-type: none"> 1 Turn off the ignition switch. 2 Disconnect and check SRS module harness plug. 3 Inspection and maintenance: <ul style="list-style-type: none"> • Corrosion (install new connectors or terminals-clean module pins). • Damaged or bent pins-Install new terminals/pins. • Pin flying out-install new pins as needed. 4 Reconnect the SRS module plug and all other previously disconnected plugs. Make sure that the pins are properly positioned and fixed. 5 Run the system and determine if the problem still exists?
YES → Replace SRS .	
NO ↓	
At this time, the system works normally. The cause of the problem may be module connection. Address the root cause of any connector or pin problem.	
Next Step ↓	
Diagnosis is over.	

B0096-49、 B0096-87、 B0096-86、 B0096-56

Fault diagnosis code
B0096-49: Right B-Pillar Side Satellite Sensor - Internal Fault
B0096-87: Right B-Pillar Side Satellite Sensor - Lost Communication
B0096-86: Right B-Pillar Side Satellite Sensor – transmitted data invalid
B0096-56: Right Side Satellite Sensor - Incompatible Configuration
Detection tools
1 Multimeter and diagnostic apparatus
Possible causes
<ul style="list-style-type: none"> • Circuit, terminal and adapting piece fault • SRS • Right B-pillar side impact sensor
Conditions for fault code operation
Turn the ignition switch to the ON position
Conditions for fault code setting
B0096-49
Sensor internal electronic fault
B0096-87
The sensor detects a short circuit to the battery or a short circuit to GND one or more times during 200 ms. One or more sensor communication errors were detected during 200 ms
B0096-86
The sensor failed the offset test or the sensor failed the deflection test.
B0096-56
If RAS is not configured, but the sensor exists normally; Or if RAS is configured but physically disconnected; Or, if the RAS serial number does not match the sampling rate
To set the effect of a fault code condition
The airbag fault light is on, and it does not have the function of igniting the airbag.
Description of circuit diagram
The SRS module monitors the right impact sensor through the low reference circuit and the signal circuit.

Circuit diagram

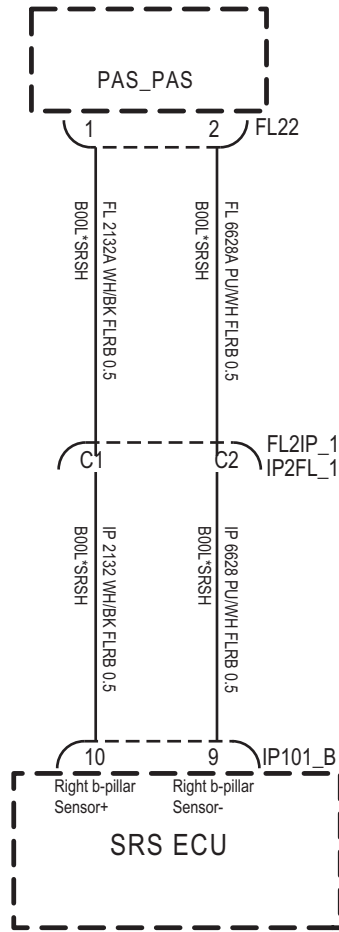

IP101_B

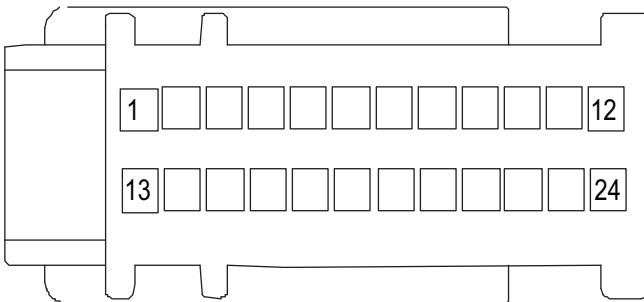

FL22

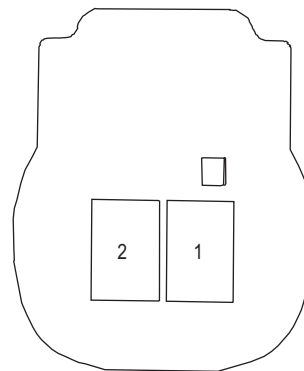

EK891332

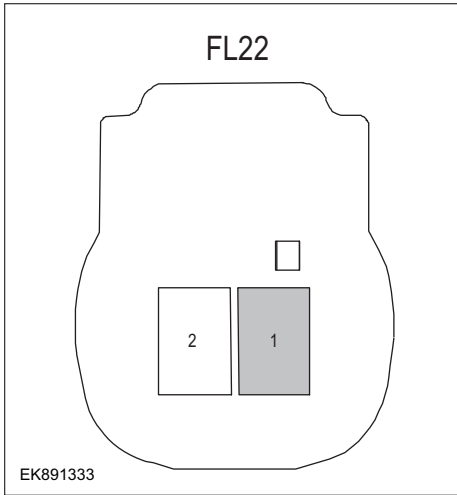
Troubleshooting steps	
Step1	General inspection.
	<ol style="list-style-type: none"> 1 Check fuse for damage. 2 Check battery capacity. 3 Check the right B-pillar side impact sensor and SRS module wiring harness plug for damage, poor contact, aging and looseness. 4 Check whether the result is normal or not?
NO → Repair or replace parts with detected faults.	
YES ↓	
Step2	Check fault codes.
	<ol style="list-style-type: none"> 1 Connect the scan tool to the diagnostic interface. 2 Turn the ignition switch to the on position. 3 Diagnose SRS module with diagnostic instrument. 4 Is there any other fault code except for B0096-49, B0096-87, B0096-86, B0096-56?
YES → Refer to: DTC Summary list (SRS) .	
NO ↓	
Step3	Check the power supply circuit of the right B-pillar side-impact sensor circuit.
	<ol style="list-style-type: none"> 1 Turn off the ignition switch. 2 Disconnect the right B-pillar side-impact sensor harness plug. 3 Turn on the ignition switch. 4 Measure the voltage between the right B-pillar side-impact sensor harness terminal and ground. Measuring circuit: voltage between No.1 terminal of right B-pillar side-impact sensor plug and ground. Standard value:4.8~5.2V 5 Check whether the result is normal or not?
NO → Repair or replace parts with detected faults.	
YES ↓	

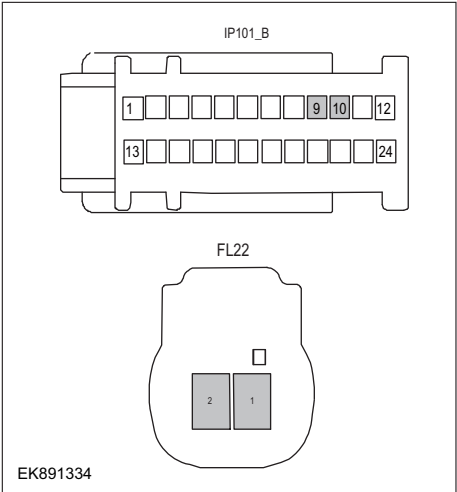
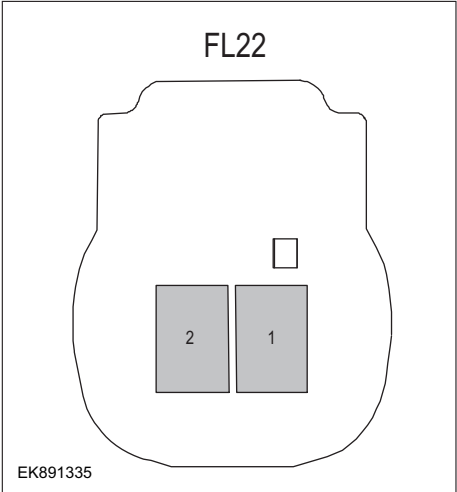
Step4	Check the right B-pillar side-impact sensor circuit (open circuit).
 <p>IP101_B</p> <p>FL22</p> <p>EK891334</p>	<ol style="list-style-type: none"> 1 Turn off the ignition switch. 2 Disconnect SRS module harness plug. 3 Measure the resistance between the right B-pillar side-impact sensor harness terminal and SRS module harness terminal. Measuring circuit: resistance between No.1 terminal of the right B-pillar side-impact sensor plug and No.10 terminal of SRS module plug. Measuring circuit: resistance between terminal 2 of the right B-pillar side-impact sensor plug and terminal 9 of the SRS module plug. <p>Standard value: $\approx 0\Omega$</p> <ol style="list-style-type: none"> 4 Check whether the result is normal or not?
NO → Repair or replace parts with detected faults.	
YES ↓	
Step5	Check the right B-pillar side-impact sensor circuit (short circuit).
 <p>FL22</p> <p>EK891335</p>	<ol style="list-style-type: none"> 1 Turn off the ignition switch. 2 Measure the resistance between the right B-pillar side-impact sensor harness plug and ground. Measuring circuit: resistance between No.1 terminal of right B-pillar side-impact sensor plug and ground. Measuring circuit: resistance between No.2 terminal of right B-pillar side-impact sensor plug and ground. <p>Standard value: infinite</p> <ol style="list-style-type: none"> 3 Measure the voltage between the right B-pillar side-impact sensor harness plug and ground. The voltage of. Measuring circuit: voltage between No.2 terminal of right B-pillar side-impact sensor plug and ground. <p>Standard value: $\approx 0V$</p> <ol style="list-style-type: none"> 4 Check whether the result is normal or not?
NO → Repair or replace parts with detected faults.	
YES ↓	

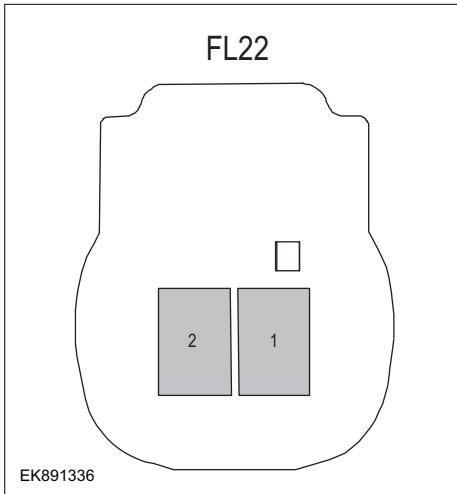
Step6	Check the right B-pillar side impact sensor (component inspection).
	<ol style="list-style-type: none"> 1 Directly measure the resistance of the right B-pillar against the sensor terminal. Measuring circuit: resistance between terminal 1 and terminal 2 of the right B-pillar side-impact sensor plug. Standard value: 2 Measure the resistance between the right B-pillar side-impact sensor terminal and the housing. Measuring circuit: the resistance between the No.1 terminal of the right B-pillar side-impact sensor plug and the housing. Measuring circuit: the resistance between the No.2 terminal of the right B-pillar side-impact sensor plug and the housing. Standard value:infinite 3 Check whether the result is normal or not?
NO → Replace the right B-pillar side impact sensor.	
YES ↓	
Step7	Check whether the SRS module is abnormal.
	<ol style="list-style-type: none"> 1 Turn off the ignition switch. 2 Disconnect and check SRS module harness plug. 3 Inspection and maintenance: <ul style="list-style-type: none"> • Corrosion (install new connectors or terminals-clean module pins). • Damaged or bent pins-Install new terminals/pins. • Pin flying out-install new pins as needed. 4 Reconnect the SRS module plug and all other previously disconnected plugs. Make sure that the pins are properly positioned and fixed. 5 Run the system and determine if the problem still exists?
YES → Replace SRS .	
NO ↓	
At this time, the system works normally. The cause of the problem may be module connection. Address the root cause of any connector or pin problem.	
Next Step ↓	
Diagnosis is over.	

B193A-14、 B193A-12

Fault diagnosis code
B193A-14: Hardwired Crash Out - Shorted to Ground or Open
B193A-12: Hardwired Crash Out - Shorted to Battery
Detection tools
1 Multimeter and diagnostic apparatus
Possible causes
<ul style="list-style-type: none"> • Circuit,terminal and adapting piece fault • SRS • Collision signal fault
Conditions for fault code operation
Turn the ignition switch to the ON position
Conditions for fault code setting
B193A-14
When the short-circuit resistance value is less than 1201 ohms, or when the external load is open, the fault may be detected when the short-circuit resistance value is less than 8886 ohms.
B193A-12
The fault is detected when the short-circuit resistance value is less than 21 ohms, and the fault may be detected when the short-circuit resistance value is less than 153 ohms.
To set the effect of a fault code condition
The airbag fault light is on, and it does not have the function of igniting the airbag.
Description of circuit diagram

Circuit diagram

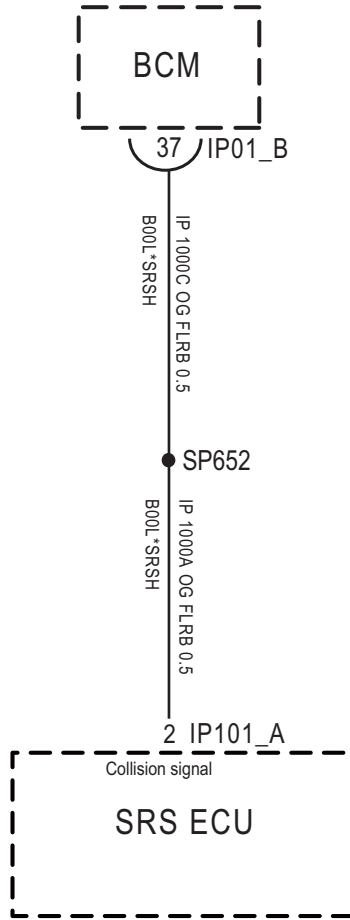

IP101_A

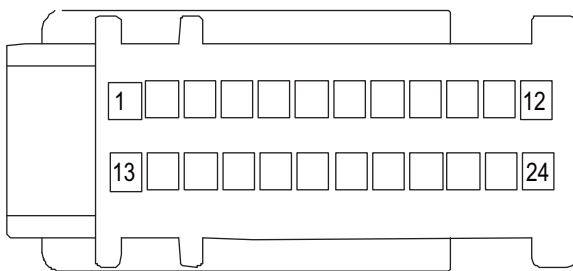

IP01_B

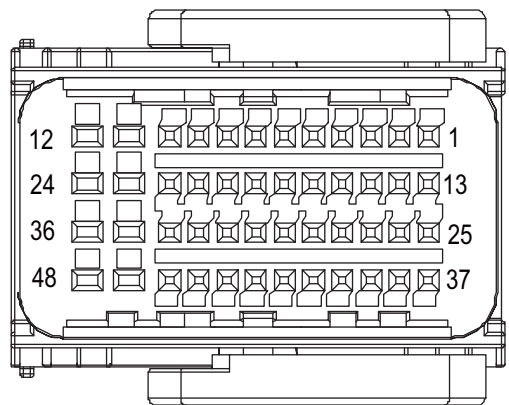

EK891337

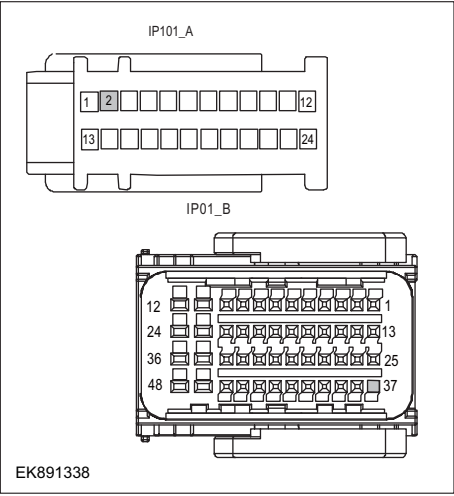
Troubleshooting steps	
Step1	General inspection.
	<ol style="list-style-type: none"> 1 Check fuse for damage. 2 Check battery capacity. 3 Check the right impact sensor and SRS module harness plug for damage, poor contact, aging and looseness. 4 Check whether the result is normal or not?
	NO → Repair or replace parts with detected faults.
YES ↓	
Step2	Check fault codes.
	<ol style="list-style-type: none"> 1 Connect the scan tool to the diagnostic interface. 2 Turn the ignition switch to the on position. 3 Diagnose SRS module with diagnostic instrument. 4 Is there any other fault code except for B193A-14, B193A-12?
	YES → Refer to: DTC Summary list (SRS) .
NO ↓	
Step3	Check hard wire collision output circuit (open circuit).
	<ol style="list-style-type: none"> 1 Turn off the ignition switch. 2 Disconnect SRS module harness plug. 3 Disconnect harness plug IP01_B of BCM module. 4 Measure the resistance between BCM module harness terminal and SRS module harness terminal. Measuring circuit: resistance between terminal 37 of IP01_B plug and terminal 2 of SRS module plug. Standard value: $\approx 0\Omega$ 5 Check whether the result is normal or not?
	NO → Repair or replace parts with detected faults.
YES ↓	

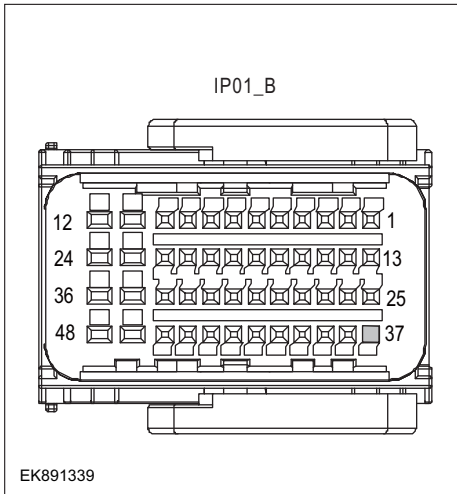
Step4	Check hard wire collision output circuit (short circuit).
	<ol style="list-style-type: none"> 1 Turn off the ignition switch. 2 Connect SRS module harness plug. 3 Measure the resistance between BCM module harness plug and ground. Measuring circuit: resistance between terminal 37 of IP01_B plug and ground. Standard value: infinite 4 Measure the voltage between BCM module harness plug and ground. Measuring circuit: voltage between terminal 37 of IP01_B plug and ground. Standard value: ≈ 0V 5 Check whether the result is normal or not?
NO → Repair or replace parts with detected faults.	
YES ↓	
Step5	Check whether the SRS module is abnormal.
	<ol style="list-style-type: none"> 1 Turn off the ignition switch. 2 Disconnect and check SRS module harness plug. 3 Inspection and maintenance: <ul style="list-style-type: none"> • Corrosion (install new connectors or terminals-clean module pins). • Damaged or bent pins-Install new terminals/pins. • Pin flying out-install new pins as needed. 4 Reconnect the SRS module plug and all other previously disconnected plugs. Make sure that the pins are properly positioned and fixed. 5 Run the system and determine if the problem still exists?
YES → Replace SRS .	
NO ↓	
At this time, the system works normally. The cause of the problem may be module connection. Address the root cause of any connector or pin problem.	
Next Step ↓	
Diagnosis is over.	

B0020-11、 B0020-12、 B0020-1A、 B0020-1B、 B0020-56

Fault diagnosis code
B0020-11: Left Hand Side Airbag -Short to GND
B0020-12: Left Hand Side Airbag -Short to Battery
B0020-1A: Left Hand Side Airbag - Resistance too Low
B0020-1B: Left Hand Side Airbag - Resistance too High
B0020-56: Left Hand Side Airbag - Incompatible Configuration
Detection tools
1 Multimeter and diagnostic apparatus
Possible causes
<ul style="list-style-type: none"> • Circuit,terminal and adapting piece fault • SRS • Left side airbag
Conditions for fault code operation
Turn the ignition switch to the ON position
Conditions for fault code setting
B0020-11
Left airbag circuit has leakage resistance to ground.
B0020-12
The left airbag circuit has leakage resistance to the battery.
B0020-1A
The resistance of the initiation circuit is lower than the threshold. The detection resistance of the left airbag is in any of the following ranges: (Gray area) (gray area) $0.9 < R < 1.8$ (Guaranteed) (guaranteed area) $R < 0.9$ "
B0020-1B
The resistance of the initiation circuit is higher than the threshold. The detection resistance of the left airbag is in any of the following ranges: (Gray area) (gray area) $2.4 < R < 5.8$ (Guaranteed) (guaranteed area) $5.8 < R$ "
B0020-56
The initiation circuit is not configured, and it is detected that the initiation circuit is normal within 6 seconds after power-on, or the initiation circuit is short-circuited to storage battery, ground or output.
To set the effect of a fault code condition
The airbag fault light is on, and it does not have the function of igniting the airbag.
Description of circuit diagram
The SRS module monitors the right impact sensor through the low reference circuit and the signal circuit.

Circuit diagram

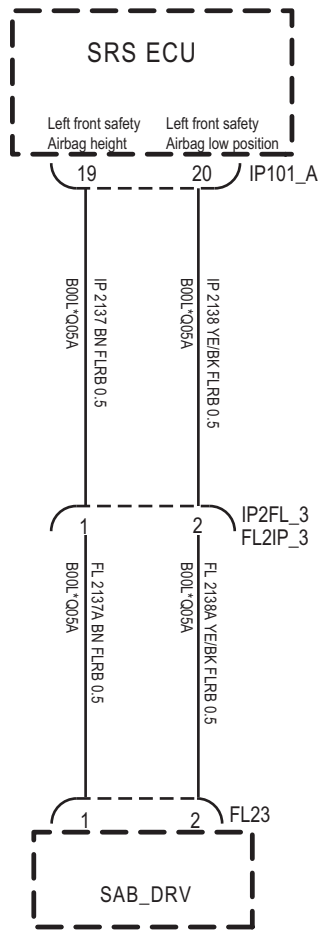

IP101_A

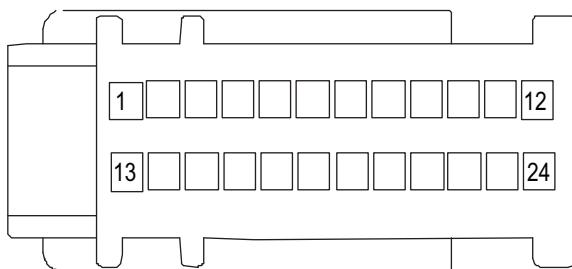

FL23

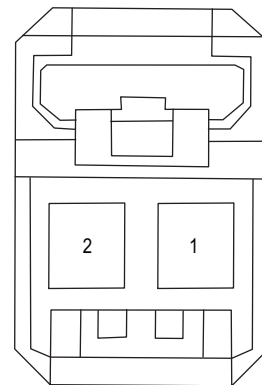

EK891340

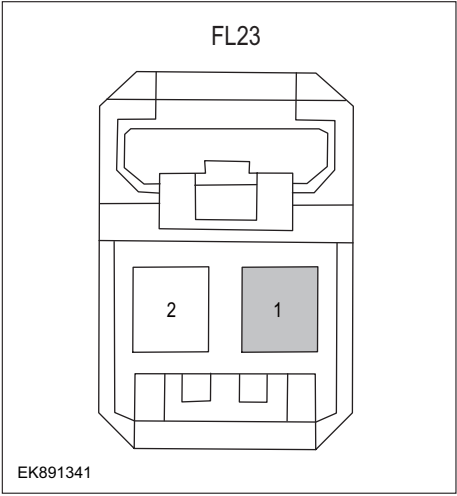
Troubleshooting steps	
Step1	General inspection.
	<ol style="list-style-type: none"> 1 Check fuse for damage. 2 Check battery capacity. 3 Check the left airbag and SRS module harness plug for damage, poor contact, aging and looseness. 4 Check whether the result is normal or not?
NO → Repair or replace parts with detected faults.	
YES ↓	
Step2	Check fault codes.
	<ol style="list-style-type: none"> 1 Connect the scan tool to the diagnostic interface. 2 Turn the ignition switch to the on position. 3 Diagnose SRS module with diagnostic instrument. 4 Is there any other fault code except for B0020-11、B0020-12、B0020-1A、B0020-1B、B0020-56?
YES → Refer to: DTC Summary list (SRS) .	
NO ↓	
Step3	Check the power supply circuit of the left airbag circuit.
	<ol style="list-style-type: none"> 1 Turn off the ignition switch. 2 Disconnect the left airbag harness plug. 3 Turn on the ignition switch. 4 Measure the voltage between the left airbag harness terminal and ground. Measuring circuit: voltage between terminal 1 of left airbag plug and ground. Standard value:4.8~5.2V 5 Check whether the result is normal or not?
NO → Repair or replace parts with detected faults.	
YES ↓	

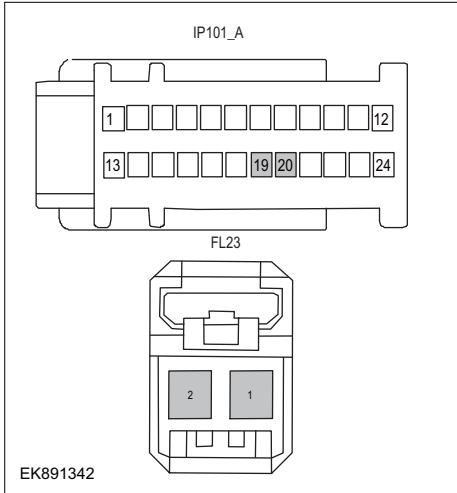
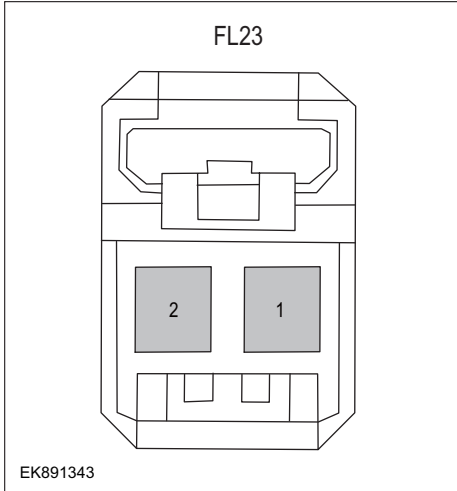
Step4	Check left airbag circuit (open circuit).
 <p>IP101_A</p> <p>FL23</p> <p>EK891342</p>	<ol style="list-style-type: none"> 1 Turn off the ignition switch. 2 Disconnect SRS module harness plug. 3 Measure the resistance between the left airbag harness terminal and the SRS module harness terminal. Measuring circuit: resistance between terminal 1 of left airbag plug and terminal 19 of SRS module plug. Measuring circuit: resistance between terminal 2 of left airbag plug and terminal 20 of SRS module plug. Standard value: $\approx 0\Omega$ 4 Check whether the result is normal or not?
NO → Repair or replace parts with detected faults.	
YES ↓	
Step5	Check left airbag circuit (short circuit).
 <p>FL23</p> <p>EK891343</p>	<ol style="list-style-type: none"> 1 Turn off the ignition switch. 2 Measure the resistance between left airbag harness plug and ground. Measuring circuit: resistance between terminal 1 of left airbag plug and ground. Measuring circuit: resistance between terminal 2 of left airbag plug and ground. Standard value: infinite 3 Measure the voltage between left airbag harness plug and ground. Measuring circuit: voltage between terminal 2 of left airbag harness plug and ground. Standard value: $\approx 0V$ 4 Check whether the result is normal or not?
NO → Repair or replace parts with detected faults.	
YES ↓	

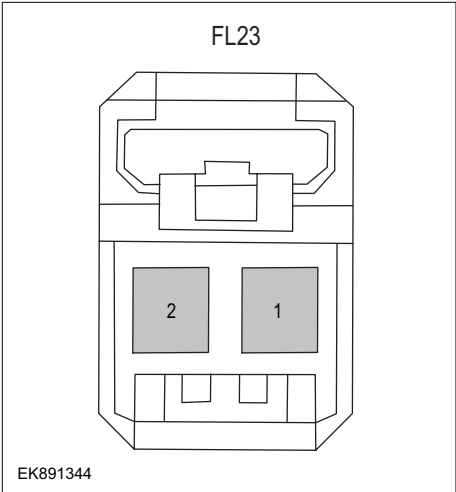
Step6	Check the left side airbag (component inspection).
	<ol style="list-style-type: none"> 1 Directly measure the resistance of the left airbag terminal. Measuring circuit: resistance between terminal 1 and terminal 2 of left airbag plug. Standard value: 2 Measure the resistance between the left airbag terminal and the housing. Measuring circuit: resistance between terminal 1 of left airbag plug and housing. Measuring circuit: resistance between terminal 2 of left airbag plug and housing. Standard value:infinite 3 Check whether the result is normal or not?
NO → Replace the left airbag.	
YES ↓	
Step7	Check whether the SRS module is abnormal.
	<ol style="list-style-type: none"> 1 Turn off the ignition switch. 2 Disconnect and check SRS module harness plug. 3 Inspection and maintenance: <ul style="list-style-type: none"> • Corrosion (install new connectors or terminals-clean module pins). • Damaged or bent pins-Install new terminals/pins. • Pin flying out-install new pins as needed. 4 Reconnect the SRS module plug and all other previously disconnected plugs. Make sure that the pins are properly positioned and fixed. 5 Run the system and determine if the problem still exists?
YES → Replace SRS .	
NO ↓	
At this time, the system works normally. The cause of the problem may be module connection. Address the root cause of any connector or pin problem.	
Next Step ↓	
Diagnosis is over.	

B0028-11、 B0028-12、 B0028-1A、 B0028-1B、 B0028-56

Fault diagnosis code
B0028-11: Right Hand Side Airbag -Short to GND
B0028-12: Right Hand Side Airbag -Short to Battery
B0028-1A: Right Hand Side Airbag - Resistance too Low
B0028-1B: Right Hand Side Airbag - Resistance too High
B0028-56: Right Hand Side Airbag - Incompatible Configuration
Detection tools
1 Multimeter and diagnostic apparatus
Possible causes
<ul style="list-style-type: none"> • Circuit,terminal and adapting piece fault • SRS • Right side airbag
Conditions for fault code operation
Turn the ignition switch to the ON position
Conditions for fault code setting
B0028-11
Right airbag circuit short circuit to ground
B0028-12
Right airbag circuit short circuit to battery
B0028-1A
The resistance of the initiation circuit is lower than the threshold. Right side airbag detection resistance is in any of the following ranges: (Gray area) (gray area) $0.9 < R < 1.8$ (Guaranteed) (guaranteed area) $R < 0.9$ "
B0028-1B
The resistance of the initiation circuit is higher than the threshold. Right side airbag detection resistance is in any of the following ranges: (Gray area) (gray area) $2.4 < R < 5.8$ (Guaranteed) (guaranteed area) $5.8 < R$ "
B0028-56
The initiation circuit is not configured, and it is detected that the initiation circuit is normal within 6 seconds after power-on, or the initiation circuit is short-circuited to storage battery, ground or output.
To set the effect of a fault code condition
The airbag fault light is on, and it does not have the function of igniting the airbag.
Description of circuit diagram
The SRS module monitors the right impact sensor through the low reference circuit and the signal circuit.

Circuit diagram

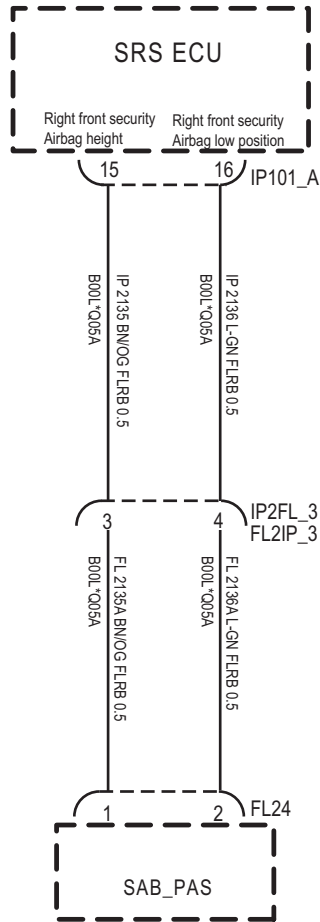

IP101_A

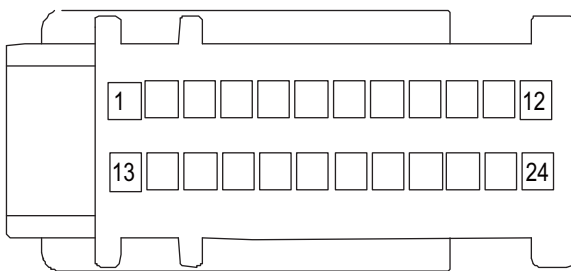

FL24

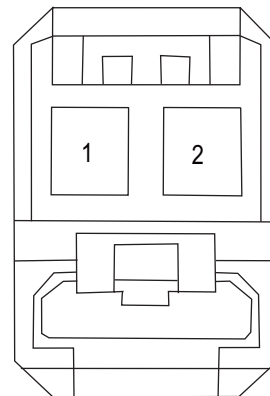

EK891345

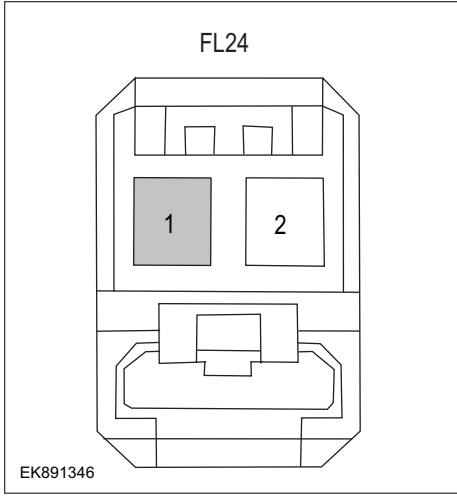
Troubleshooting steps	
Step1	General inspection.
	<ol style="list-style-type: none"> 1 Check fuse for damage. 2 Check battery capacity. 3 Check the right airbag and SRS module harness plug for damage, poor contact, aging and looseness. 4 Check whether the result is normal or not?
NO → Repair or replace parts with detected faults.	
YES ↓	
Step2	Check fault codes.
	<ol style="list-style-type: none"> 1 Connect the scan tool to the diagnostic interface. 2 Turn the ignition switch to the on position. 3 Diagnose SRS module with diagnostic instrument. 4 Is there any other fault code except for B0028-11、B0028-12、B0028-1A、B0028-1B、B0028-56?
YES → Refer to: DTC Summary list (SRS) .	
NO ↓	
Step3	Check the power supply circuit of the right side airbag circuit.
	<ol style="list-style-type: none"> 1 Turn off the ignition switch. 2 Disconnect the right airbag harness plug. 3 Turn on the ignition switch. 4 Measure the voltage between the right airbag harness terminal and ground. Measuring circuit: voltage between No.1 terminal of right airbag plug and ground. Standard value:4.8~5.2V 5 Check whether the result is normal or not?
NO → Repair or replace parts with detected faults.	
YES ↓	

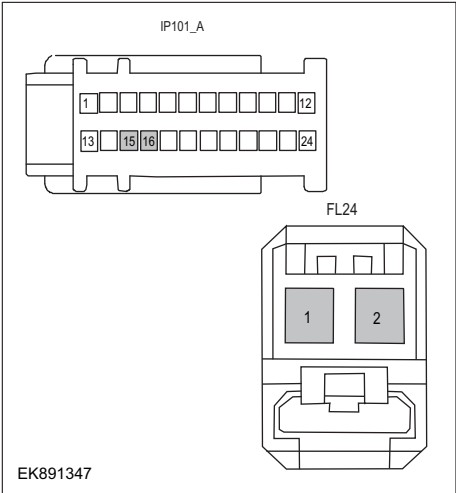
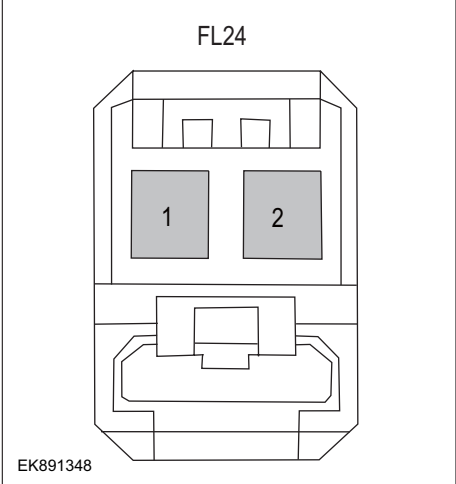
Step4	Check the right airbag circuit (open circuit).
 <p>IP101_A</p> <p>FL24</p> <p>EK891347</p>	<ol style="list-style-type: none"> 1 Turn off the ignition switch. 2 Disconnect SRS module harness plug. 3 Measure the resistance between the right airbag harness terminal and the SRS module harness terminal. Measuring circuit: resistance between No.1 terminal of right airbag plug and No.15 terminal of SRS module plug. Measuring circuit: resistance between terminal 2 of right airbag plug and terminal 16 of SRS module plug. Standard value: $\approx 0\Omega$ 4 Check whether the result is normal or not?
NO → Repair or replace parts with detected faults.	
YES ↓	
Step5	Check right side airbag circuit (short circuit).
 <p>FL24</p> <p>EK891348</p>	<ol style="list-style-type: none"> 1 Turn off the ignition switch. 2 Measure the resistance between right airbag harness plug and ground. Measuring circuit: resistance between No.1 terminal of right airbag plug and ground. Measurement circuit: resistance between terminal 2 of right airbag plug and ground. Standard value: infinite 3 Measure the voltage between right airbag harness plug and ground. Measuring circuit: voltage between No.2 terminal of right airbag harness plug and ground. Standard value: $\approx 0V$ 4 Check whether the result is normal or not?
NO → Repair or replace parts with detected faults.	
YES ↓	

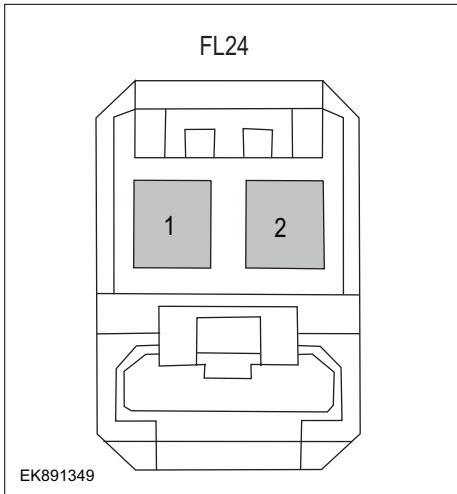
Step6	Check the right side airbag (component inspection).
	<ol style="list-style-type: none"> 1 Directly measure the resistance of the right airbag terminal. Measuring circuit: resistance between terminal 1 and terminal 2 of right airbag plug. Standard value: 2 Measure the resistance between the right airbag terminal and the housing. Measuring circuit: resistance between No.1 terminal of right airbag plug and housing. Measuring circuit: resistance between No.2 terminal of right airbag plug and housing. Standard value:infinite 3 Check whether the result is normal or not?
NO → Replace the right side airbag.	
YES ↓	
Step7	Check whether the SRS module is abnormal.
	<ol style="list-style-type: none"> 1 Turn off the ignition switch. 2 Disconnect and check SRS module harness plug. 3 Inspection and maintenance: <ul style="list-style-type: none"> • Corrosion (install new connectors or terminals-clean module pins). • Damaged or bent pins-Install new terminals/pins. • Pin flying out-install new pins as needed. 4 Reconnect the SRS module plug and all other previously disconnected plugs. Make sure that the pins are properly positioned and fixed. 5 Run the system and determine if the problem still exists?
YES → Replace SRS .	
NO ↓	
At this time, the system works normally. The cause of the problem may be module connection. Address the root cause of any connector or pin problem.	
Next Step ↓	
Diagnosis is over.	

B0021-11、 B0021-12、 B0021-1A、 B0021-1B、 B0021-56

Fault diagnosis code
B0021-11: Left Hand Curtain Airbag -Short to GND
B0021-12: Left Hand Curtain Airbag -Short to Battery
B0021-1A: Left Hand Curtain Airbag - Resistance too Low
B0021-1B: Left Hand Curtain Airbag - Resistance too High
B0021-56: Left Hand Curtain Airbag - Incompatible Configuration
Detection tools
1 Multimeter and diagnostic apparatus
Possible causes
<ul style="list-style-type: none"> • Circuit,terminal and adapting piece fault • SRS • Left air curtain
Conditions for fault code operation
Turn the ignition switch to the ON position
Conditions for fault code setting
B0021-11
Left air curtain loop short circuit to ground.
B0021-12
Left air curtain loop short circuit to battery.
B0021-1A
The resistance of the initiation circuit is lower than the threshold. The detection resistance of the left air curtain is in any of the following ranges: (Gray area) (gray area) $0.9 < R < 1.8$ (Guaranteed) (guaranteed area) $R < 0.9$ "
B0021-1B
The resistance of the initiation circuit is higher than the threshold. The detection resistance of the left air curtain is in any of the following ranges: (Gray area) (gray area) $2.4 < R < 5.8$ (Guaranteed) (guaranteed area) $5.8 < R$ "
B0021-56
The initiation circuit is not configured, and it is detected that the initiation circuit is normal within 6 seconds after power-on, or the initiation circuit is short-circuited to storage battery, ground or output.
To set the effect of a fault code condition
The airbag fault light is on, and it does not have the function of igniting the airbag.
Description of circuit diagram
The SRS module monitors the right impact sensor through the low reference circuit and the signal circuit.

Circuit diagram

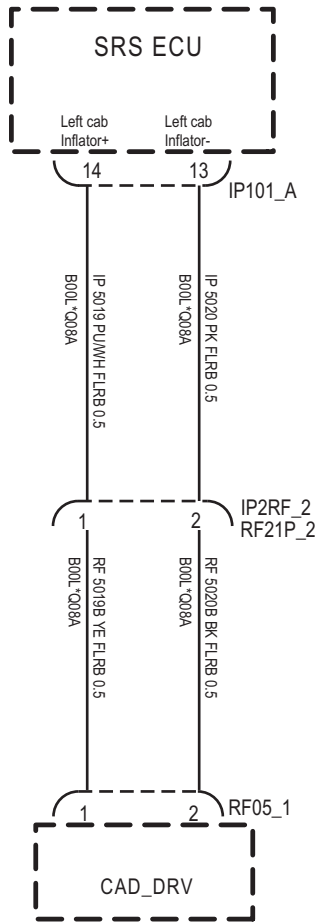

IP101_A

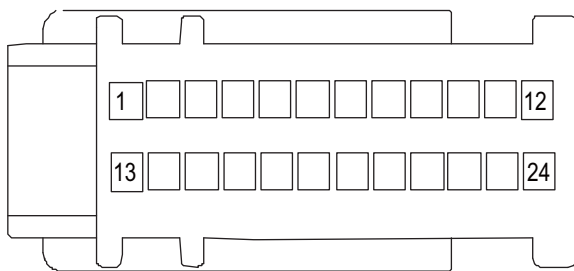

RF05_1

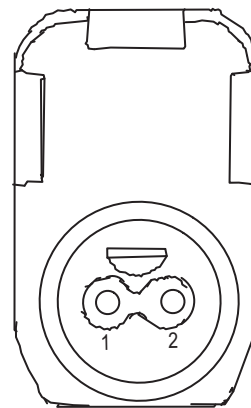

EK891350

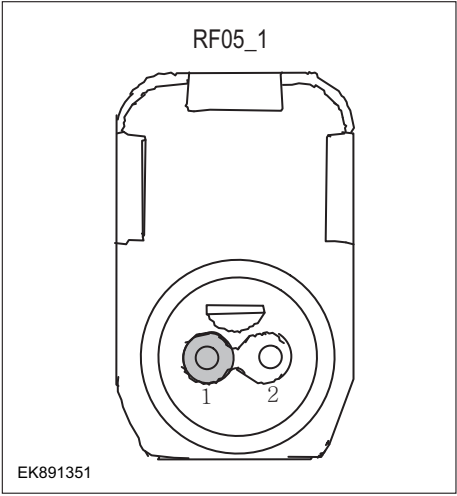
Troubleshooting steps	
Step1	General inspection.
	<ol style="list-style-type: none"> 1 Check fuse for damage. 2 Check battery capacity. 3 Check the left air curtain and SRS module harness plug for damage, poor contact, aging and looseness. 4 Check whether the result is normal or not?
NO → Repair or replace parts with detected faults.	
YES ↓	
Step2	Check fault codes.
	<ol style="list-style-type: none"> 1 Connect the scan tool to the diagnostic interface. 2 Turn the ignitiON switch to the on position. 3 Diagnose SRS module with diagnostic instrument. 4 Is there any other fault code except for B0021-11、 B0021-12、 B0021-1A、 B0021-1B、 B0021-56?
YES → Refer to: DTC Summary list (SRS) .	
NO ↓	
Step3	Check the supply circuit of the left air curtain circuit.
	<ol style="list-style-type: none"> 1 Turn off the ignition switch. 2 Disconnect the left air curtain harness plug. 3 Turn on the ignition switch. 4 Measure the voltage between the left air curtain harness terminal and ground. Measuring circuit: voltage between terminal 1 of left air curtain plug and ground. Standard value:4.8~5.2V 5 Check whether the result is normal or not?
NO → Repair or replace parts with detected faults.	
YES ↓	

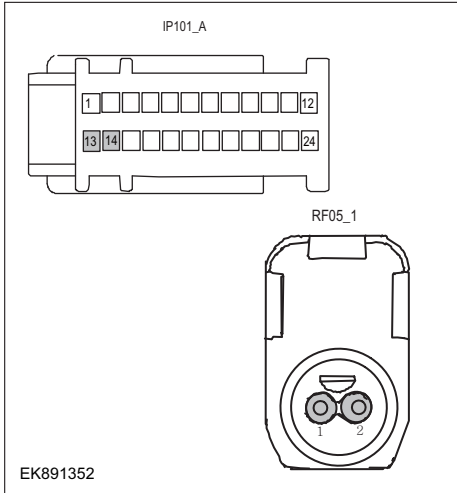
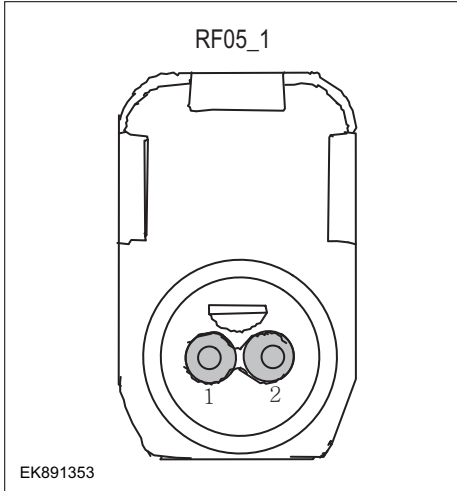
Step4	Check left air curtain circuit (open circuit).
	<ol style="list-style-type: none"> 1 Turn off the ignition switch. 2 Disconnect SRS module harness plug. 3 Measure the resistance between the left air curtain harness terminal and the SRS module harness terminal. Measuring circuit: resistance between terminal 1 of left air curtain plug and terminal 14 of SRS module plug. Measuring circuit: resistance between terminal 2 of left air curtain plug and terminal 13 of SRS module plug. Standard value: $\approx 0\Omega$ 4 Check whether the result is normal or not?
NO → Repair or replace parts with detected faults.	
YES ↓	
Step5	Check the left air curtain (short circuit).
	<ol style="list-style-type: none"> 1 Turn off the ignition switch. 2 Measure the resistance between left air curtain harness plug and ground. Measuring circuit: resistance between terminal 1 of left air curtain harness plug and ground. Measuring circuit: resistance between terminal 2 of left air curtain harness plug and ground. Standard value: infinite 3 Measure the voltage between left air curtain harness plug and ground. Measuring circuit: voltage between terminal 2 of left air curtain harness plug and ground. Standard value: $\approx 0V$ 4 Check whether the result is normal or not?
NO → Repair or replace parts with detected faults.	
YES ↓	

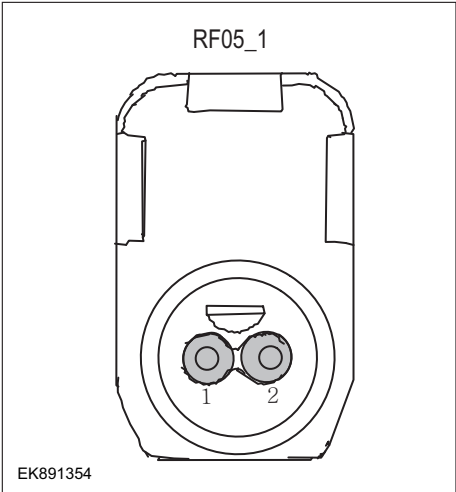
Step6	Check the left air curtain (component inspection).
	<ol style="list-style-type: none"> 1 Directly measure the resistance of the left air curtain terminal. Measuring circuit: resistance between terminal 1 and terminal 2 of left air curtain plug. Standard value: 2 Measure the resistance between the left air curtain terminal and the housing. Measuring circuit: resistance between terminal 1 of left air curtain plug and housing. Measuring circuit: resistance between terminal 2 of left air curtain plug and housing. Standard value:infinite 3 Check whether the result is normal or not?
<p>NO → Replace the left air curtain.</p>	
<p>YES ↓</p>	
Step7	Check whether the SRS module is abnormal.
	<ol style="list-style-type: none"> 1 Turn off the ignition switch. 2 Disconnect and check SRS module harness plug. 3 Inspection and maintenance: <ul style="list-style-type: none"> • Corrosion (install new connectors or terminals-clean module pins). • Damaged or bent pins-Install new terminals/pins. • Pin flying out-install new pins as needed. 4 Reconnect the SRS module plug and all other previously disconnected plugs. Make sure that the pins are properly positioned and fixed. 5 Run the system and determine if the problem still exists?
<p>YES → Replace SRS .</p>	
<p>NO ↓</p>	
<p>At this time, the system works normally. The cause of the problem may be module connection. Address the root cause of any connector or pin problem.</p>	
<p>Next Step ↓</p>	
<p>Diagnosis is over.</p>	

B0029-11、 B0029-12、 B0029-1A、 B0029-1B、 B0029-56

Fault diagnosis code
B0029-11: Right Hand Curtain Airbag -Short to GND
B0029-12: Right Hand Curtain Airbag -Short to Battery
B0029-1A: Right Hand Curtain Airbag - Resistance too Low
B0029-1B: Right Hand Curtain Airbag - Resistance too High
B0029-56: Right Hand Curtain Airbag - Incompatible Configuration
Detection tools
1 Multimeter and diagnostic apparatus
Possible causes
<ul style="list-style-type: none"> • Circuit,terminal and adapting piece fault • SRS • Right air curtain
Conditions for fault code operation
Turn the ignition switch to the ON position
Conditions for fault code setting
B0029-11
Right air curtain loop short circuit to ground.
B0029-12
Right air curtain loop short circuit to battery.
B0029-1A
The resistance of the initiation circuit is lower than the threshold. Right air curtain detection resistance is in any of the following ranges: (Gray area) (gray area) $0.9 < R < 1.8$ (Guaranteed) (guaranteed area) $R < 0.9$ "
B0029-1B
The resistance of the initiation circuit is higher than the threshold. Right air curtain detection resistance is in any of the following ranges: (Gray area) (gray area) $2.4 < R < 5.8$ (Guaranteed) (guaranteed area) $5.8 < R$ "
B0029-56
The initiation circuit is not configured, and it is detected that the initiation circuit is normal within 6 seconds after power-on, or the initiation circuit is short-circuited to storage battery, ground or output.
To set the effect of a fault code condition
The airbag fault light is on, and it does not have the function of igniting the airbag.
Description of circuit diagram
The SRS module monitors the right impact sensor through the low reference circuit and the signal circuit.

Circuit diagram

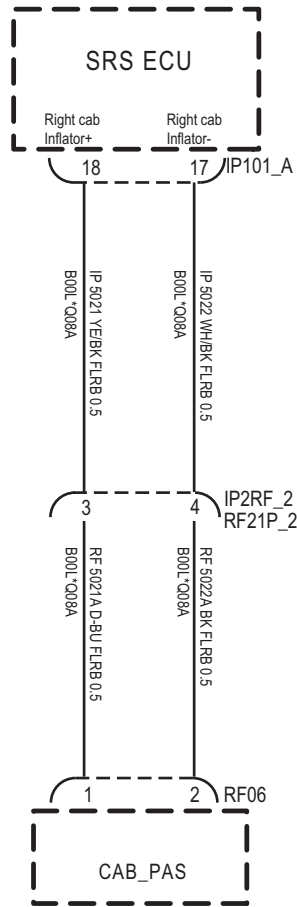

IP101_A

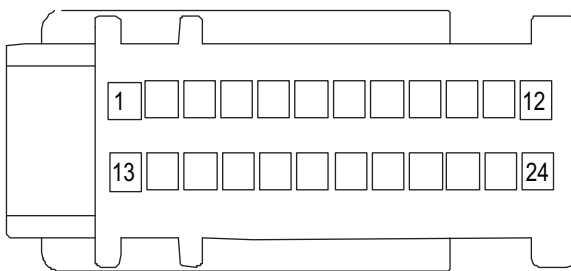

RF06

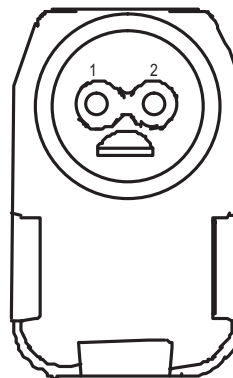

EK891355

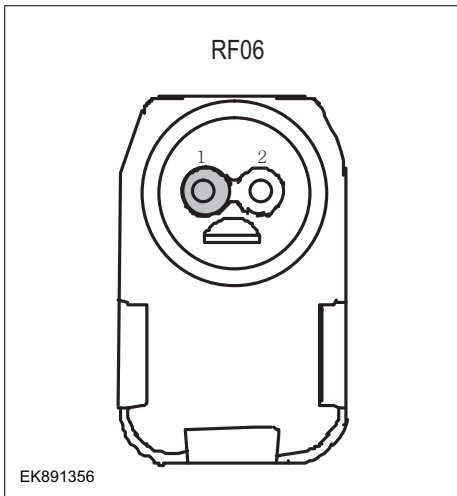
Troubleshooting steps	
Step1	General inspection.
	<ol style="list-style-type: none"> 1 Check fuse for damage. 2 Check battery capacity. 3 Check the right air curtain and SRS module harness plug for damage, poor contact, aging and looseness. 4 Check whether the result is normal or not?
NO → Repair or replace parts with detected faults.	
YES ↓	
Step2	Check fault codes.
	<ol style="list-style-type: none"> 1 Connect the scan tool to the diagnostic interface. 2 Turn the ignition switch to the on position. 3 Diagnose SRS module with diagnostic instrument. 4 Is there any other fault code except for B0029-11、B0029-12、B0029-1A、B0029-1B、B0029-56?
YES → Refer to: DTC Summary list (SRS) .	
NO ↓	
Step3	Check the right air curtain circuit power supply circuit.
	<ol style="list-style-type: none"> 1 Turn off the ignition switch. 2 Disconnect the right air curtain harness plug. 3 Turn on the ignition switch. 4 Measure the voltage between the right air curtain harness terminal and ground. Measuring circuit: voltage between No.1 terminal of right air curtain plug and ground. Standard value:4.8~5.2V 5 Check whether the result is normal or not?
NO → Repair or replace parts with detected faults.	
YES ↓	

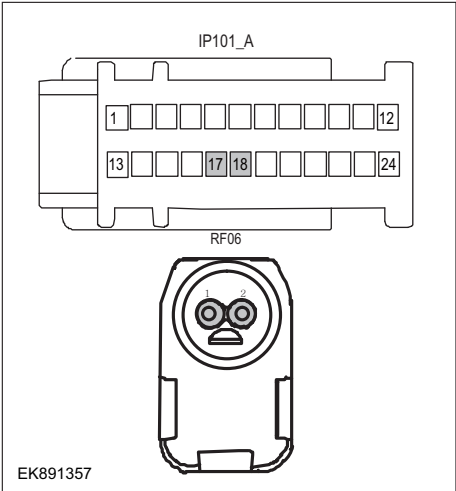
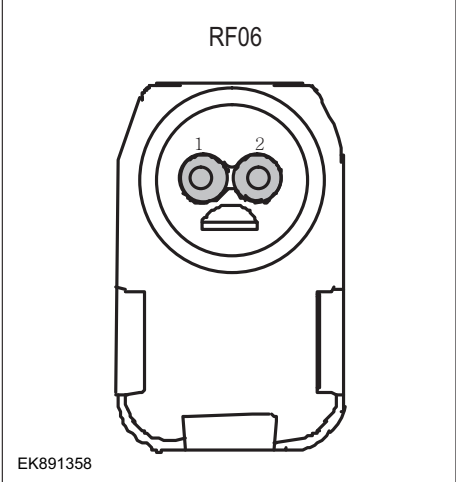
Step4	Check the right air curtain circuit (open circuit).
 <p>IP101_A</p> <p>RF06</p> <p>EK891357</p>	<ol style="list-style-type: none"> 1 Turn off the ignition switch. 2 Disconnect SRS module harness plug. 3 Measure the resistance between the right air curtain harness terminal and the SRS module harness terminal. Measuring circuit: resistance between No.1 terminal of right air curtain plug and No.18 terminal of SRS module plug. Measuring circuit: resistance between terminal 2 of right air curtain plug and terminal 17 of SRS module plug. Standard value: $\approx 0\Omega$ 4 Check whether the result is normal or not?
NO → Repair or replace parts with detected faults.	
YES ↓	
Step5	Check the right air curtain (short circuit).
 <p>RF06</p> <p>EK891358</p>	<ol style="list-style-type: none"> 1 Turn off the ignition switch. 2 Measure the resistance between plug of right air curtain harness and ground. Measuring circuit: resistance between No.1 terminal of right air curtain harness plug and ground. Measuring circuit: resistance between No.2 terminal of right air curtain harness plug and ground. Standard value: infinite 3 Measure the voltage between plug of right air curtain harness and ground. Measuring circuit: voltage between terminal 2 of plug of right air curtain harness and ground. Standard value: $\approx 0V$ 4 Check whether the result is normal or not?
NO → Repair or replace parts with detected faults.	
YES ↓	

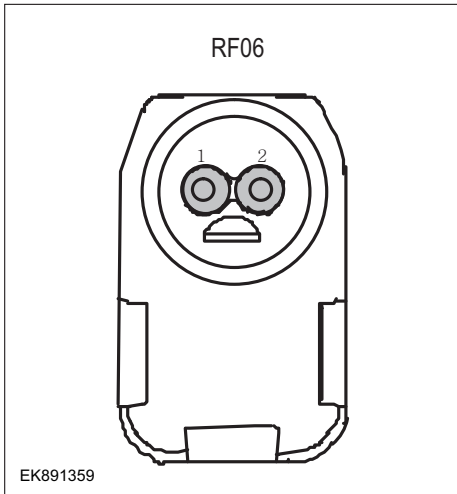
Step6	Check the right air curtain (component inspection).
	<ol style="list-style-type: none"> 1 Directly measure the resistance of the right air curtain terminal. Measuring circuit: resistance between terminal 1 and terminal 2 of right air curtain plug. Standard value: 2 Measure the resistance between the right air curtain terminal and the housing. Measuring circuit: resistance between No.1 terminal of right air curtain plug and housing. Measuring circuit: resistance between No.2 terminal of right air curtain plug and housing. Standard value:infinite 3 Check whether the result is normal or not?
<p>NO → Replace the right air curtain.</p>	
<p>YES ↓</p>	
Step7	Check whether the SRS module is abnormal.
	<ol style="list-style-type: none"> 1 Turn off the ignition switch. 2 Disconnect and check SRS module harness plug. 3 Inspection and maintenance: <ul style="list-style-type: none"> • Corrosion (install new connectors or terminals-clean module pins). • Damaged or bent pins-Install new terminals/pins. • Pin flying out-install new pins as needed. 4 Reconnect the SRS module plug and all other previously disconnected plugs. Make sure that the pins are properly positioned and fixed. 5 Run the system and determine if the problem still exists?
<p>YES → Replace SRS .</p>	
<p>NO ↓</p>	
<p>At this time, the system works normally. The cause of the problem may be module connection. Address the root cause of any connector or pin problem.</p>	
<p>Next Step ↓</p>	
<p>Diagnosis is over.</p>	

B0050-12

Fault diagnosis code
B0050-12: Driver Buckle Switch Shorted to Battery
Detection tools
1 Multimeter and diagnostic apparatus
Possible causes
<ul style="list-style-type: none">• Circuit, terminal and adapting piece fault• SRS• Driver's seat belt mortise lock
Conditions for fault code operation
Turn the ignition switch to the ON position
Conditions for fault code setting
B0050-12
Driver's seat belt latch has a short circuit to the battery.
To set the effect of a fault code condition
The airbag fault light is on, and it does not have the function of igniting the airbag.
Description of circuit diagram
The SRS module monitors the right impact sensor through the low reference circuit and the signal circuit.

Circuit diagram

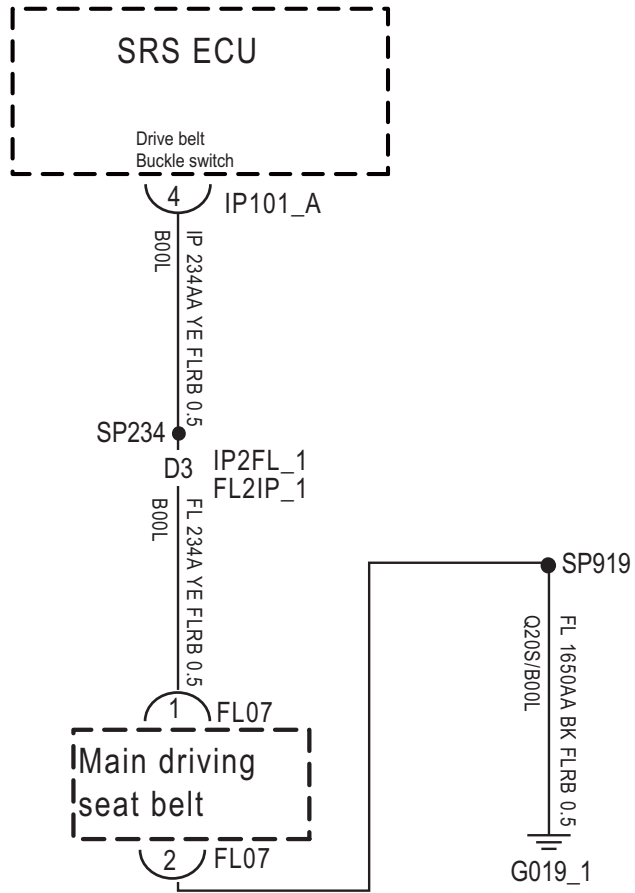

IP101_A

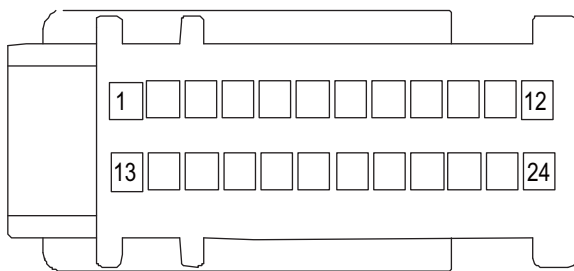

FL07

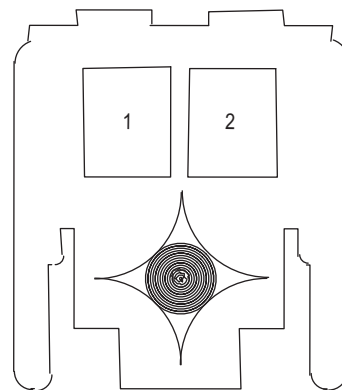

EK891360

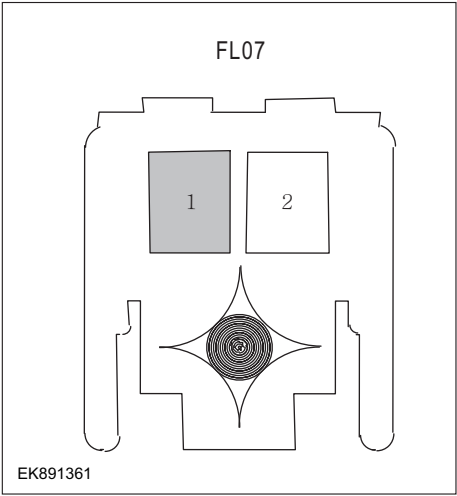
Troubleshooting steps	
Step1	General inspection.
	<ol style="list-style-type: none"> 1 Check fuse for damage. 2 Check battery capacity. 3 Check the driver's seat belt mortise lock and SRS module harness plug for damage, poor contact, aging and looseness. 4 Check whether the result is normal or not?
NO → Repair or replace parts with detected faults.	
YES ↓	
Step2	Check fault codes.
	<ol style="list-style-type: none"> 1 Connect the scan tool to the diagnostic interface. 2 Turn the ignition switch to the on position. 3 Diagnose SRS module with diagnostic instrument. 4 Is there any other fault code except for B0050-12?
YES → Refer to: DTC Summary list (SRS) .	
NO ↓	
Step3	Check the power supply circuit of driver's seat belt latch circuit.
	<ol style="list-style-type: none"> 1 Turn off the ignition switch. 2 Disconnect the driver's seat belt latch harness plug. 3 Turn on the ignition switch. 4 Measure the voltage between driver's seat belt latch harness terminal and ground. Measuring circuit: voltage between terminal 1 of driver's seat belt latch plug and ground. Standard value:4.8~5.2V 5 Check whether the result is normal or not?
NO → Repair or replace parts with detected faults.	
YES ↓	

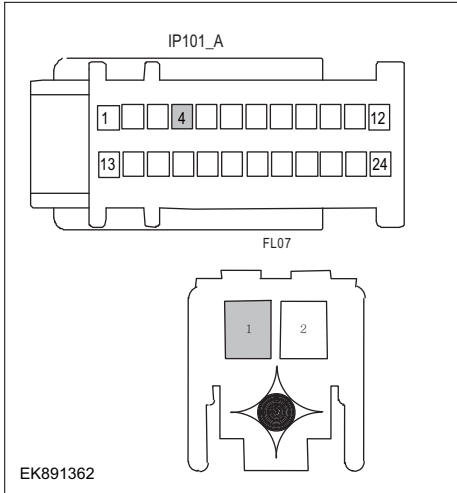
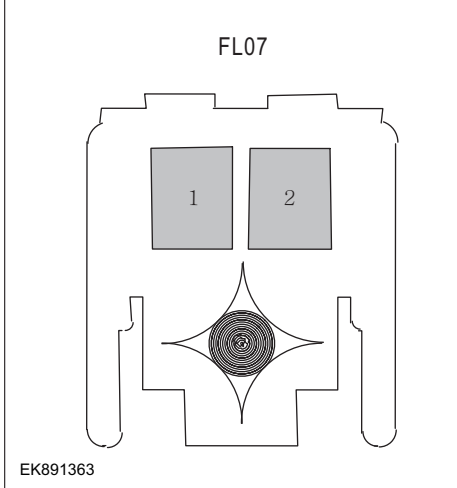
Step4	Check driver's seat belt latch circuit (open circuit).
	<ol style="list-style-type: none"> 1 Turn off the ignition switch. 2 Disconnect SRS module harness plug. 3 Measure the resistance between driver's seat belt latch harness terminal and SRS module harness terminal. Measuring circuit: resistance between terminal 1 of driver's seat belt latch plug and terminal 4 of SRS module plug. Standard value: $\approx 0\Omega$ 4 Check whether the result is normal or not?
NO → Repair or replace parts with detected faults.	
YES ↓	
Step5	Check driver's seat belt latch (short circuit).
	<ol style="list-style-type: none"> 1 Turn off the ignition switch. 2 Measure the resistance between driver's seat belt latch harness plug and ground. Measure circuit: resistance between No.1 terminal of harness plug of driver's seat belt latch and ground. Measure circuit: resistance between No.2 terminal of harness plug of driver's seat belt latch and ground. Standard value: infinite 3 Measure the voltage between driver's seat belt latch harness plug and ground. Measuring circuit: voltage between No.2 terminal of harness plug of driver's seat belt latch and ground. Standard value: $\approx 0V$ 4 Check whether the result is normal or not?
NO → Repair or replace parts with detected faults.	
YES ↓	

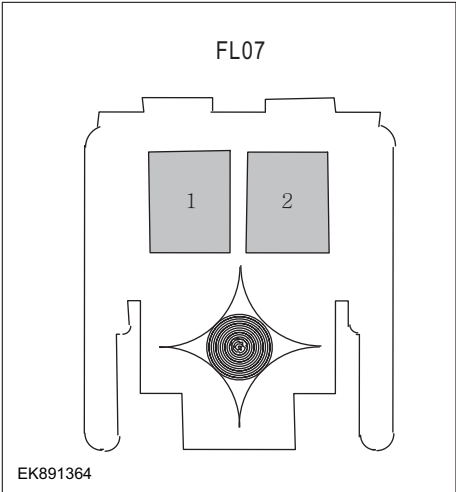
Step6	Check the driver's seat belt latch (component inspection).
	<ol style="list-style-type: none"> 1 Directly measure the resistance of the driver's seat belt latch. Measuring circuit: resistance between terminal 1 and terminal 2 of driver's seat belt latch plug. Standard value: 2 Measure the resistance between the driver's seat belt latch terminal and the housing. Measuring circuit: resistance between No.1 terminal of driver's seat belt latch plug and housing. Measuring circuit: resistance between No.2 terminal of driver's seat belt latch plug and housing. Standard value:infinite 3 Check whether the result is normal or not?
<p>NO → Replace the driver's seat belt latch.</p>	
<p>YES ↓</p>	
Step7	Check whether the SRS module is abnormal.
	<ol style="list-style-type: none"> 1 Turn off the ignition switch. 2 Disconnect and check SRS module harness plug. 3 Inspection and maintenance: <ul style="list-style-type: none"> • Corrosion (install new connectors or terminals-clean module pins). • Damaged or bent pins-Install new terminals/pins. • Pin flying out-install new pins as needed. 4 Reconnect the SRS module plug and all other previously disconnected plugs. Make sure that the pins are properly positioned and fixed. 5 Run the system and determine if the problem still exists?
<p>YES → Replace SRS .</p>	
<p>NO ↓</p>	
<p>At this time, the system works normally. The cause of the problem may be module connection. Address the root cause of any connector or pin problem.</p>	
<p>Next Step ↓</p>	
<p>Diagnosis is over.</p>	

B0052-12

Fault diagnosis code
B0052-12: Passenger Buckle Switch Shorted to Battery
Detection tools
1 Multimeter and diagnostic apparatus
Possible causes
<ul style="list-style-type: none"> • Circuit, terminal and adapting piece fault • SRS • Co-driver's seat belt mortise lock
Conditions for fault code operation
Turn the ignition switch to the ON position
Conditions for fault code setting
B0052-12
Co-driver's seat belt latch has a short circuit to the battery.
To set the effect of a fault code condition
The airbag fault light is on, and it does not have the function of igniting the airbag.
Description of circuit diagram
The SRS module monitors the right impact sensor through the low reference circuit and the signal circuit.

Circuit diagram

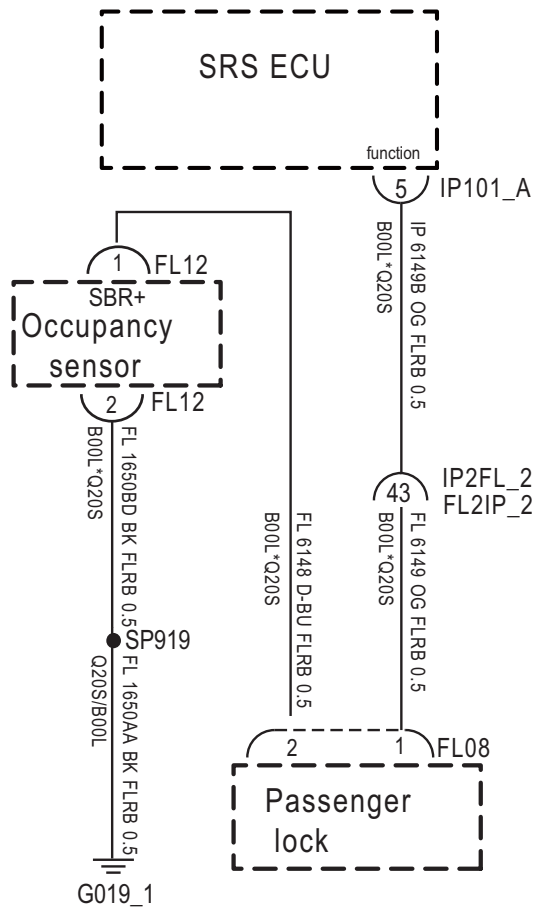

IP101_A

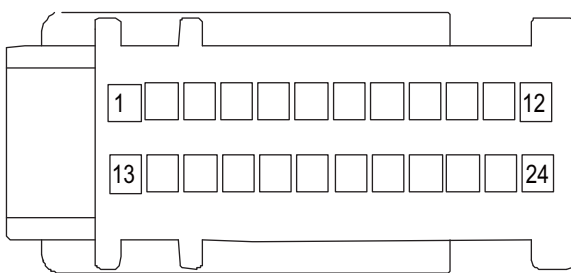

FL08

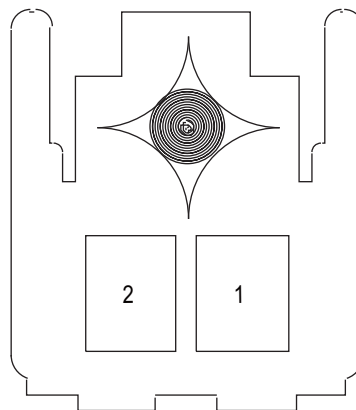

EK891365

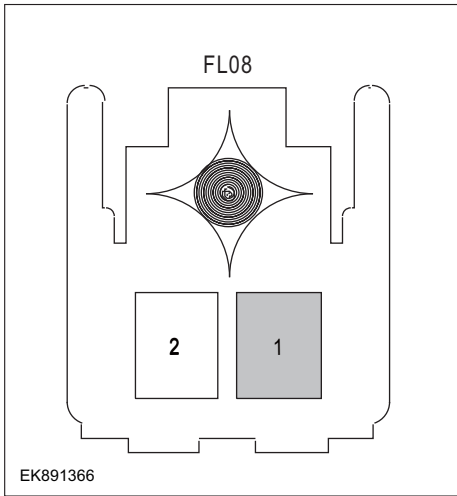
Troubleshooting steps	
Step1	General inspection.
	<ol style="list-style-type: none"> 1 Check fuse for damage. 2 Check battery capacity. 3 Check whether there is any damage, poor contact, aging and loosening of the seat belt latch and SRS module harness plug on the co-driver's side. 4 Check whether the result is normal or not?
NO → Repair or replace parts with detected faults.	
YES ↓	
Step2	Check fault codes.
	<ol style="list-style-type: none"> 1 Connect the scan tool to the diagnostic interface. 2 Turn the ignition switch to the on position. 3 Diagnose SRS module with diagnostic instrument. 4 Is there any other fault code except for B0052-12?
YES → Refer to: DTC Summary list (SRS) .	
NO ↓	
Step3	Check the power supply circuit of the front passenger seat belt latch circuit.
	<ol style="list-style-type: none"> 1 Turn off the ignition switch. 2 Disconnect the harness plug of the front passenger's seat belt latch. 3 Turn on the ignition switch. 4 Measure the voltage between the harness terminal of the passenger seat belt latch and ground. Measuring circuit: voltage between No.1 terminal of the safety belt latch plug on the passenger side and ground. Standard value:4.8~5.2V 5 Check whether the result is normal or not?
NO → Repair or replace parts with detected faults.	
YES ↓	

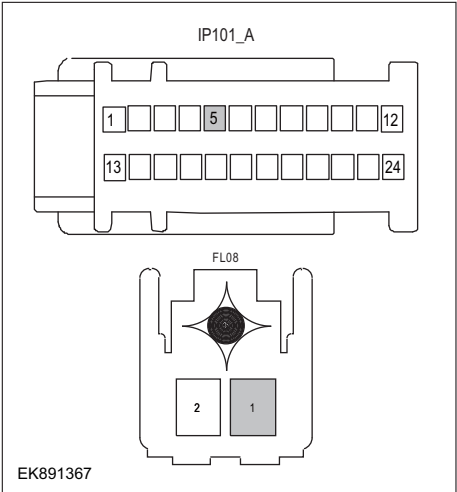
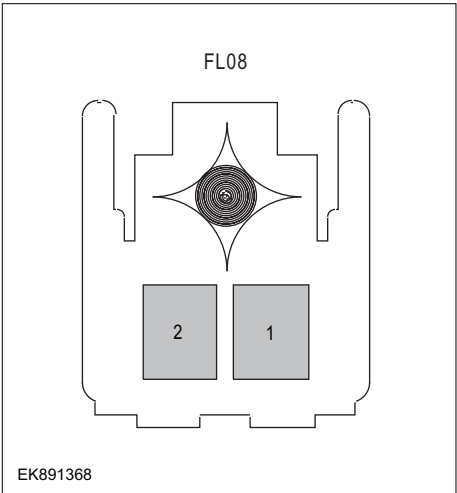
Step4	Check driver's seat belt latch circuit (open circuit).
	<ol style="list-style-type: none"> 1 Turn off the ignition switch. 2 Disconnect SRS module harness plug. 3 Measure the resistance between the harness terminal of the front passenger seat belt latch and the harness terminal of SRS module. Measuring circuit: resistance between No.1 terminal of the front passenger seat belt latch plug and No.5 terminal of the SRS module plug. Standard value: $\approx 0\Omega$ 4 Check whether the result is normal or not?
NO → Repair or replace parts with detected faults.	
YES ↓	
Step5	Check the front passenger seat belt latch (short circuit).
	<ol style="list-style-type: none"> 1 Turn off the ignition switch. 2 Measure the resistance between the plug of harness for the front passenger's seat belt latch and ground. Measure circuit: resistance between No.1 terminal of harness plug of the passenger seat belt latch and ground. Measure circuit: resistance between No.2 terminal of harness plug of safety belt latch on passenger side and ground. Standard value: infinite 3 Measure the voltage between the plug of the harness of the front driver's seat belt latch and the ground. Measuring circuit: voltage between No.2 terminal of harness plug of safety belt latch on passenger side and ground. Standard value: $\approx 0V$ 4 Check whether the result is normal or not?
NO → Repair or replace parts with detected faults.	
YES ↓	

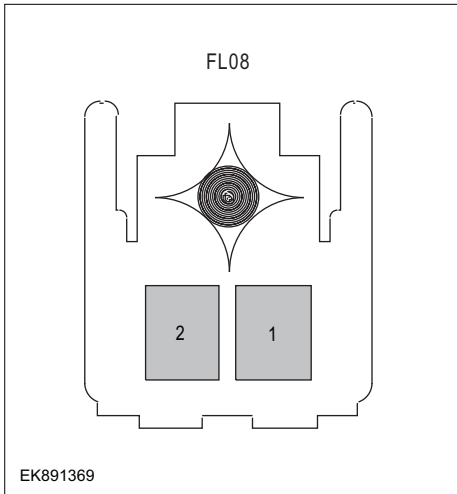
Step6	Check the seat belt latch on the passenger side (component inspection).
	<ol style="list-style-type: none"> 1 Directly measure the resistance of the seat belt latch on the passenger side. Directly measure the resistance of the seat belt latch on the passenger side. Standard value: 2 Measure the resistance between the front passenger seat belt latch terminal and the housing. Measuring circuit: resistance between No.1 terminal of the plug of the safety belt latch on the passenger side and the housing. Measuring circuit: resistance between No.2 terminal of the plug of the safety belt latch on the passenger side and the housing. Standard value:infinite 3 Check whether the result is normal or not?
<p>NO → Replace the front passenger seat belt latch.</p>	
<p>YES ↓</p>	
Step7	Check whether the SRS module is abnormal.
	<ol style="list-style-type: none"> 1 Turn off the ignition switch. 2 Disconnect and check SRS module harness plug. 3 Inspection and maintenance: <ul style="list-style-type: none"> • Corrosion (install new connectors or terminals-clean module pins). • Damaged or bent pins-Install new terminals/pins. • Pin flying out-install new pins as needed. 4 Reconnect the SRS module plug and all other previously disconnected plugs. Make sure that the pins are properly positioned and fixed. 5 Run the system and determine if the problem still exists?
<p>YES → Replace SRS .</p>	
<p>NO ↓</p>	
<p>At this time, the system works normally. The cause of the problem may be module connection. Address the root cause of any connector or pin problem.</p>	
<p>Next Step ↓</p>	
<p>Diagnosis is over.</p>	

B0053-12

Fault diagnosis code
B0053-12: 2nd Row Left Seat Belt buckle switch Circuit – Shorted to Battery
Detection tools
1 Multimeter and diagnostic apparatus
Possible causes
<ul style="list-style-type: none">• Circuit, terminal and adapting piece fault• SRS• Second Row Left Seat Belt
Conditions for fault code operation
Turn the ignition switch to the ON position
Conditions for fault code setting
B0053-12
The left seat belt switch in the second row is leakage-proof for the battery.
To set the effect of a fault code condition
The airbag fault light is on, and it does not have the function of igniting the airbag.
Description of circuit diagram
The SRS module monitors the right impact sensor through the low reference circuit and the signal circuit.

Circuit diagram

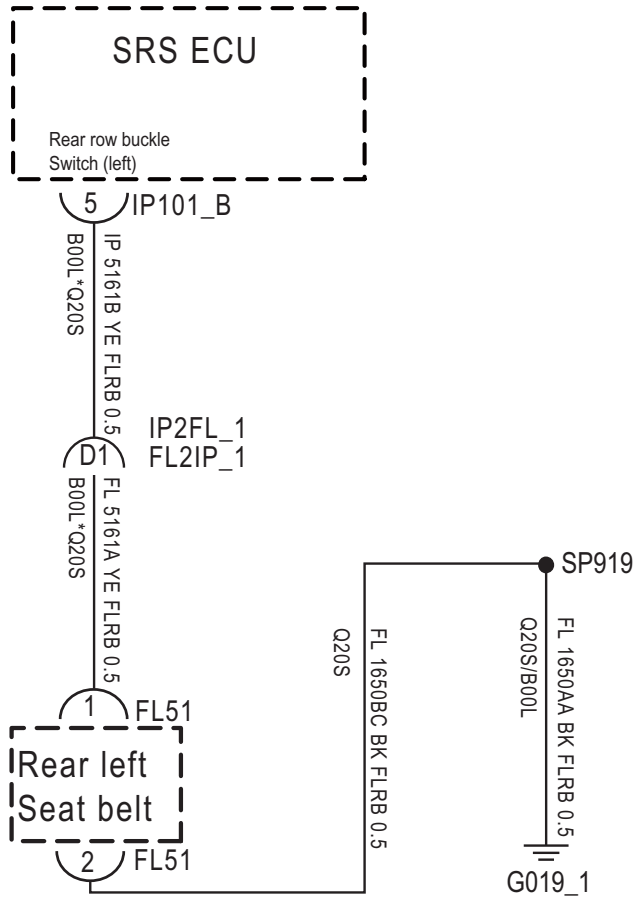

IP101_B

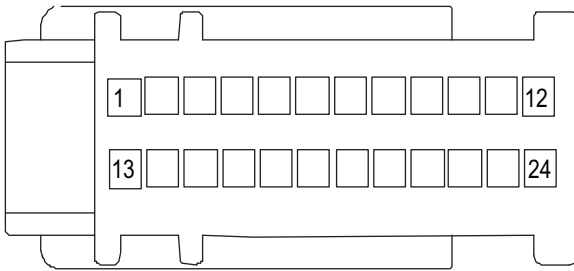

FL51

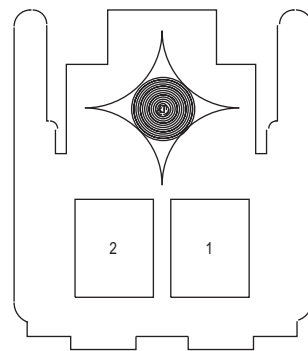

EK891370

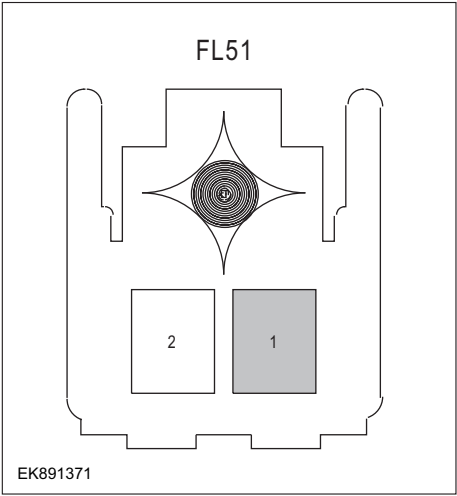
Troubleshooting steps	
Step1	General inspection.
	<ol style="list-style-type: none"> 1 Check fuse for damage. 2 Check battery capacity. 3 Check whether there is any damage, poor contact, aging and loosening of the second row left seat belt and SRS module harness plug. 4 Check whether the result is normal or not?
<p>NO → Repair or replace parts with detected faults.</p>	
<p>YES ↓</p>	
Step2	Check fault codes.
	<ol style="list-style-type: none"> 1 Connect the scan tool to the diagnostic interface. 2 Turn the ignition switch to the on position. 3 Diagnose SRS module with diagnostic instrument. 4 Is there any other fault code except for B0053-12?
<p>YES → Refer to: DTC Summary list (SRS).</p>	
<p>NO ↓</p>	
Step3	Check the second row left seat belt circuit power supply circuit.
	<ol style="list-style-type: none"> 1 Turn off the ignition switch. 2 Disconnect the second row left seat belt harness plug. 3 Turn on the ignition switch. 4 Measure the voltage between the second row left seat belt harness terminal and ground. Measuring circuit: voltage between No.1 terminal of the second row left seat belt harness plug and ground. Standard value:4.8~5.2V 5 Check whether the result is normal or not?
<p>NO → Repair or replace parts with detected faults.</p>	
<p>YES ↓</p>	

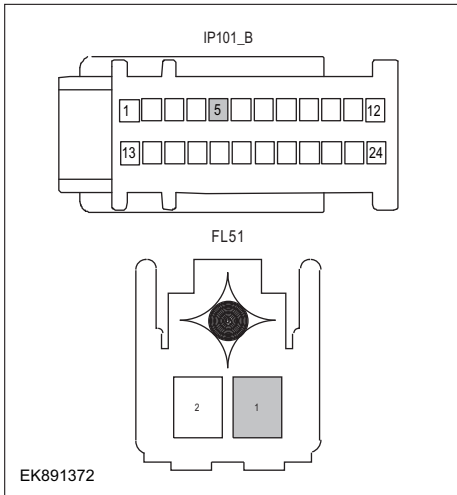
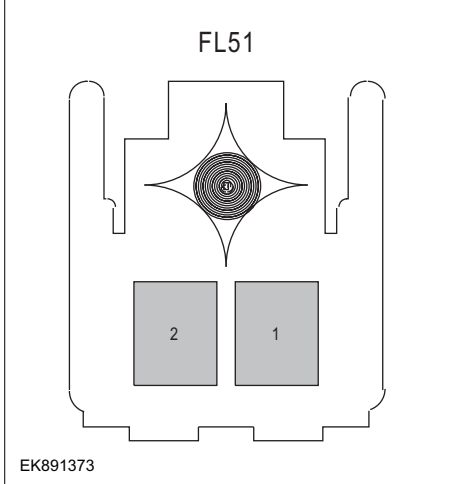
<p>Step4</p>	<p>Check the second row left seat belt circuit (open circuit).</p>
	<ol style="list-style-type: none"> 1 Turn off the ignition switch. 2 Disconnect SRS module harness plug. 3 Measure the resistance between the second row left seat belt harness terminal and SRS module harness terminal. Measuring circuit: resistance between No.1 terminal of the second row left seat belt harness plug and No.5 terminal of SRS module plug. Standard value: $\approx 0\Omega$ 4 Check whether the result is normal or not?
<p>NO → Repair or replace parts with detected faults.</p>	
<p>YES ↓</p>	
<p>Step5</p>	<p>Check the second row left seat belt (short circuit).</p>
	<ol style="list-style-type: none"> 1 Turn off the ignition switch. 2 Measure the resistance between the second row left seat belt harness plug and ground. Measure circuit: resistance between No.1 terminal of the second row left seat belt harness plug and ground. Measure circuit: resistance between No.2 terminal of the second row left seat belt harness plug and ground. Standard value: infinite 3 Measure the voltage between the second row left seat belt harness plug and ground. Measuring circuit: voltage between No.2 terminal of the second row left seat belt harness plug and ground. Standard value: $\approx 0V$ 4 Check whether the result is normal or not?
<p>NO → Repair or replace parts with detected faults.</p>	
<p>YES ↓</p>	

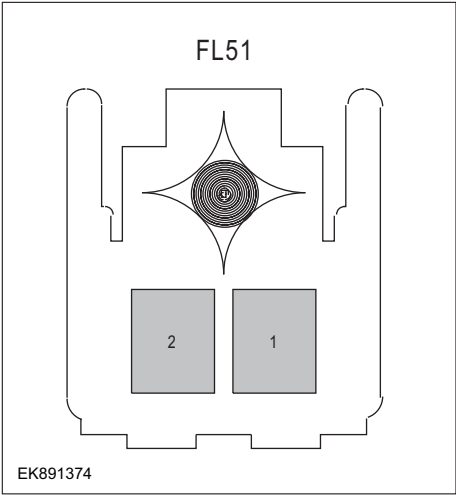
Step6	Check the second row left seat belt (component inspection).
	<ol style="list-style-type: none"> 1 Directly measure the resistance of the second row left seat belt. Measuring circuit: resistance between No.1 terminal and No.2 terminal of the second row left seat belt harness plug. Standard value: 2 Measure the resistance between the second row left seat belt terminal and the housing. Measuring circuit: resistance between No.1 terminal of the second row left seat belt plug and the housing. Measuring circuit: resistance between No.2 terminal of the second row left seat belt plug and the housing. Standard value:infinite 3 Check whether the result is normal or not?
NO → Replace the left seat belt in the second row	
YES ↓	
Step7	Check whether the SRS module is abnormal.
	<ol style="list-style-type: none"> 1 Turn off the ignition switch. 2 Disconnect and check SRS module harness plug. 3 Inspection and maintenance: <ul style="list-style-type: none"> • Corrosion (install new connectors or terminals-clean module pins). • Damaged or bent pins-Install new terminals/pins. • Pin flying out-install new pins as needed. 4 Reconnect the SRS module plug and all other previously disconnected plugs. Make sure that the pins are properly positioned and fixed. 5 Run the system and determine if the problem still exists?
YES → Replace SRS .	
NO ↓	
At this time, the system works normally. The cause of the problem may be module connection. Address the root cause of any connector or pin problem.	
Next Step ↓	
Diagnosis is over.	

B0054-12

Fault diagnosis code
B0054-12: 2nd Row Middle Seat Belt buckle switch Circuit – Shorted to Battery
Detection tools
1 Multimeter and diagnostic apparatus
Possible causes
<ul style="list-style-type: none"> • Circuit, terminal and adapting piece fault • SRS • Second row middle seat belt
Conditions for fault code operation
Turn the ignition switch to the ON position
Conditions for fault code setting
B0054-12
The middle seat belt buckle switch in the second row is leakage-proof to the battery.
To set the effect of a fault code condition
The airbag fault light is on, and it does not have the function of igniting the airbag.
Description of circuit diagram
The SRS module monitors the right impact sensor through the low reference circuit and the signal circuit.

Circuit diagram

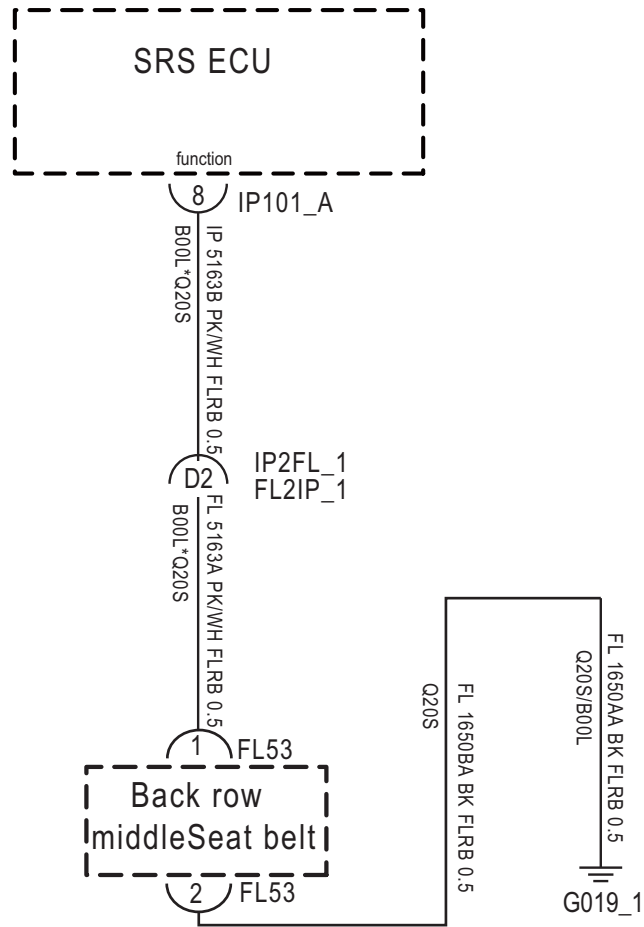

IP101_A

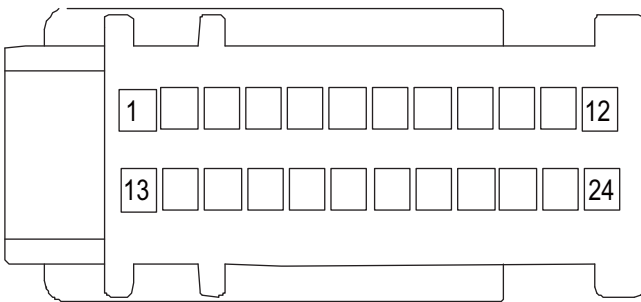

FL53

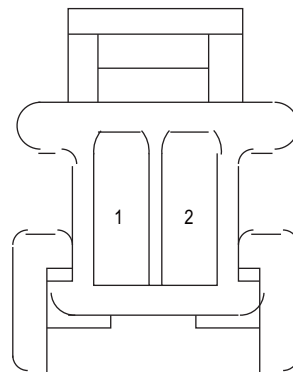

EK891375

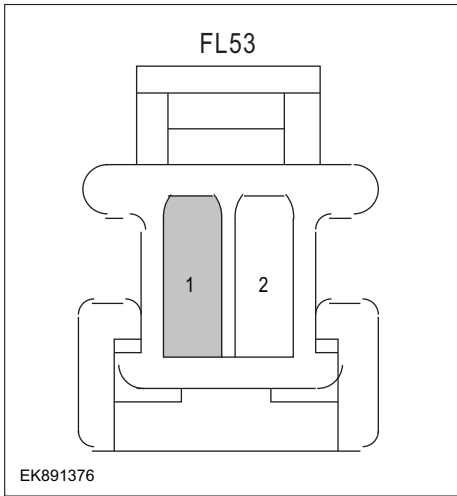
Troubleshooting steps	
Step1	General inspection.
	<ol style="list-style-type: none"> 1 Check fuse for damage. 2 Check battery capacity. 3 Check whether there is any damage, poor contact, aging and loosening of the second row of middle seat belt and SRS module harness plug. 4 Check whether the result is normal or not?
NO → Repair or replace parts with detected faults.	
YES ↓	
Step2	Check fault codes.
	<ol style="list-style-type: none"> 1 Connect the scan tool to the diagnostic interface. 2 Turn the ignition switch to the on position. 3 Diagnose SRS module with diagnostic instrument. 4 Is there any other fault code except for B0054-12?
YES → Refer to: DTC Summary list (SRS) .	
NO ↓	
Step3	Check the power supply circuit of the second row middle seat belt circuit.
	<ol style="list-style-type: none"> 1 Turn off the ignition switch. 2 Disconnect the second row middle seat belt harness plug. 3 Turn on the ignition switch. 4 Measure the voltage between the second row middle seat belt harness terminal and ground. Measuring circuit: voltage between No.1 terminal of the second row middle seat belt harness plug and ground. Standard value:4.8~5.2V 5 Check whether the result is normal or not?
NO → Repair or replace parts with detected faults.	
YES ↓	

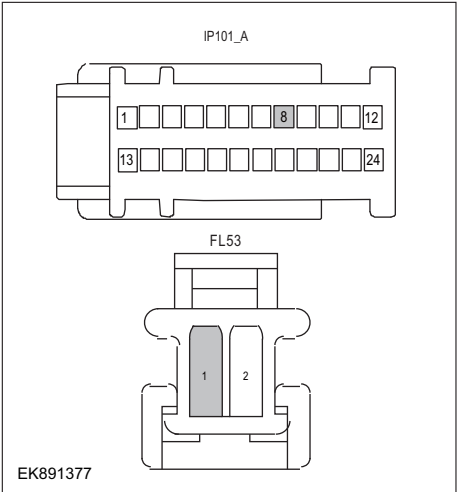
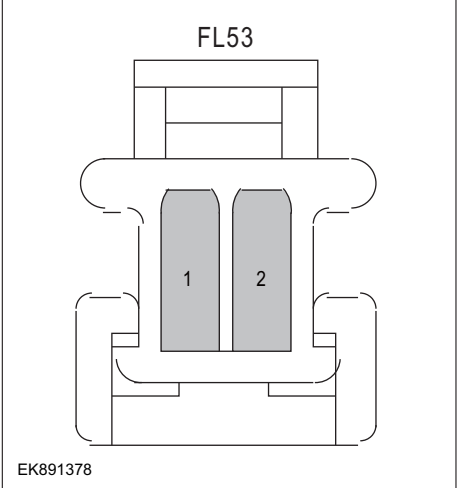
Step4	Check the second row middle seat belt circuit (open circuit).
	<ol style="list-style-type: none"> 1 Turn off the ignition switch. 2 Disconnect SRS module harness plug. 3 Measure the resistance between the harness terminal of the second row middle seat belt and the harness terminal of SRS module. Measuring circuit: the resistance between the No.1 terminal of the second row middle seat belt harness plug and the No.8 terminal of the SRS module plug. Standard value: $\approx 0\Omega$ 4 Check whether the result is normal or not?
NO → Repair or replace parts with detected faults.	
YES ↓	
Step5	Check the second row middle seat belt (short circuit).
	<ol style="list-style-type: none"> 1 Turn off the ignition switch. 2 Measure the resistance between the second row middle seat belt harness plug and ground. Measuring circuit: resistance between No.1 terminal of the second row middle seat belt harness plug and ground. Measuring circuit: resistance between No.2 terminal of harness plug of the second row middle seat belt and ground. Standard value: infinite 3 Measure the voltage between the second row middle seat belt harness plug and ground. Measuring circuit: voltage between No.2 terminal of the second row middle seat belt harness plug and ground. Standard value: $\approx 0V$ 4 Check whether the result is normal or not?
NO → Repair or replace parts with detected faults.	
YES ↓	

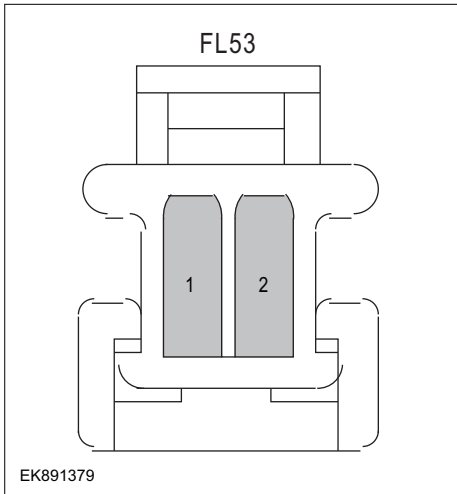
Step6	Check the second row middle seat belt (component inspection).
	<ol style="list-style-type: none"> 1 Directly measure the resistance of the second row middle seat belt. Measuring circuit: resistance between No.1 terminal and No.2 terminal of the second row middle seat belt harness plug. Standard value: 2 Measure the resistance between the second row middle seat belt terminal and the housing. Measuring circuit: resistance between No.1 terminal of the second row middle seat belt plug and the housing. Measuring circuit: resistance between No.2 terminal of the second row middle seat belt plug and the housing. Standard value:infinite 3 Check whether the result is normal or not?
<p>NO → Replace the second row middle seat belt.</p>	
<p>YES ↓</p>	
Step7	Check whether the SRS module is abnormal.
	<ol style="list-style-type: none"> 1 Turn off the ignition switch. 2 Disconnect and check SRS module harness plug. 3 Inspection and maintenance: <ul style="list-style-type: none"> • Corrosion (install new connectors or terminals-clean module pins). • Damaged or bent pins-Install new terminals/pins. • Pin flying out-install new pins as needed. 4 Reconnect the SRS module plug and all other previously disconnected plugs. Make sure that the pins are properly positioned and fixed. 5 Run the system and determine if the problem still exists?
<p>YES → Replace SRS .</p>	
<p>NO ↓</p>	
<p>At this time, the system works normally. The cause of the problem may be module connection. Address the root cause of any connector or pin problem.</p>	
<p>Next Step ↓</p>	
<p>Diagnosis is over.</p>	

B0055-12

Fault diagnosis code
B0055-12: 2nd Row Right Seat Belt buckle switch Circuit – Shorted to Battery
Detection tools
1 Multimeter and diagnostic apparatus
Possible causes
<ul style="list-style-type: none">• Circuit, terminal and adapting piece fault• SRS• Second row right seat belt
Conditions for fault code operation
Turn the ignition switch to the ON position
Conditions for fault code setting
B0055-12
The second row of right seat belt buckle switches has leakage resistance to the battery.
To set the effect of a fault code condition
The airbag fault light is on, and it does not have the function of igniting the airbag.
Description of circuit diagram
The SRS module monitors the right impact sensor through the low reference circuit and the signal circuit.

Circuit diagram

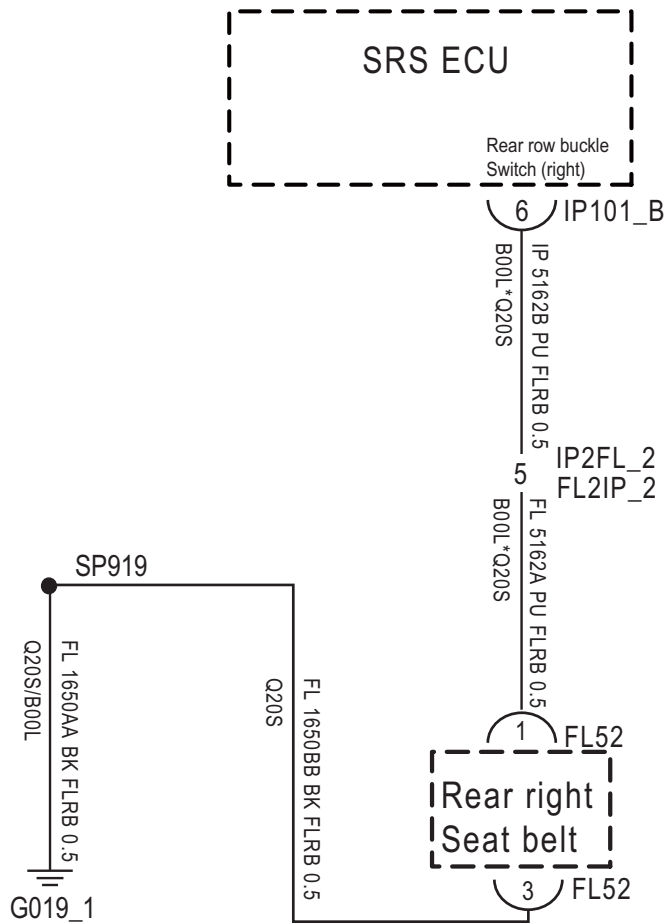

IP101_B

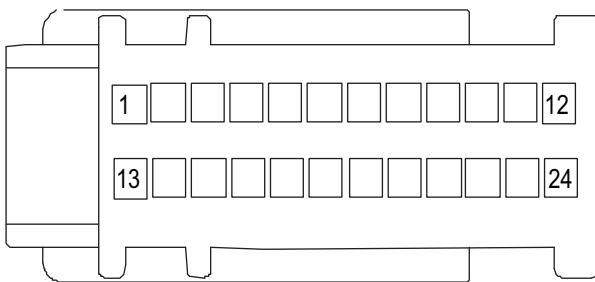

FL52

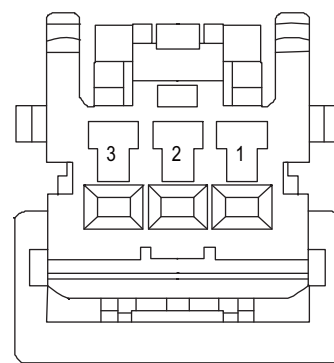

EK891380

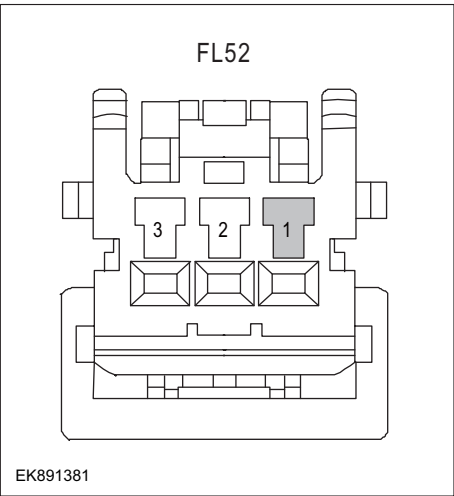
Troubleshooting steps	
Step1	General inspection.
	<ol style="list-style-type: none"> 1 Check fuse for damage. 2 Check battery capacity. 3 Check the second row right seat belt and SRS module harness plug for damage, poor contact, aging and looseness. 4 Check whether the result is normal or not?
NO → Repair or replace parts with detected faults.	
YES ↓	
Step2	Check fault codes.
	<ol style="list-style-type: none"> 1 Connect the scan tool to the diagnostic interface. 2 Turn the ignition switch to the on position. 3 Diagnose SRS module with diagnostic instrument. 4 Is there any other fault code except for B0055-12?
YES → Refer to: DTC Summary list (SRS) .	
NO ↓	
Step3	Check the power supply circuit of the second row right seat belt circuit.
	<ol style="list-style-type: none"> 1 Turn off the ignition switch. 2 Disconnect the second row right seat belt harness plug. 3 Turn on the ignition switch. 4 Measure the voltage between the second row right seat belt harness terminal and ground. Measuring circuit: voltage between No.1 terminal of the second row right seat belt harness plug and ground. Standard value:4.8~5.2V 5 Check whether the result is normal or not?
NO → Repair or replace parts with detected faults.	
YES ↓	

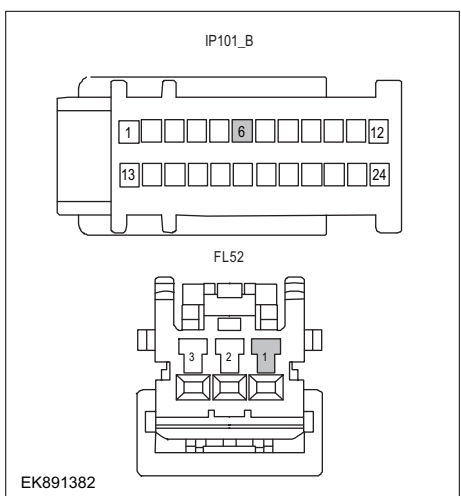
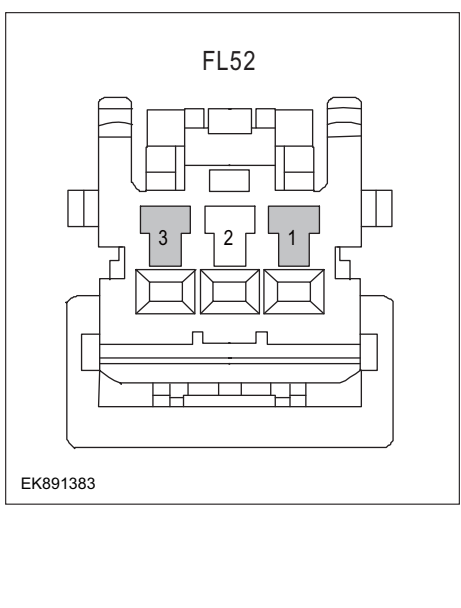
Step4	Check the second row right seat belt circuit (open circuit).
	<ol style="list-style-type: none"> 1 Turn off the ignition switch. 2 Disconnect SRS module harness plug. 3 Measure the resistance between the second row right seat belt harness terminal and SRS module harness terminal. Measuring circuit: resistance between No.1 terminal of the second row right seat belt harness plug and No.6 terminal of SRS module plug. Standard value: $\approx 0\Omega$ 4 Check whether the result is normal or not?
NO → Repair or replace parts with detected faults.	
YES ↓	
Step5	Check the second row right seat belt (short circuit).
	<ol style="list-style-type: none"> 1 Turn off the ignition switch. 2 Measure the resistance between the second row right seat belt harness plug and ground. Measure circuit: resistance between No.1 terminal of the second row right seat belt harness plug and ground. Measure circuit: resistance between No.3 terminal of the second row right seat belt harness plug and ground. Standard value: infinite 3 Measure the voltage between the second row right seat belt harness plug and ground. Measuring circuit: voltage between No.3 terminal of the second row right seat belt harness plug and ground. Standard value: $\approx 0V$ 4 Check whether the result is normal or not?
NO → Repair or replace parts with detected faults.	
YES ↓	

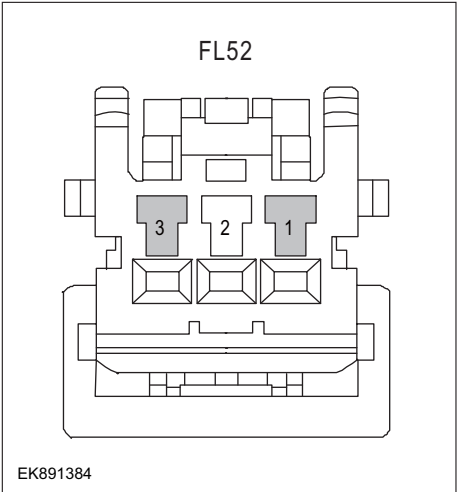
Step6	Check the second row right seat belt (component inspection).
	<ol style="list-style-type: none"> 1 Directly measure the resistance of the second row right seat belt. Measuring circuit: resistance between No.1 terminal and No.3 terminal of the second row right seat belt harness plug. Standard value: 2 Measure the resistance between the second row right seat belt terminal and the housing. Measuring circuit: resistance between No.1 terminal of the second row right seat belt plug and the housing. Measuring circuit: resistance between No.3 terminal of the second row right seat belt plug and the housing. Standard value:infinite 3 Check whether the result is normal or not?
NO → Replace the second row right seat belt.	
YES ↓	
Step7	Check whether the SRS module is abnormal.
	<ol style="list-style-type: none"> 1 Turn off the ignition switch. 2 Disconnect and check SRS module harness plug. 3 Inspection and maintenance: <ul style="list-style-type: none"> • Corrosion (install new connectors or terminals-clean module pins). • Damaged or bent pins-Install new terminals/pins. • Pin flying out-install new pins as needed. 4 Reconnect the SRS module plug and all other previously disconnected plugs. Make sure that the pins are properly positioned and fixed. 5 Run the system and determine if the problem still exists?
YES → Replace SRS .	
NO ↓	
At this time, the system works normally. The cause of the problem may be module connection. Address the root cause of any connector or pin problem.	
Next Step ↓	
Diagnosis is over.	

B193F-49、 B193F-09、 B193F-96、 B193F-00、 B193F-00

Fault diagnosis code
B193F-49: SDM Internal Faults -- Power
B193F-09: SDM Internal Faults -- Acceleration Sensors
B193F-96: SDM Internal Faults--Firing Circuit
B193F-00: SDM Internal Faults -- Control Function Block
Detection tools
1 Multimeter and diagnostic apparatus
Possible causes
<ul style="list-style-type: none"> • Circuit,terminal and adapting piece fault • storage battery • SRS • fuse
Conditions for fault code operation
Turn the ignition switch to the ON position
Conditions for fault code setting
B193F-49
SDM internal power-related internal fault
B193F-09
SDM internal acceleration sensor failure
B193F-96
SDM internal ignition circuit failure
B193F-00
SDM internal control function module failure
To set the effect of a fault code condition
Description of circuit diagram
SRS will always monitor whether the sensors and actuators are in the normal range. At the same time, it will also test the rationality of virtual connection, short circuit, open circuit and other signals. When a fault occurs, SRS will store the fault code corresponding to this fault.

Circuit diagram

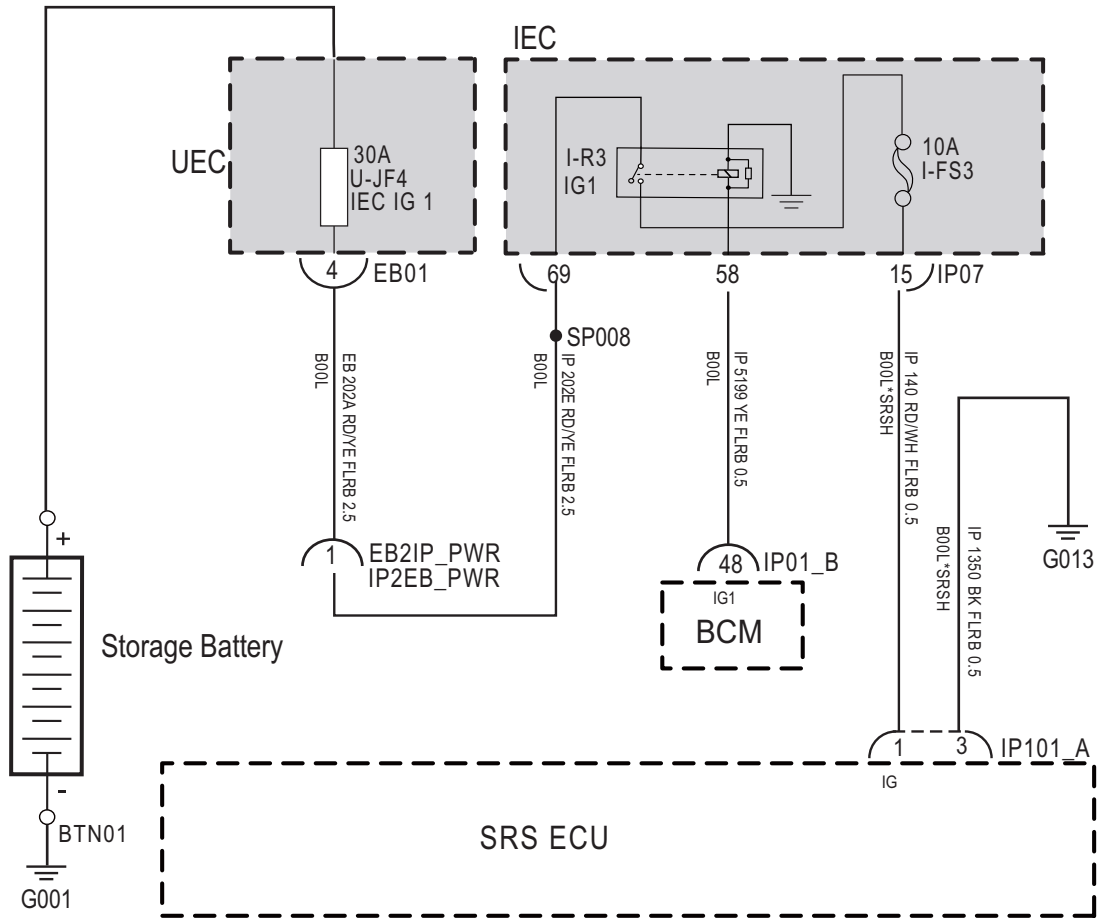

IP101_A

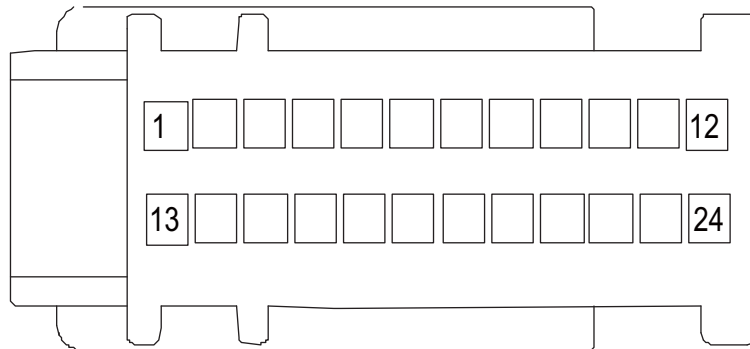

EK891304

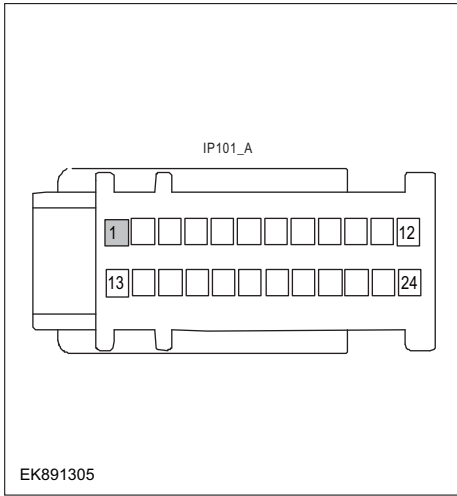
Troubleshooting steps	
Step1	General inspection.
	<ol style="list-style-type: none"> 1 Check fuse U-JF4、 I-FS3 for damage. 2 Check relay IG1 for damage. 3 Check battery capacity. 4 Check the harness plug of SRS for damage, poor contact, aging and looseness. 5 Check whether the result is normal or not?
	NO → Repair or replace parts with detected faults.
YES ↓	
Step2	Check fault codes.
	<ol style="list-style-type: none"> 1 Connect the scan tool to the diagnostic interface. 2 Turn the ignitiON switch to the on position. 3 Diagnose SRS module with diagnostic instrument. 4 Is there any other fault code except for B193F-49、 B193F-09、 B193F-96、 B193F-00?
	YES → Refer to: DTC Summary list (SRS) .
NO ↓	
Step3	Check the power supply voltage of SCU module when it is started or running.
 <p style="text-align: center;">IP101_A</p> <p style="text-align: center;">EK891305</p>	<ol style="list-style-type: none"> 1 Turn on the ignition switch. 2 Measure the voltage between SRS module harness terminal and ground. Measuring circuit: voltage between terminal 1 of IP101_A plug and ground. Standard value:10~14V 3 Check whether the result is normal or not?
	NO → Repair or replace parts with detected faults.
YES ↓	

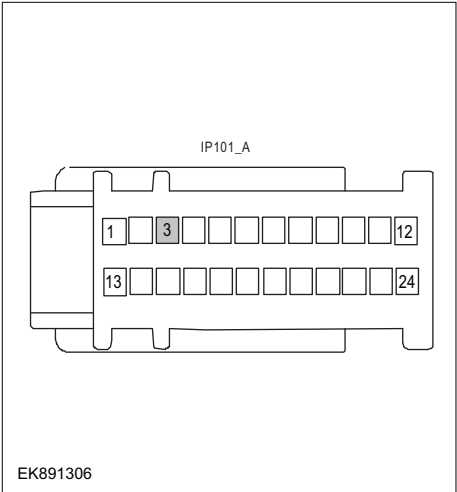
Step4	Check SRS module ground circuit for open circuit.
	<ol style="list-style-type: none"> 1 Turn off the ignition switch. 2 Measure the resistance between SRS module harness plug and ground. Measuring circuit: resistance between terminal 3 of IP101_A plug and ground. Standard value:< 1Ω 3 Is the resistance less than 1 ω?
NO → Repair or replace parts with detected faults.	
YES ↓	
Step5	Check whether the SCU module is abnormal.
	<ol style="list-style-type: none"> 1 Turn off the ignition switch. 2 Disconnect and check the harness plug IP101_A of SRS module. 3 Inspection and maintenance: <ul style="list-style-type: none"> • Corrosion (install new connectors or terminals-clean module pins). • Damaged or bent pins-Install new terminals/pins. • Pin flying out-install new pins as needed. 4 Reconnect the SRS module plug and all other previously disconnected plugs. Make sure that the pins are properly positioned and fixed. 5 Run the system and determine if the problem still exists?
YES → Replace SRS .	
NO ↓	
At this time, the system works normally. The cause of the problem may be module connection. Address the root cause of any connector or pin problem.	
Next Step ↓	
Diagnosis is over.	

DTC Summary list (SCU)

DTC	English descriptions	Reference page
B1117-17	Battery voltage is too high	B1117-17、 B1117-16
B1117-16	Battery voltage is too low	
P1002-1C	Hall sensor Error	P1002-1C
U2001-42	Write EEPROM error	U2001-42
U0151-87	lost communication with ABS	U0151-87
U0101-00	lost communication with VCU	U0101-00
U0073-00	CAN bus off	U0073-00

B1117-17、 B1117-16

Fault diagnosis code
B1117-17: Battery voltage is too high
B1117-16: Battery voltage is too low
Detection tools
1 Multimeter and diagnostic apparatus
Possible causes
<ul style="list-style-type: none"> • Circuit,terminal and adapting piece fault • storage battery • SCU • fuse
Conditions for fault code operation
Turn the ignition switch to the ON position
Conditions for fault code setting
B1117-17
The voltage is higher than 16V for 1s.
B1117-16
The voltage is lower than 9V for 1s.
To set the effect of a fault code condition
Description of circuit diagram
SCU will always monitor whether the sensors and actuators are in the normal range. At the same time, it will also test the rationality of virtual connection, short circuit, open circuit and other signals. When a fault occurs, SCU will store the fault code corresponding to this fault.

Circuit diagram

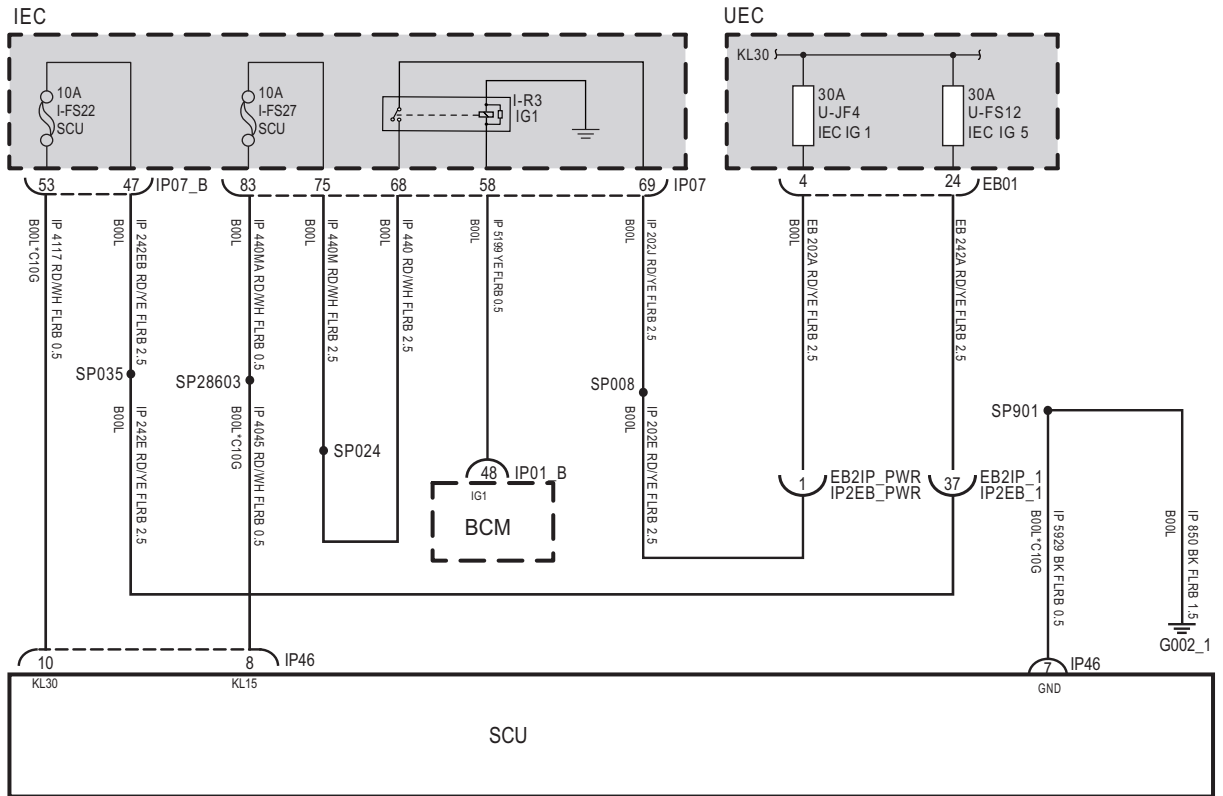

IP46

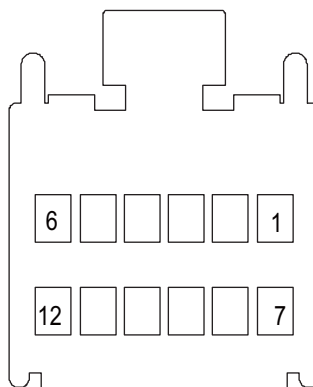

EK899101

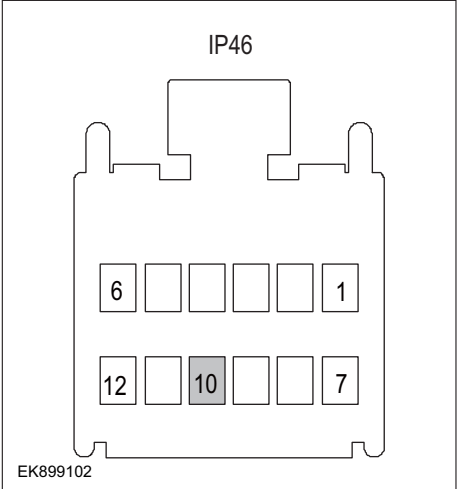
Troubleshooting steps	
Steps1	General inspection.
	<ol style="list-style-type: none"> 1 Check the fuse I-FS22、 I-FS27、 U-JF4、 U-FS12 for damage. 2 Check relay I-R3 for damage. 3 Check battery capacity. 4 Check the harness plug of SCU for damage, poor contact, aging and looseness. 5 Check whether the result is normal or not?
<p>NO → Repair or replace parts with detected faults.</p>	
<p>YES ↓</p>	
Steps2	Check fault codes.
	<ol style="list-style-type: none"> 1 Connect the scan tool to the diagnostic interface. 2 Turn the ignitiON switch to the on position. 3 Use diagnostic instrument to diagnose SCU. 4 If there is any fault code except for B1117-17、 B1117-16?
<p>YES → Refer to:DTC Summary list (SCU).</p>	
<p>NO ↓</p>	
Steps3	Check the supply voltage of SCUstorage battery.
	<ol style="list-style-type: none"> 1 Turn on the ignition switch. 2 Measure the voltage between SCU harness terminal and ground. Measuring circuit: voltage between terminal 10 of IP46 plug and ground. Standard value:10~14V 3 Check whether the result is normal or not?
<p>NO → Repair or replace the faulted parts.</p>	
<p>YES ↓</p>	

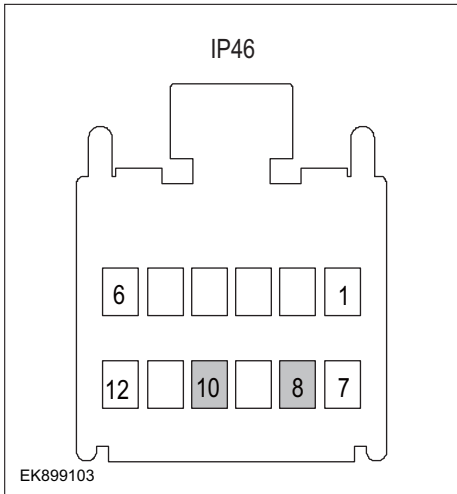
Steps4	Check the power supply voltage when SCU is started or running.
 <p style="text-align: center;">IP46</p> <p style="text-align: left;">EK899103</p>	<ol style="list-style-type: none"> 1 Turn on the ignition switch. 2 Measure the voltage between SCU harness terminal and ground. Measuring circuit: voltage between terminal 8 of IP46 plug and ground. Measuring circuit: voltage between terminal 10 of IP46 plug and ground. Standard value:10~14V 3 Check whether the result is normal or not?

NO → Repair or replace the faulted parts.

YES ↓

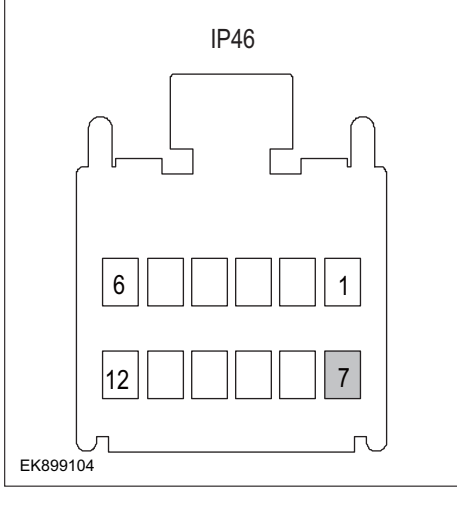
Steps5	Check SCU ground circuit for open circuit.
 <p style="text-align: center;">IP46</p> <p style="text-align: left;">EK899104</p>	<ol style="list-style-type: none"> 1 Turn off the ignition switch. 2 Measure the resistance between SCU harness plug and ground. Measuring circuit: resistance between terminal 7 of IP46 plug and ground. Standard value:< 1Ω 3 Is the resistance less than 1 ω?

NO → Repair or replace the faulted parts.

YES ↓

SCU

Steps6	Check whether SCU is abnormal.
	<ol style="list-style-type: none"> 1 Turn off the ignition switch. 2 Disconnect and check the SCU harness plug IP46. 3 Inspection and maintenance: <ul style="list-style-type: none"> • Corrosion (install new connectors or terminals-clean module pins). • Damaged or bent pins-Install new terminals/pins. • Pin flying out-install new pins as needed. 4 Reconnect the SCU plug and all other previously disconnected plugs. Make sure that the pins are properly positioned and fixed. 5 Run the system and determine if the problem still exists?
	YES → Replace SCU.
NO ↓	
At this time, the system works normally. The cause of the problem may be module connection. Address the root cause of any connector or pin problem.	
Next Step ↓	
Diagnosis is over.	

P1002-1C

Fault diagnosis code
P1002-1C: Hall sensor Error
Detection tools
1 Multimeter and diagnostic apparatus
Possible causes
<ul style="list-style-type: none"> • Circuit, terminal and adapting piece fault • storage battery • SCU • fuse • internal fault
Conditions for fault code operation
Turn the ignition switch to the ON position
Conditions for fault code setting
P1002-1C
Multiple Hall induction for 2s.
To set the effect of a fault code condition
Description of circuit diagram
SCU will always monitor whether the sensors and actuators are in the normal range. At the same time, it will also test the rationality of virtual connection, short circuit, open circuit and other signals. When a fault occurs, SCU will store the fault code corresponding to this fault.

Circuit diagram

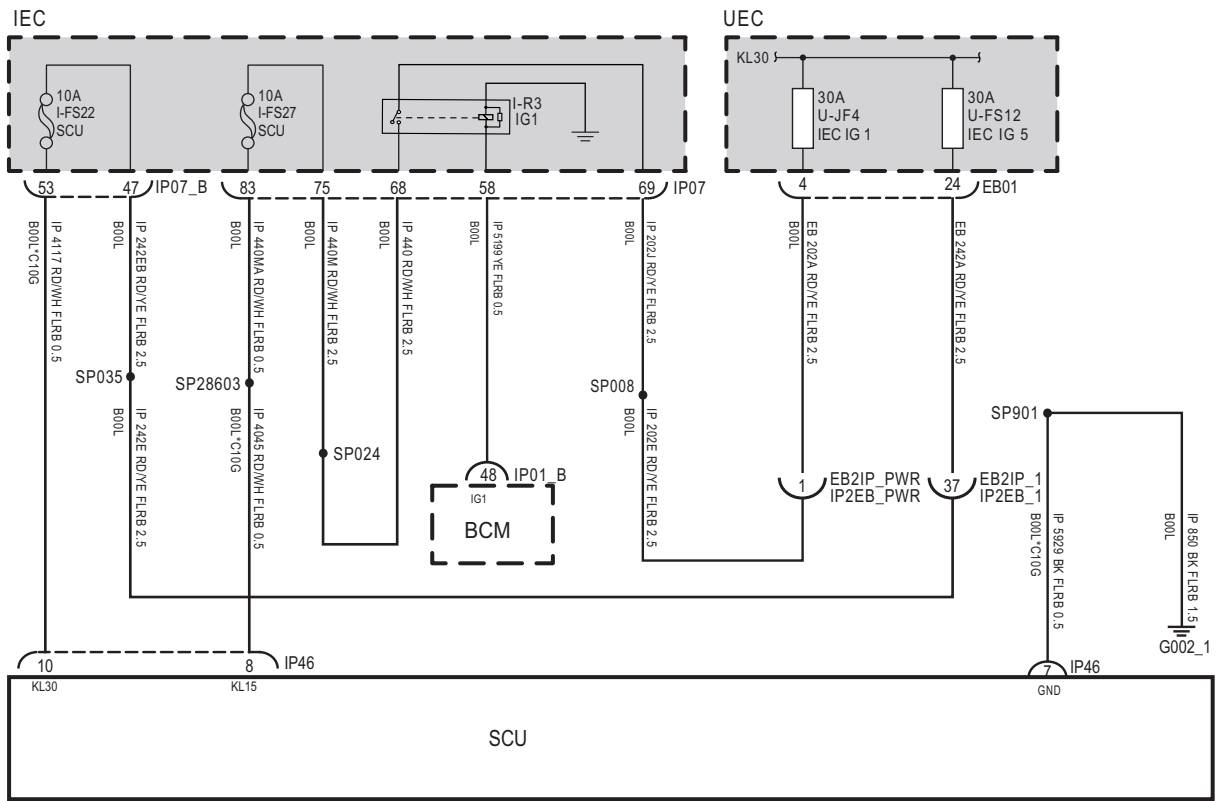

IP46

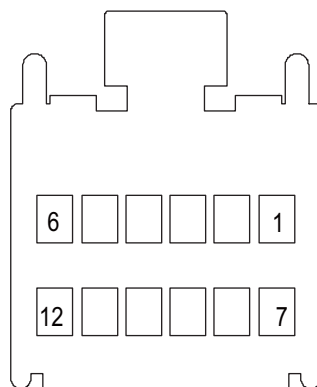

EK899101

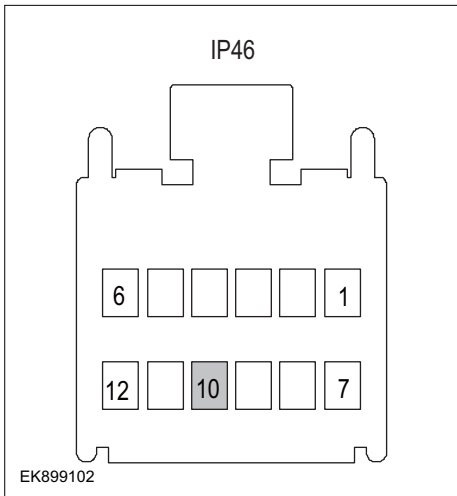
Troubleshooting steps	
Steps1	General inspection.
	<ol style="list-style-type: none"> 1 Check the fuse I-FS22、 I-FS27、 U-JF4、 U-FS12 for damage. 2 Check relay I-R3 for damage. 3 Check battery capacity. 4 Check the harness plug of SCU for damage, poor contact, aging and looseness. 5 Check whether the result is normal or not?
	NO → Repair or replace parts with detected faults.
YES ↓	
Steps2	Check fault codes.
	<ol style="list-style-type: none"> 1 Connect the scan tool to the diagnostic interface. 2 Turn the ignitiON switch to the on position. 3 Use diagnostic instrument to diagnose SCU. 4 If there is any fault code except for P1002-1C?
	YES → Refer to: DTC Summary list (SCU) .
NO ↓	
Steps3	Check the supply voltage of SCUstorage battery.
 <p>The diagram shows a top-down view of an IP46 connector. It has two rows of terminals. The top row has terminals labeled 6, 1, and two unlabeled terminals. The bottom row has terminals labeled 12, 10, and 7, with two unlabeled terminals between 12 and 10, and between 10 and 7. Terminal 10 is shaded grey. The connector is labeled 'IP46' at the top and 'EK899102' at the bottom left.</p>	<ol style="list-style-type: none"> 1 Turn on the ignition switch. 2 Measure the voltage between SCU harness terminal and ground. Measuring circuit: voltage between terminal 10 of IP46 plug and ground. Standard value:10~14V 3 Check whether the result is normal or not?
	NO → Repair or replace the faulted parts.
YES ↓	

SCU

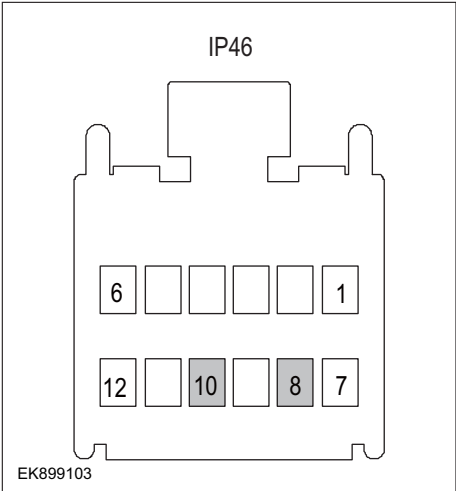
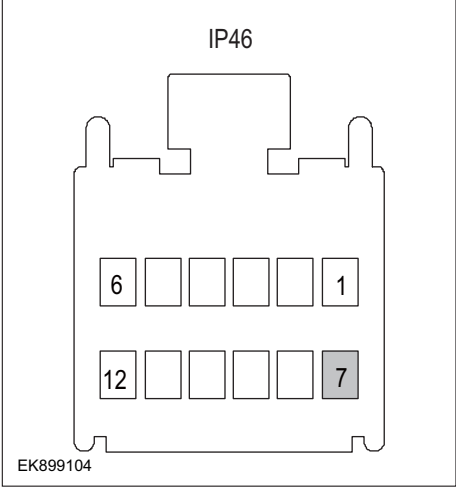
Steps4	Check the power supply voltage when SCU is started or running.
 <p>IP46</p> <p>EK899103</p>	<ol style="list-style-type: none"> 1 Turn on the ignition switch. 2 Measure the voltage between SCU harness terminal and ground. Measuring circuit: voltage between terminal 8 of IP46 plug and ground. Measuring circuit: voltage between terminal 10 of IP46 plug and ground. Standard value:10~14V 3 Check whether the result is normal or not?
NO → Repair or replace the faulted parts.	
YES ↓	
Steps5	Check SCU ground circuit for open circuit.
 <p>IP46</p> <p>EK899104</p>	<ol style="list-style-type: none"> 1 Turn off the ignition switch. 2 Measure the resistance between SCU harness plug and ground. Measuring circuit: resistance between terminal 7 of IP46 plug and ground. Standard value:< 1Ω 3 Is the resistance less than 1 ω?
NO → Repair or replace the faulted parts.	
YES ↓	

Steps6	Check whether SCU is abnormal.
	<ol style="list-style-type: none"> 1 Turn off the ignition switch. 2 Disconnect and check the SCU harness plug IP46. 3 Inspection and maintenance: <ul style="list-style-type: none"> • Corrosion (install new connectors or terminals-clean module pins). • Damaged or bent pins-Install new terminals/pins. • Pin flying out-install new pins as needed. 4 Reconnect the SCU plug and all other previously disconnected plugs. Make sure that the pins are properly positioned and fixed. 5 Run the system and determine if the problem still exists?
	YES → Replace SCU.
NO ↓	
At this time, the system works normally. The cause of the problem may be module connection. Address the root cause of any connector or pin problem.	
Next Step ↓	
Diagnosis is over.	

U2001-42

Fault diagnosis code
U2001-42: Write EEPROM error
Detection tools
1 Multimeter and diagnostic apparatus
Possible causes
<ul style="list-style-type: none"> • Circuit, terminal and adapting piece fault • storage battery • SCU • fuse • internal fault
Conditions for fault code operation
Turn the ignition switch to the ON position
Conditions for fault code setting
U2001-42
Write EEPROM fault
To set the effect of a fault code condition
Description of circuit diagram
SCU will always monitor whether the sensors and actuators are in the normal range. At the same time, it will also test the rationality of virtual connection, short circuit, open circuit and other signals. When a fault occurs, SCU will store the fault code corresponding to this fault.

Circuit diagram

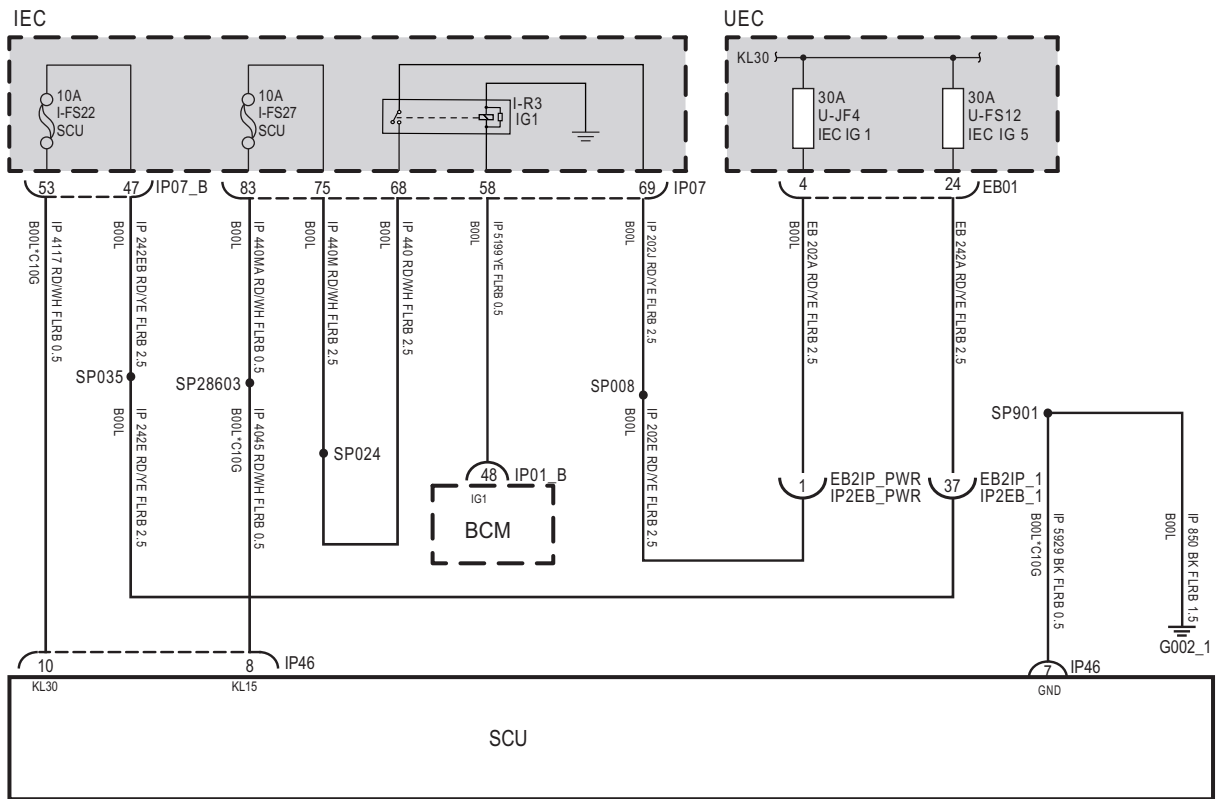

IP46

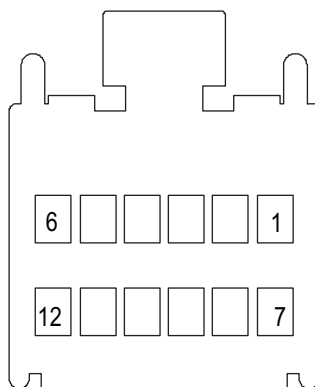

EK899101

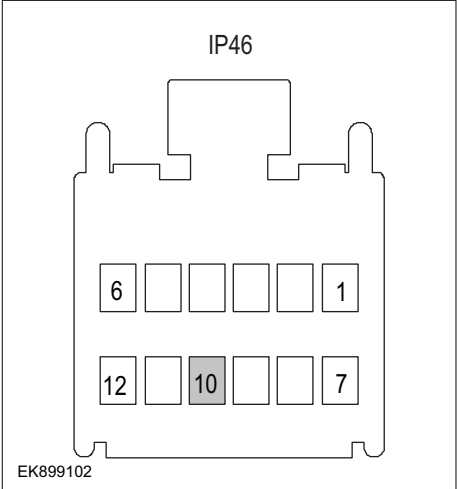
Troubleshooting steps	
Steps1	General inspection.
	<ol style="list-style-type: none"> 1 Check the fuse I-FS22、 I-FS27、 U-JF4、 U-FS12 for damage. 2 Check relay I-R3 for damage. 3 Check battery capacity. 4 Check the harness plug of SCU for damage, poor contact, aging and looseness. 5 Check whether the result is normal or not?
<p>NO → Repair or replace parts with detected faults.</p>	
<p>YES ↓</p>	
Steps2	Check fault codes.
	<ol style="list-style-type: none"> 1 Connect the scan tool to the diagnostic interface. 2 Turn the ignitiON switch to the on position. 3 Use diagnostic instrument to diagnose SCU. 4 If there is any fault code except for U2001-42?
<p>YES → Refer to:DTC Summary list (SCU).</p>	
<p>NO ↓</p>	
Steps3	Check the supply voltage of SCUstorage battery.
	<ol style="list-style-type: none"> 1 Turn on the ignition switch. 2 Measure the voltage between SCU harness terminal and ground. Measuring circuit: voltage between terminal 10 of IP46 plug and ground. Standard value:10~14V 3 Check whether the result is normal or not?
<p>NO → Repair or replace the faulted parts.</p>	
<p>YES ↓</p>	

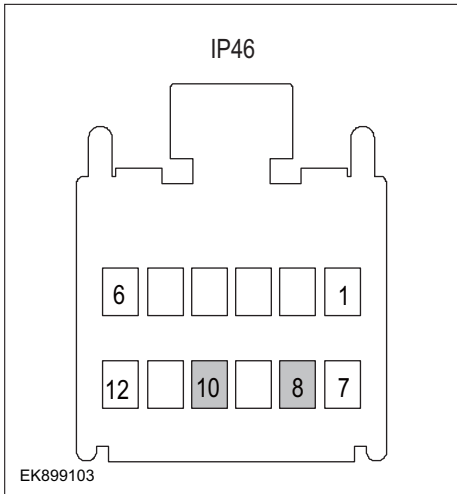
Steps4	Check the power supply voltage when SCU is started or running.
 <p style="text-align: center;">IP46</p> <p style="text-align: left; font-size: small;">EK899103</p>	<ol style="list-style-type: none"> 1 Turn on the ignition switch. 2 Measure the voltage between SCU harness terminal and ground. Measuring circuit: voltage between terminal 8 of IP46 plug and ground. Measuring circuit: voltage between terminal 10 of IP46 plug and ground. Standard value:10~14V 3 Check whether the result is normal or not?

NO → Repair or replace the faulted parts.

YES ↓

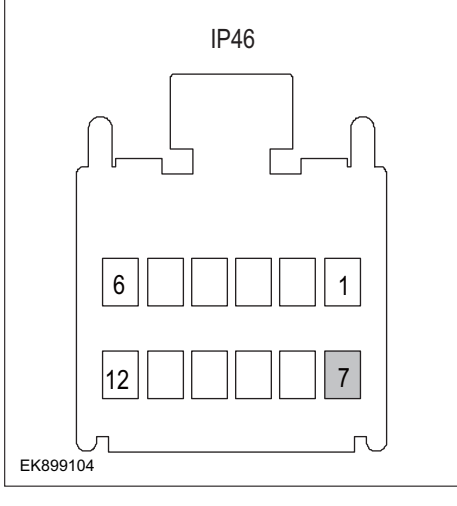
Steps5	Check SCU ground circuit for open circuit.
 <p style="text-align: center;">IP46</p> <p style="text-align: left; font-size: small;">EK899104</p>	<ol style="list-style-type: none"> 1 Turn off the ignition switch. 2 Measure the resistance between SCU harness plug and ground. Measuring circuit: resistance between terminal 7 of IP46 plug and ground. Standard value:< 1Ω 3 Is the resistance less than 1 ω?

NO → Repair or replace the faulted parts.

YES ↓

SCU

Steps6	Check whether SCU is abnormal.
	<ol style="list-style-type: none">1 Turn off the ignition switch.2 Disconnect and check the SCU harness plug IP46.3 Inspection and maintenance:<ul style="list-style-type: none">• Corrosion (install new connectors or terminals-clean module pins).• Damaged or bent pins-Install new terminals/pins.• Pin flying out-install new pins as needed.4 Reconnect the SCU plug and all other previously disconnected plugs. Make sure that the pins are properly positioned and fixed.5 Run the system and determine if the problem still exists?
	YES → Replace SCU.
NO ↓	
At this time, the system works normally. The cause of the problem may be module connection. Address the root cause of any connector or pin problem.	
Next Step ↓	
Diagnosis is over.	

U0151-87

Fault diagnosis code
U0151-87: lost communication with ABS
Detection tools
1 Multimeter and diagnostic apparatus
Possible causes
<ul style="list-style-type: none">• Circuit, terminal and adapting piece fault• SCU• CAN• Terminal resistance fault
Conditions for fault code operation
Turn the ignition switch to the ON position
Conditions for fault code setting
U0151-87
ABS message is lost for 1s.
To set the effect of a fault code condition
Description of circuit diagram

Circuit diagram

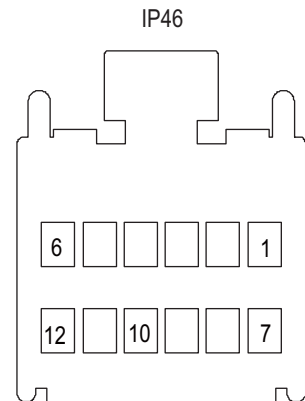
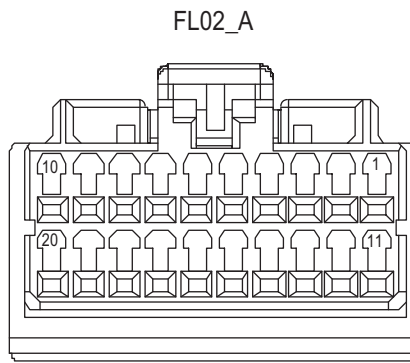
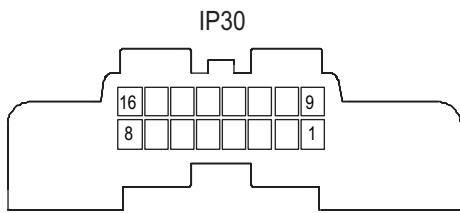
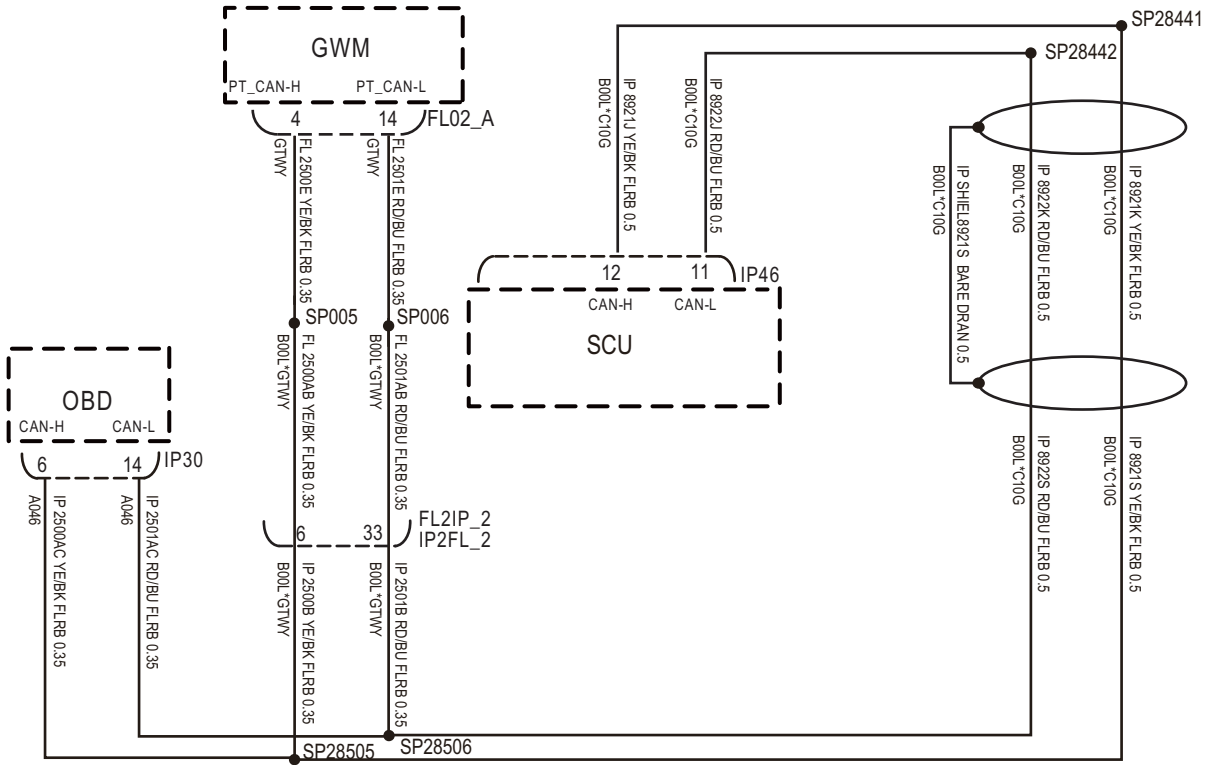

EK899105

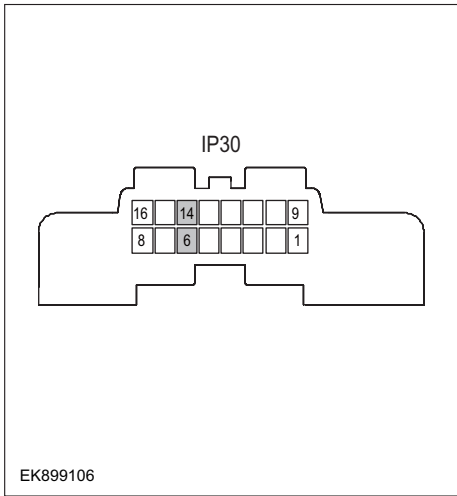
Troubleshooting steps											
Steps1	General inspection.										
	<ol style="list-style-type: none"> 1 Check the fuse for damage. 2 Check battery capacity. 3 Check the harness plug of SCU for damage, poor contact, aging and looseness. 4 Check whether the result is normal or not? 										
NO → Repair or replace parts with detected faults.											
YES ↓											
Steps2	Check fault codes.										
	<ol style="list-style-type: none"> 1 Connect the scan tool to the diagnostic interface. 2 Turn the ignitiON switch to the on position. 3 Use diagnostic instrument to diagnose SCU. 4 If there is any fault code except for U0151-87? 										
YES → Refer to: DTC Summary list (SCU) .											
NO ↓											
Steps3	Check the integrity of CAN communication network.										
 <p style="text-align: center;">IP30</p> <p style="text-align: center;"> <table border="1" style="margin: auto;"> <tr> <td>16</td> <td>14</td> <td></td> <td></td> <td>9</td> </tr> <tr> <td>8</td> <td>6</td> <td></td> <td></td> <td>1</td> </tr> </table> </p> <p>EK899106</p>	16	14			9	8	6			1	<ol style="list-style-type: none"> 1 Turn off the ignition switch. 2 Measure the resistance between diagnostic interface harness terminals. Measuring circuit: resistance between terminal 6 and terminal 14 of IP30 plug. Standard value: ≈ 60Ω 3 Check whether the result is normal or not?
16	14			9							
8	6			1							
NO → Repair or replace the faulted parts.											
YES ↓											

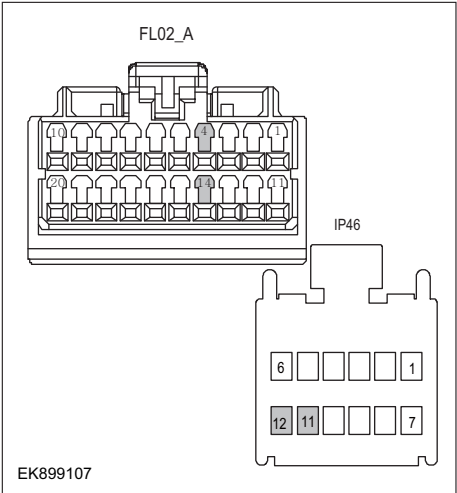
Steps4	Check the resistance of gateway module and SCU terminal.
	<ol style="list-style-type: none"> 1 Turn off the ignition switch. 2 Disconnect the gateway module harness plug FL02 _ A. 3 Measure the resistance between the gateway module harness terminals. Measuring circuit: resistance between terminal 4 and terminal 14 of FL02_A plug. Standard value:110~130Ω 4 Connect the gateway module harness plug FL02 _ A. 5 Disconnect SCU harness plug IP46. 6 Measure the resistance between terminals of SCU harness. Measuring circuit: resistance between terminal 11 and terminal 12 of IP46 plug. Standard value:110~130Ω 7 Check whether the result is normal or not?
NO → Repair or replace the faulted parts.	
YES ↓	
Steps6	Check whether SCU is abnormal.
	<ol style="list-style-type: none"> 1 Turn off the ignition switch. 2 Disconnect and check the SCU harness plug IP46. 3 Inspection and maintenance: <ul style="list-style-type: none"> • Corrosion (install new connectors or terminals-clean module pins). • Damaged or bent pins-Install new terminals/pins. • Pin flying out-install new pins as needed. 4 Reconnect the SCU plug and all other previously disconnected plugs. Make sure that the pins are properly positioned and fixed. 5 Run the system and determine if the problem still exists?
YES → Replace SCU.	
NO ↓	
At this time, the system works normally. The cause of the problem may be module connection. Address the root cause of any connector or pin problem.	
Next Step ↓	
Diagnosis is over.	

U0101-00

Fault diagnosis code
U0101-00: lost communication with VCU
Detection tools
1 Multimeter and diagnostic apparatus
Possible causes
<ul style="list-style-type: none"> • Circuit, terminal and adapting piece fault • SCU • CAN • Terminal resistance fault
Conditions for fault code operation
Turn the ignition switch to the ON position
Conditions for fault code setting
U0101-00
VCU message is lost and lasts for 1s.
To set the effect of a fault code condition
Description of circuit diagram

Circuit diagram

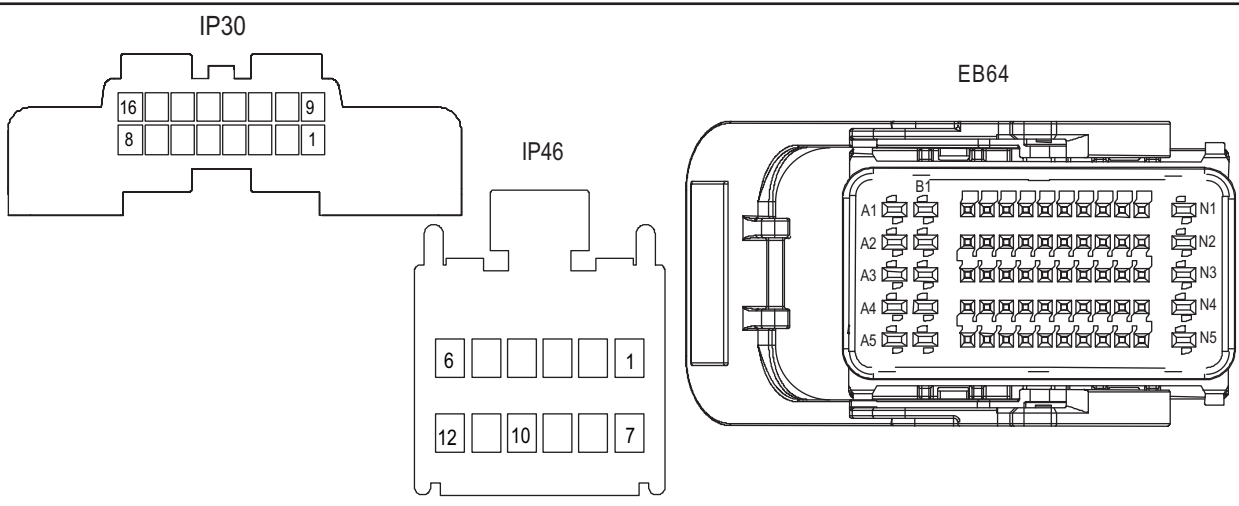
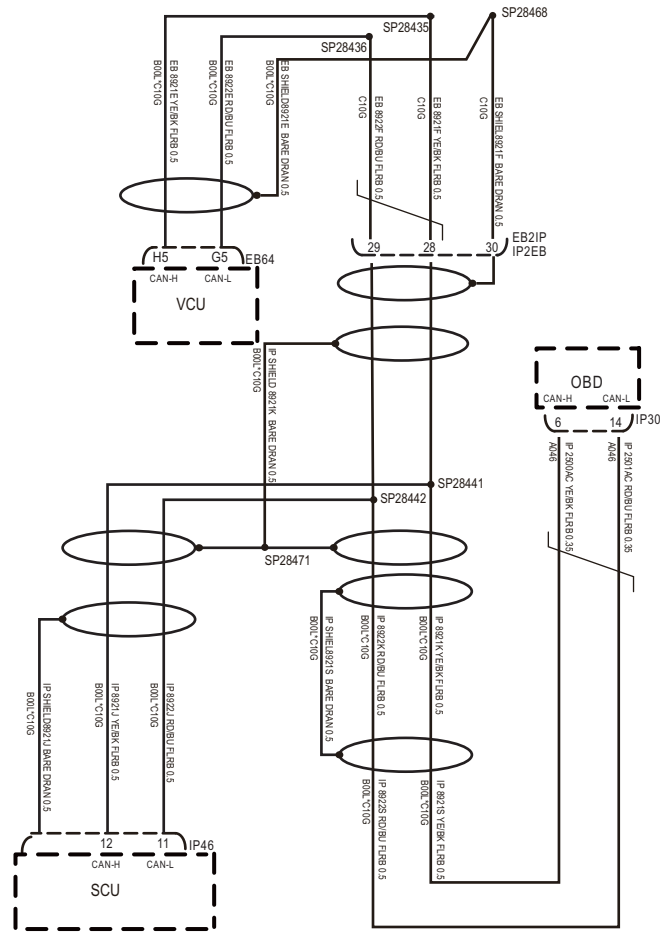

EK899108

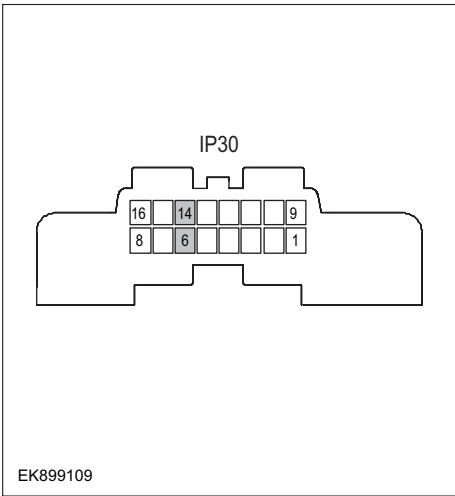
Troubleshooting steps	
Steps1	General inspection.
	<ol style="list-style-type: none"> 1 Check the fuse for damage. 2 Check battery capacity. 3 Check the harness plug of SCU for damage, poor contact, aging and looseness. 4 Check whether the result is normal or not?
NO → Repair or replace parts with detected faults.	
YES ↓	
Steps2	Check fault codes.
	<ol style="list-style-type: none"> 1 Connect the scan tool to the diagnostic interface. 2 Turn the ignitiON switch to the on position. 3 Use diagnostic instrument to diagnose SCU. 4 If there is any fault code except for U0101-00?
YES → Refer to: DTC Summary list (SCU) .	
NO ↓	
Steps3	Check the integrity of CAN communication network.
 <p style="text-align: center;">IP30</p> <p style="text-align: center;">EK899109</p>	<ol style="list-style-type: none"> 1 Turn off the ignition switch. 2 Measure the resistance between diagnostic interface harness terminals. Measuring circuit: resistance between terminal 6 and terminal 14 of IP30 plug. Standard value: ≈ 60Ω 3 Check whether the result is normal or not?
NO → Repair or replace the faulted parts.	
YES ↓	

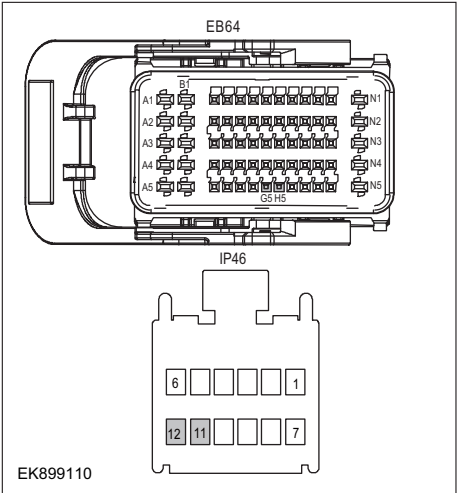
Steps4	Check VCU module and SCU terminal resistance.
	<ol style="list-style-type: none"> 1 Turn off the ignition switch. 2 Disconnect the VCU module harness plug EB64. 3 Measure the resistance between VCU module harness terminals. Measuring circuit: resistance between terminal H5 and terminal G5 of EB64 plug. Standard value:110~130Ω 4 Connect the VCU module harness plug EB64. 5 Disconnect SCU harness plug IP46. 6 Measure the resistance between terminals of SCU harness. Measuring circuit: resistance between terminal 11 and terminal 12 of IP46 plug. Standard value:110~130Ω 7 Check whether the result is normal or not?
<p>NO → Repair or replace the faulted parts.</p>	
<p>YES ↓</p>	
Steps6	Check whether SCU is abnormal.
	<ol style="list-style-type: none"> 1 Turn off the ignition switch. 2 Disconnect and check the SCU harness plug IP46. 3 Inspection and maintenance: <ul style="list-style-type: none"> • Corrosion (install new connectors or terminals-clean module pins). • Damaged or bent pins-Install new terminals/pins. • Pin flying out-install new pins as needed. 4 Reconnect the SCU plug and all other previously disconnected plugs. Make sure that the pins are properly positioned and fixed. 5 Run the system and determine if the problem still exists?
<p>YES → Replace SCU.</p>	
<p>NO ↓</p>	
<p>At this time, the system works normally. The cause of the problem may be module connection. Address the root cause of any connector or pin problem.</p>	
<p>Next Step ↓</p>	
<p>Diagnosis is over.</p>	

U0073-00

Fault diagnosis code
U0073-00: CAN bus of
Detection tools
1 Multimeter and diagnostic apparatus
Possible causes
<ul style="list-style-type: none">• Circuit,terminal and adapting piece fault• SCU• CAN• Terminal resistance fault
Conditions for fault code operation
Turn the ignition switch to the ON position
Conditions for fault code setting
U0073-00
Busoff occurred three times in a row.
To set the effect of a fault code condition
Description of circuit diagram

Circuit diagram

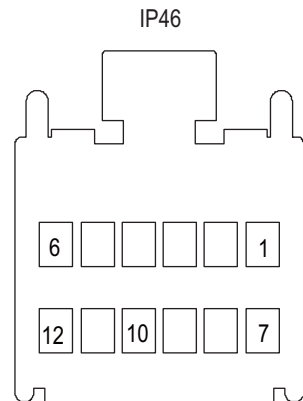
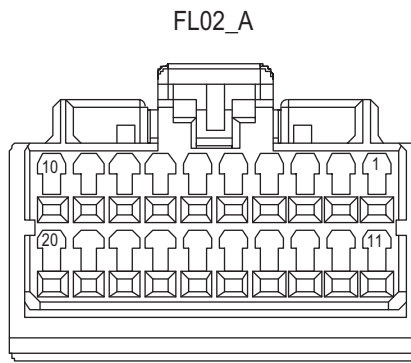
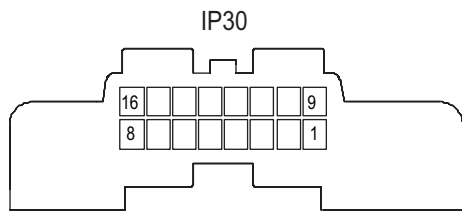
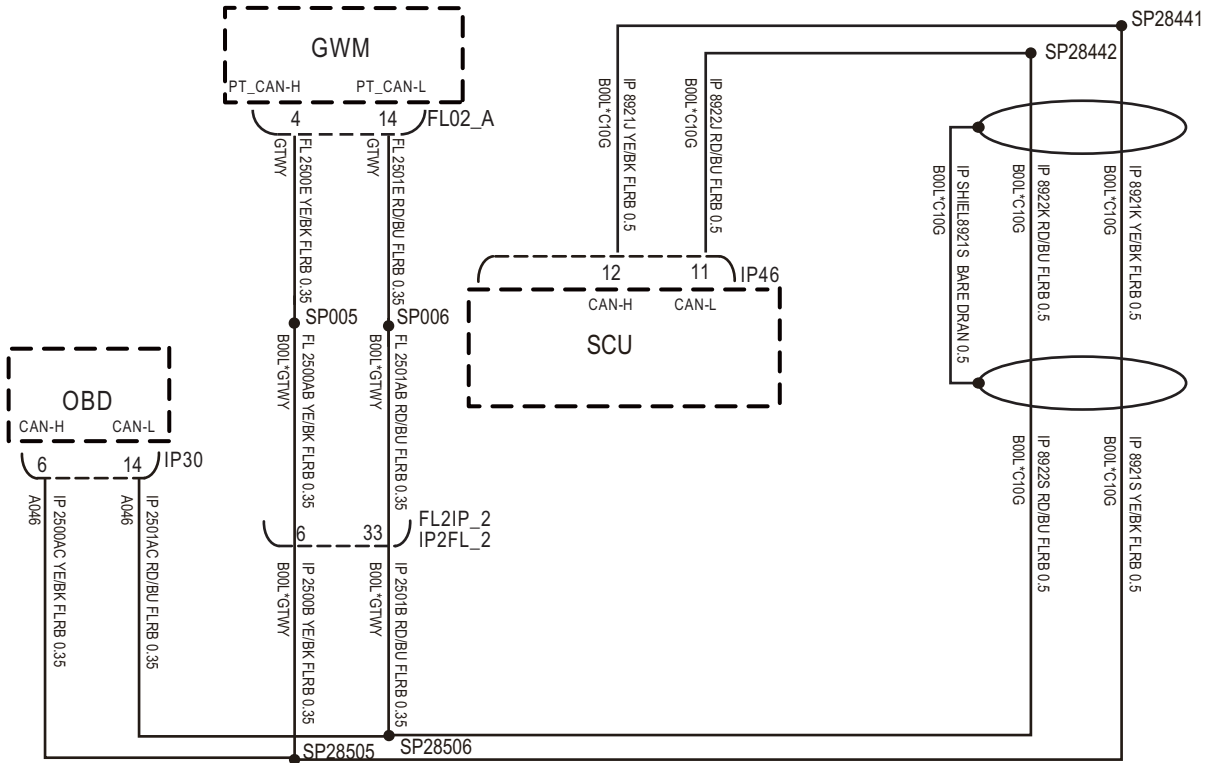

EK899105

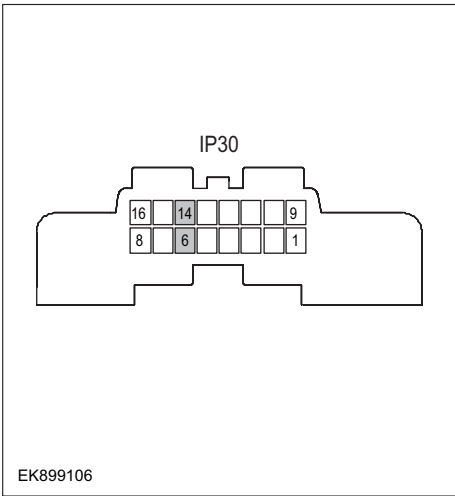
Troubleshooting steps	
Steps1	General inspection.
	<ol style="list-style-type: none"> 1 Check the fuse for damage. 2 Check battery capacity. 3 Check the harness plug of SCU for damage, poor contact, aging and looseness. 4 Check whether the result is normal or not?
NO → Repair or replace parts with detected faults.	
YES ↓	
Steps2	Check fault codes.
	<ol style="list-style-type: none"> 1 Connect the scan tool to the diagnostic interface. 2 Turn the ignitiON switch to the on position. 3 Use diagnostic instrument to diagnose SCU. 4 If there is any fault code except for U0073-00?
YES → Refer to: DTC Summary list (SCU) .	
NO ↓	
Steps3	Check the integrity of CAN communication network.
	<ol style="list-style-type: none"> 1 Turn off the ignition switch. 2 Measure the resistance between diagnostic interface harness terminals. Measuring circuit: resistance between terminal 6 and terminal 14 of IP30 plug. Standard value: ≈ 60Ω 3 Check whether the result is normal or not?
NO → Repair or replace the faulted parts.	
YES ↓	

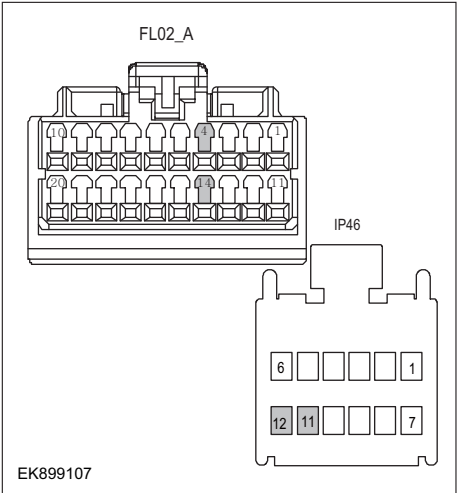
Steps4	Check the resistance of gateway module and SCU terminal.
	<ol style="list-style-type: none"> 1 Turn off the ignition switch. 2 Disconnect the gateway module harness plug FL02 _ A. 3 Measure the resistance between the gateway module harness terminals. Measuring circuit: resistance between terminal 4 and terminal 14 of FL02_A plug. Standard value:110~130Ω 4 Connect the gateway module harness plug FL02 _ A. 5 Disconnect SCU harness plug IP46. 6 Measure the resistance between terminals of SCU harness. Measuring circuit: resistance between terminal 11 and terminal 12 of IP46 plug. Standard value:110~130Ω 7 Check whether the result is normal or not?
NO → Repair or replace the faulted parts.	
YES ↓	
Steps6	Check whether SCU is abnormal.
	<ol style="list-style-type: none"> 1 Turn off the ignition switch. 2 Disconnect and check the SCU harness plug IP46. 3 Inspection and maintenance: <ul style="list-style-type: none"> • Corrosion (install new connectors or terminals-clean module pins). • Damaged or bent pins-Install new terminals/pins. • Pin flying out-install new pins as needed. 4 Reconnect the SCU plug and all other previously disconnected plugs. Make sure that the pins are properly positioned and fixed. 5 Run the system and determine if the problem still exists?
YES → Replace SCU.	
NO ↓	
At this time, the system works normally. The cause of the problem may be module connection. Address the root cause of any connector or pin problem.	
Next Step ↓	
Diagnosis is over.	

DTC Summary list (TIM)

DTC	English descriptions	Reference page
U1562-17	The battery voltage is too high	U1562-17, U1563-16
U1563-16	The battery voltage is too low	
U0073-88	The control module communication bus is turned off	U0073-88
U0140-87	Communication with IBDU is lost	U0140-87
B100D-11	The left position lamp is overloaded or shorted to ground	B100D-11
B100E-11	The right position lamp is overloaded or shorted to ground	B100E-11
B1002-11	The rear brake light is overloaded or short-circuited to ground	B1002-11
B1001-11	The rear fog lamps are overloaded or shorted to ground	B1001-11
B1007-11	The right turn signal is overloaded or shorted to ground	B1007-11
B1006-11	The left turn signal is overloaded or shorted to ground	B1006-11
B1000-11	The reversing lights are overloaded or shorted to ground	B1000-11

U1562-17、 U1563-16

Fault diagnosis code
U1562-17: Battery voltage is too high
U1563-16: The battery voltage is too low
Detection tools
1 Multimeter and diagnostic apparatus
Possible causes of failure
<ul style="list-style-type: none"> • Lines, terminals or connectors • storage battery • TIM • fuse
Conditions for fault code operation
Turn the ignition switch to the ON position
Conditions for fault code setting
U1562-17
iBDU Voltage below Low_Threshold
U1563-16
iBDU Voltage is higher than High_Threshold
To set the effect of a fault code condition
Description of circuit diagram
TIM module will always monitor whether the sensor and actuator are in the normal range. At the same time, it will also test the rationality of virtual connection, short circuit, open circuit and other signals. When a fault occurs, the TIM module will store the fault code corresponding to this fault.

Circuit diagram

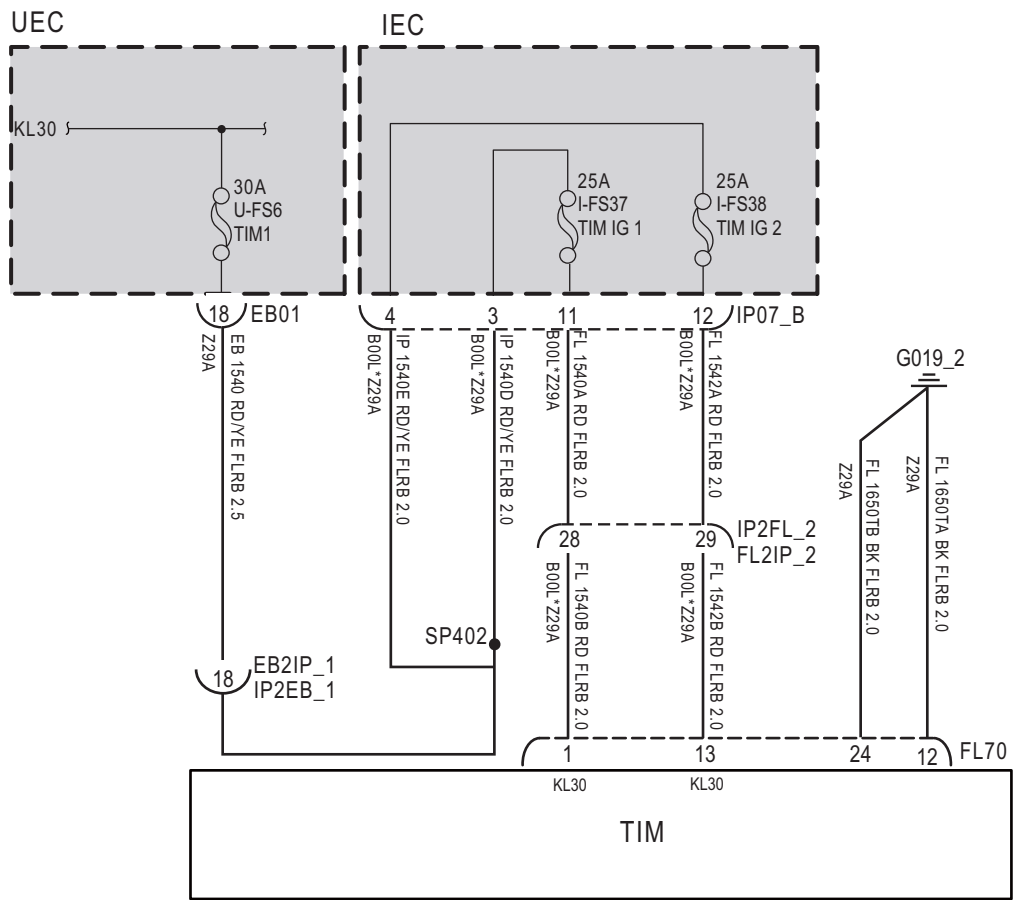

FL70

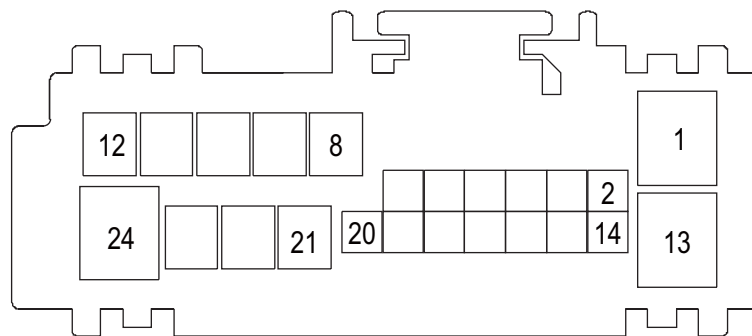

EK909201

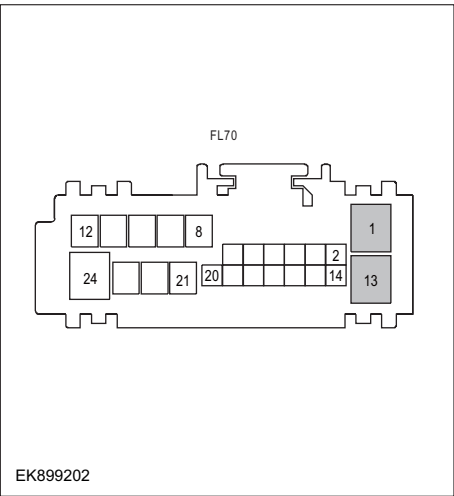
Troubleshooting steps	
Step1	General inspection.
	<ol style="list-style-type: none"> 1 Check fuse U-FS6、I-FS37、I-FS38 Whether it is damaged. 2 Check whether the battery is fully charged. 3 Check the wire harness plug of TIM module for damage, poor contact, aging and looseness. 4 Is the inspection result normal?
	NO → Repair or replace parts with detected faults.
YES ↓	
Step2	Check the fault code.
	<ol style="list-style-type: none"> 1 Connect the scan tool to the diagnostic interface. 2 Turn the ignition switch to the on position. 3 Use the diagnostic instrument to diagnose the TIM module. 4 Are there any fault codes other than U1562-17、U1563-16?
	YES → Refer to: DTC Summary list (TIM) .
NO ↓	
Step3	Check the battery supply voltage of TIM .
 <p>FL70</p> <p>EK899202</p>	<ol style="list-style-type: none"> 1 Turn on the ignition switch. 2 Measure the voltage between TIM harness terminal and ground. Measuring circuit: voltage between terminal 1 of FL70 plug and ground. Measuring circuit: voltage between terminal 13 of FL70 plug and ground. Standard value:10~14V 3 Is the inspection result normal?
	NO → Repair or replace parts with detected faults.
YES ↓	

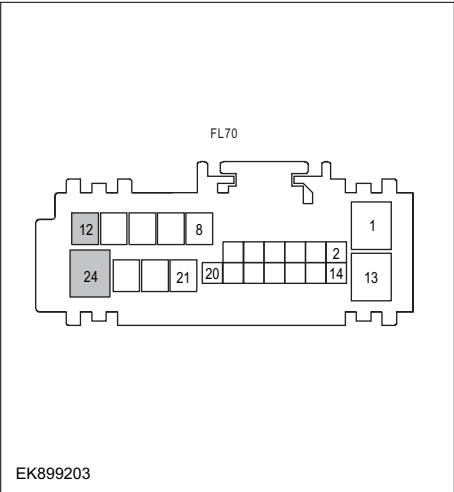
Step4	Check the TIM module ground circuit for an open circuit.
	<ol style="list-style-type: none"> 1 Turn off the ignition switch. 2 Measure the resistance between TIM module harness plug and ground. Measuring circuit: resistance between terminal 12 of FL70 plug and ground. Measuring circuit: resistance between terminal 24 of FL70 plug and ground. Standard value:< 1Ω 3 Is the resistance less than 1 ω?
NO → Repair or replace parts with detected faults.	
YES ↓	
Step5	Check whether the TIM module is abnormal.
	<ol style="list-style-type: none"> 1 Turn off the ignition switch. 2 Disconnect and inspect the wire harness plug FL70 of TIM module. 3 Inspection and maintenance: <ul style="list-style-type: none"> • Corrosion (install new connectors or terminals-clean module pins). • Damaged or bent pins-Install new terminals/pins. • Pin flying out-install new pins as needed. 4 Reconnect the TIM plug and all other previously disconnected plugs. Make sure that the pins are properly positioned and fixed. 5 Run the system and determine if the problem still exists?
YES → Replace the TIM .	
NO ↓	
At this time, the system works normally. The cause of the problem may be module connection. Address the root cause of any connector or pin problem.	
Next Step ↓	
Diagnosis is over.	

U0073-88

Fault diagnosis code
U0073-88: The control module communication bus is turned off
Detection tools
1 Multimeter and diagnostic apparatus
Possible causes of failure
<ul style="list-style-type: none">• Lines, terminals or connectors• TIM• CAN
Conditions for fault code operation
Turn the ignition switch to the ON position
Conditions for fault code setting
U0073-88
CAN Bus OFF
To set the effect of a fault code condition
Description of circuit diagram

Circuit diagram

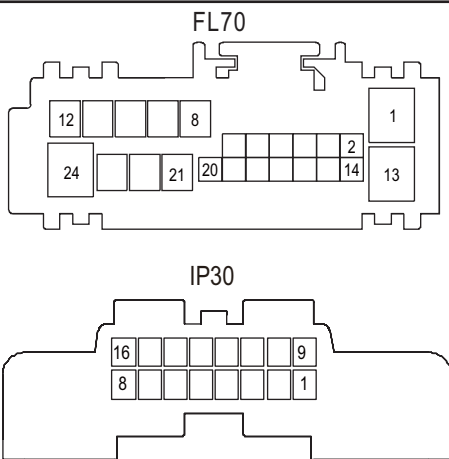
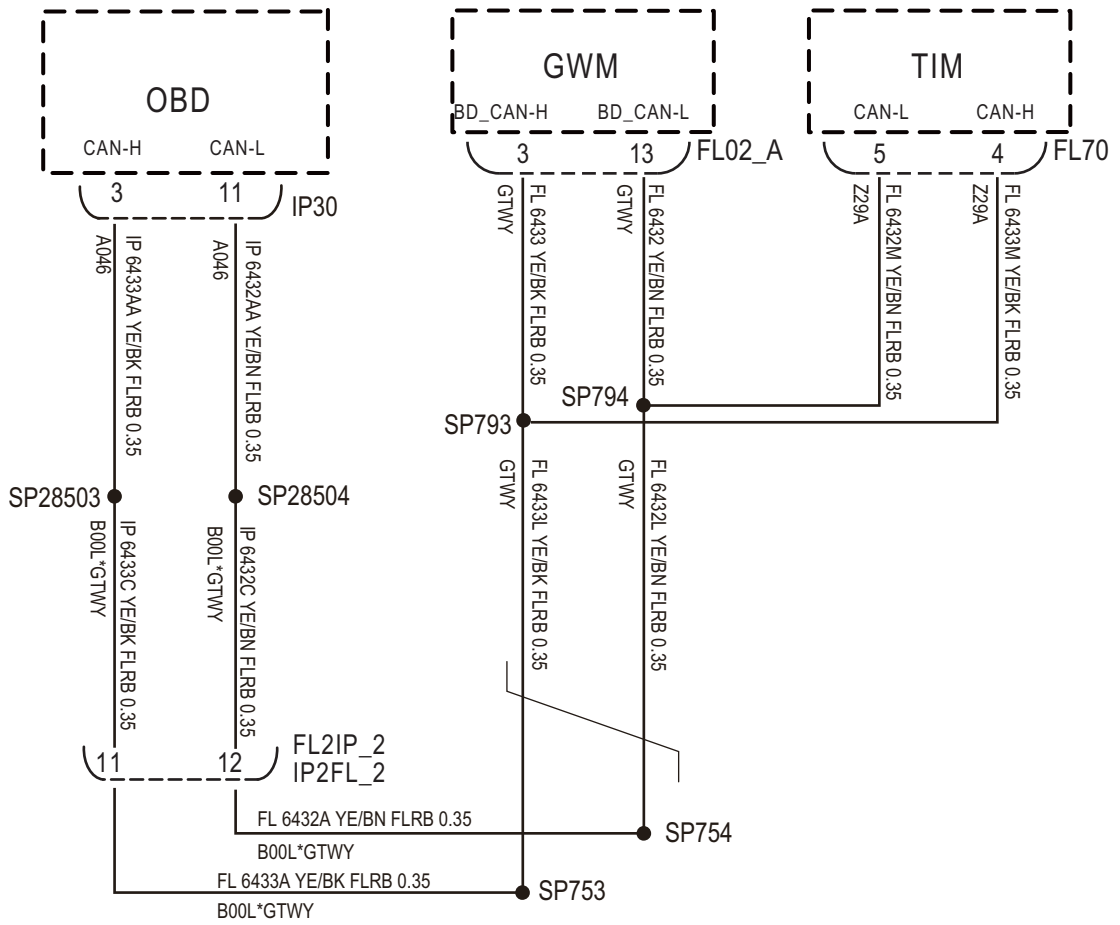

EK909204

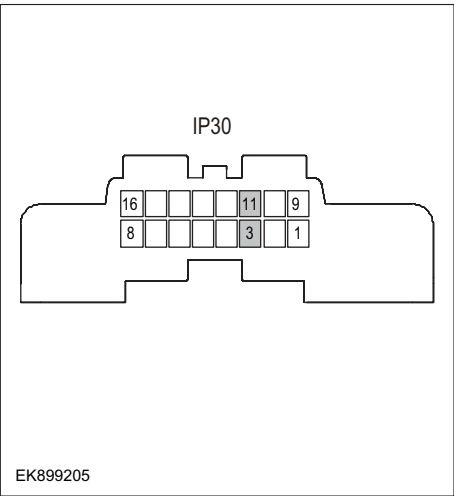
Troubleshooting steps	
Step1	General inspection.
	<ol style="list-style-type: none"> 1 Check fuse Whether it is damaged. 2 Check whether the battery is fully charged. 3 Check the wire harness plug of TIM module for damage, poor contact, aging and looseness. 4 Is the inspection result normal?
	NO → Repair or replace parts with detected faults.
YES ↓	
Step2	Check the fault code.
	<ol style="list-style-type: none"> 1 Connect the scan tool to the diagnostic interface. 2 Turn the ignitiON switch to the on position. 3 Use the diagnostic instrument to diagnose the TIM module. 4 Are there any fault codes other than U0073-88?
	YES → Refer to: DTC Summary list (TIM) .
NO ↓	
Step3	Check the integrity of CAN communication network.
	<ol style="list-style-type: none"> 1 Turn off the ignition switch. 2 Measure the resistance between diagnostic interface harness terminals. Measuring circuit: resistance between terminal 3 and terminal 11 of IP30 plug. Standard value: ≈ 60Ω 3 Is the inspection result normal?
	NO → Repair or replace parts with detected faults.
YES ↓	

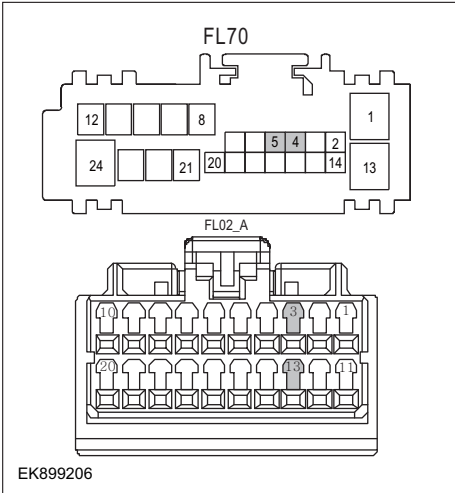
Step4	Check the resistance of gateway module and TIM terminal.
	<ol style="list-style-type: none"> 1 Turn off the ignition switch. 2 Disconnect the gateway module harness plug FL02 _ A. 3 Measure the resistance between the gateway module harness terminals. Measuring circuit: resistance between terminal 3 and terminal 13 of FL02_A plug. Standard value:110~130Ω 4 Connect the gateway module harness plug FL02 _ A. 5 Disconnect TIM wire harness plug FL70. 6 Measure the resistance between TIM harness terminals. Measuring circuit: resistance between terminal 5 and terminal 4 of FL70 plug. Standard value:110~130Ω 7 Is the inspection result normal?
<p>NO → Repair or replace parts with detected faults.</p>	
<p>YES ↓</p>	
Step6	Check whether the TIM module is abnormal.
	<ol style="list-style-type: none"> 1 Turn off the ignition switch. 2 Disconnect and inspect the wire harness plug FL70 of TIM module. 3 Inspection and maintenance: <ul style="list-style-type: none"> • Corrosion (install new connectors or terminals-clean module pins). • Damaged or bent pins-Install new terminals/pins. • Pin flying out-install new pins as needed. 4 Reconnect the TIM plug and all other previously disconnected plugs. Make sure that the pins are properly positioned and fixed. 5 Run the system and determine if the problem still exists?
<p>YES → Replace the TIM .</p>	
<p>NO ↓</p>	
<p>At this time, the system works normally. The cause of the problem may be module connection. Address the root cause of any connector or pin problem.</p>	
<p>Next Step ↓</p>	
<p>Diagnosis is over.</p>	

U0140-87

Fault diagnosis code
U0140-87: Communication with IBDU is lost
Detection tools
1 Multimeter and diagnostic apparatus
Possible causes of failure
<ul style="list-style-type: none">• Lines, terminals or connectors• TIM• CAN
Conditions for fault code operation
Turn the ignition switch to the ON position
Conditions for fault code setting
U0140-87
Lost contact with IBDU
To set the effect of a fault code condition
Description of circuit diagram

Circuit diagram

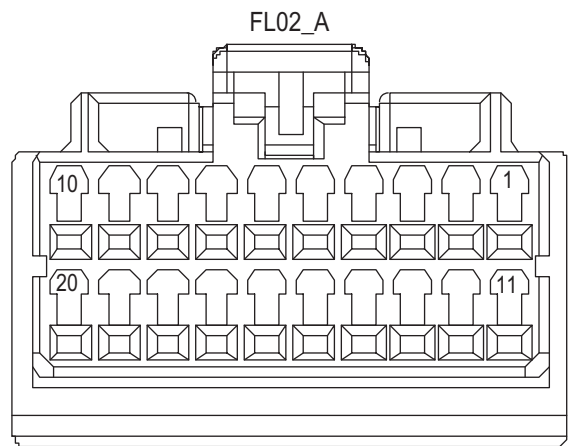
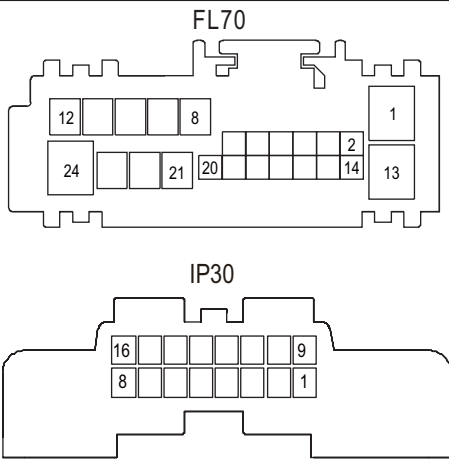
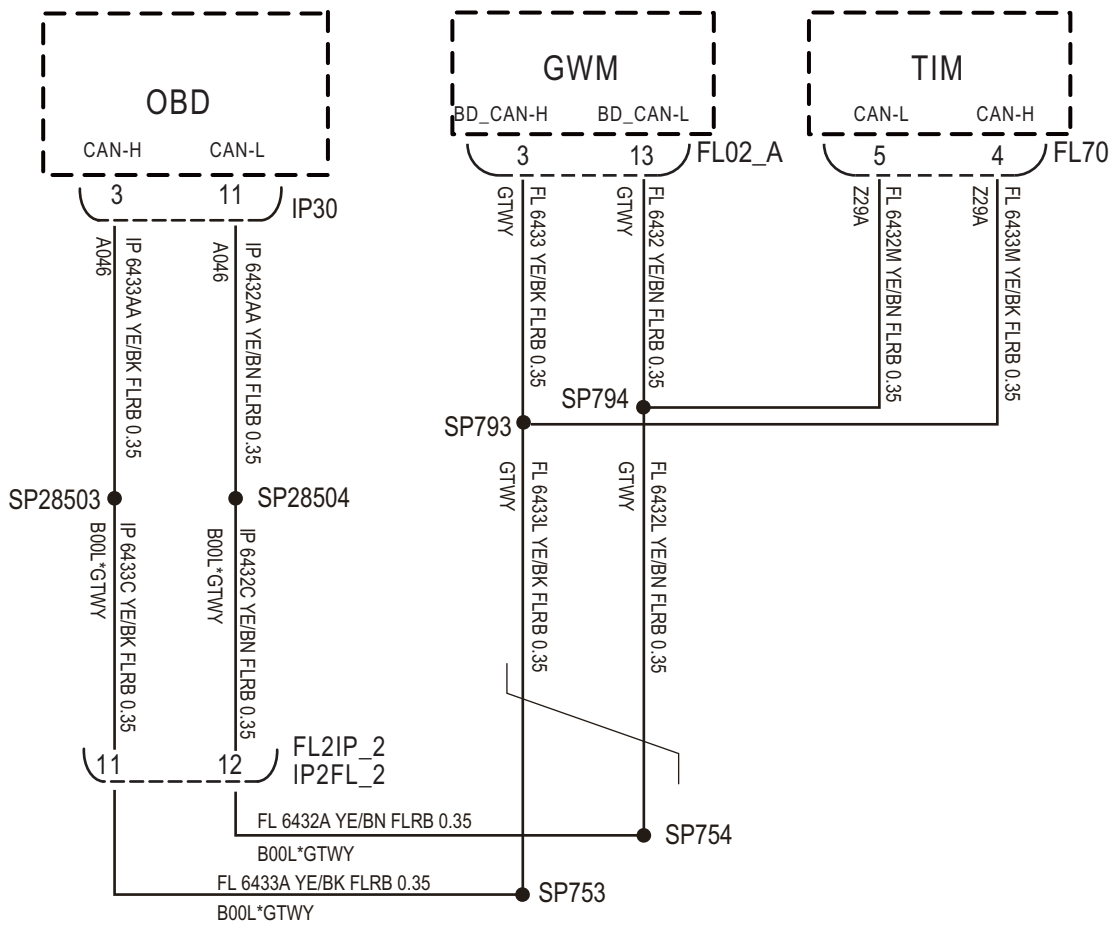

EK909204

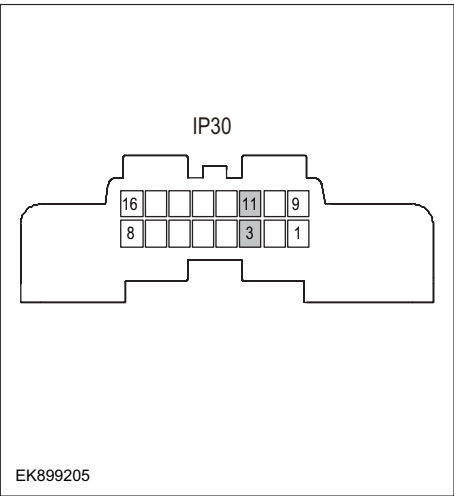
Troubleshooting steps	
Step1	General inspection.
	<ol style="list-style-type: none"> 1 Check fuse Whether it is damaged. 2 Check whether the battery is fully charged. 3 Check the wire harness plug of TIM module for damage, poor contact, aging and looseness. 4 Is the inspection result normal?
	NO → Repair or replace parts with detected faults.
YES ↓	
Step2	Check the fault code.
	<ol style="list-style-type: none"> 1 Connect the scan tool to the diagnostic interface. 2 Turn the ignitiON switch to the on position. 3 Use the diagnostic instrument to diagnose the TIM module. 4 Are there any fault codes other than U0140-87?
	YES → Refer to: DTC Summary list (TIM) .
NO ↓	
Step3	Check the integrity of CAN communication network.
	<ol style="list-style-type: none"> 1 Turn off the ignition switch. 2 Measure the resistance between diagnostic interface harness terminals. Measuring circuit: resistance between terminal 3 and terminal 11 of IP30 plug. Standard value: ≈ 60Ω 3 Is the inspection result normal?
	NO → Repair or replace parts with detected faults.
YES ↓	

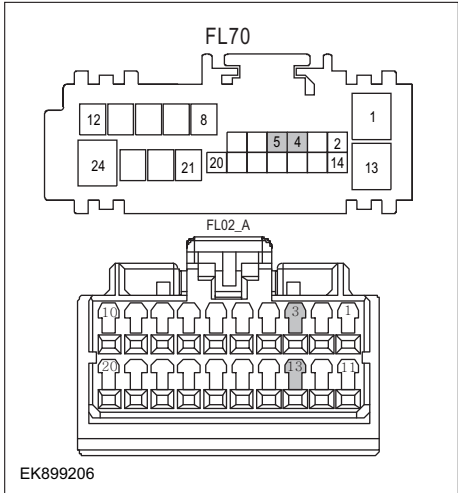
Step4	Check the resistance of gateway module and TIM terminal.
	<ol style="list-style-type: none"> 1 Turn off the ignition switch. 2 Disconnect the gateway module harness plug FL02 _ A. 3 Measure the resistance between the gateway module harness terminals. Measuring circuit: resistance between terminal 3 and terminal 13 of FL02_A plug. Standard value:110~130Ω 4 Connect the gateway module harness plug FL02 _ A. 5 Disconnect TIM wire harness plug FL70. 6 Measure the resistance between TIM harness terminals. Measuring circuit: resistance between terminal 5 and terminal 4 of FL70 plug. Standard value:110~130Ω 7 Is the inspection result normal?
<p>NO → Repair or replace parts with detected faults.</p>	
<p>YES ↓</p>	
Step6	Check whether the TIM module is abnormal.
	<ol style="list-style-type: none"> 1 Turn off the ignition switch. 2 Disconnect and inspect the wire harness plug FL70 of TIM module. 3 Inspection and maintenance: <ul style="list-style-type: none"> • Corrosion (install new connectors or terminals-clean module pins). • Damaged or bent pins-Install new terminals/pins. • Pin flying out-install new pins as needed. 4 Reconnect the TIM plug and all other previously disconnected plugs. Make sure that the pins are properly positioned and fixed. 5 Run the system and determine if the problem still exists?
<p>YES → Replace the TIM .</p>	
<p>NO ↓</p>	
<p>At this time, the system works normally. The cause of the problem may be module connection. Address the root cause of any connector or pin problem.</p>	
<p>Next Step ↓</p>	
<p>Diagnosis is over.</p>	

B100D-11

Fault diagnosis code
B100D-11: The left position lamp is overloaded or shorted to ground
Detection tools
1 Multimeter and diagnostic apparatus
Possible causes of failure
<ul style="list-style-type: none">• Lines, terminals or connectors• storage battery• TIM• fuse
Conditions for fault code operation
Turn the ignition switch to the ON position
Conditions for fault code setting
B100D-11
Position Lamp_Left circuit is short to ground.
To set the effect of a fault code condition
Description of circuit diagram
TIM module will always monitor whether the sensor and actuator are in the normal range. At the same time, it will also test the rationality of virtual connection, short circuit, open circuit and other signals. When a fault occurs, the TIM module will store the fault code corresponding to this fault.

Circuit diagram

UEC

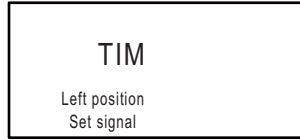
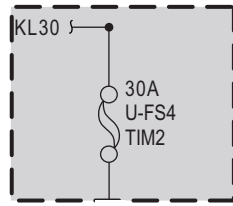

Z29A

EB 8009D RD/YE FLRB 2.0

29 EB2CH
CH2EB

Z29A

CH 8009E RD/YE FLRB 2.0

9

21 FL70

Z29A

FL 8005D GY FLRB 0.5

13

Z29A

CH 8005E GY FLRB 0.5

7

7

11

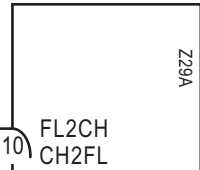

CH2TRAILER
TRAILER2CH

Z29A

FL 2250AA BK FLRB 2.0

G021_3

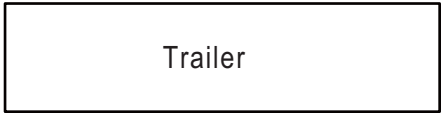

FL70

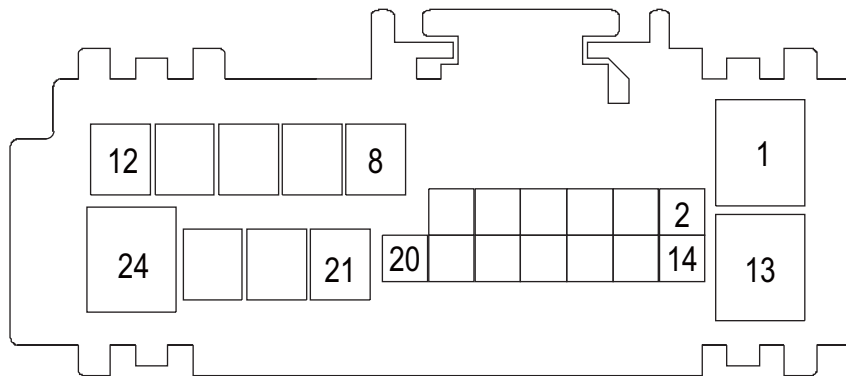

EK909207

Troubleshooting steps	
Step1	General inspection.
	<ol style="list-style-type: none"> 1 Check fuse U-FS4 Whether it is damaged. 2 Check whether the battery is fully charged. 3 Check the wire harness plug of TIM module for damage, poor contact, aging and looseness. 4 Is the inspection result normal?
	NO → Repair or replace parts with detected faults.
YES ↓	
Step2	Check the fault code.
	<ol style="list-style-type: none"> 1 Connect the scan tool to the diagnostic interface. 2 Turn the ignitiON switch to the on position. 3 Use the diagnostic instrument to diagnose the TIM module. 4 Are there any fault codes other than B100D-11?
	YES → Refer to: DTC Summary list (TIM) .
NO ↓	
Step3	Check the supply voltage of trailer battery.
	<ol style="list-style-type: none"> 1 Turn on the ignition switch. 2 Measure the voltage between trailer harness terminal and ground. Measuring circuit: voltage between terminal 9 of trailer harness plug and ground. Standard value:10~14V 3 Is the inspection result normal?
	NO → Repair or replace parts with detected faults.
YES ↓	

Step4	Check the trailer ground circuit for an open circuit.
	<ol style="list-style-type: none"> 1 Turn off the ignition switch. 2 Measure the resistance between harness plug of trailer harness and ground. Measuring circuit: resistance between No.11 terminal of trailer harness plug and ground. Standard value:< 1Ω 3 Is the resistance less than 1 ω?
	NO → Repair or replace parts with detected faults.
YES ↓	
Step5	Check left position lamp circuit (open circuit).
	<ol style="list-style-type: none"> 1 Turn off the ignition switch. 2 Disconnect TIM module harness plug. 3 Disconnect the trailer harness plug. 4 Measure the resistance between trailer harness terminal and TIM module harness terminal. Measuring circuit: resistance between terminal 7 of trailer plug and terminal 21 of TIM plug. Standard value: ≈ 0Ω 5 Is the inspection result normal?
	NO → Repair or replace parts with detected faults.
YES ↓	

TIM

Step5	Check whether the TIM module is abnormal.
	<ol style="list-style-type: none">1 Turn off the ignition switch.2 Disconnect and inspect the wire harness plug FL70 of TIM module.3 Inspection and maintenance:<ul style="list-style-type: none">• Corrosion (install new connectors or terminals-clean module pins).• Damaged or bent pins-Install new terminals/pins.• Pin flying out-install new pins as needed.4 Reconnect the TIM plug and all other previously disconnected plugs. Make sure that the pins are properly positioned and fixed.5 Run the system and determine if the problem still exists?
	YES → Replace the TIM .
NO ↓	
At this time, the system works normally. The cause of the problem may be module connection. Address the root cause of any connector or pin problem.	
Next Step ↓	
Diagnosis is over.	

B100E-11

Fault diagnosis code
B100E-11: The right position lamp is overloaded or shorted to ground
Detection tools
1 Multimeter and diagnostic apparatus
Possible causes of failure
<ul style="list-style-type: none"> • Lines, terminals or connectors • storage battery • TIM • fuse
Conditions for fault code operation
Turn the ignition switch to the ON position
Conditions for fault code setting
B100E-11
Position Lamp_Right circuit is short to ground.
To set the effect of a fault code condition
Description of circuit diagram
TIM module will always monitor whether the sensor and actuator are in the normal range. At the same time, it will also test the rationality of virtual connection, short circuit, open circuit and other signals. When a fault occurs, the TIM module will store the fault code corresponding to this fault.

Circuit diagram

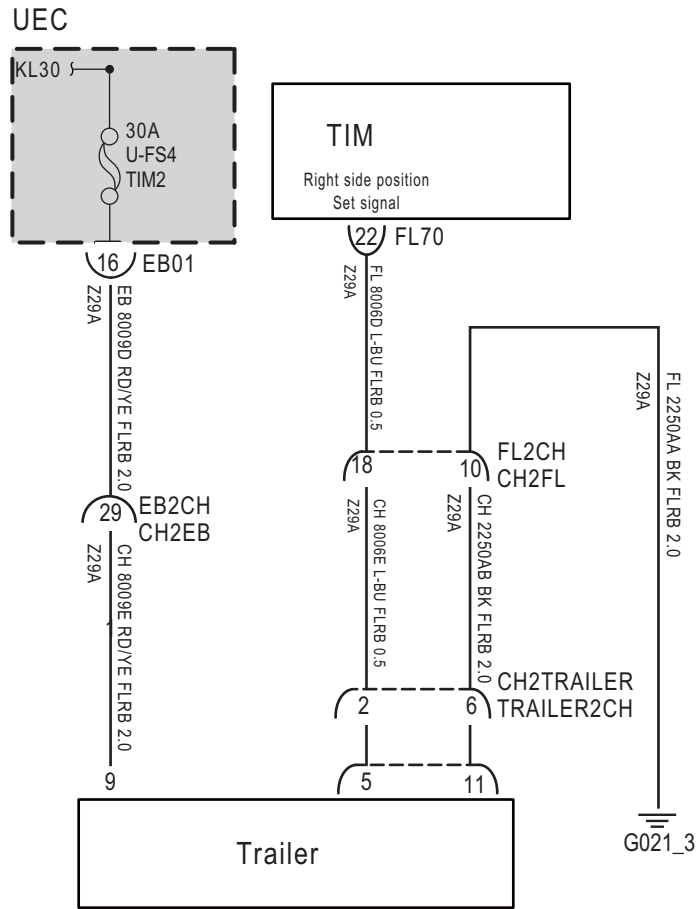

FL70

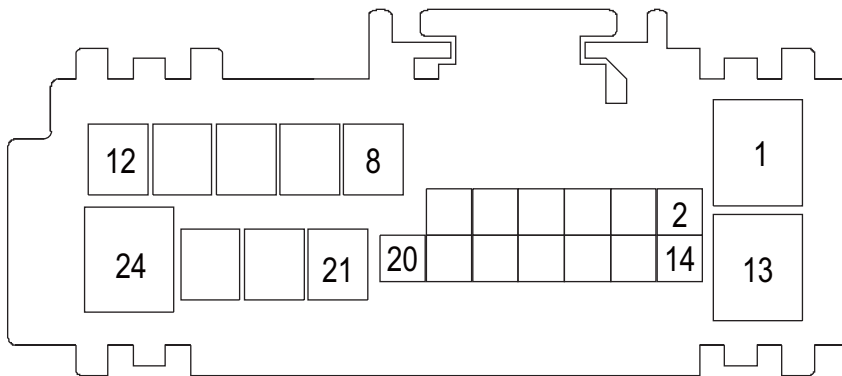

EK909208

Troubleshooting steps	
Step1	General inspection.
	<ol style="list-style-type: none"> 1 Check fuse U-FS4 Whether it is damaged. 2 Check whether the battery is fully charged. 3 Check the wire harness plug of TIM module for damage, poor contact, aging and looseness. 4 Is the inspection result normal?
	NO → Repair or replace parts with detected faults.
YES ↓	
Step2	Check the fault code.
	<ol style="list-style-type: none"> 1 Connect the scan tool to the diagnostic interface. 2 Turn the ignitiON switch to the on position. 3 Use the diagnostic instrument to diagnose the TIM module. 4 Are there any fault codes other than B100E-11?
	YES → Refer to: DTC Summary list (TIM) .
NO ↓	
Step3	Check the supply voltage of trailer battery.
	<ol style="list-style-type: none"> 1 Turn on the ignition switch. 2 Measure the voltage between trailer harness terminal and ground. Measuring circuit: voltage between terminal 9 of trailer harness plug and ground. Standard value:10~14V 3 Is the inspection result normal?
	NO → Repair or replace parts with detected faults.
YES ↓	

TIM

Step4	Check the trailer ground circuit for an open circuit.	
	<ol style="list-style-type: none"> 1 Turn off the ignition switch. 2 Measure the resistance between harness plug of trailer harness and ground. Measuring circuit: resistance between No.11 terminal of trailer harness plug and ground. Standard value:< 1Ω 3 Is the resistance less than 1 ω? 	
		NO → Repair or replace parts with detected faults.
YES ↓		
Step5	Check right position lamp circuit (open circuit).	
	<ol style="list-style-type: none"> 1 Turn off the ignition switch. 2 Disconnect TIM module harness plug. 3 Disconnect the trailer harness plug. 4 Measure the resistance between trailer harness terminal and TIM module harness terminal. Measuring circuit: resistance between terminal 5 of trailer plug and terminal 22 of TIM plug. Standard value: ≈ 0Ω 5 Is the inspection result normal? 	
		NO → Repair or replace parts with detected faults.
YES ↓		

Step5	Check whether the TIM module is abnormal.
	<ol style="list-style-type: none"> 1 Turn off the ignition switch. 2 Disconnect and inspect the wire harness plug FL70 of TIM module. 3 Inspection and maintenance: <ul style="list-style-type: none"> • Corrosion (install new connectors or terminals-clean module pins). • Damaged or bent pins-Install new terminals/pins. • Pin flying out-install new pins as needed. 4 Reconnect the TIM plug and all other previously disconnected plugs. Make sure that the pins are properly positioned and fixed. 5 Run the system and determine if the problem still exists?
	YES → Replace the TIM .
NO ↓	
At this time, the system works normally. The cause of the problem may be module connection. Address the root cause of any connector or pin problem.	
Next Step ↓	
Diagnosis is over.	

B1002-11

Fault diagnosis code
B1002-11: The rear brake light is overloaded or short-circuited to ground
Detection tools
1 Multimeter and diagnostic apparatus
Possible causes of failure
<ul style="list-style-type: none">• Lines, terminals or connectors• storage battery• TIM• fuse
Conditions for fault code operation
Turn the ignition switch to the ON position
Conditions for fault code setting
B1002-11
Brake light circuit short circuit to ground
To set the effect of a fault code condition
Description of circuit diagram
TIM module will always monitor whether the sensor and actuator are in the normal range. At the same time, it will also test the rationality of virtual connection, short circuit, open circuit and other signals. When a fault occurs, the TIM module will store the fault code corresponding to this fault.

Circuit diagram

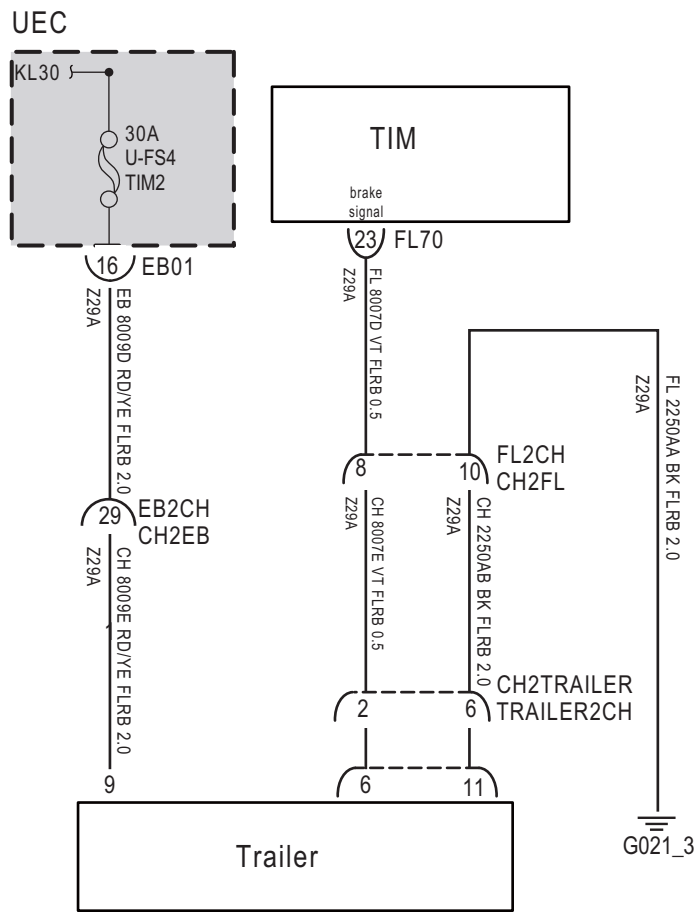

FL70

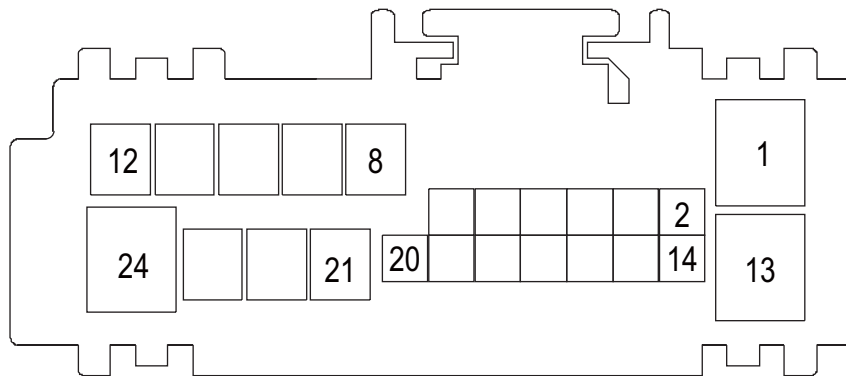

EK909209

Troubleshooting steps	
Step1	General inspection.
	<ol style="list-style-type: none"> 1 Check fuse U-FS4 Whether it is damaged. 2 Check whether the battery is fully charged. 3 Check the wire harness plug of TIM module for damage, poor contact, aging and looseness. 4 Is the inspection result normal?
	NO → Repair or replace parts with detected faults.
YES ↓	
Step2	Check the fault code.
	<ol style="list-style-type: none"> 1 Connect the scan tool to the diagnostic interface. 2 Turn the ignitiON switch to the on position. 3 Use the diagnostic instrument to diagnose the TIM module. 4 Are there any fault codes other than B1002-11?
	YES → Refer to: DTC Summary list (TIM) .
NO ↓	
Step3	Check the supply voltage of trailer battery.
	<ol style="list-style-type: none"> 1 Turn on the ignition switch. 2 Measure the voltage between trailer harness terminal and ground. Measuring circuit: voltage between terminal 9 of trailer harness plug and ground. Standard value:10~14V 3 Is the inspection result normal?
	NO → Repair or replace parts with detected faults.
YES ↓	

Step4	Check the trailer ground circuit for an open circuit.
	<ol style="list-style-type: none"> 1 Turn off the ignition switch. 2 Measure the resistance between trailer harness plug and ground. Measuring circuit: resistance between No.11 terminal of trailer harness plug and ground. Standard value:< 1Ω 3 Is the resistance less than 1 ω?
	NO → Repair or replace parts with detected faults.
YES ↓	
Step5	Check stop lamp circuit (open circuit).
	<ol style="list-style-type: none"> 1 Turn off the ignition switch. 2 Disconnect TIM module harness plug. 3 Disconnect the trailer harness plug. 4 Measure the resistance between trailer harness terminal and TIM module harness terminal. Measuring circuit: resistance between terminal 6 of trailer plug and terminal 23 of TIM plug. Standard value: ≈ 0Ω 5 Is the inspection result normal?
	NO → Repair or replace parts with detected faults.
YES ↓	

TIM

Step5	Check whether the TIM module is abnormal.
	<ol style="list-style-type: none">1 Turn off the ignition switch.2 Disconnect and inspect the wire harness plug FL70 of TIM module.3 Inspection and maintenance:<ul style="list-style-type: none">• Corrosion (install new connectors or terminals-clean module pins).• Damaged or bent pins-Install new terminals/pins.• Pin flying out-install new pins as needed.4 Reconnect the TIM plug and all other previously disconnected plugs. Make sure that the pins are properly positioned and fixed.5 Run the system and determine if the problem still exists?
	YES → Replace the TIM .
NO ↓	
At this time, the system works normally. The cause of the problem may be module connection. Address the root cause of any connector or pin problem.	
Next Step ↓	
Diagnosis is over.	

B1001-11

Fault diagnosis code
B1001-11: The rear fog lamps are overloaded or shorted to ground
Detection tools
1 Multimeter and diagnostic apparatus
Possible causes of failure
<ul style="list-style-type: none"> • Lines, terminals or connectors • storage battery • TIM • fuse
Conditions for fault code operation
Turn the ignition switch to the ON position
Conditions for fault code setting
B1001-11
Rear fog lamp circuit short circuit to ground.
To set the effect of a fault code condition
Description of circuit diagram
TIM module will always monitor whether the sensor and actuator are in the normal range. At the same time, it will also test the rationality of virtual connection, short circuit, open circuit and other signals. When a fault occurs, the TIM module will store the fault code corresponding to this fault.

Circuit diagram

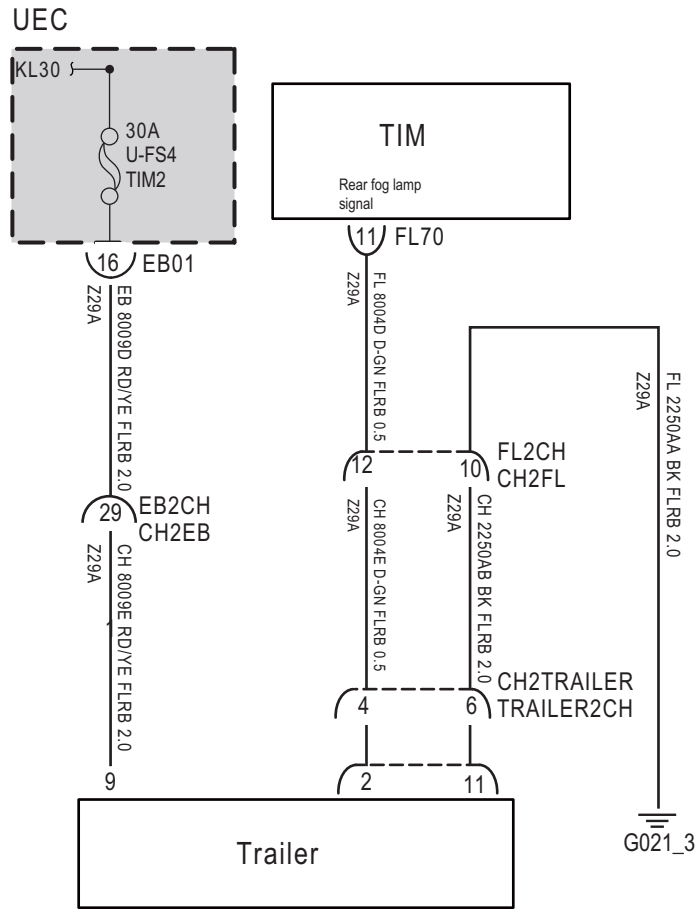

FL70

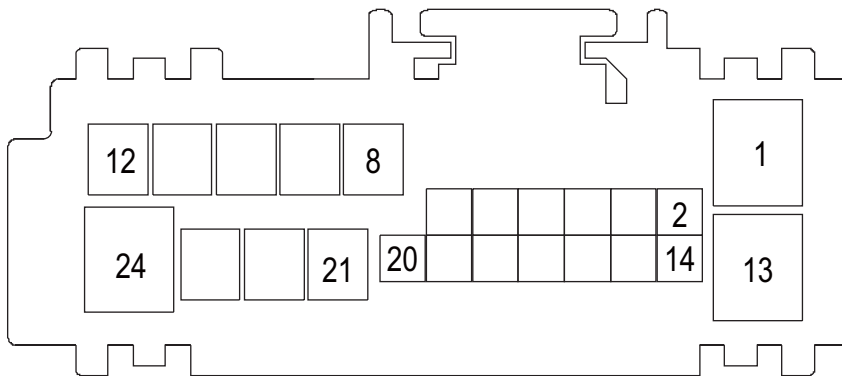

EK909210

Troubleshooting steps	
Step1	General inspection.
	<ol style="list-style-type: none"> 1 Check fuse U-FS4 Whether it is damaged. 2 Check whether the battery is fully charged. 3 Check the wire harness plug of TIM module for damage, poor contact, aging and looseness. 4 Is the inspection result normal?
	NO → Repair or replace parts with detected faults.
YES ↓	
Step2	Check the fault code.
	<ol style="list-style-type: none"> 1 Connect the scan tool to the diagnostic interface. 2 Turn the ignitiON switch to the on position. 3 Use the diagnostic instrument to diagnose the TIM module. 4 Are there any fault codes other than B1001-11?
	YES → Refer to: DTC Summary list (TIM) .
NO ↓	
Step3	Check the supply voltage of trailer battery.
	<ol style="list-style-type: none"> 1 Turn on the ignition switch. 2 Measure the voltage between trailer harness terminal and ground. Measuring circuit: voltage between terminal 9 of trailer harness plug and ground. Standard value:10~14V 3 Is the inspection result normal?
	NO → Repair or replace parts with detected faults.
YES ↓	

Step4	Check the trailer ground circuit for an open circuit.	
	<ol style="list-style-type: none"> 1 Turn off the ignition switch. 2 Measure the resistance between trailer harness plug and ground. Measuring circuit: resistance between No.11 terminal of trailer harness plug and ground. Standard value:< 1Ω 3 Is the resistance less than 1 ω? 	
		NO → Repair or replace parts with detected faults.
YES ↓		
Step5	Check rear fog lamp circuit (open circuit).	
	<ol style="list-style-type: none"> 1 Turn off the ignition switch. 2 Disconnect TIM module harness plug. 3 Disconnect the trailer harness plug. 4 Measure the resistance between trailer harness terminal and TIM module harness terminal. Measuring circuit: resistance between terminal 2 of trailer plug and terminal 11 of TIM plug. Standard value: ≈ 0Ω 5 Is the inspection result normal? 	
		NO → Repair or replace parts with detected faults.
YES ↓		

Step5	Check whether the TIM module is abnormal.
	<ol style="list-style-type: none"> 1 Turn off the ignition switch. 2 Disconnect and inspect the wire harness plug FL70 of TIM module. 3 Inspection and maintenance: <ul style="list-style-type: none"> • Corrosion (install new connectors or terminals-clean module pins). • Damaged or bent pins-Install new terminals/pins. • Pin flying out-install new pins as needed. 4 Reconnect the TIM plug and all other previously disconnected plugs. Make sure that the pins are properly positioned and fixed. 5 Run the system and determine if the problem still exists?
	YES → Replace the TIM .
NO ↓	
At this time, the system works normally. The cause of the problem may be module connection. Address the root cause of any connector or pin problem.	
Next Step ↓	
Diagnosis is over.	

B1007-11

Fault diagnosis code
B1007-11: The right turn signal is overloaded or shorted to ground
Detection tools
1 Multimeter and diagnostic apparatus
Possible causes of failure
<ul style="list-style-type: none">• Lines, terminals or connectors• storage battery• TIM• fuse
Conditions for fault code operation
Turn the ignition switch to the ON position
Conditions for fault code setting
B1007-11
Right turn signal circuit is short-circuited to ground.
To set the effect of a fault code condition
Description of circuit diagram
TIM module will always monitor whether the sensor and actuator are in the normal range. At the same time, it will also test the rationality of virtual connection, short circuit, open circuit and other signals. When a fault occurs, the TIM module will store the fault code corresponding to this fault.

Circuit diagram

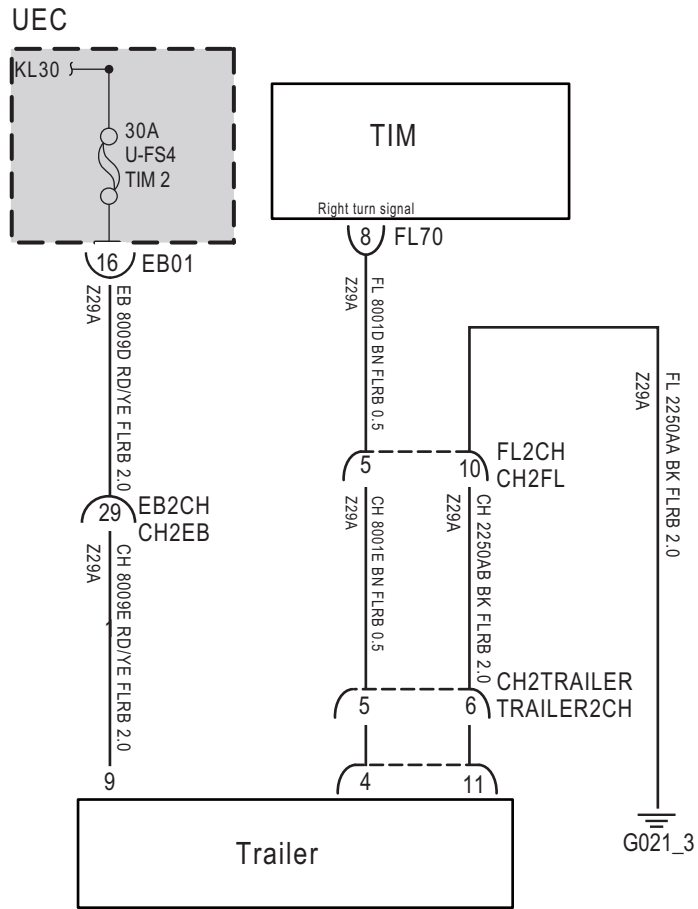

FL70

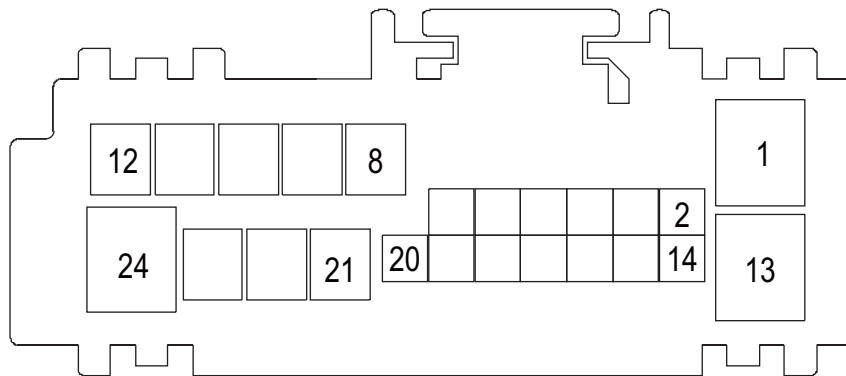

EK909211

Troubleshooting steps	
Step1	General inspection.
	<ol style="list-style-type: none"> 1 Check fuse U-FS4 Whether it is damaged. 2 Check whether the battery is fully charged. 3 Check the wire harness plug of TIM module for damage, poor contact, aging and looseness. 4 Is the inspection result normal?
	NO → Repair or replace parts with detected faults.
YES ↓	
Step2	Check the fault code.
	<ol style="list-style-type: none"> 1 Connect the scan tool to the diagnostic interface. 2 Turn the ignitiON switch to the on position. 3 Use the diagnostic instrument to diagnose the TIM module. 4 Are there any fault codes other than B1007-11?
	YES → Refer to: DTC Summary list (TIM) .
NO ↓	
Step3	Check the supply voltage of trailer battery.
	<ol style="list-style-type: none"> 1 Turn on the ignition switch. 2 Measure the voltage between trailer harness terminal and ground. Measuring circuit: voltage between terminal 9 of trailer harness plug and ground. Standard value:10~14V 3 Is the inspection result normal?
	NO → Repair or replace parts with detected faults.
YES ↓	

Step4	Check the trailer ground circuit for an open circuit.
	<ol style="list-style-type: none"> 1 Turn off the ignition switch. 2 Measure the resistance between trailer harness plug and ground. Measuring circuit: resistance between No.11 terminal of trailer harness plug and ground. Standard value:< 1Ω 3 Is the resistance less than 1 ω?
	NO → Repair or replace parts with detected faults.
YES ↓	
Step5	Check the right turn signal circuit (open circuit).
	<ol style="list-style-type: none"> 1 Turn off the ignition switch. 2 Disconnect TIM module harness plug. 3 Disconnect the trailer harness plug. 4 Measure the resistance between trailer harness terminal and TIM module harness terminal. Measuring circuit: resistance between terminal 4 of trailer plug and terminal 8 of TIM plug. Standard value: ≈ 0Ω 5 Is the inspection result normal?
	NO → Repair or replace parts with detected faults.
YES ↓	

TIM

Step5	Check whether the TIM module is abnormal.
	<ol style="list-style-type: none">1 Turn off the ignition switch.2 Disconnect and inspect the wire harness plug FL70 of TIM module.3 Inspection and maintenance:<ul style="list-style-type: none">• Corrosion (install new connectors or terminals-clean module pins).• Damaged or bent pins-Install new terminals/pins.• Pin flying out-install new pins as needed.4 Reconnect the TIM plug and all other previously disconnected plugs. Make sure that the pins are properly positioned and fixed.5 Run the system and determine if the problem still exists?
	YES → Replace the TIM .
NO ↓	
At this time, the system works normally. The cause of the problem may be module connection. Address the root cause of any connector or pin problem.	
Next Step ↓	
Diagnosis is over.	

B1006-11

Fault diagnosis code
B1006-11: The left turn signal is overloaded or shorted to ground
Detection tools
1 Multimeter and diagnostic apparatus
Possible causes of failure
<ul style="list-style-type: none"> • Lines, terminals or connectors • storage battery • TIM • fuse
Conditions for fault code operation
Turn the ignition switch to the ON position
Conditions for fault code setting
B1006-11
Left turn signal circuit is short-circuited to ground.
To set the effect of a fault code condition
Description of circuit diagram
TIM module will always monitor whether the sensor and actuator are in the normal range. At the same time, it will also test the rationality of virtual connection, short circuit, open circuit and other signals. When a fault occurs, the TIM module will store the fault code corresponding to this fault.

Circuit diagram

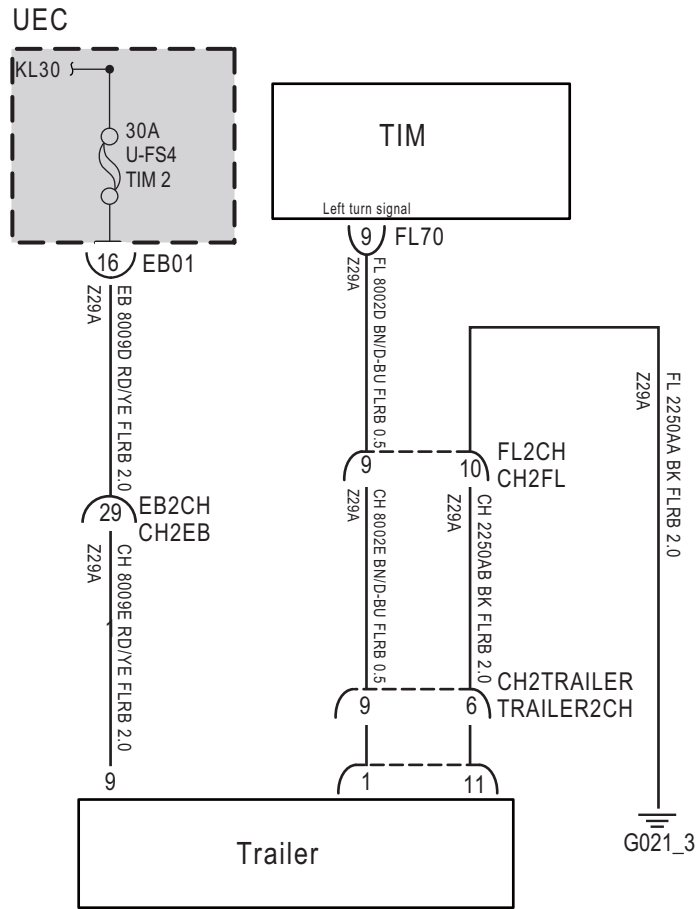

FL70

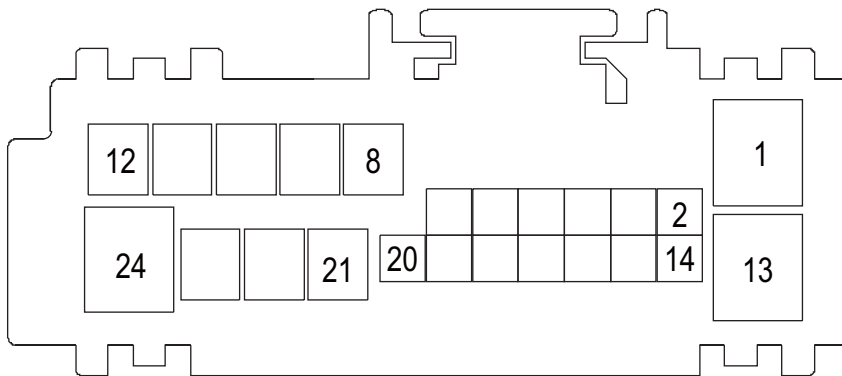

EK909212

Troubleshooting steps	
Step1	General inspection.
	<ol style="list-style-type: none"> 1 Check fuse U-FS4 Whether it is damaged. 2 Check whether the battery is fully charged. 3 Check the wire harness plug of TIM module for damage, poor contact, aging and looseness. 4 Is the inspection result normal?
	NO → Repair or replace parts with detected faults.
YES ↓	
Step2	Check the fault code.
	<ol style="list-style-type: none"> 1 Connect the scan tool to the diagnostic interface. 2 Turn the ignitiON switch to the on position. 3 Use the diagnostic instrument to diagnose the TIM module. 4 Are there any fault codes other than B1006-11?
	YES → Refer to: DTC Summary list (TIM) .
NO ↓	
Step3	Check the supply voltage of trailer battery.
	<ol style="list-style-type: none"> 1 Turn on the ignition switch. 2 Measure the voltage between trailer harness terminal and ground. Measuring circuit: voltage between terminal 9 of trailer harness plug and ground. Standard value:10~14V 3 Is the inspection result normal?
	NO → Repair or replace parts with detected faults.
YES ↓	

Step4	Check the trailer ground circuit for an open circuit.	
	<ol style="list-style-type: none"> 1 Turn off the ignition switch. 2 Measure the resistance between trailer harness plug and ground. Measuring circuit: resistance between No.11 terminal of trailer harness plug and ground. Standard value:< 1Ω 3 Is the resistance less than 1 ω? 	
		NO → Repair or replace parts with detected faults.
YES ↓		
Step5	Check left turn signal circuit (open circuit).	
	<ol style="list-style-type: none"> 1 Turn off the ignition switch. 2 Disconnect TIM module harness plug. 3 Disconnect the trailer harness plug. 4 Measure the resistance between trailer harness terminal and TIM module harness terminal. Measuring circuit: resistance between terminal 1 of trailer plug and terminal 9 of TIM plug. Standard value: ≈ 0Ω 5 Is the inspection result normal? 	
		NO → Repair or replace parts with detected faults.
YES ↓		

Step5	Check whether the TIM module is abnormal.
	<ol style="list-style-type: none"> 1 Turn off the ignition switch. 2 Disconnect and inspect the wire harness plug FL70 of TIM module. 3 Inspection and maintenance: <ul style="list-style-type: none"> • Corrosion (install new connectors or terminals-clean module pins). • Damaged or bent pins-Install new terminals/pins. • Pin flying out-install new pins as needed. 4 Reconnect the TIM plug and all other previously disconnected plugs. Make sure that the pins are properly positioned and fixed. 5 Run the system and determine if the problem still exists?
	YES → Replace the TIM .
NO ↓	
At this time, the system works normally. The cause of the problem may be module connection. Address the root cause of any connector or pin problem.	
Next Step ↓	
Diagnosis is over.	

B1000-11

Fault diagnosis code
B1000-11: The reversing lights are overloaded or shorted to ground
Detection tools
1 Multimeter and diagnostic apparatus
Possible causes of failure
<ul style="list-style-type: none">• Lines, terminals or connectors• storage battery• TIM• fuse
Conditions for fault code operation
Turn the ignition switch to the ON position
Conditions for fault code setting
B1000-11
Reverse lamp circuit short to ground
To set the effect of a fault code condition
Description of circuit diagram
TIM module will always monitor whether the sensor and actuator are in the normal range. At the same time, it will also test the rationality of virtual connection, short circuit, open circuit and other signals. When a fault occurs, the TIM module will store the fault code corresponding to this fault.

Circuit diagram

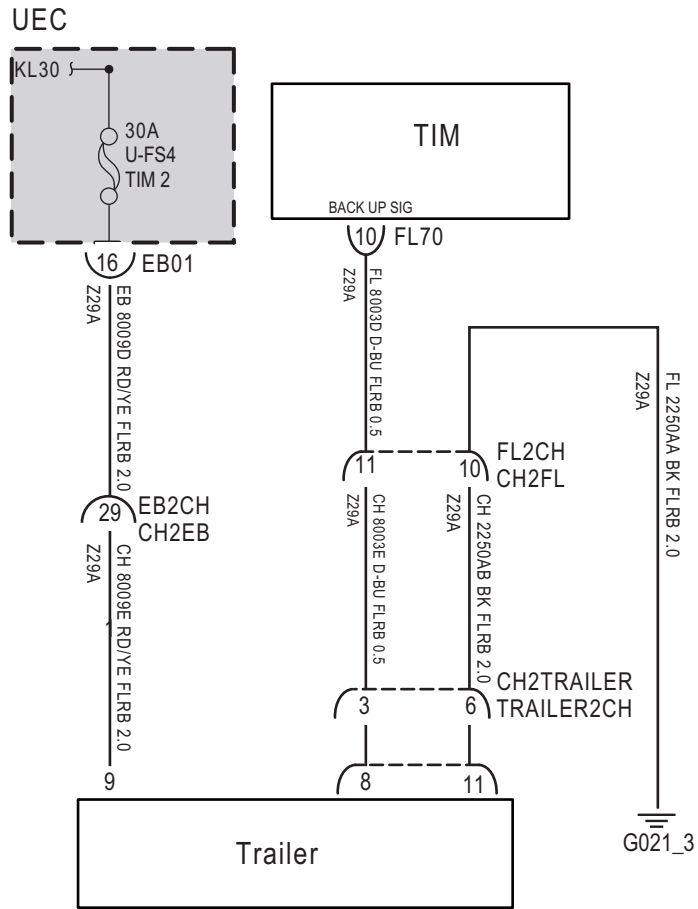

FL70

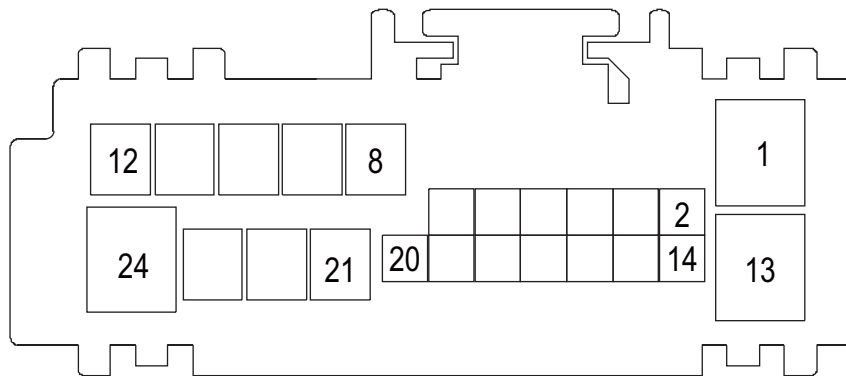

EK909213

Troubleshooting steps	
Step1	General inspection.
	<ol style="list-style-type: none"> 1 Check fuse U-FS4 Whether it is damaged. 2 Check whether the battery is fully charged. 3 Check the wire harness plug of TIM module for damage, poor contact, aging and looseness. 4 Is the inspection result normal?
	NO → Repair or replace parts with detected faults.
YES ↓	
Step2	Check the fault code.
	<ol style="list-style-type: none"> 1 Connect the scan tool to the diagnostic interface. 2 Turn the ignitiON switch to the on position. 3 Use the diagnostic instrument to diagnose the TIM module. 4 Are there any fault codes other than B1000-11?
	YES → Refer to: DTC Summary list (TIM) .
NO ↓	
Step3	Check the supply voltage of trailer battery.
	<ol style="list-style-type: none"> 1 Turn on the ignition switch. 2 Measure the voltage between trailer harness terminal and ground. Measuring circuit: voltage between terminal 9 of trailer harness plug and ground. Standard value:10~14V 3 Is the inspection result normal?
	NO → Repair or replace parts with detected faults.
YES ↓	

Step4	Check the trailer ground circuit for an open circuit.
	<ol style="list-style-type: none"> 1 Turn off the ignition switch. 2 Measure the resistance between trailer harness plug and ground. Measuring circuit: resistance between No.11 terminal of trailer harness plug and ground. Standard value:< 1Ω 3 Is the resistance less than 1 ω?
	NO → Repair or replace parts with detected faults.
YES ↓	
Step5	Check backup lamp circuit (open circuit).
	<ol style="list-style-type: none"> 1 Turn off the ignition switch. 2 Disconnect TIM module harness plug. 3 Disconnect the trailer harness plug. 4 Measure the resistance between trailer harness terminal and TIM module harness terminal. Measuring circuit: resistance between terminal 8 of trailer plug and terminal 10 of TIM module plug. Standard value: ≈ 0Ω 5 Is the inspection result normal?
	NO → Repair or replace parts with detected faults.
YES ↓	

TIM

Step5	Check whether the TIM module is abnormal.
	<ol style="list-style-type: none">1 Turn off the ignition switch.2 Disconnect and inspect the wire harness plug FL70 of TIM module.3 Inspection and maintenance:<ul style="list-style-type: none">• Corrosion (install new connectors or terminals-clean module pins).• Damaged or bent pins-Install new terminals/pins.• Pin flying out-install new pins as needed.4 Reconnect the TIM plug and all other previously disconnected plugs. Make sure that the pins are properly positioned and fixed.5 Run the system and determine if the problem still exists?
	YES → Replace the TIM .
NO ↓	
At this time, the system works normally. The cause of the problem may be module connection. Address the root cause of any connector or pin problem.	
Next Step ↓	
Diagnosis is over.	

DTC Summary list (EVCC)

DTC	English descriptions	Reference page
P1FF0	CP(control pilot) Voltage is Abnormal	P1FF0、 P1FF1、 P1FF8
P1FF1	CP(control pilot) Voltage is Abnormal when waked by KL15	
P1FF8	CP1(control pilot) Voltage is Abnormal	
P1FF2	PP(proximity pilot) resistor is Abnormal	P1FF2、 P1FF3、 P1FF5
P1FF5	offboard wake up voltage is abnormal	
P1FF3	PP(proximity pilot) resistor is Abnormal	
P1FF4	CC(Connection Confirm to OBC) resistor is abnormal	P1FF4、 P1FF6
P1FF6	CC2(Connection Confirm toBMS)resistor is abnormal	
P1FF7	lost communicatin with DC Charging Station by plc	P1FF7、 U2003、 U2000
U2003	PLC's Software Error	
U2000	PLC's Hardware Error	
U1563	Battery Voltage Low	U1563、 U1562
U1562	Battery Voltage High	
U0078	Control Module Communication Bus Off on BMS	U0078、 U1111
U1111	Lost Communication With BMS	

P1FF0、P1FF1、P1FF8

Fault diagnosis code
P1FF0: CP(control pilot) Voltage is Abnormal
P1FF1: CP(control pilot) Voltage is Abnormal when waked by KL15
P1FF8: CP1(control pilot) Voltage is Abnormal
Detection tools
1 Multimeter and diagnostic apparatus
Possible causes
<ul style="list-style-type: none"> • Circuit,terminal and adapting piece fault • Storage battery • EVCC • Charging System • fuse
Conditions for fault code operation
Turn the ignition switch to ON position.
Conditions for fault code setting
P1FF0
When charging mode=DC and S2 is turned on, the CP (control pilot) voltage returns to 9V or charging mode=DC and S2 is close, and the CP (control pilot) voltage returns to 6V continuously for 0.5s;
When charging mode=AC, S2 opens, CP (control pilot) voltage returns to 9V or charging mode=AC, S2 approaches, and CP (control pilot) voltage continuously returns to 6V 0.5S
P1FF1
When KL15 wakes up, the CP (control pilot) voltage continuously recovers to 0V0.5S
P1FF8
When charging mode=DC and S2 is turned on, CP1 (control pilot) voltage returns to 9V or charging mode=DC and S2 is close, CP1 (control pilot) voltage returns to 6V for 0.5 seconds continuously
When charging mode=AC, S2 is turned on, CP1 (control pilot) voltage returns to 9V, or charging mode=AC, S2 is close, CP1 (control pilot) voltage continuously returns to 6V0.5S;
When KL15 wakes up, CP1 (control pilot) voltage continuously returns to 9V0.5S
To set the effect of a fault code condition
Description of circuit diagram
EVCC will continuously monitor whether the sensors and actuators are within the normal range. At the same time, it will also detect the rationality of virtual connections, short circuits, open circuits, and other signals between connectors. When a fault occurs, EVCC will store the corresponding fault code for this fault.

Circuit diagram

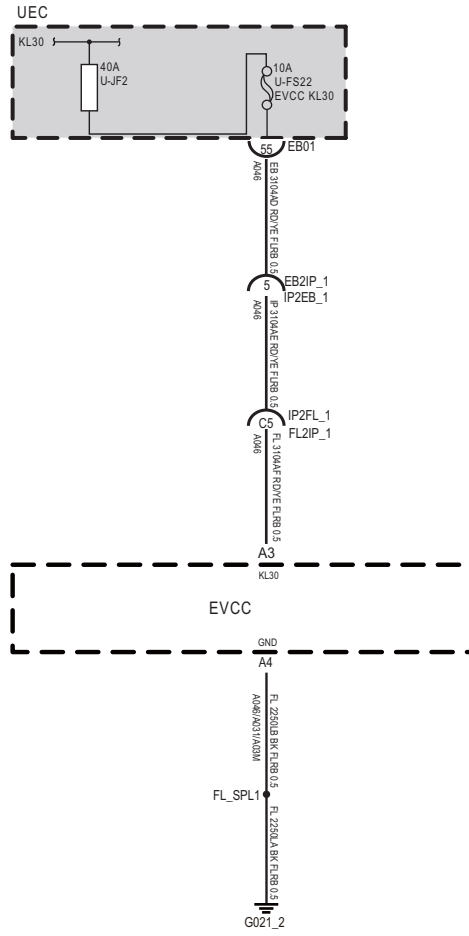

EVCC

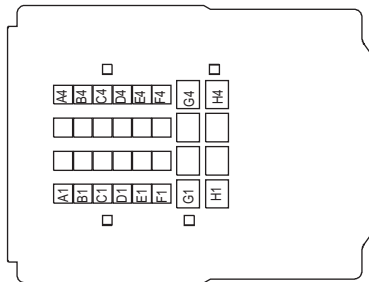

EK894401

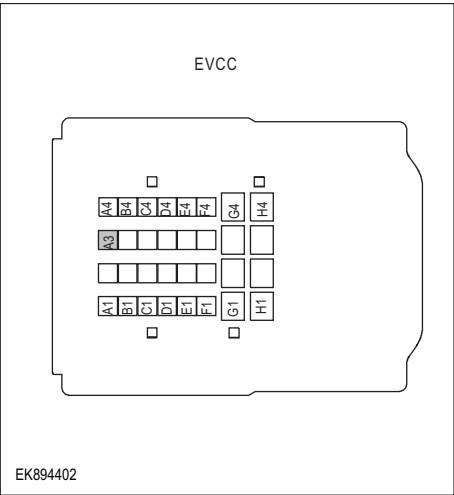
Troubleshooting procedures	
Step1	General inspection.
	<ol style="list-style-type: none"> 1 Check the fuse U-JF2、 U-FS22Is it damaged. 2 Check relays it damaged. 3 Check battery capacity. 4 Check the EVCC harness plug for damage, poor contact, aging, and looseness. 5 Is the inspection result normal?
NO → Repair or replace the detected faulty parts.	
YES ↓	
Step2	Check for fault codes.
	<ol style="list-style-type: none"> 1 Connect the fault diagnosis instrument to the diagnostic interface. 2 Turn the ignition switch to the ON position. 3 Use a diagnostic tool to diagnose EVCC. 4 Is there any other fault code except for P1FF0、 P1FF1、 P1FF8?
YES → Refer to: DTC Summary list (EVCC) .	
NO ↓	
Step3	Check the EVCC battery power supply voltage.
	<ol style="list-style-type: none"> 1 Turn off the ignition switch. 2 Disconnect the EVCC harness plug FL09. 3 Measure the voltage between the EVCC harness terminal and ground. Measuring circuit: The voltage between terminal A3 of plug FL09 and the grounding. Standard value: 10-14V 4 Is the inspection result normal?
NO → Repair or replace the detected faulty parts.	
YES ↓	

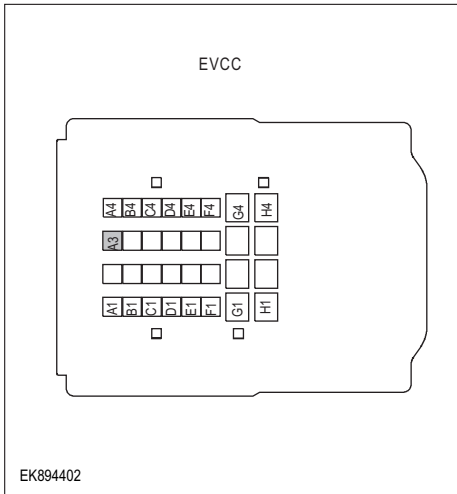
Step4	Check the power supply voltage of EVCC during startup or operation.
 <p style="text-align: center;">EVCC</p> <p style="text-align: left;">EK894402</p>	<ol style="list-style-type: none"> 1 Turn on the ignition. 2 Measure the voltage between the EVCC harness terminal and ground. Measuring circuit: The voltage between terminal A3 of plug FL09 and the grounding. Standard value: 10-14V 3 Is the inspection result normal?

NO → Repair or replace the detected faulty parts.

YES ↓

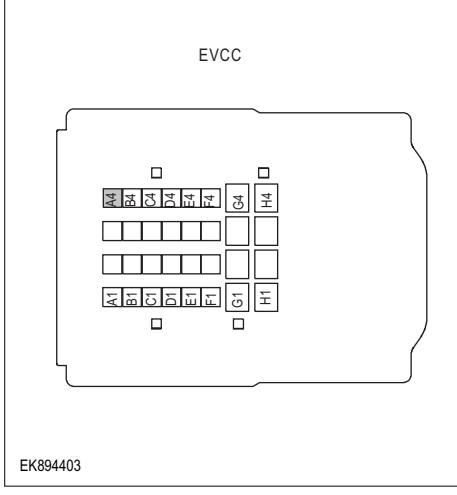
Step5	Check if the EVCC ground circuit is open.
 <p style="text-align: center;">EVCC</p> <p style="text-align: left;">EK894403</p>	<ol style="list-style-type: none"> 1 Turn off the ignition switch. 2 Measure the resistance between the EVCC harness plug and ground. Measuring circuit: The resistance between terminal A4 of plug FL09 and the grounding. Standard value:<1 Ω 3 Is the resistance less than 1 Ω?

NO → Repair or replace the detected faulty parts.

YES ↓

EVCC

Step6	Check if there are any abnormalities in EVCC.
	<ol style="list-style-type: none">1 Turn off the ignition switch.2 Disconnect and inspect the EVCC harness plug FL09.3 Inspection and maintenance:<ul style="list-style-type: none">• Corrosion (installing new connectors or terminals - cleaning module pins).• Damaged or bent pins - install new terminals/pins.• Pin flying - Install new pins as needed.4 Reconnect the EVCC plug and all other previously disconnected plugs. Ensure proper pin position and fixation5 Run the system and determine if the problem still exists?
	YES → Replace EVCC.
NO ↓	
At this point, the system is operating normally. The possible cause of the problem may be module connection. Address the root cause of any connector or pin issues.	
Next Step ↓	
Diagnosis completed.	

P1FF2、 P1FF3、 P1FF5

Fault diagnosis code
P1FF2: PP(proximity pilot) resistor is Abnormal
P1FF5: offboard wake up voltage is abnormal
P1FF3: PP(proximity pilot) resistor is Abnormal
Detection tools
1 Multimeter and diagnostic apparatus
Possible causes
<ul style="list-style-type: none"> • Circuit,terminal and adapting piece fault • EVCC • Charging System • fuse
Conditions for fault code operation
Turn the ignition switch to ON position.
Conditions for fault code setting
P1FF2
When the charging mode is DC, the PP (close to the lead) resistance continuously returns to 1500 Ω for 0.5S; When the charging mode is AC, the PP (close to the lead) resistance is between 100 Ω, 220 Ω, 680 Ω, and 1500 Ω, continuously 0.5 Ω
P1FF3
When KL15 wakes up, PP (close to pilot) resistance \geq 4500 Ω for 0.5 seconds continuously
P1FF5
When the charging mode is DC, the wake-up voltage outside the board is 12V, lasting for 1 second; When the charging mode is AC, the wake-up voltage outside the board is 0V for 1 second.
To set the effect of a fault code condition
Description of circuit diagram
EVCC will continuously monitor whether the sensors and actuators are within the normal range. At the same time, it will also detect the rationality of virtual connections, short circuits, open circuits, and other signals between connectors. When a fault occurs, EVCC will store the corresponding fault code for this fault.

Circuit diagram

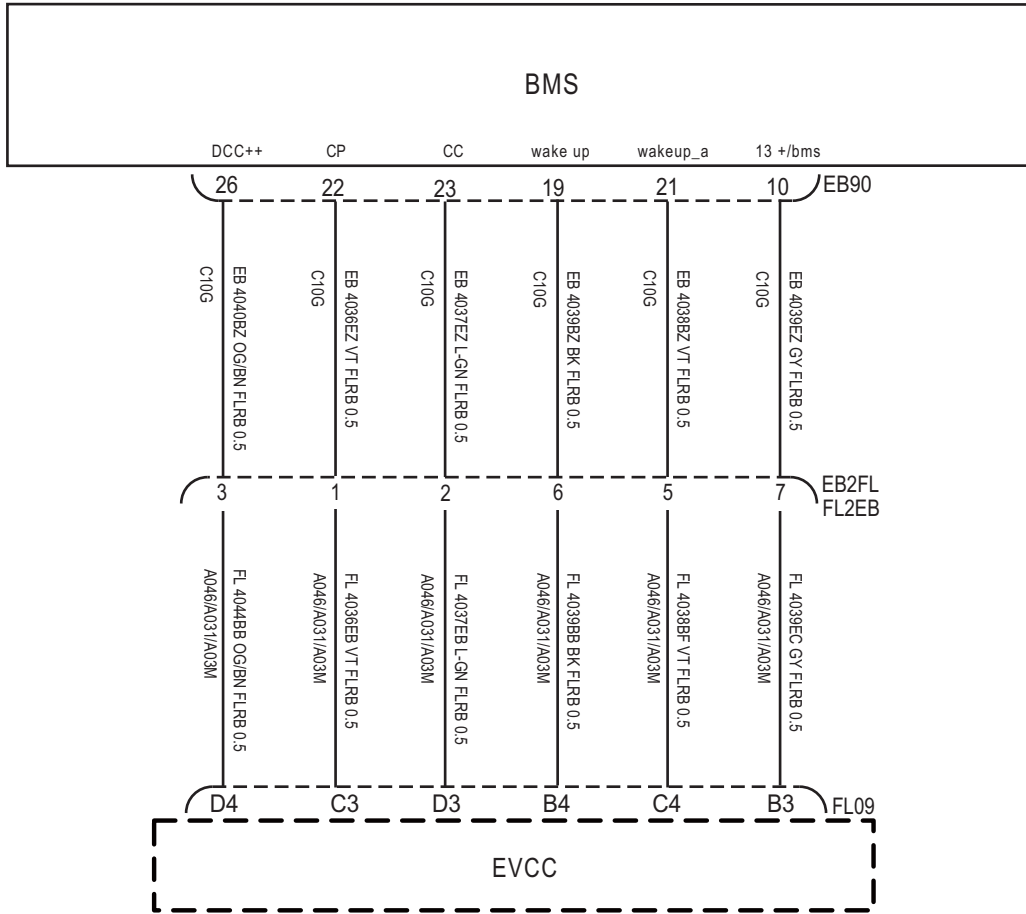

EVCC

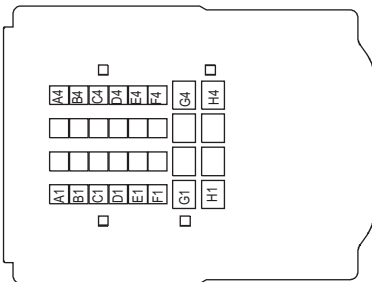

BMS

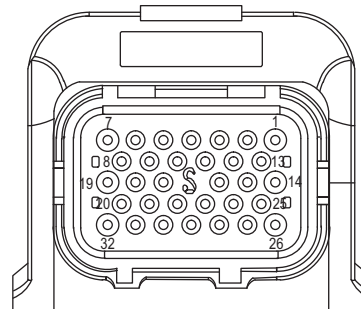

EK894404

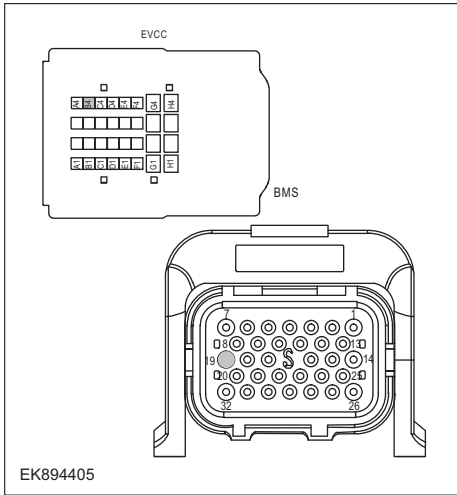
Troubleshooting procedures	
Step1	General inspection.
	<ol style="list-style-type: none"> 1 Check the fuse Is it damaged. 2 Check relays it damaged. 3 Check battery capacity. 4 Check the EVCC harness plug for damage, poor contact, aging, and looseness. 5 Is the inspection result normal?
	NO → Repair or replace the detected faulty parts.
YES ↓	
Step2	Check for fault codes.
	<ol style="list-style-type: none"> 1 Connect the fault diagnosis instrument to the diagnostic interface. 2 Turn the ignition switch to the ON position. 3 Use a diagnostic tool to diagnose EVCC. 4 Is there any other fault code except for P1FF2、 P1FF3、 P1FF5?
	YES → Refer to: DTC Summary list (EVCC) .
NO ↓	
Step3	Check for an open circuit in the EVCC circuit.
 <p>EK894405</p>	<ol style="list-style-type: none"> 1 Turn off the ignition switch. 2 Disconnect the EVCC harness plug FL09. 3 Disconnect the BMS module harness plug EB90. 4 Measure the resistance between the EVCC harness terminal and the BMS module harness terminal. 5 Measuring circuit: The resistance between terminal B4 of plug FL09 and terminal 19 of plug EB90. 6 Is the inspection result normal?
	NO → Repair or replace the detected faulty parts.
YES ↓	

EVCC

Step4	Check if there are any abnormalities in EVCC.
	<ol style="list-style-type: none">1 Turn off the ignition switch.2 Disconnect and inspect the EVCC harness plug FL09.3 Inspection and maintenance:<ul style="list-style-type: none">• Corrosion (installing new connectors or terminals - cleaning module pins).• Damaged or bent pins - install new terminals/pins.• Pin flying - Install new pins as needed.4 Reconnect the EVCC plug and all other previously disconnected plugs. Ensure proper pin position and fixation5 Run the system and determine if the problem still exists?
	YES → Replace EVCC.
NO ↓	
At this point, the system is operating normally. The possible cause of the problem may be module connection. Address the root cause of any connector or pin issues.	
Next Step ↓	

P1FF4、 P1FF6

Fault diagnosis code
CC(Connection Confirm to OBC) resistor is abnormal
CC2(Connection Confirm toBMS)resistor is abnormal
Detection tools
1 Multimeter and diagnostic apparatus
Possible causes
<ul style="list-style-type: none"> • Circuit,terminal and adapting piece fault • EVCC • Charging System • fuse
Conditions for fault code operation
Turn the ignition switch to ON position.
Conditions for fault code setting
P1FF4
When the charging mode is DC, the resistance of CC (connection confirmation to OBC) is 1500 Ω for 1 second continuously; When the charging mode is AC, the resistance of CC (confirm connection to OBC) is between 100 Ω , 220 Ω , 680 Ω , and 1500 Ω for 1 second continuously
P1FF6
When the charging mode is DC, the resistance of CC2 (confirmed connection to BMS) is 1000 Ω for 1 second continuously; When charging mode=AC, the resistance of CC2 (connection confirmation to BMS) continuously exceeds 4500 Ω for 1 second
To set the effect of a fault code condition
Description of circuit diagram
EVCC will continuously monitor whether the sensors and actuators are within the normal range. At the same time, it will also detect the rationality of virtual connections, short circuits, open circuits, and other signals between connectors. When a fault occurs, EVCC will store the corresponding fault code for this fault.

Circuit diagram

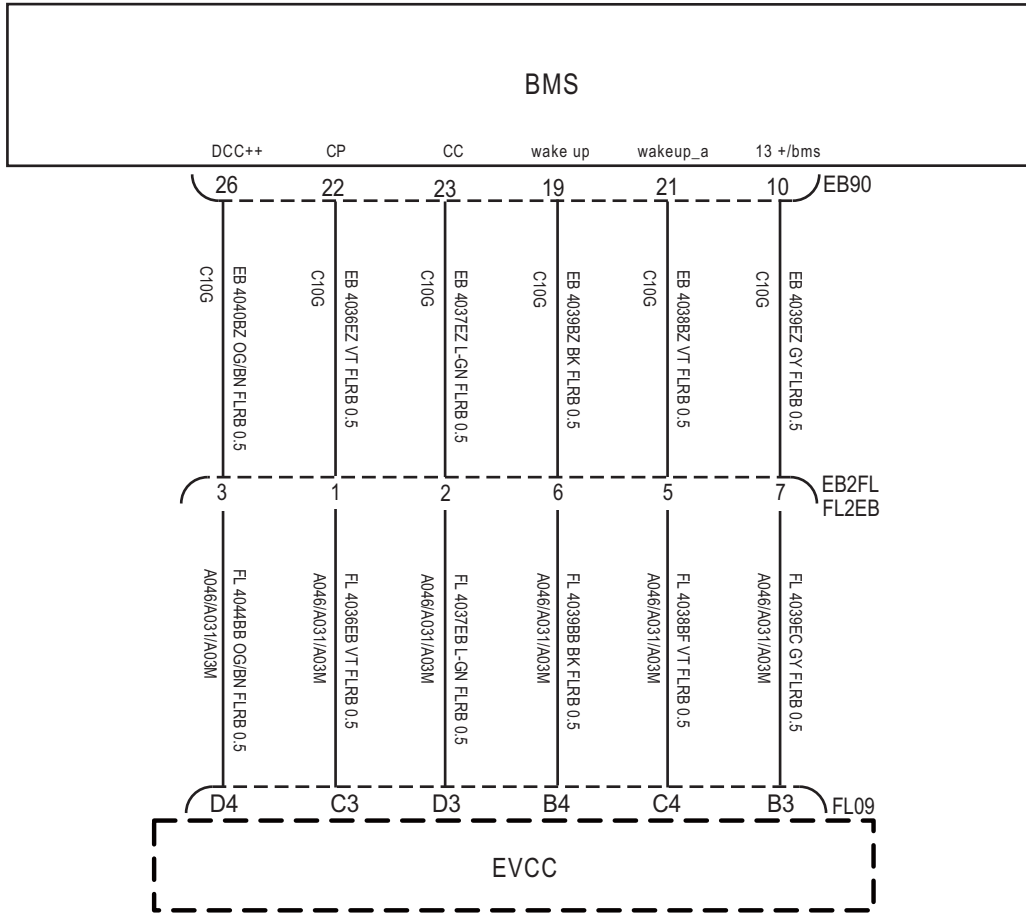

EVCC

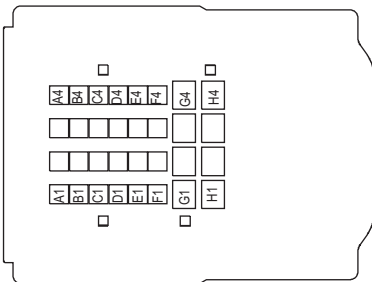

BMS

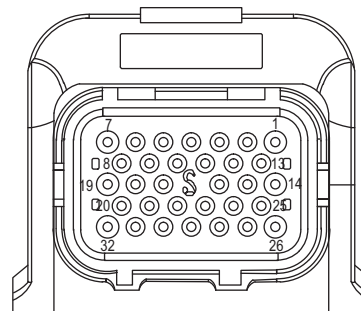

EK894404

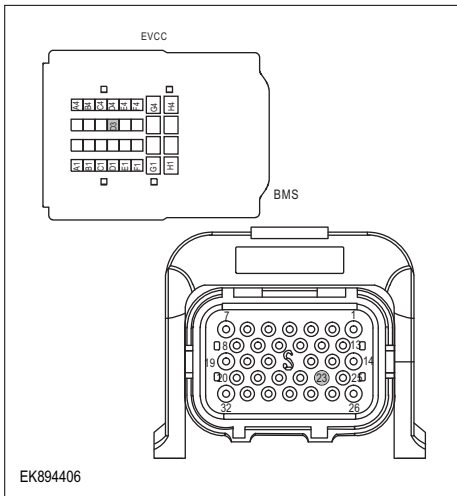
Troubleshooting procedures	
Step1	General inspection.
	<ol style="list-style-type: none"> 1 Check the fuse Is it damaged. 2 Check relays it damaged. 3 Check battery capacity. 4 Check the EVCC harness plug for damage, poor contact, aging, and looseness. 5 Is the inspection result normal?
	NO → Repair or replace the detected faulty parts.
YES ↓	
Step2	Check for fault codes.
	<ol style="list-style-type: none"> 1 Connect the fault diagnosis instrument to the diagnostic interface. 2 Turn the ignition switch to the ON position. 3 Use a diagnostic tool to diagnose EVCC. 4 Is there any other fault code except for P1FF4、 P1FF6?
	YES → Refer to: DTC Summary list (EVCC) .
NO ↓	
Step3	Check for an open circuit in the EVCC circuit.
 <p>EK894406</p>	<ol style="list-style-type: none"> 1 Turn off the ignition switch. 2 Disconnect the EVCC harness plug FL09. 3 Disconnect the BMS module harness plug EB90. 4 Measure the resistance between the EVCC harness terminal and the BMS module harness terminal. 5 Measuring circuit: The resistance between terminal D3 of plug FL09 and terminal 23 of plug EB90. 6 Is the inspection result normal?
	NO → Repair or replace the detected faulty parts.
YES ↓	

EVCC

Step4	Check if there are any abnormalities in EVCC.
	<ol style="list-style-type: none">1 Turn off the ignition switch.2 Disconnect and inspect the EVCC harness plug FL09.3 Inspection and maintenance:<ul style="list-style-type: none">• Corrosion (installing new connectors or terminals - cleaning module pins).• Damaged or bent pins - install new terminals/pins.• Pin flying - Install new pins as needed.4 Reconnect the EVCC plug and all other previously disconnected plugs. Ensure proper pin position and fixation5 Run the system and determine if the problem still exists?
	YES → Replace EVCC.
NO ↓	
At this point, the system is operating normally. The possible cause of the problem may be module connection. Address the root cause of any connector or pin issues.	
Next Step ↓	

P1FF7、 U2003、 U2000

Fault diagnosis code
P1FF7: lost communicatin with DC Charging Station by plc
U2003: PLC's Software Error
U2000: PLC's Hardware Error
Detection tools
1 Multimeter and diagnostic apparatus
Possible causes
<ul style="list-style-type: none"> • Circuit,terminal and adapting piece fault • EVCC • CAN fault • fuse
Conditions for fault code operation
Turn the ignition switch to ON position.
Conditions for fault code setting
P1FF7
The communication between the DC charging station and the PLC is successfully handshake after being unplugged
U2003
No fault detected after IG is closed/opened
U2000
No fault detected after IG is closed/opened
To set the effect of a fault code condition
Description of circuit diagram
EVCC will continuously monitor whether the sensors and actuators are within the normal range. At the same time, it will also detect the rationality of virtual connections, short circuits, open circuits, and other signals between connectors. When a fault occurs, EVCC will store the corresponding fault code for this fault.

Circuit diagram

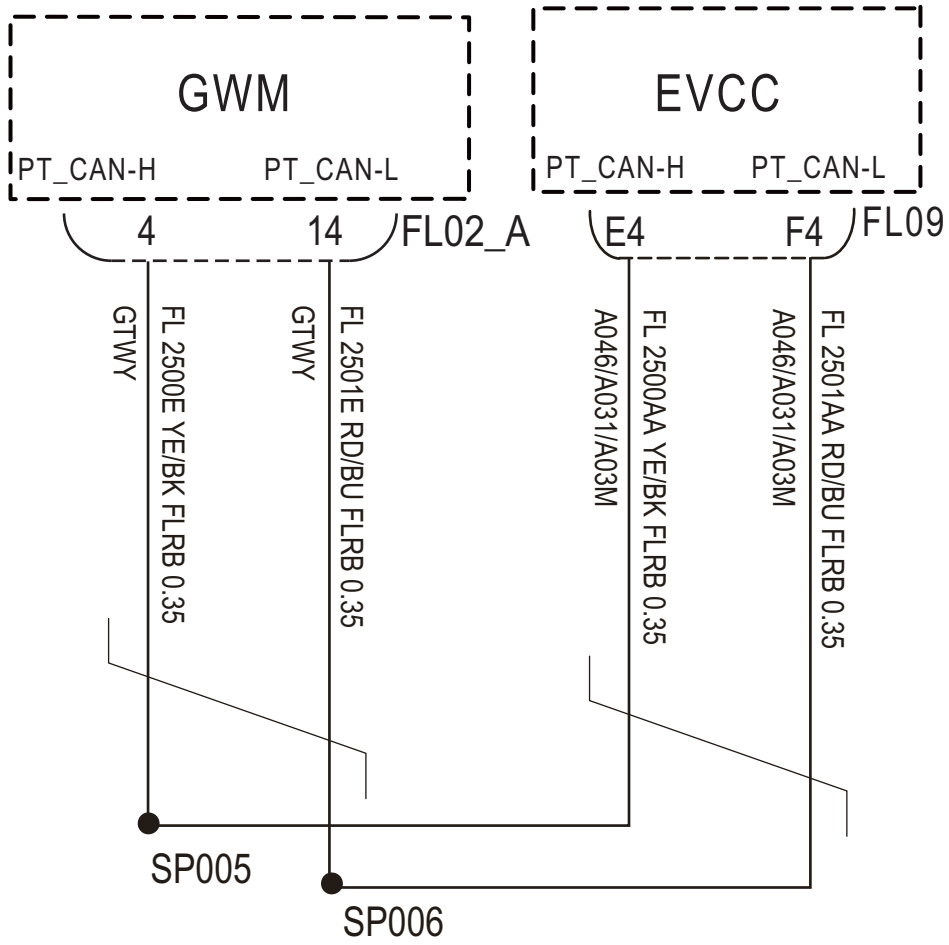

EVCC

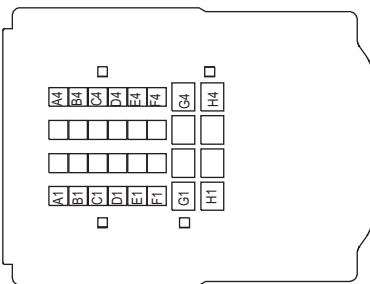

GWM

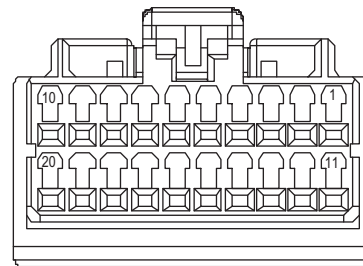

EK894407

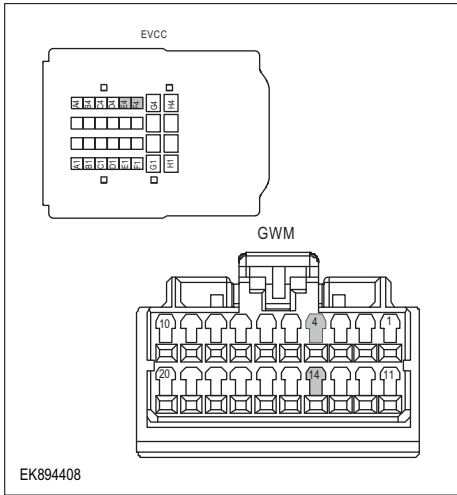
Troubleshooting procedures	
Step1	General inspection.
	<ol style="list-style-type: none"> 1 Check the fuse Is it damaged. 2 Check relays it damaged. 3 Check battery capacity. 4 Check the EVCC harness plug for damage, poor contact, aging, and looseness. 5 Is the inspection result normal?
	NO → Repair or replace the detected faulty parts.
YES ↓	
Step2	Check for fault codes.
	<ol style="list-style-type: none"> 1 Connect the fault diagnosis instrument to the diagnostic interface. 2 Turn the ignition switch to the ON position. 3 Use a diagnostic tool to diagnose EVCC. 4 Is there any other fault code except for P1FF7、 U2003、 U2000?
	YES → Refer to: DTC Summary list (EVCC) .
NO ↓	
Step3	Check the resistance of the gateway module and charging module.
 <p>EK894408</p>	<ol style="list-style-type: none"> 1 Turn off the ignition switch. 2 Disconnect the gateway module harness plug. 3 Measure the resistance between the harness terminals of the gateway module. Measuring circuit: The resistance between terminal 4 and terminal 14 of the gateway module plug. Standard value: 110~130 Ω 4 Connect the gateway module harness plug. 5 Disconnect the charging module harness plug. 6 Measure the resistance between the harness terminals of the charging module. Measuring circuit: The resistance between terminal E4 and terminal F4 of the charging module plug. Standard value: 110~130 Ω 7 Is the inspection result normal?
	NO → Repair or replace the detected faulty parts.
YES ↓	

EVCC

Step4	Check if there are any abnormalities in EVCC.
	<ol style="list-style-type: none">1 Turn off the ignition switch.2 Disconnect and inspect the EVCC harness plug FL09.3 Inspection and maintenance:<ul style="list-style-type: none">• Corrosion (installing new connectors or terminals - cleaning module pins).• Damaged or bent pins - install new terminals/pins.• Pin flying - Install new pins as needed.4 Reconnect the EVCC plug and all other previously disconnected plugs. Ensure proper pin position and fixation5 Run the system and determine if the problem still exists?
	YES → Replace EVCC.
NO ↓	
At this point, the system is operating normally. The possible cause of the problem may be module connection. Address the root cause of any connector or pin issues.	
Next Step ↓	

U1563、 U1562

Fault diagnosis code
U1563: Battery Voltage Low
U1562: Battery Voltage High
Detection tools
1 Multimeter and diagnostic apparatus
Possible causes
<ul style="list-style-type: none"> • Circuit,terminal and adapting piece fault • Storage battery • EVCC • Charging System • fuse
Conditions for fault code operation
Turn the ignition switch to ON position.
Conditions for fault code setting
U1563
The power supply voltage is higher than 9.5V for 1 second
U1562
Power supply voltage below 15.5 V for 1 second
To set the effect of a fault code condition
Description of circuit diagram
EVCC will continuously monitor whether the sensors and actuators are within the normal range. At the same time, it will also detect the rationality of virtual connections, short circuits, open circuits, and other signals between connectors. When a fault occurs, EVCC will store the corresponding fault code for this fault.

Circuit diagram

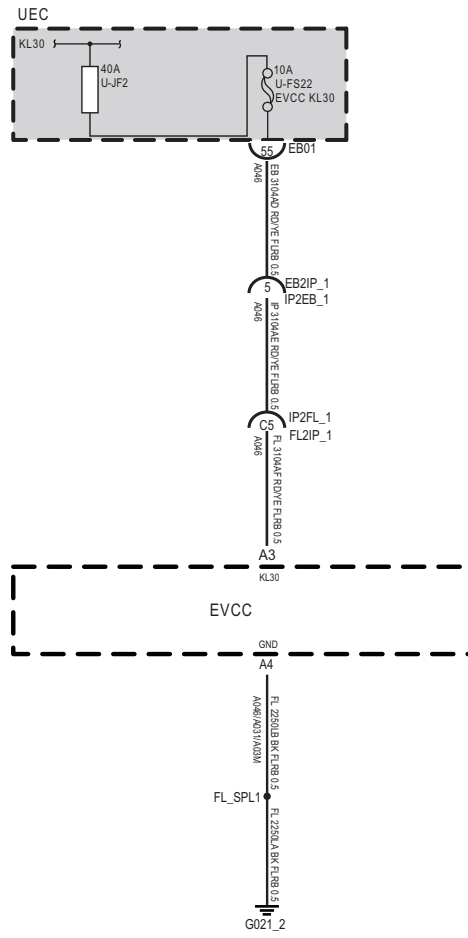

EVCC

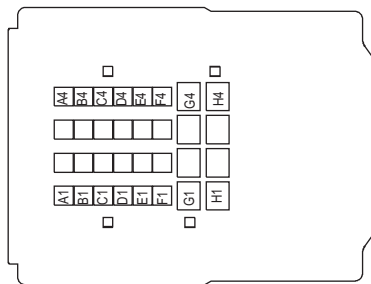

EK894401

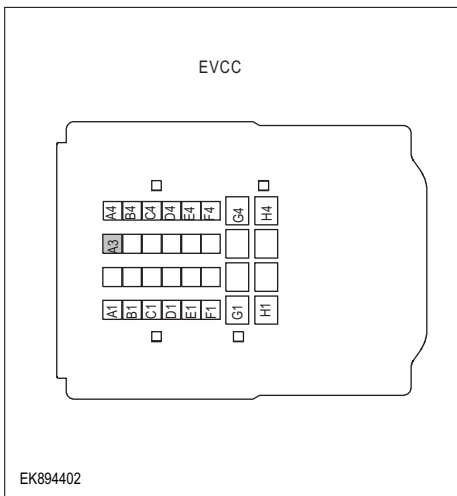
Troubleshooting procedures	
Step1	General inspection.
	<ol style="list-style-type: none"> 1 Check the fuse U-JF2、 U-FS22Is it damaged. 2 Check relays it damaged. 3 Check battery capacity. 4 Check the EVCC harness plug for damage, poor contact, aging, and looseness. 5 Is the inspection result normal?
	NO → Repair or replace the detected faulty parts.
YES ↓	
Step2	Check for fault codes.
	<ol style="list-style-type: none"> 1 Connect the fault diagnosis instrument to the diagnostic interface. 2 Turn the ignition switch to the ON position. 3 Use a diagnostic tool to diagnose EVCC. 4 Is there any other fault code except for U1563、 U1562?
	YES → Refer to: DTC Summary list (EVCC) .
NO ↓	
Step3	Check the EVCC battery power supply voltage.
	<ol style="list-style-type: none"> 1 Turn off the ignition switch. 2 Disconnect the EVCC harness plug FL09. 3 Measure the voltage between the EVCC harness terminal and ground. Measuring circuit: The voltage between terminal A3 of plug FL09 and the grounding. Standard value: 10-14V 4 Is the inspection result normal?
	NO → Repair or replace the detected faulty parts.
YES ↓	

EVCC

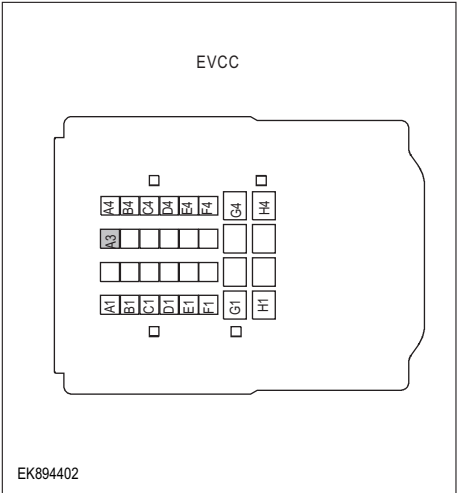
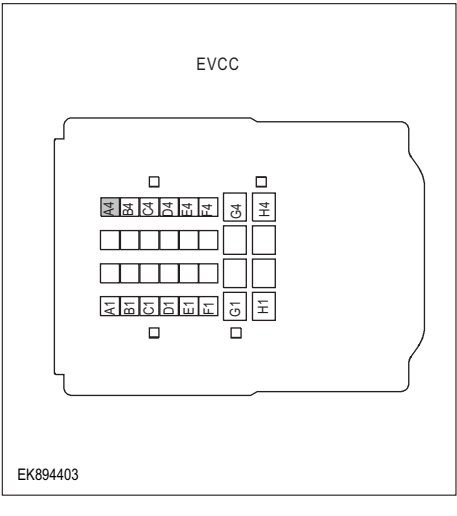
Step4	Check the power supply voltage of EVCC during startup or operation.
 <p style="text-align: center;">EVCC</p> <p style="text-align: center;">EK894402</p>	<ol style="list-style-type: none"> 1 Turn on the ignition. 2 Measure the voltage between the EVCC harness terminal and ground. Measuring circuit: The voltage between terminal A3 of plug FL09 and the grounding. Standard value: 10-14V 3 Is the inspection result normal?
NO → Repair or replace the detected faulty parts.	
YES ↓	
Step5	Check if the EVCC ground circuit is open.
 <p style="text-align: center;">EVCC</p> <p style="text-align: center;">EK894403</p>	<ol style="list-style-type: none"> 1 Turn off the ignition switch. 2 Measure the resistance between the EVCC harness plug and ground. Measuring circuit: The resistance between terminal A4 of plug FL09 and the grounding. Standard value: <1 Ω 3 Is the resistance less than 1 Ω?
NO → Repair or replace the detected faulty parts.	
YES ↓	

Step6	Check if there are any abnormalities in EVCC.
	<ol style="list-style-type: none"> 1 Turn off the ignition switch. 2 Disconnect and inspect the EVCC harness plug FL09. 3 Inspection and maintenance: <ul style="list-style-type: none"> • Corrosion (installing new connectors or terminals - cleaning module pins). • Damaged or bent pins - install new terminals/pins. • Pin flying - Install new pins as needed. 4 Reconnect the EVCC plug and all other previously disconnected plugs. Ensure proper pin position and fixation 5 Run the system and determine if the problem still exists?
	YES → Replace EVCC.
NO ↓	
At this point, the system is operating normally. The possible cause of the problem may be module connection. Address the root cause of any connector or pin issues.	
Next Step ↓	
Diagnosis completed.	

U0078、U1111

Fault diagnosis code
U1111: Lost Communication With BMS
U0078: Control Module Communication Bus Off on BMS
Detection tools
1 Multimeter and diagnostic apparatus
Possible causes
<ul style="list-style-type: none"> • Circuit,terminal and adapting piece fault • EVCC • CAN fault • fuse
Conditions for fault code operation
Turn the ignition switch to ON position.
Conditions for fault code setting
U0078
<p>The first strategy: If no bus shutdown occurs within 5000 milliseconds, the bus shutdown counter will be reset and the DTC status bit 0 (test failed) will be cleared</p> <p>The second strategy: If no bus shutdown occurs within 5000 milliseconds, the bus shutdown counter will be reset and the DTC status bit 0 will be cleared (test failed)</p>
U1111
When the timeout can be restored within 100 cycles of the frame, DTC status bit 0 (test failed) will be cleared
To set the effect of a fault code condition
Description of circuit diagram
EVCC will continuously monitor whether the sensors and actuators are within the normal range. At the same time, it will also detect the rationality of virtual connections, short circuits, open circuits, and other signals between connectors. When a fault occurs, EVCC will store the corresponding fault code for this fault.

Circuit diagram

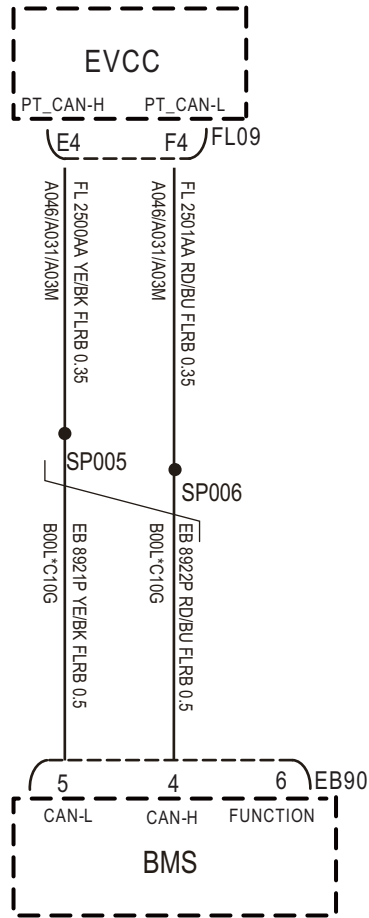

EVCC

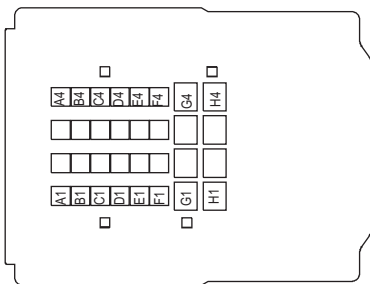

BMS

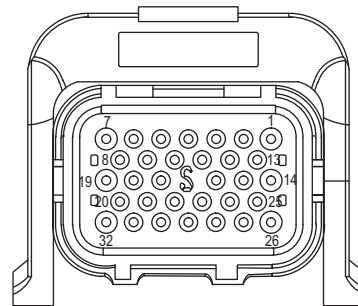

EK894409

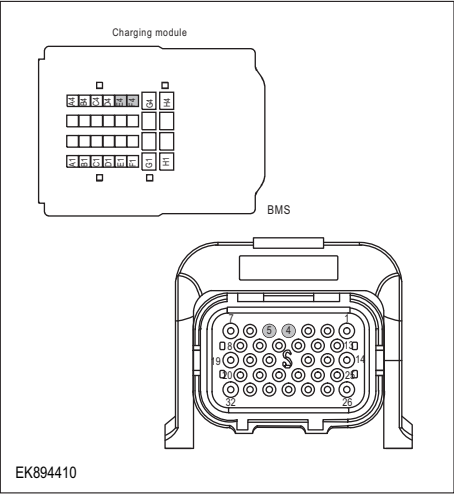
Troubleshooting procedures	
Step1	General inspection.
	<ol style="list-style-type: none"> 1 Check the fuse Is it damaged. 2 Check relays it damaged. 3 Check battery capacity. 4 Check the EVCC harness plug for damage, poor contact, aging, and looseness. 5 Is the inspection result normal?
	NO → Repair or replace the detected faulty parts.
YES ↓	
Step2	Check for fault codes.
	<ol style="list-style-type: none"> 1 Connect the fault diagnosis instrument to the diagnostic interface. 2 Turn the ignition switch to the ON position. 3 Use a diagnostic tool to diagnose EVCC. 4 Is there any other fault code except for U0078、 U1111?
	YES → Refer to: DTC Summary list (EVCC) .
NO ↓	
Step3	Check the resistance of the BMS module and charging module.
	<ol style="list-style-type: none"> 1 Turn off the ignition switch. 2 Disconnect the gateway module harness plug. 3 Measure the resistance between the harness terminals of the gateway module. Measuring circuit: The resistance between terminal 4 and terminal 5 of the BMS module plug. Standard value: 110~130 Ω 4 Connect the gateway module harness plug. 5 Disconnect the charging module harness plug. 6 Measure the resistance between the harness terminals of the charging module. Measuring circuit: The resistance between terminal E4 and terminal F4 of the charging module plug. Standard value: 110~130 Ω 7 Is the inspection result normal?
	NO → Repair or replace the detected faulty parts.
YES ↓	

Step4	Check if there are any abnormalities in EVCC.
	<ol style="list-style-type: none"> 1 Turn off the ignition switch. 2 Disconnect and inspect the EVCC harness plug FL09. 3 Inspection and maintenance: <ul style="list-style-type: none"> • Corrosion (installing new connectors or terminals - cleaning module pins). • Damaged or bent pins - install new terminals/pins. • Pin flying - Install new pins as needed. 4 Reconnect the EVCC plug and all other previously disconnected plugs. Ensure proper pin position and fixation 5 Run the system and determine if the problem still exists?
	YES → Replace EVCC.
NO ↓	
At this point, the system is operating normally. The possible cause of the problem may be module connection. Address the root cause of any connector or pin issues.	
Next Step ↓	

DTC Summary list(VCU)

DTC	English descriptions	Reference page
P0641-00	The sensor is powered by 5V1 voltage fault VP	P0641-00 、 P0651-00 、 P0697-00
P0651-00	The sensor is powered by 5V2 voltage fault AP1 BP	
P0697-00	The sensor is powered by 5V3 voltage fault AP2 HL	
P0563-00	The system voltage is too high	P0563-00 、 P0562-00
P0562-00	The system voltage is too low	
P057D-00	Brake pedal position sensor STB failure	P057D-00 、 P057C-00 、 P057B-00 、 P0571-00
P057C-00	Brake pedal position sensor STG failure	
P057B-00	The brake pedal position sensor voltage is out of range	
P0571-00	Brake pedal position sensor rationality diagnosis	
P0558-00	Brake vacuum pressure sensor STB failure	P0558-00 、 P0557-00 、 P0556-00 、 P1C70-00
P0557-00	Brake vacuum pressure sensor STG failure	
P0556-00	Brake vacuum pressure sensor voltage out of range	
P1C70-00	Brake vacuum pressure sensor rationality diagnosis	
P1C71-00	Brake vacuum booster pump continuous overload warning	No maintenance is required. Please do not step on the brake continuously for a long time to avoid EVP burning.
P1C72-00	Brake vacuum booster pump continuous overload protection	
P258D-00	Brake vacuum booster pump relay STB	P258D-00 、 P258C-00 、 P258A-00
P258C-00	Brake vacuum booster pump relay STG	
P258A-00	Brake vacuum booster pump relay OPEN	
P050F-00	Vacuum pump system leakage	Check the tightness of EVP related pump body and pipeline.
P2123-00	Accelerator pedal position sensor 1STB	P2123-00 、 P2122-00 、 P2128-00 、 P2127-00 、 P2135-00 、 P2136-00 、 P2138-00
P2122-00	Accelerator pedal position sensor 1STG	
P2128-00	Accelerator pedal position sensor 2STB	
P2127-00	Accelerator pedal position sensor 2STG	
P2135-00	Accelerator pedal position sensor 1 voltage out of range	
P2136-00	Accelerator pedal position sensor 2 voltage out of range	
P2138-00	The accelerator pedal input signal 1 is inconsistent with the accelerator pedal input signal 2	
P1C00-00	Motor controller inlet temperature sensor STB	
P1C01-00	Motor controller inlet temperature sensor STG	
P1C03-00	Motor controller inlet temperature sensor input rationality diagnosis	

VCU

DTC	English descriptions	Reference page
P0692-00	Fan relay 1 control terminal STB	P0692-00 , P0691-00 , P0480-00
P0691-00	Fan relay 1 control terminal STG	
P0480-00	Fan relay 1 control terminal OPEN	
P0A07-00	Motor controller, cooling system, water pump output STB	P0A07-00 , P0A06-00 , P0A05-00
P0A06-00	Motor controller, cooling system, water pump output STG	
P0A05-00	Motor controller, cooling system, water pump, output OPEN	
P1C10-00	Motor controller: cooling system, water pump, no water dry running	P1C10-00 , P1C11-00 , P1C12-00 , P1C13-00
P1C11-00	Motor controller, cooling system, water pump stall	
P1C12-00	Motor controller, cooling system, water pump overtemperature	
P1C13-00	The speed of the motor controller cooling system water pump is too low	
P0687-00	Main relay control terminal STB	P0687-00 , P0686-00 , P0688-00
P0686-00	Main relay control terminal STG	
P0688-00	The main relay control terminal is OPEN	
P1C20-00	PowerLimit	P1C2000 , P1C2100
P1C21-00	PowerShutDown	
U0121-87	VCU communication with ESP is lost	U0121-87 , U0151-87 , U0140-87 , U0298-87 , U0291-87 , U0110-87 , U0111-87 , U019B-87 , U1113-87 , U0164-87 , U0155-87 , U0073-88 , U0074-88
U0151-87	VCU communication with SRS is lost	
U0140-87	VCU communication with BCM is lost	
U0298-87	VCU communication with DCDC is lost	
U0291-87	VCU communication with SCU is lost	
U0110-87	VCU communication with PEU is lost	
U0111-87	VCU communication with BMS is lost	
U019B-87	VCU communication with OBC is lost	
U1113-87	VCU communication with FEM is lost	
U0164-87	VCU communication with HCM is lost	
U0155-87	VCU communication with IPK is lost	
U0073-88	The PTCAN bus is turned off	
U0074-88	The EPTCAN bus is turned off	
P1C40-00	The actual torque is higher than the required torque of the driver	
P1C41-00	The actual torque is lower than the required torque for the driver	
P1C97-00	Baro sensor rationality	P1C97-00
P1C98-00	Energy recovery rationality failure	The fault has been closed.
P1CDD-00	ESP failure	No need to repair
P1CB1-00	collide	P1CB1-00
P1C22-00	High voltage power-up failed	P1C22-00 , P1CB2-00
P1CB2-00	On high voltage timeout	

DTC	English descriptions	Reference page
P1CB3-00	The high-voltage battery is not in Operation mode	P1CB3-00 , P1CB5-00 , P1CB6-00 , P1CB7-00
P1CB5-00	Battery level 2 failure	
P1CB6-00	Battery level 3 failure	
P1CB7-00	Battery level 4 failure	
P1CB8-00	Battery high voltage interlock failure	P1CB8-00
P1CB9-00	Battery high voltage interlock failure	P1CB9-00
P1CC0-00	CDU high voltage interlock failure	P1CC0-00
P1CC1-00	PTC high voltage interlock failure	P1CC1-00
P1CC2-00	EPP unlock failure	P1CC2-00 , P1CC3-00
P1CC3-00	EPP lighting	
P1CC4-00	Motor level 1 failure	P1CC4-00 , P1CC5-00 , P1CC6-00 , P1CEA-00
P1CC5-00	Motor level 2 failure	
P1CC6-00	Motor level 3 failure	
P1CEA-00	Motor level 4 failure	
P1CC7-00	The speed signal is invalid	P1CC7-00 , P1CC8-00 , P1CC9-00
P1CC8-00	Wrong wheel speed signal	
P1CC9-00	The wheel speed signal is invalid	
P1CE0-00	FEM sensor failure	P1CE0-00 , P1CE1-00
P1CE1-00	FEM thermal runaway alarm	
P1CE5-00	The water inlet temperature sensor is faulty	P1CE5-00 , P1CE6-00 , P1CE9-00
P1CE6-00	The outlet temperature sensor is faulty	
P1CE9-00	Total success rate output failure	

P0641-00、 P0651-00、 P0697-00

Fault diagnosis code
P0641-00: The sensor is powered by 5V1 voltage fault VP
P0651-00: The sensor is powered by 5V2 voltage fault AP1 BP
P0697-00: The sensor is powered by 5V3 voltage fault AP2 HL
Detection tools
1 Multimeter and diagnostic apparatus
Possible causes
<ul style="list-style-type: none"> • ircuit,terminal and adapting piece fault • Battery • VCU • Charging system • Insurance fuse
Conditions for fault code operation
The ignition switch is in the ON position.
Conditions for fault code setting
P0641-00
The sensor power supply 5V1 voltage is detected to be greater than 5.2V or less than 4.7V.
P0651-00
The sensor power supply 5V2 voltage is detected to be greater than 5.2V or less than 4.7V.
P0697-00
The sensor power supply 5V3 voltage is detected to be greater than 5.2V or less than 4.7V.
To set the effect of a fault code condition
Description of circuit diagram
The VCU will monitor whether all sensors and actuators are within normal range all the time. Meanwhile,it will check the connector for virtual connection, short circuit, open circuit and the connection rationality with other signals. When fault occurs, the VCU will save the fault code corresponding to that fault and enable safety mode.

Circuit diagram

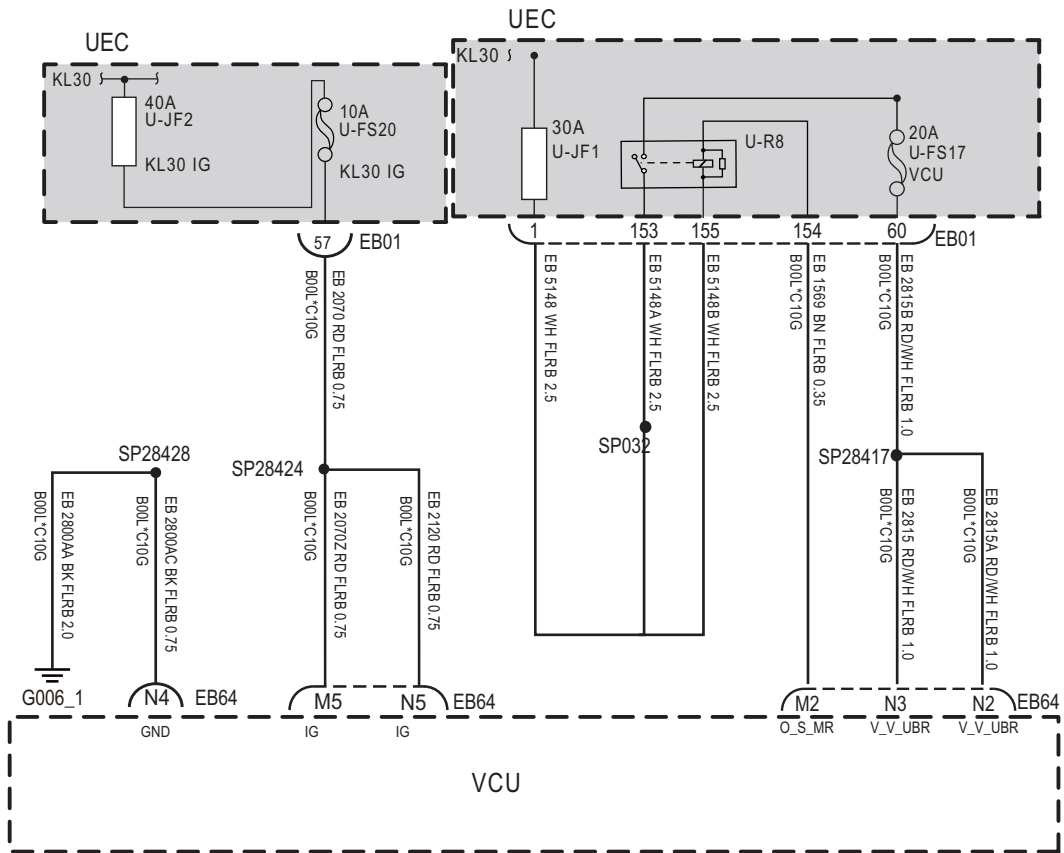

EB64

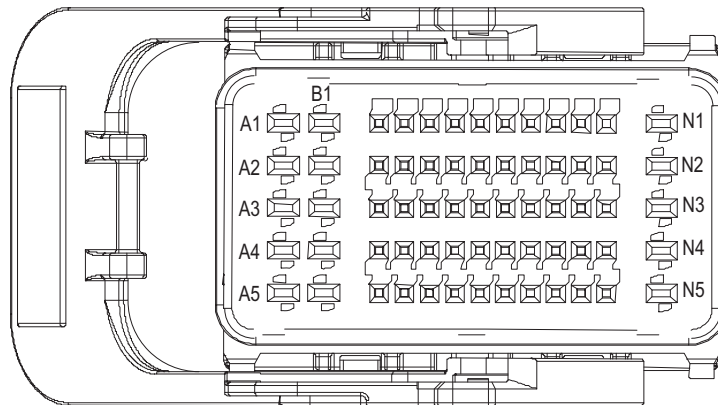

EK891201

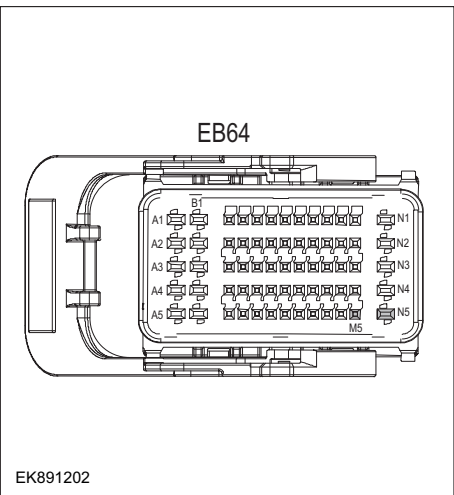
Troubleshooting steps	
Step 1	General inspection.
	<ol style="list-style-type: none"> 1 Check fuses U-JF2、 U-FS20、 U-FS17 or damage. 2 Check whether relays U-JF1 and U-R8 are damaged. 3 Check battery capacity. 4 Check the harness plug of air conditioning control for damage, poor contact, aging and looseness. 5 Check whether the result is normal or not?
	NO → Repair or replace the faulted parts.
YES ↓	
Step 2	Check fault codes.
	<ol style="list-style-type: none"> 1 Connect the fault diagnosis instrument to the diagnosis interface. 2 Turn the ignition switch to ON position. 3 Check the body control with a diagnostic apparatus. 4 Are there any other fault code except for P0641-00/P0651-00/P0697-00?
	YES → Refer to: DTC Summary list(VCU) .
NO ↓	
Step 3	Check the power voltage of VCU battery.
 <p>EK891202</p>	<ol style="list-style-type: none"> 1 Turn the ignition switch to OFF. 2 Disconnect the harness plug EB64 of VCU. 3 Measure the voltage between the VCU harness terminals and ground. <ul style="list-style-type: none"> Measuring circuit: voltage between terminal N5 on plug EB64 and ground. Measuring circuit: voltage between terminal M5 on plug EB64 and ground <p>Standard value: 10~14V</p> 4 Check whether the result is normal or not?
	NO → Repair the circuit.
YES ↓	

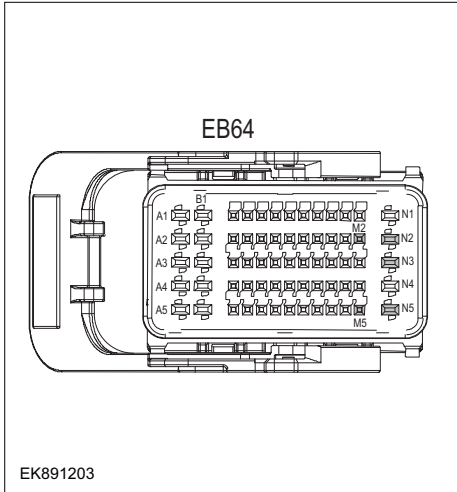
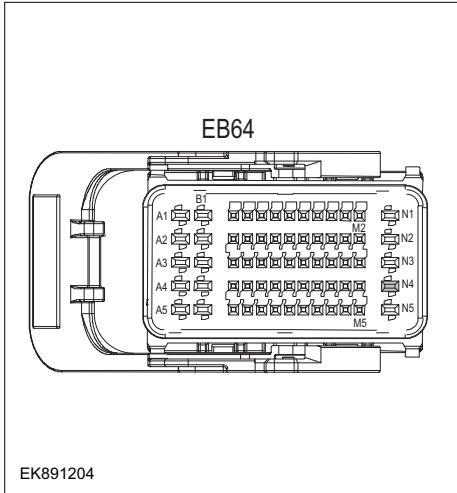
Step 4	Check the power voltage when the VCU is started or operating
	<ol style="list-style-type: none"> 1 Turn the ignition switch to ON. 2 Measure the voltage between the harness terminal of VCU and ground. Measuring circuit: voltage between terminal N5 on plug EB64 and ground. Measuring circuit: voltage between terminal M5 on plug EB64 and ground Measuring circuit: voltage between terminal M2 on plug EB64 and ground. Measuring circuit: voltage between terminal N2 on plug EB64 and ground Measuring circuit: voltage between terminal N3 on plug EB64 and ground Standard value:10~14V 3 Check whether the result is normal or not?
NO → Repair the circuit.	
YES ↓	
Step 5	Test whether the grounding circuit of VCU is open.
	<ol style="list-style-type: none"> 1 Turn the ignition switch to OFF. 2 Disconnect the harness plug EB64 of VCU. 3 Measure the resistance between the harness terminal of VCU and ground. Measuring circuit: resistance between terminal N4 on plug EB64 and ground. Standard value: < 1Ω 4 Test whether the resistance is less than 1Ω?
NO → Repair the circuit	
YES ↓	

VCU

Step 6	Test whether VCU is norm.
	<ol style="list-style-type: none">1 Turn the ignition switch to OFF.2 Disconnect and check the harness plug EB64,EB66 of VCU.3 Check and repair.<ul style="list-style-type: none">• Corrosion(install new adapting piece or terminal-cleaning and pin).• Pin damaged or bent-install new terminal/pin.• Fly out of pins-install new pins as needed.4 Reconnect the VCU plug and all other previously disconnected plug. Make sure the pin is properly positioned and fixed.5 Run the system and determine if the problem persists?
	YES → Replace the VCU.
NO ↓	
At this point the system is functioning normally. The problem may be caused by connections. Address the root cause of any connector or pin problems	
Next Step ↓	
Diagnosis end.	

P0563-00、 P0562-00

Fault diagnosis code
P0563-00: The system voltage is too high
P0562-00: The system voltage is too low
Detection tools
1 Multimeter and diagnostic apparatus
Possible causes
<ul style="list-style-type: none"> • Circuit,terminal and adapting piece fault • Battery • VCU • Charging system • Insurance fuse
Conditions for fault code operation
Turn the ignition switch to ON position
Conditions for fault code setting
P0563-00
Check the battery voltage is greater than 16V.
P0562-00
Check the battery voltage is less than 9V.
To set the effect of a fault code condition
Description of circuit diagram
The VCU will monitor whether all sensors and actuators are within normal range all the time. Meanwhile,it will check the connector for virtual connection, short circuit, open circuit and the connection rationality with other signals. When fault occurs, the VCU will save the fault code corresponding to that fault and enable safety mode

Circuit diagram

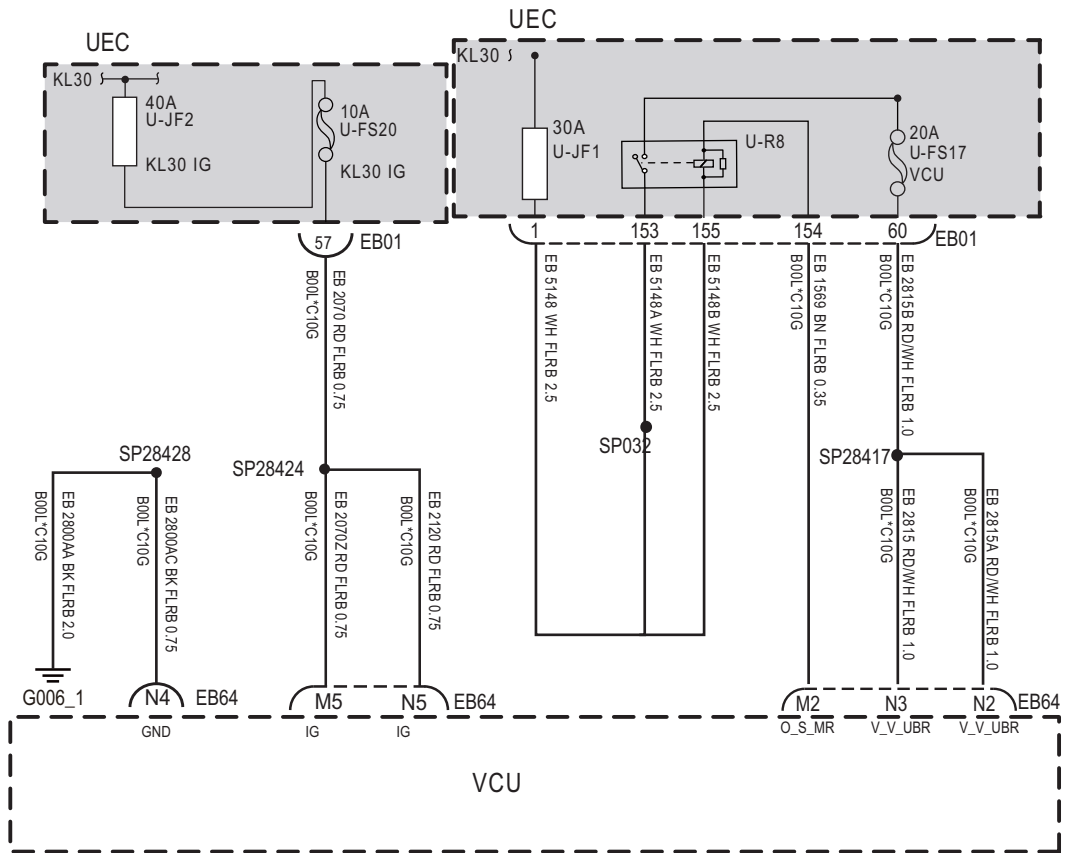

EB64

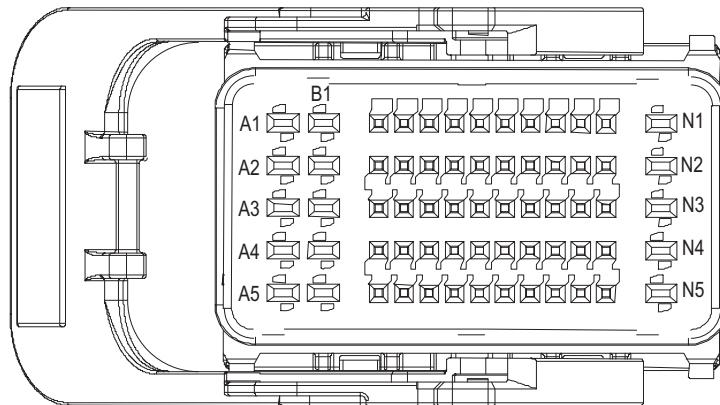

EK891201

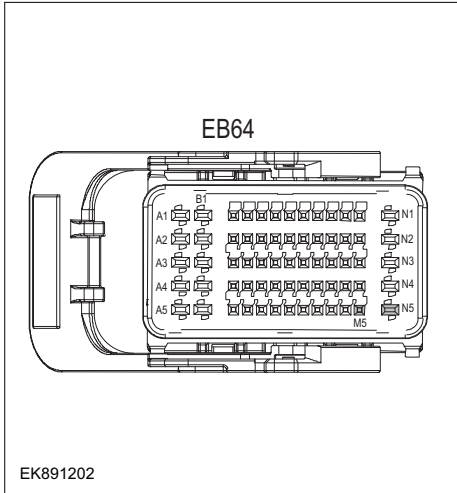
Troubleshooting steps	
Step 1	General inspection.
	<ol style="list-style-type: none"> 1 Check fuses U-JF2/U-FS20/U-FS17 for damage. 2 Check whether relays U-JF1 and U-R8 are damaged. 3 Check that the battery is fully charged. 4 Check the harness plug of air conditioning control for damage, poor contact, aging and looseness. 5 Check whether the result is normal or not?
	NO → Repair or replace the faulted parts.
YES ↓	
Step 2	Check fault codes.
	<ol style="list-style-type: none"> 1 Connect the fault diagnosis instrument to the diagnosis interface. 2 Turn the ignition switch to ON position. 3 Check the body control with a diagnostic apparatus. 4 If there is any fault code except for P0563-00、P0562-00?
	YES → Refer to: DTC Summary list(VCU) .
NO ↓	
Step 3	Check the power voltage of VCU battery.
 <p>EK891202</p>	<ol style="list-style-type: none"> 1 Turn the ignition switch to OFF. 2 Disconnect the harness plug EB64 of VCU. 3 Measure the voltage between the harness terminal of VCU and ground. Measuring circuit: voltage between terminal N5 on plug EB64 and ground. Measuring circuit: voltage between terminal M5 on plug EB64 and ground. Standard value:10~14V 4 Check whether the result is normal or not?
	NO → Repair the circuit.
YES ↓	

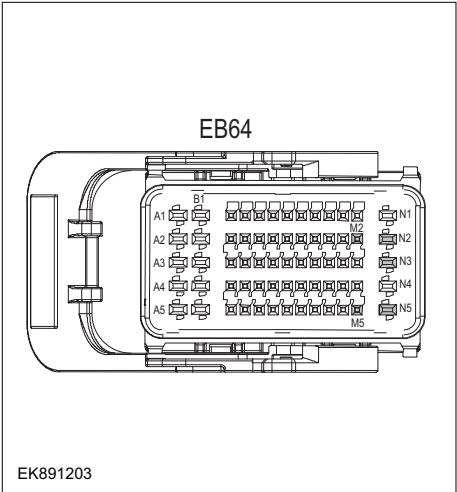
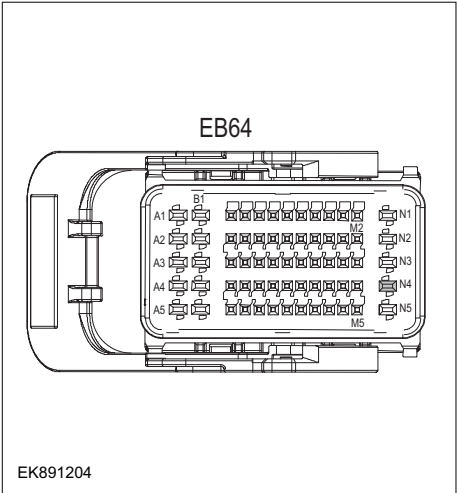
Step 4	Check the power voltage when the VCU is started or operating
	<ol style="list-style-type: none"> 1 Turn the ignition switch to ON. 1 Turn the ignition switch to ON. 2 Measure the voltage between the harness terminal of VCU and ground. Measuring circuit: voltage between terminal N5 on plug EB64 and ground. Measuring circuit: voltage between terminal M5 on plug EB64 and ground. Measuring circuit: voltage between terminal M2 on plug EB64 and ground. Measuring circuit: voltage between terminal N2 on plug EB64 and ground. Measuring circuit: voltage between terminal N3 on plug EB64 and ground. Standard value: 10~14V 3 Check whether the result is normal or not?
NO → Repair the circuit.	
YES ↓	
Step 5	Test whether the grounding circuit of VCU is open.
	<ol style="list-style-type: none"> 1 Turn the ignition switch to OFF. 2 Disconnect the harness plug EB64 of VCU. 3 Measure the resistance between the harness terminal of VCU and ground. Measuring circuit: resistance between terminal N4 on plug EB64 and ground. Standard value: < 1Ω 4 Test whether the resistance is less than 1Ω?
NO → Repair the circuit.	
YES ↓	

Step 6	Test whether VCU is norm.
	<ol style="list-style-type: none"> 1 Turn the ignition switch to OFF. 2 Disconnect and check the harness plug EB64,EB66 of VCU. 3 Check and repair. <ul style="list-style-type: none"> • Corrosion(install new adapting piece or terminal-cleaning and pin). • Pin damaged or bent-install new terminal/pin. • Fly out of pins-install new pins as needed. 4 Reconnect the VCU plug and all other previously disconnected plug. Make sure the pin is properly positioned and fixed. 5 Run the system and determine if the problem persists?
	YES → Replace the VCU.
NO ↓	
At this point the system is functioning normally. The problem may be caused by connections. Address the root cause of any connector or pin problems.	
Next Step ↓	
Diagnosis end.	

P057D-00、 P057C-00、 P057B-00、 P0571-00

Fault diagnosis code
P057D-00: Brake pedal position sensor STB failure
P057C-00: Brake pedal position sensor STG failure
P057B-00: The brake pedal position sensor voltage is out of range
P0571-00: Brake pedal position sensor rationality diagnosis
Detection tools
1 Multimeter and diagnostic apparatus
Possible causes
<ul style="list-style-type: none"> • Circuit,terminal and adapting piece fault • VCU • Brake pedal positioning sensor fault.
Conditions for fault code operation
Turn the ignition switch to ON position.
Conditions for fault code setting
P057D-00
Brake pedal positioning sensor voltage is greater than or equal to 4.9V
P057C-00
Brake pedal positioning sensor voltage is lower than or equal to 4.9V
P057B-00
Any of the following conditions are satisfied: 1, Brake pedal positioning sensor voltage is greater than 4.5V ; 2, Brake pedal positioning sensor voltage is lower than 4.9V.
P0571-00
The absolute value of the difference between the brake pedal opening and VCU's brake pedal opening is greater than or equal to 10%
To set the effect of a fault code condition
Description of circuit diagram
The VCU monitors the brake pedal position sensor via low level reference circuit and signal circuit.

Circuit diagram

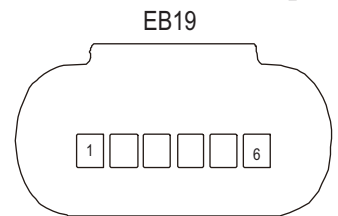
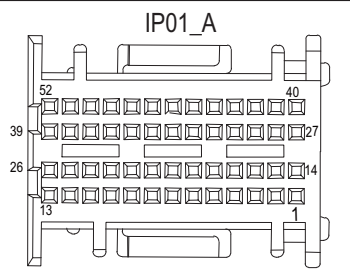
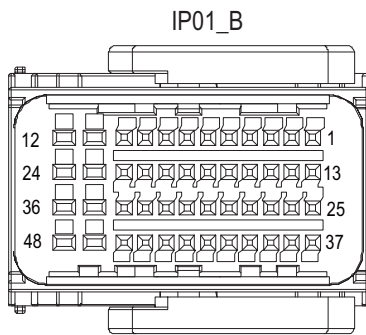
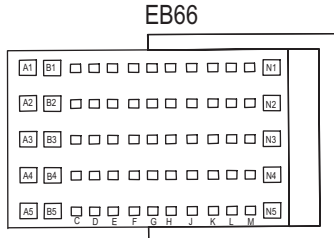
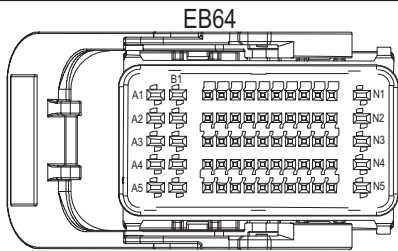
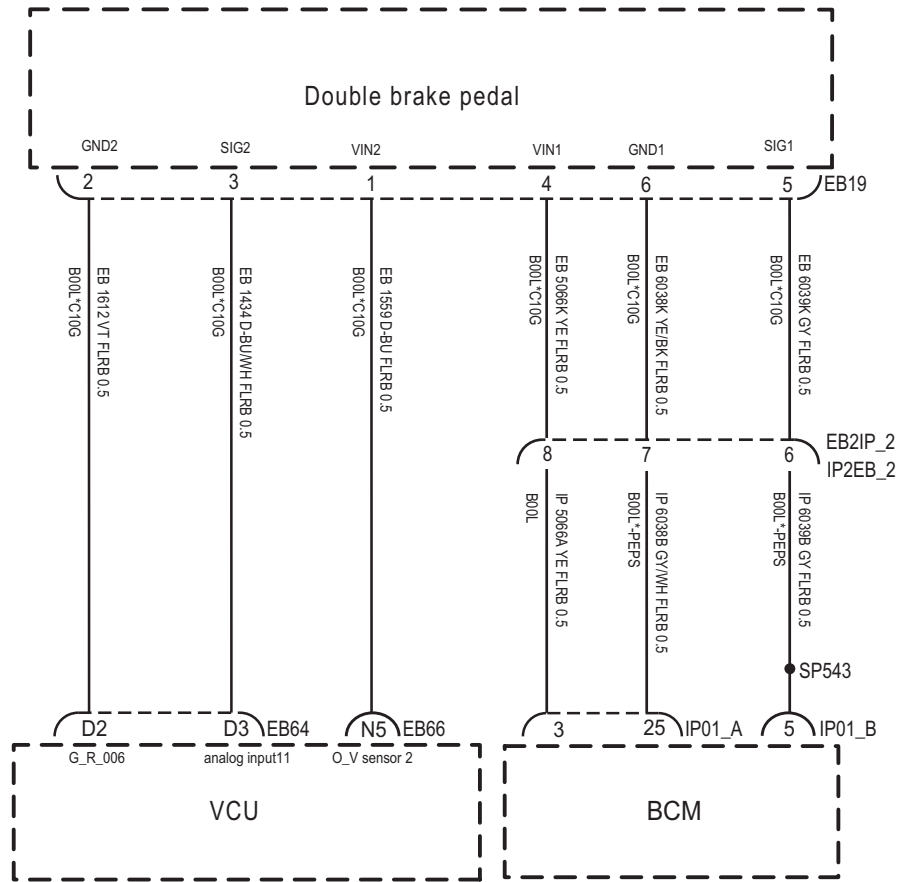

EK891205

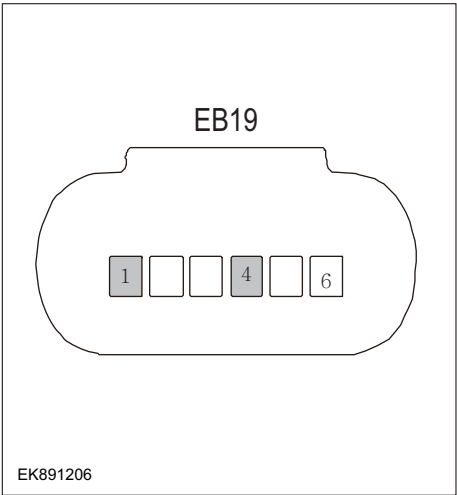
Troubleshooting steps	
Step 1	General inspection.
	<ol style="list-style-type: none"> 1 Check the fuse for damage. 2 Check battery capacity. 3 Check the harness plug of brake pedal position sensor, VCU for damage, poor contact, aging and looseness. 4 Check whether the result is normal or not?
NO → Repair or replace the faulted parts.	
YES ↓	
Step 2	Check fault codes.
	<ol style="list-style-type: none"> 1 Connect the fault diagnosis instrument to the diagnosis interface. 2 Turn the ignition switch to ON position. 3 Diagnose the VCU with diagnostic apparatus. 4 Is there any other fault code except for P057D-00、P057C-00、P057B-00、P0571-00?
YES → Refer to: DTC Summary list(VCU) .	
NO ↓	
Step 3	Check the supply power of brake pedal positioning sensor when it is started or operating.
 <p>The diagram shows a top-down view of a multi-pin connector labeled EB19. It has six terminals in a row. Terminal 1 is shaded grey, terminal 4 is shaded grey, and terminal 6 is shaded grey. The other three terminals are white. The diagram is labeled EK891206 at the bottom left.</p>	<ol style="list-style-type: none"> 1 Turn the ignition switch to OFF 2 Disconnect the harness plug EB19 of brake pedal positioning sensor. 3 Turn the ignition switch to ON. 4 Measure the voltage between the plug terminal of brake pedal positioning sensor and ground. Measuring circuit: voltage between terminal 1 on plug EB19 and ground. Measuring circuit: voltage between terminal 4 on plug EB19 and ground. Standard value: 4.7~5.2V 5 Check whether the result is normal or not?
NO → Repair the circuit.	
YES ↓	

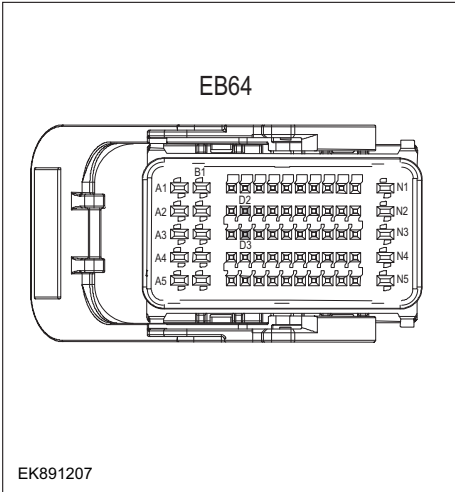
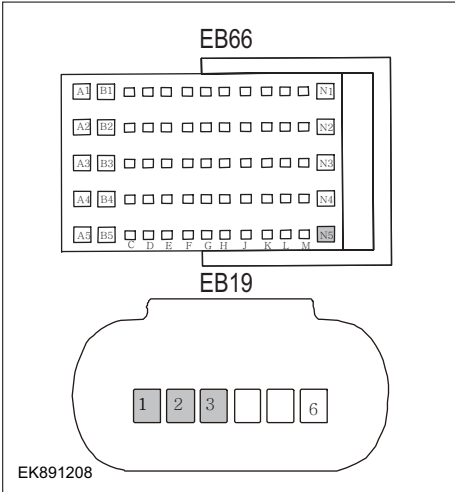
<p>Step 4</p>	<p>Check the circuit between brake pedal positioning sensor and VCU (open).</p>
<div style="text-align: center;">  <p>EB64</p> <p>EK891207</p> </div> <div style="text-align: center; margin-top: 20px;">  <p>EB66</p> <p>EB19</p> <p>EK891208</p> </div>	<ol style="list-style-type: none"> 1 Turn the ignition switch to OFF. 2 Disconnect the harness plug EB64,EB66 of VCU . 3 Measure the resistance between the harness terminal of brake pedal positioning sensor and the VCU. <ul style="list-style-type: none"> Measuring circuit: resistance between EB19 plug No. 1 terminal and EB66 plug N5 terminal. Measuring circuit: resistance between EB19 plug No. 2 terminal and EB64 plug D2 terminal. Measuring circuit: resistance between EB19 plug 3 terminal and EB64 plug D3 terminal. <p>Standard value: $\approx 0\Omega$</p> 4 Check whether the result is normal or not?
<p>NO → Repair or replace the faulted parts.</p>	
<p>YES ↓</p>	

Step 5	Check the circuit between brake pedal positioning sensor and BCM (open).
<div data-bbox="197 255 655 745"> <p>IP01_B</p> <p>EB19</p> <p>EK891209</p> </div> <div data-bbox="197 775 655 1261"> <p>IP01_A</p> <p>EK891210</p> </div>	<ol style="list-style-type: none"> 1 Turn the ignition switch to OFF. 2 Disconnect the harness plug IP09_A, IP09_B of BCM . 3 Measure the resistance between the harness terminal of brake pedal positioning sensor and the BCM. <ul style="list-style-type: none"> Measuring circuit: resistance between EB19 plug 5 terminal and IP01_B plug 5 terminal. Measuring circuit: resistance between EB19 plug 4 terminal and IP01_A plug 3 terminal. Measuring circuit: resistance between EB19 plug 6 terminal and IP01_A plug 25 terminal. <p>Standard value: $\approx 0\Omega$</p> 4 Check whether the result is normal or not?
	<p>NO → Repair or replace the faulted parts.</p>
<p>YES ↓</p>	

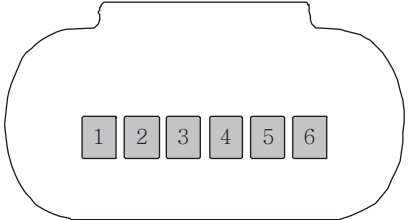
Step 6	Check the power supply circuit of brake pedal positioning sensor circuit (short circuit).
<div data-bbox="242 255 699 745" style="border: 1px solid black; padding: 10px; text-align: center;"> <p>EB19</p>  <p>EK891211</p> </div>	<ol style="list-style-type: none"> 1 Turn the ignition switch to OFF. 2 Measure the resistance between the harness plug of brake pedal positioning sensor and ground. <ul style="list-style-type: none"> Measuring circuit: resistance between terminal 1 on plug EB19 and ground. Measuring circuit: resistance between terminal 2 on plug EB19 and ground. Measuring circuit: resistance between terminal 3 on plug EB19 and ground. Measuring circuit: resistance between terminal 4 on plug EB19 and ground. Measuring circuit: resistance between terminal 5 on plug EB19 and ground. Measuring circuit: resistance between terminal 6 on plug EB19 and ground. <p>Standard value: ∞</p> 3 Measure the voltage between the harness plug of brake pedal positioning sensor and ground. <ul style="list-style-type: none"> Measuring circuit: voltage between terminal 1 on plug EB19 and ground. Measuring circuit: voltage between terminal 2 on plug EB19 and ground. Measuring circuit: voltage between terminal 3 on plug EB19 and ground. Measuring circuit: voltage between terminal 4 on plug EB19 and ground. Measuring circuit: voltage between terminal 5 on plug EB19 and ground. Measuring circuit: voltage between terminal 6 on plug EB19 and ground. <p>Standard value: ≈ 0V</p> 4 Check whether the result is normal or not?
	<p>NO → Repair or replace the faulted parts.</p>
<p>YES ↓</p>	

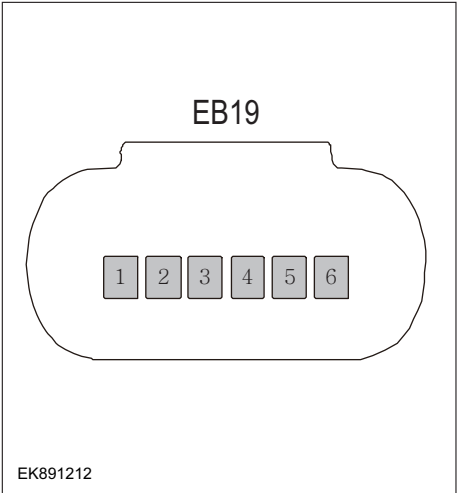
Step 7	Check the brake pedal position sensor (components).
	<ol style="list-style-type: none"> 1 Measure the resistance of the terminal of brake pedal position sensor directly. Measuring circuit: resistance between terminal 2 and terminal 6 on plug EB19. Standard value: Measuring circuit: resistance between terminal 3 and terminal 5 on plug EB19. Standard value: 2 Measure the resistance between the brake pedal position sensor terminal and the housing. Measuring circuit: resistance between terminal 1 on plug EB19 and the housing. Measuring circuit: resistance between terminal 2 on plug EB19 and the housing. Measuring circuit: resistance between terminal 3 on plug EB19 and the housing. Measuring circuit: resistance between terminal 4 on plug EB19 and the housing. Measuring circuit: resistance between terminal 5 on plug EB19 and the housing. Measuring circuit: resistance between terminal 6 on plug EB19 and the housing. Standard value: ∞ 3 Check whether the result is normal or not?
NO → Replace brake pedal position sensor.	
YES ↓	
Step 8	Test whether VCU is norm.
	<ol style="list-style-type: none"> 1 Turn the ignition switch to OFF. 2 Disconnect and check the harness plug EB64, IP55_A of VCU. 3 Check and repair. <ul style="list-style-type: none"> • Corrosion(install new adapting piece or terminal-cleaning and pin). • Pin damaged or bent-install new terminal/pin. • Fly out of pins-install new pins as needed. 4 Reconnect the VCU plug and all other previously disconnected plug. Make sure the pin is properly positioned and fixed. 5 Run the system and determine if the problem persists?
YES → Change the VCU .	

NO ↓
At this point the system is functioning normally. The problem may be caused by connections. Address the root cause of any connector or pin problems.
Next Step ↓
Diagnosis end.

P0558-00、 P0557-00、 P0556-00、 P1C70-00

Fault diagnosis code
P0571-00: Brake pedal position sensor rationality diagnosis
P0558-00: Brake vacuum pressure sensor STB failure
P0557-00: Brake vacuum pressure sensor STG failure
P0556-00: Brake vacuum pressure sensor voltage out of range
P1C70-00: Brake vacuum pressure sensor rationality diagnosis
Detection tools
1 Multimeter and diagnostic apparatus
Possible causes
<ul style="list-style-type: none"> • Circuit,terminal and adapting piece fault • VCU • The brake vacuum sensor fault
Conditions for fault code operation
Turn the ignition switch to ON position.
Conditions for fault code setting
P0558-00
Brake vacuum sensor voltage is greater than or equal to 4.9V
P0557-00
Brake vacuum sensor voltage is lower than or equal to 4.9V
P0556-00
Any of the following conditions are satisfied:
1. Brake vacuum sensor voltage is greater than 4.5V ;
2, Brake vacuum sensor voltage is lower than 4.9V.
P1C70-00
The diagnosis has been disabled
To set the effect of a fault code condition
Description of circuit diagram
The VCU monitors the brake vacuum sensor via low level reference circuit and signal circuit.

Circuit diagram

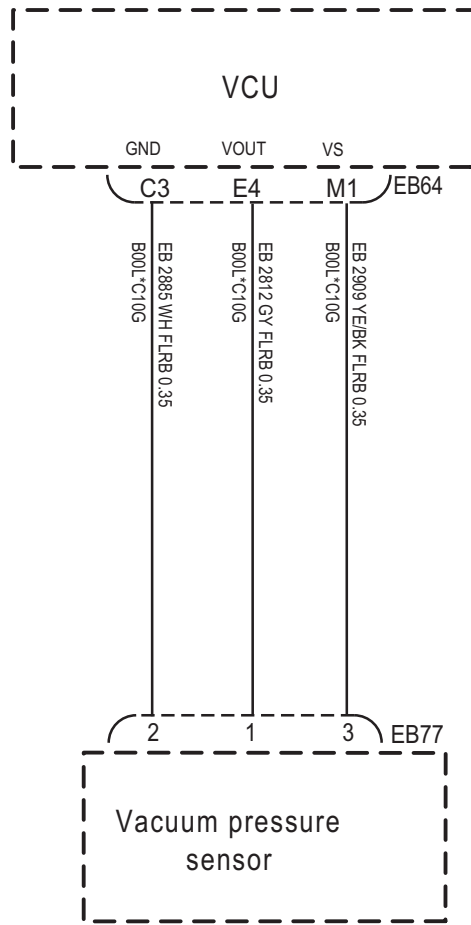

EB64

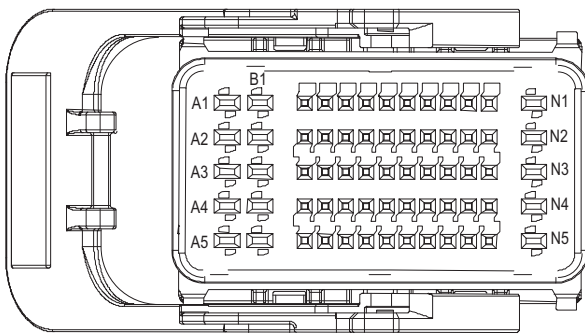

EB77

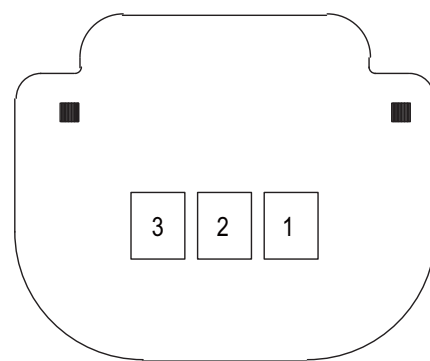

EK891213

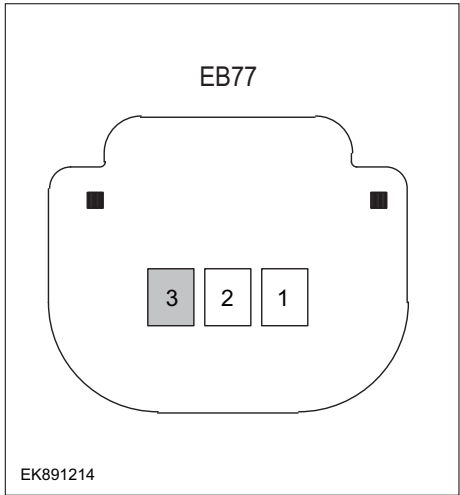
Troubleshooting steps	
Step 1	General inspection.
	<ol style="list-style-type: none"> 1 Check the fuse for damage. 2 Check battery capacity. 3 Check the harness plug of brake vacuum sensor, VCU for damage, poor contact, aging and looseness. 4 Check whether the result is normal or not?
	NO → Repair or replace the faulted parts.
YES ↓	
Step 2	Check fault codes.
	<ol style="list-style-type: none"> 1 Connect the fault diagnosis instrument to the diagnosis interface. 2 Turn the ignition switch to ON position. 3 Diagnose the VCU with diagnostic apparatus. 4 Is there any other fault code except for P0558-00、 P0557-00、 P0556-00、 P1C70-00?
	YES → Refer to: DTC Summary list(VCU) .
NO ↓	
Step 3	Check the supply power of brake vacuum sensor when it is started or operating.
	<ol style="list-style-type: none"> 1 Turn the ignition switch to OFF. 2 Disconnect the harness plug EB19 of brake vacuum sensor. 3 Turn the ignition switch to ON. 4 Measure the voltage between the plug terminal of brake vacuum sensor and ground. Measuring circuit: voltage between terminal 3 on plug EB19 and ground. Standard value: 4.7~5.2V 5 Check whether the result is normal or not?
	NO → Repair the circuit.
YES ↓	

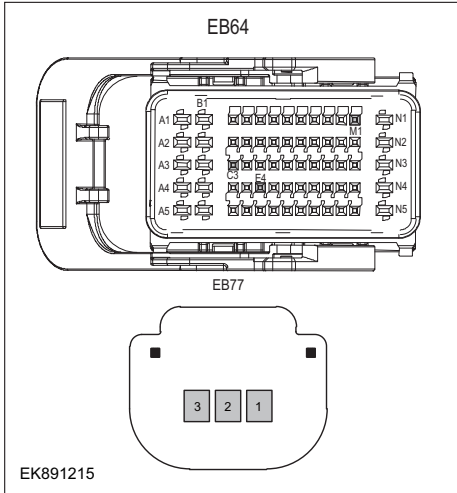
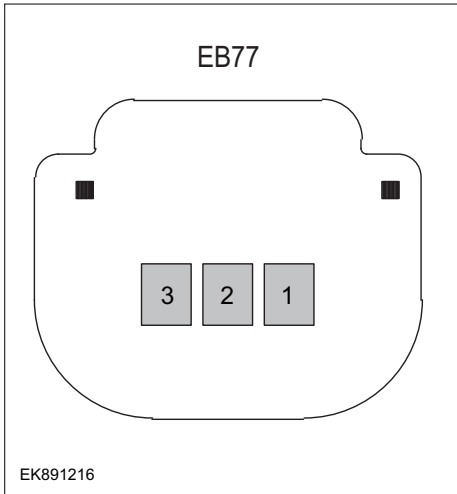
Step 4	Check the power supply circuit of brake vacuum sensor circuit(open circuit).
	<ol style="list-style-type: none"> 1 Turn the ignition switch to OFF. 2 Disconnect the harness plug EB64 of GAW . 3 Measure the resistance between the harness terminal of brake vacuum sensor and the VCU. Measuring circuit: resistance between terminal 1 on plug EB77and terminal E4 on plug EB64. Measuring circuit: resistance between terminal 2 on plug EB77and terminal C3on plug EB64. Measuring circuit: resistance between terminal 3 on plug EB77and terminal M1 on plug EB64. Standard value: $\approx 0\Omega$ 4 Check whether the result is normal or not?
NO → Repair or replace the faulted parts.	
YES ↓	
Step 5	Check the power supply circuit of brake vacuum sensor circuit(short circuit).
	<ol style="list-style-type: none"> 1 Turn the ignition switch to OFF. 2 Measure the resistance between the harness plug of brake vacuum sensor and ground. Measuring circuit: resistance between terminal 1 on plug EB77 and ground. Measuring circuit: resistance between terminal 2 on plug EB77 and ground. Measuring circuit: resistance between terminal 3 on plug EB77 and ground. Standard value: ∞ 3 Measure the voltage between the plug terminal of brake vacuum sensor and ground. Measuring circuit: voltage between terminal 1 on plug EB77 and ground. Measuring circuit: voltage between terminal 2 on plug EB77 and ground. Measuring circuit: voltage between terminal 3 on plug EB77 and ground. Standard value: $\approx 0V$ 4 Check whether the result is normal or not?
NO → Repair or replace the faulted parts.	
YES ↓	

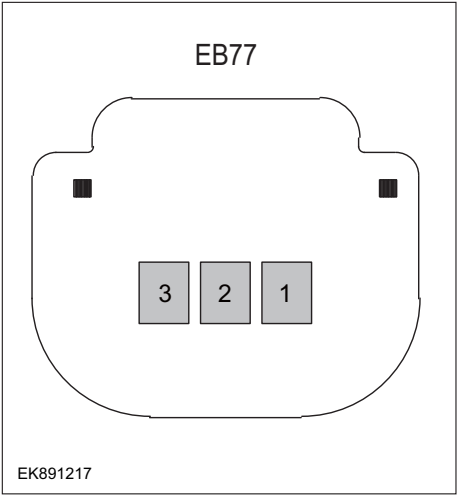
Step 6	Check the brake vacuum sensor (components).
	<ol style="list-style-type: none"> 1 Measure the resistance of the terminal of brake vacuum sensor directly. Measuring circuit: resistance between terminal 1 and terminal 2 on plug EB77. Standard value: 2 Measure the resistance between the brake vacuum sensor terminal and the housing. Measuring circuit: resistance between terminal 1 on plug EB77 and the housing. Measuring circuit: resistance between terminal 2 on plug EB77 and the housing. Measuring circuit: resistance between terminal 3 on plug EB77 and the housing. Standard value: ∞ 3 Check whether the result is normal or not?
NO → Replace brake vacuum sensor.	
YES ↓	
Step 7	Test whether VCU is norm.
	<ol style="list-style-type: none"> 1 Turn the ignition switch to OFF. 2 Disconnect and check the harness plug EB64, EB66 of VCU. 3 Check and repair. <ul style="list-style-type: none"> • Corrosion(install new adapting piece or terminal-cleaning and pin). • Pin damaged or bent-install new terminal/pin. • Fly out of pins-install new pins as needed. 4 Reconnect the VCU plug and all other previously disconnected plug. Make sure the pin is properly positioned and fixed. 5 Run the system and determine if the problem persists?
YES → Change the VCU	
NO ↓	
At this point the system is functioning normally. The problem may be caused by connections. Address the root cause of any connector or pin problems.	
Next Step ↓	
Diagnosis end.	

P258D-00、 P258C-00、 P258A-00

Fault diagnosis code
P258D-00: Brake vacuum booster pump relay STB
P258C-00: Brake vacuum booster pump relay STG
P258A-00: Brake vacuum booster pump relay OPEN
Detection tools
1 Multimeter and diagnostic apparatus
Possible causes
<ul style="list-style-type: none"> • Circuit,terminal and adapting piece fault • VCU • The brake vacuum pump fault.
Conditions for fault code operation
Turn the ignition switch to ON position.
Conditions for fault code setting
P258D-00
The underlying diagnosis
P258C-00
The underlying diagnosis
P258A-00
The underlying diagnosis
To set the effect of a fault code condition
Description of circuit diagram
The VCU monitors the brake vacuum pump via low level reference circuit and signal circuit.

Circuit diagram

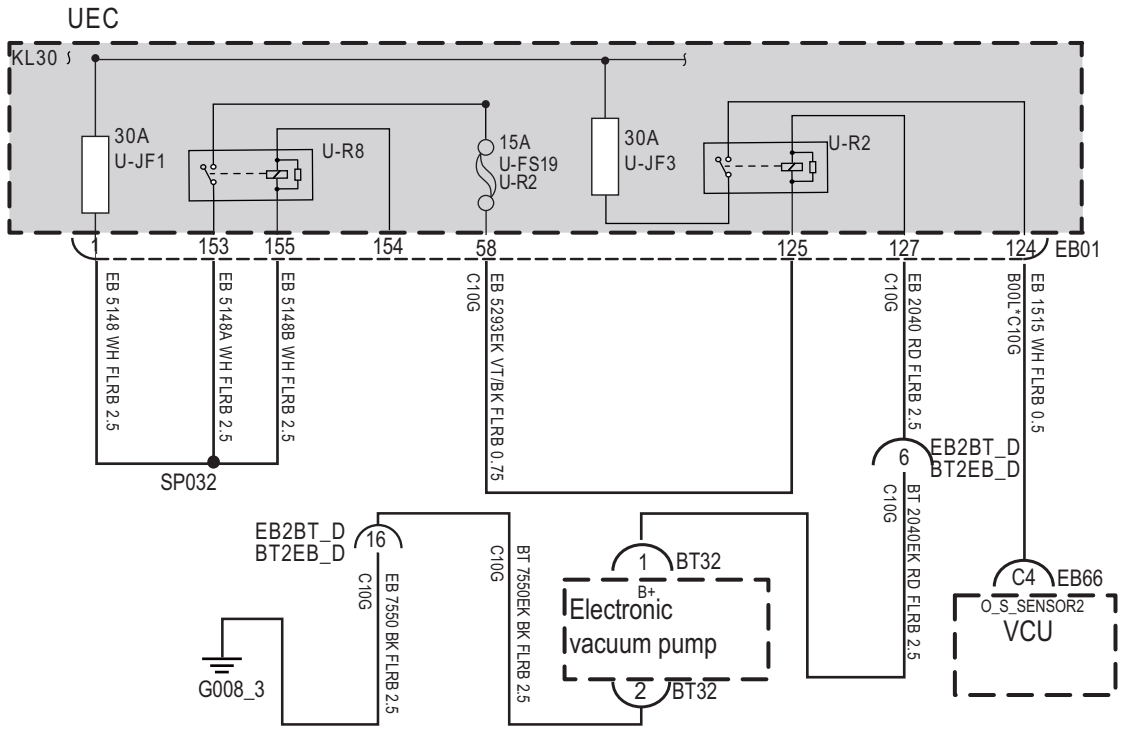

EB66

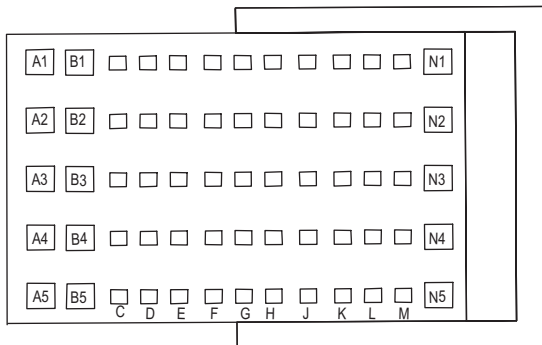

BT32

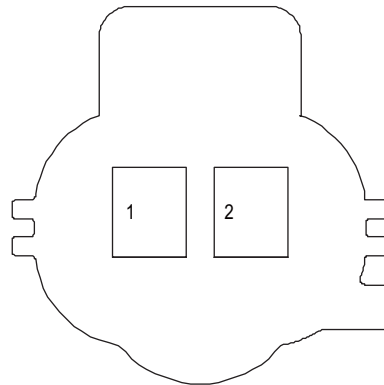

EK891218

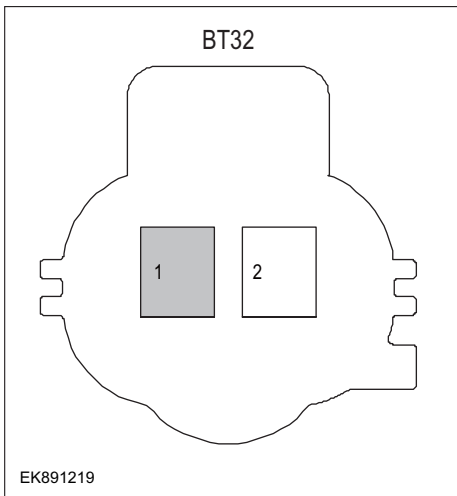
Troubleshooting steps	
Step 1	General inspection.
	<ol style="list-style-type: none"> 1 Check fuses U-JF1、 U-FS19、 U-JF3 for damage. 2 Check the relay U-R8 for damage. 3 Check battery capacity. 4 Check the harness plug of brake vacuum pump,VCU for damage, poor contact, aging and looseness. 5 Check whether the result is normal or not?
	NO → Repair or replace the faulted parts.
YES ↓	
Step 2	Check fault codes.
	<ol style="list-style-type: none"> 1 Connect the fault diagnosis instrument to the diagnosis interface. 2 Turn the ignition switch to ON position. 3 Diagnose the VCU with diagnostic apparatus. 4 Is there any other fault code except for P258D-00、 P258C-00、 P258A-00?
	YES → Refer to: DTC Summary list(VCU) .
NO ↓	
Step 3	Check the power voltage of brake vacuum pump battery.
	<ol style="list-style-type: none"> 1 Turn the ignition switch to OFF. 2 Disconnect the harness plug BT32 of brake vacuum pump 3 Turn the ignition switch to ON. 4 Measure the voltage between the plug terminal of brake vacuum pump and ground. Measuring circuit: voltage between terminal 1 on plug BT32 and ground. Standard value: 0V 5 Check whether the result is normal or not?
	NO → Repair or replace the faulted parts.
YES ↓	

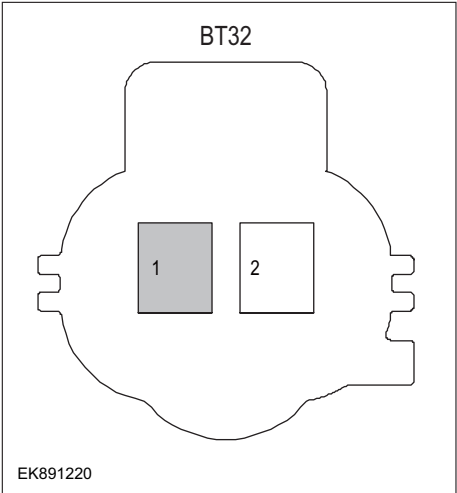
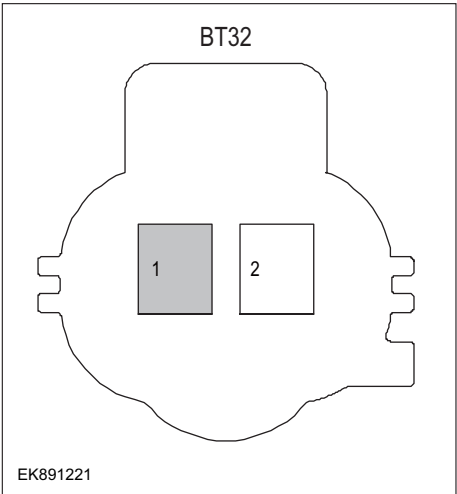
Step 4	Check the supply power of brake vacuum pump when it is started or operating
 <p>BT32</p> <p>EK891220</p>	<ol style="list-style-type: none"> 1 Turn the ignition switch to ON. 2 Step down the brake pedal and make the brake vacuum pump relay in working state. 3 Measure the voltage between the plug terminal of brake vacuum pump and ground. <p>Measuring circuit: voltage between terminal 1 on plug BT32 and ground.</p> <p>Standard value: 10~14V</p> <ol style="list-style-type: none"> 4 Check whether the result is normal or not?
NO → Repair or replace the faulted parts.	
YES ↓	
Step 5	Check the circuit between brake vacuum pump relay and brake vacuum pump(open circuit).
 <p>BT32</p> <p>EK891221</p>	<ol style="list-style-type: none"> 1 Turn the ignition switch to OFF. 2 Disconnect the harness plug EB01 of UEC. 3 Measure the resistance between the harness terminal of UEC and the brake vacuum pump. <p>Measuring circuit: resistance between terminal 127 on plug EB01 and terminal 1 on plug BT32.</p> <p>Standard value: $\approx 0\Omega$</p> <ol style="list-style-type: none"> 4 Check whether the result is normal or not?
NO → Repair or replace the faulted parts.	
YES ↓	

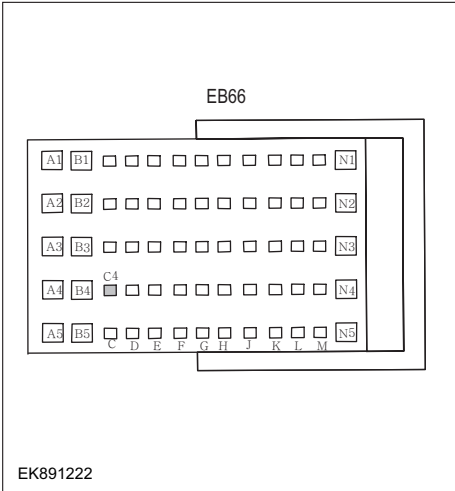
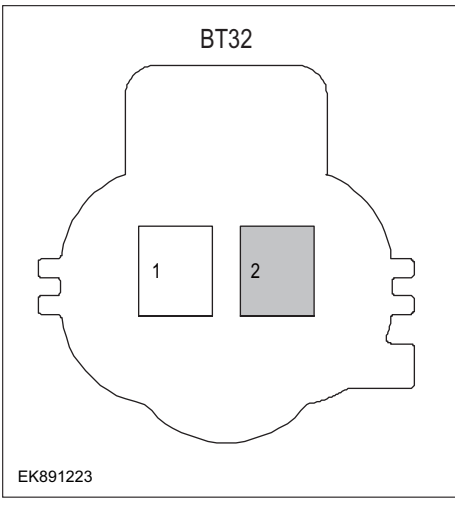
Step 6	Check the circuit between brake vacuum pump relay and VCU (open circuit).
 <p>EK891222</p>	<ol style="list-style-type: none"> 1 Turn the ignition switch to OFF. 2 Disconnect the harness plug EB66 of VCU . 3 Measure the resistance between the harness terminal of UEC and the VCU. Measuring circuit: resistance between terminal 124 on plug EB01 and terminal C4 on plug EB66. Standard value: $\approx 0\Omega$ 4 Check whether the result is normal or not?
NO → Repair or replace the faulted parts.	
YES ↓	
Step 7	Check the grounding circuit of brake vacuum pump .
 <p>EK891223</p>	<ol style="list-style-type: none"> 1 Turn the ignition switch to OFF. 2 Measure the resistance between the harness plug of brake vacuum pump and ground. Measuring circuit: resistance between terminal 2 on plug BT32 and ground. Standard value: $\approx 0\Omega$ 3 Check whether the result is normal or not?
NO → Repair or replace the faulted parts.	
YES ↓	

VCU

Step 8	Check the brake vacuum pump relay . (components)
	<ol style="list-style-type: none"> 1 Turn the ignition switch to OFF. 2 Replace the relay of brake vacuum pump in good condition. 3 Connect the fault diagnosis instrument to the diagnosis interface. 4 Turn the ignition switch to ON position. 5 Clear fault codes. 6 Reread fault codes. 7 Test whether the faulted code is existed.
	NO → Replace the relay of brake vacuum pump.
YES ↓	
Step 9	Test whether VCU is norm.
	<ol style="list-style-type: none"> 1 Turn the ignition switch to OFF. 2 Disconnect and check the harness plug EB64, EB66 of VCU. 3 Check and repair. <ul style="list-style-type: none"> • Corrosion(install new adapting piece or terminal-cleaning and pin). • Pin damaged or bent-install new terminal/pin. • Fly out of pins-install new pins as needed. 4 Reconnect the VCU plug and all other previously disconnected plug. Make sure the pin is properly positioned and fixed. 5 Run the system and determine if the problem persists?
	YES → Change the VCU
NO ↓	
At this point the system is functioning normally. The problem may be caused by connections. Address the root cause of any connector or pin problems.	
Next Step ↓	
Diagnosis end.	

P2123-00、 P2122-00、 P2128-00、 P2127-00、 P2135-00、 P2136-00、 P2138-00

Fault diagnosis code
P2123-00: Accelerator pedal position sensor 1STB
P2122-00: Accelerator pedal position sensor 1STG
P2128-00: Accelerator pedal position sensor 2STB
P2127-00: Accelerator pedal position sensor 2STG
P2135-00: Accelerator pedal position sensor 1 voltage out of range
P2136-00: Accelerator pedal position sensor 2 voltage out of range
P2138-00: The accelerator pedal input signal 1 is inconsistent with the accelerator pedal input signal 2
Detection tools
1 Multimeter and diagnostic apparatus
Possible causes
<ul style="list-style-type: none"> • Circuit, terminal and adapting piece fault • VCU • Accelerator pedal fault
Conditions for fault code operation
Turn the ignition switch to ON position.
Conditions for fault code setting
P2123-00
Accelerator pedal position sensor voltage is greater than or equal to 4.9V
P2122-00
Accelerator pedal position sensor 1 voltage is lower than or equal to 0.1V
P2128-00
Accelerator pedal position sensor voltage is greater than or equal to 4.9V
P2127-00
Accelerator pedal position sensor 2 voltage is lower than or equal to 0.1V
P2135-00
Any of the following conditions are satisfied:
1. Accelerator pedal position sensor 1 voltage is greater than 4.5V ;
2. Accelerator pedal position sensor 1 voltage is lower than 0.5V.
P2136-00
Any of the following conditions are satisfied:
1. Accelerator pedal position sensor 2 voltage is greater than 4.5V ;
2. Accelerator pedal position sensor 2 voltage is lower than 0.5V.
P2138-00

VCU

Any of the following conditions are satisfied:

The ratio of "Accelerator pedal signal1/accelerator pedal signal2" > 2.2;

The ratio of "Accelerator pedal signal1/accelerator pedal signal2" < 1.8

To set the effect of a fault code condition

Description of circuit diagram

The VCU monitors the accelerator pedal via low level reference circuit and signal circuit.

Circuit diagram

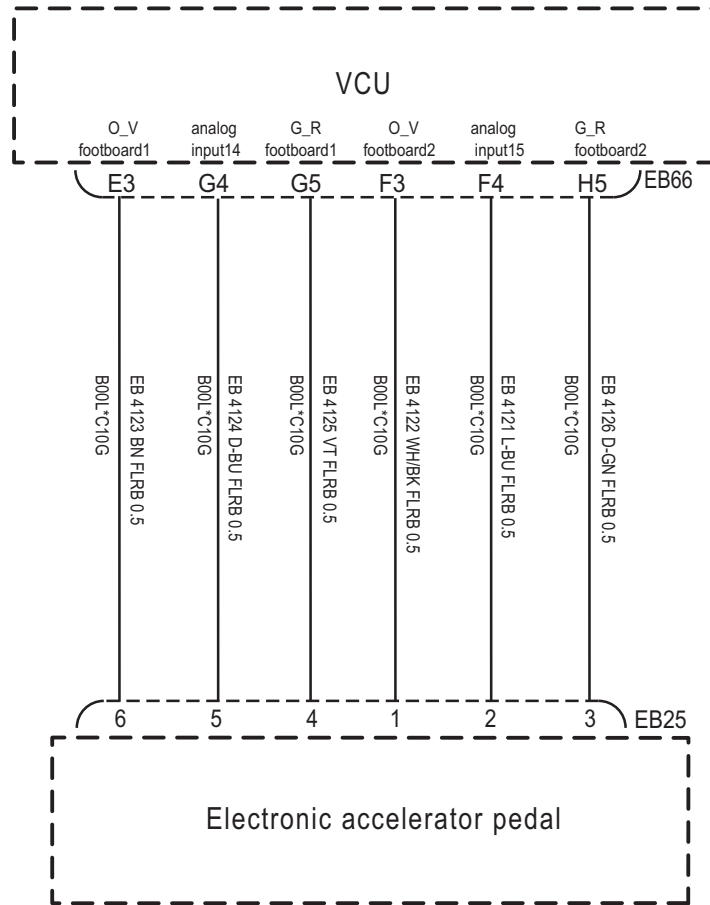

EB66

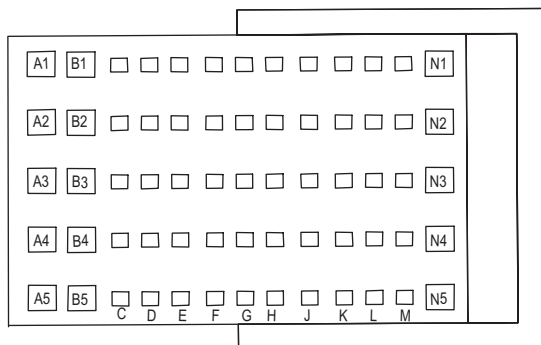

BT32

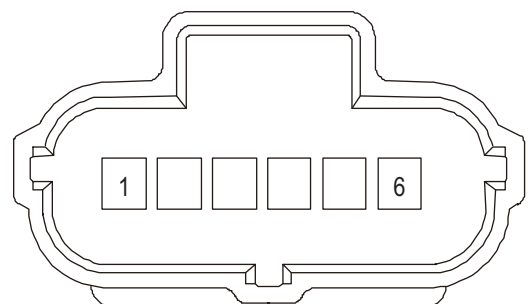

EK891224

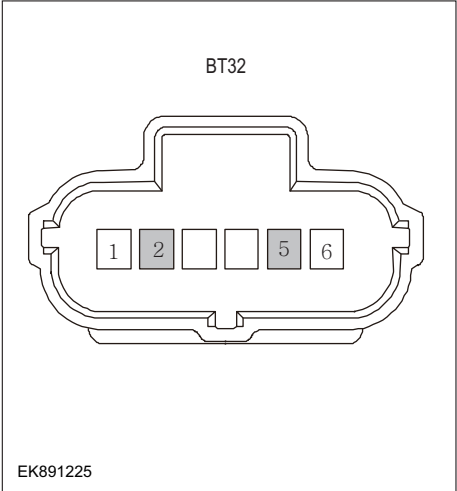
Troubleshooting steps	
Step 1	General inspection.
	<ol style="list-style-type: none"> 1 Check the fuse for damage. 2 Check battery capacity. 3 Check the harness plug of accelerator pedal, VCU for damage, poor contact, aging and looseness. 4 Check whether the result is normal or not?
	NO → Repair or replace the faulted parts.
YES ↓	
Step 2	Check fault codes.
	<ol style="list-style-type: none"> 1 Connect the fault diagnosis instrument to the diagnosis interface. 2 Turn the ignition switch to ON position. 3 Diagnose the VCU with diagnostic apparatus. 4 If there is any fault code except for P2123-00、P2122-00、P2128-00、P2127-00、P2135-00、P2136-00、P2138-00?
	YES → Refer to: DTC Summary list(VCU) .
NO ↓	
Step 3	Check the supply power of brake vacuum sensor when it is started or operating.
	<ol style="list-style-type: none"> 1 Turn the ignition switch to OFF. 2 Disconnect the harness plug EB25 of brake vacuum sensor. 3 Turn the ignition switch to ON. 4 Measure the voltage between the plug terminal of brake vacuum sensor and ground. Measuring circuit: voltage between terminal 2 on plug EB25 and ground. Measuring circuit: voltage between terminal 5 on plug EB25 and ground. Standard value:4.7~5.2V 5 Check whether the result is normal or not?
	NO → Repair the circuit.
YES ↓	

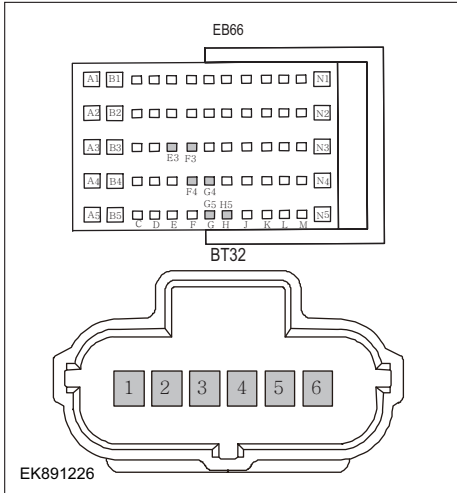
Step 4	Check the accelerator pedal circuit (open circuit).
 <p>The diagram shows two electrical connectors. The top one is a multi-pin connector labeled EB66, with terminals arranged in two rows: A1-N5 and C-T. The bottom one is a 6-pin connector labeled BT32, with terminals numbered 1 through 6. The diagram is identified by the code EK891226.</p>	<ol style="list-style-type: none"> 1 Turn the ignition switch to OFF. 2 Disconnect the harness plug EB66 of VCU . 3 Measure the resistance between the harness terminal of accelerator pedal and the VCU. <ul style="list-style-type: none"> Measuring circuit: resistance between terminal 1 on plug EB25 and terminal F3 on plug EB66. Measuring circuit: resistance between terminal 2 on plug EB25 and terminal F4 on plug EB66. Measuring circuit: resistance between terminal 3 on plug EB25 and terminal H5 on plug EB66. Measuring circuit: resistance between terminal 4 on plug EB25 and terminal G5 on plug EB66. Measuring circuit: resistance between terminal 5 on plug EB25 and terminal G4 on plug EB66. Measuring circuit: resistance between terminal 6 on plug EB25 and terminal E3 on plug EB66. <p>Standard value: $\approx 0\Omega$</p> 4 Check whether the result is normal or not?
	<p>NO → Repair or replace the faulted parts.</p>
<p>YES ↓</p>	

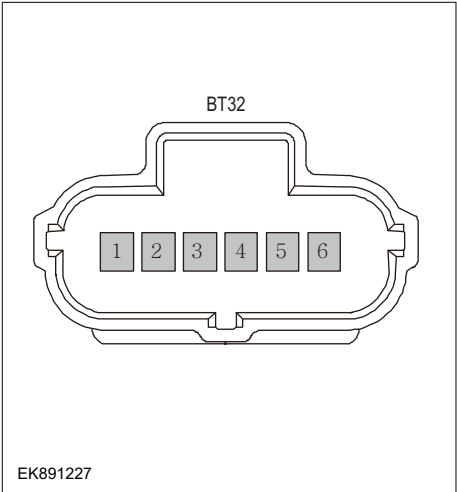
Step 5	Check the circuit of accelerator pedal (short circuit).
<div style="text-align: center;">  <p>BT32</p> <p>EK891227</p> </div>	<ol style="list-style-type: none"> 1 Turn the ignition switch to OFF. 2 Measure the resistance between the harness terminal of accelerator pedal and ground. <ul style="list-style-type: none"> Measuring circuit: resistance between terminal 1 on plug EB25 and ground. Measuring circuit: resistance between terminal 2 on plug EB25 and ground. Measuring circuit: resistance between terminal 3 on plug EB25 and ground. Measuring circuit: resistance between terminal 4 on plug EB25 and ground. Measuring circuit: resistance between terminal 5 on plug EB25 and ground. Measuring circuit: resistance between terminal 6 on plug EB25 and ground. <p>Standard value: ∞</p> 3 Measure the voltage between the harness terminal of accelerator pedal and ground. <ul style="list-style-type: none"> Measuring circuit: voltage between terminal 1 on plug EB25 and ground. Measuring circuit: voltage between terminal 2 on plug EB25 and ground. Measuring circuit: voltage between terminal 3 on plug EB25 and ground. Measuring circuit: voltage between terminal 4 on plug EB25 and ground. Measuring circuit: voltage between terminal 5 on plug EB25 and ground. Measuring circuit: voltage between terminal 6 on plug EB25 and ground. <p>Standard value: ≈ 0V</p> 4 Check whether the result is normal or not?
	<p>NO → Repair or replace the faulted parts.</p>
<p>YES ↓</p>	

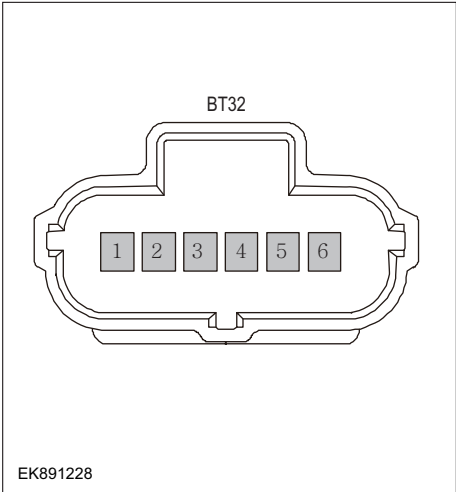
Step 6	Check the accelerator pedal (components).
 <p data-bbox="256 719 336 736">EK891228</p>	<p data-bbox="823 248 1492 309">1 Measure the resistance of the terminal of accelerator pedal directly.</p> <p data-bbox="868 331 1492 392">Measuring circuit: resistance between terminal 4 and terminal 3 on plug EB25.</p> <p data-bbox="868 414 1492 474">Measuring circuit: resistance between terminal 1 and terminal 6 on plug EB25.</p> <p data-bbox="868 497 1050 521">Standard value:</p> <p data-bbox="823 548 1492 609">2 Measure the resistance between the accelerator pedal terminal and the housing.</p> <p data-bbox="868 631 1492 692">Measuring circuit: resistance between terminal 1 on plug EB25 and the housing.</p> <p data-bbox="868 714 1492 775">Measuring circuit: resistance between terminal 2 on plug EB25 and the housing.</p> <p data-bbox="868 797 1492 857">Measuring circuit: resistance between terminal 3 on plug EB25 and the housing.</p> <p data-bbox="868 880 1492 940">Measuring circuit: resistance between terminal 4 on plug EB25 and the housing.</p> <p data-bbox="868 963 1492 1023">Measuring circuit: resistance between terminal 5 on plug EB25 and the housing.</p> <p data-bbox="868 1046 1492 1106">Measuring circuit: resistance between terminal 6 on plug EB25 and the housing.</p> <p data-bbox="868 1128 1082 1153">Standard value: ∞</p> <p data-bbox="823 1180 1326 1205">3 Check whether the result is normal or not?</p>
	<p data-bbox="823 1234 1254 1258">NO → Replace accelerator pedal.</p>
<p data-bbox="153 1285 229 1310">YES ↓</p>	

VCU

Step 7	Test whether VCU is norm.
	<ol style="list-style-type: none">1 Turn the ignition switch to OFF.2 Disconnect and check the harness plug EB64, EB66 of VCU.3 Check and repair.<ul style="list-style-type: none">• Corrosion(install new adapting piece or terminal-cleaning and pin).• Pin damaged or bent-install new terminal/pin.• Fly out of pins-install new pins as needed.4 Reconnect the VCU plug and all other previously disconnected plug. Make sure the pin is properly positioned and fixed.5 Run the system and determine if the problem persists?
	YES → Change the VCU
NO ↓	
At this point the system is functioning normally. The problem may be caused by connections. Address the root cause of any connector or pin problems.	
Next Step ↓	
Diagnosis end.	

P1C00-00、 P1C01-00、 P1C03-00

Fault diagnosis code
P1C00-00: Motor controller inlet temperature sensor STB
P1C01-00: Motor controller inlet temperature sensor STG
P1C03-00: Motor controller inlet temperature sensor input rationality diagnosis
Detection tools
1 Multimeter and diagnostic apparatus
Possible causes
<ul style="list-style-type: none"> • Circuit,terminal and adapting piece fault • VCU • The inlet temperature sensor of the motor controller is faulty
Conditions for fault code operation
Turn the ignition switch to ON position.
Conditions for fault code setting
P1C00-00
The voltage of the temperature sensor at the water inlet of the charger is greater than or equal to 4.9V
P1C01-00
The voltage of the temperature sensor at the water inlet of the charger is lower than or equal to 4.9V
P1C03-00
The diagnosis has been disabled
To set the effect of a fault code condition
Description of circuit diagram
The VCU monitors the the temperature sensor at the water inlet via low level reference circuit and signal circuit.

Circuit diagram

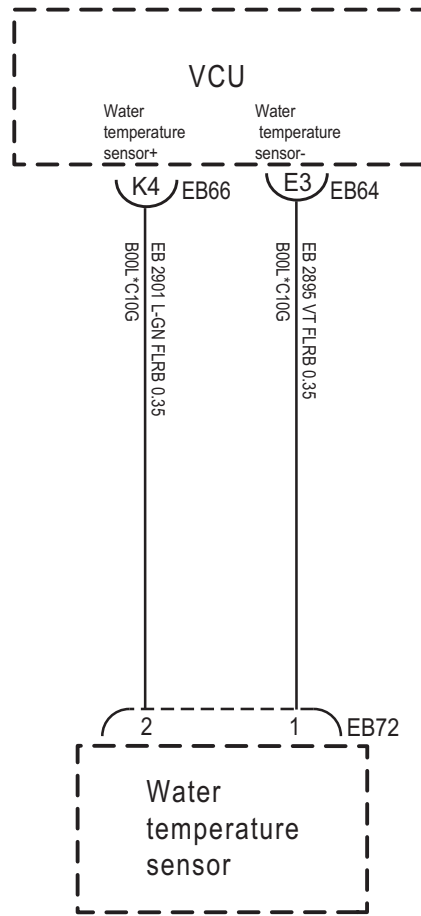

EB66

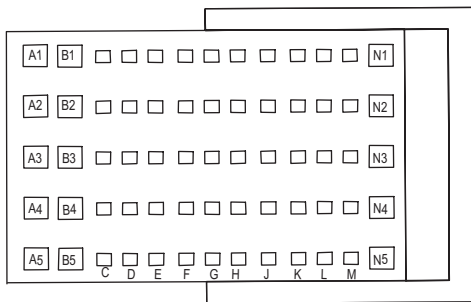

EB72

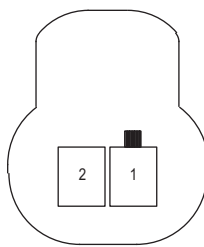

EB64

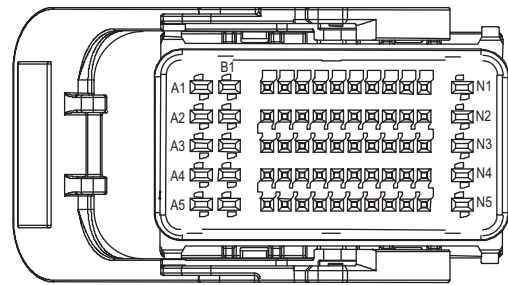

EK891229

Troubleshooting steps	
Step 1	General inspection.
	<ol style="list-style-type: none"> 1 Check the fuse for damage. 2 Check battery capacity. 3 Check the harness plug of the temperature sensor at the water inlet of the motor controller, VCU for damage, poor contact, aging and looseness. 4 Check whether the result is normal or not?
	NO → Repair or replace the faulted parts.
YES ↓	
Step 2	Check fault codes.
	<ol style="list-style-type: none"> 1 Connect the fault diagnosis instrument to the diagnosis interface. 2 Turn the ignition switch to ON position. 3 Diagnose the VCU with diagnostic apparatus. 4 Is there any other fault code except for P1C00-00、P1C01-00、 P1C03-00?
	YES → Refer to: DTC Summary list(VCU) .
NO ↓	

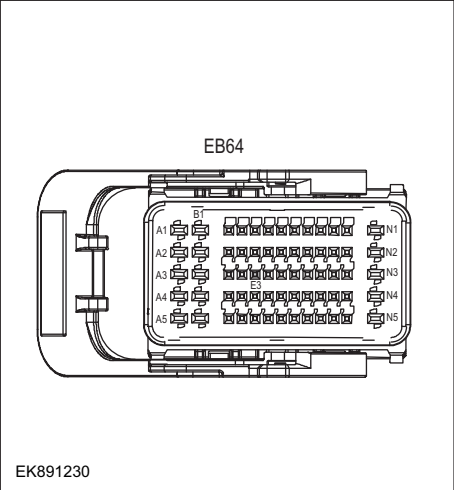
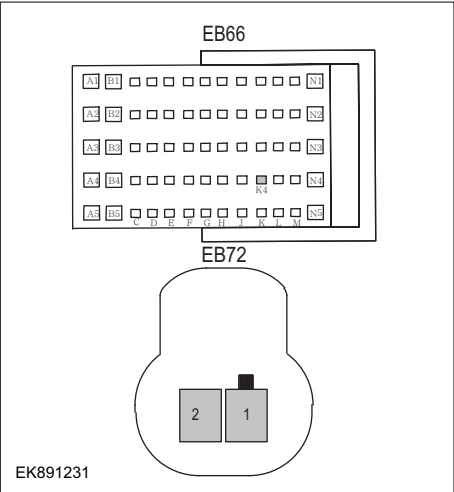
<p>Step 3</p>	<p>Check the circuit of temperature sensor at the water inlet of the motor controller(open circuit).</p>
<div style="text-align: center;">  <p>EK891230</p> </div> <div style="text-align: center; margin-top: 20px;">  <p>EK891231</p> </div>	<ol style="list-style-type: none"> 1 Turn the ignition switch to OFF. 2 Disconnect the harness plug BT1004 of temperature sensor at the water inlet of the motor controller. 3 Disconnect the harness plug EB64, EB66 of VCU . 4 Measure the resistance between the harness terminal of temperature sensor at the water inlet of the motor controller and the VCU. Measuring circuit: resistance between terminal 1 on plug BT72 and terminal E3 on plug EB66. Measuring circuit: resistance between terminal 2 on plug BT72 and terminal K4 on plug EB64. Standard value: $\approx 0\Omega$ 5 Check whether the result is normal or not?
<p>NO → Repair or replace the faulted parts</p>	
<p>YES ↓</p>	

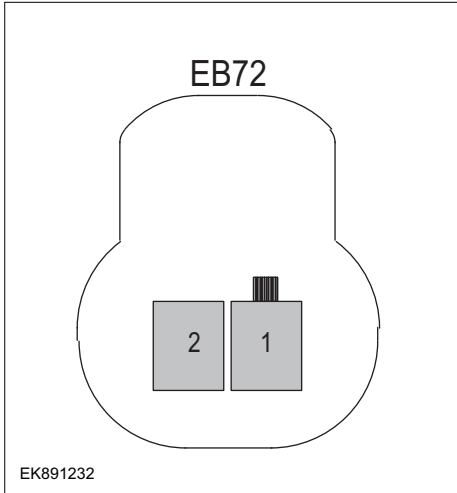
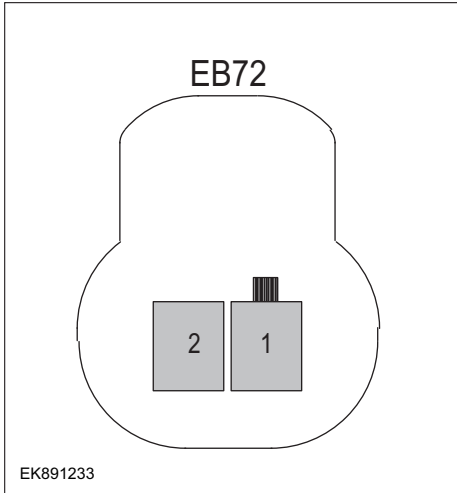
Step 4	Check the circuit of temperature sensor at the water inlet of the motor controller(short circuit).
	<ol style="list-style-type: none"> 1 Turn the ignition switch to OFF. 2 Measure the resistance between the harness plug of temperature sensor at the water inlet of the motor controller and ground. Measuring circuit: resistance between terminal 1 on plug BT72 and ground. Measuring circuit: resistance between terminal 2 on plug BT72 and ground. Standard value: ∞ 3 Measure the voltage between the harness plug of temperature sensor at the water inlet of the motor controller and ground. Measuring circuit: voltage between terminal 1 on plug BT72 and ground. Measuring circuit: voltage between terminal 2 on plug BT72 and ground. Standard value: $\approx 0V$ 4 Check whether the result is normal or not??
NO → Repair or replace the faulted parts.	
YES ↓	
Step 5	Check the circuit of temperature sensor at the water inlet of the motor controller(components).
	<ol style="list-style-type: none"> 1 Measure the resistance of terminals on temperature sensor at the water inlet of the motor controller directly. Measuring circuit: resistance between terminal 1 and terminal 2 on plug BT72. Standard value: 2 Measure the resistance between the harness plug of temperature sensor at the water inlet of the motor controller and the housing. Measuring circuit: resistance between terminal 1 on plug BT72 and the housing. Measuring circuit: resistance between terminal 2 on plug BT72 and the housing. Standard value: ∞ 3 Check whether the result is normal or not?
NO → Replace temperature sensor at the water inlet of the motor controller.	
YES ↓	

VCU

Step 6	Test whether VCU is norm.
	<ol style="list-style-type: none">1 Turn the ignition switch to OFF.2 Disconnect and check the harness plug EB64, EB66 of VCU.3 Check and repair.<ul style="list-style-type: none">• Corrosion(install new adapting piece or terminal-cleaning and pin).• Pin damaged or bent-install new terminal/pin.• Fly out of pins-install new pins as needed.4 Reconnect the VCU plug and all other previously disconnected plug. Make sure the pin is properly positioned and fixed.5 Run the system and determine if the problem persists?
	YES → Change the VCU
NO ↓	
At this point the system is functioning normally. The problem may be caused by connections. Address the root cause of any connector or pin problems.	
Next Step ↓	
Diagnosis end.	

P0692-00、 P0691-00、 P0480-00

Fault diagnosis code
P0692-00: Fan relay 1 control terminal STB
P0691-00: Fan relay 1 control terminal STG
P0480-00: Fan relay 1 control terminal OPEN
Detection tools
1 Multimeter and diagnostic apparatus
Possible causes
<ul style="list-style-type: none"> • Circuit,terminal and adapting piece fault • VCU • Cooling fan relay fault
Conditions for fault code operation
Turn the ignition switch to ON position.
Conditions for fault code setting
P0692-00
The underlying diagnosis
P0691-00
The underlying diagnosis
P0480-00
The underlying diagnosis
To set the effect of a fault code condition
Description of circuit diagram

Circuit diagram

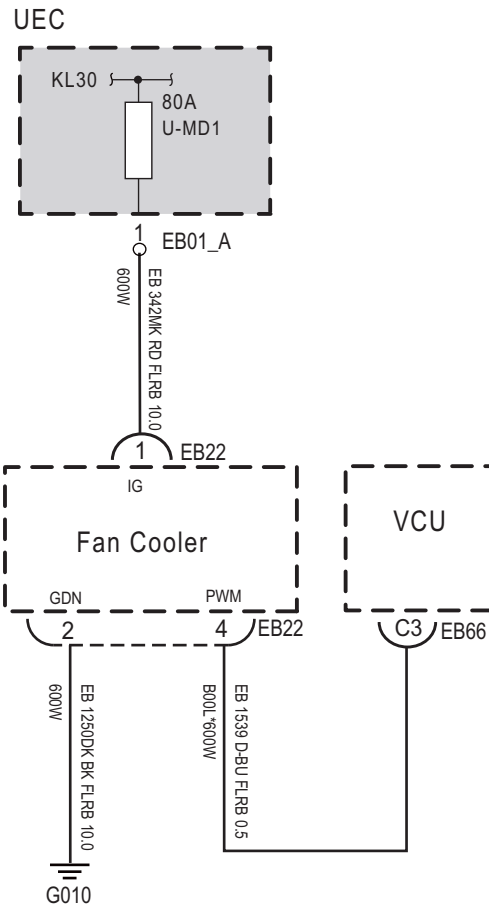

EB66

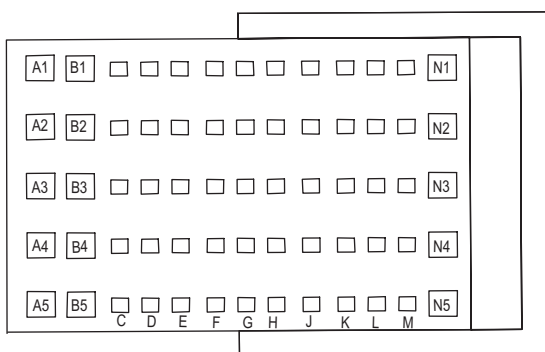

EB22

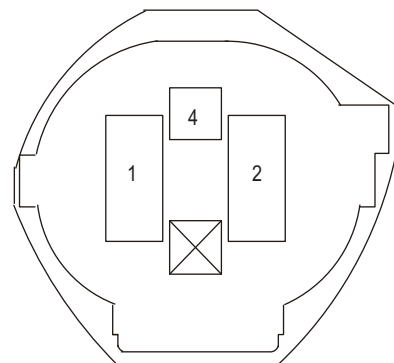

EK891234

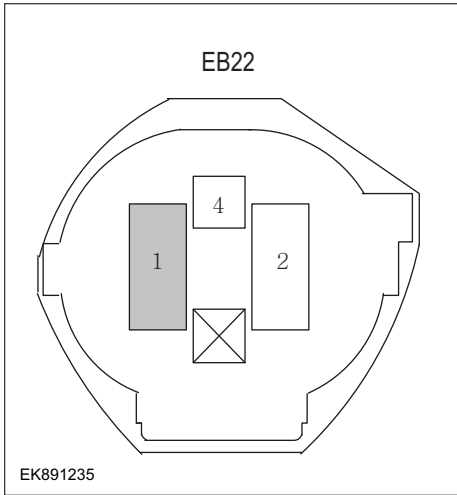
Troubleshooting steps	
Step 1	General inspection.
	<ol style="list-style-type: none"> 1 Check fusesU-MD1 for damage. 2 Check battery capacity. 3 Check the harness plug of cooling fan , VCU for damage, poor contact, aging and looseness. 4 Check whether the result is normal or not?
	NO → Repair or replace the faulted parts.
YES ↓	
Step 2	Check fault codes.
	<ol style="list-style-type: none"> 1 Connect the fault diagnosis instrument to the diagnosis interface. 2 Turn the ignition switch to ON position. 3 Diagnose the VCU with diagnostic apparatus. 4 If there is any fault code except for P0692-00、P0691-00、P0480-00?
	YES → Refer to: DTC Summary list(VCU) .
NO ↓	
Step 3	Check the power voltage of cooling fan battery.
	<ol style="list-style-type: none"> 1 Turn the ignition switch to OFF. 2 Disconnect the harness plug EB22 of cooling fan. 3 Turn the ignition switch to ON. 4 Measure the voltage between the harness terminal of cooling fan and ground. Measuring circuit: voltage between terminal 1 on plug EB22 and ground. Standard value: 0V 5 Check whether the result is normal or not?
	NO → Repair or replace the faulted parts.
YES ↓	

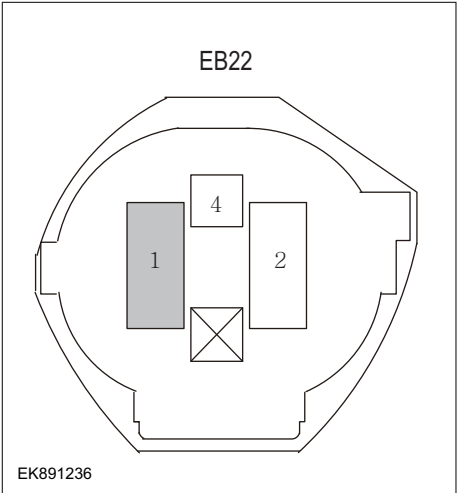
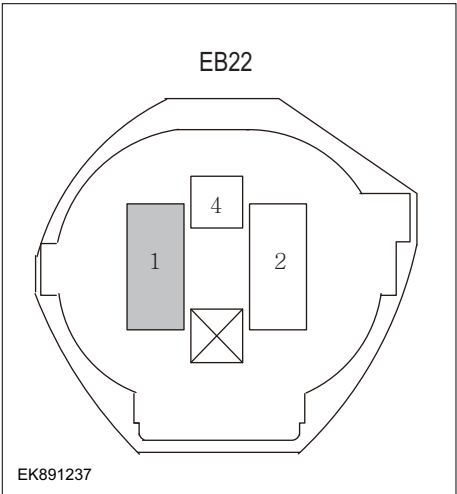
Step 4	Check the power voltage when the cooling fan is started or operating
 <p>EB22</p> <p>EK891236</p>	<ol style="list-style-type: none"> 1 Turn the ignition switch to ON. 2 Step down the brake pedal and make the cooling fan relay in working state. 3 Measure the voltage between the harness terminal of cooling fan and ground. <p>Measuring circuit: voltage between terminal 1 on plug EB22 and ground.</p> <p>Standard value:10~14V</p> <ol style="list-style-type: none"> 4 Check whether the result is normal or not?
NO → Repair or replace the faulted parts.	
YES ↓	
Step 5	Check the circuit between cooling fan relay and cooling fan (open circuit).
 <p>EB22</p> <p>EK891237</p>	<ol style="list-style-type: none"> 1 Turn the ignition switch to OFF. 2 Disconnect the UEC harness plug EB01_A. 3 Measure the resistance between the UEC harness terminals and the cooling fan harness terminals. <p>Measuring circuit: Resistance between EB01_A plug 1 terminal and EB22 plug 1 terminal.</p> <p>Standard value: ≈ 0Ω</p> <ol style="list-style-type: none"> 4 Check whether the result is normal or not?
NO → Repair or replace the faulted parts.	
YES ↓	

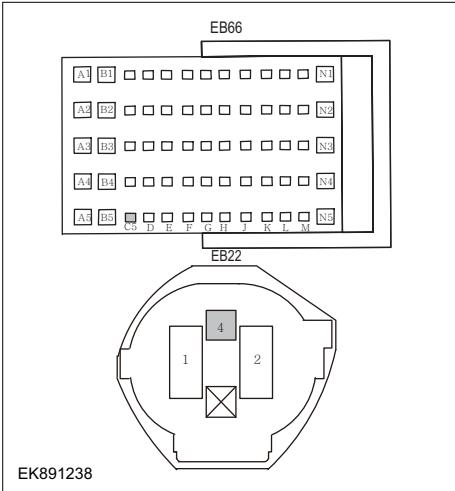
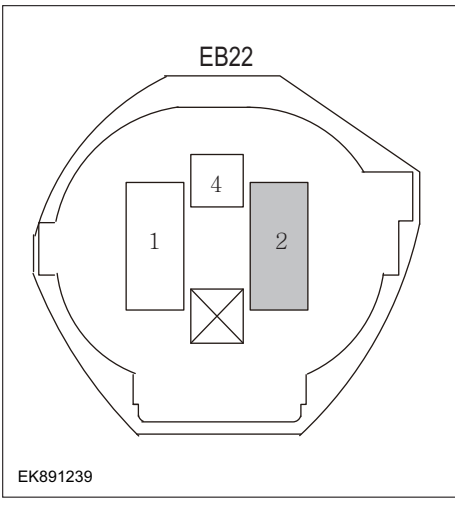
Step 6	Check the circuit between the cooling fan and the VCU (open circuit).
	<ol style="list-style-type: none"> 1 Turn the ignition switch to OFF. 2 Disconnect the cooling fan harness plug EB22. 断开 VCU 模块线束插头 EB66。 3 Measure the resistance between the cooling fan harness terminals and the VCU harness terminals. Measuring circuit: resistance between EB22 plug 4 terminal and EB66 plug C5 terminal. Standard value: $\approx 0\Omega$ 4 Check whether the result is normal or not?
NO → Repair or replace the faulted parts.	
YES ↓	
Step 7	Check the cooling fan grounding circuit.
	<ol style="list-style-type: none"> 1 Turn the ignition switch to OFF. 2 Measure the resistance between the cooling fan harness plug and ground. Measuring circuit: resistance between EB22 plug terminal 2 and ground. Standard value: $\approx 0\Omega$ 3 Check whether the result is normal or not?
NO → Repair or replace the faulted parts.	
YES ↓	

VCU

Step 8	Check the relay of cooling fan. (components)
	<ol style="list-style-type: none"> 1 Turn the ignition switch to OFF. 2 Replace the relay of cooling fan in good condition. 3 Connect the fault diagnosis instrument to the diagnosis interface. 4 Turn the ignition switch to ON position. 5 Clear fault codes. 6 Reread fault codes. 7 Test whether the faulted code is existed.
	NO → Replace the relay of cooling fan.
YES ↓	
Step 9	Test whether VCU is norm.
	<ol style="list-style-type: none"> 1 Turn the ignition switch to OFF. 2 Disconnect and check the harness plug EB64, EB66 of VCU. 3 Check and repair. <ul style="list-style-type: none"> • Corrosion(install new adapting piece or terminal-cleaning and pin). • Pin damaged or bent-install new terminal/pin. • Fly out of pins-install new pins as needed. 4 Reconnect the VCU plug and all other previously disconnected plug. Make sure the pin is properly positioned and fixed. 5 Run the system and determine if the problem persists?
	YES → Change the VCU
NO ↓	
At this point the system is functioning normally. The problem may be caused by connections. Address the root cause of any connector or pin problems	
Next Step ↓	
Diagnosis end.	

P0A07-00、 P0A06-00、 P0A05-00

Fault diagnosis code
P0A07-00: Motor controller, cooling system, water pump output STB
P0A06-00: Motor controller, cooling system, water pump output STG
P0A05-00: Motor controller, cooling system, water pump, output OPEN
Detection tools
1 Multimeter and diagnostic apparatus
Possible causes
<ul style="list-style-type: none"> • Circuit,terminal and adapting piece fault • VCU • The motor controller cooling water pump is faulty.
Conditions for fault code operation
Turn the ignition switch to ON position.
Conditions for fault code setting
P0A07-00
The underlying diagnosis
P0A06-00
The underlying diagnosis
P0A05-00
The underlying diagnosis
To set the effect of a fault code condition
Description of circuit diagram
The VCU monitors motor controller cooling water pump via low level reference circuit and signal circuit.

Circuit diagram

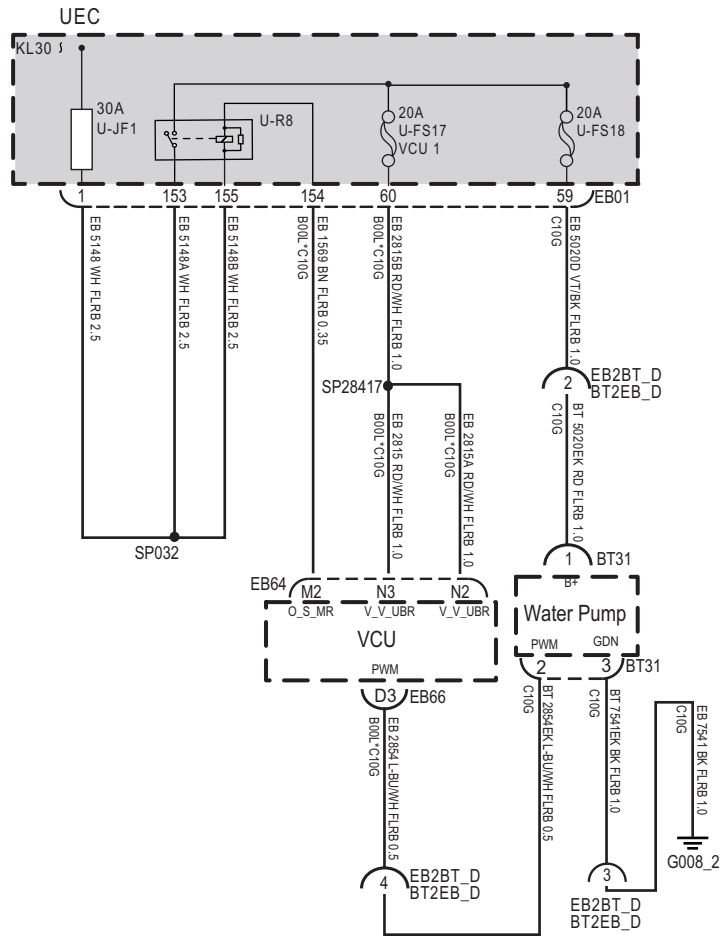

EB66

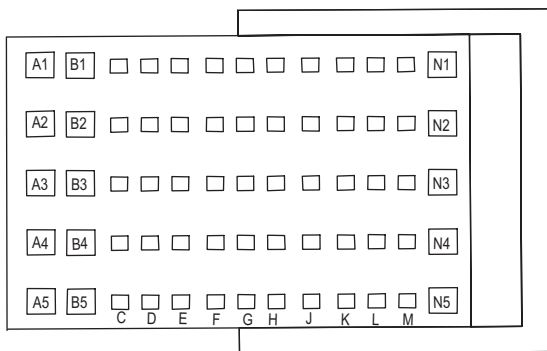

BT31

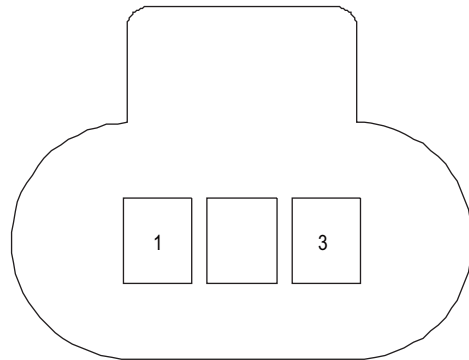

EK891240

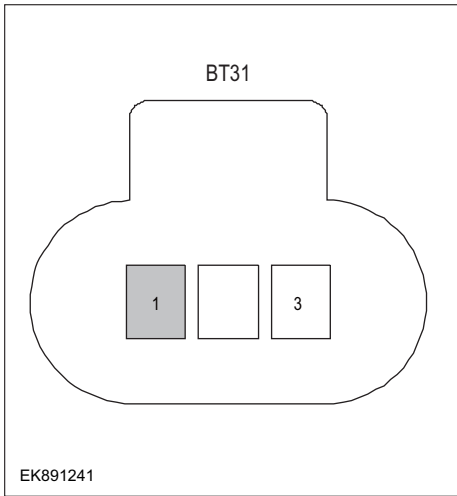
Troubleshooting steps	
Step 1	General inspection.
	<ol style="list-style-type: none"> 1 Check the fuse U-FS18 or damage. 2 Check battery capacity. 3 Check the harness plug of motor controller cooling water pump, VCU for damage, poor contact, aging and looseness. 4 Check whether the result is normal or not?
	NO → Repair or replace the faulted parts.
YES ↓	
Step 2	Check fault codes.
	<ol style="list-style-type: none"> 1 Connect the fault diagnosis instrument to the diagnosis interface. 2 Turn the ignition switch to ON position. 3 Diagnose the VCU with diagnostic apparatus. 4 Is there any other fault code except for P0A07-00, P0A06-00, P0A05-00?
	YES → Refer to: DTC Summary list(VCU) .
NO ↓	
Step 3	Check the supply power of motor controller cooling water pump when it is started or operating.
	<ol style="list-style-type: none"> 1 Turn the ignition switch to OFF. 2 Disconnect the motor controller cooling water pump harness plug BT31. 3 Turn the ignition switch to ON. 4 Measure the voltage between the motor controller, cooling water pump, harness terminals, and ground. Measuring circuit: the voltage between BT31 plug terminal 1 and ground. Standard value: 10~14V 5 Check whether the result is normal or not?
	NO → Repair the circuit
YES ↓	

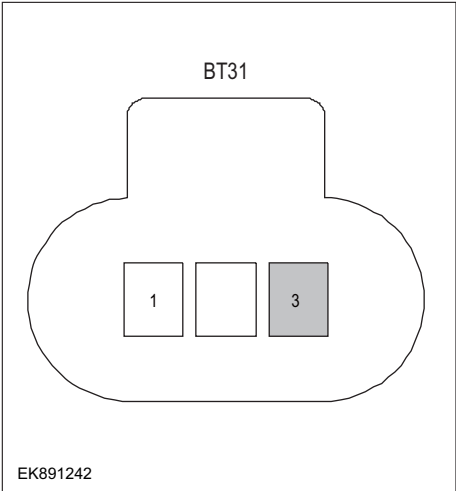
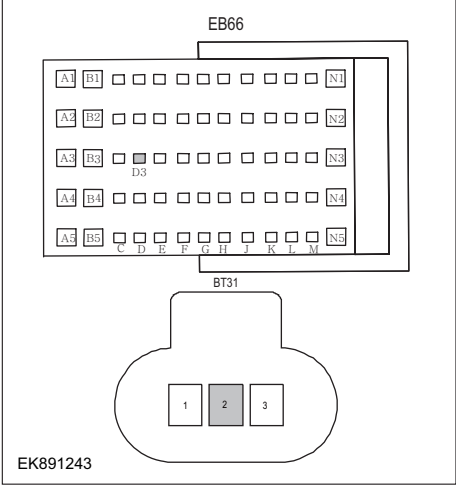
Step 4	Check the circuit of temperature sensor at the water inlet of the motor controller(open circuit).
 <p>BT31</p> <p>EK891242</p>	<ol style="list-style-type: none"> 1 Turn the ignition switch to OFF. 2 Measure the resistance between the motor controller, cooling water pump, harness terminals, and ground. Measuring circuit: resistance between EB31 plug terminal 3 and ground. Standard value: $\approx 0\Omega$ 3 Check whether the result is normal or not?
NO → Repair or replace the faulted parts.	
YES ↓	
Step 5	Check the circuit of temperature sensor at the water inlet of the motor controller (open circuit).
 <p>EB66</p> <p>BT31</p> <p>EK891243</p>	<ol style="list-style-type: none"> 1 Turn the ignition switch to OFF. 2 Disconnect the motor controller cooling water pump harness plug EB31. 3 Disconnect the VCU harness plug EB66. 4 Measure the resistance between the motor controller cooling water pump harness terminals and the VCU harness terminals. Measuring circuit: resistance between EB31 plug 2 terminal and EB66 plug D3 terminal. Standard value: $\approx 0\Omega$ 5 Check whether the result is normal or not?
NO → Repair or replace the faulted parts.	
YES ↓	

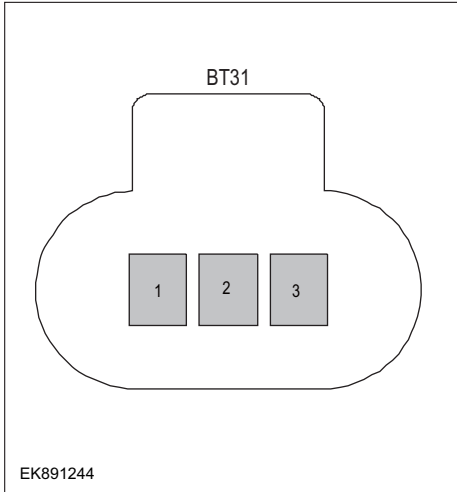
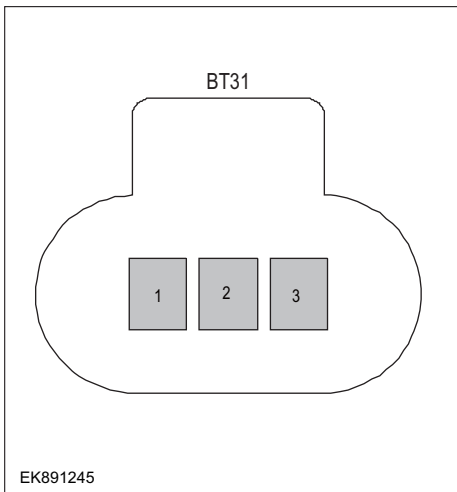
Step 6	Check the circuit of temperature sensor at the water inlet of the motor controller(short circuit).
	<ol style="list-style-type: none"> 1 Turn the ignition switch to OFF. 2 Measure the resistance between the motor controller cooling water pump harness plug and ground. Measuring circuit: resistance between EB31 plug terminal 1 and ground. Measuring circuit: resistance between EB31 plug terminal 2 and ground. Standard value: ∞ 3 Measure the voltage between the motor controller, cooling water pump, harness plug and ground. Measuring circuit: the voltage between EB31 plug 2 terminal and ground. Measuring circuit: the voltage between EB31 plug 3 terminal and ground. Standard value: $\approx 0V$ 4 Check whether the result is normal or not?
NO → Repair or replace the faulted parts.	
YES ↓	
Step 7	Check the circuit of motor controller cooling water pump(short circuit).
	<ol style="list-style-type: none"> 1 Measure the voltage between the plug terminal of motor controller cooling water pump and ground. Measuring circuit: resistance between terminals 2 and 3 of EB31 plugs. Standard value: 2 Measure the resistance between the motor controller cooling water pump terminal and the housing. Measuring circuit: resistance between terminal 1 on plug BT31 and the housing. Measuring circuit: resistance between terminal 2 on plug BT31 and the housing. Measuring circuit: resistance between terminal 3 on plug BT31 and the housing. Standard value: ∞ 3 Check whether the result is normal or not?
NO → Replace the motor controller cooling water pump.	
YES ↓	

VCU

Step 8	Test whether VCU is norm.
	<ol style="list-style-type: none">1 Turn the ignition switch to OFF.2 Disconnect and check the harness plug EB64, EB66 of VCU.3 Check and repair.<ul style="list-style-type: none">• Corrosion(install new adapting piece or terminal-cleaning and pin).• Pin damaged or bent-install new terminal/pin.• Fly out of pins-install new pins as needed.4 Reconnect the VCU plug and all other previously disconnected plug. Make sure the pin is properly positioned and fixed.5 Run the system and determine if the problem persists?
	YES → Change the VCU
NO ↓	
At this point the system is functioning normally. The problem may be caused by connections. Address the root cause of any connector or pin problems	
Next Step ↓	
Diagnosis end.	

P1C10-00、 P1C11-00、 P1C12-00、 P1C13-00

Fault diagnosis code
P1C10-00: Motor controller: cooling system, water pump, no water dry running
P1C11-00: Motor controller, cooling system, water pump stall
P1C12-00: Motor controller, cooling system, water pump overtemperature
P1C13-00: The speed of the motor controller cooling system water pump is too low
Detection tools
1 Multimeter and diagnostic apparatus
Possible causes
<ul style="list-style-type: none"> • Circuit,terminal and adapting piece fault • VCU • The motor controller cooling water pump is faulty.
Conditions for fault code operation
Turn the ignition switch to ON position.
Conditions for fault code setting
P1C10-00
The pump period is equal to 2s
P1C11-00
The pump period is equal to 2.5s
P1C12-00
The pump period is equal to 3s
P1C13-00
The pump period is equal to 3.5s
To set the effect of a fault code condition
Description of circuit diagram
The VCU monitors motor controller cooling water pump via low level reference circuit and signal circuit.

Circuit diagram

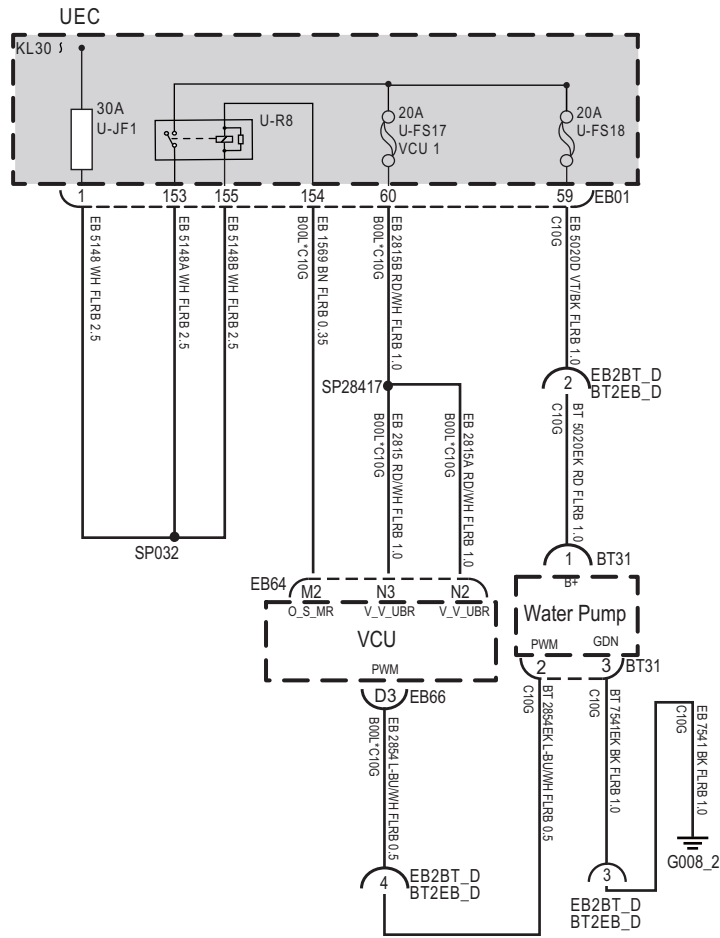

EB66

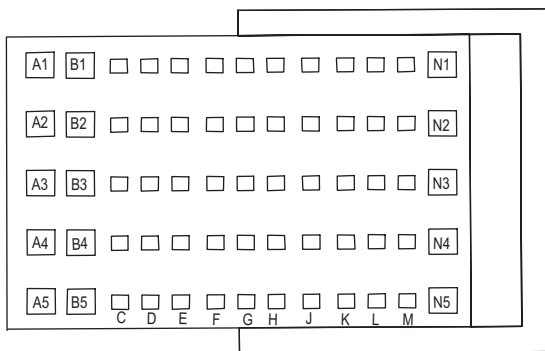

BT31

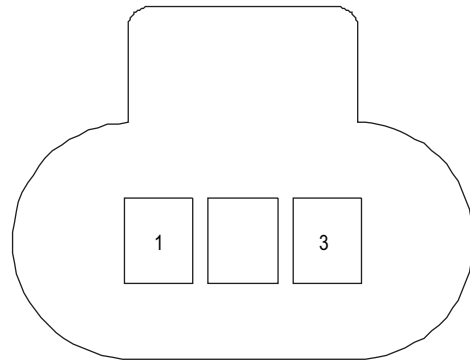

EK891240

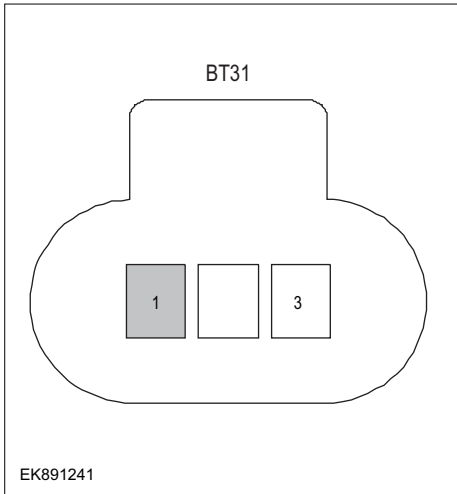
Troubleshooting steps	
Step 1	General inspection.
	<ol style="list-style-type: none"> 1 Check the fuse U-JF2、 U-FS17、 U-FS18or damage. 2 Check battery capacity. 3 Check the harness plug of motor controller cooling water pump, VCU for damage, poor contact, aging and looseness. 4 Check whether the result is normal or not?
	NO → Repair or replace the faulted parts.
YES ↓	
Step 2	Check fault codes.
	<ol style="list-style-type: none"> 1 Connect the fault diagnosis instrument to the diagnosis interface. 2 Turn the ignition switch to ON position. 3 Diagnose the VCU with diagnostic apparatus. 4 Is there any other fault code except for P1C10-00、 P1C11-00、 P1C12-00、 P1C13-00?
	YES → Refer to: DTC Summary list(VCU) .
NO ↓	
Step 3	Check cooling system.
	<ol style="list-style-type: none"> 1 Check whether there is leakage or poor heat dissipation in the cooling system. 2 Check whether the result is normal or not?
	NO → Repair the cooling system.
Step 4	Check the supply power of motor controller cooling water pump when it is started or operating.
	<ol style="list-style-type: none"> 1 Turn the ignition switch to OFF. 2 Disconnect the harness plug BT31 of motor controller cooling water pump. 3 Turn the ignition switch to ON. 4 Measure the voltage between the motor controller, cooling water pump, harness terminals, and ground. Measuring circuit: the voltage between EB31 plug terminal 1 and ground. Standard value:10~14V 5 Check whether the result is normal or not?
	NO → Repair the circuit
YES ↓	

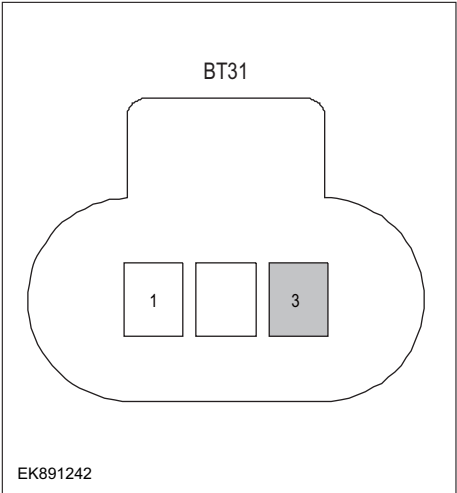
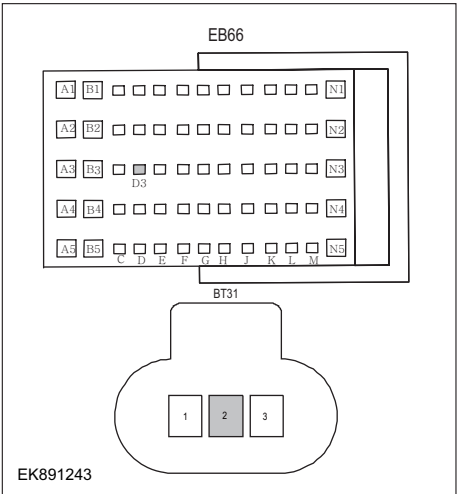
Step 5	Check the circuit of temperature sensor at the water inlet of the motor controller(open circuit).
 <p>BT31</p> <p>EK891242</p>	<ol style="list-style-type: none"> 1 Turn the ignition switch to OFF. 2 Measure the voltage between the plug terminal of motor controller cooling water pump and ground. Measuring circuit: resistance between EB31 plug terminal 3 and ground. Standard value: $\approx 0\Omega$ 3 Check whether the result is normal or not?
NO → Repair or replace the faulted parts.	
YES ↓	
Step 6	Check the circuit of temperature sensor at the water inlet of the motor controller (open circuit).
 <p>EB66</p> <p>BT31</p> <p>EK891243</p>	<ol style="list-style-type: none"> 1 Turn the ignition switch to OFF. 2 Disconnect the motor controller cooling water pump harness plug EB31. 3 Disconnect the VCU harness plug EB66. 4 Measure the resistance between the motor controller cooling water pump harness terminals and the VCU harness terminals. Measuring circuit: resistance between EB31 plug 2 terminal and EB66 plug D3 terminal. Standard value: $\approx 0\Omega$ 5 Check whether the result is normal or not?
NO → Repair or replace the faulted parts.	
YES ↓	

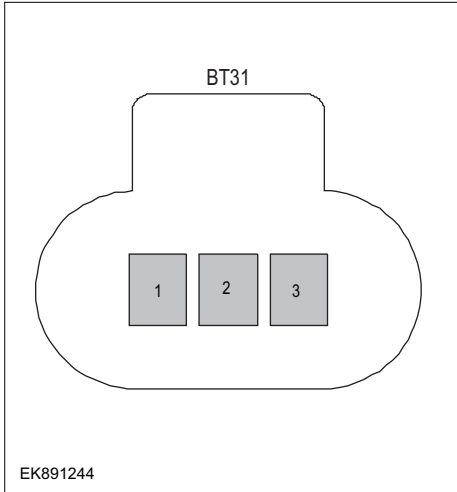
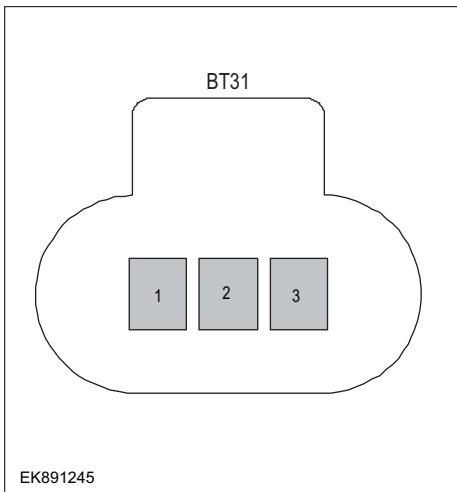
Step 7	Check the circuit of temperature sensor at the water inlet of the motor controller(short circuit).
	<ol style="list-style-type: none"> 1 Turn the ignition switch to OFF. 2 Measure the resistance between the motor controller cooling water pump harness plug and ground. Measuring circuit: resistance between EB31 plug terminal 1 and ground. Measuring circuit: resistance between EB31 plug 2 terminal and ground. Standard value: ∞ 3 Measure the voltage between the plug terminal of motor controller cooling water pump and ground. Measuring circuit: the voltage between EB31 plug 2 terminal and ground. Measuring circuit: the voltage between EB31 plug terminal 3 and ground. Standard value: $\approx 0V$ 4 Check whether the result is normal or not?
NO → Repair or replace the faulted parts.	
YES ↓	
Step 8	Check the circuit of motor controller cooling water pump(short circuit).
	<ol style="list-style-type: none"> 1 Measure the voltage between the plug terminal of motor controller cooling water pump and ground. Measuring circuit: resistance between terminal 2 and terminal 3 on plug BT31. Standard value: 2 Measure the voltage between the plug terminal of motor controller cooling water pump and the housing. Measuring circuit: resistance between terminal 1 on plug BT31 and the housing. Measuring circuit: resistance between terminal 2 on plug BT31 and the housing. Measuring circuit: resistance between terminal 3 on plug BT31 and the housing. Standard value: ∞ 3 Check whether the result is normal or not?
NO → Replace the motor controller cooling water pump	
YES ↓	

VCU

Step 9	Test whether VCU is norm.
	<ol style="list-style-type: none"> 1 Turn the ignition switch to OFF. 2 Disconnect and check the harness plug EB64, EB66 of VCU. 3 Check and repair. <ul style="list-style-type: none"> • Corrosion(install new adapting piece or terminal-cleaning and pin). • Pin damaged or bent-install new terminal/pin. • Fly out of pins-install new pins as needed. 4 Reconnect the VCU plug and all other previously disconnected plug. Make sure the pin is properly positioned and fixed. 5 Run the system and determine if the problem persists?
	YES → Change the VCU
NO ↓	
At this point the system is functioning normally. The problem may be caused by connections. Address the root cause of any connector or pin problems	
Next Step ↓	
Diagnosis end.	

P0687-00、 P0686-00、 P0688-00

Fault diagnosis code
P0687-00: Main relay control terminal STB
P0686-00: Main relay control terminal STG
P0688-00: The main relay control terminal is OPEN
Detection tools
1 Multimeter and diagnostic apparatus
Possible causes
<ul style="list-style-type: none"> • Circuit,terminal and adapting piece fault • VCU • Main relay fault
Conditions for fault code operation
Turn the ignition switch to ON position.
Conditions for fault code setting
P0687-00
The underlying diagnosis
P0686-00
The underlying diagnosis
P0688-00
The underlying diagnosis
To set the effect of a fault code condition
Description of circuit diagram

Circuit diagram

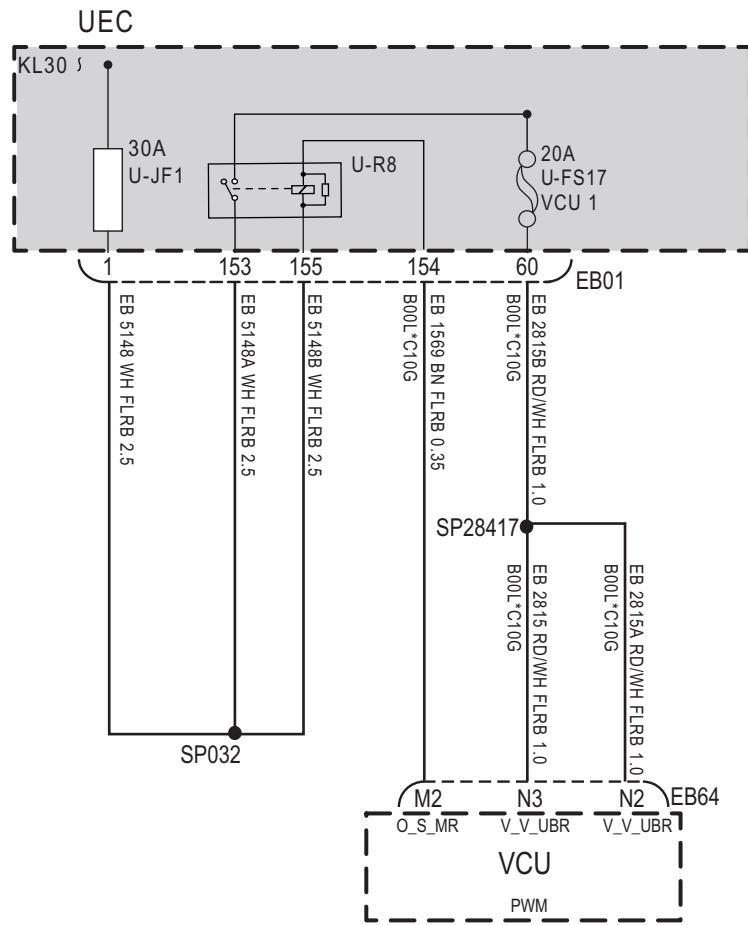

EB64

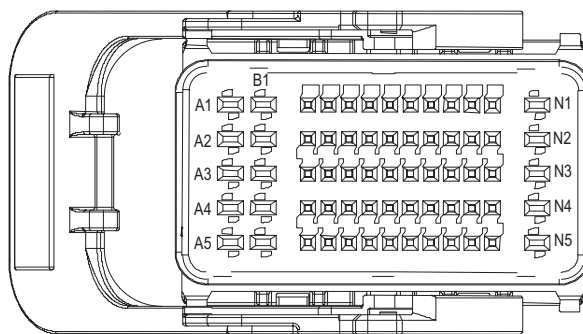

EK891246

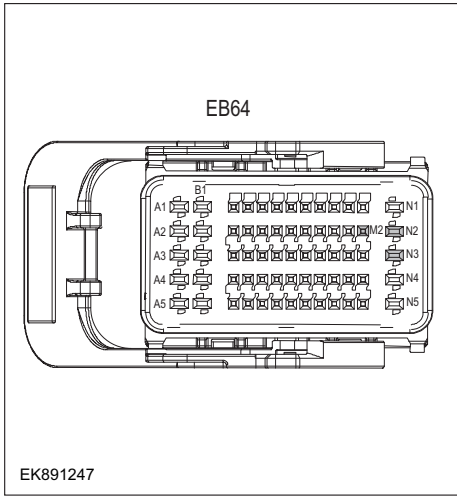
Troubleshooting steps	
Step 1	General inspection.
	<ol style="list-style-type: none"> 1 Check the fuse U-JF1、 U-FS17 for damage 2 Check the relay U-R8 for damage. 3 Check battery capacity. 4 Check the harness plug of main relay, VCU for damage, poor contact, aging and looseness. 5 Check whether the result is normal or not?
	NO → Repair or replace the faulted parts.
YES ↓	
Step 2	Check fault codes.
	<ol style="list-style-type: none"> 1 Connect the fault diagnosis instrument to the diagnosis interface. 2 Turn the ignition switch to ON position. 3 Diagnose the VCU with diagnostic apparatus. 4 Is there any other fault code except for P0687-00、 P0686-00、 P0688-00?
	YES → Refer to: DTC Summary list(VCU) .
NO ↓	
Step 3	Check the circuit between main relay and VCU (open circuit).
 <p>EK891247</p>	<ol style="list-style-type: none"> 1 Turn the ignition switch to OFF. 2 Disconnect the UEC harness plug EB01. 3 Disconnect the VCU harness plug EB64. 4 Measure the resistance between the UEC harness terminals and the VCU harness terminals. <ul style="list-style-type: none"> Measuring circuit: resistance between EB01 plug 154 terminal and EB64 plug M2 terminal. Measuring circuit: resistance between EB01 plug 60 terminal and EB64 plug N2 terminal. Measuring circuit: resistance between EB01 plug 60 terminal and EB64 plug N3 terminal. <p>Standard value: $\approx 0\Omega$</p> 5 Check whether the result is normal or not?
	NO → Repair or replace the faulted parts.
YES ↓	

VCU

Step 4	Check the main relay. (components)
	<ol style="list-style-type: none"> 1 Turn the ignition switch to OFF. 2 Replace the main relay in good condition. 3 Connect the fault diagnosis instrument to the diagnosis interface. 4 Turn the ignition switch to ON position. 5 Clear fault codes. 6 Reread fault codes. 7 Test whether the faulted code is existed.
	NO → Replace the main relay.
YES ↓	
Step 5	Test whether VCU is norm.
	<ol style="list-style-type: none"> 1 Turn the ignition switch to OFF. 2 Disconnect and check the harness plug EB64, EB66 of VCU. 3 Check and repair. <ul style="list-style-type: none"> • Corrosion(install new adapting piece or terminal-cleaning and pin). • Pin damaged or bent-install new terminal/pin. • Fly out of pins-install new pins as needed. 4 Reconnect the VCU plug and all other previously disconnected plug. Make sure the pin is properly positioned and fixed. 5 Run the system and determine if the problem persists?
	YES → Change the VCU
NO ↓	
At this point the system is functioning normally. The problem may be caused by connections. Address the root cause of any connector or pin problems	
Next Step ↓	
Diagnosis end.	

P1C2000、 P1C2100

Fault diagnosis code
P1C20-00: PowerLimit
P1C21-00: PowerShutDown
Detection tools
1 Multimeter and diagnostic apparatus
Possible causes
<ul style="list-style-type: none"> • Circuit,terminal and adapting piece fault • VCU • High voltage system fault
Conditions for fault code operation
Turn the ignition switch to ON position.
Conditions for fault code setting
P1C2000
A fault occurs that requires a twist
P1C2100
An emergency power-off fault occurs
To set the effect of a fault code condition
This fault code only provides a twist limit warning

Troubleshooting steps	
Step 1	General inspection.
	<ol style="list-style-type: none"> 1 Check the fuse for damage. 2 Check the relay for damage. 3 Check battery capacity. 4 Check the harness plug of main relay, VCU for damage, poor contact, aging and looseness. 5 Check whether the result is normal or not?
	NO → Repair or replace the faulted parts.
YES ↓	
Step 2	Check fault codes.
	<ol style="list-style-type: none"> 1 Connect the fault diagnosis instrument to the diagnosis interface. 2 Turn the ignition switch to ON position. 3 Diagnose the VCU with diagnostic apparatus. 4 If there is any fault code except for P1C2000、P1C2100?
	YES → Refer to: DTC Summary list(VCU) .
NO ↓	
Step 3	Check the fault code of high voltage system.
	<ol style="list-style-type: none"> 1 Turn the ignition switch to OFF. 2 Connect the fault diagnosis instrument to the diagnosis interface. 3 Turn the ignition switch to ON position. 4 Diagnose the high voltage using a diagnostic instrument. 5 Check whether the result is normal or not?
	NO → Perform diagnosis based on the specific DTC.
YES ↓	

Step 4	Test whether VCU is norm.
	<ol style="list-style-type: none"> 1 Turn the ignition switch to OFF. 2 Disconnect and check the harness plug EB64, EB66 of VCU. 3 Check and repair. <ul style="list-style-type: none"> • Corrosion(install new adapting piece or terminal-cleaning and pin). • Pin damaged or bent-install new terminal/pin. • Fly out of pins-install new pins as needed. 4 Reconnect the VCU plug and all other previously disconnected plug. Make sure the pin is properly positioned and fixed. 5 Run the system and determine if the problem persists?
	YES → Change the VCU
NO ↓	
At this point the system is functioning normally. The problem may be caused by connections. Address the root cause of any connector or pin problems	
Next Step ↓	
Diagnosis end.	

VCU

U0121-87、U0151-87、U0140-87、U0298-87、U0291-87、U0110-87、U0111-87、U019B-87、U1113-87、U0164-87、U0155-87、U0073-88、U0074-88

Fault diagnosis code
U0121-87: VCU communication with ESP is lost
U0151-87: VCU communication with SRS is lost
U0140-87: VCU communication with BCM is lost
U0298-87: VCU communication with DCDC is lost
U0291-87: VCU communication with SCU is lost
U0110-87: VCU communication with PEU is lost
U0111-87: VCU communication with BMS is lost
U019B-87: VCU communication with OBC is lost
U1113-87: VCU communication with FEM is lost
U0164-87: VCU communication with HCM is lost
U0155-87: VCU communication with IPK is lost
U0073-88: The PTCAN bus is turned off
U0074-88: The EPTCAN bus is turned off
Detection tools
1 Multimeter and diagnostic apparatus
Possible causes
<ul style="list-style-type: none"> • Circuit,terminal and adapting piece fault • GAW
Conditions for fault code operation
Turn the ignition switch to ON position.
Conditions for fault code setting
U0121-87
The receiving state of ESP packets at a interval of 10 ms is equal to 1 and the duration is more than 500 ms
U0151-87
The receiving state of SRS packets at a interval of 10 ms is equal to 1 and the duration is more than 500 ms
U0140-87
The receiving state of BCM packets at a interval of 10 ms is equal to 1 and the duration is more than 500 ms
U0298-87
The receiving state of DCDC packets at a interval of 100 ms is equal to 1 and the duration is more than 2000 ms
U0291-87
The receiving state of SCU packets at a interval of 100 ms is equal to 1 and the duration is more than 2000 ms
U0110-87
The receiving state of PEU packets at a interval of 100 ms is equal to 1 and the duration is more than 2000 ms

U0111-87
The receiving state of BMS packets at a interval of 100 ms is equal to 1 and the duration is more than 2000 ms
U019B-87
The receiving state of OBC packets at a interval of 100 ms is equal to 1 and the duration is more than 2000 ms
U1113-87
The receiving state of FEM packets at a interval of 100 ms is equal to 1 and the duration is more than 2000 ms
U0164-87
The receiving state of HCM packets at a interval of 200 ms is equal to 1 and the duration is more than 10000 ms
U0155-87
The receiving state of IPK packets at a interval of 20 ms is equal to 1 and the duration is more than 1000 ms
U0073-88
The underlying diagnosis
U0074-87
The underlying diagnosis
To set the effect of a fault code condition
Description of circuit diagram
The device is connected to serial data circuit, which is used to monitor the communication situation of serial data during normal operation of vehicle. The devices will exchange the operation information and commands mutually. The device has programming information required to be exchanged on the serial data circuit. The receiver device will also monitor such information; in addition, there are some regular information indication transmitter devices available.

Circuit diagram

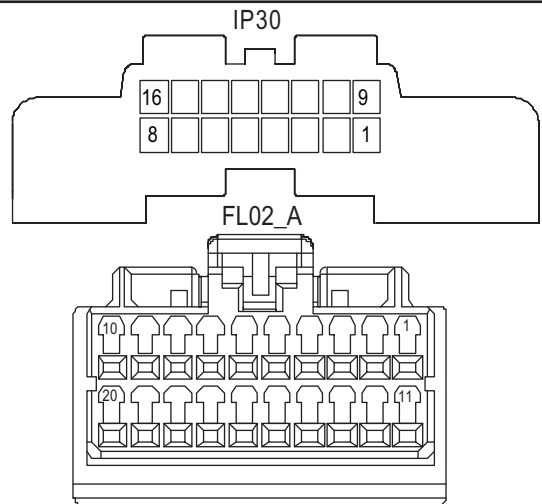
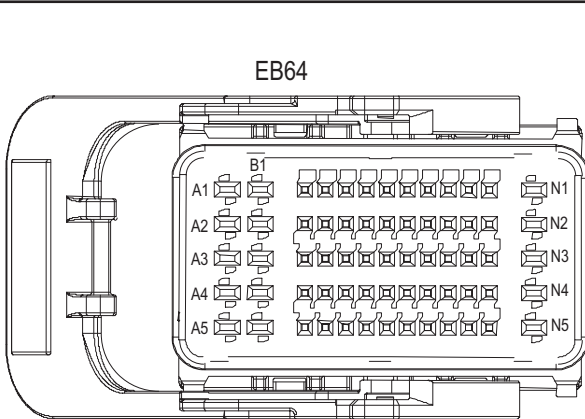
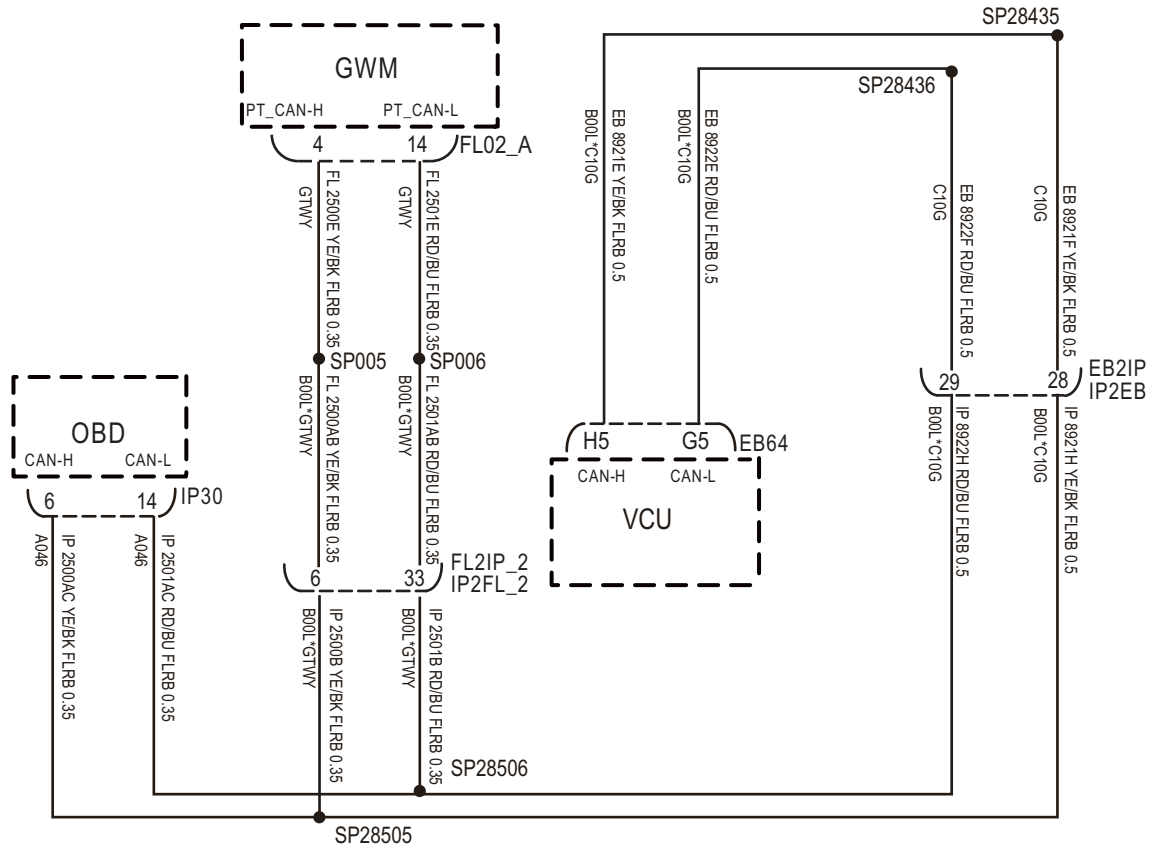

EK891248

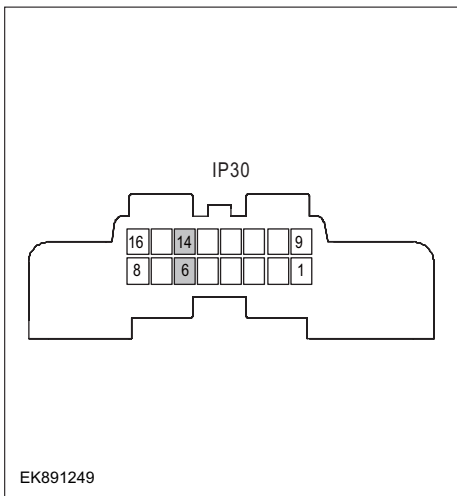
Troubleshooting steps	
Step 1	General inspection.
	<ol style="list-style-type: none"> 1 Check the fuse for damage. 2 Check battery capacity. 3 Check the harness plug of GAW for damage, poor contact, aging and looseness. 4 Check whether the result is normal or not?
	NO → Repair or replace the faulted parts.
YES ↓	
Step 2	Check fault codes.
	<ol style="list-style-type: none"> 1 Connect the fault diagnosis instrument to the diagnosis interface. 2 Turn the ignition switch to ON position. 3 Diagnose the GAW with diagnostic apparatus. 4 Is there any other fault code except for U0121-87、U0151-87、U0140-87、U0298-87、U0291-87、U0110-87、U0111-87、U019B-87、U1113-87、U0164-87、U0155-87、U0073-88、U0074-88?
	YES → Refer to: DTC Summary list(VCU) .
NO ↓	
Step 3	Inspection for CAN communication network completeness.
 <p>EK891249</p>	<ol style="list-style-type: none"> 1 Turn the ignition switch to OFF. 2 Measure the resistance between the harness terminals of diagnose interface. Measuring circuit: IP30 plug resistance between terminal 6 and terminal 14. Standard value: $\approx 60\Omega$ 3 Check whether the result is normal or not?
	NO → Repair or replace the faulted parts.
YES ↓	

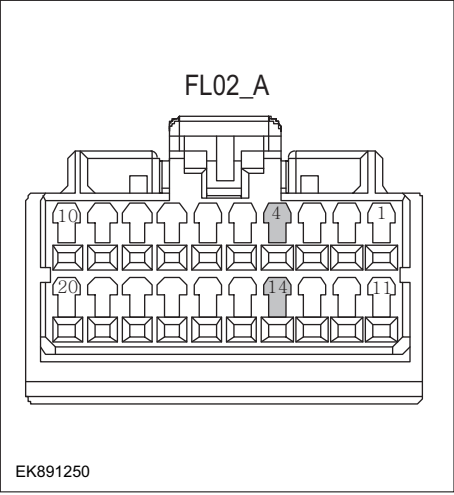
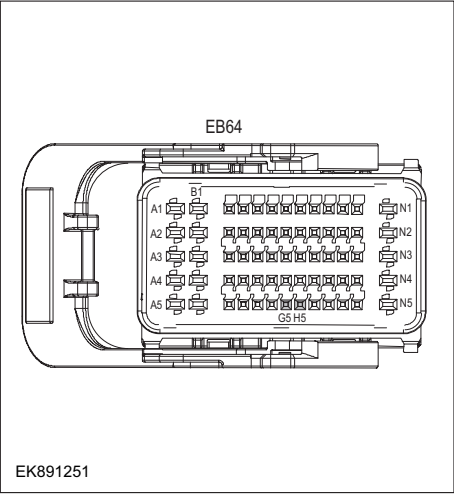
Step 4	Check the terminating resistance of GAW and VCU resistor.
<div style="text-align: center;">  <p>FL02_A</p> <p>EK891250</p> </div> <div style="text-align: center; margin-top: 20px;">  <p>EB64</p> <p>EK891251</p> </div>	<ol style="list-style-type: none"> 1 Turn the ignition switch to OFF. 2 Disconnect the gateway harness plug EL02_A. 3 Measure the resistance between the wiring harness terminals of the gateway . Measuring circuit: EL02_A resistance between terminals 4 and 14 of the plug. Standard value: 110~130Ω 4 Connect the gateway harness plug EL02_A. 5 Disconnect the VCU harness plug EB64. 6 Measure the resistance between the wiring harness terminals of the VCU . Measuring circuit: resistance between EB64 plug H5 terminal and G5 terminal. Standard value: 110~130Ω 7 Check whether the result is normal or not?
NO → Repair or replace the faulted parts.	
YES ↓	
Step 5	Test whether VCU is norm.
	<ol style="list-style-type: none"> 1 Turn the ignition switch to OFF. 2 Disconnect and check the harness plug EB64, EB66 of VCU. 3 Check and repair. <ul style="list-style-type: none"> • Corrosion(install new adapting piece or terminal-cleaning and pin). • Pin damaged or bent-install new terminal/pin. • Fly out of pins-install new pins as needed. 4 Reconnect the VCU plug and all other previously disconnected plug. Make sure the pin is properly positioned and fixed. 5 Run the system and determine if the problem persists?
YES → Change the VCU	

NO ↓
At this point the system is functioning normally. The problem may be caused by connections. Address the root cause of any connector or pin problems
Next Step ↓
Diagnosis end.

P1C97-00

Fault diagnosis code
P1C97-00: Baro sensor rationality
Detection tools
1 Multimeter and diagnostic apparatus
Possible causes
<ul style="list-style-type: none">• Circuit,terminal and adapting piece fault• Battery• VCU• VCU internal atmospheric pressure sensor fault• Charging system• Insurance fuse
Conditions for fault code operation
Turn the ignition switch to ON position.
Conditions for fault code setting
P1C97-00
The sensor pressure is less than 0.35 bar or greater than 1.2 bar.
To set the effect of a fault code condition
Description of circuit diagram
The VCU will monitor whether all sensors and actuators are within normal range all the time. Meanwhile,it will check the connector for virtual connection, short circuit, open circuit and the connection rationality with other signals. When fault occurs, the VCU will save the fault code corresponding to that fault and enable safety mode.

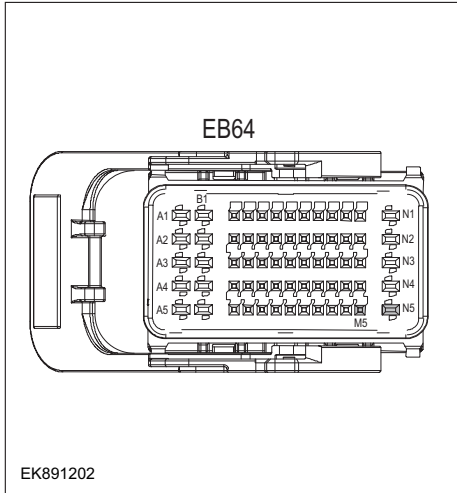
Troubleshooting steps	
Step 1	General inspection.
	<ol style="list-style-type: none"> 1 Check fuses U-JF2、 U-FS20、 U-FS17 for damage. 2 Check the relay U-JF1、 U-R8 for damage. 3 Check battery capacity. 4 Check the harness plug of air conditioning control for damage, poor contact, aging and looseness. 5 Check whether the result is normal or not?
	NO → Repair or replace the faulted parts.
YES ↓	
Step 2	Check fault codes.
	<ol style="list-style-type: none"> 1 Connect the fault diagnosis instrument to the diagnosis interface. 2 Turn the ignition switch to ON position. 3 Check the body control with a diagnostic apparatus. 4 Is there any other fault code except for P1C97-00?
	YES → Refer to: DTC Summary list(VCU) .
NO ↓	
Step 3	Check the power voltage of VCU battery.
	<ol style="list-style-type: none"> 1 Turn the ignition switch to OFF. 2 Disconnect the harness plug EB64 of VCU. 3 Measure the voltage between the harness terminal of VCU and ground. Measuring circuit: the voltage between the EB64 plug M5 terminal and ground. Measuring circuit: the voltage between the EB64 plug M5 terminal and ground. Standard value:10~14V 4 Check whether the result is normal or not?
	NO → Repair the circuit
YES ↓	

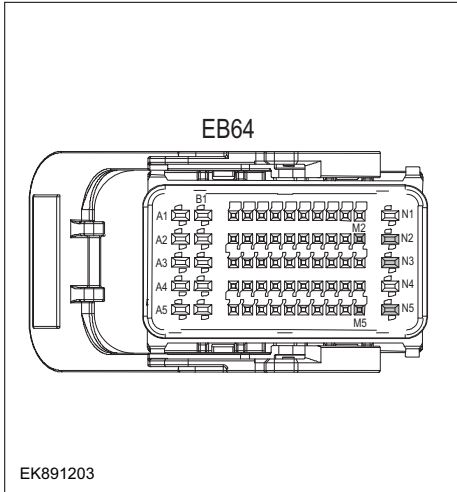
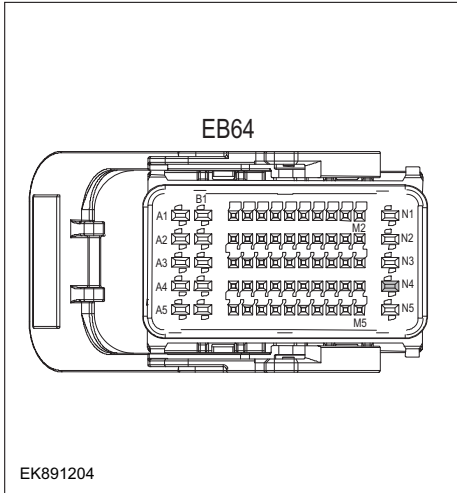
Step 4	Check the power voltage when the VCU is started or operating
	<ol style="list-style-type: none"> 1 Turn the ignition switch to ON. 2 Measure the voltage between the harness terminal of VCU and ground. Measuring circuit: the voltage between the EB64 plug M5 terminal and ground. Measuring circuit: the voltage between the EB64 plug N5 terminal and ground. Measuring circuit: the voltage between the EB64 plug M2 terminal and ground. Measuring circuit: the voltage between the EB64 plug N2 terminal and ground. Measuring circuit: the voltage between the EB64 plug N3 terminal and ground. Standard value:10~14V 3 Check whether the result is normal or not?
NO → Repair the circuit	
YES ↓	
Step 5	Test whether the grounding circuit of VCU is open.
	<ol style="list-style-type: none"> 1 Turn the ignition switch to OFF. 2 Disconnect the VCU harness plug EB64. 3 Measure the resistance between the VCU harness plug and ground. Measuring circuit: resistance between EB64 plug N4 terminal and ground. Standard value: < 1Ω 4 Test whether the resistance is less than 1Ω?
NO → Repair the circuit	
YES ↓	

VCU

Step 6	Test whether VCU is norm.
	<ol style="list-style-type: none">1 Turn the ignition switch to OFF.2 Disconnect and check the harness plug EB64, EB66 of VCU.3 Check and repair.<ul style="list-style-type: none">• Corrosion(install new adapting piece or terminal-cleaning and pin).• Pin damaged or bent-install new terminal/pin.• Fly out of pins-install new pins as needed.4 Reconnect the VCU plug and all other previously disconnected plug. Make sure the pin is properly positioned and fixed.5 Run the system and determine if the problem persists?
	YES → Replace the VCU.
NO ↓	
At this point the system is functioning normally. The problem may be caused by connections. Address the root cause of any connector or pin problems	
Next Step ↓	
Diagnosis end.	

P1CB1-00

Fault diagnosis code
P1CB1-00: collide
Detection tools
1 Multimeter and diagnostic apparatus
Possible causes
<ul style="list-style-type: none">• No need to repair
Conditions for fault code operation
Turn the ignition switch to ON position.
Conditions for fault code setting
P1CB1-00
ABSActive
To set the effect of a fault code condition

Troubleshooting steps	
Step 1	General inspection.
	<ol style="list-style-type: none"> 1 Check the fuse for damage. 2 Check the relay for damage. 3 Check battery capacity. 4 Check the harness plug of main relay, VCU for damage, poor contact, aging and looseness. 5 Check whether the result is normal or not?
	NO → Repair or replace the faulted parts.
YES ↓	
Step 2	Check fault codes.
	<ol style="list-style-type: none"> 1 Connect the fault diagnosis instrument to the diagnosis interface. 2 Turn the ignition switch to ON position. 3 Diagnose the VCU with diagnostic apparatus. 4 Is there any other fault code except for P1CB1-00?
	YES → Refer to: DTC Summary list(VCU) .
NO ↓	
Step 3	Check the vehicle for collisions.
	<ol style="list-style-type: none"> 1 Check the condition of the vehicle and confirm to the owner whether the vehicle has been involved in a collision.
	YES → Replace airbags.
NO ↓	
Step 4	Power on and off the vehicle again.
	<ol style="list-style-type: none"> 1 Turn the ignition switch to OFF. 2 Disconnect the negative polar of the battery. 3 After waiting for 15s, reconnect the negative polar of the battery. 4 Connect the fault diagnosis instrument to the diagnosis interface. 5 Turn the ignition switch to ON position. 6 Diagnose the VCU with diagnostic apparatus. 7 Test whether the faulted code is existed.
	YES → Replace the airbag.
NO ↓	
At this point the system is functioning normally. The problem may be caused by connections. Address the root cause of any connector or pin problems	

Next Step ↓
Diagnosis end.

P1C22-00、 P1CB2-00

Fault diagnosis code
P1C22-00: DEM_stCesdHvReadyFail
P1CB2-00: DEM_stCesdHvDisErr
Detection tools
1 Multimeter and diagnostic apparatus
Possible causes
<ul style="list-style-type: none"> • Circuit,terminal and adapting piece fault • VCU • High voltage system fault
Conditions for fault code operation
Turn the ignition switch to ON position.
Conditions for fault code setting
P1C22-00
Upper high voltage timeout
P1CB2-00
The electricity fault
To set the effect of a fault code condition
The high-voltage power-on fault

Troubleshooting steps	
Step 1	General inspection.
	<ol style="list-style-type: none"> 1 Check the fuse for damage. 2 Check the relay for damage. 3 Check battery capacity. 4 Check the harness plug of main relay, VCU for damage, poor contact, aging and looseness. 5 Check whether the result is normal or not?
	NO → Repair or replace the faulted parts.
YES ↓	
Step 2	Check fault codes.
	<ol style="list-style-type: none"> 1 Connect the fault diagnosis instrument to the diagnosis interface. 2 Turn the ignition switch to ON position. 3 Diagnose the VCU with diagnostic apparatus. 4 If there is any fault code except for P1C22-00、 P1CB2-00?
	YES → Refer to: DTC Summary list(VCU) .
NO ↓	
Step 3	Power on and off the vehicle again.
	<ol style="list-style-type: none"> 1 Turn the ignition switch to OFF. 2 Make protective preparations according to the safety operation specifications of the high voltage voltage in the maintenance manual. 3 Disconnect the harness plug battery pack high voltage. 4 Check whether the battery pack high-voltage connection cable is rotten, damaged, and water enters. 5 After waiting 15 minutes, reconnect the harness plug of battery pack high-voltage. 6 Check whether the result is normal or not?
	YES → Diagnosis end.
NO ↓	

VCU

Step 4	Check the fault code of high voltage system.	
		<ol style="list-style-type: none"> 1 Turn the ignition switch to OFF. 2 Connect the fault diagnosis instrument to the diagnosis interface. 3 Turn the ignition switch to ON position. 4 Diagnose the high voltage using a diagnostic instrument. 5 Check whether the result is normal or not?
		NO → Perform diagnosis based on the specific DTC.
YES ↓		
Step 5	Test whether VCU is norm.	
		<ol style="list-style-type: none"> 1 Turn the ignition switch to OFF. 2 Disconnect and check the harness plug EB64, EB66 of VCU. 3 Check and repair. <ul style="list-style-type: none"> • Corrosion(install new adapting piece or terminal-cleaning and pin). • Pin damaged or bent-install new terminal/pin. • Fly out of pins-install new pins as needed. 4 Reconnect the VCU plug and all other previously disconnected plug. Make sure the pin is properly positioned and fixed. 5 Run the system and determine if the problem persists?
		YES → Change the VCU
NO ↓		
At this point the system is functioning normally. The problem may be caused by connections. Address the root cause of any connector or pin problems		
Next Step ↓		
Diagnosis end.		

P1CB3-00、 P1CB5-00、 P1CB6-00、 P1CB7-00

Fault diagnosis code
P1CB3-00: The high-voltage battery is not in Operation mode
P1CB5-00: Battery level 2 failure
P1CB6-00: Battery level 3 failure
P1CB7-00: Battery level 4 failure
Detection tools
1 Multimeter and diagnostic apparatus
Possible causes
<ul style="list-style-type: none"> • Line, terminal or connector failure • VCU • BMS
Conditions for fault code operation
Turn the ignition switch to ON position.
Conditions for fault code setting
P1CB3-00
The high-voltage battery is not in Operation mode
P1CB5-00
The battery sends a Level 2 fault
P1CB6-00
The battery sends a Level 3 fault
P1CB7-00
The battery sends a Level 4 fault
To set the effect of a fault code condition

Troubleshooting steps	
Step 1	General inspection.
	<ol style="list-style-type: none"> 1 Check the fuse for damage. 2 Check the relay for damage. 3 Check battery capacity. 4 Check the harness plug of main relay, VCU for damage, poor contact, aging and looseness. 5 Check whether the result is normal or not?
	NO → Repair or replace the faulted parts.
YES ↓	
Step 2	Check fault codes.
	<ol style="list-style-type: none"> 1 Connect the fault diagnosis instrument to the diagnosis interface. 2 Turn the ignition switch to ON position. 3 Diagnose the VCU with diagnostic apparatus. 4 Is there any other fault code except for P1CB3-00, P1CB5-00, P1CB6-00, P1CB7-00?
	YES → Refer to: DTC Summary list(VCU) .
NO ↓	
Step 3	Check the fault code of BMS .
	<ol style="list-style-type: none"> 1 Turn the ignition switch to OFF. 2 Connect the fault diagnosis instrument to the diagnosis interface. 3 Turn the ignition switch to ON position. 4 Diagnose the BMS with diagnostic apparatus. 5 Check whether the result is normal or not?
	NO → Perform diagnosis based on the specific DTC.
YES ↓	

Step 4	Test whether VCU is norm.
	<ol style="list-style-type: none"> 1 Turn the ignition switch to OFF. 2 Disconnect and check the harness plug EB64, EB66 of VCU. 3 Check and repair. <ul style="list-style-type: none"> • Corrosion(install new adapting piece or terminal-cleaning and pin). • Pin damaged or bent-install new terminal/pin. • Fly out of pins-install new pins as needed. 4 Reconnect the VCU plug and all other previously disconnected plug. Make sure the pin is properly positioned and fixed. 5 Run the system and determine if the problem persists?
	YES → Change the VCU
NO ↓	
At this point the system is functioning normally. The problem may be caused by connections. Address the root cause of any connector or pin problems	
Next Step ↓	
Diagnosis end.	

P1CB8-00

Fault diagnosis code
P1CB8-00: Battery high voltage interlock failure
Detection tools
1 Multimeter and diagnostic apparatus
Possible causes
<ul style="list-style-type: none">• Circuit, terminal and adapting piece fault• High voltage interlock circuit fault
Conditions for fault code operation
Turn the ignition switch to ON position.
Conditions for fault code setting
P1CB8-00
BMS reports a high voltage interlock fault
To set the effect of a fault code condition
High-voltage function fault

Troubleshooting steps	
Step 1	General inspection.
	<ol style="list-style-type: none"> 1 Check the fuse for damage. 2 Check battery capacity. 3 Check the harness plug of VCU for damage, poor contact, aging and looseness. 4 Check whether the result is normal or not?
	NO → Repair or replace the faulted parts.
YES ↓	
Step 2	Check fault codes.
	<ol style="list-style-type: none"> 1 Connect the fault diagnosis instrument to the diagnosis interface. 2 Turn the ignition switch to ON position. 3 Diagnose the VCU with diagnostic apparatus. 4 Is there any other fault code except for P1CB8-00?
	YES → Refer to: DTC Summary list(VCU) .
NO ↓	
Step 3	Check battery pack high-voltage interlock of CDU.
	<ol style="list-style-type: none"> 1 Turn the ignition switch to OFF. 2 Make protective preparations according to the safety operation specifications of the high voltage voltage in the maintenance manual. 3 Disconnect the harness plug battery pack high voltage. 4 Disconnect the harness plug battery pack high voltage of CDU. 5 Check whether the CDU connection cable is rotten, damaged, and water enters. 6 Check whether the interlock circuit of CDU battery pack high-voltage exist the situation of open or short circuit. 7 Check whether the result is normal or not?
	NO → Repair or replace the faulted parts.
YES ↓	

Step 4	Check the battery pack high-voltage cable interlock circuit.
	<ol style="list-style-type: none"> 1 Turn the ignition switch to OFF. 2 Make protective preparations according to the safety operation specifications of the high voltage voltage in the maintenance manual. 3 Disconnect the harness plug battery pack high voltage. 4 Disconnect the harness plug battery pack high voltage of CDU. 5 Check whether the battery pack high-voltage interlock circuit is open. 6 Check whether the result is normal or not?
	NO → Repair or replace the faulted parts.
YES ↓	
At this point the system is functioning normally. The problem may be caused by connections. Address the root cause of any connector or pin problems	
Next Step ↓	
Diagnosis end.	

P1CB9-00

Fault diagnosis code
P1CB9-00: Battery high voltage interlock failure
Detection tools
1 Multimeter and diagnostic apparatus
Possible causes
<ul style="list-style-type: none">• Circuit, terminal and adapting piece fault• High voltage interlock circuit fault
Conditions for fault code operation
Turn the ignition switch to ON position.
Conditions for fault code setting
P1CB9-00
PEU reports a high voltage interlock fault
To set the effect of a fault code condition
High-voltage function fault

Troubleshooting steps	
Step 1	General inspection.
	<ol style="list-style-type: none"> 1 Check the fuse for damage. 2 Check battery capacity. 3 Check the harness plug of VCU for damage, poor contact, aging and looseness. 4 Check whether the result is normal or not?
	NO → Repair or replace the faulted parts.
YES ↓	
Step 2	Check fault codes.
	<ol style="list-style-type: none"> 1 Connect the fault diagnosis instrument to the diagnosis interface. 2 Turn the ignition switch to ON position. 3 Diagnose the VCU with diagnostic apparatus. 4 Is there any other fault code except for P1CB9-00?
	YES → Refer to: DTC Summary list(VCU) .
NO ↓	
Step 3	Check the driving motor high-voltage interlock circuit of CDU.
	<ol style="list-style-type: none"> 1 Turn the ignition switch to OFF. 2 Make protective preparations according to the safety operation specifications of the high voltage voltage in the maintenance manual. 3 Disconnect the harness plug battery pack high voltage. 4 Disconnect the harness plug driving motor high-voltage of CDU. 5 Check whether the CDU connection cable is rotten, damaged, and water enters. 6 Check whether the interlock circuit of CDU driving motor high-voltage exist the situation of open or short circuit. 7 Check whether the result is normal or not?
	NO → Repair or replace the faulted parts.
YES ↓	

Step 4	Check the driving motor high-voltage interlock circuit.
	<ol style="list-style-type: none"> 1 Turn the ignition switch to OFF. 2 Make protective preparations according to the safety operation specifications of the high voltage voltage in the maintenance manual. 3 Disconnect the harness plug driving motor high-voltage of CDU. 4 Disconnect the harness plug driving motor high-voltage of driving motor. 5 Check whether the driving motor high-voltage interlock circuit is open. 6 Check whether the result is normal or not?
	NO → Repair or replace the faulted parts.
YES ↓	
Step 5	Check the driving motor high-voltage cable interlock circuit.
	<ol style="list-style-type: none"> 1 Turn the ignition switch to OFF. 2 Make protective preparations according to the safety operation specifications of the high voltage voltage in the maintenance manual. 3 Disconnect the harness plug driving motor high-voltage of driving motor. 4 Check whether the interlock circuit of driving motor high-voltage cable exist the situation of open or short circuit. 5 Check whether the result is normal or not?
	NO → Repair or replace the faulted parts.
YES ↓	
At this point the system is functioning normally. The problem may be caused by connections. Address the root cause of any connector or pin problems	
Next Step ↓	
Diagnosis end.	

P1CC0-00

Fault diagnosis code
P1CC0-00: CDU high voltage interlock failure
Detection tools
1 Multimeter and diagnostic apparatus
Possible causes
<ul style="list-style-type: none">• Circuit, terminal and adapting piece fault• High voltage interlock circuit fault
Conditions for fault code operation
Turn the ignition switch to ON position.
Conditions for fault code setting
P1CC0-00
CDU reports a high voltage interlock fault
To set the effect of a fault code condition
High-voltage function fault

Troubleshooting steps	
Step 1	General inspection.
	<ol style="list-style-type: none"> 1 Check the fuse for damage. 2 Check battery capacity. 3 Check the harness plug of VCU for damage, poor contact, aging and looseness.
	1 Check whether the result is normal or not?
	NO → Repair or replace the faulted parts.
YES ↓	
Step 2	Check fault codes.
	<ol style="list-style-type: none"> 1 Connect the fault diagnosis instrument to the diagnosis interface. 2 Turn the ignition switch to ON position. 3 Diagnose the VCU with diagnostic apparatus. 4 Is there any other fault code except for P1CC0-00?
	YES → Refer to: DTC Summary list(VCU) .
NO ↓	
Step 3	Check high-voltage interlock circuit of CDU.
	<ol style="list-style-type: none"> 1 Turn the ignition switch to OFF. 2 Make protective preparations according to the safety operation specifications of the high voltage voltage in the maintenance manual. 3 Disconnect the harness plug battery pack high voltage. 4 Disconnect the high voltage harness plug of CDU. 5 Check whether the CDU connection cable is rotten, damaged, and water enters. 6 Check whether the interlock circuit of CDU high-voltage exist the situation of open or short circuit. 7 Check whether the result is normal or not?
	NO → Repair or replace the faulted parts.
YES ↓	

Step 4	Check interlock switch circuit of CDU end cover.
	<ol style="list-style-type: none"> 1 Turn the ignition switch to OFF. 2 Make protective preparations according to the safety operation specifications of the high voltage voltage in the maintenance manual. 3 Disconnect the harness plug battery pack high voltage. 4 Check whether the CDU connection cable is rotten, damaged, and water enters. 5 Open the CDU end cover. 6 Check whether the interlock switch of CDU end cover exist the situation of open or short circuit. 7 Check whether the result is normal or not?
	NO → Repair or replace the faulted parts.
YES ↓	
At this point the system is functioning normally. The problem may be caused by connections. Address the root cause of any connector or pin problems	
Next Step ↓	
Diagnosis end.	

P1CC1-00

Fault diagnosis code
P1CC1-00: PTC high voltage interlock failure
Detection tools
1 Multimeter and diagnostic apparatus
Possible causes
<ul style="list-style-type: none">• Circuit, terminal and adapting piece fault• High voltage interlock circuit fault
Conditions for fault code operation
Turn the ignition switch to ON position.
Conditions for fault code setting
P1CC1-00
PTC reports a high voltage interlock fault
To set the effect of a fault code condition
High-voltage function fault

Troubleshooting steps	
Step 1	General inspection.
	<ol style="list-style-type: none"> 1 Check the fuse for damage. 2 Check battery capacity. 3 Check the harness plug of VCU for damage, poor contact, aging and looseness. 4 Check whether the result is normal or not?
	NO → Repair or replace the faulted parts.
YES ↓	
Step 2	Check fault codes.
	<ol style="list-style-type: none"> 1 Connect the fault diagnosis instrument to the diagnosis interface. 2 Turn the ignition switch to ON position. 3 Diagnose the VCU with diagnostic apparatus. 4 Is there any other fault code except for P1CC1-00?
	YES → Refer to: DTC Summary list(VCU) .
NO ↓	
Step 3	Check PTC high-voltage interlock circuit of CDU.
	<ol style="list-style-type: none"> 1 Turn the ignition switch to OFF. 2 Make protective preparations according to the safety operation specifications of the high voltage voltage in the maintenance manual. 3 Disconnect the harness plug battery pack high voltage. 4 Disconnect the PTC high voltage harness plug of CDU. 5 Check whether the CDU connection cable is rotten, damaged, and water enters. 6 Check whether the PTC interlock circuit of CDU high-voltage exist the situation of open or short circuit. 7 Check whether the result is normal or not?
	NO → Repair or replace the faulted parts.
YES ↓	

Step 5	Check PTC high-voltage interlock circuit of PTC.
	<ol style="list-style-type: none"> 1 Turn the ignition switch to OFF. 2 Make protective preparations according to the safety operation specifications of the high voltage voltage in the maintenance manual. 3 Disconnect the high voltage harness plug of PTC. 4 Check whether the interlock circuit of PTC high-voltage exist the situation of open or short circuit. 5 Check whether the result is normal or not?
	NO → Repair or replace the faulted parts.
YES ↓	
At this point the system is functioning normally. The problem may be caused by connections. Address the root cause of any connector or pin problems	
Next Step ↓	
Diagnosis end.	

P1CC2-00、 P1CC3-00

Fault diagnosis code
P1CC2-00: EPP unlock failure
P1CC3-00: EPP lighting
Detection tools
1 Multimeter and diagnostic apparatus
Possible causes
<ul style="list-style-type: none">• Circuit,terminal and adapting piece fault• VCU• EPP fault
Conditions for fault code operation
Turn the ignition switch to ON position.
Conditions for fault code setting
P1CC2-00
EPP unlock abnormal
P1CC3-00
EPP reports the lighting request
To set the effect of a fault code condition

Troubleshooting steps	
Step 1	General inspection.
	<ol style="list-style-type: none"> 1 Check the fuse for damage. 2 Check the relay for damage. 3 Check battery capacity. 4 Check the harness plug of main relay, VCU for damage, poor contact, aging and looseness. 5 Check whether the result is normal or not?
	NO → Repair or replace the faulted parts.
YES ↓	
Step 2	Check fault codes.
	<ol style="list-style-type: none"> 1 Connect the fault diagnosis instrument to the diagnosis interface. 2 Turn the ignition switch to ON position. 3 Diagnose the VCU with diagnostic apparatus. 4 If there is any fault code except for P1CC2-00、 P1CC3-00?
	YES → Refer to: DTC Summary list(VCU) .
NO ↓	
Step 3	Check the fault code of PEU .
	<ol style="list-style-type: none"> 1 Turn the ignition switch to OFF. 2 Connect the fault diagnosis instrument to the diagnosis interface. 3 Turn the ignition switch to ON position. 4 Diagnose the PEU with diagnostic apparatus. 5 Check whether the result is normal or not?
	NO → Please perform diagnostic operations according to the specific DTC.
YES ↓	

VCU

Step 4	Test whether VCU is norm.
	<ol style="list-style-type: none">1 Turn the ignition switch to OFF.2 Disconnect and check the harness plug EB64, EB66 of VCU.3 Check and repair.<ul style="list-style-type: none">• Corrosion(install new adapting piece or terminal-cleaning and pin).• Pin damaged or bent-install new terminal/pin.• Fly out of pins-install new pins as needed.4 Reconnect the VCU plug and all other previously disconnected plug. Make sure the pin is properly positioned and fixed.5 Run the system and determine if the problem persists?
	YES → Change the VCU
NO ↓	
At this point the system is functioning normally. The problem may be caused by connections. Address the root cause of any connector or pin problems	
Next Step ↓	
Diagnosis end.	

P1CC4-00、 P1CC5-00、 P1CC6-00、 P1CEA-00

Fault diagnosis code
P1CC4-00: Motor level 1 failure
P1CC5-00: Motor level 2 failure
P1CC6-00: Motor level 3 failure
P1CEA-00: Motor level 4 failure
Detection tools
1 Multimeter and diagnostic apparatus
Possible causes
<ul style="list-style-type: none"> • Circuit,terminal and adapting piece fault • VCU • PEU system fault
Conditions for fault code operation
Turn the ignition switch to ON position.
Conditions for fault code setting
P1CC4-00
Motor transmission level 1 fault
P1CC5-00
Motor transmission level 2 fault
P1CC6-00
Motor transmission level 3 fault
P1CEA-00
Motor transmission level 4 fault
To set the effect of a fault code condition

Troubleshooting steps	
Step 1	General inspection.
	<ol style="list-style-type: none"> 1 Check the fuse for damage. 2 Check the relay for damage. 3 Check battery capacity. 4 Check the harness plug of main relay, VCU for damage, poor contact, aging and looseness. 5 Check whether the result is normal or not?
	NO → Repair or replace the faulted parts.
YES ↓	
Step 2	Check fault codes.
	<ol style="list-style-type: none"> 1 Connect the fault diagnosis instrument to the diagnosis interface. 2 Turn the ignition switch to ON position. 3 Diagnose the VCU with diagnostic apparatus. 4 Is there any other fault code except for P1CC4-00, P1CC5-00, P1CC6-00, P1CEA-00?
	YES → Refer to: DTC Summary list(VCU) .
NO ↓	
Step 3	Check the fault code of PEU .
	<ol style="list-style-type: none"> 1 Turn the ignition switch to OFF. 2 Connect the fault diagnosis instrument to the diagnosis interface. 3 Turn the ignition switch to ON position. 4 Diagnose the PEU with diagnostic apparatus. 5 Check whether the result is normal or not?
	NO → Perform diagnosis based on the specific DTC.
YES ↓	

Step 4	Test whether VCU is norm.
	<ol style="list-style-type: none"> 1 Turn the ignition switch to OFF. 2 Disconnect and check the harness plug EB64, EB66 of VCU. 3 Check and repair. <ul style="list-style-type: none"> • Corrosion(install new adapting piece or terminal-cleaning and pin). • Pin damaged or bent-install new terminal/pin. • Fly out of pins-install new pins as needed. 4 Reconnect the VCU plug and all other previously disconnected plug. Make sure the pin is properly positioned and fixed. 5 Run the system and determine if the problem persists?
	YES → Change the VCU
NO ↓	
At this point the system is functioning normally. The problem may be caused by connections. Address the root cause of any connector or pin problems	
Next Step ↓	
Diagnosis end.	

P1CC7-00、 P1CC8-00、 P1CC9-00

Fault diagnosis code
P1CC7-00: The speed signal is invalid
P1CC8-00: Wrong wheel speed signal
P1CC9-00: The wheel speed signal is invalid
Detection tools
1 Multimeter and diagnostic apparatus
Possible causes
<ul style="list-style-type: none"> • Circuit,terminal and adapting piece fault • VCU • Wheel speed sensor fault
Conditions for fault code operation
Turn the ignition switch to ON position.
Conditions for fault code setting
P1CC7-00
Speed signal invalid
P1CC8-00
Speed signal invalid
P1CC9-00
车 Speed signal invalid
To set the effect of a fault code condition

Troubleshooting steps	
Step 1	General inspection.
	<ol style="list-style-type: none"> 1 Check the fuse for damage. 2 Check the relay for damage. 3 Check battery capacity. 4 Check the harness plug of main relay, VCU for damage, poor contact, aging and looseness. 5 Check whether the result is normal or not?
	NO → Repair or replace the faulted parts.
YES ↓	
Step 2	Check fault codes.
	<ol style="list-style-type: none"> 1 Connect the fault diagnosis instrument to the diagnosis interface. 2 Turn the ignition switch to ON position. 3 Diagnose the VCU with diagnostic apparatus. 4 Is there any other fault code except for P1CC7-00, P1CC8-00, P1CC9-00?
	YES → Refer to: DTC Summary list(VCU) .
NO ↓	
Step 3	Check the fault code of ABS .
	<ol style="list-style-type: none"> 1 Turn the ignition switch to OFF. 2 Connect the fault diagnosis instrument to the diagnosis interface. 3 Turn the ignition switch to ON position. 4 Diagnose the ABS with diagnostic apparatus. 5 Check whether the result is normal or not?
	NO → Please perform diagnostic operations according to the specific DTC.
YES ↓	

VCU

Step 4	Test whether VCU is norm.
	<ol style="list-style-type: none">1 Turn the ignition switch to OFF.2 Disconnect and check the harness plug EB64, EB66 of VCU.3 Check and repair.<ul style="list-style-type: none">• Corrosion(install new adapting piece or terminal-cleaning and pin).• Pin damaged or bent-install new terminal/pin.• Fly out of pins-install new pins as needed.4 Reconnect the VCU plug and all other previously disconnected plug. Make sure the pin is properly positioned and fixed.5 Run the system and determine if the problem persists?
	YES → Change the VCU
NO ↓	
At this point the system is functioning normally. The problem may be caused by connections. Address the root cause of any connector or pin problems	
Next Step ↓	
Diagnosis end.	

P1CE0-00、 P1CE1-00

Fault diagnosis code
P1CE0-00: FEM sensor failure
P1CE1-00: FEM thermal runaway alarm
Detection tools
1 Multimeter and diagnostic apparatus
Possible causes
<ul style="list-style-type: none"> • Circuit,terminal and adapting piece fault • VCU • PEM failure
Conditions for fault code operation
Turn the ignition switch to ON position.
Conditions for fault code setting
P1CE0-00
The FEM controller reports a fault message
P1CE1-00
The FEM controller reports a thermal runaway signal
To set the effect of a fault code condition

Troubleshooting steps	
Step 1	General inspection.
	<ol style="list-style-type: none"> 1 Check the fuse for damage. 2 Check the relay for damage. 3 Check battery capacity. 4 Check the harness plug of main relay, VCU for damage, poor contact, aging and looseness. 5 Check whether the result is normal or not?
	NO → Repair or replace the faulted parts.
YES ↓	
Step 2	Check fault codes.
	<ol style="list-style-type: none"> 1 Connect the fault diagnosis instrument to the diagnosis interface. 2 Turn the ignition switch to ON position. 3 Diagnose the VCU with diagnostic apparatus. 4 Is there any other fault code except for P1CE0-00, P1CE1-00?
	YES → Refer to: DTC Summary list(VCU) .
NO ↓	
Step 3	Check the PEM fault code.
	<ol style="list-style-type: none"> 1 Turn the ignition switch to OFF. 2 Connect the fault diagnosis instrument to the diagnosis interface. 3 Turn the ignition switch to ON position. 4 Diagnose PEM using a diagnostic instrument. 5 Check whether the result is normal or not?
	NO → Please perform diagnostic operations according to the specific DTC.
YES ↓	

Step 4	Test whether VCU is norm.
	<ol style="list-style-type: none"> 1 Turn the ignition switch to OFF. 2 Disconnect and check the harness plug EB64, EB66 of VCU. 3 Check and repair. <ul style="list-style-type: none"> • Corrosion(install new adapting piece or terminal-cleaning and pin). • Pin damaged or bent-install new terminal/pin. • Fly out of pins-install new pins as needed. 4 Reconnect the VCU plug and all other previously disconnected plug. Make sure the pin is properly positioned and fixed. 5 Run the system and determine if the problem persists?
	YES → Change the VCU
NO ↓	
At this point the system is functioning normally. The problem may be caused by connections. Address the root cause of any connector or pin problems	
Next Step ↓	
Diagnosis end.	

P1CE5-00、 P1CE6-00、 P1CE9-00

Fault diagnosis code
P1CE5-00: The water inlet temperature sensor is faulty
P1CE6-00: The outlet temperature sensor is faulty
P1CE9-00: Total success rate output failure
Detection tools
1 Multimeter and diagnostic apparatus
Possible causes
<ul style="list-style-type: none"> • Circuit,terminal and adapting piece fault • VCU • PEM
Conditions for fault code operation
Turn the ignition switch to ON position.
Conditions for fault code setting
P1CE5-00
BPTC reports inlet water temperature sensor fault
P1CE6-00
BPTC reports outlet water temperature sensor fault
P1CE9-00
BPTC reports an output fault
To set the effect of a fault code condition

Troubleshooting steps	
Step 1	General inspection.
	<ol style="list-style-type: none"> 1 Check the fuse for damage. 2 Check the relay for damage. 3 Check battery capacity. 4 Check the harness plug of main relay, VCU for damage, poor contact, aging and looseness. 5 Check whether the result is normal or not?
	NO → Repair or replace the faulted parts.
YES ↓	
Step 2	Check fault codes.
	<ol style="list-style-type: none"> 1 Connect the fault diagnosis instrument to the diagnosis interface. 2 Turn the ignition switch to ON position. 3 Diagnose the VCU with diagnostic apparatus. 4 Is there any other fault code except for P1CE5-00, P1CE6-00, P1CE9-00?
	YES → Refer to: DTC Summary list(VCU) .
NO ↓	
Step 3	Check the fault code of BPTC
	<ol style="list-style-type: none"> 1 Turn the ignition switch to OFF. 2 Connect the fault diagnosis instrument to the diagnosis interface. 3 Turn the ignition switch to ON position. 4 Diagnose the BPTC with diagnostic apparatus. 5 Check whether the result is normal or not?
	NO → Perform diagnosis based on the specific DTC.
YES ↓	

VCU

Step 4	Test whether VCU is norm.
	<ol style="list-style-type: none">1 Turn the ignition switch to OFF.2 Disconnect and check the harness plug EB64, EB66 of VCU.3 Check and repair.<ul style="list-style-type: none">• Corrosion(install new adapting piece or terminal-cleaning and pin).• Pin damaged or bent-install new terminal/pin.• Fly out of pins-install new pins as needed.4 Reconnect the VCU plug and all other previously disconnected plug. Make sure the pin is properly positioned and fixed.5 Run the system and determine if the problem persists?
	YES → Change the VCU
NO ↓	
At this point the system is functioning normally. The problem may be caused by connections. Address the root cause of any connector or pin problems	
Next Step ↓	
Diagnosis end.	