

Wiring Diagram Symbols and Wire Colors



Entire component shown



Part of component shown

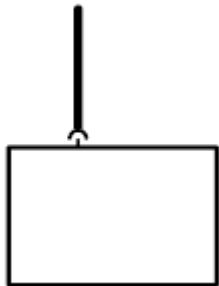

Connector attached to component

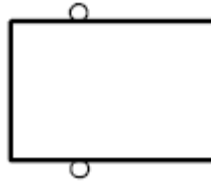

Component with screw terminals



Component case attached directly to metal part of car (grounded)

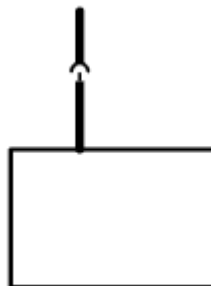

Connector attached to component lead (pigtail)

| Wire Color | | |
|------------|----|---------------|
| | BL | Blue Blau |
| | BR | Brown |
| | GE | Yellow |
| | GN | Green |
| | GR | Gray Grau |
| | OR | Orange |
| | RS | Pink |
| | RT | Red Rot |
| | SW | Black Schartz |
| | VI | Violet |
| | WS | White |
| | TR | Transparent |

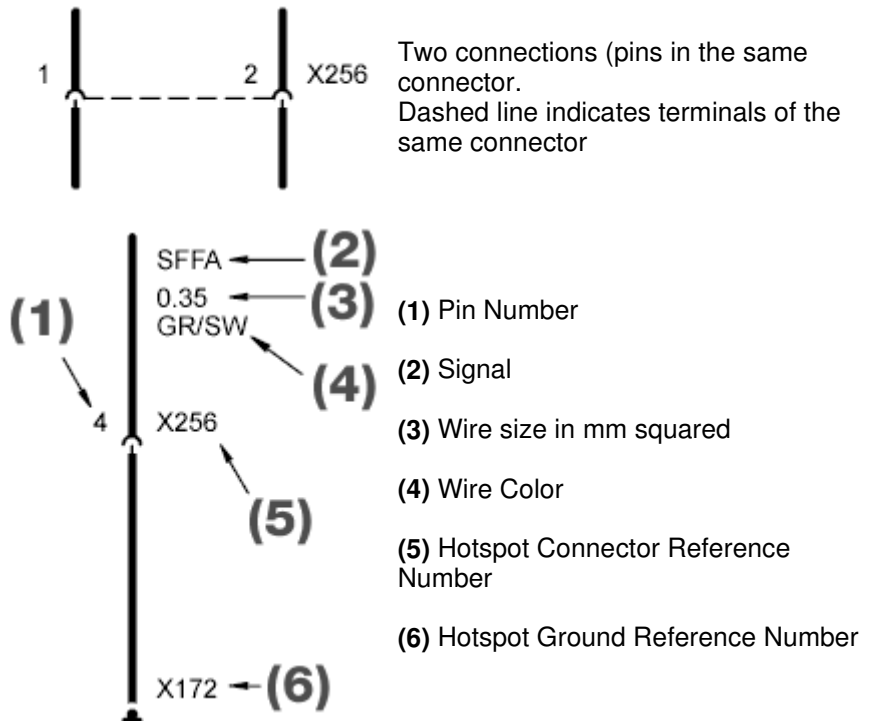

Hotspots in Wiring Diagrams



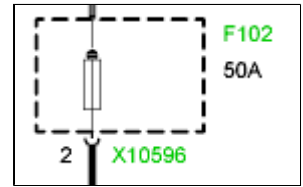





Wiring diagrams contain **green** hotspots (hyperlinks). Clicking on a hotspot opens the navigation tree at the corresponding position. There you will find the documents belonging to the selected component.



[Top](#)

Symbols in the Navigation Tree

The different document types are flagged with different symbols:

-  Wiring Diagrams
-  Component Locations
-  Measuring Devices
-  Connector Views
-  Pin Assignments
-  Help Texts
-  Functional Tests
-  Functional Descriptions
-  Desired Vaules